

---

## AUDIO CODEC WITH USB INTERFACE, MONO MICROPHONE INPUT AND STEREO HEADPHONE OUTPUT

---

### FEATURES

- **On-Chip USB Interface:**
  - With Full-Speed Transceivers
  - Fully Compliant with USB 2.0 Specification
  - Certified By USB-IF
  - Partially Programmable Descriptors
  - Adaptive Isochronous Transfer for Playback
  - Asynchronous Isochronous Transfer for Record
  - Bus Powered
- **16-Bit Delta-Sigma ADC and DAC**
- **Sampling Rate:**
  - 8, 11.025, 16, 22.05, 32, 44.1, 48 kHz
- **On-Chip Clock Generator:**
  - With Single 6-MHz Clock Source
- **Mono ADC with Microphone Input**
  - Analog Performance at  $V_{BUS} = 5\text{ V}$ :
    - THD+N: 0.01%
    - SNR: 92 dB
    - Dynamic Range: 90 dB
  - Decimation Digital Filter
    - Pass-Band Ripple:  $\pm 0.05\text{ dB}$
    - Stop-Band Attenuation:  $-65\text{ dB}$
  - Single-Ended Voltage Input
  - Antialiasing Filter Included
  - Digital HPF Included
  - Microphone Bias, Microphone Amplifier, and Input PGA
- **Stereo DAC With Headphone Output**
  - Analog Performance at  $V_{BUS} = 5.0\text{ V}$ :
    - THD+N: 0.01% ( $R_L > 10\text{ k}\Omega$ )
    - THD+N: 0.02% ( $R_L = 32\ \Omega$ )
    - SNR: 92 dB
    - Dynamic Range: 90 dB
    - PO: 13 mW ( $R_L = 32\ \Omega$ )
    - PO: 25 mW ( $R_L = 16\ \Omega$ )
  - Oversampling Digital Filter
    - Pass-Band Ripple:  $\pm 0.1\text{ dB}$
    - Stop-Band Attenuation:  $-43\text{ dB}$
    - Single-Ended Voltage Output
    - Analog LPF Included
    - Sidetone PGA, Output PGA, and HP Amplifier
- **Multifunctions:**
  - Suspend, Playback, and Record Status Flag
  - Microphone Amplifier, Mute, and Gain Control
- **Pop/Click Noise Free**
- **Single Power Supply: 5 V Typ ( $V_{BUS}$ )**
- **Package: 32-Pin TQFP**

### APPLICATIONS

- USB Headset
- USB Headphone
- USB Speaker
- USB Featured Consumer Audio Product
- USB Audio Interface Box
- USB Monitor
- Video Conference System

### DESCRIPTION

The PCM2912 is the Texas Instruments single-chip, USB stereo audio CODEC with USB 2.0-compliant full-speed protocol controller and analog front end (AFE) function for headset application. The USB protocol controller works with no software code, but USB descriptors can be modified on request<sup>(1)</sup>. The PCM2912 employs SpAct™ architecture, TI's unique system that recovers the audio clock from USB packet data. On chip analog PLLs with SpAct enables independent playback and record sampling rate with low clock jitters.

(1) The descriptor can be modified by changing a mask; contact your representative about the details.



Please be aware that an important notice concerning availability, standard warranty, and use in critical applications of Texas Instruments semiconductor products and disclaimers thereto appears at the end of this data sheet.

SpAct is a trademark of Texas Instruments.

Audio Precision, System Two are trademarks of Audio Precision, Inc..



This integrated circuit can be damaged by ESD. Texas Instruments recommends that all integrated circuits be handled with appropriate precautions. Failure to observe proper handling and installation procedures can cause damage.

ESD damage can range from subtle performance degradation to complete device failure. Precision integrated circuits may be more susceptible to damage because very small parametric changes could cause the device not to meet its published specifications.

## ABSOLUTE MAXIMUM RATINGS

over operating free-air temperature range (unless otherwise noted)<sup>(1) (2)</sup>

|  |  | PCM2912      | UNIT |
|--|--|--------------|------|
| Supply voltage   | $V_{BUS}$  | –0.3 to +6.5 | V    |
| Ground voltage differences: BGND, PGND, AGND, HGND, DGND                 |  | ±0.1         | V    |
| Input voltage : $V_{CCP}$ , $V_{CCA}$ , $V_{CCL}$ , $V_{CCR}$ , $V_{DD}$ |  | –0.3 to 4    | V    |
| Digital input voltage  | PLAY, REC.   | –0.3 to 6.5  | V    |
|  | D+, D–, XTI, XTO, MMUTE, TEST0, TEST1, POWER, MAMP, $\overline{SSPND}$       | –0.3 to 4    | V    |
| Analog input voltage   | MBIAS, $V_{IN}$ , $V_{COM1}$ , $V_{COM2}$ , $V_{OUTL}$ , $V_{OUTR}$ , FR, FL | –0.3 to 4    | V    |
| Input current (any pins except supplies)                                 |  | ±10          | mA   |
| Ambient temperature under bias   |  | –40 to 125   | °C   |
| Storage temperature  |  | –55 to 150   | °C   |
| Junction temperature   |  | 150          | °C   |

- (1) Stresses beyond those listed under *absolute maximum ratings* may cause permanent damage to the device. These are stress ratings only, and functional operation of the device at these or any other conditions beyond those indicated under *recommended operating conditions* is not implied. Exposure to absolute–maximum–rated conditions for extended periods may affect device reliability.
- (2) All voltage values are with respect to network ground terminal.

## RECOMMENDED OPERATING CONDITIONS

over operating free-air temperature range (unless otherwise noted)

|           |  | MIN            | NOM   | MAX   | UNIT   |
|-----------|--|----------------|-------|-------|--------|
| $V_{BUS}$ | Supply voltage                           | 4.35           | 5.00  | 5.25  | V      |
|           | Analog input voltage, full scale (–0 dB) | 0.43 $V_{CCA}$ |       |       | Vp-p   |
|           | Digital input logic family               | TTL            |       |       |        |
|           | Digital input clock frequency            | 5.997          | 6.000 | 6.003 | MHz    |
|           | Analog output load resistance            | 32             |       |       | Ω      |
|           | Analog output load capacitance           |                |       |       | 100 pF |
|           | Digital output load capacitance          |                |       |       | 10 pF  |
| $T_A$     | Operating free-air temperature           | –25            |       | 70    | °C     |

## ELECTRICAL CHARACTERISTICS

 All specifications at  $T_A = 25^\circ\text{C}$ ,  $V_{\text{BUS}} = 5\text{ V}$ ,  $f_S = 44.1\text{ kHz}$ ,  $f_{\text{IN}} = 1\text{ kHz}$ , 16-bit data, unless otherwise noted

| PARAMETER                   | TEST CONDITIONS                    | PCM2912PJT                      |                       |          | UNIT                       |
|-----------------------------|------------------------------------|---------------------------------|-----------------------|----------|----------------------------|
|                             |                                    | MIN                             | TYP                   | MAX      |                            |
| <b>DIGITAL INPUT/OUTPUT</b> |                                    |                                 |                       |          |                            |
| Host interface              | Apply USB Revision 2.0, full-speed |                                 |                       |          |                            |
| Audio data format           | USB isochronous data format        |                                 |                       |          |                            |
| <b>INPUT LOGIC</b>          |                                    |                                 |                       |          |                            |
| $V_{\text{IH}}$             | Input logic level                  |                                 | 2                     | 3.3      | VDC                        |
| $V_{\text{IL}}$             |                                    |                                 |                       | 0.8      |                            |
| $I_{\text{IH}}^{(1)(2)}$    | Input logic current                | $V_{\text{IN}} = 3.3\text{ V}$  |                       | $\pm 10$ | $\mu\text{A}$              |
| $I_{\text{IL}}^{(1)(2)}$    |                                    | $V_{\text{IN}} = 0\text{ V}$    |                       | $\pm 10$ |                            |
| $I_{\text{IH}}^{(3)}$       |                                    | $V_{\text{IN}} = 3.3\text{ V}$  | 65                    | 100      | $\mu\text{A}$              |
| $I_{\text{IL}}^{(3)}$       |                                    | $V_{\text{IN}} = 0\text{ V}$    |                       | $\pm 10$ |                            |
| <b>OUTPUT LOGIC</b>         |                                    |                                 |                       |          |                            |
| $V_{\text{OH}}^{(1)}$       | Output logic level                 | $I_{\text{OH}} = -10\text{ mA}$ | 2.9                   |          | VDC                        |
| $V_{\text{OL}}^{(1)}$       |                                    | $I_{\text{OL}} = 10\text{ mA}$  |                       | 0.3      |                            |
| $V_{\text{OH}}^{(4)}$       |                                    | $I_{\text{OH}} = -2\text{ mA}$  | 2.8                   |          |                            |
| $V_{\text{OL}}^{(4)}$       |                                    | $I_{\text{OL}} = 2\text{ mA}$   |                       | 0.5      |                            |
| $V_{\text{OL}}^{(5)}$       |                                    | $I_{\text{OL}} = 8\text{ mA}$   |                       | 0.5      |                            |
| $I_{\text{OH}}^{(5)}$       | Output leak current                | $V_{\text{IN}} = 5\text{ V}$    |                       | $\pm 10$ | $\mu\text{A}$              |
| <b>CLOCK FREQUENCY</b>      |                                    |                                 |                       |          |                            |
| Input clock frequency, XTI  |                                    | 5.997                           | 6.000                 | 6.003    | MHz                        |
| <b>MICROPHONE BIAS</b>      |                                    |                                 |                       |          |                            |
| Output voltage              |                                    |                                 | $0.75 V_{\text{CCA}}$ |          | VDC                        |
| Output current              |                                    |                                 | 2                     |          | mA                         |
| Output noise                | $R_L = 1\text{ k}\Omega$           |                                 | 5                     |          | $\mu\text{V}_{\text{rms}}$ |

 (1) Pins 3, 4: D<sup>-</sup>, D<sup>+</sup>.

(2) Pins 8, 23, 24, 27, 28: XTI, MAMP, POWER, TEST1, TEST0

(3) Pin 30: MMUTE

 (4) Pins 7, 29: XTO,  $\overline{\text{SSPND}}$ 

 (5) Pins 31, 32:  $\overline{\text{REC}}$ , PLAY.

**ELECTRICAL CHARACTERISTICS (continued)**All specifications at  $T_A = 25^\circ\text{C}$ ,  $V_{\text{BUS}} = 5\text{ V}$ ,  $f_S = 44.1\text{ kHz}$ ,  $f_{\text{IN}} = 1\text{ kHz}$ , 16-bit data, unless otherwise noted

| PARAMETER                                | TEST CONDITIONS  | PCM2912PJT                         |     |     | UNIT       |
|--|--|------------------------------------|-----|-----|------------|
|  |  | MIN                                | TYP | MAX |            |
| <b>ADC CHARACTERISTICS</b>               |  |                                    |     |     |            |
| Resolution                               |  | 16                                 |     |     | Bits       |
| Audio data channel                       |  | 1                                  |     |     | channel    |
| Sampling frequency                       |  | 8, 11.025, 16, 22.05, 32, 44.1, 48 |     |     | kHz        |
| <b>DYNAMIC PERFORMANCE<sup>(6)</sup></b> |  |                                    |     |     |            |
| THD+N                                    | $V_{\text{IN}} = -1\text{ dB of } 0.43 V_{\text{CCA}}$ | 0.01% 0.02%                        |     |     |            |
| Dynamic range                            | A-weighted   | 82                                 | 90  |     | dB         |
| S/N ratio                                | A-weighted   | 84                                 | 92  |     | dB         |
| <b>DC ACCURACY</b>                       |  |                                    |     |     |            |
| Gain error                               |  | $\pm 2$ $\pm 10$                   |     |     | % of FSR   |
| Bipolar zero error                       |  | $\pm 0$                            |     |     | % of FSR   |
| <b>ANALOG INPUT</b>                      |  |                                    |     |     |            |
| Input voltage                            |  | $0.43 V_{\text{CCA}}$              |     |     | Vp-p       |
| Center voltage                           |  | $0.5 V_{\text{CCA}}$               |     |     | V          |
| Antialiasing filter frequency response   | $-3\text{ dB}$   | 150                                |     |     | kHz        |
|  | $f_{\text{IN}} = 20\text{ kHz}$                        | $-0.08$                            |     |     | dB         |
| <b>MICROPHONE AMPLIFIER</b>              |  |                                    |     |     |            |
| Gain                                     |  | 0                                  | 20  |     | dB         |
| Input impedance                          |  | 20                                 |     |     | k $\Omega$ |
| <b>INPUT PGA</b>                         |  |                                    |     |     |            |
| Gain range                               |  | $-12$                              | 30  |     | dB         |
| Gain step size                           |  | 1                                  |     |     | dB         |
| <b>DIGITAL FILTER PERFORMANCE</b>        |  |                                    |     |     |            |
| Pass band                                |  | $0.454 f_S$                        |     |     | Hz         |
| Stop band                                |  | $0.583 f_S$                        |     |     | Hz         |
| Pass-band ripple                         |  | $\pm 0.02$                         |     |     | dB         |
| Stop-band attenuation                    |  | $-65$                              |     |     | dB         |
| Delay time                               |  | $17.4/f_S$                         |     |     | s          |
| HPF frequency response                   | $-3\text{ dB}$   | $0.078 f_S$                        |     |     | MHz        |

(6)  $f_{\text{IN}} = 1\text{ kHz}$ , using Audio Precision™ System Two™, RMS mode with 20 kHz LPF, 400 Hz HPF in calculation. Mic amp = 0 dB, PGA = 0 dB.

**ELECTRICAL CHARACTERISTICS (continued)**

All specifications at  $T_A = 25^\circ\text{C}$ ,  $V_{\text{BUS}} = 5\text{ V}$ ,  $f_S = 44.1\text{ kHz}$ ,  $f_{\text{IN}} = 1\text{ kHz}$ , 16-bit data, unless otherwise noted

| PARAMETER  | TEST CONDITIONS  | PCM2912PJT                         |         |          | UNIT       |
|--|--|------------------------------------|---------|----------|------------|
|  |  | MIN                                | TYP     | MAX      |            |
| <b>DAC CHARACTERISTICS</b>                       |  |                                    |         |          |            |
| Resolution                                       |  | 16                                 |         |          | Bits       |
| Audio data channel                               |  | 1, 2                               |         |          | channel    |
| Sampling frequency                               |  | 8, 11.025, 16, 22.05, 32, 44.1, 48 |         |          | kHz        |
| <b>DYNAMIC PERFORMANCE<sup>(7)</sup></b>         |  |                                    |         |          |            |
| THD+N  | $R_L > 10\text{ k}\Omega$ , $V_{\text{OUT}} = 0\text{ dB}$ of $0.6 V_{\text{CCA}}$ | 0.01% 0.02%                        |         |          |            |
|  | $R_L = 32\ \Omega$ , $V_{\text{OUT}} = 0\text{ dB}$ of $0.55 V_{\text{CCA}}$       | 0.02% 0.05%                        |         |          |            |
| Dynamic range                                    | EIAJ, A-Weighted   | 82                                 | 90      |          | dB         |
| S/N ratio  | EIAJ, A-Weighted   | 84                                 | 92      |          | dB         |
| Channel separation                               | $R_L > 10\text{ k}\Omega$  | 80                                 | 88      |          | dB         |
| <b>DC ACCURACY</b>                               |  |                                    |         |          |            |
| Gain mismatch channel-to-channel                 |  |                                    | $\pm 2$ | $\pm 10$ | % of FSR   |
| Gain error                                       |  |                                    | $\pm 2$ | $\pm 10$ | % of FSR   |
| Bipolar zero error                               |  |                                    | $\pm 3$ |          | % of FSR   |
| <b>ANALOG OUTPUT</b>                             |  |                                    |         |          |            |
| Output voltage                                   | $R_L > 10\text{ k}\Omega$  | $0.6 V_{\text{CCA}}$               |         |          | Vp-p       |
|  | $R_L = 32\ \Omega$   | $0.55 V_{\text{CCA}}$              |         |          |            |
| Center voltage                                   |  | $0.5 V_{\text{CCA}}$               |         |          | V          |
| Output power                                     | $R_L = 32\ \Omega$   | 13                                 |         |          | mW         |
|  | $R_L = 16\ \Omega$   | 25                                 |         |          |            |
| Load impedance (AC coupling)                     | LINE   | 10                                 |         |          | k $\Omega$ |
|  | HEADPHONE  | 16                                 | 32      |          | $\Omega$   |
| LPF frequency response                           | -3 dB  | 140                                |         |          | kHz        |
|  | $f = 20\text{ kHz}$  | -0.1                               |         |          | dB         |
| <b>SIDETONE PROGRAMMABLE ATTENUATOR</b>          |  |                                    |         |          |            |
| Gain range                                       |  | -76                                |         | 0        | dB         |
| Gain step size                                   |  |                                    | 1       |          | dB         |
| <b>OUTPUT PROGRAMMABLE ATTENUATOR</b>            |  |                                    |         |          |            |
| Gain range                                       |  | -76                                |         | 0        | dB         |
| Gain step size                                   |  |                                    | 1       |          | dB         |
| <b>ANALOG LOOPBACK PERFORMANCE<sup>(8)</sup></b> |  |                                    |         |          |            |
| THD+N  | $R_L > 10\text{ k}\Omega$ , $V_{\text{IN}} = 0\text{ dB}$ of $0.43 V_{\text{CCA}}$ | 0.01% 0.02%                        |         |          |            |
|  | $R_L = 32\ \Omega$ , $V_{\text{IN}} = 0\text{ dB}$ of $0.43 V_{\text{CCA}}$        | 0.02% 0.05%                        |         |          |            |
| Dynamic range                                    | EIAJ, A-weighted   | 82                                 | 90      |          | dB         |
| S/N ratio  | EIAJ, A-weighted   | 84                                 | 92      |          | dB         |

(7)  $f_{\text{OUT}} = 1\text{ kHz}$ , using Audio Precision™ System Two™, RMS mode with 20 kHz LPF, 400 Hz HPF. Output attenuator = 0 dB, Sidetone = Mute.

(8) MIC Amp = 0 dB, Sidetone attenuator = 0 dB, Output attenuator = 0 dB.

**ELECTRICAL CHARACTERISTICS (continued)**All specifications at  $T_A = 25^\circ\text{C}$ ,  $V_{\text{BUS}} = 5\text{ V}$ ,  $f_S = 44.1\text{ kHz}$ ,  $f_{\text{IN}} = 1\text{ kHz}$ , 16-bit data, unless otherwise noted

| PARAMETER   | TEST CONDITIONS                           | PCM2912PJT  |             |             | UNIT                      |
|---|---|-------------|-------------|-------------|---------------------------|
|   |   | MIN         | TYP         | MAX         |                           |
| <b>DIGITAL FILTER PERFORMANCE</b>   |   |             |             |             |                           |
| Pass band   |   |             |             | 0.445 $f_S$ | Hz                        |
| Stop band   |   | 0.555 $f_S$ |             |             | Hz                        |
| Pass-band ripple  |   |             |             | $\pm 0.1$   | dB                        |
| Stop-band attenuation   |   | -43         |             |             | dB                        |
| Delay time  |   |             | 14.3/ $f_S$ |             | s                         |
| <b>POWER SUPPLY REQUIREMENTS</b>  |   |             |             |             |                           |
| $V_{\text{BUS}}$ Voltage range  | Bus-powered                               | 4.35        | 5.0         | 5.25        | VDC                       |
| Supply current  | ADC, DAC operation ( $R_L = 32\ \Omega$ ) |             | 85          | 100         | mA                        |
|   | Suspend mode <sup>(9)</sup>               |             | 220         | 300         | $\mu\text{A}$             |
| Power dissipation   | ADC, DAC Operation                        |             | 425         | 500         | mW                        |
|   | Suspend mode <sup>(9)</sup>               |             | 0.8         | 1           | mW                        |
| $V_{\text{CCP}}, V_{\text{CCL}}, V_{\text{CCR}}, V_{\text{CCA}}, V_{\text{DD}}$ Internally generated power supply voltage <sup>(10)</sup> |   | 3           | 3.3         | 3.6         | VDC                       |
| <b>TEMPERATURE RANGE</b>  |   |             |             |             |                           |
| Operation temperature   |   | -25         |             | 85          | $^\circ\text{C}$          |
| $\theta_{\text{JA}}$ Thermal resistance   | 32-pin TQFP                               |             | 80          |             | $^\circ\text{C}/\text{W}$ |

(9) Under USB suspend state

(10) Pins 5, 15, 19, 21, 26:  $V_{\text{DD}}, V_{\text{CCA}}, V_{\text{CCL}}, V_{\text{CCR}}, V_{\text{CCP}}$ .

**DEVICE INFORMATION**

**PIN ASSIGNMENTS**

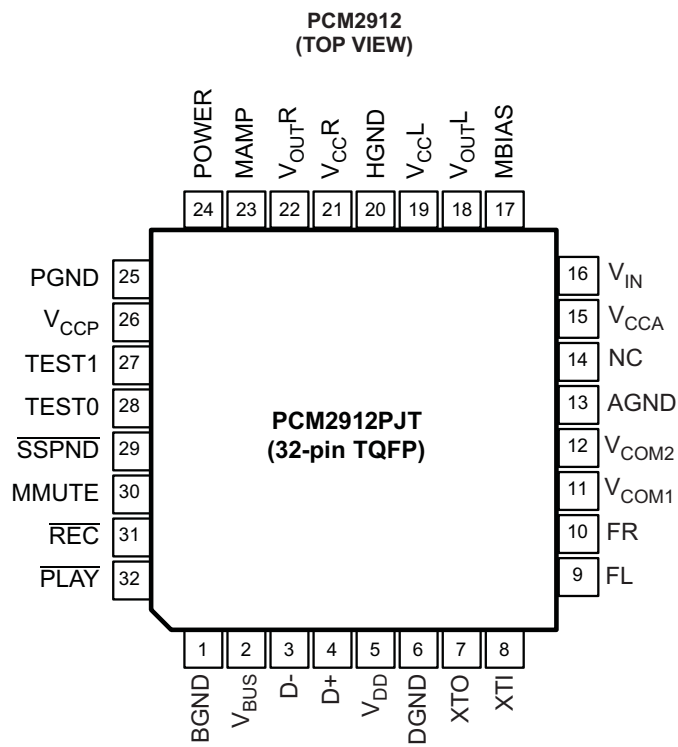

### TERMINAL FUNCTIONS

| TERMINAL                  |     | I/O | DESCRIPTIONS  |
|---------------------------|-----|-----|---|
| NAME                      | PJT |     |   |
| BGND                      | 1   | –   | Reference for internal regulator.   |
| V <sub>BUS</sub>          | 2   | –   | Connect to USB power (V <sub>BUS</sub> )  |
| D–                        | 3   | I/O | USB differential input/output minus <sup>(1)</sup>  |
| D+                        | 4   | I/O | USB differential input/output plus <sup>(1)</sup>   |
| V <sub>DD</sub>           | 5   | –   | Digital power supply <sup>(2)</sup>   |
| DGND                      | 6   |     | Digital ground  |
| XTO                       | 7   | O   | Crystal oscillator output   |
| XTI                       | 8   | I   | Crystal oscillator input <sup>(3)</sup>   |
| FL                        | 9   | –   | External filter pin of L-channel (optional)   |
| FR                        | 10  | –   | External filter pin of R-channel (optional)   |
| V <sub>COM1</sub>         | 11  | –   | Common voltage for ADC, DAC and analog front end (V <sub>CCA</sub> /2). Decouple capacitor should be connected to AGND. |
| V <sub>COM2</sub>         | 12  | –   | Common voltage for headphone (V <sub>CCA</sub> /2). Decouple capacitor should be connected to AGND.                     |
| AGND                      | 13  | –   | Analog ground   |
| NC                        | 14  | –   | Not connected   |
| V <sub>CCA</sub>          | 15  | –   | Analog power supply   |
| V <sub>IN</sub>           | 16  | I   | ADC microphone input  |
| MBIAS                     | 17  | O   | Microphone bias output (0.75 V <sub>CCA</sub> )   |
| V <sub>OUTL</sub>         | 18  | O   | Headphone output for L-channel  |
| V <sub>CCL</sub>          | 19  | –   | Analog power supply for headphone amplifier of L-channel <sup>(2)</sup>   |
| HGND                      | 20  | –   | Analog ground for headphone amplifier   |
| V <sub>CCR</sub>          | 21  | –   | Analog power supply for headphone amplifier of R-channel <sup>(2)</sup>   |
| V <sub>OUTR</sub>         | 22  | O   | Headphone output for R-channel  |
| MAMP                      | 23  | I   | Microphone preamplifier gain control (LOW: Preamplifier off, HIGH: Preamplifier on = +20 dB) <sup>(3)</sup>             |
| POWER                     | 24  | I   | Power consumption declaration select pin (LOW: 100 mA, HIGH: 500 mA) <sup>(3)</sup>                                     |
| PGND                      | 25  | –   | Analog ground for microphone bias, microphone amplifier, and PGA  |
| V <sub>CCP</sub>          | 26  | –   | Analog power supply for PLL <sup>(2)</sup>  |
| TEST1                     | 27  | I   | Test pin. Must be set to HIGH <sup>(3)</sup>  |
| TEST0                     | 28  | I   | Test pin. Must be set to LOW <sup>(3)</sup>   |
| $\overline{\text{SSPND}}$ | 29  | O   | Suspend flag (LOW: Suspend, HIGH: Operational state)  |
| MMUTE                     | 30  | I   | Microphone mute control, active HIGH (LOW: Mute off, HIGH: Mute on) <sup>(4)</sup>                                      |
| $\overline{\text{REC}}$   | 31  | O   | Status output for record (LOW: Record, FLASH: Mute on recode, HIGH: Stop) <sup>(5)</sup>                                |
| $\overline{\text{PLAY}}$  | 32  | O   | Status output for playback (LOW: Playback, FLASH: Mute on playback, HIGH: Stop) <sup>(5)</sup>                          |

- (1) LV-TTL level  
(2) Connect decouple capacitor to corresponding ground.  
(3) 3.3-V CMOS level input.  
(4) 3.3-V CMOS level input with internal pulldown.  
(5) 5 V tolerant, open-drain.



**FUNCTIONAL BLOCK DIAGRAM**

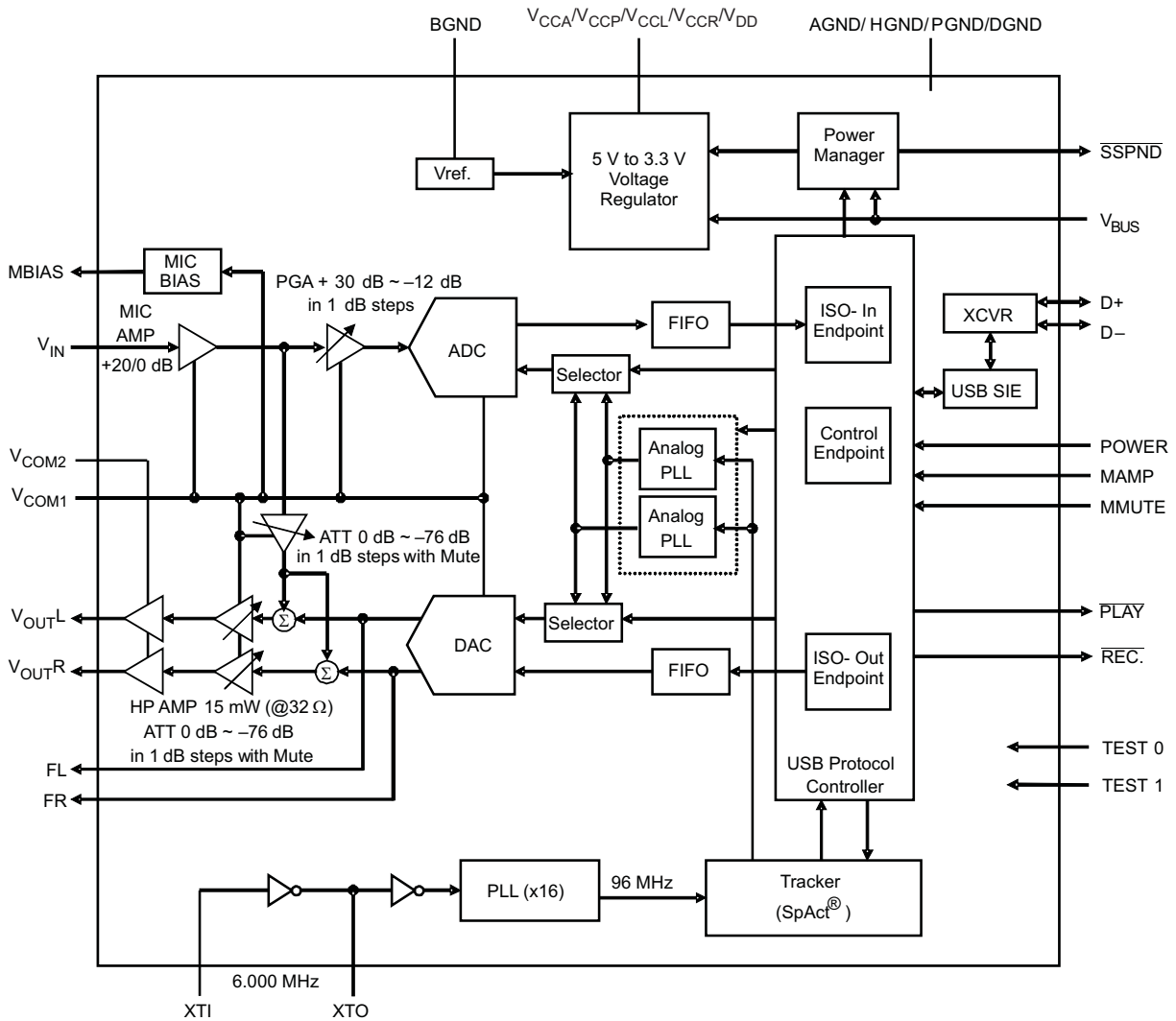

**TYPICAL PERFORMANCE CURVES OF INTERNAL FILTER**

All specifications at  $T_A = 25^\circ\text{C}$ ,  $V_{\text{BUS}} = 5\text{ V}$ ,  $f_S = 44.1\text{ kHz}$ ,  $f_{\text{IN}} = 1\text{ kHz}$ , 16-bit data, unless otherwise noted.

**ADC Digital Decimation Filter Frequency Response**

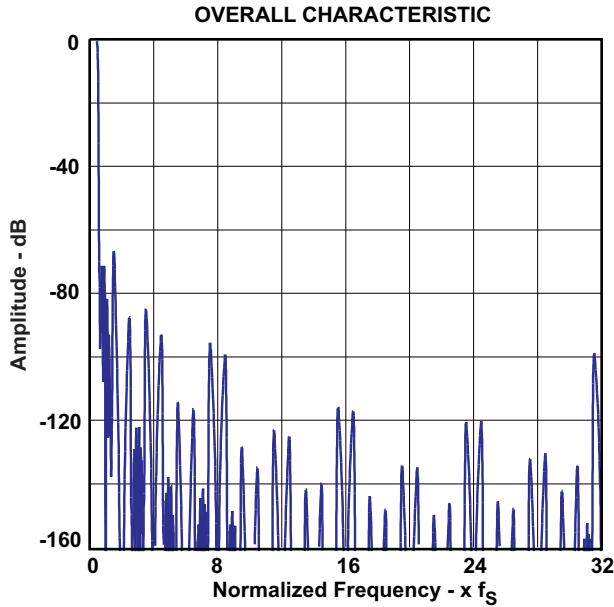

Figure 1.

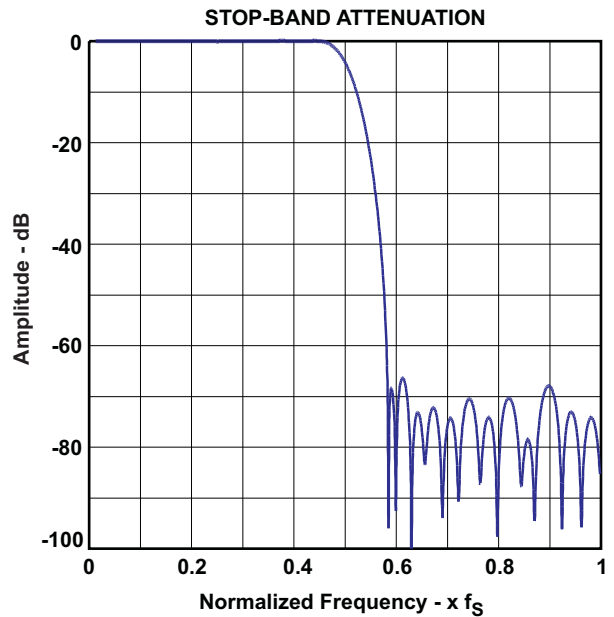

Figure 2.

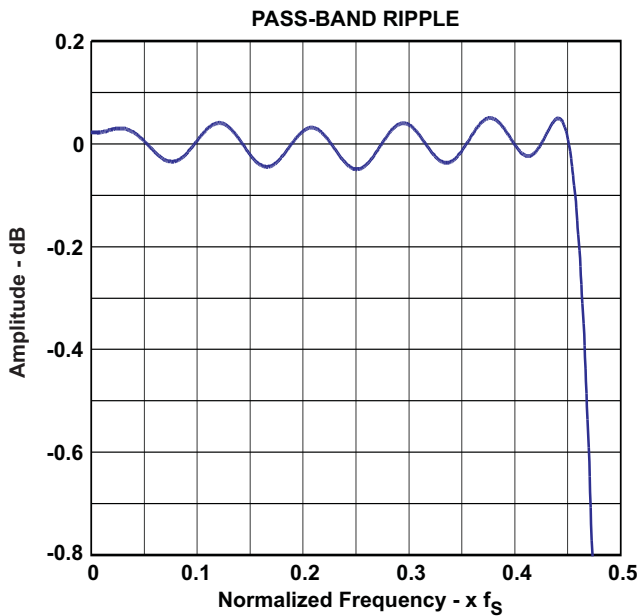

Figure 3.

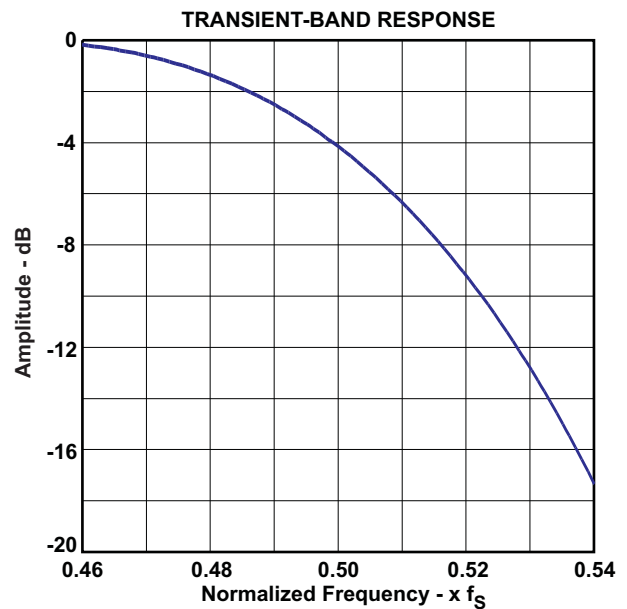

Figure 4.

### TYPICAL PERFORMANCE CURVES OF INTERNAL FILTER (continued)

All specifications at  $T_A = 25^\circ\text{C}$ ,  $V_{\text{BUS}} = 5\text{ V}$ ,  $f_S = 44.1\text{ kHz}$ ,  $f_{\text{IN}} = 1\text{ kHz}$ , 16-bit data, unless otherwise noted.

#### ADC Digital High-Pass Filter Frequency Response

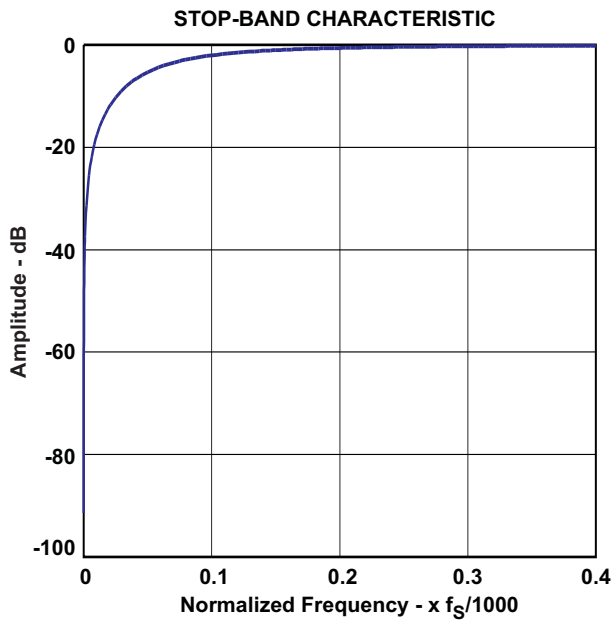

Figure 5.

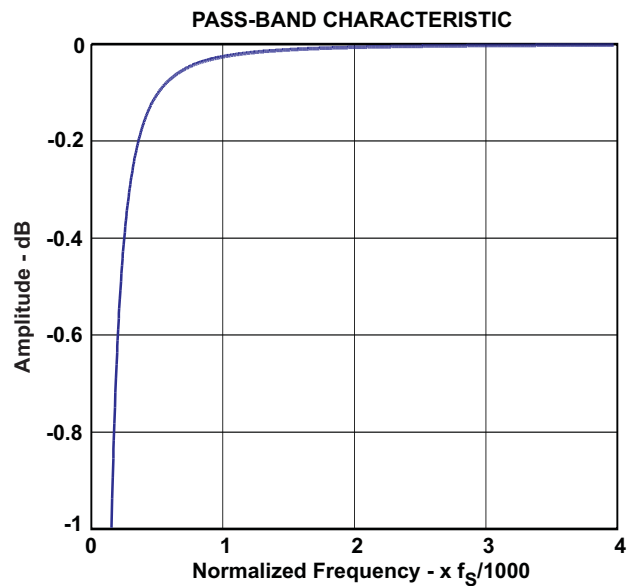

Figure 6.

#### ADC Analog Antialiasing Filter Frequency Response

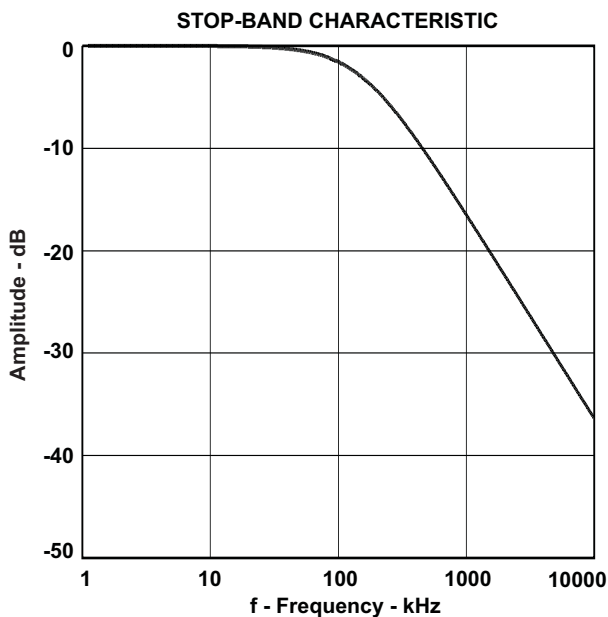

Figure 7.

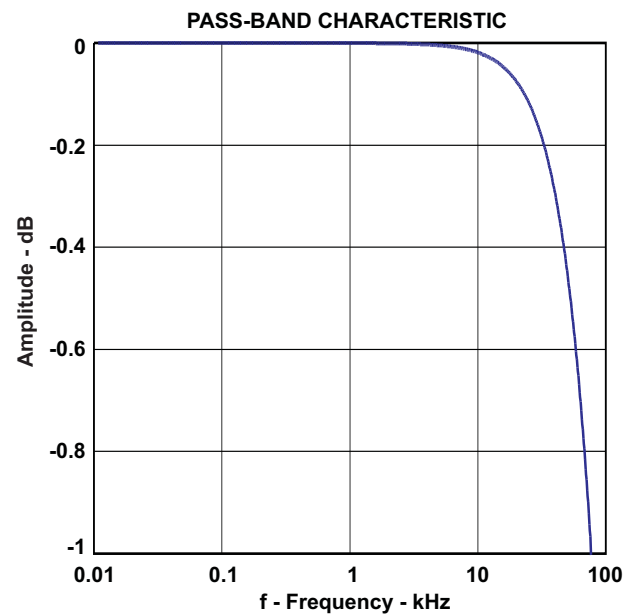

Figure 8.

**TYPICAL PERFORMANCE CURVES OF INTERNAL FILTER (continued)**

All specifications at  $T_A = 25^\circ\text{C}$ ,  $V_{\text{BUS}} = 5\text{ V}$ ,  $f_S = 44.1\text{ kHz}$ ,  $f_{\text{IN}} = 1\text{ kHz}$ , 16-bit data, unless otherwise noted.

**DAC Digital Interpolation Filter Frequency Response**

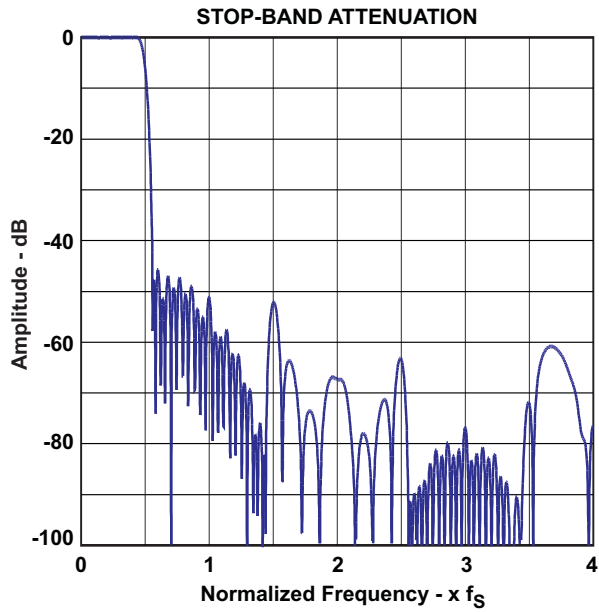

Figure 9.

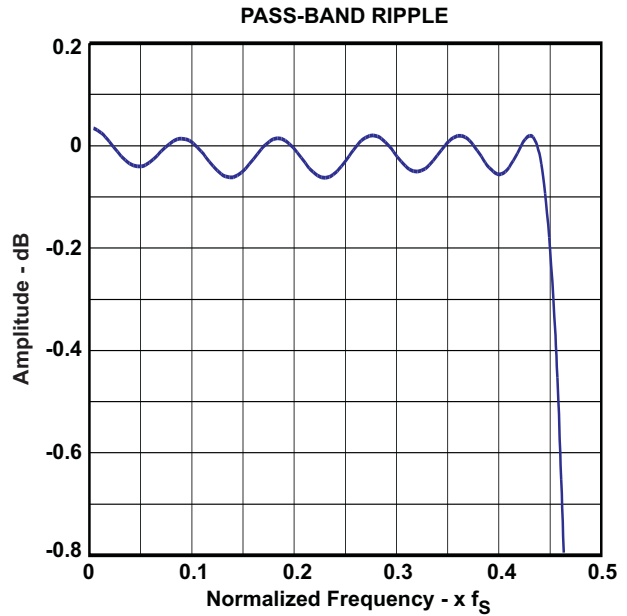

Figure 10.

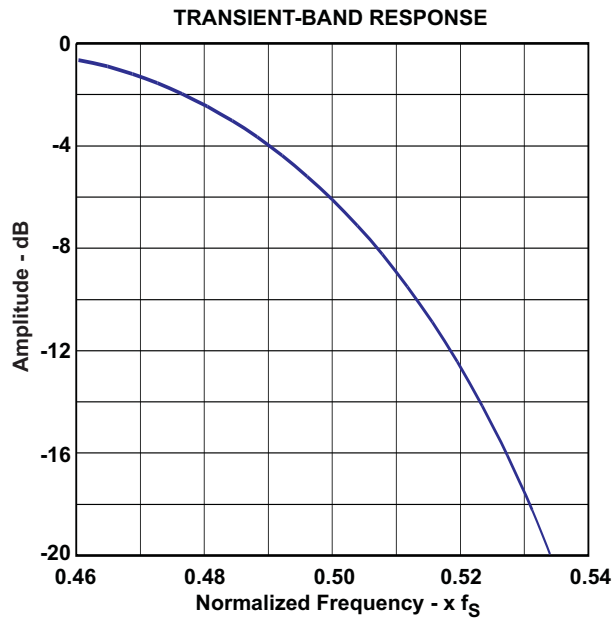

Figure 11.

**TYPICAL PERFORMANCE CURVES OF INTERNAL FILTER (continued)**

All specifications at  $T_A = 25^\circ\text{C}$ ,  $V_{\text{BUS}} = 5\text{ V}$ ,  $f_S = 44.1\text{ kHz}$ ,  $f_{\text{IN}} = 1\text{ kHz}$ , 16-bit data, unless otherwise noted.

**DAC Analog FIR Filter Frequency Response**

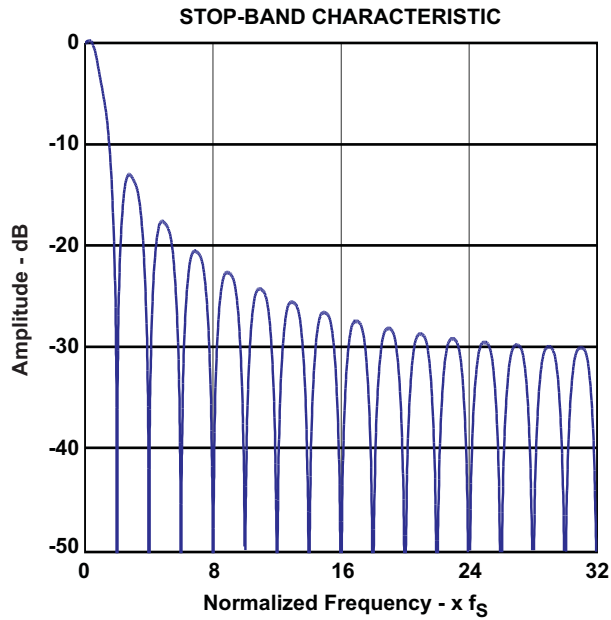

Figure 12.

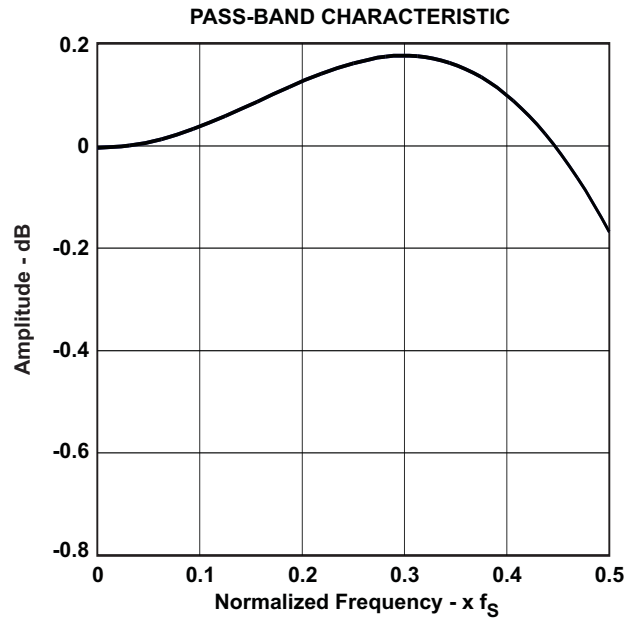

Figure 13.

**DAC Analog Low-Pass Filter Frequency Response**

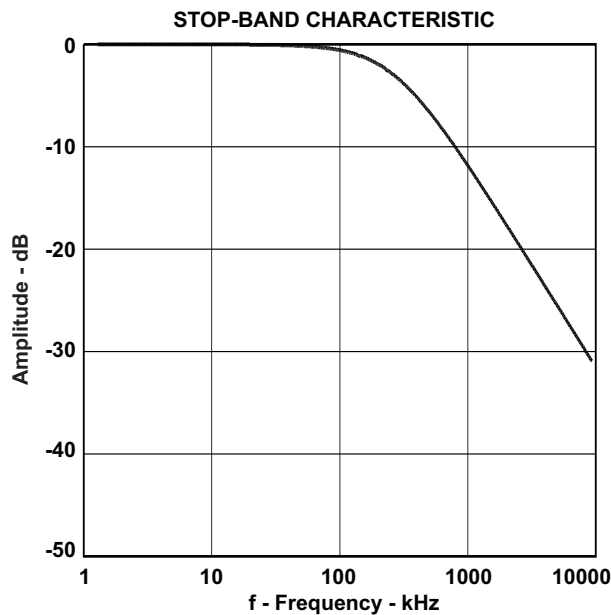

Figure 14.

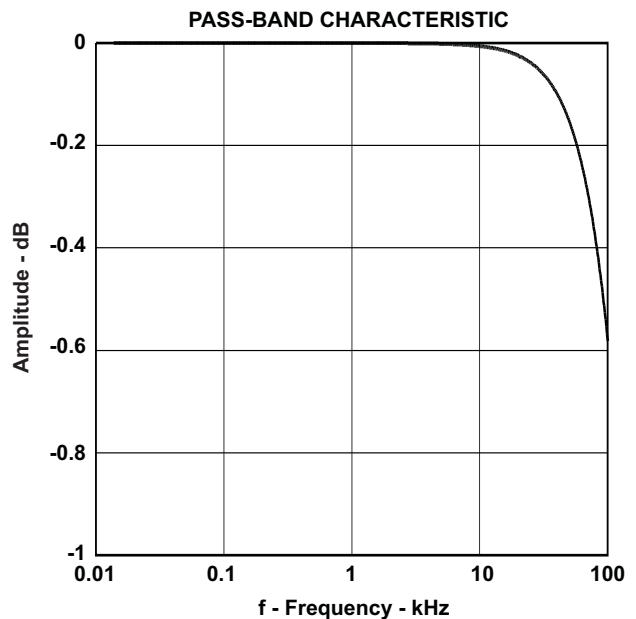

Figure 15.

### TYPICAL PERFORMANCE CURVES

All specifications at  $T_A = 25^\circ\text{C}$ ,  $V_{BUS} = 5\text{ V}$ ,  $f_S = 44.1\text{ kHz}$ ,  $f_{IN} = 1\text{ kHz}$ , 16-bit data, unless otherwise noted.

#### ADC

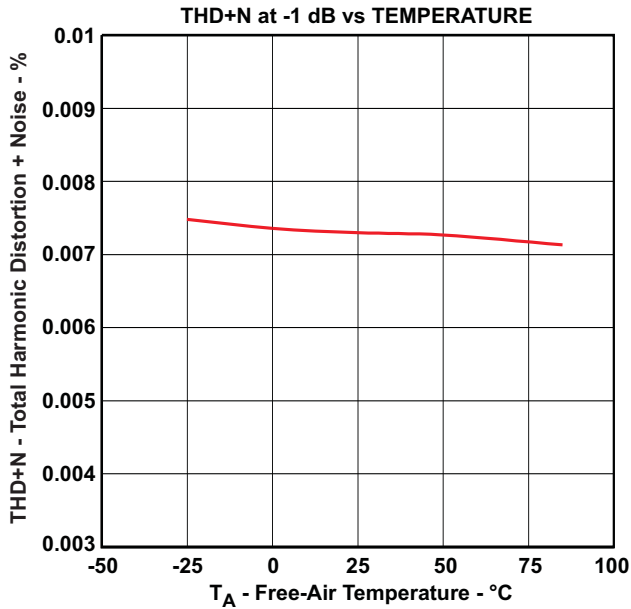

Figure 16.

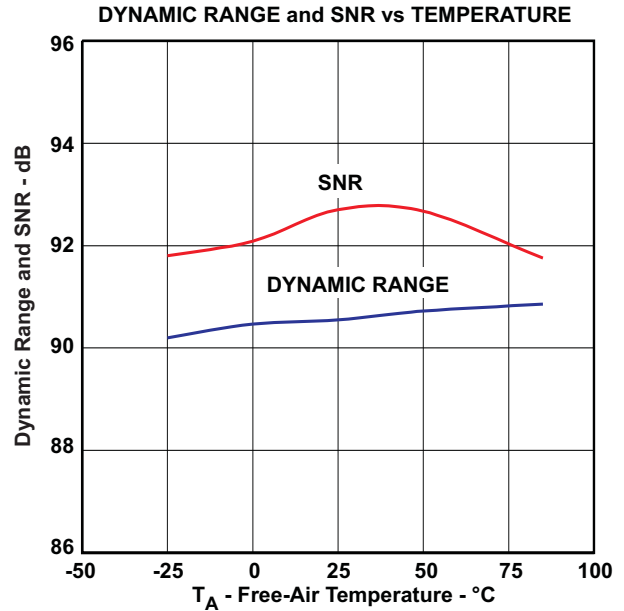

Figure 17.

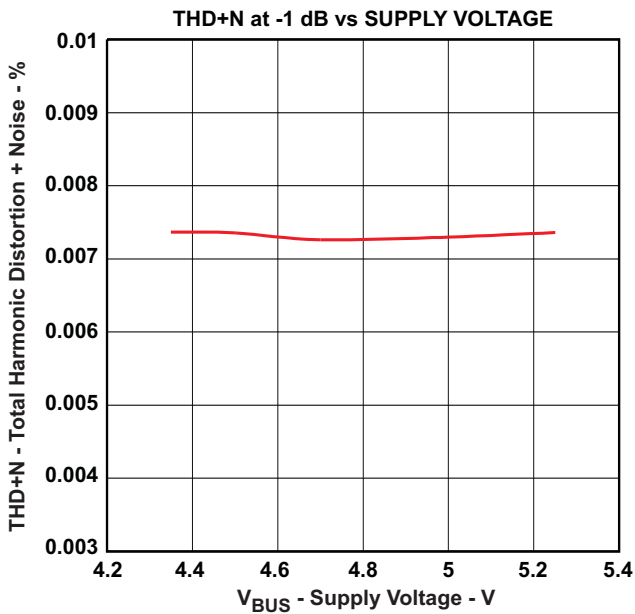

Figure 18.

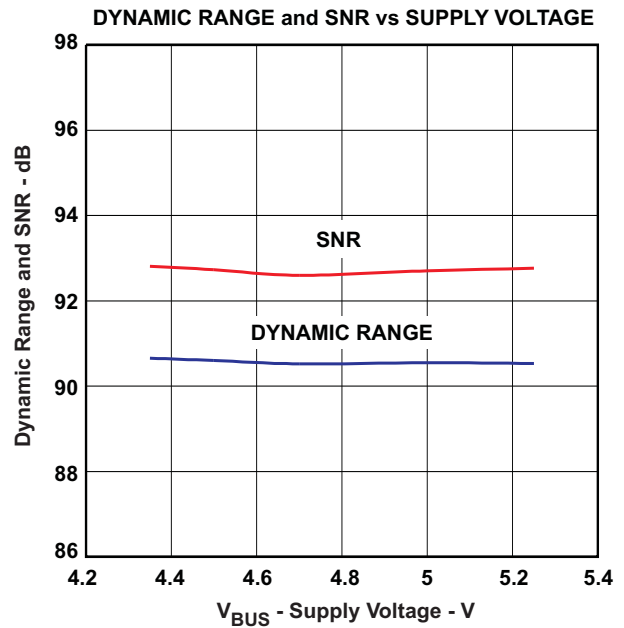

Figure 19.

**TYPICAL PERFORMANCE CURVES (continued)**

All specifications at  $T_A = 25^\circ\text{C}$ ,  $V_{\text{BUS}} = 5\text{ V}$ ,  $f_S = 44.1\text{ kHz}$ ,  $f_{\text{IN}} = 1\text{ kHz}$ , 16-bit data, unless otherwise noted.

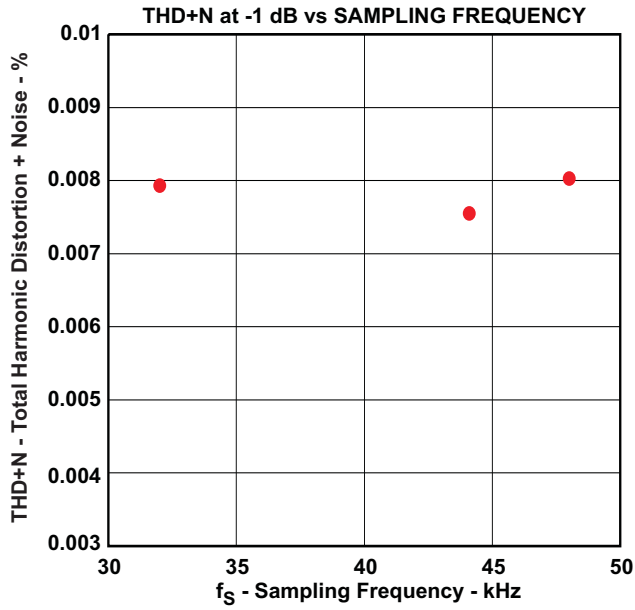

Figure 20.

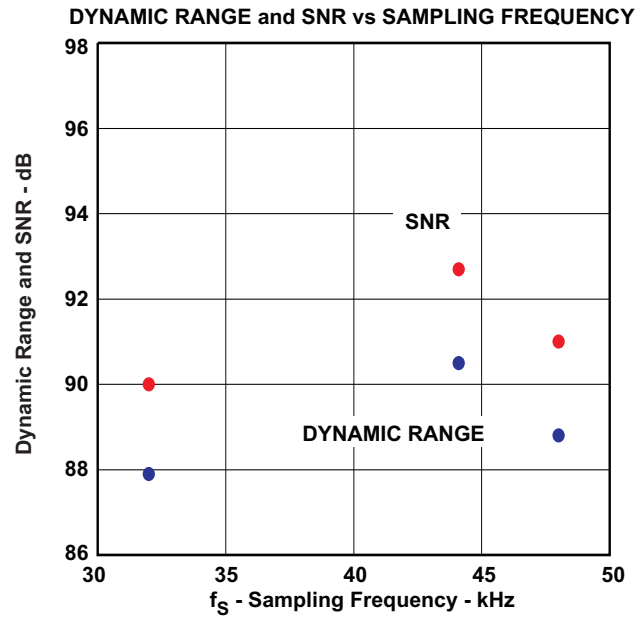

Figure 21.

**DAC**

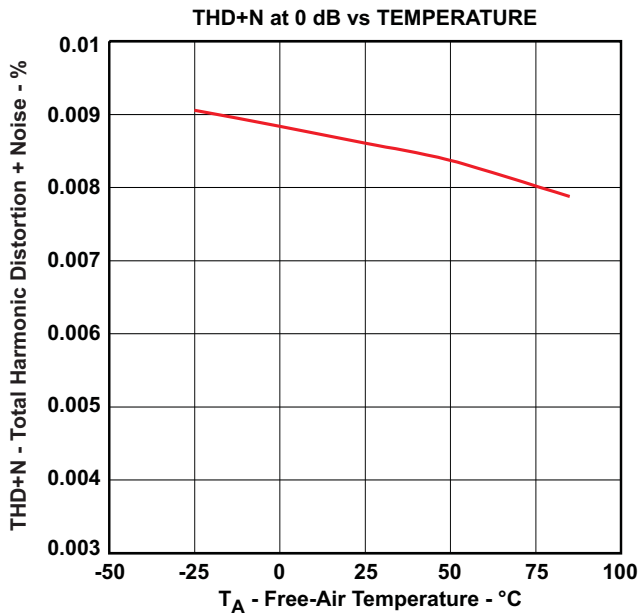

Figure 22.

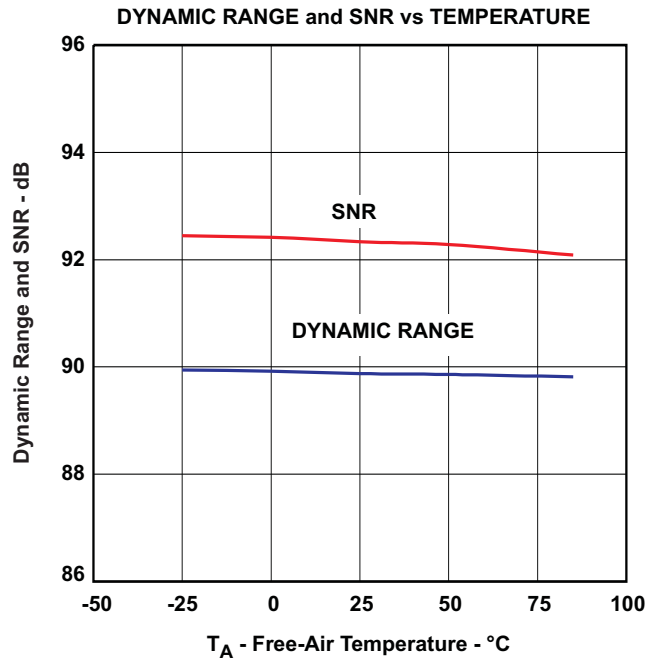

Figure 23.

**TYPICAL PERFORMANCE CURVES (continued)**

All specifications at  $T_A = 25^\circ\text{C}$ ,  $V_{\text{BUS}} = 5\text{ V}$ ,  $f_S = 44.1\text{ kHz}$ ,  $f_{\text{IN}} = 1\text{ kHz}$ , 16-bit data, unless otherwise noted.

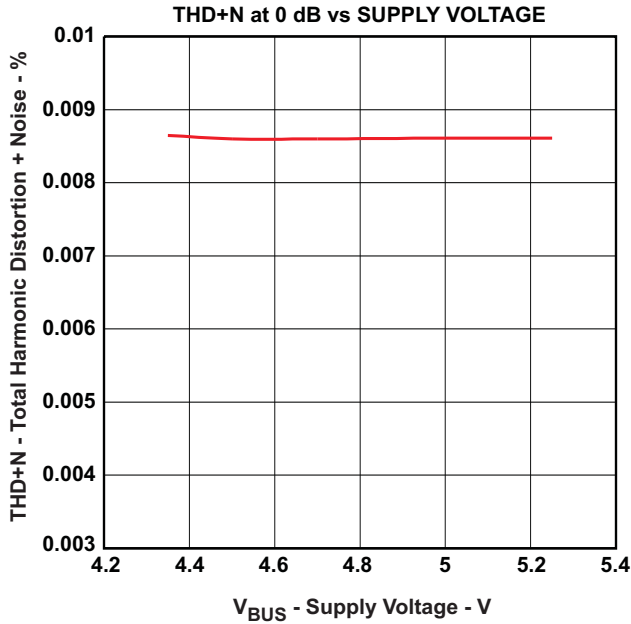

Figure 24.

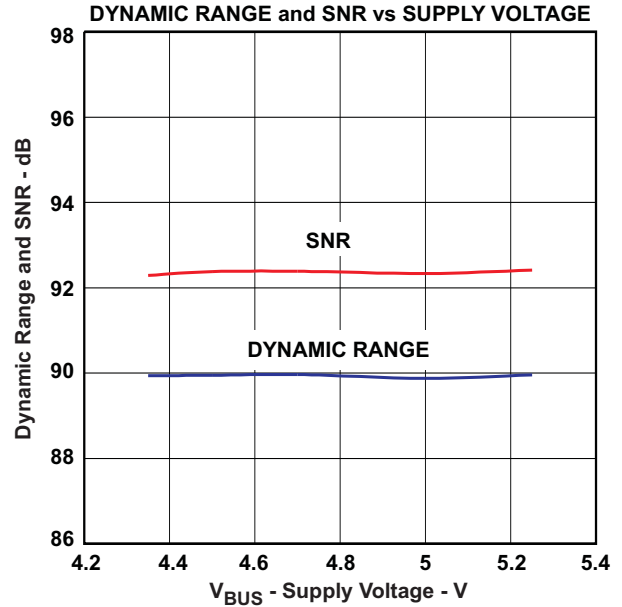

Figure 25.

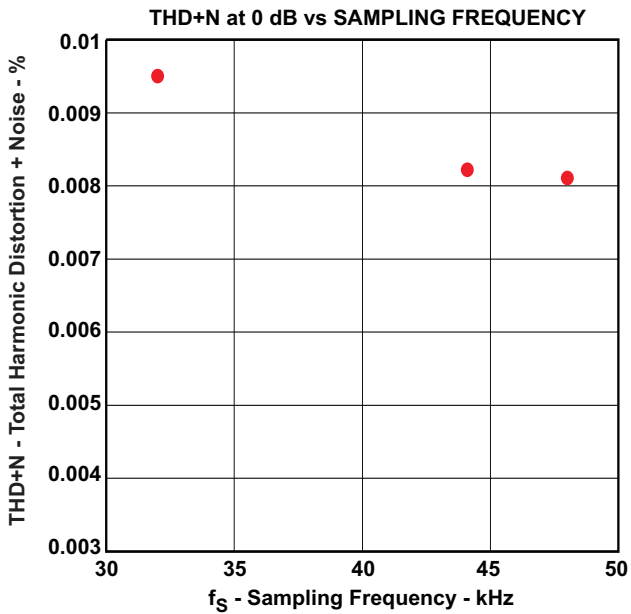

Figure 26.

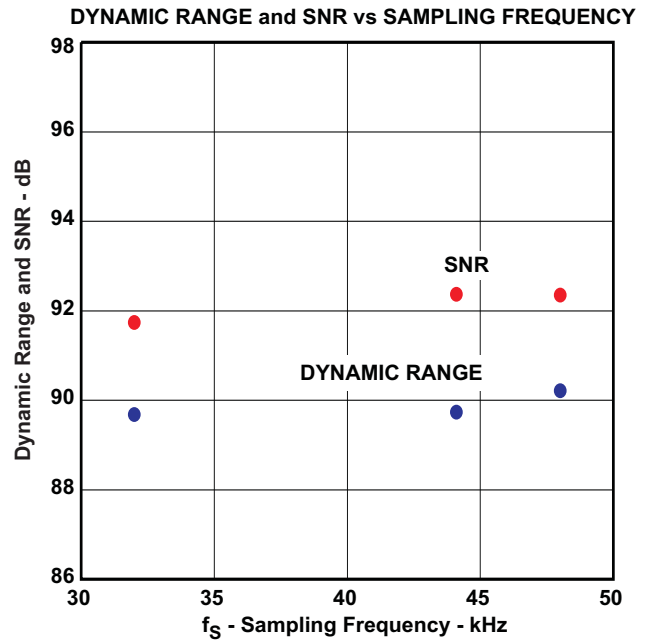

Figure 27.



**TYPICAL PERFORMANCE CURVES (continued)**

All specifications at  $T_A = 25^\circ\text{C}$ ,  $V_{\text{BUS}} = 5\text{ V}$ ,  $f_s = 44.1\text{ kHz}$ ,  $f_{\text{IN}} = 1\text{ kHz}$ , 16-bit data, unless otherwise noted.

**Supply Current**

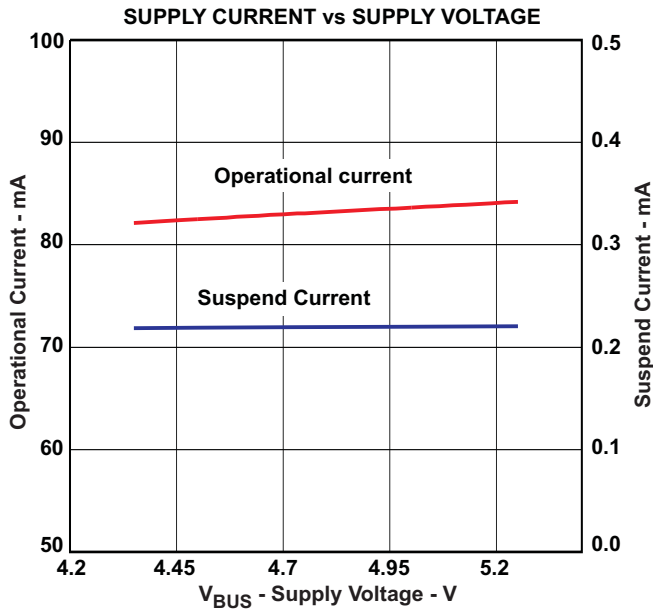

Figure 28.

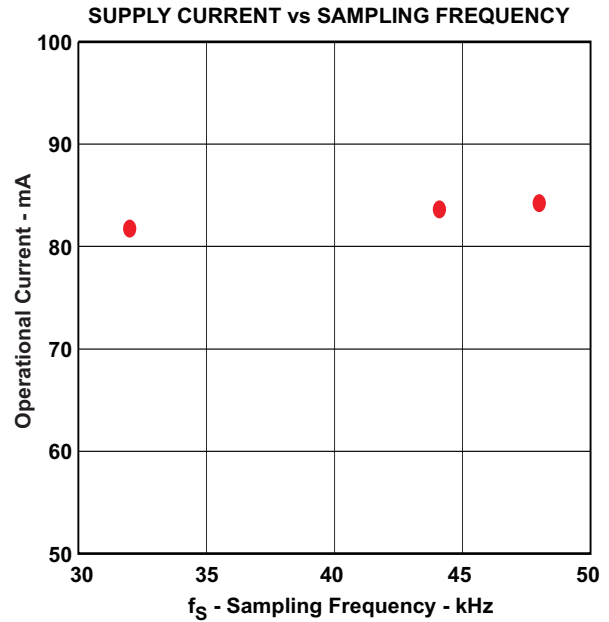

Figure 29.

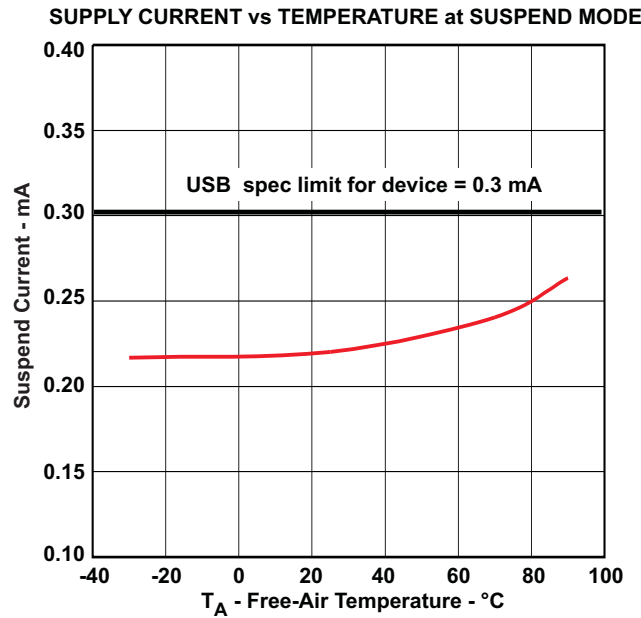

Figure 30.

## USB INTERFACE

Control data and audio data are transferred to the PCM2912 via D+ (pin 4) and D– (pin 3). All data to/from the PCM2912 are performed in full-speed. The following information is described in the device descriptor. The device descriptor can be modified on request.

**Table 1. Device Descriptor**

|                                |   |
|--------------------------------|---|
| USB revision                   | 2.0 compliant                                 |
| Device class                   | 0x00 (device defined interface level)         |
| Device sub class               | 0x00 (not specified)                          |
| Device protocol                | 0x00 (not specified)                          |
| Max packet size for endpoint 0 | 8 byte  |
| Vendor ID                      | 0x08BB  |
| Product ID                     | 0x2910  |
| Device release number          | 0x0100 (1.00)                                 |
| Number of configurations       | 1   |
| Vendor string                  | String #1 (refer to <a href="#">Table 3</a> ) |
| Product string                 | String #2 (refer to <a href="#">Table 3</a> ) |
| Serial number                  | Not supported                                 |

The following information is described in the configuration descriptor. The configuration descriptor can be modified on request.

**Table 2. Configuration Descriptor**

|                 |   |
|-----------------|---|
| Interface       | 3 interfaces  |
| Power attribute | 0x80 (Bus powered, no remote wakeup)                      |
| Max power       | 0x32 (100 mA at POWER=Low) / 0xFA (500mA at POWER = High) |

The following information is described in the string descriptor. The string descriptor can be modified on request.

**Table 3. String Descriptor**

|    |                    |
|----|--------------------|
| #0 | 0x0409             |
| #1 | Burr-Brown from TI |
| #2 | USB audio CODEC    |

## Device Configuration

Figure 31 illustrates USB audio function topology. The PCM2912 has three interfaces. Each interface is constructed by some alternative settings.

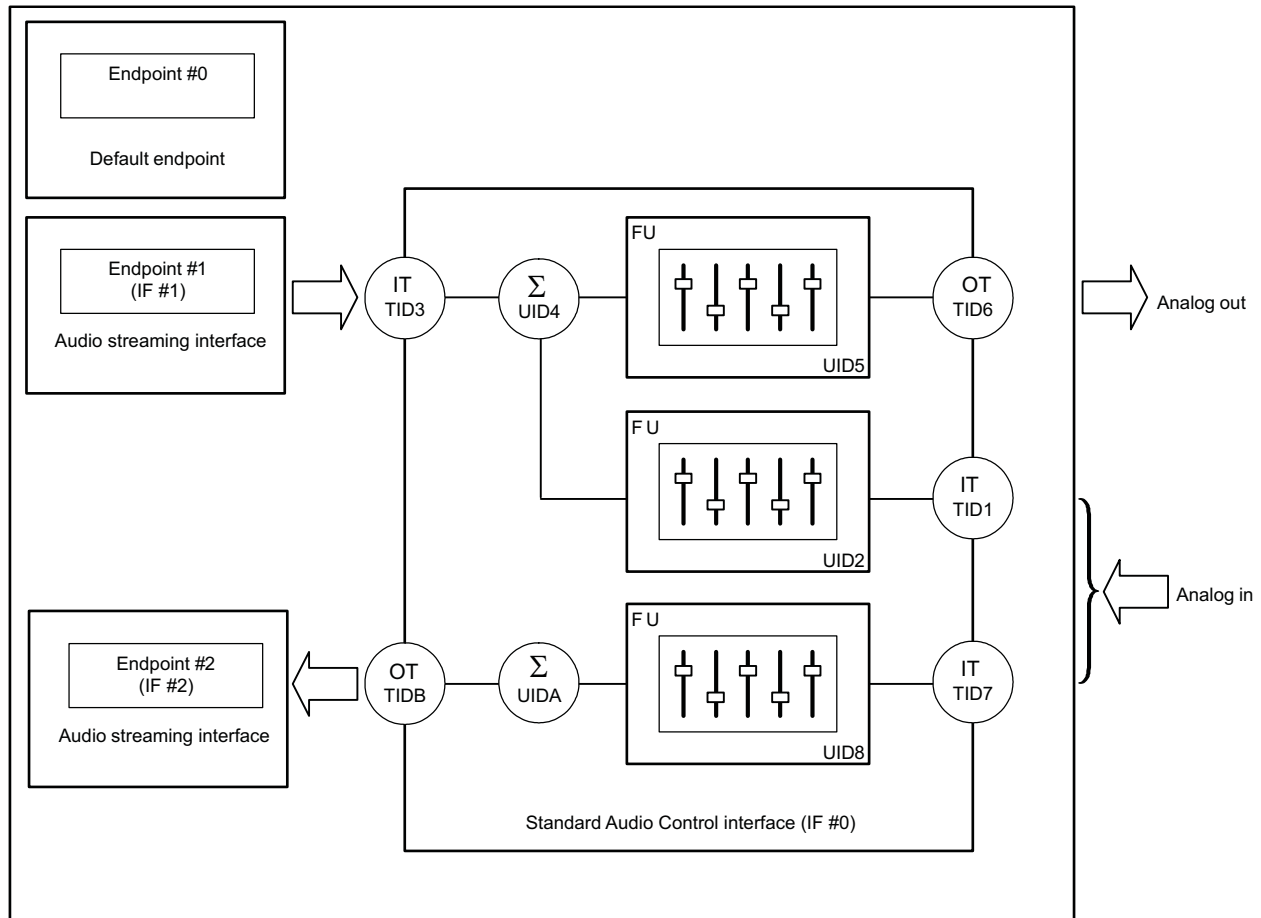

**Figure 31. USB Audio Function Topology**

### Interface #0

Interface #0 is for control interface. Alternative setting #0 is the only possible setting for interface #0. Alternative setting #0 describes the standard audio control interface. Audio control interface is constructed by a terminal. The PCM2912 has ten terminals as follows.

- Input Terminal (Terminal ID#1) for audio analog input for sidetone
- Feature Unit (Unit ID#2) for sidetone PGA
- Input Terminal (Terminal ID#3) for isochronous-out stream
- Mixer Unit (Unit ID#4) for sidetone mixing
- Feature Unit (Unit ID#5) for analog output PGA
- Output Terminal (Terminal ID#6) for audio analog output
- Input Terminal (Terminal ID#7) for audio analog input
- Feature Unit (Unit ID#8) for analog input PGA
- Mixer Unit (Unit ID#A) for analog input
- Output Terminal (Terminal ID#B) for isochronous-in stream

The Input Terminal #3 is defined as *USB stream* (terminal type 0x0101). The Input Terminal #3 can accept 2-channel audio streams constructed by Left and Right channels. The Output Terminal #6 is defined as a *speaker* (terminal type 0x0301). The Input Terminals #1 and #7 are defined as *Microphone* (terminal type 0x0201). Physically, these two input terminals are the same input, but logically duplicated. The Output Terminal #B is defined as a *USB stream* (terminal type 0x0101). The Output Terminal #B is a single-channel audio stream. The Mixer Unit #4 mixes up the analog input (sidetone) and the audio data of the DAC. The Mixer Unit #A is placed in front of the Output Terminal #B. The Mixer Unit #A has no impact on record data. The Mixer Units #4 and #A do not have programming capability.

The Feature Unit #5 supports the following sound control features for analog outputs.

- Volume control
- Mute control

The built-in volume controller can be manipulated by an audio-class-specific request from 0 dB to –76 dB in steps of 1 dB. An individual (L and R) channel can be set for different values. The built-in mute controller can be manipulated by an audio-class-specific request. Only a master mute control request is acceptable.

The Feature Unit #2 supports the following sound control features for analog input (sidetone).

- Volume control
- Mute control

The built-in volume controller can be manipulated by an audio-class-specific request from 0 dB to –76 dB in 1-dB steps. The only master volume control is acceptable. The built-in mute controller can be manipulated by audio-class-specific request. The only master mute control request is acceptable.

The Feature Unit #8 supports the following sound control features for analog input (microphone record input).

- Volume control
- Mute control

The built-in analog volume controller can be manipulated by an audio-class-specific request from +30 dB to –12 dB in 1-dB steps. The built-in mute controller can be manipulated by an audio-class-specific request. The only master mute control request is acceptable.

### Interface #1

Interface #1 is for audio streaming data-out interface. Interface #1 has the following three alternative settings. Alternative setting #0 is the zero bandwidth setting. All other alternative settings are operational settings.

| ALTERNATIVE SETTING | DATA FORMAT     |        |                     | TRANSFER MODE | SAMPLING RATE (kHz)                |
|---------------------|-----------------|--------|---------------------|---------------|------------------------------------|
| 00                  | Zero band width |        |                     |               |                                    |
| 01                  | 16 bit          | Stereo | 2s complement (PCM) | Adaptive      | 8, 11.025, 16, 22.05, 32, 44.1, 48 |
| 02                  | 16 bit          | Mono   | 2s complement (PCM) | Adaptive      | 8, 11.025, 16, 22.05, 32, 44.1, 48 |

### Interface #2

Interface #2 is for audio streaming data in interface. Interface #2 has the following two alternative settings. Alternative setting #0 is the Zero Band Width setting. Alternative setting #1 is an operational setting.

| ALTERNATIVE SETTING | DATA FORMAT     |      |                     | TRANSFER MODE | SAMPLING RATE (kHz)                |
|---------------------|-----------------|------|---------------------|---------------|------------------------------------|
| 00                  | Zero band width |      |                     |               |                                    |
| 01                  | 16 bit          | Mono | 2s complement (PCM) | Asynchronous  | 8, 11.025, 16, 22.05, 32, 44.1, 48 |

## Endpoints

The PCM2912 has three endpoints as follows.

- Control endpoint (EP #0)
- Isochronous-out audio data stream endpoint (EP #1)
- Isochronous-in audio data stream endpoint (EP #2)

The control endpoint is a default endpoint. The control endpoint is used to control all functions of the PCM2912 by the standard USB request and USB audio-class-specific request from the host. Isochronous-out audio data stream endpoint is an audio sink endpoint, which receives the PCM audio data. The isochronous-out audio data stream endpoint accepts the adaptive transfer mode. Isochronous-in audio data stream endpoint is an audio source endpoint, which transmits the PCM audio data. The isochronous-in audio data stream endpoint uses synchronous transfer mode.

## Internal Regulator

All required power sources are generated by five internal regulators.

Each regulator generates 3.3 V (typical, without load) from  $V_{BUS}$  (pin 2). Each regulator has an output pin and ground return pin as follows, and this pair must be decoupled with an appropriate capacitor. Note that this capacitance affects inrush-current limitation. One band-gap reference circuit supplies reference voltage for all regulators. BGND (pin 1) is provided for reference ground of the band-gap reference.

| SUPPLIED CIRCUIT | OUTPUT             | RETURN        |
|------------------|--------------------|---------------|
| Digital          | $V_{DD}$ (pin 5)   | DGND (pin 6)  |
| Analog           | $V_{CCA}$ (pin 15) | AGND (pin 13) |
| Headphone (L-ch) | $V_{CCL}$ (pin 19) | HGND (pin 20) |
| Headphone (R-ch) | $V_{CCR}$ (pin 21) | HGND (pin 20) |
| PLL              | $V_{CCP}$ (pin 26) | PGND (pin 25) |

## Clock and Reset

The PCM2912 requires a 6-MHz ( $\pm 500$  ppm) clock for USB function and audio function, which can be generated by a built-in crystal oscillator with a 6-MHz crystal resonator. The 6-MHz crystal resonator must be connected to XTI (pin 8) and XTO (pin 7) with one high (1-M $\Omega$ ) resistor and two small capacitors, whose capacitance depends on the load capacitance of the crystal resonator. An external clock can be supplied from XTI; if an external clock is supplied, XTO must be left open. Because there is no clock disabling signal, using the external clock supply is not recommended.  $\overline{SSPND}$  (pin 29) is unable to use clock disabling.

The PCM2912 has an internal power-on-reset circuit, which works automatically when  $V_{BUS}$  (pin 2) exceeds 2.5 V, typical (2.2 V–2.7 V), and approximately 700  $\mu$ s is required until the internal reset is released.

## DAC

The PCM2912 has the stereo delta-sigma DAC which uses a  $64\text{-}f_s$  oversampling technique with  $8\text{-}f_s$  oversampling digital filter. DAC outputs are provided through the headphone amplifier,  $V_{OUTL}$  (pin 18), and  $V_{OUTR}$  (pin 22) can provides 13 mW at 32  $\Omega$  and  $0.6 V_{CCL}/V_{CCR}$  V<sub>p-p</sub> at 10-k $\Omega$  load.

## ADC

The PCM2912 has the mono delta-sigma ADC which uses a  $64\text{-}f_s$  oversampling technique with  $1/64\text{-}f_s$  decimation digital filter. Microphone input,  $V_{IN}$  (pin 16), is fed to ADC through +20-dB microphone amplifier and PGA which has +30 dB to –12 dB in 1-dB steps.

## Microphone Bias

The PCM2912 has the microphone bias generator, which provides low-noise,  $0.75\text{-}V_{CCA}$ , 2-mA source current output with appropriate output impedance for electret-microphone driving. This output, MBIAS (pin 17) should be bypassed to AGND (pin 13) through an appropriate capacitor for reducing output noise level.

## Microphone Amplifier

The PCM2912 has the low-noise, single-ended mono microphone amplifier with mute function which is controlled by MUTE (pin 30). The signal gain is selectable by MAMP (pin 23). The noise level at input node is  $5 \mu\text{V}_{\text{rms}}$ , and the input impedance is  $20 \text{ k}\Omega$ .

## Input PGA

The PCM2912 has the low-noise input programmable gain amplifier (PGA) for the microphone amplifier output/ADC input, whose gain range is  $+30 \text{ dB}$  to  $-12 \text{ dB}$  in  $1 \text{ dB/step}$ .

## Sidetone Programmable Attenuator

The PCM2912 has the low-noise, sidetone programmable attenuator with mute function for the sidetone signal path (microphone amplifier output to output PGA input), whose gain range is  $0 \text{ dB}$  to  $-76 \text{ dB}$  in  $1 \text{ dB/step}$ .

## Output Programmable Attenuator

The PCM2912 has the low-noise output programmable attenuator with mute function for mixed signal, which affects DAC output signal and sidetone signal. The output PGA gain range is  $0 \text{ dB}$  to  $-76 \text{ dB}$  in  $1 \text{ dB/step}$ .

## $V_{\text{COM}1}$ and $V_{\text{COM}2}$

$V_{\text{COM}2}$  (pin 12) is provided for the center voltage of a headphone amplifier.  $V_{\text{COM}1}$  (pin 11) is provided for the center voltage of all other analog circuit. Each  $V_{\text{COM}}$  pin must be decoupled with an appropriate capacitor. Because the headphone output is disconnected when entering the suspend state, determining the capacitance is important to prevent the pop-noise, especially for the  $V_{\text{COM}2}$  (pin 12). The equivalent resistance of  $V_{\text{COM}2}$  is  $500 \text{ k}\Omega$ , and  $V_{\text{COM}1}$  is  $15 \text{ k}\Omega$ .

## Filter Pins

FL (pin 9) and FR (pin 10) are provided to make an LPF to decrease the DAC outband noise.

This is optional.

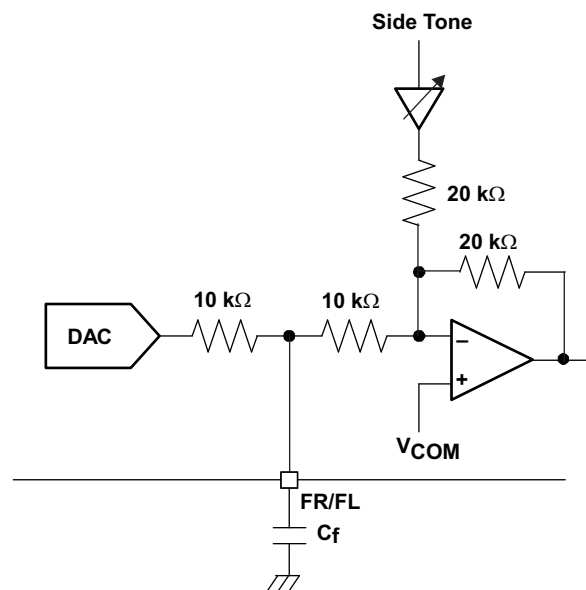

**Figure 32. Filter Circuit**

## INTERFACE SEQUENCE

### Power-On, Attach, and Play Back Sequence

The PCM2912 is ready for setup when the reset sequence has finished and the USB bus is attached. After a connection has been established by setup, the PCM2912 is ready to accept USB audio data. While awaiting the audio data (idle state), the analog output is set to bipolar zero (BPZ).

When receiving the audio data, the PCM2912 stores the first audio packet, which contained 1-ms audio data, into the internal storage buffer. The PCM2912 starts playing the audio data when detecting the following Start of Frame (SOF) packet.

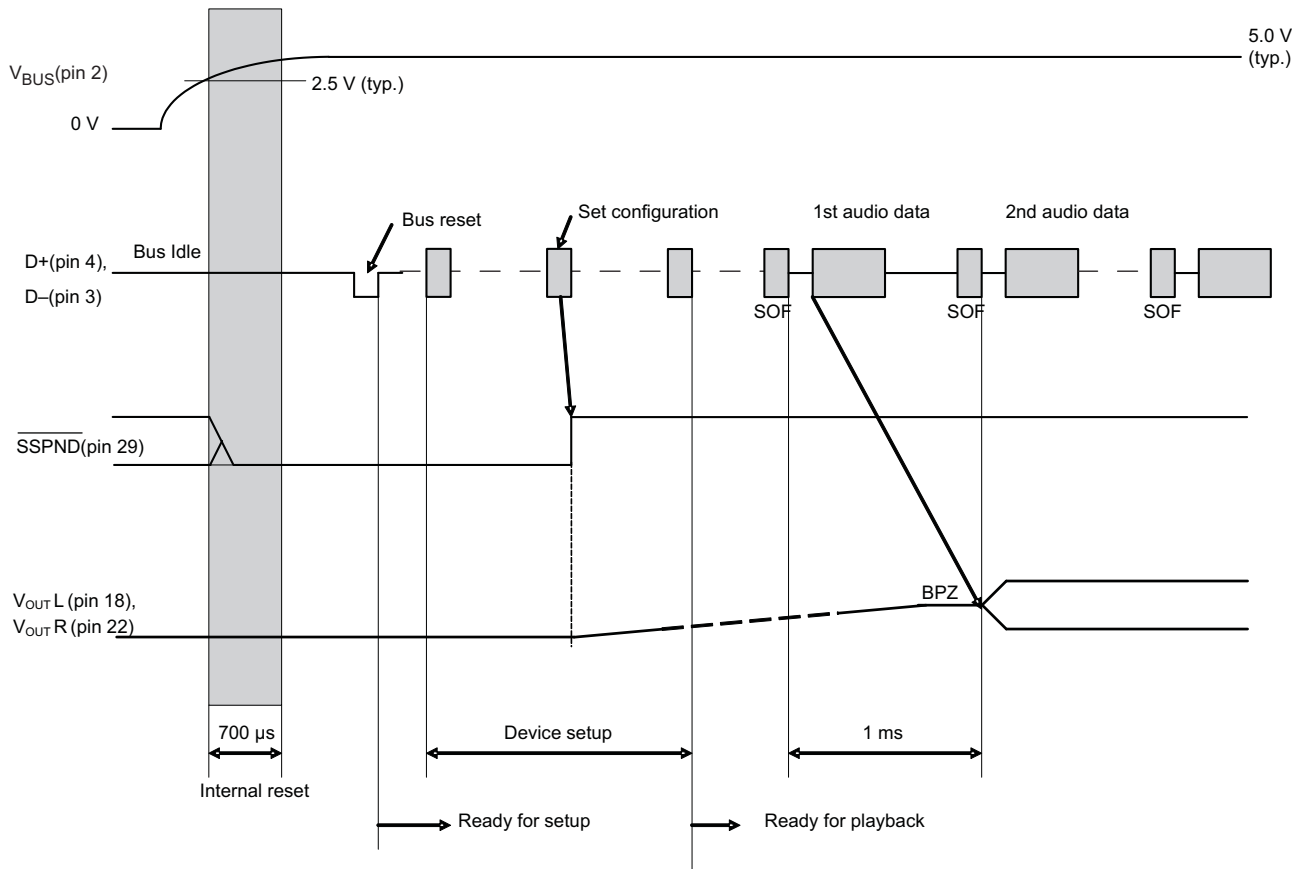

**Figure 33. Initial Sequence**

### Play Stop and Detach Sequence

When the host finishes or aborts the playing back, the PCM2912 stops the playing after last audio data has played.

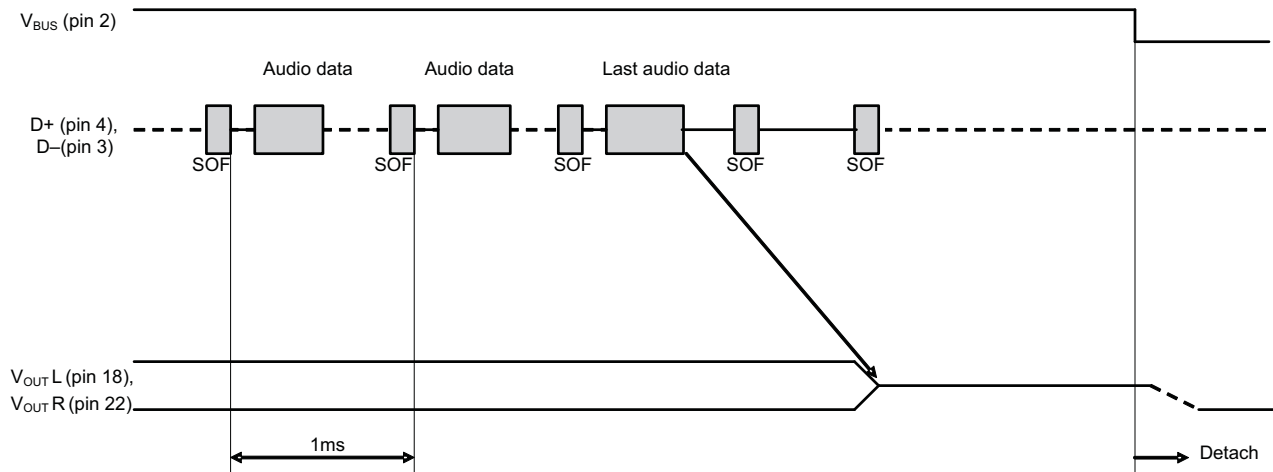

Figure 34. Play, Stop, and Detach

### Record Sequence

The PCM2912 starts the audio capture into the internal memory after receiving the SET\_INTERFACE command.

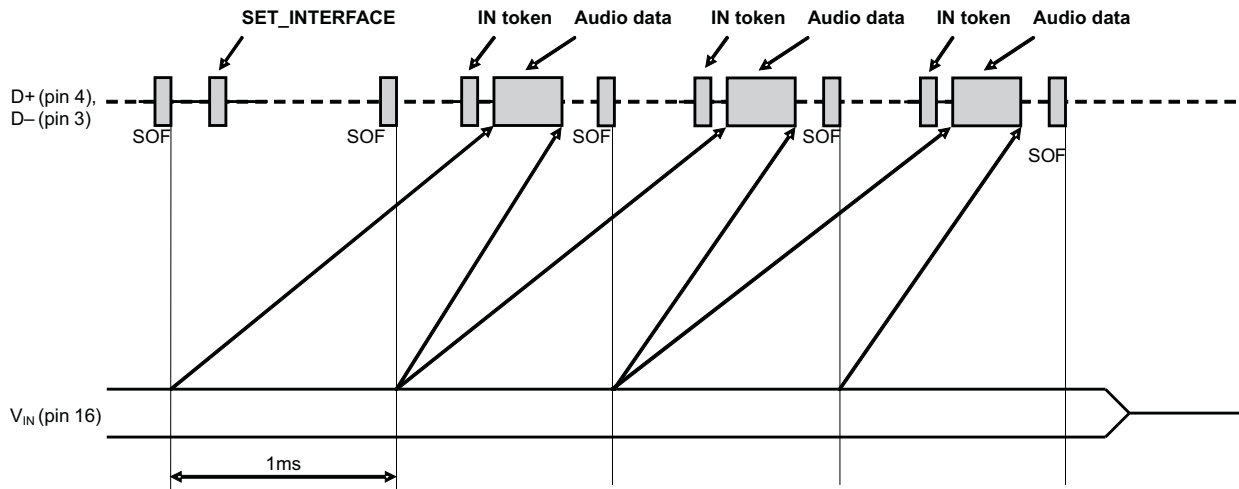
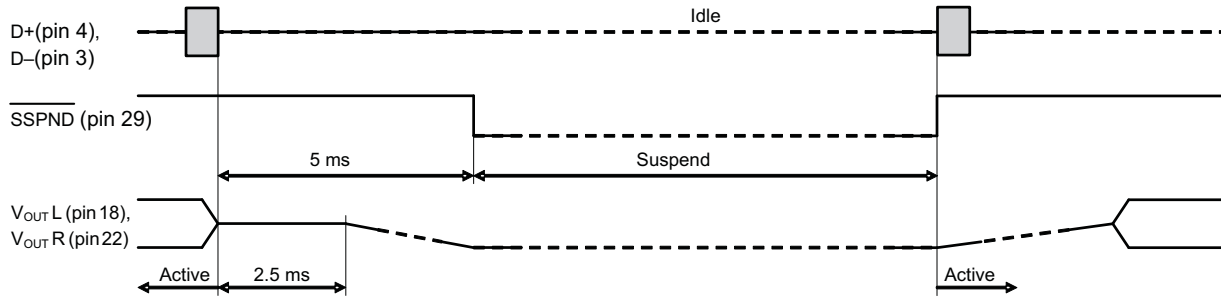

Figure 35. Record Sequence



### Suspend and Resume Sequence

The PCM2912 enters the suspend state after it sees a constant Idle state on the USB bus after approximately 5 ms. When the PCM2912 enters the suspend state,  $\overline{\text{SSPND}}$  flag (pin 29) is asserted. The PCM2912 wakes up immediately when detecting the non-idle state on the USB bus.



**Figure 36. Suspend and Resume**

## TYPICAL CIRCUIT CONNECTION

A bus-powered (Hi-power), +20-dB microphone amplifier application example follows.

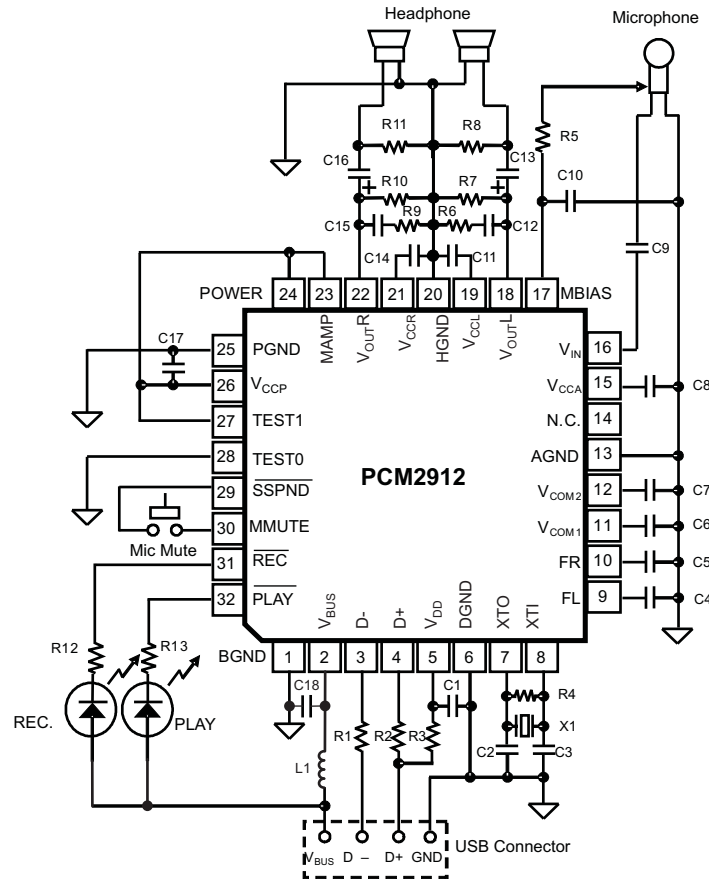

NOTE: X<sub>1</sub>: 6-MHz crystal resonator

C<sub>1</sub>, C<sub>8</sub>, C<sub>11</sub>, C<sub>14</sub>, C<sub>17</sub>, C<sub>18</sub>: 1  $\mu$ F ceramic

C<sub>2</sub>, C<sub>3</sub>: 10 pF to 33 pF (depending on load capacitance of crystal resonator)

C<sub>4</sub>, C<sub>5</sub>: 100 pF ceramic

C<sub>6</sub>, C<sub>10</sub>: 3.3  $\mu$ F

C<sub>7</sub>: 0.1  $\mu$ F

C<sub>9</sub>: 0.22  $\mu$ F electrolytic (depending on required frequency response for microphone input)

C<sub>12</sub>, C<sub>15</sub>: 0.022  $\mu$ F ceramic

C<sub>13</sub>, C<sub>16</sub>: 100  $\mu$ F electrolytic (depending on required frequency response for headphone output)

R<sub>1</sub>, R<sub>2</sub>: 22  $\Omega$  to 33  $\Omega$

R<sub>3</sub>: 1.5 k $\Omega$

R<sub>4</sub>: 1 M $\Omega$

R<sub>5</sub>: 1 k $\Omega$  (depending on microphone characteristic)

R<sub>6</sub>, R<sub>9</sub>: 16  $\Omega$

R<sub>7</sub>, R<sub>8</sub>, R<sub>10</sub>, R<sub>11</sub>: 3.3 k $\Omega$

R<sub>12</sub>, R<sub>13</sub>: 820  $\Omega$  (depending on LED drive current)

L<sub>1</sub>: 1  $\mu$ H (DC resistance <0.6  $\Omega$ )

It is possible to change maximum power, if total power of actual application does not require over 100 mA (POWER = Low to configure as low-power device).

**Figure 37. USB Headset Application**

### NOTE:

The preceding circuit is for information only. Total board design should be considered in order to meet the USB specification as a USB-compliant product.

### **Related Documentation from Texas Instruments**

For additional information concerning the PCM2912 device, see TI application report *Operating Environments for PCM2912 Applications* ([SLAA387](#)).

**PACKAGING INFORMATION**

| Orderable Device | Status<br>(1) | Package Type | Package Drawing | Pins | Package Qty | Eco Plan<br>(2) | Lead finish/<br>Ball material<br>(6) | MSL Peak Temp<br>(3) | Op Temp (°C) | Device Marking<br>(4/5) | Samples |
|------------------|---------------|--------------|-----------------|------|-------------|-----------------|--------------------------------------|----------------------|--------------|-------------------------|---------|
| PCM2912PJT       | NRND          | TQFP         | PJT             | 32   | 250         | RoHS & Green    | NIPDAU                               | Level-1-260C-UNLIM   | -25 to 85    | PCM2912                 |         |
| PCM2912PJTG4     | NRND          | TQFP         | PJT             | 32   | 250         | RoHS & Green    | NIPDAU                               | Level-1-260C-UNLIM   | -25 to 85    | PCM2912                 |         |
| PCM2912PJTR      | NRND          | TQFP         | PJT             | 32   | 1000        | RoHS & Green    | NIPDAU                               | Level-1-260C-UNLIM   | -25 to 85    | PCM2912                 |         |

(1) The marketing status values are defined as follows:

**ACTIVE:** Product device recommended for new designs.

**LIFEBUY:** TI has announced that the device will be discontinued, and a lifetime-buy period is in effect.

**NRND:** Not recommended for new designs. Device is in production to support existing customers, but TI does not recommend using this part in a new design.

**PREVIEW:** Device has been announced but is not in production. Samples may or may not be available.

**OBSELETE:** TI has discontinued the production of the device.

(2) **RoHS:** TI defines "RoHS" to mean semiconductor products that are compliant with the current EU RoHS requirements for all 10 RoHS substances, including the requirement that RoHS substance do not exceed 0.1% by weight in homogeneous materials. Where designed to be soldered at high temperatures, "RoHS" products are suitable for use in specified lead-free processes. TI may reference these types of products as "Pb-Free".

**RoHS Exempt:** TI defines "RoHS Exempt" to mean products that contain lead but are compliant with EU RoHS pursuant to a specific EU RoHS exemption.

**Green:** TI defines "Green" to mean the content of Chlorine (Cl) and Bromine (Br) based flame retardants meet JS709B low halogen requirements of <=1000ppm threshold. Antimony trioxide based flame retardants must also meet the <=1000ppm threshold requirement.

(3) MSL, Peak Temp. - The Moisture Sensitivity Level rating according to the JEDEC industry standard classifications, and peak solder temperature.

(4) There may be additional marking, which relates to the logo, the lot trace code information, or the environmental category on the device.

(5) Multiple Device Markings will be inside parentheses. Only one Device Marking contained in parentheses and separated by a "~" will appear on a device. If a line is indented then it is a continuation of the previous line and the two combined represent the entire Device Marking for that device.

(6) Lead finish/Ball material - Orderable Devices may have multiple material finish options. Finish options are separated by a vertical ruled line. Lead finish/Ball material values may wrap to two lines if the finish value exceeds the maximum column width.

**Important Information and Disclaimer:**The information provided on this page represents TI's knowledge and belief as of the date that it is provided. TI bases its knowledge and belief on information provided by third parties, and makes no representation or warranty as to the accuracy of such information. Efforts are underway to better integrate information from third parties. TI has taken and continues to take reasonable steps to provide representative and accurate information but may not have conducted destructive testing or chemical analysis on incoming materials and chemicals. TI and TI suppliers consider certain information to be proprietary, and thus CAS numbers and other limited information may not be available for release.

In no event shall TI's liability arising out of such information exceed the total purchase price of the TI part(s) at issue in this document sold by TI to Customer on an annual basis.



PJT (S-PQFP-N32)

PLASTIC QUAD FLATPACK

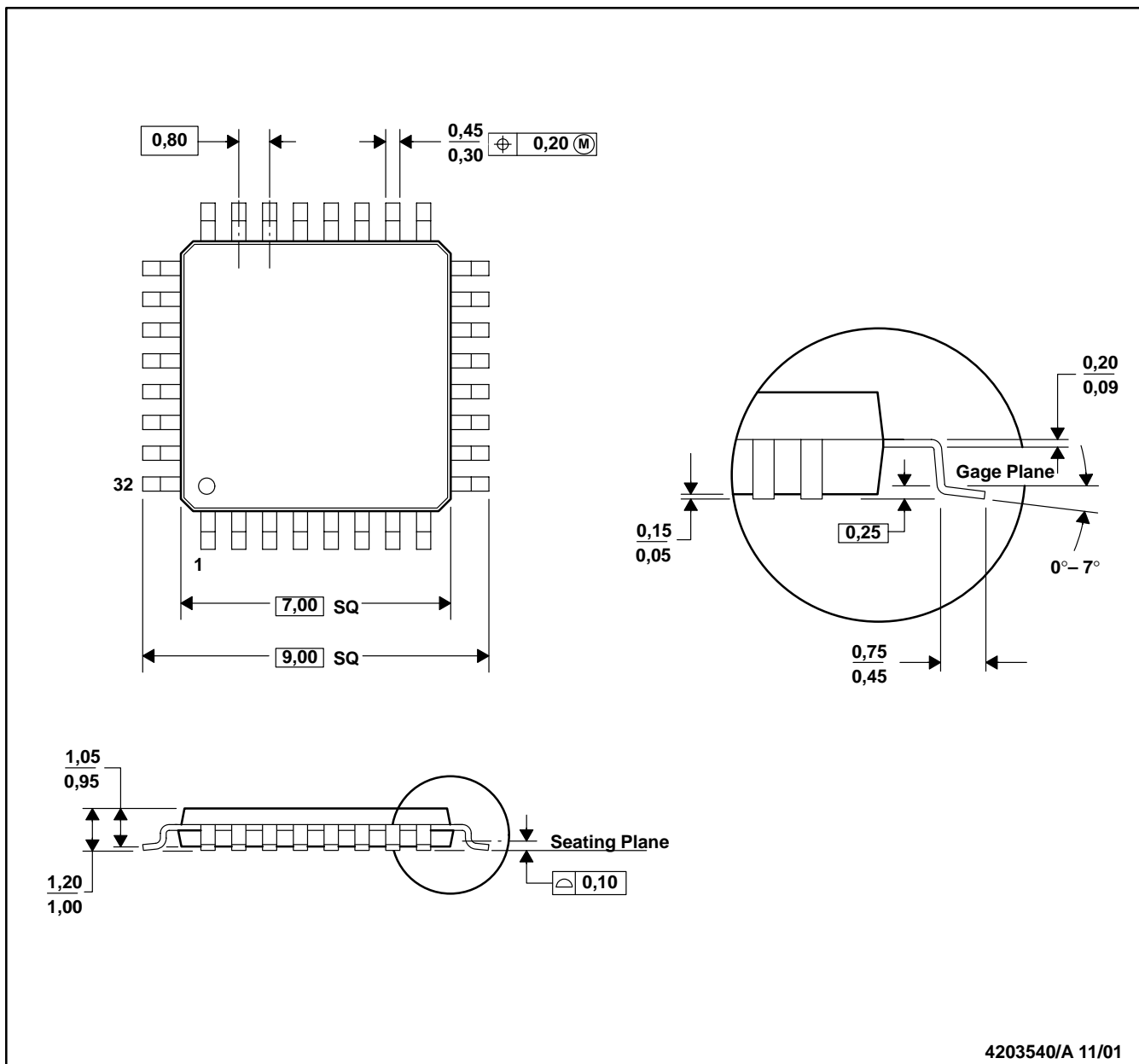

- NOTES: A. All linear dimensions are in millimeters.  
 B. This drawing is subject to change without notice.  
 C. Falls within JEDEC MS-026

## IMPORTANT NOTICE AND DISCLAIMER

TI PROVIDES TECHNICAL AND RELIABILITY DATA (INCLUDING DATA SHEETS), DESIGN RESOURCES (INCLUDING REFERENCE DESIGNS), APPLICATION OR OTHER DESIGN ADVICE, WEB TOOLS, SAFETY INFORMATION, AND OTHER RESOURCES "AS IS" AND WITH ALL FAULTS, AND DISCLAIMS ALL WARRANTIES, EXPRESS AND IMPLIED, INCLUDING WITHOUT LIMITATION ANY IMPLIED WARRANTIES OF MERCHANTABILITY, FITNESS FOR A PARTICULAR PURPOSE OR NON-INFRINGEMENT OF THIRD PARTY INTELLECTUAL PROPERTY RIGHTS.

These resources are intended for skilled developers designing with TI products. You are solely responsible for (1) selecting the appropriate TI products for your application, (2) designing, validating and testing your application, and (3) ensuring your application meets applicable standards, and any other safety, security, regulatory or other requirements.

These resources are subject to change without notice. TI grants you permission to use these resources only for development of an application that uses the TI products described in the resource. Other reproduction and display of these resources is prohibited. No license is granted to any other TI intellectual property right or to any third party intellectual property right. TI disclaims responsibility for, and you will fully indemnify TI and its representatives against, any claims, damages, costs, losses, and liabilities arising out of your use of these resources.

TI's products are provided subject to [TI's Terms of Sale](#) or other applicable terms available either on [ti.com](#) or provided in conjunction with such TI products. TI's provision of these resources does not expand or otherwise alter TI's applicable warranties or warranty disclaimers for TI products.

TI objects to and rejects any additional or different terms you may have proposed.

Mailing Address: Texas Instruments, Post Office Box 655303, Dallas, Texas 75265  
Copyright © 2021, Texas Instruments Incorporated