



NOMINAL SIZE = 1.5 in x 0.87 in (38,1 mm x 22,1 mm)

Features

- Up to 22-A Output Current
- 3.3-V Input Voltage
- Wide-Output Voltage Adjust (0.8 V to 2.5 V)
- Efficiencies up to 93 %
- 120 W/in³ Power Density
- On/Off Inhibit
- Output Voltage Sense
- Pre-Bias Startup
- Margin Up/Down Controls
- Under-Voltage Lockout
- Auto-Track™ Sequencing
- Output Over-Current Protection (Non-Latching, Auto-Reset)
- Over-Temperature Protection
- Operating Temp: -40 to +85 °C
- IPC Lead Free 2
- Safety Agency Approvals: UL 1950, CSA 22.2 950, EN60950 VDE (Pending)
- Point-of-load Alliance (POLA) Compatible

Description

The PTH03020 series of non-isolated power modules offers OEM designers a combination of high performance, small footprint, and industry leading features. As part of a new class of power modules these products provide designers with the flexibility to power the most complex multi-processor digital systems using off-the-shelf catalog parts.

The series employs double-sided surface mount construction and provides high-performance step-down power conversion for up to 22 A of output current from a 3.3-V input bus voltage. The output voltage of the PTH03020W can be set to any value over the range, 0.8 V to 2.5 V, using a single resistor.

This series includes Auto-Track™. Auto-Track simplifies the task of supply voltage sequencing in a power system by enabling modules to track each other, or any external voltage, during power up and power down.

Other operating features include an on/off inhibit, output voltage adjust (trim), and margin up/down controls. To ensure tight load regulation, an output voltage sense is also provided. A non-latching over-current trip and over-temperature shutdown provide load fault protection.

Target applications include complex multi-voltage, multi-processor systems that incorporate the industry's high-speed DSPs, micro-processors and bus drivers.

Pin Configuration

Pin	Function
1	GND
2	V _{in}
3	Inhibit*
4	V _o Adjust
5	V _o Sense
6	V _{out}
7	GND
8	Track
9	Margin Down*
10	Margin Up*

* Denotes negative logic:
 Open = Normal operation
 Ground = Function active



Standard Application

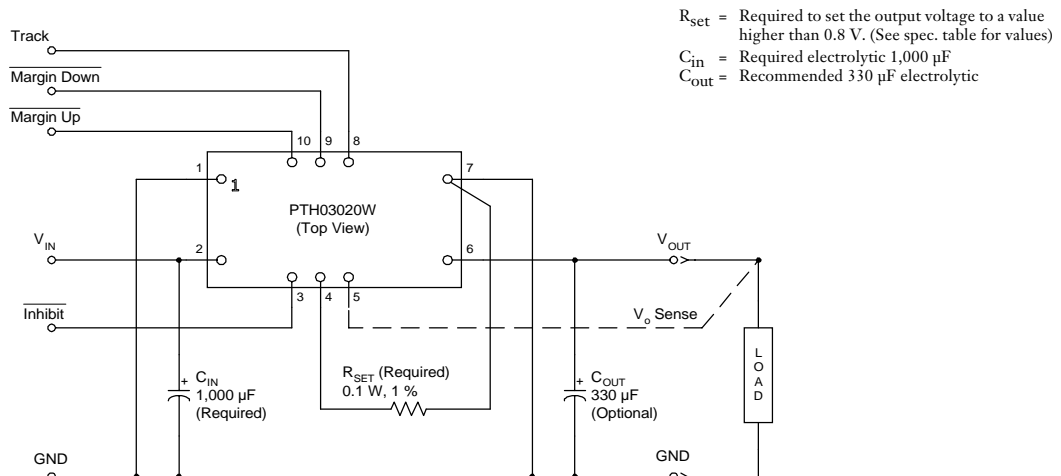

Ordering Information

Output Voltage (PTH03020□□xx)		Package Options (PTH03020x□□) ⁽¹⁾		
Code	Voltage	Code	Description	Pkg Ref. ⁽²⁾
W	0.8 V – 2.5 V (Adjust)	AH	Horiz. T/H	(EUK)
		AS	SMD, Standard ⁽³⁾	(EUL)

- Notes:** (1) Add “T” to end of part number for tape and reel on SMD packages only.
 (2) Reference the applicable package reference drawing for the dimensions and PC board layout
 (3) “Standard” option specifies 63/37, Sn/Pb pin solder material.

Pin Descriptions

Vin: The positive input voltage power node to the module, which is referenced to common *GND*.

Vout: The regulated positive power output with respect to the *GND* node.

GND: This is the common ground connection for the *Vin* and *Vout* power connections. It is also the 0 VDC reference for the control inputs.

Inhibit: The Inhibit pin is an open-collector/drain negative logic input that is referenced to *GND*. Applying a low-level ground signal to this input disables the module’s output and turns off the output voltage. When the *Inhibit* control is active, the input current drawn by the regulator is significantly reduced. If the *Inhibit* pin is left open-circuit, the module will produce an output whenever a valid input source is applied.

Vo Adjust: A 0.1 W, 1 % tolerance (or better) resistor must be connected between this pin and the *GND* pin to set the output voltage to the desired value. The set point range for the output voltage is from 0.8 V to 2.5 V. The resistor required for a given output voltage may be calculated from the following formula. If left open circuit, the module output will default to its lowest output voltage value. For further information on the adjustment of the output voltage consult the related application note.

$$R_{set} = 10\text{ k} \cdot \frac{0.8\text{ V}}{V_{out} - 0.8\text{ V}} - 2.49\text{ k}$$

The specification table gives the preferred resistor values for a number of standard output voltages.

Vo Sense: The sense input allows the regulation circuit to compensate for voltage drop between the module and the load. For optimal voltage accuracy *Vo Sense* should be connected to *Vout*. It can also be left disconnected.

Track: This is an analog control input that enables the output voltage to follow an external voltage. This pin becomes active typically 20 ms after the input voltage has been applied, and allows direct control of the output voltage from 0 V up to the nominal set-point voltage. Within this range the output will follow the voltage at the *Track* pin on a volt-for-volt basis. When the control voltage is raised above this range, the module regulates at its set-point voltage. The feature allows the output voltage to rise simultaneously with other modules powered from the same input bus. If unused, the input should be connected to *Vin*. *Note: Due to the under-voltage lockout feature, the output of the module cannot follow its own input voltage during power up. For more information, consult the related application note.*

Margin Down: When this input is asserted to *GND*, the output voltage is decreased by 5% from the nominal. The input requires an open-collector (open-drain) interface. It is not TTL compatible. A lower percent change can be accommodated with a series resistor. If unused, this input may be left unconnected. For further information, consult the related application note.

Margin Up: When this input is asserted to *GND*, the output voltage is increased by 5%. The input requires an open-collector (open-drain) interface. It is not TTL compatible. The percent change can be reduced with a series resistor. If unused, this input may be left unconnected. For further information, consult the related application note.

Environmental & Absolute Maximum Ratings (Voltages are with respect to GND)

Characteristics	Symbols	Conditions	Min	Typ	Max	Units
Track Input Voltage	V_{track}		-0.3	—	$V_{in} + 0.3$	V
Operating Temperature Range	T_a	Over V_{in} Range	-40	—	85	°C
Solder Reflow Temperature	T_{reflow}	Surface temperature of module body or pins			235 (i)	°C
Storage Temperature	T_s	—	-40	—	125	°C
Mechanical Shock		Per Mil-STD-883D, Method 2002.3 1 msec, ½ Sine, mounted	—	500	—	G's
Mechanical Vibration		Mil-STD-883D, Method 2007.2 20-2000 Hz	Suffix H Suffix S	20 10	—	G's
Weight	—		—	5	—	grams
Flammability	—	Meets UL 94V-O				

Notes: (i) During reflow of SMD package version do not elevate peak temperature of the module, pins or internal components above the stated maximum.

Specifications (Unless otherwise stated, $T_a = 25$ °C, $V_{in} = 3.3$ V, $V_{out} = 2$ V, $C_{in} = 1,000$ μ F, $C_{out} = 0$ μ F, and $I_o = I_o(max)$)

Characteristics	Symbols	Conditions	PTH03020W			Units
			Min	Typ	Max	
Output Current	I_o	60 °C, 200 LFM airflow 25 °C, natural convection	0 0	—	22 (1) 22 (1)	A
Input Voltage Range	V_{in}	Over I_o range	2.95 (2)	—	3.65	V
Set-Point Voltage Tolerance	$V_o tol$		—	—	± 2 (3)	% V_o
Temperature Variation	ΔReg_{temp}	-40 °C < T_a < +85 °C	—	± 0.5	—	% V_o
Line Regulation	ΔReg_{line}	Over V_{in} range	—	± 5	—	mV
Load Regulation	ΔReg_{load}	Over I_o range	—	± 5	—	mV
Total Output Variation	ΔReg_{tot}	Includes set-point, line, load, -40 °C $\leq T_a \leq$ +85 °C	—	—	± 3 (3)	% V_o
Efficiency	η	$I_o = 10$ A				%
		$R_{SET} = 2.21$ k Ω $V_o = 2.5$ V	—	95	—	
		$R_{SET} = 4.12$ k Ω $V_o = 2.0$ V	—	94	—	
		$R_{SET} = 5.49$ k Ω $V_o = 1.8$ V	—	93	—	
		$R_{SET} = 8.87$ k Ω $V_o = 1.5$ V	—	91	—	
		$R_{SET} = 17.4$ k Ω $V_o = 1.2$ V	—	90	—	
		$R_{SET} = 36.5$ k Ω $V_o = 1.0$ V	—	88	—	
V_o Ripple (pk-pk)	V_r	20 MHz bandwidth	—	20	—	mVpp
Over-Current Threshold	I_o trip	Reset, followed by auto-recovery	—	41	—	A
Transient Response		1 A/ μ s load step, 50 to 100 % $I_o(max)$, $C_{out} = 330$ μ F				
	t_{tr}	Recovery Time	—	50	—	μ Sec
	ΔV_{tr}	V_o over/undershoot	—	100	—	mV
Margin Up/Down Adjust	$V_o adj$		—	± 5	—	%
Margin Input Current (pins 9/10)	$I_{IL margin}$	Pin to GND	—	-8 (4)	—	μ A
Track Input Current (pin 8)	$I_{IL track}$	Pin to GND	—	—	-130 (5)	μ A
Track Slew Rate Capability	dV_{track}/dt	$C_{out} \leq C_{out(max)}$	—	—	1	V/ms
Under-Voltage Lockout	UVLO	V_{in} increasing V_{in} decreasing	— 2.2	2.8 2.7	2.95 —	V
Inhibit Control (pin3)		Referenced to GND				
Input High Voltage	V_{IH}		$V_{in} - 0.5$	—	Open (5)	V
Input Low Voltage	V_{IL}		-0.2	—	0.8	
Input Low Current	$I_{IL inhibit}$	Pin to GND	—	-130	—	μ A
Input Standby Current	$I_{in inh}$	Inhibit (pin 3) to GND, Track (pin 8) open	—	10	—	mA
Switching Frequency	f_s	Over V_{in} and I_o ranges	250	300	340	kHz
External Input Capacitance	C_{in}		1,000 (6)	—	—	μ F
External Output Capacitance	C_{out}	Capacitance value	0	330 (7)	11,000 (8)	μ F
		non-ceramic	0	—	300	
		ceramic	—	—	—	
		Equiv. series resistance (non-ceramic)	4 (9)	—	—	m Ω
Reliability	MTBF	Per Bellcore TR-332 50 % stress, $T_a = 40$ °C, ground benign	4.9	—	—	10 ⁶ Hrs

- Notes:** (1) See SOA curves or consult factory for appropriate derating.
 (2) The minimum input voltage is equal to 2.95 V or $V_{out} + 0.5$ V, whichever is greater.
 (3) The set-point voltage tolerance is affected by the tolerance and stability of R_{SET} . The stated limit is unconditionally met if R_{SET} has a tolerance of 1 % with 100 ppm/°C or better temperature stability.
 (4) A small low-leakage (<100 nA) MOSFET is recommended to control this pin. The open-circuit voltage is less than 1 Vdc.
 (5) This control pin has an internal pull-up to the input voltage V_{in} . If it is left open-circuit the module will operate when input power is applied. A small low-leakage (<100 nA) MOSFET is recommended for control. For further information, consult the related application note.
 (6) A 1,000 μ F electrolytic input capacitor is required for proper operation. The capacitor must be rated for a minimum of 700 mA Arms of ripple current.
 (7) An external output capacitor is not required for basic operation. Adding 330 μ F of distributed capacitance at the load will improve the transient response.
 (8) This is the calculated maximum. The minimum ESR limitation will often result in a lower value. Consult the application notes for further guidance.
 (9) This is the typical ESR for all the electrolytic (non-ceramic) output capacitance. Use 7 m Ω as the minimum when using max-ESR values to calculate.

Characteristic Data; $V_{in} = 3.3V$ (See Note A)

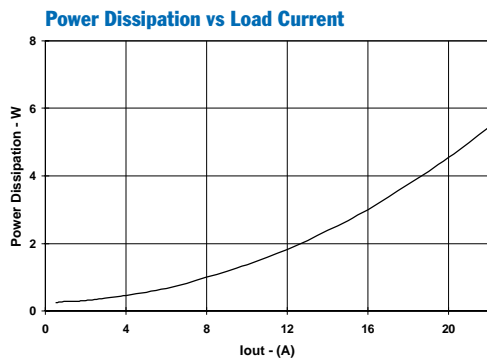
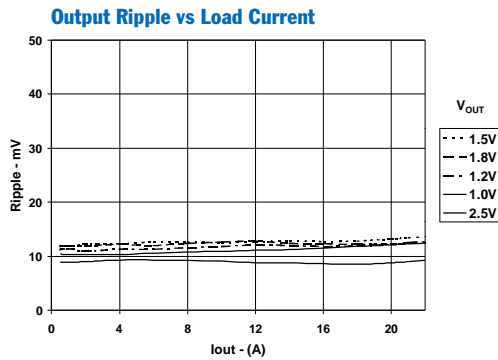
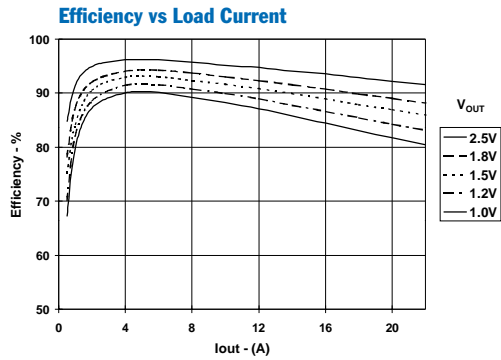

Safe Operating Area; $V_{in} = 3.3V$ (See Note B)

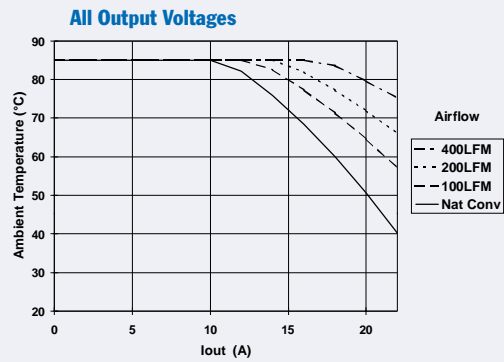

Note A: Characteristic data has been developed from actual products tested at 25°C. This data is considered typical data for the converter.

Note B: SOA curves represent the conditions at which internal components are at or below the manufacturer's maximum operating temperatures. Derating limits apply to modules soldered directly to a 4 in. × 4 in. double-sided PCB with 1 oz. copper.

Capacitor Recommendations for the PTH03020 & PTH05020 Series of Power Modules

Input Capacitor

The recommended input capacitor(s) is determined by the 1,000 μF (1) minimum capacitance and 700 mA rms minimum ripple current rating.

Ripple current and $<100\text{ m}\Omega$ equivalent series resistance (ESR) values are the major considerations, along with temperature, when designing with different types of capacitors. Unlike polymer tantalum, conventional tantalum capacitors have a recommended minimum voltage rating of $2 \times$ (maximum DC voltage + AC ripple). This is standard practice to insure reliability.

For improved ripple reduction on the input bus, ceramic capacitors may be substituted for electrolytic types using the minimum required capacitance.

Output Capacitors (Optional)

For applications with load transients (sudden changes in load current), regulator response will benefit from an external output capacitance. The recommended output capacitance of 330 μF will allow the module to meet its transient response specification (see product data sheet). For most applications, a high quality computer-grade aluminum electrolytic capacitor is most suitable. These capacitors provide adequate decoupling over the frequency range, 2 kHz to 150 kHz, and are suitable when ambient temperatures are above 0 °C. For operation below 0 °C, tantalum, ceramic or Os-Con type capacitors are recommended. When using one or more non-ceramic capacitors, the calculated equivalent ESR should be no lower than 4 m Ω (7 m Ω using the manufacturer's maximum ESR for a single capacitor). A list of preferred low-ESR type capacitors are identified in Table 2-1.

Ceramic Capacitors

Above 150 kHz the performance of aluminum electrolytic capacitors becomes less effective. To further improve the reflected input ripple current or the output transient response, multilayer ceramic capacitors can also be added. Ceramic capacitors have very low ESR and their resonant frequency is higher than the bandwidth of the regulator. When used on the output their combined ESR is not critical as long as the total value of ceramic capacitance does not exceed 300 μF . Also, to prevent the formation of local resonances, do not place more than five identical ceramic capacitors in parallel with values of 10 μF or greater.

Tantalum Capacitors

Tantalum type capacitors can be used at both the input and output, and are recommended for applications where the ambient operating temperature can be less than 0 °C. The AVX TPS, Sprague 593D/594/595 and Kemet T495/T510 capacitor series are suggested over many other tantalum types due to their higher rated surge, power

dissipation, and ripple current capability. As a caution many general purpose tantalum capacitors have considerably higher ESR, reduced power dissipation and lower ripple current capability. These capacitors are also less reliable when determining their power dissipation and surge current capability. Tantalum capacitors that do not have a stated ESR or surge current rating are not recommended for power applications.

When specifying Os-Con and polymer tantalum capacitors for the output, the minimum ESR limit will be encountered well before the maximum capacitance value is reached.

Capacitor Table

Table 2-1 identifies the characteristics of capacitors from a number of vendors with acceptable ESR and ripple current (rms) ratings. The recommended number of capacitors required at both the input and output buses is identified for each capacitor type.

This is not an extensive capacitor list. Capacitors from other vendors are available with comparable specifications. Those listed are for guidance. The RMS ripple current rating and ESR (at 100kHz) are critical parameters necessary to insure both optimum regulator performance and long capacitor life.

Designing for Very Fast Load Transients

The transient response of the DC/DC converter has been characterized using a load transient with a di/dt of 1 A/ μs . The typical voltage deviation for this load transient is given in the data sheet specification table using the optional value of output capacitance. As the di/dt of a transient is increased, the response of a converter's regulation circuit ultimately depends on its output capacitor decoupling network. This is an inherent limitation with any DC/DC converter once the speed of the transient exceeds its bandwidth capability. If the target application specifies a higher di/dt or lower voltage deviation, the requirement can only be met with additional output capacitor decoupling. In these cases special attention must be paid to the type, value and ESR of the capacitors selected.

If the transient performance requirements exceed that specified in the data sheet, or the total amount of load capacitance is above 3,000 μF , the selection of output capacitors becomes more important. For further guidance consult the separate application note, "Selecting Output Capacitors for PTH Products in High-Performance Applications."

Table 2-1: Input/Output Capacitors

Capacitor Vendor, Type Series (Style)	Capacitor Characteristics					Quantity		Vendor Part Number
	Working Voltage	Value(μF)	Max. ESR at 100 kHz	105°C Maximum Ripple Current (Irms)	Physical Size (mm)	Input Bus	Output Bus	
Panasonic, Aluminum: FC (Radial)	10 V	560	0.090 Ω	755 mA	10×12.5	2	1	EEUFC1A561
FK (SMD)	10 V	1000	0.068 Ω	1050 mA	10×16	1	1	EEUFC1A102
	25 V	1000	0.060 Ω	1100 mA	12.5×13.5	1	1	EEVFK1E102Q
	10 V	1000	0.080 Ω	850 mA	10×10.2	1	1	EEVFK1A102P
United Chemi-con: PXA, Poly-Aluminum (SMD)	6.3 V	470	0.020 Ω	4130 mA	10×7.7	2 (1)	≤3	PXA6.3VC471MJ80TP
FX, Os-con (Radial)	6.3 V	1000	0.013 Ω	4935 mA	10×10.5	1	≤2	6FX1000M
	10 V	680	0.090 Ω	760 mA	10×12.5	2	1	LXZ10VB681M10X12LL
	10 V	1000	0.068 Ω	1050 mA	10×16	1	1	LXZ10VB102M10X16LL
Nichicon, Aluminum: HD (Radial)	6.3 V	1000	0.053 Ω	1030 mA	10×12.5	1	1	UHD0J102MPR
PM (Radial)	10 V	1000	0.065 Ω	1060 mA	16×15	1	1	UPM1A102MPH6
Sanyo, Os-con: SP (Radial)	10 V	470	0.015 Ω	>4500 mA	10×10.5	2 (1)	≤3	10SP470M
SVP (SMD)	10 V	560	0.013 Ω	>5200 mA	10×12.7	2	≤2	10SVP560M
Panasonic, Poly-Aluminum: WA (SMD)	10 V	470	0.017 Ω	4500 mA	10×10.2	2 (1)	≤3	EEFWA1A471P
S/SE (SMD)	6.3 V	180	0.005 Ω	4000 mA	7.3×4.3×4.2	6	≤1	EEFSE0J181R
AVX, Tantalum: TPS (SMD)	10 V	470	0.045 Ω	1723 mA	7.3L	2 (1)	≤5	TPSE477M010R0045
T520, Poly-Tant	10 V	470	0.060 Ω	1826 mA	×5.7W×4.1H	2 (1)	≤5	TPSV477M010R0060
T530, Poly-Tant/Organic	10 V	330	0.040 Ω	1800 mA	4.3W	3	≤5	T520X337M010AS
	10 V	330	0.015 Ω	>3800 mA	×7.3L	3	≤3	T530X337M010AS
	6.3 V	470	0.012 Ω	4200 mA	×4.0H	2 (1)	≤2	T530X477M006AS
Vishay-Sprague 595D, Tantalum (SMD)	10 V	470	0.100 Ω	1440 mA	7.2L×6W	2 (1)	≤5	595D477X0010R2T
94SA, Os-con (Radial)	16 V	1000	0.015 Ω	9740 mA	×4.1H	1	≤3	94SA108X0016HBP
					16×25			
Kemet, Ceramic X5R (SMD)	16 V	10	0.002 Ω	—	1210 case	1	≤5	C1210C106M4PAC
	6.3 V	47	0.002 Ω	—	3225 mm	1	≤5	C1210C476K9PAC
Murata, Ceramic X5R (SMD)	6.3 V	100	0.002 Ω	—	1210 case	1	≤3	GRM32ER60J107M
	6.3 V	47	—	—	3225 mm	1	≤5	GRM32ER60J476M
	16 V	22	—	—		1	≤5	GRM32ER61C226K
	16 V	10	—	—		1	≤5	GRM32DR61C106K
TDK, Ceramic X5R (SMD)	6.3 V	100	0.002 Ω	—	1210 case	1	≤3	C3225X5R0J107MT
	6.3 V	47	—	—	3225 mm	1	≤5	C3225X5R0J476MT
	16 V	22	—	—		1	≤5	C3225X5R1C226MT
	16 V	10	—	—		1	≤5	C3225X5R1C106MT

(1) Total capacitance of 940 μF is acceptable based on the combined ripple current rating.

Adjusting the Output Voltage of the PTH03020W & PTH05020W Wide-Output Adjust Power Modules

The $V_o Adjust$ control (pin 4) sets the output voltage of the PTH03020W and PTH05020W products. The adjustment range of the PTH03020W (3.3-V input) is from 0.8 V to 2.5 V¹, and the PTH05020W (5-V input) from 0.8 V to 3.6 V. The adjustment method requires the addition of a single external resistor, R_{set} , that must be connected directly between the $V_o Adjust$ and GND pins². Table 1-1 gives the preferred value of the external resistor for a number of standard voltages, along with the actual output voltage that this resistance value provides.

For other output voltages the value of the required resistor can either be calculated using the following formula, or simply selected from the range of values given in Table 1-2. Figure 1-1 shows the placement of the required resistor.

$$R_{set} = 10 \text{ k}\Omega \cdot \frac{0.8 \text{ V}}{V_{out} - 0.8 \text{ V}} - 2.49 \text{ k}\Omega$$

Table 1-1; Preferred Values of R_{set} for Standard Output Voltages

V_{out} (Standard)	R_{set} (Pref'd Value)	V_{out} (Actual)
3.3 V ²	698 Ω	3.309V
2.5 V	2.21 k Ω	2.502 V
2 V	4.12 k Ω	2.010 V
1.8 V	5.49 k Ω	1.803 V
1.5 V	8.87 k Ω	1.504 V
1.2 V	17.4 k Ω	1.202 V
1 V	36.5 k Ω	1.005 V
0.8 V	Open	0.8 V

Figure 1-1; $V_o Adjust$ Resistor Placement

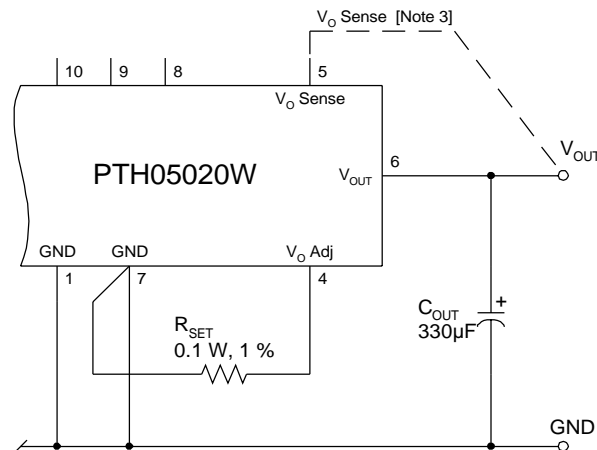

Table 1-2; Output Voltage Set-Point Resistor Values

V_a Req'd	R_{set}	V_a Req'd	R_{set}
0.800	Open	2.00	4.18 k Ω
0.825	318 k Ω	2.05	3.91 k Ω
0.850	158 k Ω	2.10	3.66 k Ω
0.875	104 k Ω	2.15	3.44 k Ω
0.900	77.5 k Ω	2.20	3.22 k Ω
0.925	61.5 k Ω	2.25	3.03 k Ω
0.950	50.8 k Ω	2.30	2.84 k Ω
0.975	43.2 k Ω	2.35	2.67 k Ω
1.000	37.5 k Ω	2.40	2.51 k Ω
1.025	33.1 k Ω	2.45	2.36 k Ω
1.050	29.5 k Ω	2.50	2.22 k Ω
1.075	26.6 k Ω	2.55	2.08 k Ω
1.100	24.2 k Ω	2.60	1.95 k Ω
1.125	22.1 k Ω	2.65	1.83 k Ω
1.150	20.4 k Ω	2.70	1.72 k Ω
1.175	18.8 k Ω	2.75	1.61 k Ω
1.200	17.5 k Ω	2.80	1.51 k Ω
1.225	16.3 k Ω	2.85	1.41 k Ω
1.250	15.3 k Ω	2.90	1.32 k Ω
1.275	14.4 k Ω	2.95	1.23 k Ω
1.300	13.5 k Ω	3.00	1.15 k Ω
1.325	12.7 k Ω	3.05	1.07 k Ω
1.350	12.1 k Ω	3.10	988 Ω
1.375	11.4 k Ω	3.15	914 Ω
1.400	10.8 k Ω	3.20	843 Ω
1.425	10.3 k Ω	3.25	775 Ω
1.450	9.82 k Ω	3.30	710 Ω
1.475	9.36 k Ω	3.35	647 Ω
1.50	8.94 k Ω	3.40	587 Ω
1.55	8.18 k Ω	3.45	529 Ω
1.60	7.51 k Ω	3.50	473 Ω
1.65	6.92 k Ω	3.55	419 Ω
1.70	6.4 k Ω	3.60	367 Ω
1.75	5.93 k Ω		
1.80	5.51 k Ω		
1.85	5.13 k Ω		
1.90	4.78 k Ω		
1.95	4.47 k Ω		

Notes:

1. Modules that operate from a 3.3-V input bus should not be adjusted higher than 2.5 V.
2. Use a 0.1 W resistor. The tolerance should be 1 %, with temperature stability of 100 ppm/ $^{\circ}$ C (or better). Place the resistor as close to the regulator as possible. Connect the resistor directly between pins 4 and 7 using dedicated PCB traces.
3. Never connect capacitors from $V_o Adjust$ to either GND or V_{out} . Any capacitance added to the $V_o Adjust$ pin will affect the stability of the regulator.

Features of the PTH Family of Non-Isolated Wide Output Adjust Power Modules

Point-of-Load Alliance

The PTH family of non-isolated, wide-output adjust power modules from Texas Instruments are optimized for applications that require a flexible, high performance module that is small in size. These products are part of the “Point-of-Load Alliance” (POLA), which ensures compatible footprint, interoperability and true second sourcing for customer design flexibility. The POLA is a collaboration between Texas Instruments, Artesyn Technologies, and Astec Power to offer customers advanced non-isolated modules that provide the same functionality and form factor. Product series covered by the alliance includes the PTHxx050W (6 A), PTHxx060W (10 A), PTHxx010W (15/12 A), PTHxx020W (22/18 A), and the PTHxx030W (30/26 A).

From the basic, “Just Plug it In” functionality of the 6-A modules, to the 30-A rated feature-rich PTHxx030W, these products were designed to be very flexible, yet simple to use. The features vary with each product. Table 3-1 provides a quick reference to the available features by product and input bus voltage.

Table 3-1; Operating Features by Series and Input Bus Voltage

Series	Input Bus	I _{OUT}	Adjust (Trim)	On/Off Inhibit	Over-Current	Pre-Bias Startup	Auto-Track™	Margin Up/Down	Output Sense	Thermal Shutdown
PTHxx050	3.3 V	6 A	•	•	•	•	•			
	5 V	6 A	•	•	•	•	•			
	12 V	6 A	•	•	•		•			
PTHxx060	3.3 V / 5 V	10 A	•	•	•	•	•	•	•	•
	12 V	8 A	•	•	•		•	•	•	•
PTHxx010	3.3 V / 5 V	15 A	•	•	•	•	•	•	•	•
	12 V	12 A	•	•	•		•	•	•	•
PTHxx020	3.3 V / 5 V	22 A	•	•	•	•	•	•	•	•
	12 V	18 A	•	•	•		•	•	•	•
PTHxx030	3.3 V / 5 V	30 A	•	•	•	•	•	•	•	•
	12 V	26 A	•	•	•		•	•	•	•

For simple point-of-use applications, the PTHxx050W provides operating features such as an on/off inhibit, output voltage trim, pre-bias startup (3.3/5-V input only), and over-current protection. The PTHxx060W (10 A), and PTHxx010W (15/12 A) include an output voltage sense, and margin up/down controls. Then the higher

output current, PTHxx020W and PTHxx030W products incorporate over-temperature shutdown protection. All of the products referenced in Table 3-1 include Auto-Track™. This is a feature unique to the PTH family, and was specifically designed to simplify the task of sequencing the supply voltage in a power system. These and other features are described in the following sections.

Soft-Start Power Up

The Auto-Track feature allows the power-up of multiple PTH modules to be directly controlled from the *Track* pin. However in a stand-alone configuration, or when the Auto-Track feature is not being used, the *Track* pin should be directly connected to the input voltage, V_{in} (see Figure 3-1).

Figure 3-1

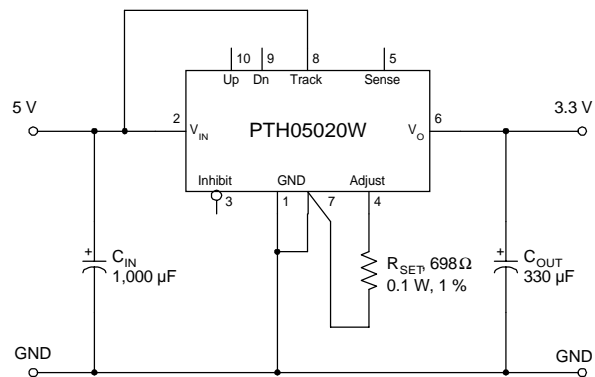

When the *Track* pin is connected to the input voltage the Auto-Track function is permanently disengaged. This allows the module to power up entirely under the control of its internal soft-start circuitry. When power up is under soft-start control, the output voltage rises to the set-point at a quicker and more linear rate.

Figure 3-2

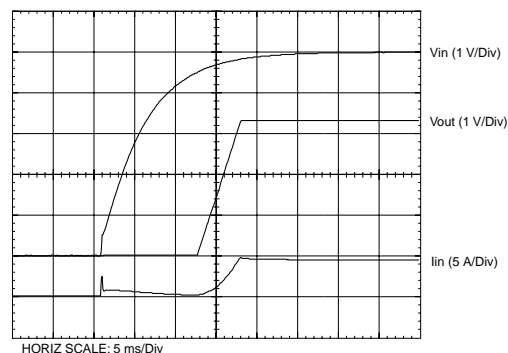

From the moment a valid input voltage is applied, the soft-start control introduces a short time delay (typically 5 ms-10 ms) before allowing the output voltage to rise. The output then progressively rises to the module's set-point voltage. Figure 3-2 shows the power-up characteristic of the 22-A output product (PTH05020W), operating from a 5-V input bus and configured for a 3.3-V output. The waveforms were measured with a 5-A resistive load. The initial rise in input current when the input voltage first starts to rise is the charge current drawn by the input capacitors. Power-up is complete within 15 ms.

Over-Current Protection

For protection against load faults, all modules incorporate output over-current protection. Applying a load that exceeds the regulator's over-current threshold will cause the regulated output to shut down. Following shutdown a module will periodically attempt to recover by initiating a soft-start power-up. This is described as a "hiccup" mode of operation, whereby the module continues in a cycle of successive shutdown and power up until the load fault is removed. During this period, the average current flowing into the fault is significantly reduced. Once the fault is removed, the module automatically recovers and returns to normal operation.

Over-Temperature Protection

The PTHxx020 and PTHxx030 series of products have over-temperature protection. These products have an on-board temperature sensor that protects the module's internal circuitry against excessively high temperatures. A rise in the internal temperature may be the result of a drop in airflow, or a high ambient temperature. If the internal temperature exceeds the OTP threshold, the module's *Inhibit* control is automatically pulled low. This turns the output off. The output voltage will drop as the external output capacitors are discharged by the load circuit. The recovery is automatic, and begins with a soft-start power up. It occurs when the the sensed temperature decreases by about 10 °C below the trip point.

Note: The over-temperature protection is a last resort mechanism to prevent thermal stress to the regulator. Operation at or close to the thermal shutdown temperature is not recommended and will reduce the long-term reliability of the module. Always operate the regulator within the specified Safe Operating Area (SOA) limits for the worst-case conditions of ambient temperature and airflow.

Output On/Off Inhibit

For applications requiring output voltage on/off control, each series of the PTH family incorporates an output *Inhibit* control pin. The inhibit feature can be used wherever there is a requirement for the output voltage from the regulator to be turned off.

The power modules function normally when the *Inhibit* pin is left open-circuit, providing a regulated output whenever a valid source voltage is connected to V_{in} with respect to GND .

Figure 3-3 shows the typical application of the inhibit function. Note the discrete transistor (Q_1). The *Inhibit* control has its own internal pull-up to V_{in} potential. The input is not compatible with TTL logic devices. An open-collector (or open-drain) discrete transistor is recommended for control.

Figure 3-3



Turning Q_1 on applies a low voltage to the *Inhibit* control and disables the output of the module. If Q_1 is then turned off, the module will execute a soft-start power-up. A regulated output voltage is produced within 20 msec. Figure 3-4 shows the typical rise in both the output voltage and input current, following the turn-off of Q_1 . The turn off of Q_1 corresponds to the rise in the waveform, $Q_1 V_{ds}$. The waveforms were measured with a 5-A load.

Figure 3-4

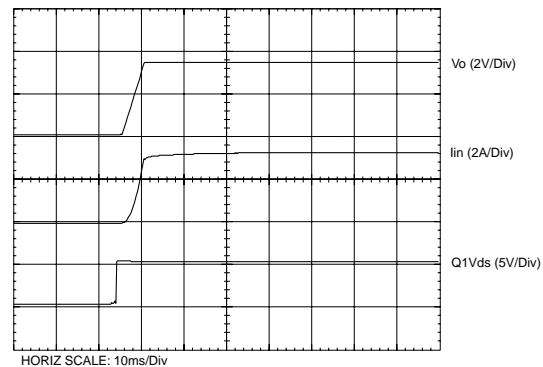

Auto-Track™ Function

The Auto-Track function is unique to the PTH family, and is available with the all “Point-of-Load Alliance” (POLA) products. Auto-Track was designed to simplify the amount of circuitry required to make the output voltage from each module power up and power down in sequence. The sequencing of two or more supply voltages during power up is a common requirement for complex mixed-signal applications, that use dual-voltage VLSI ICs such as DSPs, micro-processors, and ASICs.

How Auto-Track Works

Auto-Track works by forcing the module’s output voltage to follow a voltage presented at the *Track* control pin. This control range is limited to between 0 V and the module’s set-point voltage. Once the track-pin voltage is raised above the set-point voltage, the module’s output remains at its set-point¹. As an example, if the *Track* pin of a 2.5-V regulator is at 1 V, the regulated output will be 1 V. But if the voltage at the *Track* pin rises to 3 V, the regulated output will not go higher than 2.5 V.

When under track control, the regulated output from the module follows the voltage at its *Track* pin on a volt-for-volt basis. By connecting the *Track* pin of a number of these modules together, the output voltages will follow a common signal during power-up and power-down. The control signal can be an externally generated master ramp waveform, or the output voltage from another power supply circuit³. For convenience the *Track* control incorporates an internal RC charge circuit. This operates off the module’s input voltage to provide a suitable rising voltage ramp waveform.

Typical Application

The basic implementation of Auto-Track allows for simultaneous voltage sequencing of a number of Auto-Track compliant modules. Connecting the *Track* control pins of two or more modules forces the *Track* control of all modules to follow the same collective RC ramp waveform, and allows them to be controlled through a single transistor or switch; Q₁ in Figure 3-5.

To initiate a power-up sequence the *Track* control must first be pulled to ground potential. This should be done at or before input power is applied to the modules, and then held for at least 10 ms thereafter. This brief period gives the modules time to complete their internal soft-start initialization, which enables them to produce an output voltage.

Applying a logic-level high signal to the circuit’s On/Off Control turns Q₁ on and applies a ground signal to the *Track* control. After completing their internal soft-start initialization, the output of all modules will remain at zero volts while Q₁ is on. 10 ms after a valid input voltage has been applied to all modules, Q₁ can be turned off. This allows the track control voltage to automatically rise toward the modules’ input voltage. During this period the output voltage of each module will rise in unison with

other modules, to its respective set-point voltage.

Figure 3-6 shows the output voltage waveforms from the circuit of Figure 3-5 after the On/Off Control is set from a high to a low-level voltage. The waveforms, V_{O1} and V_{O2} represent the output voltages from the two power modules, U₁ (3.3 V) and U₂ (1.8 V) respectively. V_{O1} and V_{O2} are shown rising together to produce the desired simultaneous power-up characteristic.

The same circuit also provides a power-down sequence. Power down is the reverse of power up, and is accomplished by lowering the track control voltage back to zero volts. The important constraint is that a valid input voltage must be maintained until the power down is complete. It also requires that Q₁ be turned off relatively slowly. This is so that the *Track* control voltage does not fall faster than Auto-Track’s slew rate capability, which is 1 V/ms. The components R₁ and C₁ in Figure 3-5 limit the rate at which Q₁ can pull down the *Track* control voltage. The values of 100 k-ohm and 0.1 μF correlate to a decay rate of about 0.17 V/ms.

The power-down sequence is initiated with a low-to-high transition at the On/Off Control input to the circuit. Figure 3-7 shows the power-down waveforms. As the *Track* control voltage falls below the nominal set-point voltage of each power module, then its output voltage decays with all the other modules under Auto-Track control.

Notes on Use of Auto-Track™

1. The *Track* pin voltage must be allowed to rise above the module’s set-point voltage before the module can regulate at its adjusted set-point voltage.
2. The Auto-Track function will track almost any voltage ramp during power up, and is compatible with ramp speeds of up to 1 V/ms.
3. The absolute maximum voltage that may be applied to the *Track* pin is V_{in}.
4. The module will not follow a voltage at its *Track* control input until it has completed its soft-start initialization. This takes about 10 ms from the time that the module has sensed that a valid voltage has been applied its input. During this period, it is recommended that the *Track* pin be held at ground potential.
5. The module is capable of both sinking and sourcing current when following a voltage at its *Track* pin. Therefore startup into an output prebias is not supported during Auto-Track control. *Note: A pre-bias holdoff is not necessary when all supply voltages rise simultaneously under the control of Auto-Track.*
6. The Auto-Track function can be disabled by connecting the *Track* pin to the input voltage (V_{in}). With Auto-Track disabled, the output voltage will rise at a quicker and more linear rate after input power is applied.

Figure 3-5; Sequenced Power Up & Power Down Using Auto-Track



Figure 3-6; Simultaneous Power Up with Auto-Track Control



Figure 3-7; Simultaneous Power Down with Auto-Track Control



Margin Up/Down Controls

The PTH_{xx}060W, PTH_{xx}010W, PTH_{xx}020W, and PTH_{xx}030W products incorporate *Margin Up* and *Margin Down* control inputs. These controls allow the output voltage to be momentarily adjusted¹, either up or down, by a nominal 5%. This provides a convenient method for dynamically testing the operation of the load circuit over its supply margin or range. It can also be used to verify the function of supply voltage supervisors. The ±5% change is applied to the adjusted output voltage, as set by the external resistor, R_{set} at the V_o Adjust pin.

The 5% adjustment is made by pulling the appropriate margin control input directly to the GND terminal². A low-leakage open-drain device, such as an n-channel MOSFET or p-channel JFET is recommended for this purpose³. Adjustments of less than 5% can also be accommodated by adding series resistors to the control inputs. The value of the resistor can be selected from Table 3-2, or calculated using the following formula.

Up/Down Adjust Resistance Calculation

To reduce the margin adjustment to something less than 5%, series resistors are required (See R_D and R_U in Figure 3-8). For the same amount of adjustment, the resistor value calculated for R_U and R_D will be the same. The formulas is as follows.

$$R_U \text{ or } R_D = \frac{499}{\Delta\%} - 99.8 \quad \text{k}\Omega$$

Where Δ% = The desired amount of margin adjust in percent.

Notes:

1. The *Margin Up** and *Margin Dn** controls were not intended to be activated simultaneously. If they are their affects on the output voltage may not completely cancel, resulting in the possibility of a slightly higher error in the output voltage set point.
2. The ground reference should be a direct connection to the module GND at pin 7 (pin 1 for the PTH_{xx}050).
3. The Margin Up and Margin Dn control inputs are not compatible with devices that source voltage. This includes TTL logic. These are analog inputs and should only be controlled with a true open-drain device (preferably a discrete MOSFET transistor). The device selected should have low off-state leakage current. Each input sources 8 μA when grounded, and has an open-circuit voltage of 0.8 V.

Table 3-2; Margin Up/Down Resistor Values

% Adjust	R _U / R _D
5	0.0 kΩ
4	24.9 kΩ
3	66.5 kΩ
2	150.0 kΩ
1	397.0 kΩ

Figure 3-8; Margin Up/Down Application Schematic



Pre-Bias Startup Capability

Only selected products in the PTH family incorporate this capability. Consult Table 3-1 to identify which products are compliant.

A pre-bias startup condition occurs as a result of an external voltage being present at the output of a power module prior to its output becoming active. This often occurs in complex digital systems when current from another power source is backed through a dual-supply logic component, such as an FPGA or ASIC. Another path might be via clamp diodes as part of a dual-supply power-up sequencing arrangement. A prebias can cause problems with power modules that incorporate synchronous rectifiers. This is because under most operating conditions, these types of modules can sink as well as source output current.

The PTH family of power modules incorporate synchronous rectifiers, but will not sink current during startup¹, or whenever the *Inhibit* pin is held low. However, to ensure satisfactory operation of this function, certain conditions must be maintained.² Figure 3-9 shows an application demonstrating the pre-bias startup capability. The startup waveforms are shown in Figure 3-10. Note that the output current from the PTH03010W (I_o) shows negligible current until its output voltage rises above that backed through diodes D_1 and D_2 .

*Note: The pre-bias start-up feature is not compatible with Auto-Track. When the module is under Auto-Track control, it will sink current if the output voltage is below that of a back-feeding source. To ensure a pre-bias hold-off one of two approaches must be followed when input power is applied to the module. The Auto-Track function must either be disabled³, or the module's output held off (for at least 50 ms) using the *Inhibit* pin. Either approach ensures that the *Track* pin voltage is above the set-point voltage at start up.*

Figure 3-9; Application Circuit Demonstrating Pre-Bias Startup



Notes

1. Startup includes the short delay (approx. 10 ms) prior to the output voltage rising, followed by the rise of the output voltage under the module's internal soft-start control. Startup is complete when the output voltage has risen to either the set-point voltage or the voltage at the *Track* pin, whichever is lowest.
2. To ensure that the regulator does not sink current when power is first applied (even with a ground signal applied to the *Inhibit* control pin), the input voltage must always be greater than the output voltage throughout the power-up and power-down sequence.
3. The Auto-Track function can be disabled at power up by immediately applying a voltage to the module's *Track* pin that is greater than its set-point voltage. This can be easily accomplished by connecting the *Track* pin to V_{in} .

Figure 3-10; Pre-Bias Startup Waveforms







Remote Sense

The PTHxx060W, PTHxx010W, PTHxx020W, and PTHxx030W products incorporate an output voltage sense pin, V_o Sense. The V_o Sense pin should be connected to V_{out} at the load circuit (see data sheet standard application). A remote sense improves the load regulation performance of the module by allowing it to compensate for any 'IR' voltage drop between itself and the load. An IR drop is caused by the high output current flowing through the small amount of pin and trace resistance. Use of the remote sense is optional. If not used, the V_o Sense pin can be left open-circuit. An internal low-value resistor (15- Ω or less) is connected between the V_o Sense and V_{out} . This ensures the output voltage remains in regulation.

With the sense pin connected, the difference between the voltage measured directly between the V_{out} and GND pins, and that measured from V_o Sense to GND , is the amount of IR drop being compensated by the regulator. This should be limited to a maximum of 0.3 V.

Note: The remote sense feature is not designed to compensate for the forward drop of non-linear or frequency dependent components that may be placed in series with the converter output. Examples include OR-ing diodes, filter inductors, ferrite beads, and fuses. When these components are enclosed by the remote sense connection they are effectively placed inside the regulation control loop, which can adversely affect the stability of the regulator.

PACKAGING INFORMATION

Orderable Device	Status (1)	Package Type	Package Drawing	Pins	Package Qty	Eco Plan (2)	Lead finish/ Ball material (6)	MSL Peak Temp (3)	Op Temp (°C)	Device Marking (4/5)	Samples
PTH03020WAH	ACTIVE	Through-Hole Module	EUK	10	20	RoHS (In Work) & Green (In Work)	SN	N / A for Pkg Type	-40 to 85		
PTH03020WAS	ACTIVE	Surface Mount Module	EUL	10	20	Non-RoHS & Green (In Work)	SNPB	Level-1-235C-UNLIM/ Level-3-260C-168HRS	-40 to 85		
PTH03020WAST	ACTIVE	Surface Mount Module	EUL	10	200	Non-RoHS & Green (In Work)	SNPB	Level-1-235C-UNLIM/ Level-3-260C-168HRS	-40 to 85		
PTH03020WAZ	ACTIVE	Surface Mount Module	EUL	10	20	RoHS (In Work) & Green (In Work)	SNAGCU	Level-3-260C-168 HR	-40 to 85		
PTH03020WAZT	ACTIVE	Surface Mount Module	EUL	10	200	RoHS (In Work) & Green (In Work)	SNAGCU	Level-3-260C-168 HR	-40 to 85		

(1) The marketing status values are defined as follows:

ACTIVE: Product device recommended for new designs.

LIFEBUY: TI has announced that the device will be discontinued, and a lifetime-buy period is in effect.

NRND: Not recommended for new designs. Device is in production to support existing customers, but TI does not recommend using this part in a new design.

PREVIEW: Device has been announced but is not in production. Samples may or may not be available.

OBSELETE: TI has discontinued the production of the device.

(2) **RoHS:** TI defines "RoHS" to mean semiconductor products that are compliant with the current EU RoHS requirements for all 10 RoHS substances, including the requirement that RoHS substance do not exceed 0.1% by weight in homogeneous materials. Where designed to be soldered at high temperatures, "RoHS" products are suitable for use in specified lead-free processes. TI may reference these types of products as "Pb-Free".

RoHS Exempt: TI defines "RoHS Exempt" to mean products that contain lead but are compliant with EU RoHS pursuant to a specific EU RoHS exemption.

Green: TI defines "Green" to mean the content of Chlorine (Cl) and Bromine (Br) based flame retardants meet JS709B low halogen requirements of <=1000ppm threshold. Antimony trioxide based flame retardants must also meet the <=1000ppm threshold requirement.

(3) MSL, Peak Temp. - The Moisture Sensitivity Level rating according to the JEDEC industry standard classifications, and peak solder temperature.

(4) There may be additional marking, which relates to the logo, the lot trace code information, or the environmental category on the device.

⁽⁵⁾ Multiple Device Markings will be inside parentheses. Only one Device Marking contained in parentheses and separated by a "-" will appear on a device. If a line is indented then it is a continuation of the previous line and the two combined represent the entire Device Marking for that device.

⁽⁶⁾ Lead finish/Ball material - Orderable Devices may have multiple material finish options. Finish options are separated by a vertical ruled line. Lead finish/Ball material values may wrap to two lines if the finish value exceeds the maximum column width.

Important Information and Disclaimer:The information provided on this page represents TI's knowledge and belief as of the date that it is provided. TI bases its knowledge and belief on information provided by third parties, and makes no representation or warranty as to the accuracy of such information. Efforts are underway to better integrate information from third parties. TI has taken and continues to take reasonable steps to provide representative and accurate information but may not have conducted destructive testing or chemical analysis on incoming materials and chemicals. TI and TI suppliers consider certain information to be proprietary, and thus CAS numbers and other limited information may not be available for release.

In no event shall TI's liability arising out of such information exceed the total purchase price of the TI part(s) at issue in this document sold by TI to Customer on an annual basis.

MECHANICAL DATA

EUK (R-PDSS-T10)

DOUBLE SIDED MODULE

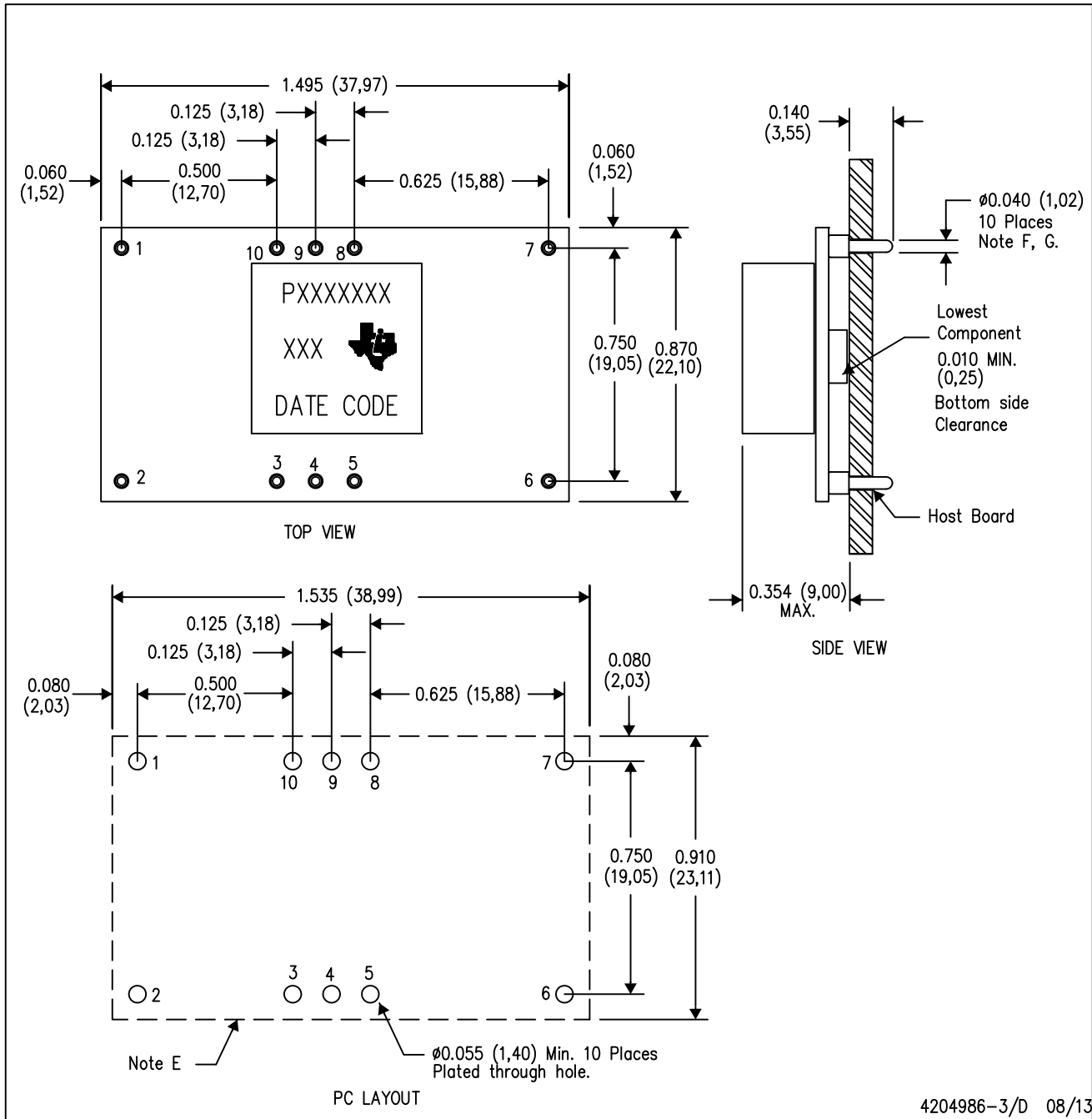

4204986-3/D 08/13

- NOTES:
- A. All linear dimensions are in inches (mm).
 - B. This drawing is subject to change without notice.
 - C. 2 place decimals are ± 0.030 ($\pm 0,76$ mm).
 - D. 3 place decimals are ± 0.010 ($\pm 0,25$ mm).
 - E. Recommended keep out area for user components.

- F. Pins are 0.040" (1,02) diameter with 0.070" (1,78) diameter standoff shoulder.
- G. All pins: Material - Copper Alloy
Finish - Tin (100%) over Nickel plate

MECHANICAL DATA

EUL (R-PDSS-B10)

DOUBLE SIDED MODULE

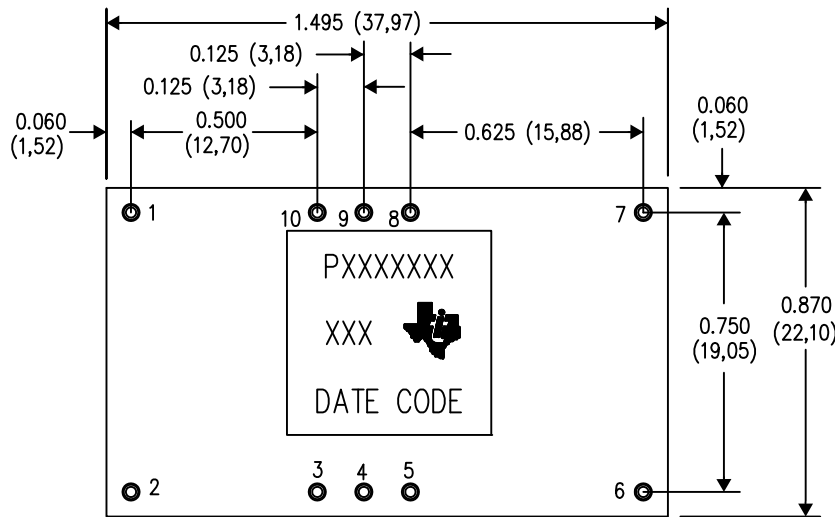

TOP VIEW

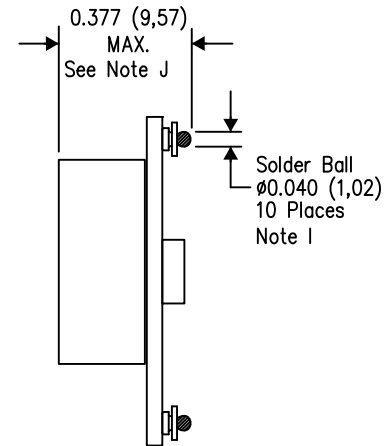

SIDE VIEW

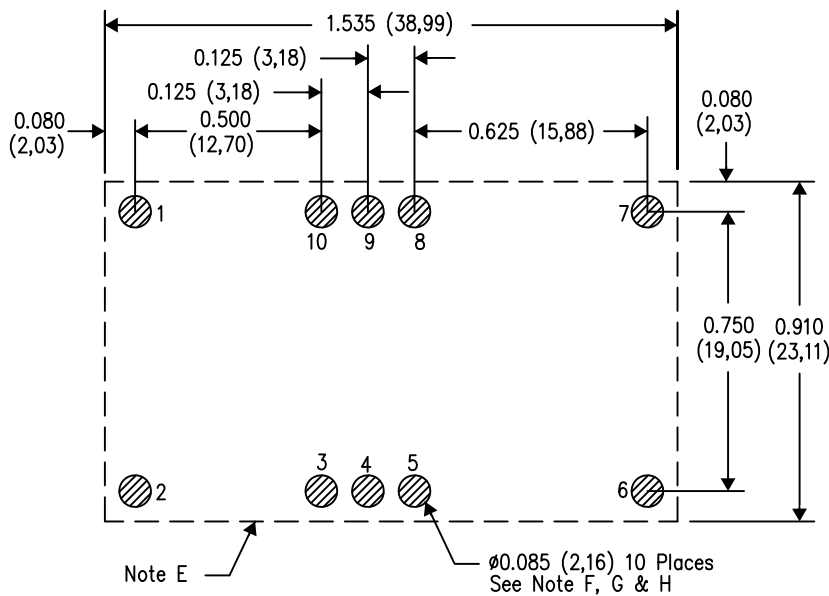

PC LAYOUT

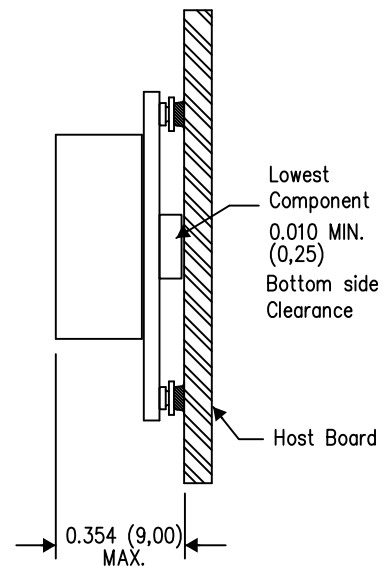

4204987-3/D 08/13

- NOTES:
- A. All linear dimensions are in inches (mm).
 - B. This drawing is subject to change without notice.
 - C. 2 place decimals are ± 0.030 (± 0.76 mm).
 - D. 3 place decimals are ± 0.010 (± 0.25 mm).
 - E. Recommended keep out area for user components.
 - F. Power pin connection should utilize four or more vias to the interior power plane of 0.025 (0.63) I.D. per input, ground and output pin (or the electrical equivalent).

- G. Paste screen opening: 0.080 (2,03) to 0.085 (2,16).
Paste screen thickness: 0.006 (0,15).
- H. Pad type: Solder mask defined.
- I. All pins: Material - Copper Alloy
Finish - Tin (100%) over Nickel plate
Solder Ball - See product data sheet.
- J. Dimension prior to reflow solder.

IMPORTANT NOTICE AND DISCLAIMER

TI PROVIDES TECHNICAL AND RELIABILITY DATA (INCLUDING DATASHEETS), DESIGN RESOURCES (INCLUDING REFERENCE DESIGNS), APPLICATION OR OTHER DESIGN ADVICE, WEB TOOLS, SAFETY INFORMATION, AND OTHER RESOURCES "AS IS" AND WITH ALL FAULTS, AND DISCLAIMS ALL WARRANTIES, EXPRESS AND IMPLIED, INCLUDING WITHOUT LIMITATION ANY IMPLIED WARRANTIES OF MERCHANTABILITY, FITNESS FOR A PARTICULAR PURPOSE OR NON-INFRINGEMENT OF THIRD PARTY INTELLECTUAL PROPERTY RIGHTS.

These resources are intended for skilled developers designing with TI products. You are solely responsible for (1) selecting the appropriate TI products for your application, (2) designing, validating and testing your application, and (3) ensuring your application meets applicable standards, and any other safety, security, or other requirements. These resources are subject to change without notice. TI grants you permission to use these resources only for development of an application that uses the TI products described in the resource. Other reproduction and display of these resources is prohibited. No license is granted to any other TI intellectual property right or to any third party intellectual property right. TI disclaims responsibility for, and you will fully indemnify TI and its representatives against, any claims, damages, costs, losses, and liabilities arising out of your use of these resources.

TI's products are provided subject to TI's Terms of Sale (www.ti.com/legal/termsofsale.html) or other applicable terms available either on ti.com or provided in conjunction with such TI products. TI's provision of these resources does not expand or otherwise alter TI's applicable warranties or warranty disclaimers for TI products.

Mailing Address: Texas Instruments, Post Office Box 655303, Dallas, Texas 75265
Copyright © 2020, Texas Instruments Incorporated