

## 100-W 48-V INPUT ISOLATED DC/DC CONVERTER

Check for Samples: [PTQA430025](#), [PTQA430033](#), [PTQA420050](#)

### FEATURES

- 100-W Output
- Input Voltage Range: 36 V to 75 V
- 92% Efficiency
- 1500 Vdc Isolation
- Fast Transient Response
- On/Off Control
- Overcurrent Protection
- Differential Remote Sense
- Adjustable Output Voltage
- Output Overvoltage Protection
- Over-Temperature Shutdown
- Undervoltage Lockout
- Standard 1/4-Brick Footprint
- UL Safety Agency Approval



### DESCRIPTION

The PTQA series of power modules are single-output isolated DC/DC converters, housed in an industry standard quarter-brick package. These modules are rated up to 100W with a maximum load current of up to 30 A.

The PTQA series operates from a standard 48-V telecom central office (CO) supply and occupies only 3.3 in<sup>2</sup> of PCB area. The modules offer OEMs a compact and flexible high-output power source in an industry standard footprint. They are suitable for distributed power applications in both telecom and computing environments, and may be used for powering high-end microprocessors, DSPs, general purpose logic and analog.

Features include a remote On/Off control with optional logic polarity, an undervoltage lockout (UVLO), a differential remote sense, and an industry standard output voltage adjustment using an external resistor. Protection features include output overcurrent protection (OCP), overvoltage protection (OVP), and thermal shutdown (OTP).

The modules are fully integrated for stand-alone operation, and require no additional components.

### STANDARD APPLICATION

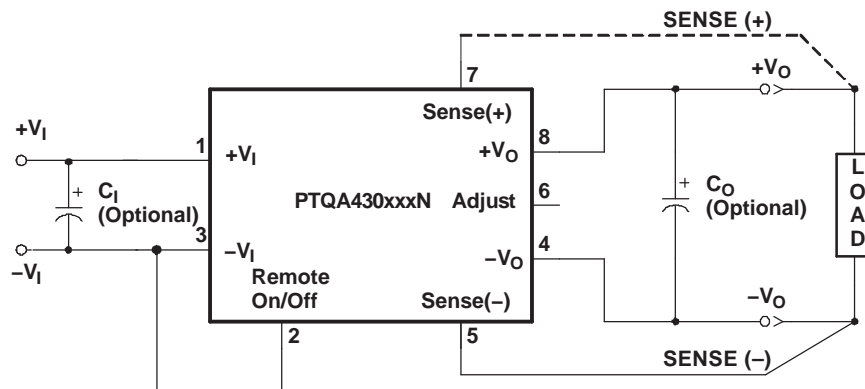

Please be aware that an important notice concerning availability, standard warranty, and use in critical applications of Texas Instruments semiconductor products and disclaimers thereto appears at the end of this data sheet.



This integrated circuit can be damaged by ESD. Texas Instruments recommends that all integrated circuits be handled with appropriate precautions. Failure to observe proper handling and installation procedures can cause damage.

ESD damage can range from subtle performance degradation to complete device failure. Precision integrated circuits may be more susceptible to damage because very small parametric changes could cause the device not to meet its published specifications.

### ORDERING INFORMATION

For the most current package and ordering information, see the Package Option Addendum at the end of this datasheet, or see the TI website at [www.ti.com](http://www.ti.com).

**Table 1. PART NUMBERING SCHEME**

	Input Voltage	Output Current	Output Voltage	Enable	Electrical Options		Pin Style
<b>PTQA</b>	<b>4</b>	<b>30</b>	<b>033</b>	<b>N</b>	<b>2</b>	<b>A</b>	<b>D</b>
	4 = 48 V	30 = 30A 20 = 20A	025 = 2.5 V 033 = 3.3 V 050 = 5.0 V	N = Negative P = Positive	2 = V <sub>O</sub> Adjust		D = Through-hole, Pb-free S = SMD, SnPb solder ball Z = SMD, SnAgCu solder ball

### ABSOLUTE MAXIMUM RATING

		UNIT
T <sub>A</sub>	Operating Temperature Range	Over V <sub>I</sub> Range –40°C to 85°C <sup>(1)</sup>
V <sub>I, MAX</sub>	Maximum Input Voltage	Continuous voltage Peak voltage for 100 ms duration 80 V 100 V
P <sub>O, MAX</sub>	Maximum Output Power	PTQA420050x2 PTQA430033x2 PTQA430025x2 100 W 75 W
T <sub>S</sub>	Storage Temperature	–40°C to 125°C
Mechanical Shock	Per Mil-STD-883, Method 2002.3 1 ms, 1/2 Sine, mounted	AD Suffix 250 G
		AS or AZ Suffix 175 G
Mechanical Vibration	Per Mil-STD-883, Method 2007.2 20-2000 Hz, PCB mounted	AD Suffix 15 G
		AS or AZ Suffix 2.5 G
Weight		30 grams
Flammability	Meets UL 94V-O	

(1) See SOA curves or consult factory for appropriate derating.

**ELECTRICAL CHARACTERISTICS PTQA430025**

(Unless otherwise stated,  $T_A = 25^\circ\text{C}$ ,  $V_I = 48\text{ V}$ ,  $V_O = 2.5\text{ V}$ ,  $C_O = 0\text{ }\mu\text{F}$ , and  $I_O = I_{Omax}$ )

PARAMETER		TEST CONDITIONS	PTQA430025			
			MIN	TYP	MAX	UNIT
$I_O$	Output Current	Over $V_I$ range	0		30	A
$V_I$	Input Voltage Range	Over $I_O$ Range	36	48	75	V
$V_O$ tol	Set Point Voltage Tolerance		$\pm 1^{(1)}$			$\%V_O$
$Reg_{temp}$	Temperature Variation	$-40^\circ\text{C} > T_A > 85^\circ\text{C}$	$\pm 1.15$			$\%V_O$
$Reg_{line}$	Line Regulation	Over $V_I$ range	$\pm 5$			mV
$Reg_{load}$	Load Regulation	Over $I_O$ range	$\pm 5$			mV
$\Delta V_{Otot}$	Total Output Voltage Variation	Includes set-point, line, load, $-40^\circ\text{C} > T_A > 85^\circ\text{C}$	$\pm 1.5$		$\pm 3$	$\%V_O$
$\Delta V_{ADJ}$	Output Adjust Range	$P_O \leq 75\text{ W}$	-20		10	$\%V_O$
$\eta$	Efficiency	$I_O = 50\% I_{Omax}$	91%			
$V_R$	$V_O$ Ripple (pk-pk)	20 MHz bandwidth	50	100		mV <sub>pp</sub>
$t_{tr}$	Transient Response	0.1 A/ $\mu\text{s}$ slew rate, 50% to 75% $I_{Omax}$	150			$\mu\text{s}$
$\Delta V_{tr}$		$V_O$ over/undershoot	25			mV
$I_{TRIP}$	Overcurrent Threshold	Shutdown, followed by auto-recovery	41			A
OVP	Output Overvoltage Protection	Output shutdown and latch off	120			$\%V_O$
OTP	Over Temperature Protection	Temperature Measurement at thermal sensor. Hysteresis = $10^\circ\text{C}$ nominal.	105			$^\circ\text{C}$
$f_s$	Switching Frequency	Over $V_I$ range	300			kHz
UVLO	Undervoltage Lockout	$V_{OFF}$ $V_{HYS}$	$V_I$ decreasing, $I_O = 6\text{ A}$ Hysteresis		32.5 1.5	V
On/Off Input: <b>Negative Enable</b>						
$V_{IH}$	Input High Voltage	Referenced to $-V_I$	2.4	Open <sup>(2)</sup>		V
$V_{IL}$	Input Low Voltage		-0.2	0.8		
$I_{IL}$	Input Low Current		-0.3			mA
On/Off Input: <b>Positive Enable</b>						
$V_{IH}$	Input High Voltage	Referenced to $-V_I$	4.5	Open <sup>(2)</sup>		V
$V_{IL}$	Input Low Voltage		-0.2	0.8		
$I_{IL}$	Input Low Current		-0.5			mA
$I_{ISB}$	Standby Input Current	Output disabled (pin 2 status set to Off)	37			mA
$C_I$	External Input Capacitance	Between $+V_I$ and $-V_I$	100			$\mu\text{F}$
$C_O$	External Output Capacitance	Between $+V_O$ and $-V_O$	0	30000		$\mu\text{F}$
	Isolation Voltage	Input-to-output and input-to-case	1500			Vdc
	Isolation Capacitance	Input-to-output	1200			pF
	Isolation Resistance	Input-to-output	10			M $\Omega$

(1) If Sense(-) is not used, pin 5 must be connected to pin 4 for optimum output voltage accuracy.

(2) The Remote On/Off input has an internal pull-up and may be controlled with an open collector (drain) interface. An open circuit correlates to a logic high. Consult the application notes for interface considerations.

## ELECTRICAL CHARACTERISTICS PTQA430033

(Unless otherwise stated,  $T_A = 25^\circ\text{C}$ ,  $V_I = 48\text{ V}$ ,  $V_O = 3.3\text{ V}$ ,  $C_O = 0\ \mu\text{F}$ , and  $I_O = I_{Omax}$ )

PARAMETER		TEST CONDITIONS	PTQA430033			
			MIN	TYP	MAX	UNIT
$I_O$	Output Current	Over $V_I$ range	0		30	A
$V_I$	Input Voltage Range	Over $I_O$ Range	36	48	75	V
$V_O$ tol	Set Point Voltage Tolerance		$\pm 1^{(1)}$			$\%V_O$
$Reg_{temp}$	Temperature Variation	$-40^\circ\text{C} > T_A > 85^\circ\text{C}$	$\pm 1.15$			$\%V_O$
$Reg_{line}$	Line Regulation	Over $V_I$ range	$\pm 5$			mV
$Reg_{load}$	Load Regulation	Over $I_O$ range	$\pm 5$			mV
$\Delta V_{Otot}$	Total Output Voltage Variation	Includes set-point, line, load, $-40^\circ\text{C} > T_A > 85^\circ\text{C}$	$\pm 1.5$		$\pm 3$	$\%V_O$
$\Delta V_{ADJ}$	Output Adjust Range	$P_O \leq 100\text{ W}$	-20		10	$\%V_O$
$\eta$	Efficiency	$I_O = 50\% I_{Omax}$	92%			
$V_R$	$V_O$ Ripple (pk-pk)	20 MHz bandwidth		50	100	mV <sub>pp</sub>
$t_{tr}$	Transient Response	0.1 A/ $\mu\text{s}$ slew rate, 50% to 75% $I_{Omax}$	150			$\mu\text{s}$
$\Delta V_{tr}$		$V_O$ over/undershoot	33			mV
$I_{TRIP}$	Overcurrent Threshold	Shutdown, followed by auto-recovery	41			A
OVP	Output Overvoltage Protection	Output shutdown and latch off	120			$\%V_O$
OTP	Over Temperature Protection	Temperature Measurement at thermal sensor. Hysteresis = $10^\circ\text{C}$ nominal.	105			$^\circ\text{C}$
$f_s$	Switching Frequency	Over $V_I$ range	300			kHz
UVLO	Undervoltage Lockout	$V_{OFF}$ $V_{HYS}$	$V_I$ decreasing, $I_O = 6\text{ A}$ Hysteresis		32.5 1.5	V
On/Off Input: <b>Negative Enable</b>						
$V_{IH}$	Input High Voltage	Referenced to $-V_I$	2.4	Open <sup>(2)</sup>		V
$V_{IL}$	Input Low Voltage		-0.2	0.8		
$I_{IL}$	Input Low Current		-0.3			mA
On/Off Input: <b>Positive Enable</b>						
$V_{IH}$	Input High Voltage	Referenced to $-V_I$	4.5	Open <sup>(2)</sup>		V
$V_{IL}$	Input Low Voltage		-0.2	0.8		
$I_{IL}$	Input Low Current		-0.5			mA
$I_{isb}$	Standby Input Current	Output disabled (pin 2 status set to Off)	42			mA
$C_I$	External Input Capacitance	Between $+V_I$ and $-V_I$	100			$\mu\text{F}$
$C_O$	External Output Capacitance	Between $+V_O$ and $-V_O$	0	30000		$\mu\text{F}$
	Isolation Voltage	Input-to-output and input-to-case	1500			Vdc
	Isolation Capacitance	Input-to-output	1200			pF
	Isolation Resistance	Input-to-output	10			M $\Omega$

- (1) If Sense(-) is not used, pin 5 must be connected to pin 4 for optimum output voltage accuracy.
- (2) The Remote On/Off input has an internal pull-up and may be controlled with an open collector (drain) interface. An open circuit correlates to a logic high. Consult the application notes for interface considerations.

**ELECTRICAL CHARACTERISTICS PTQA420050**

 (Unless otherwise stated,  $T_A = 25^\circ\text{C}$ ,  $V_I = 48\text{ V}$ ,  $V_O = 5.0\text{ V}$ ,  $C_O = 0\text{ }\mu\text{F}$ , and  $I_O = I_{O\text{max}}$ )

PARAMETER		TEST CONDITIONS	PTQA420050			
			MIN	TYP	MAX	UNIT
$I_O$	Output Current	Over $V_I$ range	0		20	A
$V_I$	Input Voltage Range	Over $I_O$ Range	36	48	75	V
$V_O$ tol	Set Point Voltage Tolerance		$\pm 1^{(1)}$			$\%V_O$
$\text{Reg}_{\text{temp}}$	Temperature Variation	$-40^\circ\text{C} > T_A > 85^\circ\text{C}$	$\pm 1.15$			$\%V_O$
$\text{Reg}_{\text{line}}$	Line Regulation	Over $V_I$ range	$\pm 5$			mV
$\text{Reg}_{\text{load}}$	Load Regulation	Over $I_O$ range	$\pm 5$			mV
$\Delta V_{O\text{tot}}$	Total Output Voltage Variation	Includes set-point, line, load, $-40^\circ\text{C} > T_A > 85^\circ\text{C}$	$\pm 1.5$		$\pm 3$	$\%V_O$
$\Delta V_{\text{ADJ}}$	Output Adjust Range	$P_O \leq 100\text{ W}$	-20		10	$\%V_O$
$\eta$	Efficiency	$I_O = 50\% I_{O\text{max}}$	92.5%			
$V_R$	$V_O$ Ripple (pk-pk)	20 MHz bandwidth		50	100	mV <sub>pp</sub>
$t_{\text{tr}}$	Transient Response	0.1 A/ $\mu\text{s}$ slew rate, 50% to 75% $I_{O\text{max}}$	100			$\mu\text{s}$
$\Delta V_{\text{tr}}$		$V_O$ over/undershoot	50			mV
$I_{\text{TRIP}}$	Overcurrent Threshold	Shutdown, followed by auto-recovery	29			A
OVP	Output Overvoltage Protection	Output shutdown and latch off	120			$\%V_O$
OTP	Over Temperature Protection	Temperature Measurement at thermal sensor. Hysteresis = $10^\circ\text{C}$ nominal.	105			$^\circ\text{C}$
$f_s$	Switching Frequency	Over $V_I$ range	300			kHz
UVLO	Undervoltage Lockout	$V_{\text{OFF}}$ $V_{\text{HYS}}$	$V_I$ decreasing, $I_O = 6\text{ A}$ Hysteresis		32.5 1.5	V
On/Off Input: <b>Negative Enable</b>						
$V_{\text{IH}}$	Input High Voltage	Referenced to $-V_I$	2.4	Open <sup>(2)</sup>		V
$V_{\text{IL}}$	Input Low Voltage		-0.2	0.8		
$I_{\text{IL}}$	Input Low Current		-0.3			mA
On/Off Input: <b>Positive Enable</b>						
$V_{\text{IH}}$	Input High Voltage	Referenced to $-V_I$	4.5	Open <sup>(2)</sup>		V
$V_{\text{IL}}$	Input Low Voltage		-0.2	0.8		
$I_{\text{IL}}$	Input Low Current		-0.5			mA
$I_{\text{isb}}$	Standby Input Current	Output disabled (pin 2 status set to Off)	58			mA
$C_I$	External Input Capacitance	Between $+V_I$ and $-V_I$	100			$\mu\text{F}$
$C_O$	External Output Capacitance	Between $+V_O$ and $-V_O$	0	30000		$\mu\text{F}$
	Isolation Voltage	Input-to-output and input-to-case	1500			Vdc
	Isolation Capacitance	Input-to-output	1200			pF
	Isolation Resistance	Input-to-output	10			M $\Omega$

(1) If Sense(-) is not used, pin 5 must be connected to pin 4 for optimum output voltage accuracy.

(2) The Remote On/Off input has an internal pull-up and may be controlled with an open collector (drain) interface. An open circuit correlates to a logic high. Consult the application notes for interface considerations.

### PIN DESCRIPTIONS

**+V<sub>I</sub>:** The positive input for the module with respect to  $-V_I$ . When powering the module from a  $-48\text{-V}$  telecom central office supply, this input is connected to the primary system ground.

**$-V_I$ :** The negative input supply for the module, and the 0 VDC reference for the Remote On/Off input. When powering the module from a  $+48\text{-V}$  supply, this input is connected to the 48-V return.

**Remote On/Off:** This input controls the On/Off status of the output voltage. It is either driven low ( $-V_I$  potential), or left open-circuit. For units identified with the NEN option, applying a logic low to this pin will enable the output. And for units identified with the PEN option, the output will be disabled.

**V<sub>O</sub> Adjust:** Allows the output voltage to be trimmed by up or down between  $+10\%$  and  $-20\%$  of its nominal value. The adjustment method uses a single external resistor. Connecting the resistor between V<sub>O</sub> Adjust and  $-V_O$  adjusts the output voltage lower, and placing it between V<sub>O</sub> Adjust and  $+V_O$  adjusts the output higher. The calculations for the resistance value follows industry standard formulas. For further information consult the application note on output voltage adjustment.

**+V<sub>O</sub>:** The positive power output with respect to  $-V_O$ , which is DC isolated from the input supply pins. If a negative output voltage is desired,  $+V_O$  should be connected to the secondary circuit common and the output taken from  $-V_O$ .

**$-V_O$ :** The negative power output with respect to  $+V_O$ , which is DC isolated from the input supply pins. This output is normally connected to the secondary circuit common when a positive output voltage is desired.

**Sense(+):** Provides the converter with an output sense capability to regulate the set-point voltage directly at the load. When used with Sense(-), the regulation circuitry will compensate for voltage drop between the converter and the load. The pin may be left open circuit, but connecting it to  $+V_O$  improves load regulation.

**Sense(-):** Provides the converter with an output sense capability when used in conjunction with Sense(+) input. For optimum output voltage accuracy this pin should always be connected to  $-V_O$ .

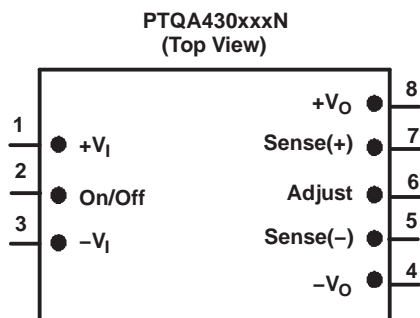

TYPICAL CHARACTERISTICS

PTQA430025,  $V_O = 2.5\text{ V}$  <sup>(1)</sup> <sup>(2)</sup>

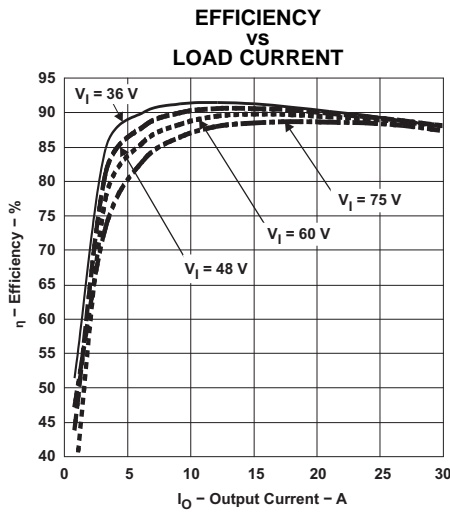

Figure 1.

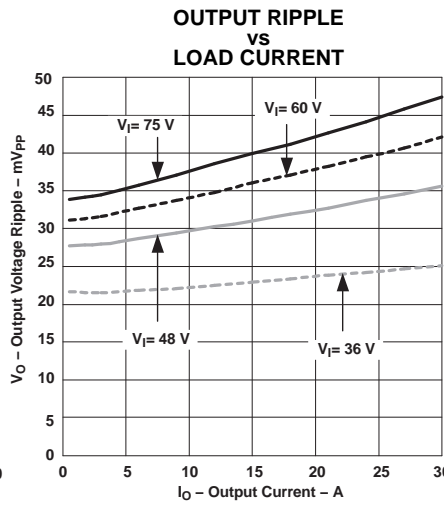

Figure 2.

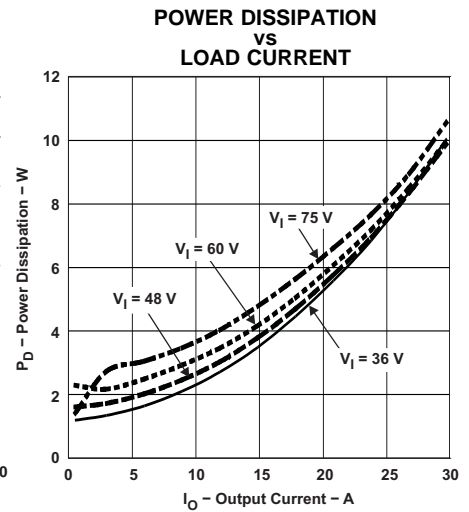

Figure 3.

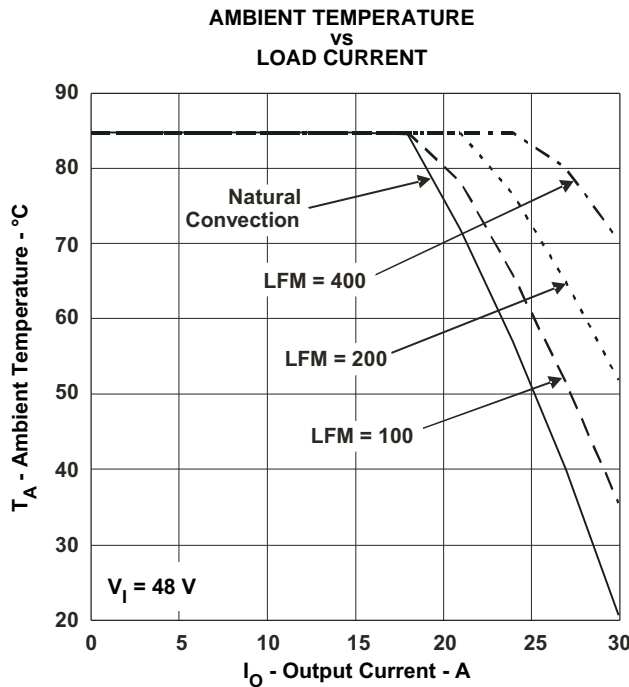

Figure 4.

- (1) All data listed in Figure 1, Figure 2, and Figure 3 have been developed from actual products tested at 25°C. This data is considered typical data for the dc-dc converter.
- (2) The temperature derating curves represent operating conditions at which internal components are at or below manufacturer's maximum rated operating temperature. Derating limits apply to modules soldered directly to a 100–mm x 100–mm, double-sided PCB with 2 oz. copper. For surface mount packages, multiple vias (plated through holes) are required to add thermal paths around the power pins. Please refer to the mechanical specification for more information. Applies to Figure 4.

TYPICAL CHARACTERISTICS

PTQA430033,  $V_O = 3.3\text{ V}$  <sup>(1)</sup> <sup>(2)</sup>

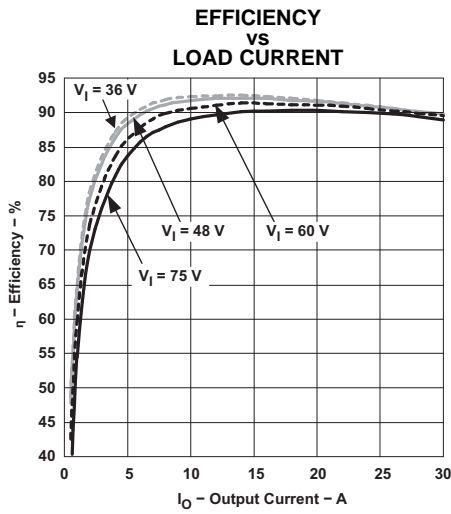

Figure 5.

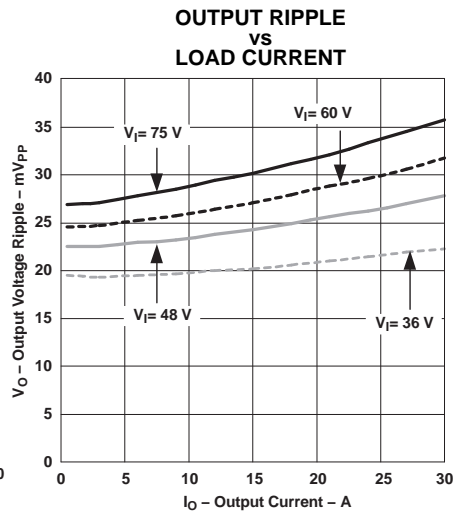

Figure 6.

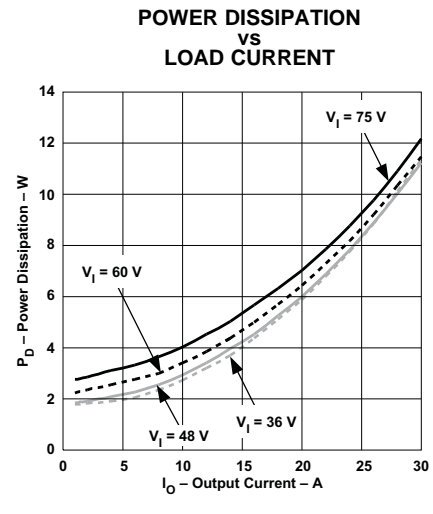

Figure 7.

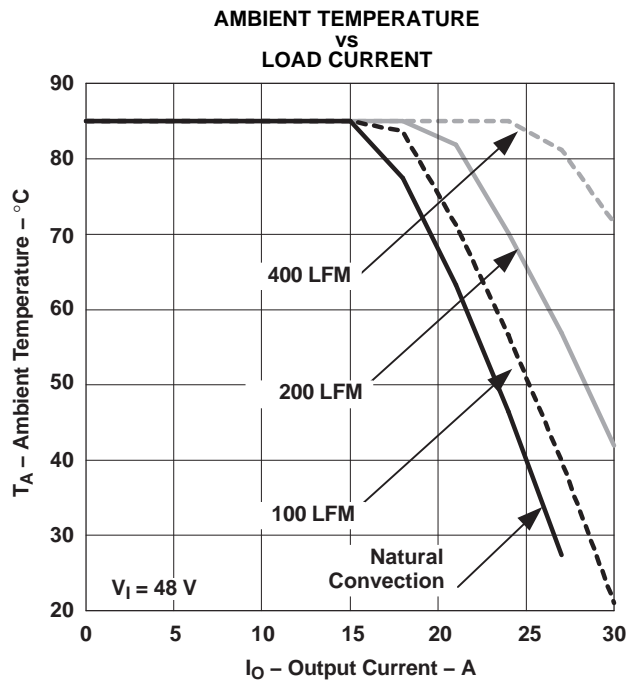

Figure 8.

- (1) All data listed in Figure 5, Figure 6, and Figure 7 have been developed from actual products tested at 25°C. This data is considered typical data for the dc-dc converter.
- (2) The temperature derating curves represent operating conditions at which internal components are at or below manufacturer's maximum rated operating temperature. Derating limits apply to modules soldered directly to a 100-mm x 100-mm, double-sided PCB with 2 oz. copper. For surface mount packages, multiple vias (plated through holes) are required to add thermal paths around the power pins. Please refer to the mechanical specification for more information. Applies to Figure 8.



TYPICAL CHARACTERISTICS

PTQA420050,  $V_O = 5.0\text{ V}$  (1) (2)

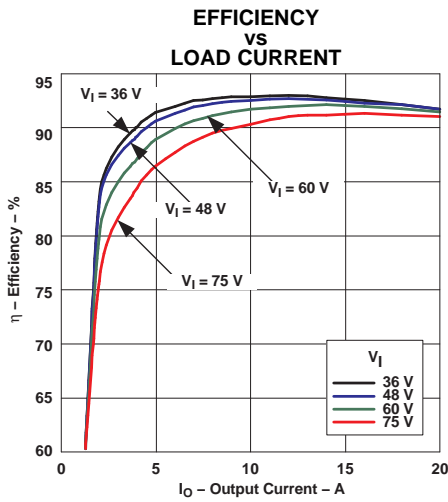

Figure 9.

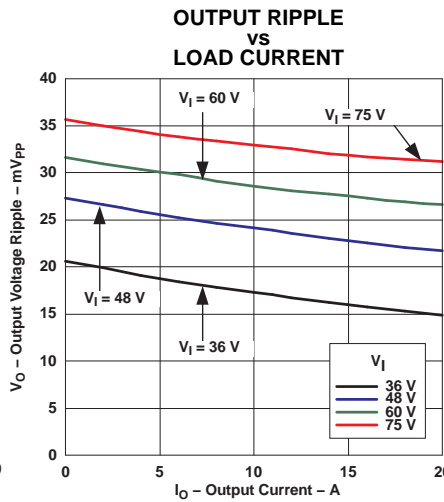

Figure 10.

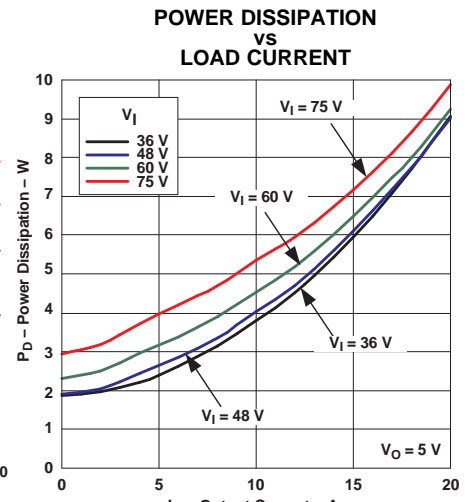

Figure 11.

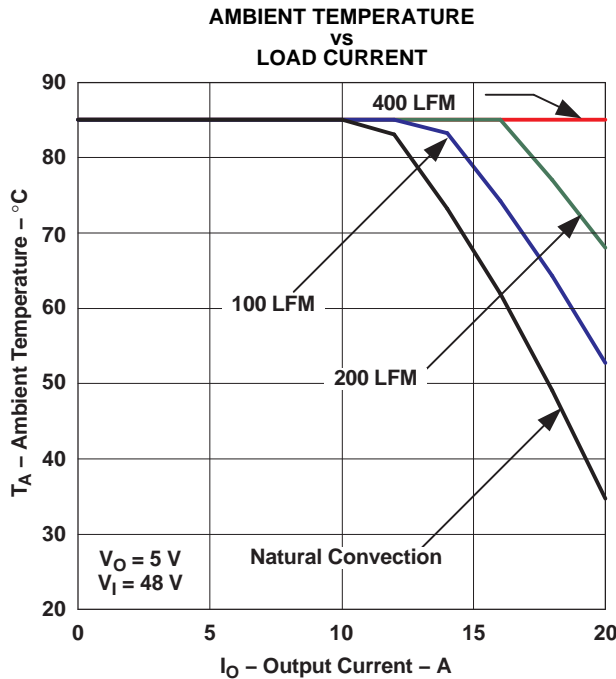

Figure 12.

- (1) All data listed in Figure 9, Figure 10, and Figure 11 have been developed from actual products tested at 25°C. This data is considered typical data for the dc-dc converter.
- (2) The temperature derating curves represent operating conditions at which internal components are at or below manufacturer's maximum rated operating temperature. Derating limits apply to modules soldered directly to a 100–mm x 100–mm, double-sided PCB with 2 oz. copper. For surface mount packages, multiple vias (plated through holes) are required to add thermal paths around the power pins. Please refer to the mechanical specification for more information. Applies to Figure 12.

## APPLICATION INFORMATION

### Operating Features and System Considerations for the PTQA Series of DC/DC Converters

#### Overcurrent Protection

To protect against load faults, these converters incorporate output overcurrent protection. Applying a load to the output that exceeds the converter's overcurrent threshold (see applicable specification) will cause the output voltage to momentarily fold back, and then shut down. Following shutdown the module will periodically attempt to automatically recover by initiating a soft-start power-up. This is often described as a *hiccup* mode of operation, whereby the module continues in the cycle of successive shutdown and power up until the load fault is removed. Once the fault is removed, the converter automatically recovers and returns to normal operation.

#### Output Overvoltage Protection

Each converter incorporates protection circuitry that continually senses for an output overvoltage (OV) condition. The OV threshold is set approximately 20% higher than the nominal output voltage. If the converter output voltage exceeds this threshold, the converter is immediately shut down and remains in a latched-off state. To resume normal operation the converter must be actively reset. This can only be done by momentarily removing the input power to the converter. For fail-safe operation and redundancy, the OV protection uses circuitry that is independent of the converter's internal feedback loop.

#### Overtemperature Protection

Overtemperature protection is provided by an internal temperature sensor, which closely monitors the temperature of the converter's printed circuit board (PCB). If the sensor exceeds a temperature of approximately 105°C, the converter will shut down. The converter will then automatically restart when the sensed temperature drops back to approximately 95°C. When operated outside its recommended thermal derating envelope (see data sheet SOA curves), the converter will typically cycle on and off at intervals from a few seconds to one or two minutes. This is to ensure that the internal components are not permanently damaged from excessive thermal stress.

#### Undervoltage Lockout

The Undervoltage lockout (UVLO) is designed to prevent the operation of the converter until the input voltage is at the minimum input voltage. This prevents high start-up current during normal power-up of the converter, and minimizes the current drain from the input source during low input voltage conditions. The UVLO circuitry also overrides the operation of the *Remote On/Off* control.

#### Primary-Secondary Isolation

These converters incorporate electrical isolation between the input terminals (primary) and the output terminals (secondary). All converters are production tested to a withstand voltage of 1500 VDC. This specification complies with UL60950 and EN60950 requirements. This allows the converter to be configured for either a positive or negative input voltage source. The data sheet *Pin Descriptions* section provides guidance as to the correct reference that must be used for the external control signals.

#### Input Current Limiting

The converter is not internally fused. For safety and overall system protection, the maximum input current to the converter must be limited. Active or passive current limiting can be used. Passive current limiting can be a fast acting fuse. A 125-V fuse, rated no more than 10 A, is recommended. Active current limiting can be implemented with a current limited *Hot-Swap* controller.

#### Thermal Considerations

Airflow may be necessary to ensure that the module can supply the desired load current in environments with elevated ambient temperatures. The required airflow rate may be determined from the Safe Operating Area (SOA) thermal derating chart (see typical characteristics).

### Differential Remote Sense

The remote sense pins allows the converter to precisely regulate the DC output voltage at a remote location. This might be a power plane on an inner layer of the host PCB. *Connecting Sense(+)* directly to  $+V_O$ , and *Sense(-)* to  $-V_O$  will improve output voltage accuracy. In the event that the sense pins are left open-circuit, an internal 10- $\Omega$  resistor between each sense pin and its corresponding output prevents an excessive rise in the output voltage. For practical reasons, the amount of IR voltage compensation should be limited to 0.5 V maximum.

The remote sense feature is designed to compensate for limited amounts of IR voltage drop. It is **not** intended to compensate for the forward drop of a non-linear or frequency dependent components that may be placed in series with the converter output. Examples of such components include OR-ing diodes, filter inductors, ferrite beads, and fuses. Enclosing these components with the remote sense connections effectively places them inside the regulation control loop, which can affect the stability of the regulator.

## Using the Remote On/Off Function on the PTQA Series of DC/DC Converters

For applications requiring output voltage On/Off control, the PTQA series of DC/DC converters incorporate a *Remote On/Off* control (pin 2). This feature can be used to switch the module off without removing the applied input source voltage. When placed in the *Off* state, the standby current drawn from the input source is typically reduced to 3 mA.

### Negative Output Enable (NEN)

Models using the negative enable option, the *Remote On/Off* (pin 2) control must be driven to a logic low voltage for the converter to produce an output. This is accomplished by either permanently connecting pin 2 to  $-V_I$  (pin 3), or driving it low with an external control signal. Table 2 shows the input requirements of pin 2 for those modules with the *NEN* option.

**Table 2. On/Off Control Requirements for Negative Enable**

PARAMETER		MIN	TYP	MAX
$V_{IH}$	Disable	2.4 V		20 V
$V_{IL}$	Enable	-0.2 V		0.8 V
$V_{o/c}$	Open-Circuit		9 V	15 V
$I_I$	Pin 2 at $-V_I$			-0.75 mA

### Positive Output Enable (PEN)

For those models with the positive enable (PEN) option, leaving pin 2 open circuit, (or driving it to an equivalent logic high voltage), will enable the converter output. This allows the module to produce an output voltage whenever a valid input source voltage is applied to  $+V_I$  with respect to  $-V_I$ . If a logic-low signal is then applied to pin 2 the converter output is disabled. Table 3 gives the input requirements of pin 2 for modules with the *PEN* option.

**Table 3. On/Off Control Requirements for Positive Enable**

PARAMETER		MIN	TYP	MAX
$V_{IH}$	Enable	4.5 V		20 V
$V_{IL}$	Disable	-0.2 V		0.8 V
$V_{o/c}$	Open-Circuit		5 V	7 V
$I_I$	Pin 2 at $-V_I$			-0.5 mA

#### Notes:

1. The *Remote On/Off* control uses  $-V_I$  (pin 3) as its ground reference. All voltages are with respect to  $-V_I$ .
2. An open-collector device (preferably a discrete transistor) is recommended. A pull-up resistor is not required. If one is added the pull-up voltage should not exceed 20 V.

**Caution:** Do not use a pull-resistor to  $+V_I$  (pin 1). The remote On/Off control has a maximum input voltage of 20 V. Exceeding this voltage will overstress, and possibly damage, the converter.

3. The *Remote On/Off* pin may be controlled with devices that have a totem-pole output. This is provided the output high level voltage ( $V_{OH}$ ) meets the module's minimum  $V_{IH}$  specified in Table 2. If a TTL gate is used, a pull-up resistor may be required to the logic supply voltage.
4. The converter incorporates an *undervoltage lockout* (UVLO). The UVLO keeps the converter off until the input voltage is close to the minimum specified operating voltage. This is regardless of the state of the *Remote On/Off* control. Consult the product specification for the UVLO input voltage thresholds.

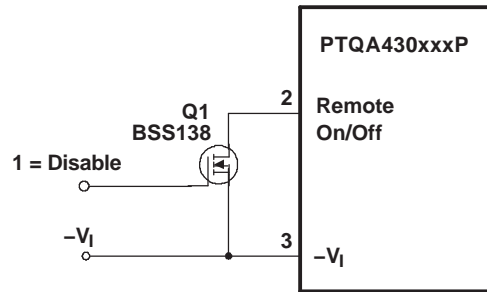
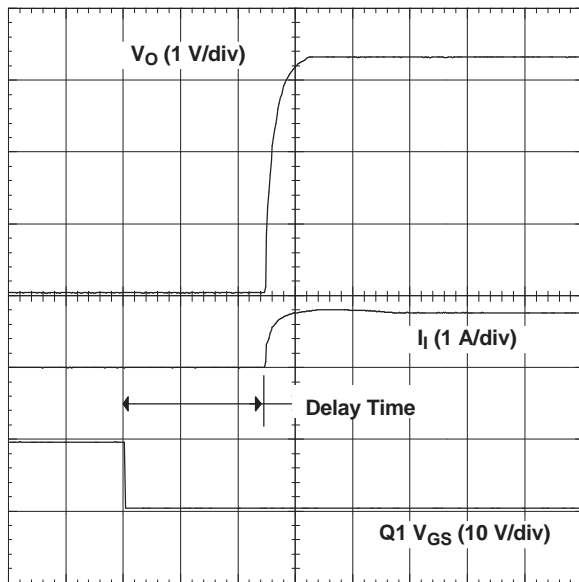

Figure 13. Recommended Control or Remote On/Off Input

**Turn-On:** With a valid input source voltage applied, the converter produces a regulated output voltage within 75 ms of the output being enabled. Figure 14 shows the output response of the PTQA430033P following the removal of the logic-low signal from the *Remote On/Off* (pin 2); see Figure 13. This corresponds to the drop in Q1  $V_{GS}$  in Figure 14. Although the rise-time of the output voltage is short (<10 ms), the indicated delay time will vary depending upon the input voltage and the module’s internal timing. The waveforms were measured with 48 VDC input voltage, and a 10-A resistive load.

**Turn-Off Time:** When a valid input source is removed or if the *Remote On/Off* (pin 2) is used to disable the output, with no external output capacitance, the module powers down within 200  $\mu$ s. Figure 15 shows that, during power down, there is a small undershoot, typically less than 300 mV (or less than a diode drop). If used to supply processor I/O voltages, the low undershoot ensures the parasitic diodes do not conduct current and potentially cause damage to external circuitry.



t – Time – 5 ms/div

Figure 14. Power Up

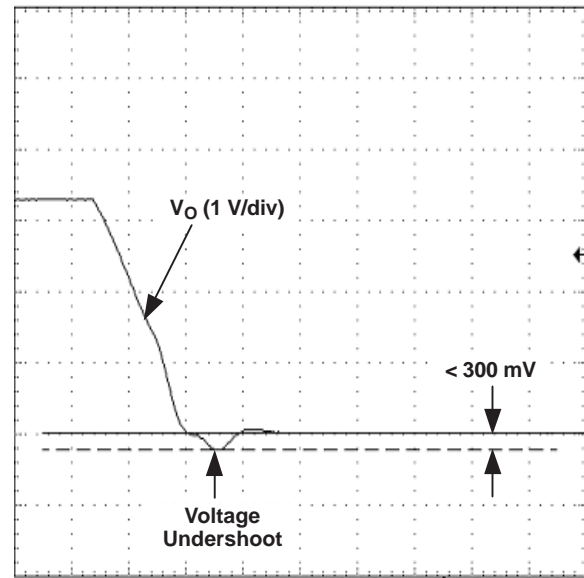

t – Time – 100  $\mu$ s/div

Figure 15. Power Down

### Adjusting the Output Voltage of the 100-W Rated PTQA Series of Isolated DC/DC Converters

The output voltage adjustment of the PTQA series of isolated DC/DC converters follows the standard adopted by popular 1/4-brick DC/DC converters. Adjustment is accomplished with a single external resistor that can adjust the output voltage from -20% to +10% of the nominal set-point voltage. The placement of the resistor determines the direction of adjustment, up or down, and the value of the magnitude of adjustment.

**Adjust Up:** To increase the output voltage add a resistor, R1, between  $V_O$  Adjust (pin 6) and Sense(+) (pin 7).

**Adjust Down:** Add a resistor, (R2), between  $V_O$  Adjust (pin 6) and Sense(-) (pin 5).

Refer to [Figure 16](#) for the placement of the required resistor, R1 or (R2).

The values of R1 [adjust up], and (R2) [adjust down], can be calculated using the following formulas or selected from [Table 4](#).

$$R1 = \frac{5.11 V_O (100 + \Delta\%)}{1.225 \Delta\%} - \frac{511}{\Delta\%} - 10.22 \text{ (k}\Omega\text{)} \tag{1}$$

$$(R2) = 5.11 \frac{100}{\Delta\%} - 10.22 \text{ (k}\Omega\text{)} \tag{2}$$

Where:

$\Delta\%$  = Amount of adjustment in %

$V_O$  = Original set-point voltage

**Notes:**

1. Use only a single 1% resistor in either the R1 or (R2) location. Place the resistor as close to the converter as possible.
2. If the output voltage is increased, the maximum load current must be derated according to the following equation.

$$I_O(\text{max}) = \frac{V_O \times I_O(\text{rated})}{V_A} \tag{3}$$

Where:

$V_O$  = Original set-point voltage

$V_A$  = Adjusted output voltage (measured between pins 8 and 4)

In any instance, the load current must not exceed the converter's maximum rated output current of 30 A.

3. The overvoltage threshold is fixed, and is set approximately 20% above the nominal output voltage. Adjusting the output voltage higher reduces the voltage margin between the adjusted output voltage and the overvoltage (OV) protection threshold. This could make the module sensitive to OV fault detection, as a result of random noise and load transients.

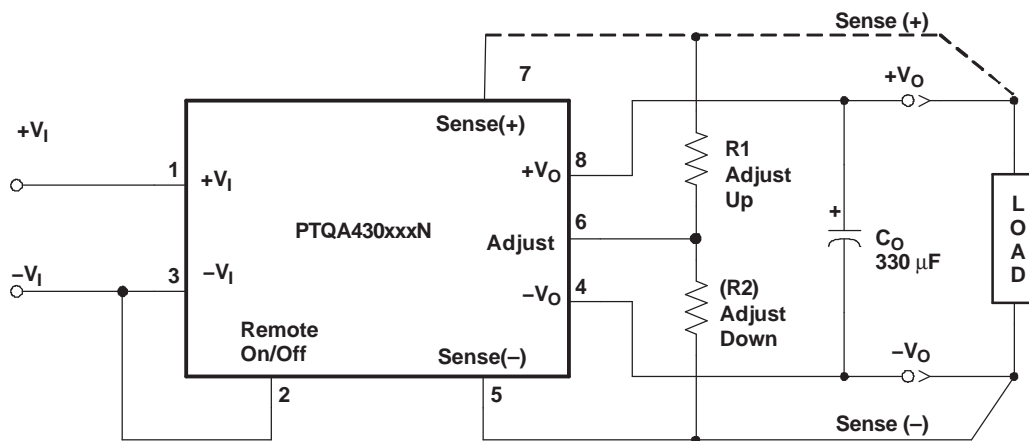

Figure 16.

**Table 4. Standard Adjustment Resistor Values**

V <sub>O</sub> (nom) % Adjust (V)	Adjusted Output Voltage (V)			Trim-Up R <sub>ADJ</sub>			Trim-Down R <sub>ADJ</sub>		
	5.0 V	3.3 V	2.5 V	5.0 V R1 (kΩ)	3.3 V R1 (kΩ)	2.5 V R1 (kΩ)	5.0 V R2 (kΩ)	3.3 V R2 (kΩ)	2.5 V R2 (kΩ)
+10	5.50	3.630	2.750	169	90.9	53.6	-	-	-
+9	5.45	3.597	2.725	187	100	59.0	-	-	-
+8	5.40	3.564	2.700	205	113	66.5	-	-	-
+7	5.35	3.531	2.675	237	127	76.8	-	-	-
+6	5.30	3.498	2.650	274	147	88.7	-	-	-
+5	5.25	3.465	2.625	324	178	107	-	-	-
+4	5.20	3.432	2.600	402	221	133	-	-	-
+3	5.15	3.399	2.575	536	294	178	-	-	-
+2	5.10	3.366	2.550	787	432	267	-	-	-
+1	5.05	3.333	2.525	1580	866	536	-	-	-
0	5.00	3.300	2.500	Open	Open	Open	-	-	-
-1	4.95	3.267	2.475	-	-	-	499	499	499
-2	4.90	3.234	2.450	-	-	-	243	243	243
-3	4.85	3.201	2.425	-	-	-	158	158	158
-4	4.80	3.168	2.400	-	-	-	118	118	118
-5	4.75	3.135	2.375	-	-	-	90.9	90.9	90.9
-6	4.70	3.102	2.350	-	-	-	75	75	75
-7	4.65	3.069	2.325	-	-	-	63.4	63.4	63.4
-8	4.60	3.036	2.300	-	-	-	53.6	53.6	53.6
-9	4.55	3.003	2.275	-	-	-	46.4	46.4	46.4
-10	4.50	2.970	2.250	-	-	-	41.2	41.2	41.2
-11	4.45	2.937	2.225	-	-	-	36.5	36.5	36.5
-12	4.40	2.904	2.200	-	-	-	32.4	32.4	32.4
-13	4.35	2.871	2.175	-	-	-	28.7	28.7	28.7
-14	4.30	2.838	2.150	-	-	-	26.1	26.1	26.1
-15	4.25	2.805	2.125	-	-	-	23.7	23.7	23.7
-16	4.20	2.772	2.100	-	-	-	21.5	21.5	21.5
-17	4.15	2.739	2.075	-	-	-	19.6	19.6	19.6
-18	4.10	2.706	2.050	-	-	-	18.2	18.2	18.2
-19	4.05	2.673	2.025	-	-	-	16.5	16.5	16.5
-20	4.00	2.640	2.000	-	-	-	15.4	15.4	15.4

**PACKAGING INFORMATION**

Orderable part number	Status (1)	Material type (2)	Package   Pins	Package qty   Carrier	RoHS (3)	Lead finish/ Ball material (4)	MSL rating/ Peak reflow (5)	Op temp (°C)	Part marking (6)
PTQA420050N2AD	NRND	Production	Through-Hole Module (EAP)   8	9   TIW TRAY	In-Work	SN	N/A for Pkg Type	-40 to 85	
PTQA420050N2AS	NRND	Production	Surface Mount Module (EAQ)   8	9   TIW TRAY	No	SNPB	Level-1-235C-UNLIM/ Level-3-260C-168HRS	-40 to 85	
PTQA420050N2AZ	NRND	Production	Surface Mount Module (BAQ)   8	9   TIW TRAY	In-Work	SNAGCU	Level-3-260C-168 HR	-40 to 85	
PTQA420050P2AD	NRND	Production	Through-Hole Module (EAP)   8	9   TIW TRAY	In-Work	SN	N/A for Pkg Type	-40 to 85	
PTQA420050P2AS	NRND	Production	Surface Mount Module (EAQ)   8	9   TIW TRAY	No	SNPB	Level-1-235C-UNLIM/ Level-3-260C-168HRS	-40 to 85	
PTQA420050P2AZ	NRND	Production	Surface Mount Module (BAQ)   8	9   TIW TRAY	In-Work	SNAGCU	Level-3-260C-168 HR	-40 to 85	
PTQA430033N2AD	NRND	Production	Through-Hole Module (EAP)   8	9   TIW TRAY	In-Work	SN	N/A for Pkg Type	-40 to 85	

<sup>(1)</sup> **Status:** For more details on status, see our [product life cycle](#).

<sup>(2)</sup> **Material type:** When designated, preproduction parts are prototypes/experimental devices, and are not yet approved or released for full production. Testing and final process, including without limitation quality assurance, reliability performance testing, and/or process qualification, may not yet be complete, and this item is subject to further changes or possible discontinuation. If available for ordering, purchases will be subject to an additional waiver at checkout, and are intended for early internal evaluation purposes only. These items are sold without warranties of any kind.

<sup>(3)</sup> **RoHS values:** Yes, No, RoHS Exempt. See the [TI RoHS Statement](#) for additional information and value definition.

<sup>(4)</sup> **Lead finish/Ball material:** Parts may have multiple material finish options. Finish options are separated by a vertical ruled line. Lead finish/Ball material values may wrap to two lines if the finish value exceeds the maximum column width.

<sup>(5)</sup> **MSL rating/Peak reflow:** The moisture sensitivity level ratings and peak solder (reflow) temperatures. In the event that a part has multiple moisture sensitivity ratings, only the lowest level per JEDEC standards is shown. Refer to the shipping label for the actual reflow temperature that will be used to mount the part to the printed circuit board.

<sup>(6)</sup> **Part marking:** There may be an additional marking, which relates to the logo, the lot trace code information, or the environmental category of the part.

Multiple part markings will be inside parentheses. Only one part marking contained in parentheses and separated by a "~" will appear on a part. If a line is indented then it is a continuation of the previous line and the two combined represent the entire part marking for that device.



**Important Information and Disclaimer:** The information provided on this page represents TI's knowledge and belief as of the date that it is provided. TI bases its knowledge and belief on information provided by third parties, and makes no representation or warranty as to the accuracy of such information. Efforts are underway to better integrate information from third parties. TI has taken and continues to take reasonable steps to provide representative and accurate information but may not have conducted destructive testing or chemical analysis on incoming materials and chemicals. TI and TI suppliers consider certain information to be proprietary, and thus CAS numbers and other limited information may not be available for release.

In no event shall TI's liability arising out of such information exceed the total purchase price of the TI part(s) at issue in this document sold by TI to Customer on an annual basis.

BAQ (R-PDSS-B8)

DOUBLE SIDED MODULE

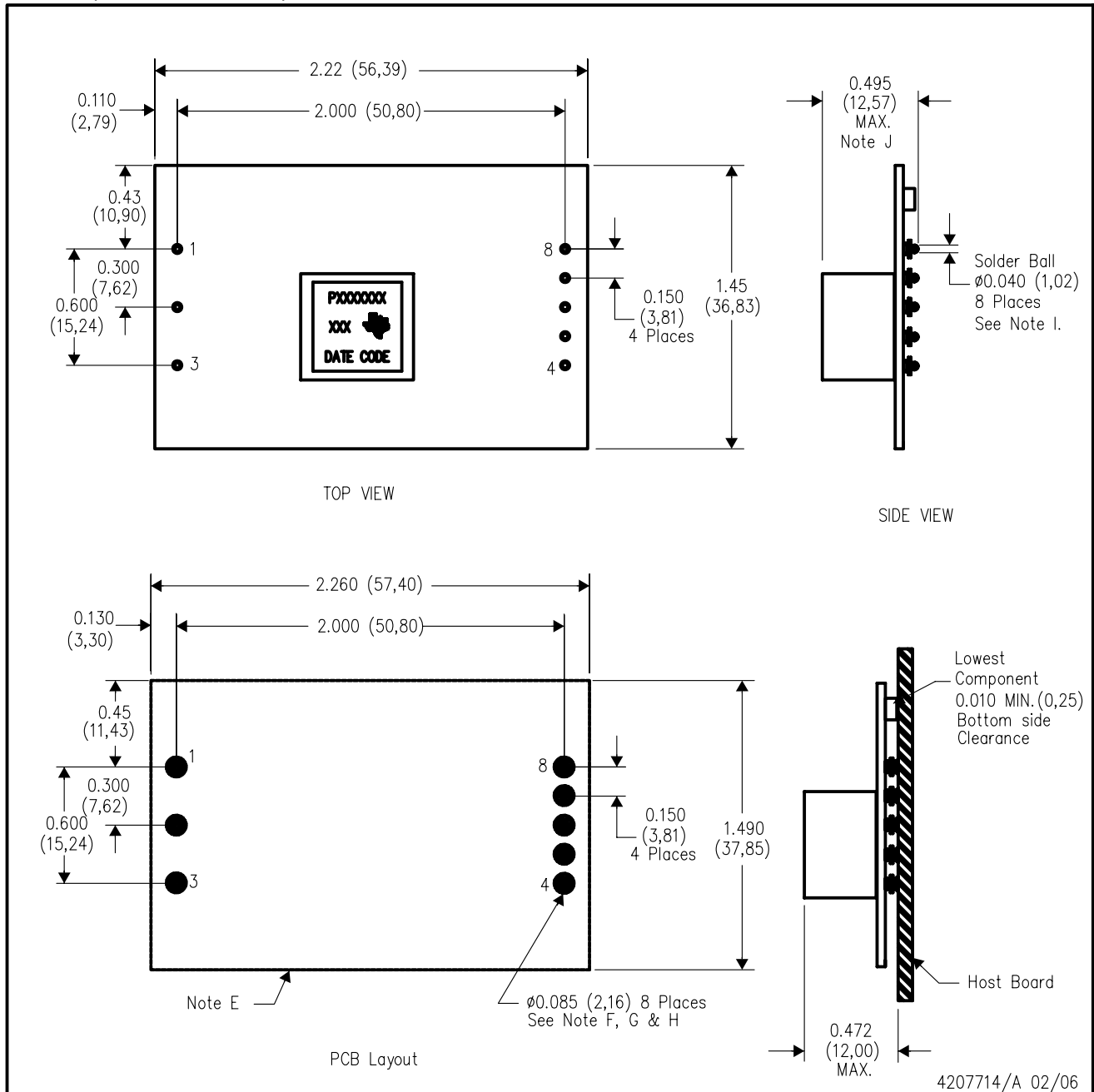

- NOTES:
- A. All linear dimensions are in inches (mm).
  - B. This drawing is subject to change without notice.
  - C. 2 place decimals are  $\pm 0.020$  ( $\pm 0,51$ mm).
  - D. 3 place decimals are  $\pm 0.010$  ( $\pm 0,25$ mm).
  - E. Recommended keep out area for user components.
  - F. Power pin connection should utilize four or more vias to the interior power plane of 0.025 (0,63) I.D. per input, ground and output pin (or the electrical equivalent).

- G. Paste screen opening: 0.080 (2,03) to 0.085 (2,16).  
Paste screen thickness: 0.006 (0,15).
- H. Pad type: Solder mask defined.
- I. All pins: Material – Copper Alloy  
Finish – Tin (100%) over Nickel plate  
Solder Ball – 96.5 Sn/3.0 Ag/0.5 Cu
- J. Dimension prior to reflow solder.

EAP (R-PDSS-T8)

DOUBLE SIDED MODULE

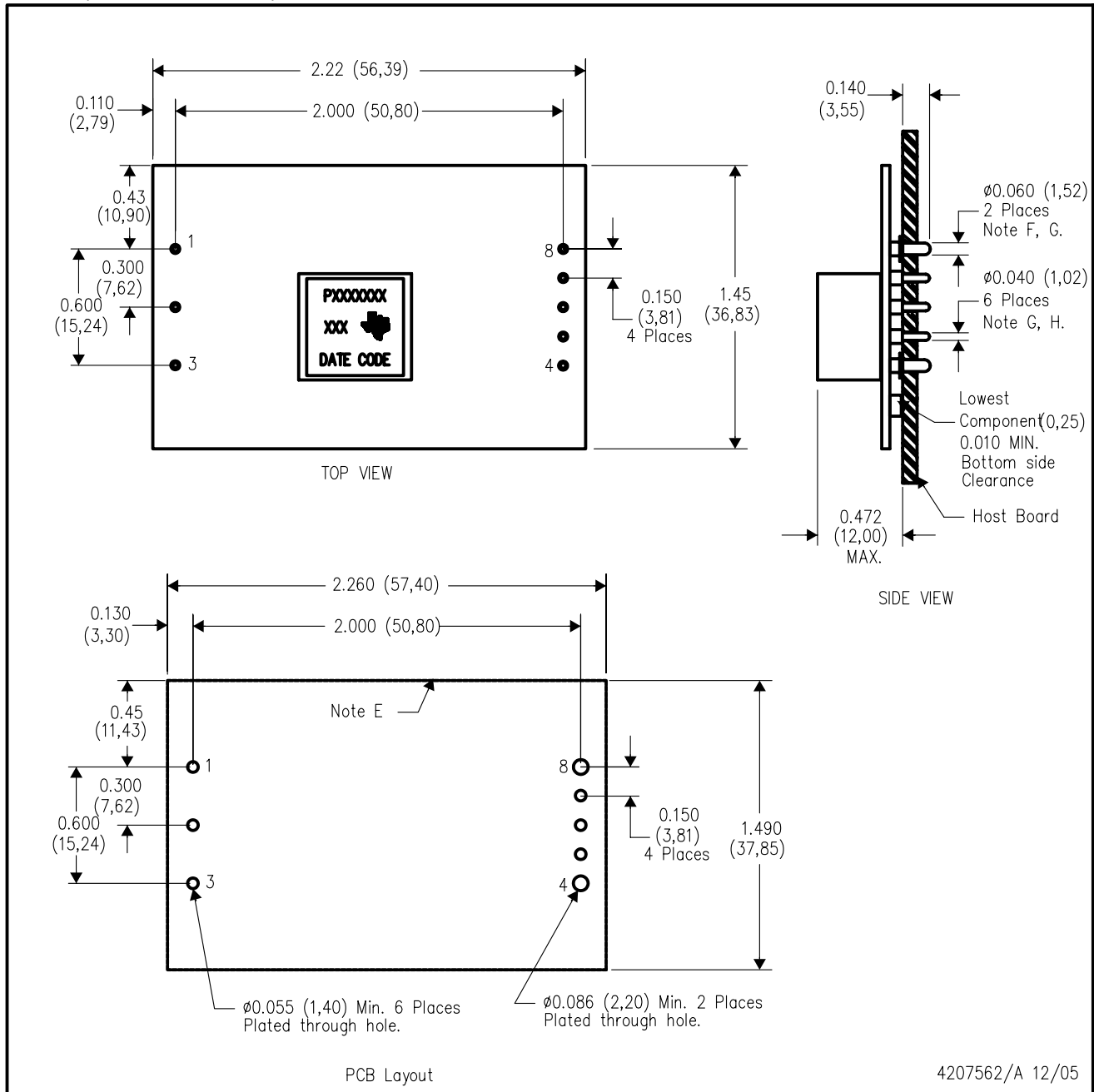

- NOTES:
- A. All linear dimensions are in inches (mm).
  - B. This drawing is subject to change without notice.
  - C. 2 place decimals are  $\pm 0.020$  ( $\pm 0,51$ mm).
  - D. 3 place decimals are  $\pm 0.010$  ( $\pm 0,25$ mm).
  - E. Recommended keep out area for user components.

- F. Pins are 0.060" (1,52) diameter with 0.125" (3,20) diameter standoff shoulder.
- G. All pins: Material - Copper Alloy  
Finish - Tin (100%) over Nickel plate
- H. Pins are 0.040" (1,02) diameter with 0.070" (1,78) diameter standoff shoulder.

EAQ (R-PDSS-B8)

DOUBLE SIDED MODULE

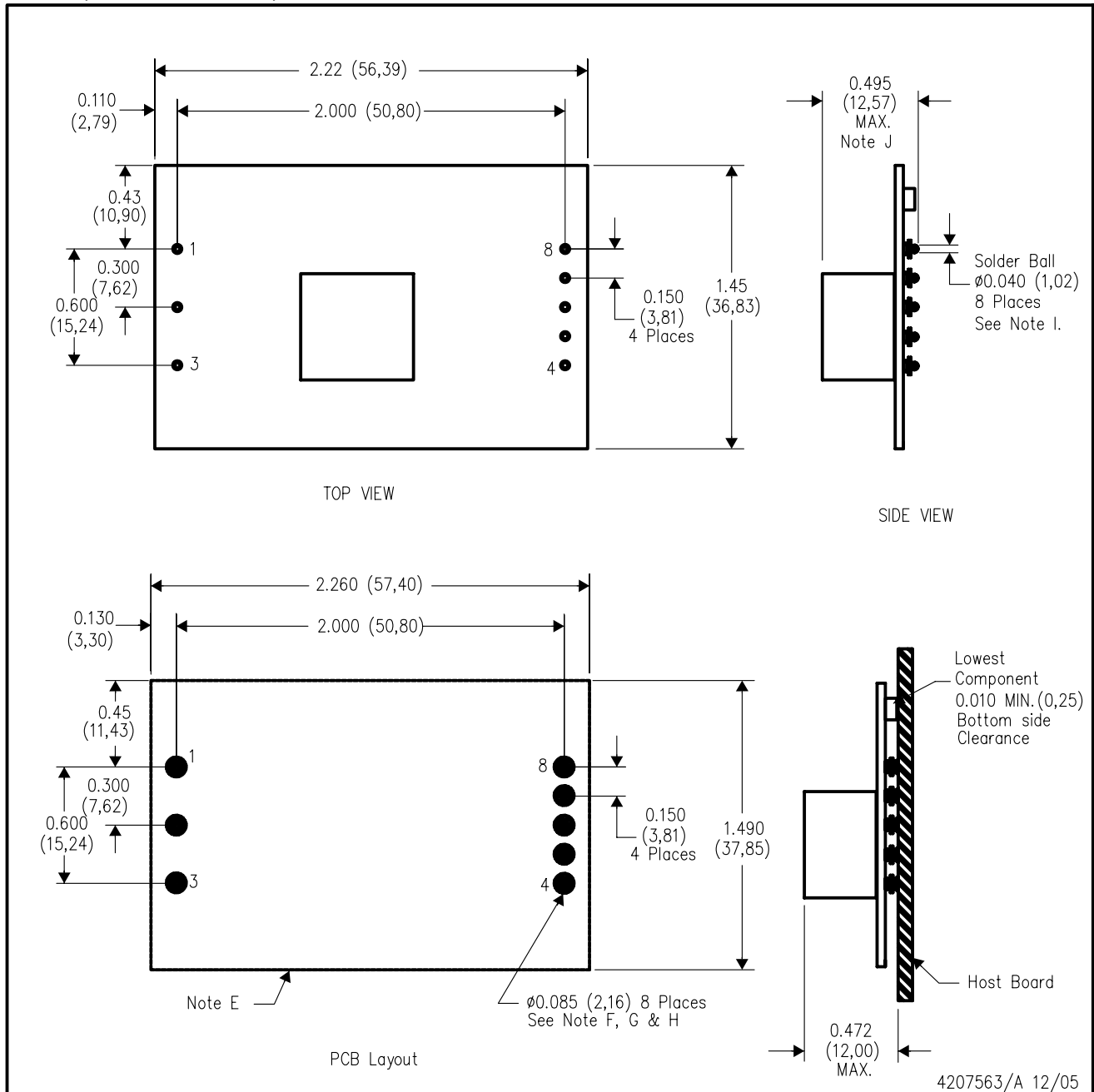

- NOTES:
- A. All linear dimensions are in inches (mm).
  - B. This drawing is subject to change without notice.
  - C. 2 place decimals are  $\pm 0.020$  ( $\pm 0,51$ mm).
  - D. 3 place decimals are  $\pm 0.010$  ( $\pm 0,25$ mm).
  - E. Recommended keep out area for user components.
  - F. Power pin connection should utilize four or more vias to the interior power plane of 0.025 (0,63) I.D. per input, ground and output pin (or the electrical equivalent).

- G. Paste screen opening: 0.080 (2,03) to 0.085 (2,16).  
Paste screen thickness: 0.006 (0,15).
- H. Pad type: Solder mask defined.
- I. All pins: Material – Copper Alloy  
Finish – Tin (100%) over Nickel plate  
Solder Ball – See product data sheet.
- J. Dimension prior to reflow solder.

## IMPORTANT NOTICE AND DISCLAIMER

TI PROVIDES TECHNICAL AND RELIABILITY DATA (INCLUDING DATA SHEETS), DESIGN RESOURCES (INCLUDING REFERENCE DESIGNS), APPLICATION OR OTHER DESIGN ADVICE, WEB TOOLS, SAFETY INFORMATION, AND OTHER RESOURCES "AS IS" AND WITH ALL FAULTS, AND DISCLAIMS ALL WARRANTIES, EXPRESS AND IMPLIED, INCLUDING WITHOUT LIMITATION ANY IMPLIED WARRANTIES OF MERCHANTABILITY, FITNESS FOR A PARTICULAR PURPOSE OR NON-INFRINGEMENT OF THIRD PARTY INTELLECTUAL PROPERTY RIGHTS.

These resources are intended for skilled developers designing with TI products. You are solely responsible for (1) selecting the appropriate TI products for your application, (2) designing, validating and testing your application, and (3) ensuring your application meets applicable standards, and any other safety, security, regulatory or other requirements.

These resources are subject to change without notice. TI grants you permission to use these resources only for development of an application that uses the TI products described in the resource. Other reproduction and display of these resources is prohibited. No license is granted to any other TI intellectual property right or to any third party intellectual property right. TI disclaims responsibility for, and you will fully indemnify TI and its representatives against, any claims, damages, costs, losses, and liabilities arising out of your use of these resources.

TI's products are provided subject to [TI's Terms of Sale](#) or other applicable terms available either on [ti.com](https://www.ti.com) or provided in conjunction with such TI products. TI's provision of these resources does not expand or otherwise alter TI's applicable warranties or warranty disclaimers for TI products.

TI objects to and rejects any additional or different terms you may have proposed.

Mailing Address: Texas Instruments, Post Office Box 655303, Dallas, Texas 75265  
Copyright © 2025, Texas Instruments Incorporated