

# REF35 Ultra Low-Power, High-Precision Voltage Reference

## 1 Features

- Ultra-low quiescent current:
  - 650 nA (typical)
- Initial accuracy:  $\pm 0.05\%$  (maximum)
- Temperature coefficient:
  - 12 ppm/°C (maximum for  $-40^{\circ}\text{C}$  to  $105^{\circ}\text{C}$ )
- Output 1/f noise (0.1 Hz to 10 Hz): 3.3 ppm<sub>p-p</sub>
- NR pin to reduce noise
- EN pin to reduce shutdown current consumption
- Long-term stability: 40 ppm at 1k hour
- Thermal hysteresis: 70 ppm
- Specified temperature range:  $-40^{\circ}\text{C}$  to  $+105^{\circ}\text{C}$
- Operating temperature range:  $-55^{\circ}\text{C}$  to  $+125^{\circ}\text{C}$
- Output current: +10 mA, -5 mA
- Input voltage:  $V_{\text{REF}} + V_{\text{DO}}$  to 6 V
- Output voltage options:
  - 1.024 V, 1.2 V, 1.25 V, 1.6 V, 1.8 V, 2.048 V, 2.5 V, 3.0 V, 3.3 V, 4.096 V, 5.0 V
- Small footprint 6-pin SOT-23 package
- Smallest footprint 4-pin WCSP package

## 2 Applications

- [Flow transmitter](#)
- [Blood glucose monitor](#)
- [Servo drive control module](#)
- [Power quality analyzer](#)
- [Fault indicator](#)
- [Oscilloscope](#)
- [Process analytics](#)
- [Optical Module](#)

## 3 Description

The REF35 is a family of nanopower, low-drift, high-precision series reference devices. The REF35 family features  $\pm 0.05\%$  initial accuracy with 650 nA typical power consumption. The temperature coefficient (12 ppm/°C) and long-term stability (40 ppm at 1000 hours) of the device can help improve system stability and reliability. The low power consumption combined with high precision specifications are suitable for wide variety of portable and low current applications.

The REF35 supplies up to 10 mA current with 3.3 ppm<sub>p-p</sub> noise and 20 ppm/mA load regulation. With this feature set, REF35 creates a strong low-noise, high accuracy power supply for precision sensors and 12–16b data converters.

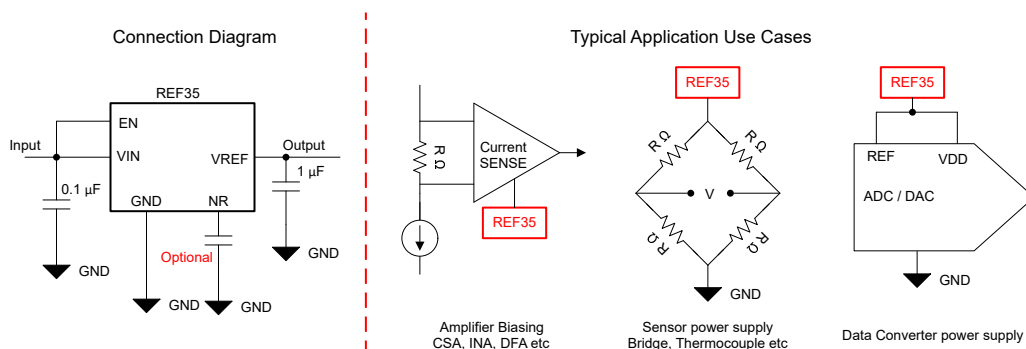
The family is specified for operation from  $-40^{\circ}\text{C}$  to  $105^{\circ}\text{C}$  and is functional over  $-55^{\circ}\text{C}$  to  $125^{\circ}\text{C}$ . The wide temperature is suited for industrial applications.

REF35 is available in wide output voltage variants starting from 1.024 V to 5.0 V. The device is offered in a space-saving, 6-pin SOT-23 and 4-pin WCSP package options. Contact your local TI sales representative for available voltage and package options.

### Package Information

PART NUMBER	PACKAGE <sup>(1)</sup>	BODY SIZE (NOM)
REF35xxx	SOT-23 (6)	2.90 mm × 1.60 mm
	WCSP (4) <sup>(2)</sup>	1.05 mm × 0.84 mm

- (1) For all available voltage variants and packages, see the orderable addendum at the end of the data sheet.
- (2) Product preview.



### REF35 Use Case



## Table of Contents

<b>1 Features</b> .....	<b>1</b>	<b>9 Detailed Description</b> .....	<b>19</b>
<b>2 Applications</b> .....	<b>1</b>	9.1 Overview.....	19
<b>3 Description</b> .....	<b>1</b>	9.2 Functional Block Diagram.....	19
<b>4 Revision History</b> .....	<b>2</b>	9.3 Feature Description.....	19
<b>5 Device Comparison</b> .....	<b>3</b>	9.4 Device Functional Modes .....	20
<b>6 Pin Configuration and Functions</b> .....	<b>3</b>	<b>10 Application and Implementation</b> .....	<b>22</b>
<b>7 Specifications</b> .....	<b>4</b>	10.1 Application Information.....	22
7.1 Absolute Maximum Ratings.....	4	10.2 Typical Applications.....	22
7.2 ESD Ratings.....	4	10.3 Power Supply Recommendations.....	25
7.3 Recommended Operating Conditions.....	4	10.4 Layout.....	25
7.4 Thermal Information.....	4	<b>11 Device and Documentation Support</b> .....	<b>27</b>
7.5 Electrical Characteristics.....	5	11.1 Documentation Support.....	27
7.6 Typical Characteristics.....	7	11.2 Receiving Notification of Documentation Updates..	27
<b>8 Parameter Measurement Information</b> .....	<b>12</b>	11.3 Support Resources.....	27
8.1 Solder Heat Shift.....	12	11.4 Trademarks.....	27
8.2 Temperature Coefficient.....	13	11.5 Electrostatic Discharge Caution.....	27
8.3 Long-Term Stability.....	13	11.6 Glossary.....	27
8.4 Thermal Hysteresis.....	14	<b>12 Mechanical, Packaging, and Orderable Information</b> .....	<b>27</b>
8.5 Noise Performance.....	15		
8.6 Power Dissipation.....	18		

## 4 Revision History

NOTE: Page numbers for previous revisions may differ from page numbers in the current version.

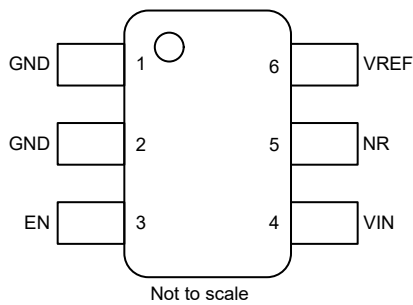
<b>Changes from Revision * (December 2021) to Revision A (August 2022)</b>	<b>Page</b>
• Production data release.....	<b>1</b>

## 5 Device Comparison

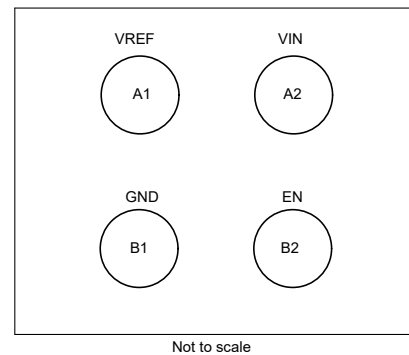
PRODUCT		V <sub>REF</sub>
SOT-23 (6)	WCSP (4) <sup>(1)</sup>	
REF35102QDBVR	REF35102YBHR	1.024 V
REF35120QDBVR	REF35120YBHR	1.2 V
REF35125QDBVR	REF35125YBHR	1.25 V
REF35160QDBVR	REF35160YBHR	1.6 V
REF35180QDBVR	REF35180YBHR	1.8 V
REF35205QDBVR	REF35205YBHR	2.048 V
REF35250QDBVR	REF35250YBHR	2.5 V
REF35300QDBVR	REF35300YBHR	3.0 V
REF35330QDBVR	REF35330YBHR	3.3 V
REF35409QDBVR	REF35409YBHR	4.096 V
REF35500QDBVR	REF35500YBHR	5.0 V

(1) Product preview. Contact local TI support for samples.

## 6 Pin Configuration and Functions



**Figure 6-1. DBV Package  
6-Pin SOT-23  
Top View**



Preview only

**Figure 6-2. YBH Package  
4-Pin WCSP  
Top View**

**Table 6-1. Pin Functions**

NAME	PIN		TYPE	DESCRIPTION
	SOT-23	WCSP		
GND	1	B1	Ground	Device ground connection
GND	2	-	Ground	Device ground connection
EN	3	B2	Input	Enable connection. Enables or disables the device.
VIN	4	A2	Power	Input supply voltage connection
NR	5	-	Output	Noise reduction pin. Connect a capacitor to reduce noise.
VREF	6	A1	Output	Reference voltage output

## 7 Specifications

### 7.1 Absolute Maximum Ratings

over operating free-air temperature range (unless otherwise noted) <sup>(1)</sup>

		MIN	MAX	UNIT
Input voltage	IN	-0.3	6.5	V
Enable voltage	EN	-0.3	IN + 0.3 <sup>(2)</sup>	V
Output voltage	V <sub>REF</sub>	-0.3	IN + 0.3 <sup>(2)</sup>	V
Output short circuit current	I <sub>SC</sub>		20	mA
Operating temperature range	T <sub>A</sub>	-55	125	°C
Storage temperature range	T <sub>stg</sub>	-65	170	°C

- (1) Operation outside the Absolute Maximum Ratings may cause permanent device damage. Absolute Maximum Ratings do not imply functional operation of the device at these or any other conditions beyond those listed under Recommended Operating Conditions. If used outside the Recommended Operating Conditions but within the Absolute Maximum Ratings, the device may not be fully functional, and this may affect device reliability, functionality, performance, and shorten the device lifetime.
- (2) IN + 0.3 V or 6.5 V, whichever is lower

### 7.2 ESD Ratings

			VALUE	UNIT
V <sub>(ESD)</sub>	Electrostatic discharge	Human body model (HBM), per ANSI/ESDA/JEDEC JS-001, all pins <sup>(1)</sup>	±2000	V
		Charged device model (CDM), per ANSI/ESDA/JEDEC JS-002, all pins <sup>(2)</sup>	±750	

- (1) JEDEC document JEP155 states that 500-V HBM allows safe manufacturing with a standard ESD control process.
- (2) JEDEC document JEP157 states that 250-V CDM allows safe manufacturing with a standard ESD control process.

### 7.3 Recommended Operating Conditions

over operating free-air temperature range (unless otherwise noted)

		MIN	NOM	MAX	UNIT
IN	Input voltage <sup>(1)</sup>	V <sub>OUT</sub> + V <sub>DO</sub> <sup>(2)</sup>		6	V
EN	Enable voltage	0		IN	V
I <sub>L</sub>	Output current	-5		10	mA
T <sub>A</sub>	Operating temperature	-40	25	125	°C

- (1) For V<sub>REF</sub> = 1.024 V to 1.5 V, minimum V<sub>IN</sub> = 1.7 V
- (2) V<sub>DO</sub> = Dropout voltage

### 7.4 Thermal Information

THERMAL METRIC <sup>(1)</sup>		REF35	UNIT
		DBV (SOT-23)	
		6 PINS	
R <sub>θJA</sub>	Junction-to-ambient thermal resistance	164.4	°C/W
R <sub>θJC(top)</sub>	Junction-to-case (top) thermal resistance	102.5	°C/W
R <sub>θJB</sub>	Junction-to-board thermal resistance	59.6	°C/W
Ψ <sub>JT</sub>	Junction-to-top characterization parameter	44.0	°C/W
Ψ <sub>JB</sub>	Junction-to-board characterization parameter	59.4	°C/W
R <sub>θJC(bot)</sub>	Junction-to-case (bottom) thermal resistance	N/A	°C/W

- (1) For more information about traditional and new thermal metrics, see the [Semiconductor and IC Package Thermal Metrics](#) application report.

## 7.5 Electrical Characteristics

At  $V_{IN} = V_{REF} + 0.5\text{ V}$ ,  $V_{EN} = V_{IN}$ ,  $C_L = 10\ \mu\text{F}$ ,  $C_{IN} = 0.1\ \mu\text{F}$ ,  $I_L = 0\ \text{mA}$ , minimum and maximum specifications at  $T_A = -40^\circ\text{C}$  to  $125^\circ\text{C}$ , typical specifications  $T_A = 25^\circ\text{C}$ ; unless otherwise noted

PARAMETER		TEST CONDITION		MIN	TYP	MAX	UNIT
<b>ACCURACY AND DRIFT</b>							
	Output voltage accuracy	$T_A = 25^\circ\text{C}$		-0.05		0.05	%
	Output voltage temperature coefficient	$-40^\circ\text{C} \leq T_A \leq 105^\circ\text{C}$				12	ppm/ $^\circ\text{C}$
<b>LINE AND LOAD REGULATION</b>							
$\frac{\Delta V_{REF}}{\Delta V_{IN}}$	Line regulation	$V_{REF} < 2.5\ \text{V}$ ; $V_{IN} = V_{REF} + V_{DO}$ to $V_{INMAX}$ ; $-40^\circ\text{C} \leq T_A \leq 105^\circ\text{C}$			40	160	ppm/V
		$V_{REF} \geq 2.5\ \text{V}$ ; $V_{IN} = V_{REF} + V_{DO}$ to $V_{INMAX}$ ; $-40^\circ\text{C} \leq T_A \leq 105^\circ\text{C}$			40	120	ppm/V
$\Delta V_{REF}/\Delta I_L$	Load regulation	$I_L = 0\ \text{mA}$ to $10\ \text{mA}$ , $V_{IN} = V_{REF} + V_{DO}$	Source		20	60	ppm/mA
		$I_L = 0\ \text{mA}$ to $5\ \text{mA}$ , $V_{IN} = V_{REF} + V_{DO}$	Sink		40	350	ppm/mA
<b>POWER SUPPLY</b>							
$V_{IN}$	Input voltage <sup>(1)</sup>			$V_{REF} + V_{DO}$		6	V
$I_Q$	Quiescent current	Active mode	$T_A = 25^\circ\text{C}$		0.65	0.9	$\mu\text{A}$
			$-40^\circ\text{C} \leq T_A \leq 85^\circ\text{C}$			1.3	
			$-40^\circ\text{C} \leq T_A \leq 125^\circ\text{C}$			2.6	
		Shutdown mode	$T_A = 25^\circ\text{C}$		0.1		
			$-40^\circ\text{C} \leq T_A \leq 125^\circ\text{C}$			0.5	
$V_{EN}$	Enable pin voltage	Active mode (EN = 1 or Float)		$0.7 \times V_{IN}$			V
		Shutdown mode (EN = 0)				$0.3 \times V_{IN}$	
$I_{EN}$	Enable pin current	$V_{EN} = V_{IN}$			0.05	0.1	$\mu\text{A}$
$V_{DO}$	Dropout voltage	$I_L = 5\ \text{mA}$				120	mV
		$I_L = 10\ \text{mA}$				250	
$I_{SC}$	Short circuit current, Sourcing	$V_{REF} = 0\ \text{V}$ , $T_A = 25^\circ\text{C}$			33		mA
$I_{SC}$	Short circuit current, Sinking	$V_{REF} = V_{IN}\ \text{V}$ , $T_A = 25^\circ\text{C}$			21		mA
<b>TURN-ON TIME</b>							
$t_{ON}$	Turn-on time <sup>(2)</sup>	0.1% settling, $C_L = 1\ \mu\text{F}$ , $V_{REF} = 2.5\ \text{V}$			2		ms
<b>NOISE</b>							
$e_n$	Output voltage noise	$f = 10\ \text{Hz}$ to $1\ \text{kHz}$ , $C_L = 1\ \mu\text{F}$			0.7		ppm <sub>rms</sub>
$e_{np-p}$	Low-frequency noise	$f = 0.1\ \text{Hz}$ to $10\ \text{Hz}$ , $V_{REF} \geq 2.5\ \text{V}$			3.8		ppm <sub>p-p</sub>
		$f = 0.1\ \text{Hz}$ to $10\ \text{Hz}$ , $V_{REF} < 2.5\ \text{V}$			3.3		ppm <sub>p-p</sub>
<b>HYSTERESIS AND LONG-TERM STABILITY</b>							
	Long-term stability	0 to 1000h at $35^\circ\text{C}$			40		ppm
	Output voltage hysteresis	$25^\circ\text{C}$ , $-40^\circ\text{C}$ , $105^\circ\text{C}$ , $25^\circ\text{C}$ (cycle 1)			70		ppm
	Output voltage hysteresis	$25^\circ\text{C}$ , $-40^\circ\text{C}$ , $105^\circ\text{C}$ , $25^\circ\text{C}$ (cycle 2)			20		ppm
	Output voltage hysteresis	$25^\circ\text{C}$ , $-40^\circ\text{C}$ , $85^\circ\text{C}$ , $25^\circ\text{C}$ (cycle 1)			50		ppm
	Output voltage hysteresis	$25^\circ\text{C}$ , $-40^\circ\text{C}$ , $85^\circ\text{C}$ , $25^\circ\text{C}$ (cycle 2)			13		ppm
<b>STABLE CAPACITANCE RANGE</b>							
	Input capacitor range				0.1		$\mu\text{F}$

**REF35**

SNAS809A – DECEMBER 2021 – REVISED AUGUST 2022

At  $V_{IN} = V_{REF} + 0.5\text{ V}$ ,  $V_{EN} = V_{IN}$ ,  $C_L = 10\ \mu\text{F}$ ,  $C_{IN} = 0.1\ \mu\text{F}$ ,  $I_L = 0\ \text{mA}$ , minimum and maximum specifications at  $T_A = -40^\circ\text{C}$  to  $125^\circ\text{C}$ , typical specifications  $T_A = 25^\circ\text{C}$ ; unless otherwise noted

PARAMETER		TEST CONDITION	MIN	TYP	MAX	UNIT
	Output capacitor range <sup>(3)</sup>		0.1		10	$\mu\text{F}$

- (1) For  $V_{REF} = 1.024\text{ V}$  to  $1.5\text{ V}$ , minimum  $V_{IN} = 1.7\text{ V}$
- (2) Scales linearly with  $V_{REF}$ .
- (3) ESR for the capacitor  $\leq 400\ \text{m}\Omega$

## 7.6 Typical Characteristics

at  $T_A = 25^\circ\text{C}$ ,  $V_{IN} = V_{EN} = V_{REF} + 0.3\text{ V}$ ,  $I_L = 0\text{ mA}$ ,  $C_L = 10\ \mu\text{F}$ ,  $C_{IN} = 0.1\ \mu\text{F}$  (unless otherwise noted)

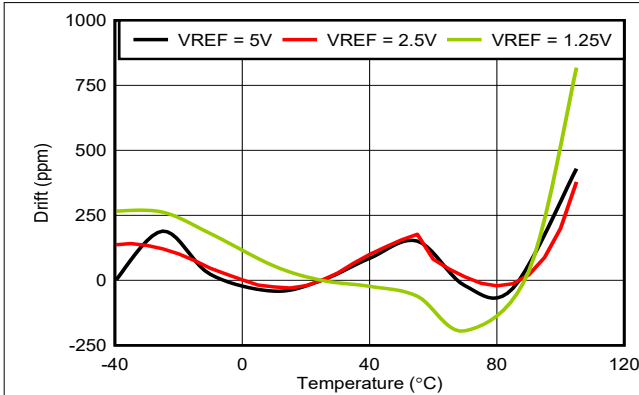


Figure 7-1. Output Voltage Drift vs Free-Air Temperature

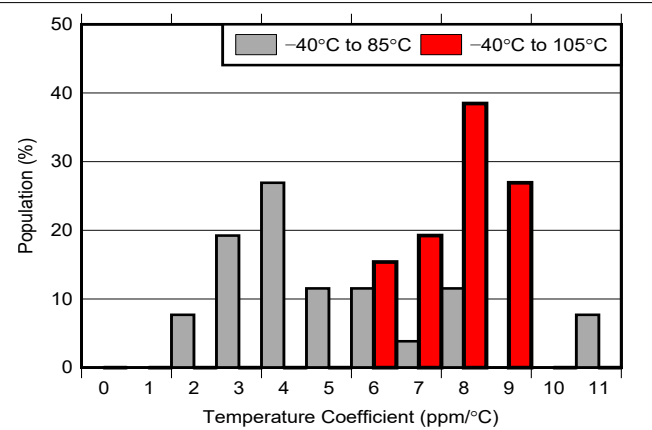


Figure 7-2. Temperature Coefficient Distribution ( $V_{REF} = 1.25\text{ V}$ )

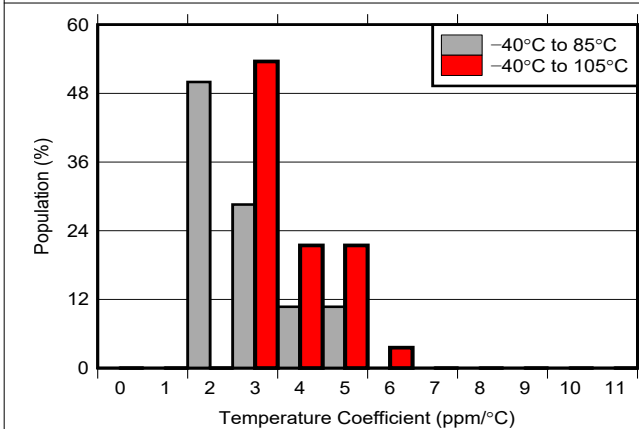


Figure 7-3. Temperature Coefficient Distribution ( $V_{REF} = 2.5\text{ V}$ )

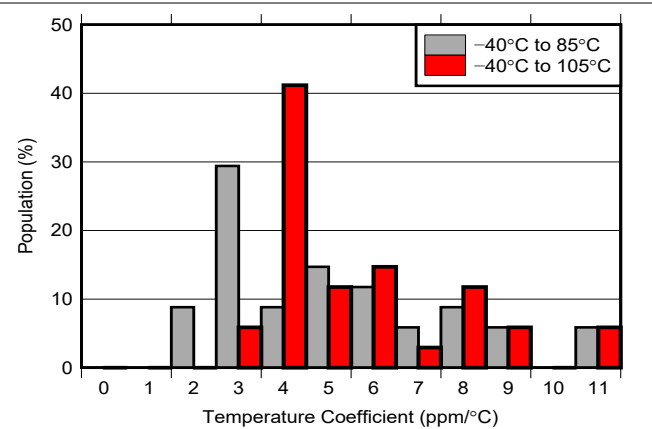


Figure 7-4. Temperature Coefficient Distribution ( $V_{REF} = 5.0\text{ V}$ )

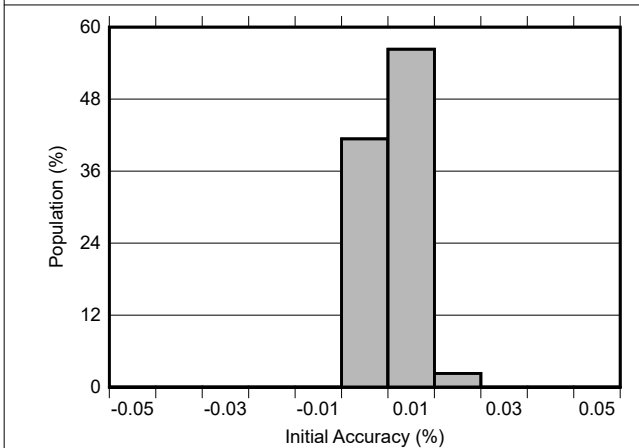


Figure 7-5. Initial Accuracy Distribution

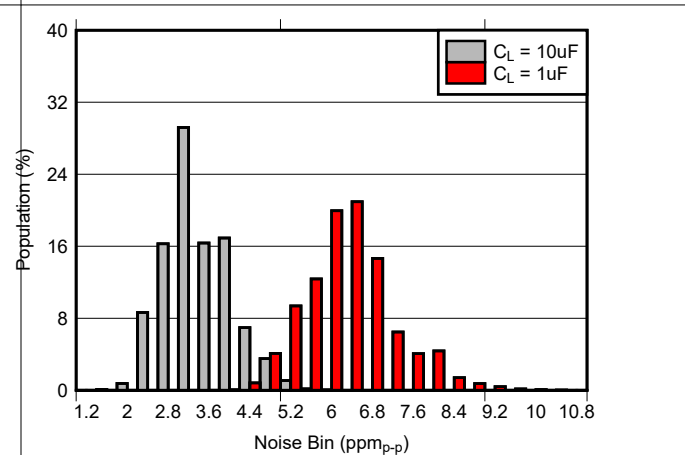
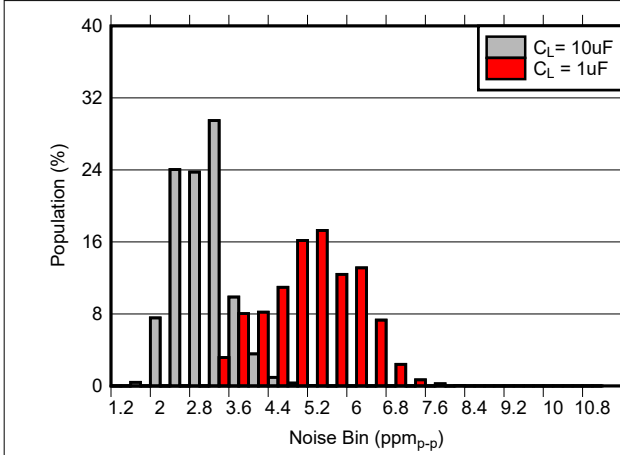


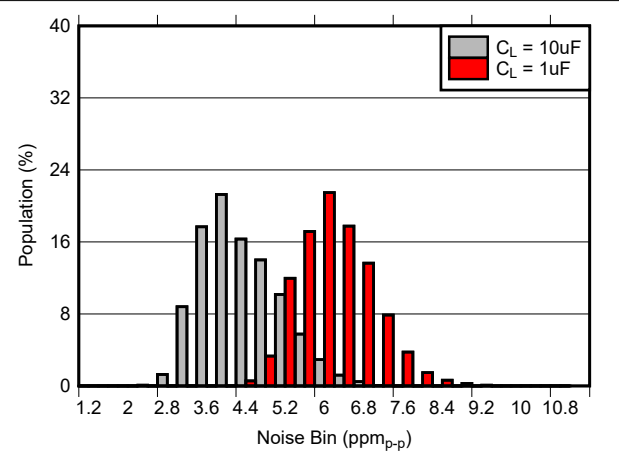
Figure 7-6. 0.1 Hz to 10 Hz Noise Distribution ( $V_{REF} = 1.25\text{ V}$ ,  $C_{NR} = \text{Open}$ ,  $I_L = 0\text{ mA}$ )

## 7.6 Typical Characteristics (continued)

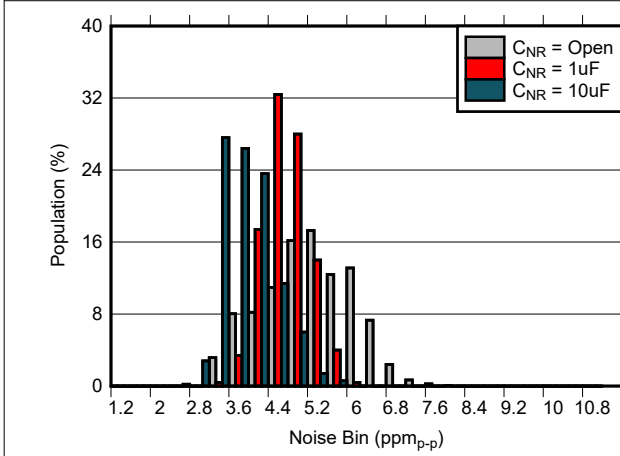
at  $T_A = 25^\circ\text{C}$ ,  $V_{IN} = V_{EN} = V_{REF} + 0.3\text{ V}$ ,  $I_L = 0\text{ mA}$ ,  $C_L = 10\ \mu\text{F}$ ,  $C_{IN} = 0.1\ \mu\text{F}$  (unless otherwise noted)



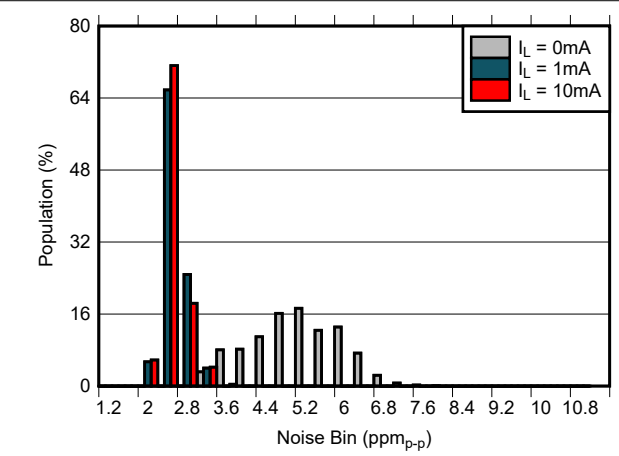
**Figure 7-7. 0.1 Hz to 10 Hz Noise Distribution**  
( $V_{REF} = 2.5\text{ V}$ ,  $C_{NR} = \text{Open}$ ,  $I_L = 0\text{ mA}$ )



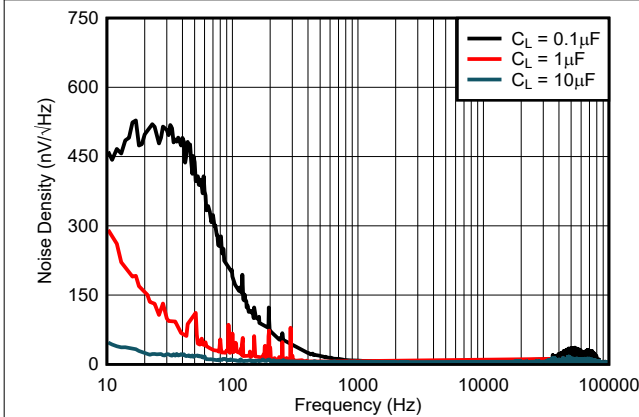
**Figure 7-8. 0.1 Hz to 10 Hz Noise Distribution**  
( $V_{REF} = 5\text{ V}$ ,  $C_{NR} = \text{Open}$ ,  $I_L = 0\text{ mA}$ )



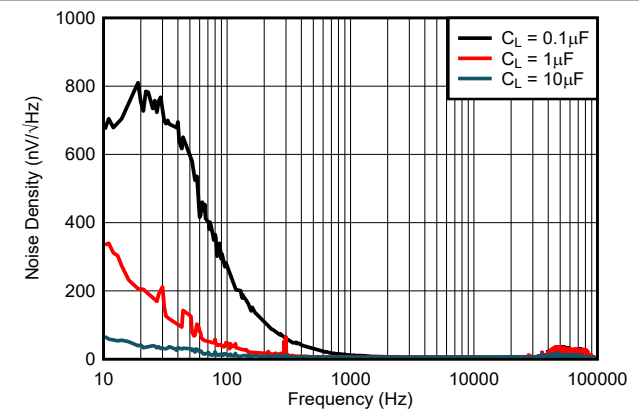
**Figure 7-9. 0.1 Hz to 10 Hz Noise Distribution**  
( $V_{REF} = 2.5\text{ V}$ ,  $C_L = 1\ \mu\text{F}$ ,  $I_L = 0\text{ mA}$ )



**Figure 7-10. 0.1 Hz to 10 Hz Noise Distribution**  
( $V_{REF} = 2.5\text{ V}$ ,  $C_L = 1\ \mu\text{F}$ ,  $C_{NR} = \text{Open}$ )



**Figure 7-11. Noise Density vs Frequency**  
( $V_{REF} = 1.25\text{ V}$ ,  $I_L = 0\text{ mA}$ )

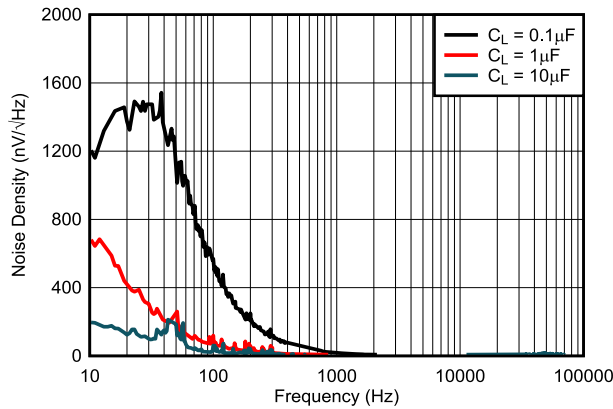


**Figure 7-12. Noise Density vs Frequency**  
( $V_{REF} = 2.5\text{ V}$ ,  $I_L = 0\text{ mA}$ )

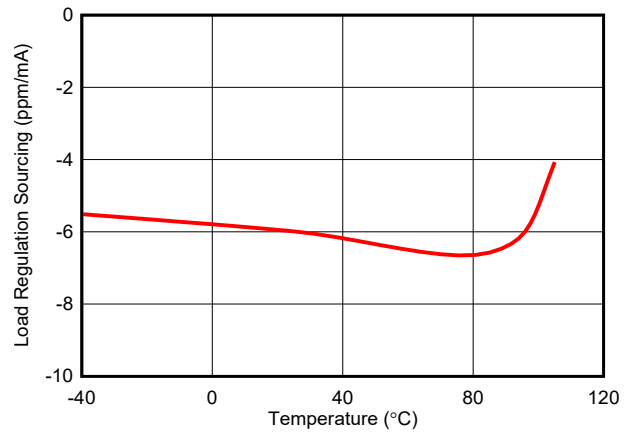


## 7.6 Typical Characteristics (continued)

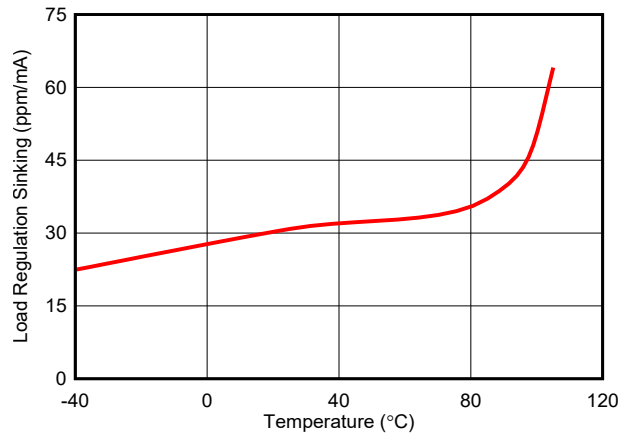
at  $T_A = 25^\circ\text{C}$ ,  $V_{IN} = V_{EN} = V_{REF} + 0.3\text{ V}$ ,  $I_L = 0\text{ mA}$ ,  $C_L = 10\ \mu\text{F}$ ,  $C_{IN} = 0.1\ \mu\text{F}$  (unless otherwise noted)



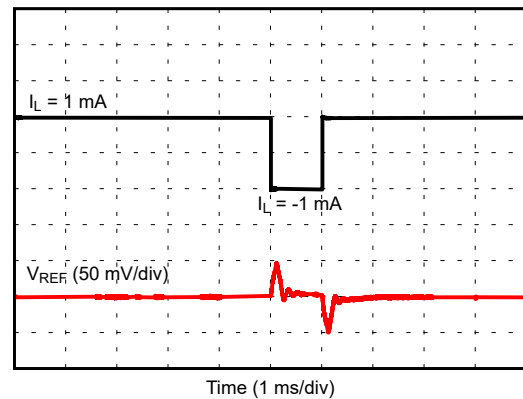
**Figure 7-13. Noise Density vs Frequency**  
( $V_{REF} = 5\text{ V}$ ,  $I_L = 0\text{ mA}$ )



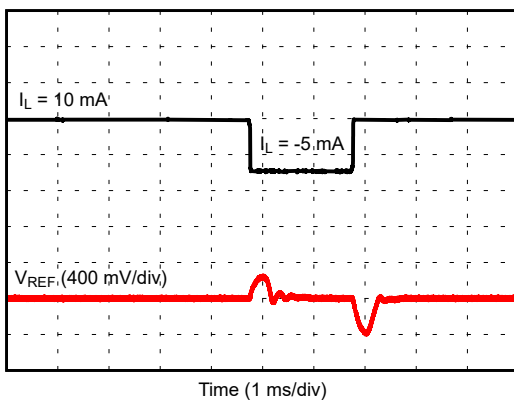
**Figure 7-14. Load Regulation (Sourcing 10 mA) vs Free-Air Temperature**



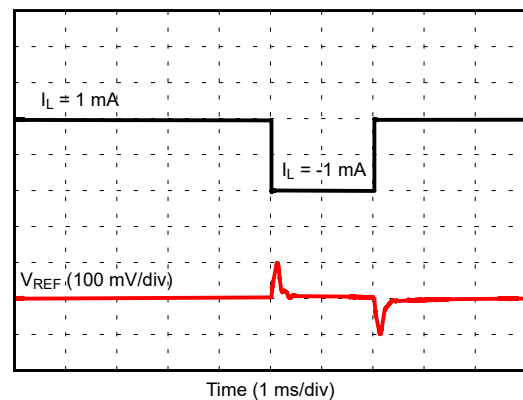
**Figure 7-15. Load Regulation (Sinking 5 mA) vs Free-Air Temperature**



**Figure 7-16. Load Transient Response**  
( $V_{REF} = 2.5\text{ V}$ ,  $C_L = 10\ \mu\text{F}$ )



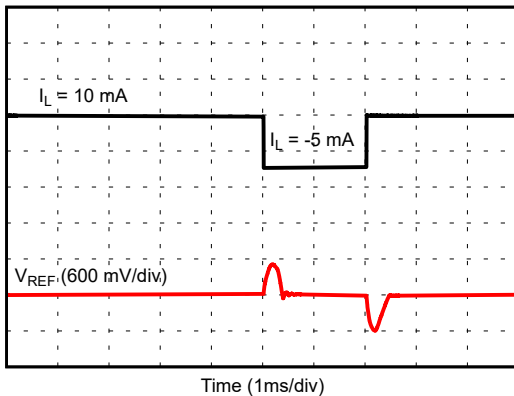
**Figure 7-17. Load Transient Response**  
( $V_{REF} = 2.5\text{ V}$ ,  $C_L = 10\ \mu\text{F}$ )



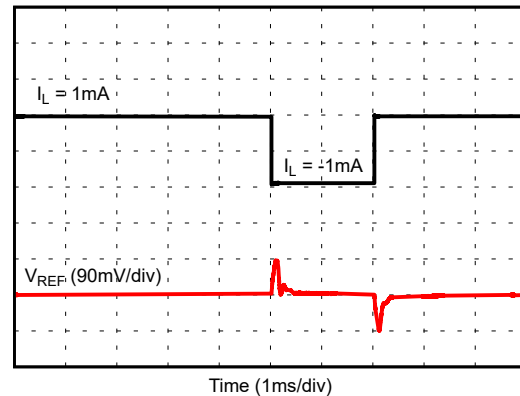
**Figure 7-18. Load Transient Response**  
( $V_{REF} = 2.5\text{ V}$ ,  $C_L = 1\ \mu\text{F}$ )

## 7.6 Typical Characteristics (continued)

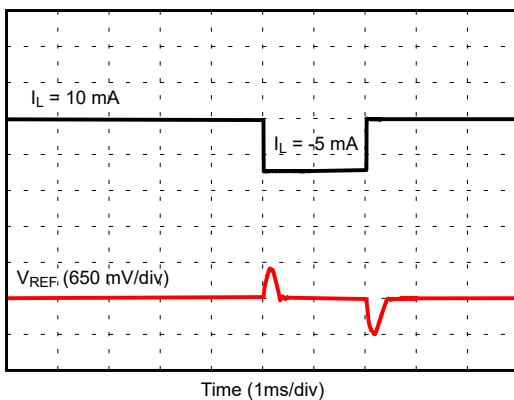
at  $T_A = 25^\circ\text{C}$ ,  $V_{IN} = V_{EN} = V_{REF} + 0.3\text{ V}$ ,  $I_L = 0\text{ mA}$ ,  $C_L = 10\ \mu\text{F}$ ,  $C_{IN} = 0.1\ \mu\text{F}$  (unless otherwise noted)



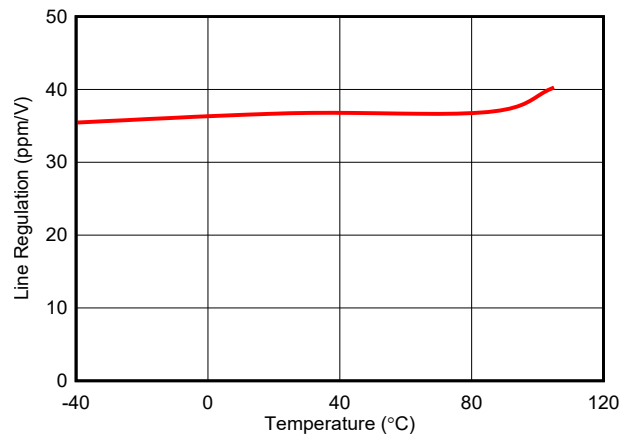
**Figure 7-19. Load Transient Response**  
( $V_{REF} = 2.5\text{ V}$ ,  $C_L = 1\ \mu\text{F}$ )



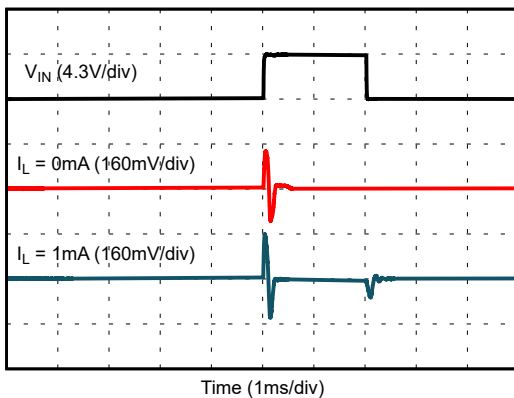
**Figure 7-20. Load Transient Response**  
( $V_{REF} = 1.25\text{ V}$ ,  $C_L = 1\ \mu\text{F}$ )



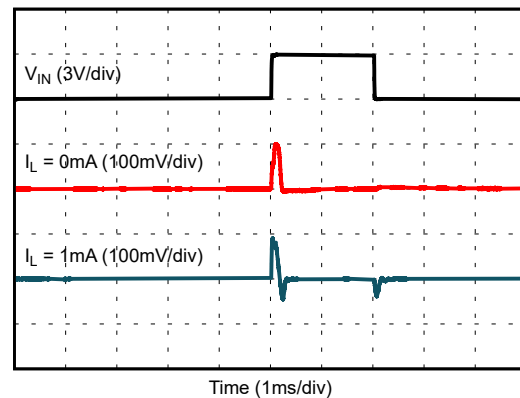
**Figure 7-21. Load Transient Response**  
( $V_{REF} = 1.25\text{ V}$ ,  $C_L = 1\ \mu\text{F}$ )



**Figure 7-22. Line Regulation vs Free-Air Temperature**



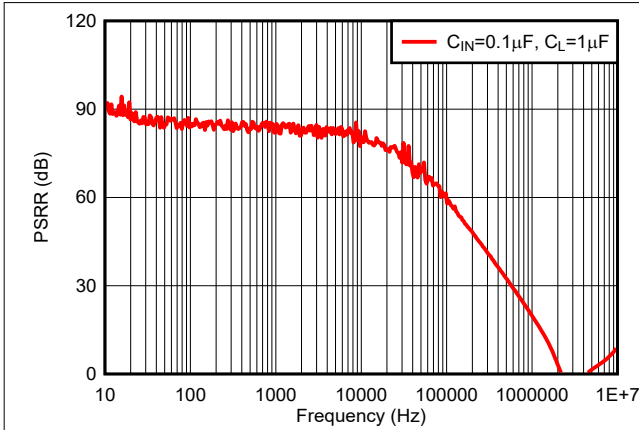
**Figure 7-23. Line Transient Response**  
( $V_{REF} = 1.25\text{ V}$ ,  $C_L = 1\ \mu\text{F}$ )



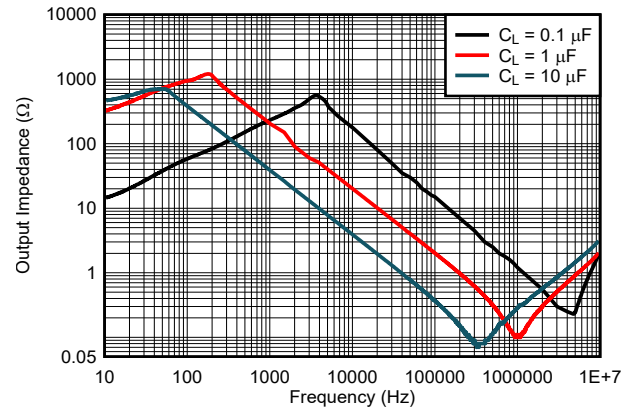
**Figure 7-24. Line Transient Response**  
( $V_{REF} = 2.5\text{ V}$ ,  $C_L = 1\ \mu\text{F}$ )

### 7.6 Typical Characteristics (continued)

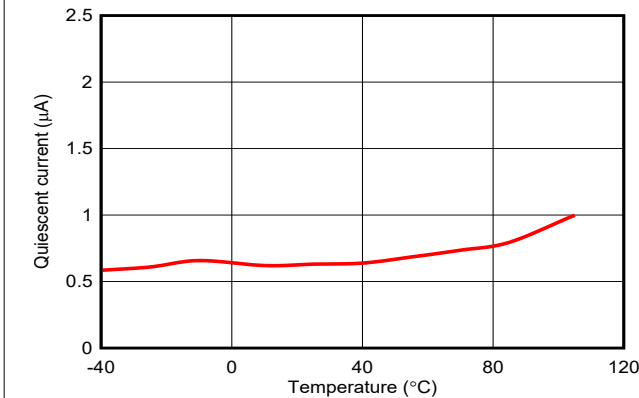
at  $T_A = 25^\circ\text{C}$ ,  $V_{IN} = V_{EN} = V_{REF} + 0.3\text{ V}$ ,  $I_L = 0\text{ mA}$ ,  $C_L = 10\ \mu\text{F}$ ,  $C_{IN} = 0.1\ \mu\text{F}$  (unless otherwise noted)



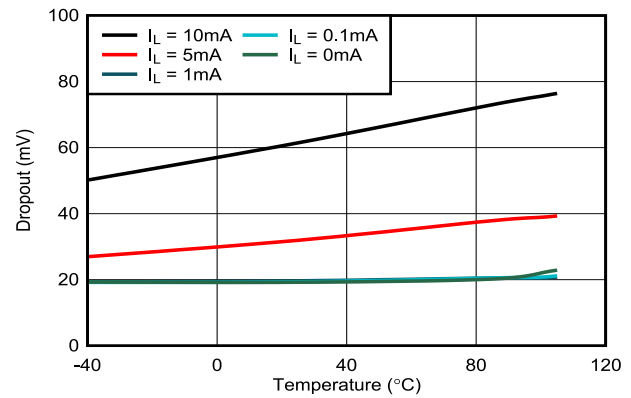
**Figure 7-25. Power Supply Rejection Ratio**  
( $V_{REF} = 2.5\text{ V}$ ,  $I_L = 0\text{ mA}$ )



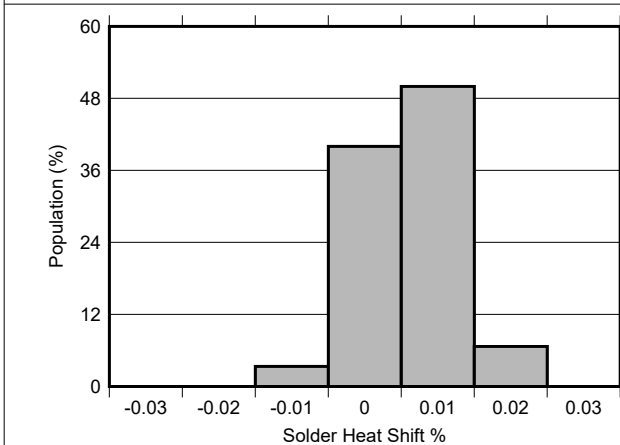
**Figure 7-26. Output Impedance**



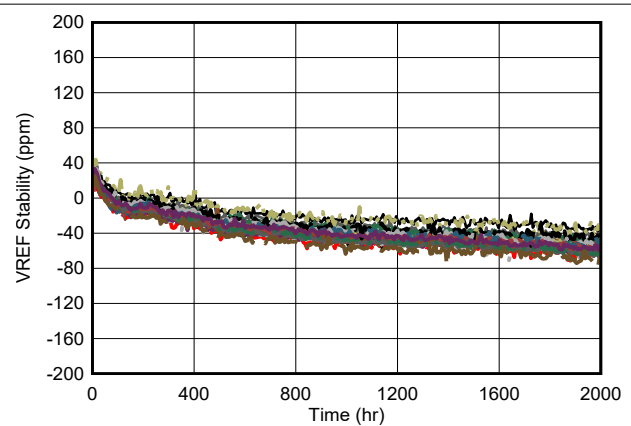
**Figure 7-27. Quiescent Current vs Free-Air Temperature**



**Figure 7-28. Dropout Voltage vs Free-Air Temperature**



**Figure 7-29. Solder Heat Shift Distribution**



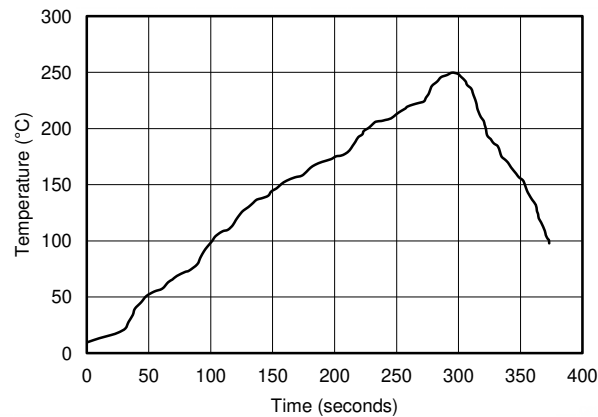
**Figure 7-30. Long Term Stability - 2000 hours ( $V_{REF}$ )**

## 8 Parameter Measurement Information

### 8.1 Solder Heat Shift

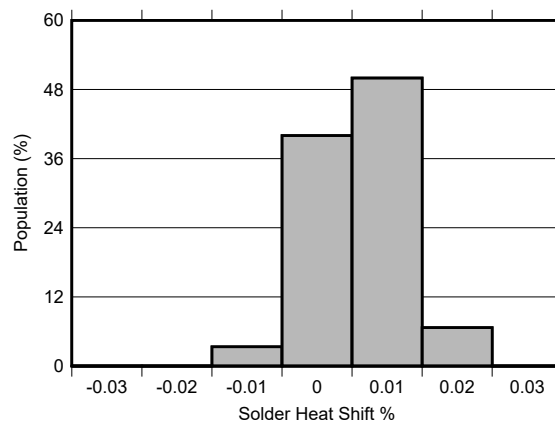
The materials used in the manufacture of the REF35 have differing coefficients of thermal expansion, resulting in stress on the device die when the part is heated. Mechanical and thermal stress on the device die can cause the output voltages to shift, degrading the initial accuracy specifications of the product. Reflow soldering is a common cause of this error.

To illustrate this effect, a total of 32 devices were soldered on one printed circuit board using lead-free solder paste and the paste manufacturer suggested reflow profile. [Figure 8-1](#) shows the reflow profile. The printed circuit board is comprised of FR4 material. The board thickness is 1.66 mm and the area is 174 mm × 135 mm.



**Figure 8-1. Reflow Profile**

The reference output voltage is measured before and after the reflow process; [Figure 8-2](#) shows the typical shift. Although all tested units exhibit very low shifts (< 0.03%), higher shifts are also possible depending on the size, thickness, and material of the printed circuit board (PCB). An important note is that the histograms display the typical shift for exposure to a single reflow profile. Exposure to multiple reflows, as is common on PCBs with surface-mount components on both sides, causes additional shifts in the output bias voltage. If the PCB is exposed to multiple reflows, the device must be soldered in the last pass to minimize its exposure to thermal stress.



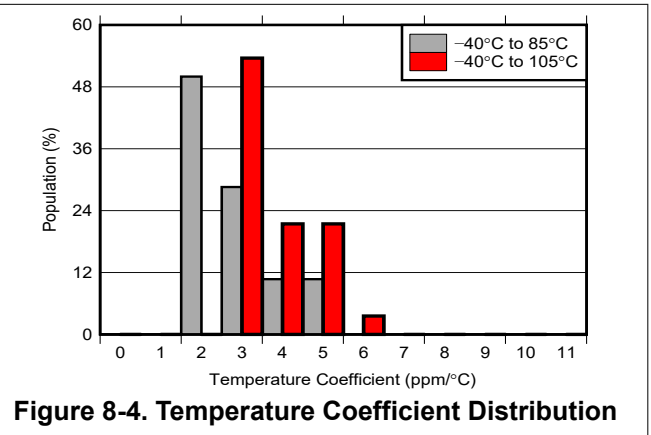
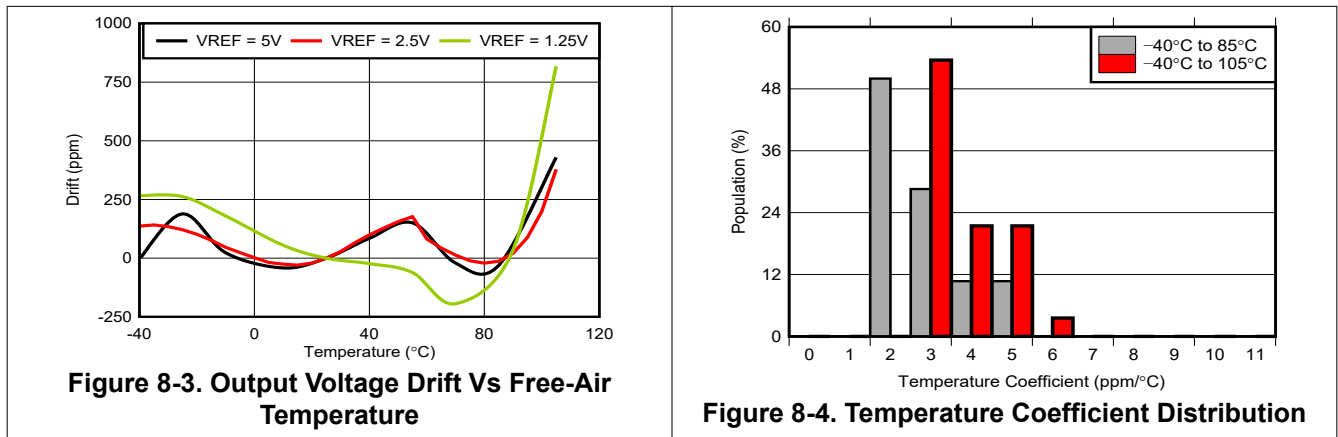
**Figure 8-2. Solder Heat Shift Distribution,  $V_{REF}$  (%)**

## 8.2 Temperature Coefficient

The REF35 is designed and tested for a low output voltage temperature coefficient. The temperature coefficient is defined as the change in output voltage over temperature. The temperature coefficient is calculated using the box method in which a box is formed by the minimum/maximum values for the nominal output voltage over the operating temperature range. REF35 has a low maximum temperature coefficient of 12 ppm/°C from –40°C to +105°C. The box method specifies limits for the temperature error but does not specify the exact shape and slope of the device under test. Due to temperature curvature correction to achieve low-temperature drift, the temperature drift is expected to be non-linear. See TI's Analog Design Journal, [Precision voltage references](#), for more information on the box method. Use [Equation 1](#) for the box method.

$$\text{Drift} = \left( \frac{V_{\text{REF(MAX)}} - V_{\text{REF(MIN)}}}{V_{\text{REF(25}^\circ\text{C)}} \times \text{Temperature Range}} \right) \times 10^6 \quad (1)$$

[Figure 8-3](#) shows a typical voltage versus temperature curves for various reference voltages. [Figure 8-4](#) shows the distribution of temperature coefficients for REF35250 devices.



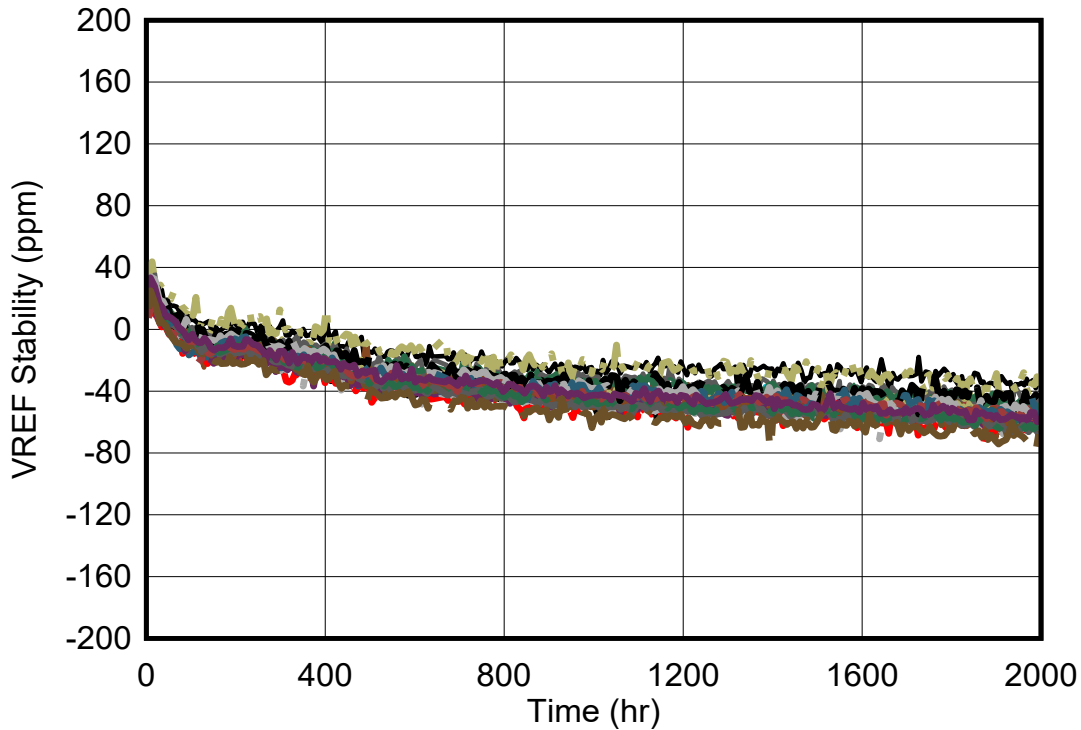
## 8.3 Long-Term Stability

One of the key performance parameters of the REF35 references is long-term stability also known as long-term drift. The long-term stability value is tested in a setup that reflects standard PCB board manufacturing practices. The boards are made of standard FR4 material and the board does not have special cuts or grooves around the devices to relieve the mechanical stress of the PCB. The devices and boards in this test do not undergo high temperature burn in post-soldering prior to testing. These conditions reflect a real world use case scenario and common manufacturing techniques.

During the long-term stability testing, precautions are taken to ensure that only the long-term stability drift is measured. The boards are maintained at 35°C in an oil bath. The oil bath ensures that the temperature is constant across the device over time compared to an air oven. The measurements are captured every 30 minutes with a calibrated 8.5 digit multimeter.

The typical long-term stability characteristic is expressed as a deviation of the reference voltage output over time.

[Figure 8-5](#) shows that the typical drift value for the REF35 6-pin SOT-23 package is 40 ppm from 0 to 1000 hours and 55 ppm from 0 to 2000 hours. It is important to understand that long-term stability is not ensured by design and that the value is typical. The REF35 will experience the highest drift in the initial 1000 hr. Subsequent deviation is typically lower than first 1000 hr.



**Figure 8-5. Long Term Stability - 2000 hours ( $V_{REF}$ )**

## 8.4 Thermal Hysteresis

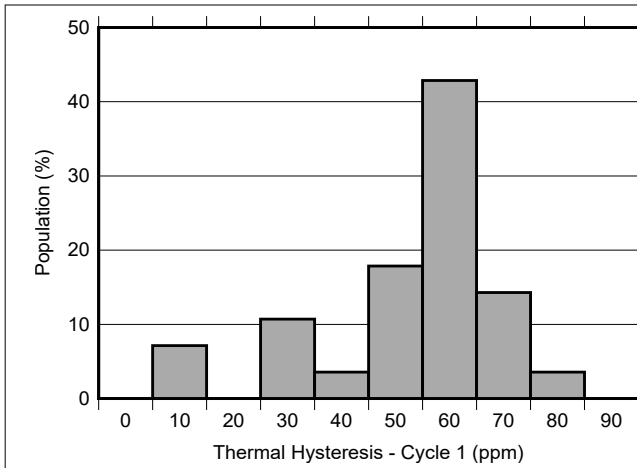
Thermal hysteresis is measured with the REF35 soldered to a PCB, similar to a real-world application. Thermal hysteresis for the device is defined as the change in output voltage after operating the device at 25°C, cycling the device through the specified temperature range, and returning to 25°C. The PCB was baked at 150°C for 30 minutes before thermal hysteresis was measured. Use [Equation 2](#) to calculate the thermal hysteresis:

$$V_{HYST} = \left( \frac{|V_{PRE} - V_{POST}|}{V_{NOM}} \right) \times 10^6 \text{ (ppm)} \quad (2)$$

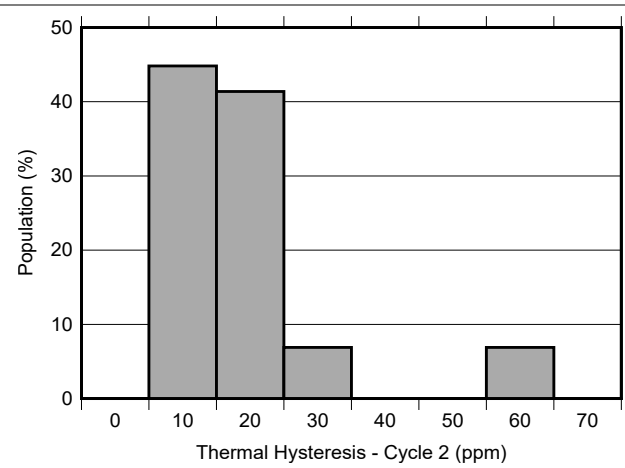
where

- $V_{HYST}$  = thermal hysteresis (in units of ppm)
- $V_{NOM}$  = the specified output voltage
- $V_{PRE}$  = output voltage measured at 25°C pre-temperature cycling
- $V_{POST}$  = output voltage measured after the device has cycled from 25°C through the specified temperature range of –40°C to +85°C or –40°C to +105°C and returns to 25°C.

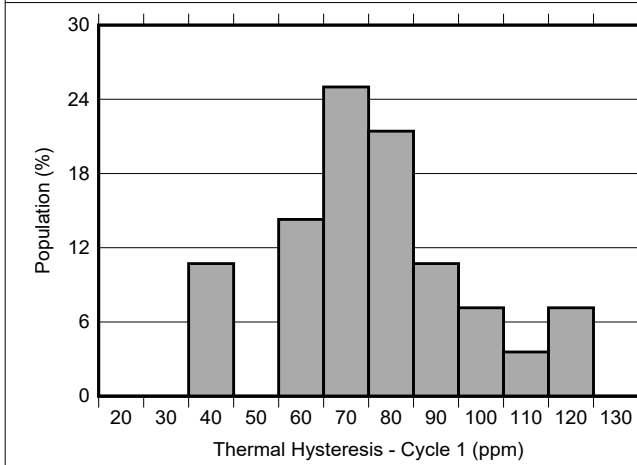
The graphs below show the typical thermal hysteresis distribution across various temperature ranges in two cycles.



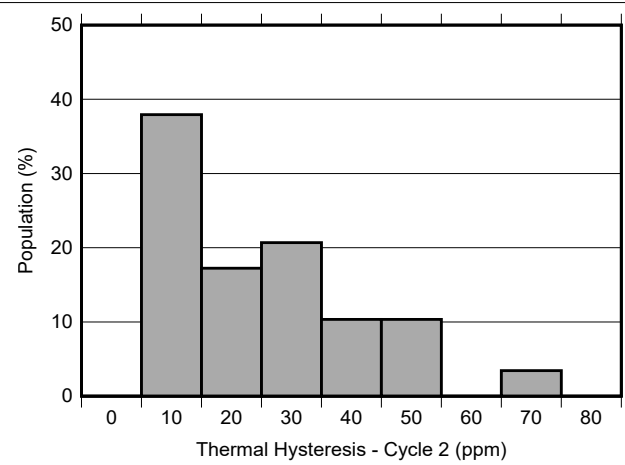
**Figure 8-6. Thermal Hysteresis Distribution  
–40°C to 85°C, Cycle 1**



**Figure 8-7. Thermal Hysteresis Distribution  
–40°C to 85°C, Cycle 2**



**Figure 8-8. Thermal Hysteresis Distribution  
–40°C to 105°C, Cycle 1**



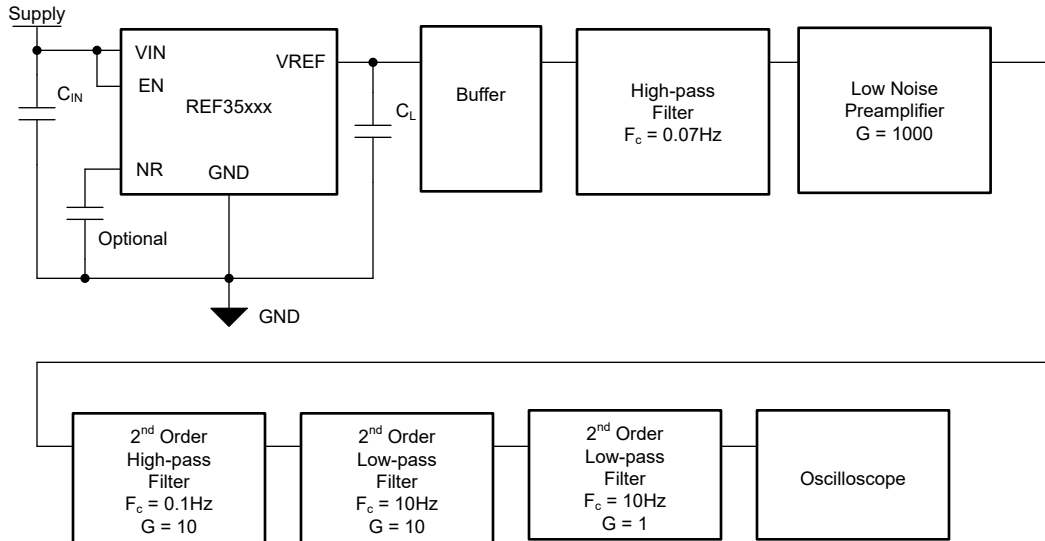
**Figure 8-9. Thermal Hysteresis Distribution  
–40°C to 105°C, Cycle 2**

## 8.5 Noise Performance

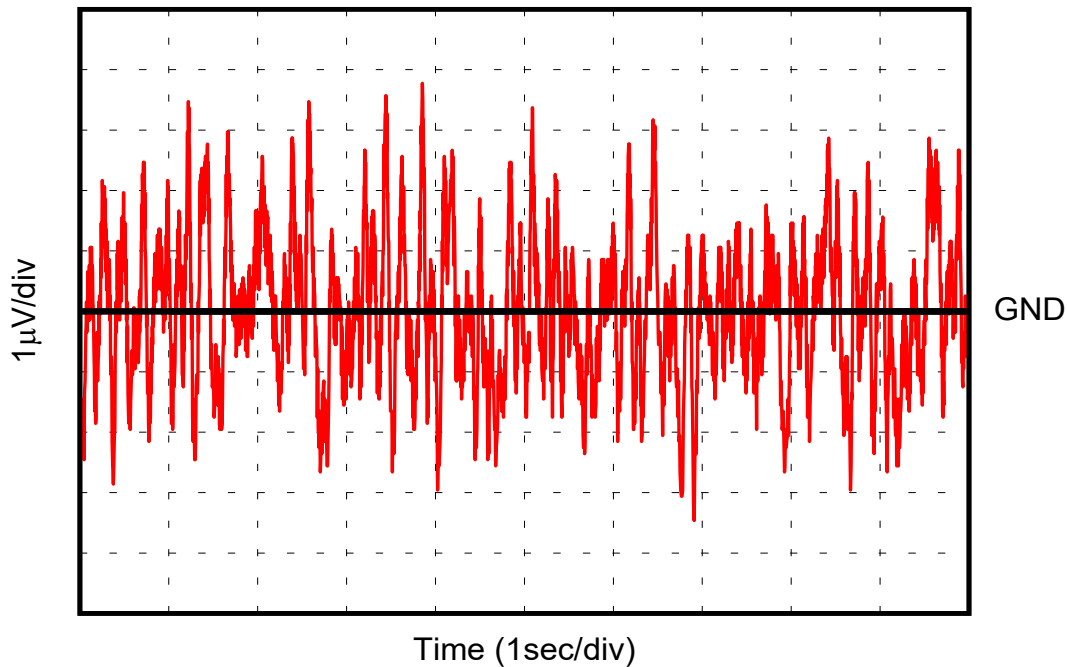
The reference pin output noise is categorized as low frequency and broadband noise. The following sections describe these categories in detail.

### 8.5.1 Low-Frequency (1/f) Noise

Flicker noise, also known as 1/f noise, is a low-frequency noise that affects the device output voltage which can affect precision measurements in ADCs. This noise increases proportionally with output voltage and operating temperature. Noise is measured by filtering the output from 0.1 Hz to 10 Hz. The 1/f noise is an extremely low value, therefore the frequency of interest must be amplified and band-pass filtered. This is done by using a high-pass filter to block the DC voltage. The resulting noise is then amplified by a gain of 1000. The bandpass filter is created by a series of high-pass and low-pass filter that adds additional gain to make it more visible on a oscilloscope as shown in [Figure 8-10](#). [Figure 8-11](#) shows the effect of flicker noise over 10 second for REF35250. Flicker noise must be tested in a Faraday cage enclosure to block environmental noise.



**Figure 8-10. Low-Frequency (1/f) Noise Test Setup**

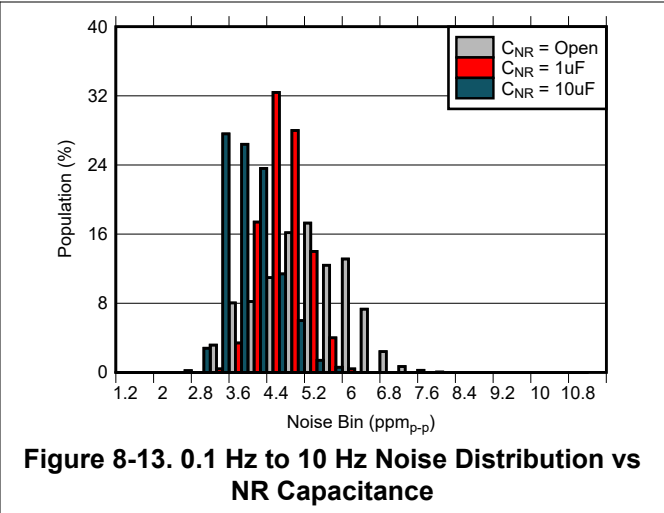
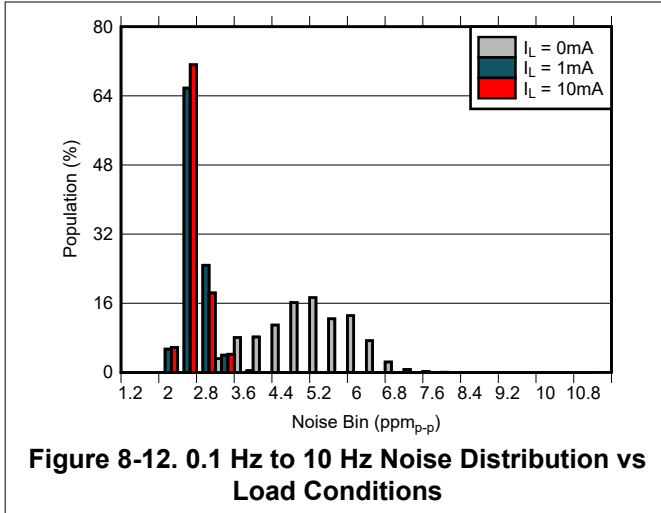


**Figure 8-11. 0.1 Hz to 10 Hz Voltage Noise**

Figure 8-12 shows the typical 1/f noise (0.1 Hz to 10 Hz) distribution across various load conditions. REF35 device also offers noise reduction functionality by adding an optional capacitor between NR (pin 5) and ground pins.

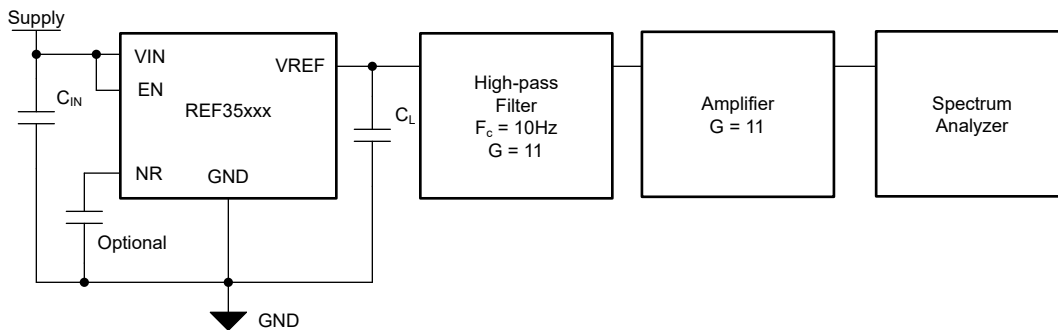
Figure 8-13 shows the typical 1/f noise (0.1 Hz to 10 Hz) distribution across REF35 devices with various capacitance between NR pin and GND.





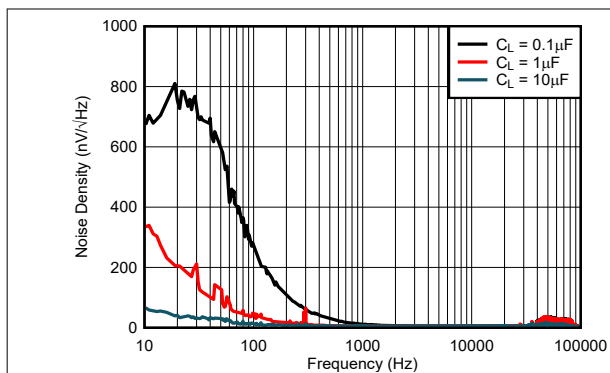
### 8.5.2 Broadband Noise

Broadband noise is a noise that appears at higher frequency compared to  $1/f$  noise. The broadband noise is measured by high-pass filtering the output of the reference device, followed by a gain stage and measuring the result on a spectrum analyzer as shown in Figure 8-14.

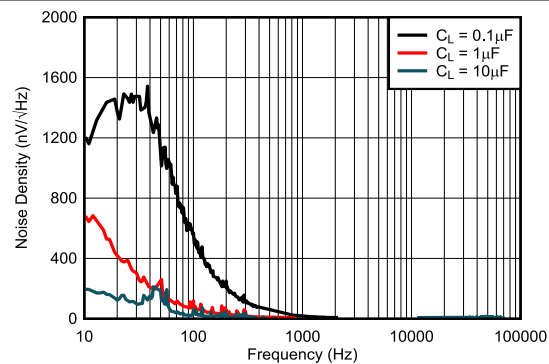


**Figure 8-14. Broadband Noise Test Setup**

For noise sensitive designs, a low-pass filter can be used to reduce broadband output noise. When designing a low-pass filter, take special care to ensure the output impedance of the filter does not degrade AC performance. This can occur in RC low-pass filters where a large series resistance can impact the load transients due to output current fluctuations. The REF35 device also offers noise reduction functionality by adding an optional capacitor between NR (pin 5) and ground pins. Figure 8-15 and Figure 8-16 show the noise spectrum for REF35250 and REF35500 devices respectively across various load capacitance.



**Figure 8-15. Noise Spectrum 10 Hz to 100 kHz**  
( $V_{REF} = 2.5\text{ V}$ )



**Figure 8-16. Noise Spectrum 10 Hz to 100 kHz**  
( $V_{REF} = 5\text{ V}$ )

## 8.6 Power Dissipation

The REF35 voltage references are capable of source up to 10 mA and sink up to 5 mA of load current across the rated input voltage range. However, when used in applications subject to high ambient temperatures, the input voltage and load current must be carefully monitored to ensure that the device does not exceed its maximum power dissipation rating. The maximum power dissipation of the device can be calculated with [Equation 3](#):

$$T_J = T_A + P_D \times R_{\theta JA} \quad (3)$$

where

- $P_D$  is the device power dissipation
- $T_J$  is the device junction temperature
- $T_A$  is the ambient temperature
- $R_{\theta JA}$  is the package (junction-to-air) thermal resistance

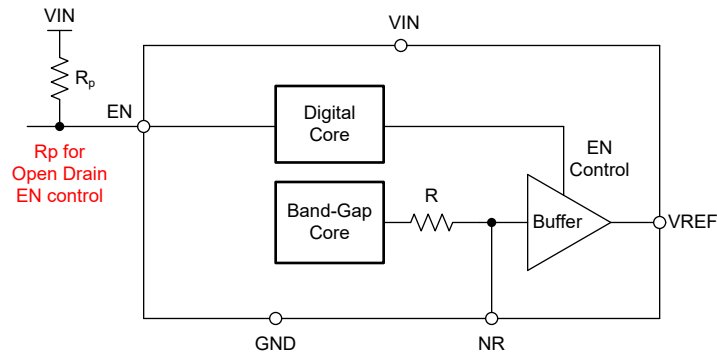
Because of this relationship, acceptable load current in high temperature conditions may be less than the maximum current-sourcing capability of the device. In no case should the device be operated outside of its maximum power rating because doing so can result in premature failure or permanent damage to the device.

## 9 Detailed Description

### 9.1 Overview

The REF35 is family of ultra-low current, low-noise, precision band-gap voltage references that are specifically designed for excellent initial voltage accuracy and drift. The [Functional Block Diagram](#) is a simplified block diagram of the REF35 showing basic band-gap topology.

### 9.2 Functional Block Diagram



### 9.3 Feature Description

#### 9.3.1 Supply Voltage

The REF35 family of references features an extremely low dropout voltage. For 10 mA loaded conditions, a maximum dropout voltage is 250 mV. [Figure 7-28](#) shows a typical dropout voltage ( $V_{DO}$ ) versus load current. The device supports operation with input voltage range from  $V_{REF} + V_{DO}$  to 6 V. The typical quiescent current is 650 nA and maximum quiescent current over temperature is only 2.6  $\mu$ A. The low dropout voltage coupled with ultra-low current enable the operation across multiple battery powered applications.

#### 9.3.2 EN Pin

The REF35 family supports device enable and disable functionality through logic level control on EN pin. The EN pin of REF35 does not use an internal pull-up resistor. Instead, the pin uses new 'clean EN' technology. This allows the EN pin to be in a no connect condition at start-up, and no extra current is drawn from the supply when the EN pin is pulled low in shutdown mode. When EN pin is pulled high or left unconnected at start-up, the device is in active mode. When EN pin is driven by an open-drain output, a pull-up resistor to VIN is required. The device must be in active mode for normal operation. The EN pin must not be pulled higher than VIN supply voltage.

The device can be placed in shutdown mode by pulling the EN pin low. When in shutdown mode, the output of the device becomes high impedance and the quiescent current of the device drops to 100 nA at room temperature. When changing the device state from shutdown to active state, ensure the EN pin is not left floating.

Also note that for applications where EN pin is no-connect, total parasitic capacitance on EN pin should be restricted within 30 pF.

See the [Electrical Characteristics](#) table for logic high and logic low voltage levels.

#### 9.3.3 NR Pin

The REF35 pin allows access to the band-gap through the NR pin. Placing a capacitor from the NR pin to GND creates a low-pass filter in combination with the internal resistance of 60 k $\Omega$ . Leakage of the capacitance directly impacts the accuracy and temperature drift. If NR functionality is used, choose a low leakage capacitor. A capacitance of 1  $\mu$ F creates a low-pass filter with corner frequency around 2.7 Hz. Such a filter decreases the overall noise on the VREF pin. Higher capacitance results in a lower filter cut off frequency, further reducing output noise. Please note, using the capacitor on NR pin also increases start-up time.

## 9.4 Device Functional Modes

### 9.4.1 Basic Connections

Figure 9-1 shows the typical connections for the REF35. TI recommends a supply bypass capacitor ( $C_{IN}$ ) ranging from 0.1  $\mu\text{F}$  to 10  $\mu\text{F}$ . A 0.1  $\mu\text{F}$  to 10  $\mu\text{F}$  output capacitor ( $C_L$ ) must be connected from REF to GND. The equivalent series resistance (ESR) value of  $C_L$  must be lower than 400 m $\Omega$  to ensure output stability.

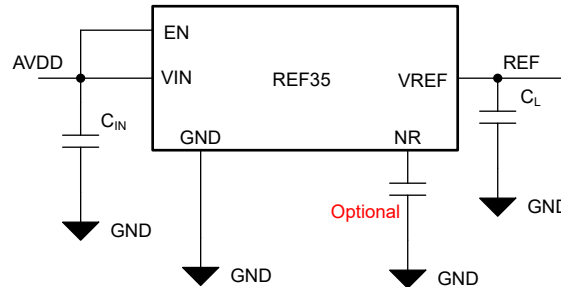


Figure 9-1. Basic Connections

### 9.4.2 Start-Up

Figure 9-2 shows the start-up behavior of REF35250 device with 1  $\mu\text{F}$  load capacitance. REF35 device ensures the output voltage settles to the expected output voltage within specified accuracy without oscillations. The start-up time is dependent on the output voltage variant, output capacitance and NR pin capacitance. Higher capacitance leads to longer start-up time.

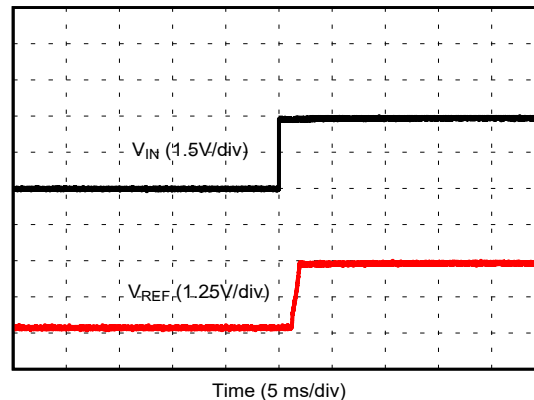
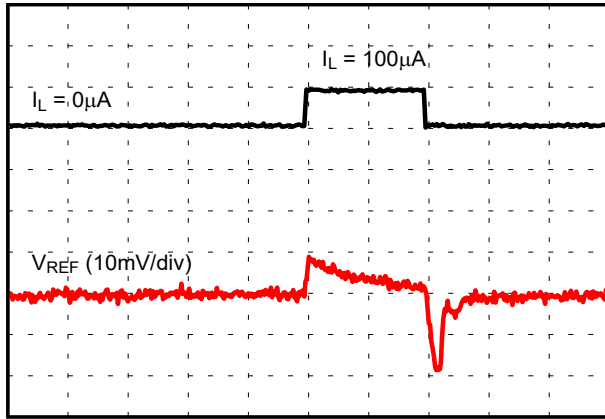


Figure 9-2. REF35250 Start-Up Behavior,  $C_L = 1 \mu\text{F}$

### 9.4.3 Output Transient Behavior

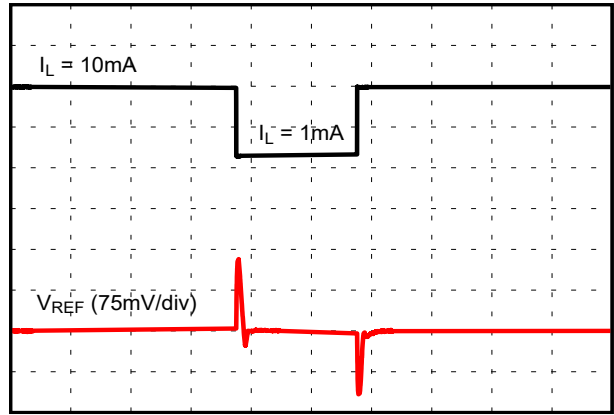
The REF35 output buffer is capable of sourcing 10 mA load current as well as sink 5 mA of load current. The output stage is designed using class AB architecture with ultra-low quiescent current. This architecture avoids the dead zone around the no load condition. The output buffer uses a fast start-up implementation to achieve 2ms typical turn-on time at  $C_L = 1 \mu\text{F}$  and no-load current condition.

Figure 9-3 and Figure 9-4 show the output settling behavior for light load transient and high load transient respectively.



Time (1ms/div)

**Figure 9-3. Load Transient Response 0  $\mu$ A to 100  $\mu$ A,  $C_L = 1 \mu$ F**



Time (1ms/div)

**Figure 9-4. Load Transient Response 1 mA to 10 mA,  $C_L = 1 \mu$ F**

## 10 Application and Implementation

### Note

Information in the following applications sections is not part of the TI component specification, and TI does not warrant its accuracy or completeness. TI's customers are responsible for determining suitability of components for their purposes. Customers should validate and test their design implementation to confirm system functionality.

### 10.1 Application Information

REF35 with low current consumption and class leading performance specifications is suitable reference for multiple applications. The device can also be used as a precision low noise power supply to sensor or data converter instead of traditional LDO or DC/DC based power supply. Basic applications includes positive/negative voltage reference and data acquisition systems. The table below shows the typical application of REF35 and its companion ADC/DAC.

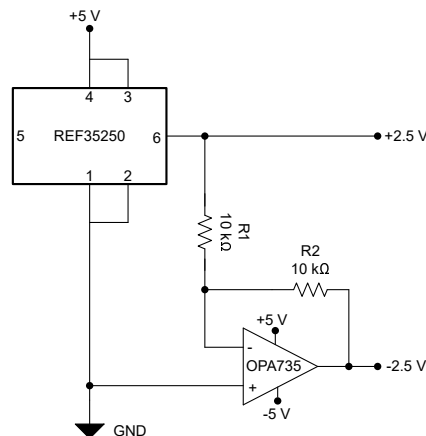
**Table 10-1. Typical Applications and Companion ADC/DAC**

APPLICATIONS	ADC/DAC
PLC - DCS	ADS7028, DAC8881, ADS1287, ADS7953
Rack Server	ADS7028, ADS7128, ADS7138
Field Transmitters - Pressure, Flow	ADS124S08
Optical Module, Optical Line Card	ADS7068, ADS7138
Medical Blood Glucose Meter	ADS1112
Power quality analyzer	ADC3662
Thermal imaging	ADC3541

### 10.2 Typical Applications

#### 10.2.1 Negative Reference Voltage

For applications requiring a negative and positive reference voltage, the REF35 and OPA735 can be used to provide a dual-supply reference from a 5 V supply. Figure 10-1 shows the REF35250 used to provide a 2.5 V supply reference voltage. The low drift performance of the REF35250 complements the low offset voltage and zero drift of the OPA735 to provide an accurate solution for split-supply applications. Take care to match the temperature coefficients of R1 and R2.



**Figure 10-1. REF35 and OPA735 Create Positive and Negative Reference Voltages**

## 10.2.2 Precision Power Supply and Reference

Figure 10-2 shows the basic configuration for the REF35 device as precision power supply to ADS7038 data converter which uses its power supply AVDD as reference. Connect bypass capacitors according to the guidelines in the *Input and Output Capacitors* section.

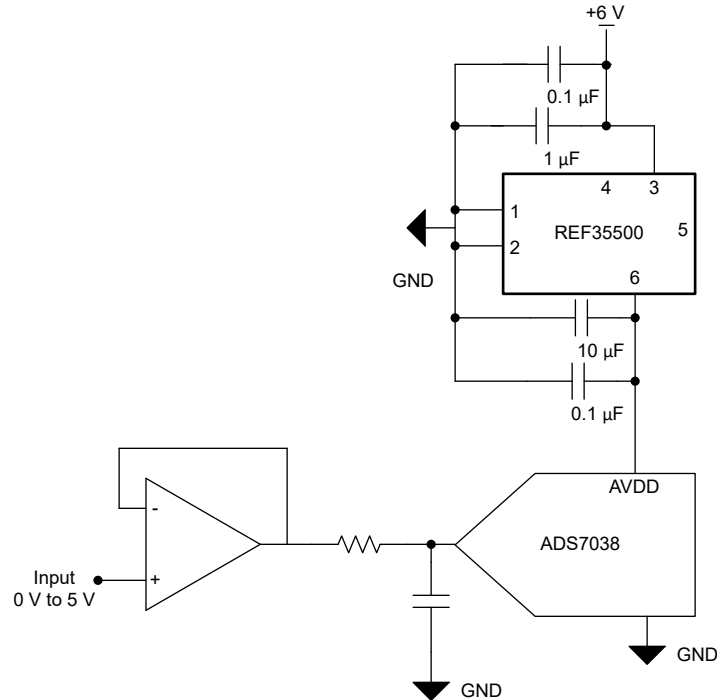


Figure 10-2. Basic Reference Connection

### 10.2.2.1 Design Requirements

A detailed design procedure is described based on a design example. For this design example, use the parameters listed in Table 10-2 as the input parameters.

Table 10-2. Design Example Parameters

DESIGN PARAMETER	VALUE
Input voltage range $V_{IN}$	0 V - 5 V
Output resolution	12-bit
REF35 input capacitor	1 $\mu$ F
REF35 output capacitor	10 $\mu$ F

### 10.2.2.2 Detailed Design Procedure

#### 10.2.2.2.1 Selection of Reference

The REF35500 reference is selected for this design. The REF35500 device operates of very low quiescent current while offering  $\pm 0.05\%$  initial accuracy and very low noise. These parameters help improve system accuracy as compared to external LDO based power supply. The 5 V reference voltage supports the 0 V to 5 V input range specification.

#### 10.2.2.2.2 Input and Output Capacitors

A 1  $\mu$ F to 10  $\mu$ F electrolytic or ceramic capacitor can be connected to the input to improve transient response in applications where the supply voltage may fluctuate.

A ceramic capacitor of at least a 0.1  $\mu\text{F}$  must be connected to the output to improve stability and help filter out high frequency noise. Add an additional 10  $\mu\text{F}$  capacitor in parallel to improve transient performance in response to sudden changes in load current; however, keep in mind that doing so increases the start-up time of the device.

Best performance and stability is attained with low-ESR, low-inductance ceramic chip-type output capacitors (X5R, X7R, or similar). If using an electrolytic capacitor on the output, place a 0.1  $\mu\text{F}$  ceramic capacitor in parallel to reduce overall ESR on the output. Place the input and output capacitors as close as possible to the device.

#### 10.2.2.2.3 Selection of ADC

**ADS7038** 12-bit 8 channel multiplexed ADC is chosen for this application. The ADC offers low current operation with averaging mode to increase the resolution to 16-bit with internal averaging modes while operating with slow sampling speed.

#### 10.2.2.3 Application Curves

**Table 10-3** and **Figure 10-3** show the captured measurement results for various DC inputs. The ADC output is captured and analyzed for output accuracy error and code spread with REF35500 as power supply versus LDO as power supply.

REF35 offers better accuracy and lower noise than the LDO device at lower quiescent current. This results in lower error in measurement as well as lower ADC output code variation across various OSR settings.

**Table 10-3. DC Input Performance Test Results**

INPUT V	ADC OSR SETTING	REF35500		LDO	
		ERROR	CODE SPREAD	ERROR	CODE SPREAD
1.0 V	0	0.01 mV	32 LSB	8.9 mV	48 LSB
	8	0.3 mV	10 LSB	9.21 mV	16 LSB
	128	0.38 mV	6 LSB	9.26 mV	6 LSB
2.5 V	0	0.69 mV	32 LSB	22.89 mV	64 LSB
	8	1.44 mV	10 LSB	23.63 mV	18 LSB
	128	1.17 mV	3 LSB	23.41 mV	5 LSB
4 V	0	2.27 mV	32 LSB	37.84 mV	48 LSB
	8	3.01 mV	24 LSB	38.62 mV	24 LSB
	128	2.46 mV	3 LSB	38.09 mV	17 LSB



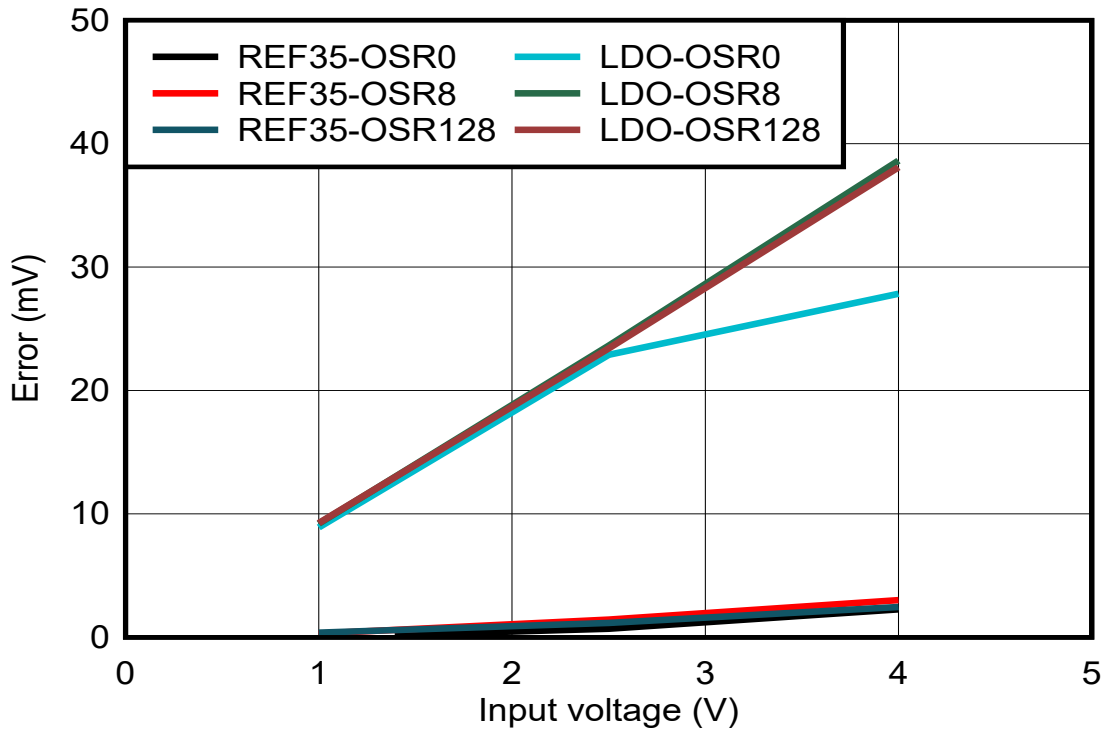


Figure 10-3. Error vs Input Voltage

### 10.3 Power Supply Recommendations

The REF35 family of references feature an extremely low-dropout voltage. These references can be operated with a supply of only 50 mV above the output voltage at no load. TI recommends a supply bypass capacitor ranging between 0.1  $\mu$ F to 10  $\mu$ F.

### 10.4 Layout

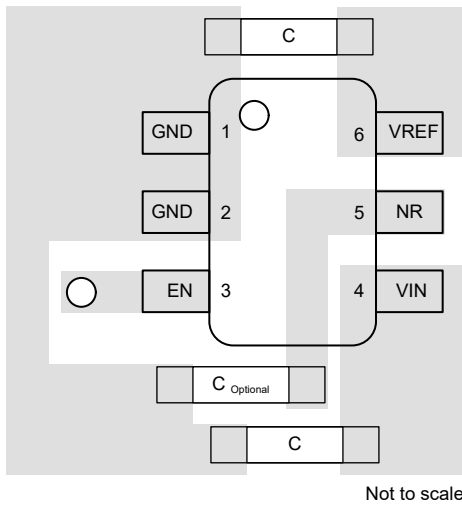
#### 10.4.1 Layout Guidelines

Figure 10-4 shows an example of a PCB layout for a data acquisition system using the REF35. Some key considerations are:

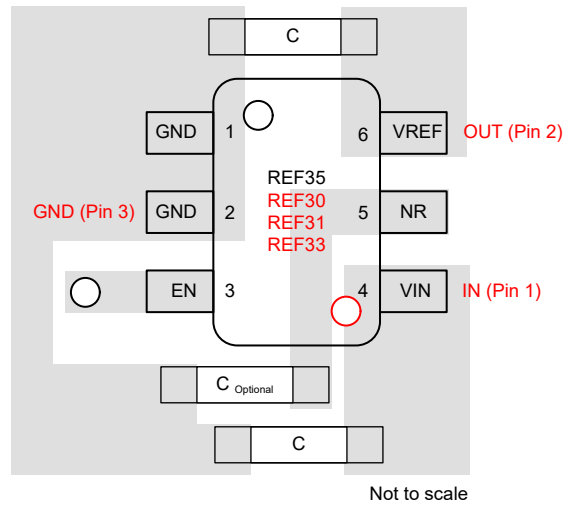
- Connect low-ESR, 0.1  $\mu$ F ceramic bypass capacitors at  $V_{IN}$ ,  $V_{REF}$  of the REF35.
- Decouple other active devices in the system per the device specifications.
- Using a solid ground plane helps distribute heat and reduces electromagnetic interference (EMI) noise pickup.
- Place the external components as close to the device as possible.
- Do not run sensitive analog traces in parallel with digital traces. Avoid crossing digital and analog traces if possible, and only make perpendicular crossings when absolutely necessary.

Figure 10-5 shows the pin compatibility with TI REF30xx, REF31xx and REF33xx series references in the 3-pin SOT-23 package when using the REF35xxx family footprint. You must rotate the REF30xx, REF31xx and REF33xx reference devices by 180° before assembly.

## 10.4.2 Layout Examples



**Figure 10-4. Layout Example**



**Figure 10-5. Pin Compatibility With REF30xx, REF31xx and REF33xx**

## 11 Device and Documentation Support

### 11.1 Documentation Support

#### 11.1.1 Related Documentation

For related documentation see the following:

- Texas Instruments, [INA21x Voltage Output, Low- or High-Side Measurement, Bidirectional, Zero-Drift Series, Current-Shunt Monitors data sheet](#)
- Texas Instruments, [Low-Drift Bidirectional Single-Supply Low-Side Current Sensing Reference Design](#)
- Texas Instruments, [Precision voltage references Analog Design Journal](#)

#### 11.2 Receiving Notification of Documentation Updates

To receive notification of documentation updates, navigate to the device product folder on [ti.com](#). Click on *Subscribe to updates* to register and receive a weekly digest of any product information that has changed. For change details, review the revision history included in any revised document.

#### 11.3 Support Resources

[TI E2E™ support forums](#) are an engineer's go-to source for fast, verified answers and design help — straight from the experts. Search existing answers or ask your own question to get the quick design help you need.

Linked content is provided "AS IS" by the respective contributors. They do not constitute TI specifications and do not necessarily reflect TI's views; see TI's [Terms of Use](#).

#### 11.4 Trademarks

TI E2E™ is a trademark of Texas Instruments.  
All trademarks are the property of their respective owners.

#### 11.5 Electrostatic Discharge Caution



This integrated circuit can be damaged by ESD. Texas Instruments recommends that all integrated circuits be handled with appropriate precautions. Failure to observe proper handling and installation procedures can cause damage.

ESD damage can range from subtle performance degradation to complete device failure. Precision integrated circuits may be more susceptible to damage because very small parametric changes could cause the device not to meet its published specifications.

#### 11.6 Glossary

[TI Glossary](#) This glossary lists and explains terms, acronyms, and definitions.

## 12 Mechanical, Packaging, and Orderable Information

The following pages include mechanical packaging and orderable information. This information is the most current data available for the designated devices. This data is subject to change without notice and revision of this document. For browser-based versions of this data sheet, refer to the left-hand navigation.

**PACKAGING INFORMATION**

Orderable Device	Status (1)	Package Type	Package Drawing	Pins	Package Qty	Eco Plan (2)	Lead finish/ Ball material (6)	MSL Peak Temp (3)	Op Temp (°C)	Device Marking (4/5)	Samples
PREF35125YBHR	ACTIVE	DSBGA	YBH	4	12000	RoHS & Green	SNAGCU	Level-1-260C-UNLIM	-40 to 125	P	<a href="#">Samples</a>
PREF35180YBHR	ACTIVE	DSBGA	YBH	4	3000	TBD	Call TI	Call TI	-40 to 125		<a href="#">Samples</a>
PREF35250YBHR	ACTIVE	DSBGA	YBH	4	3000	TBD	Call TI	Call TI	-40 to 125		<a href="#">Samples</a>
REF35102QDBVR	ACTIVE	SOT-23	DBV	6	3000	RoHS & Green	NIPDAUAG	Level-2-260C-1 YEAR	-40 to 125	2RTI	<a href="#">Samples</a>
REF35120QDBVR	ACTIVE	SOT-23	DBV	6	3000	RoHS & Green	NIPDAUAG	Level-2-260C-1 YEAR	-40 to 125	2RVI	<a href="#">Samples</a>
REF35125QDBVR	ACTIVE	SOT-23	DBV	6	3000	RoHS & Green	NIPDAUAG	Level-2-260C-1 YEAR	-40 to 125	2RUI	<a href="#">Samples</a>
REF35160QDBVR	ACTIVE	SOT-23	DBV	6	3000	RoHS & Green	NIPDAUAG	Level-2-260C-1 YEAR	-40 to 125	2UII	<a href="#">Samples</a>
REF35170QDBVR	ACTIVE	SOT-23	DBV	6	3000	RoHS & Green	NIPDAUAG	Level-2-260C-1 YEAR	-40 to 125	31QI	<a href="#">Samples</a>
REF35180QDBVR	ACTIVE	SOT-23	DBV	6	3000	RoHS & Green	NIPDAUAG	Level-2-260C-1 YEAR	-40 to 125	2J2I	<a href="#">Samples</a>
REF35205QDBVR	ACTIVE	SOT-23	DBV	6	3000	RoHS & Green	NIPDAUAG	Level-2-260C-1 YEAR	-40 to 125	2UKI	<a href="#">Samples</a>
REF35250QDBVR	ACTIVE	SOT-23	DBV	6	3000	RoHS & Green	NIPDAUAG	Level-2-260C-1 YEAR	-40 to 125	2RSI	<a href="#">Samples</a>
REF35300QDBVR	ACTIVE	SOT-23	DBV	6	3000	RoHS & Green	NIPDAUAG	Level-2-260C-1 YEAR	-40 to 125	2SLI	<a href="#">Samples</a>
REF35330QDBVR	ACTIVE	SOT-23	DBV	6	3000	RoHS & Green	NIPDAUAG	Level-2-260C-1 YEAR	-40 to 125	2ULI	<a href="#">Samples</a>
REF35360QDBVR	ACTIVE	SOT-23	DBV	6	3000	RoHS & Green	NIPDAUAG	Level-2-260C-1 YEAR	-40 to 125	31RI	<a href="#">Samples</a>
REF35409QDBVR	ACTIVE	SOT-23	DBV	6	3000	RoHS & Green	NIPDAUAG	Level-2-260C-1 YEAR	-40 to 125	2UMI	<a href="#">Samples</a>
REF35500QDBVR	ACTIVE	SOT-23	DBV	6	3000	RoHS & Green	NIPDAUAG	Level-2-260C-1 YEAR	-40 to 125	2RWI	<a href="#">Samples</a>

(1) The marketing status values are defined as follows:

**ACTIVE:** Product device recommended for new designs.

**LIFEBUY:** TI has announced that the device will be discontinued, and a lifetime-buy period is in effect.

**NRND:** Not recommended for new designs. Device is in production to support existing customers, but TI does not recommend using this part in a new design.

**PREVIEW:** Device has been announced but is not in production. Samples may or may not be available.

**OBSELETE:** TI has discontinued the production of the device.

(2) **RoHS:** TI defines "RoHS" to mean semiconductor products that are compliant with the current EU RoHS requirements for all 10 RoHS substances, including the requirement that RoHS substance do not exceed 0.1% by weight in homogeneous materials. Where designed to be soldered at high temperatures, "RoHS" products are suitable for use in specified lead-free processes. TI may reference these types of products as "Pb-Free".

**RoHS Exempt:** TI defines "RoHS Exempt" to mean products that contain lead but are compliant with EU RoHS pursuant to a specific EU RoHS exemption.

**Green:** TI defines "Green" to mean the content of Chlorine (Cl) and Bromine (Br) based flame retardants meet JS709B low halogen requirements of  $\leq 1000$ ppm threshold. Antimony trioxide based flame retardants must also meet the  $\leq 1000$ ppm threshold requirement.

(3) MSL, Peak Temp. - The Moisture Sensitivity Level rating according to the JEDEC industry standard classifications, and peak solder temperature.

(4) There may be additional marking, which relates to the logo, the lot trace code information, or the environmental category on the device.

(5) Multiple Device Markings will be inside parentheses. Only one Device Marking contained in parentheses and separated by a "~" will appear on a device. If a line is indented then it is a continuation of the previous line and the two combined represent the entire Device Marking for that device.

(6) Lead finish/Ball material - Orderable Devices may have multiple material finish options. Finish options are separated by a vertical ruled line. Lead finish/Ball material values may wrap to two lines if the finish value exceeds the maximum column width.

**Important Information and Disclaimer:** The information provided on this page represents TI's knowledge and belief as of the date that it is provided. TI bases its knowledge and belief on information provided by third parties, and makes no representation or warranty as to the accuracy of such information. Efforts are underway to better integrate information from third parties. TI has taken and continues to take reasonable steps to provide representative and accurate information but may not have conducted destructive testing or chemical analysis on incoming materials and chemicals. TI and TI suppliers consider certain information to be proprietary, and thus CAS numbers and other limited information may not be available for release.

In no event shall TI's liability arising out of such information exceed the total purchase price of the TI part(s) at issue in this document sold by TI to Customer on an annual basis.

#### OTHER QUALIFIED VERSIONS OF REF35 :

- Automotive : [REF35-Q1](#)

NOTE: Qualified Version Definitions:

- Automotive - Q100 devices qualified for high-reliability automotive applications targeting zero defects

**TAPE AND REEL INFORMATION**

**QUADRANT ASSIGNMENTS FOR PIN 1 ORIENTATION IN TAPE**


\*All dimensions are nominal

Device	Package Type	Package Drawing	Pins	SPQ	Reel Diameter (mm)	Reel Width W1 (mm)	A0 (mm)	B0 (mm)	K0 (mm)	P1 (mm)	W (mm)	Pin1 Quadrant
REF35102QDBVR	SOT-23	DBV	6	3000	180.0	8.4	3.23	3.17	1.37	4.0	8.0	Q3
REF35120QDBVR	SOT-23	DBV	6	3000	180.0	8.4	3.23	3.17	1.37	4.0	8.0	Q3
REF35125QDBVR	SOT-23	DBV	6	3000	180.0	8.4	3.23	3.17	1.37	4.0	8.0	Q3
REF35160QDBVR	SOT-23	DBV	6	3000	180.0	8.4	3.23	3.17	1.37	4.0	8.0	Q3
REF35170QDBVR	SOT-23	DBV	6	3000	180.0	8.4	3.23	3.17	1.37	4.0	8.0	Q3
REF35180QDBVR	SOT-23	DBV	6	3000	180.0	8.4	3.23	3.17	1.37	4.0	8.0	Q3
REF35205QDBVR	SOT-23	DBV	6	3000	180.0	8.4	3.23	3.17	1.37	4.0	8.0	Q3
REF35250QDBVR	SOT-23	DBV	6	3000	180.0	8.4	3.23	3.17	1.37	4.0	8.0	Q3
REF35300QDBVR	SOT-23	DBV	6	3000	180.0	8.4	3.23	3.17	1.37	4.0	8.0	Q3
REF35330QDBVR	SOT-23	DBV	6	3000	180.0	8.4	3.23	3.17	1.37	4.0	8.0	Q3
REF35360QDBVR	SOT-23	DBV	6	3000	180.0	8.4	3.23	3.17	1.37	4.0	8.0	Q3
REF35409QDBVR	SOT-23	DBV	6	3000	180.0	8.4	3.23	3.17	1.37	4.0	8.0	Q3
REF35500QDBVR	SOT-23	DBV	6	3000	180.0	8.4	3.23	3.17	1.37	4.0	8.0	Q3

**TAPE AND REEL BOX DIMENSIONS**


\*All dimensions are nominal

Device	Package Type	Package Drawing	Pins	SPQ	Length (mm)	Width (mm)	Height (mm)
REF35102QDBVR	SOT-23	DBV	6	3000	213.0	191.0	35.0
REF35120QDBVR	SOT-23	DBV	6	3000	213.0	191.0	35.0
REF35125QDBVR	SOT-23	DBV	6	3000	213.0	191.0	35.0
REF35160QDBVR	SOT-23	DBV	6	3000	213.0	191.0	35.0
REF35170QDBVR	SOT-23	DBV	6	3000	213.0	191.0	35.0
REF35180QDBVR	SOT-23	DBV	6	3000	213.0	191.0	35.0
REF35205QDBVR	SOT-23	DBV	6	3000	213.0	191.0	35.0
REF35250QDBVR	SOT-23	DBV	6	3000	213.0	191.0	35.0
REF35300QDBVR	SOT-23	DBV	6	3000	213.0	191.0	35.0
REF35330QDBVR	SOT-23	DBV	6	3000	213.0	191.0	35.0
REF35360QDBVR	SOT-23	DBV	6	3000	213.0	191.0	35.0
REF35409QDBVR	SOT-23	DBV	6	3000	213.0	191.0	35.0
REF35500QDBVR	SOT-23	DBV	6	3000	213.0	191.0	35.0

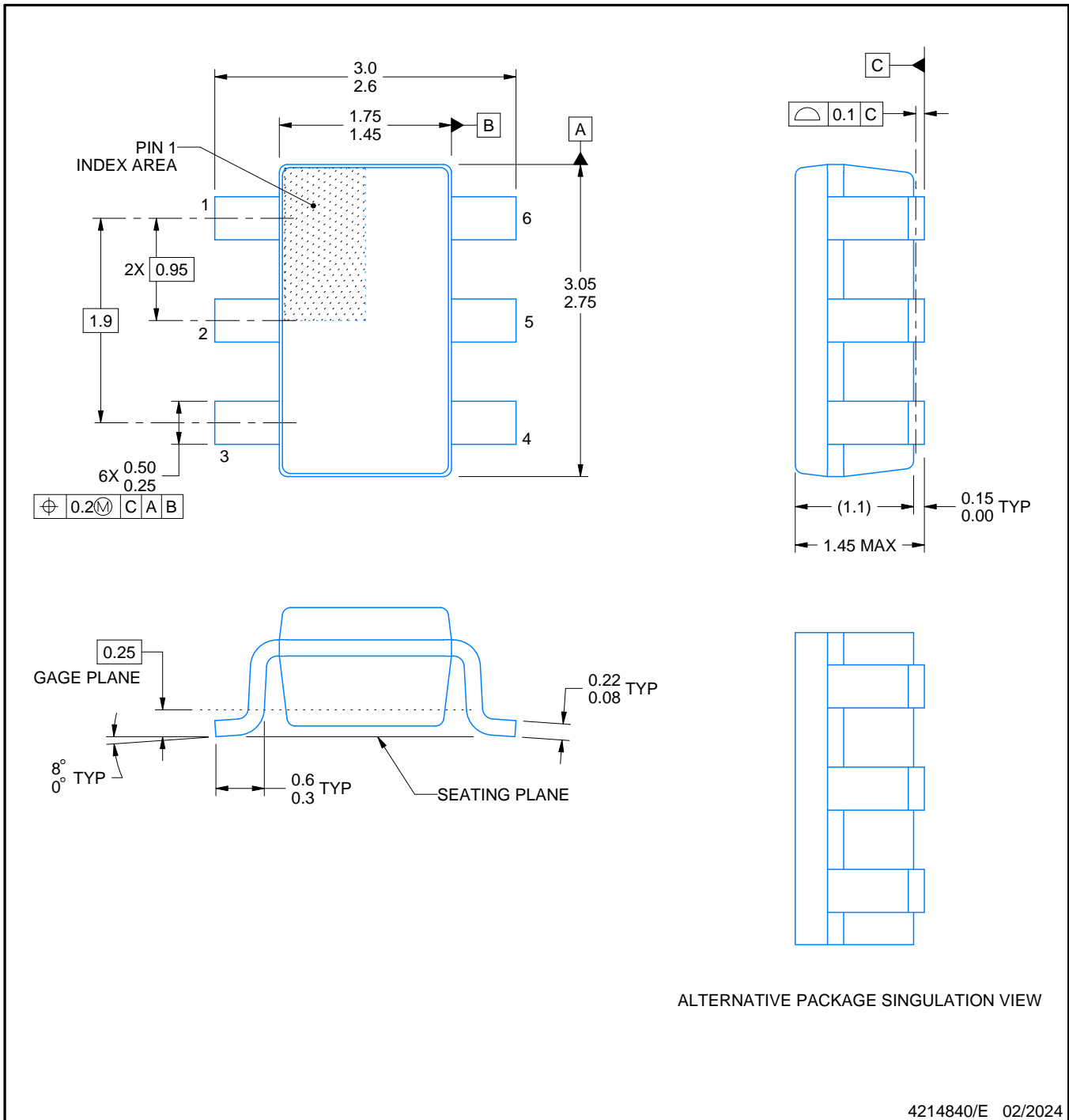


# DBV0006A

# PACKAGE OUTLINE

## SOT-23 - 1.45 mm max height

SMALL OUTLINE TRANSISTOR



### NOTES:

1. All linear dimensions are in millimeters. Any dimensions in parenthesis are for reference only. Dimensioning and tolerancing per ASME Y14.5M.
2. This drawing is subject to change without notice.
3. Body dimensions do not include mold flash or protrusion. Mold flash and protrusion shall not exceed 0.25 per side.
4. Leads 1,2,3 may be wider than leads 4,5,6 for package orientation.
5. Reference JEDEC MO-178.

4214840/E 02/2024

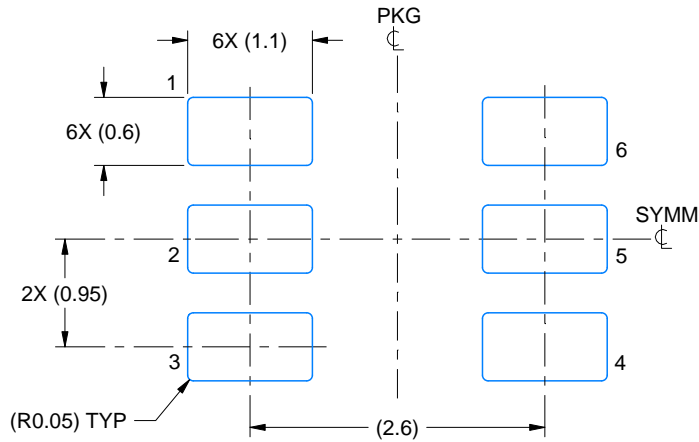


# EXAMPLE BOARD LAYOUT

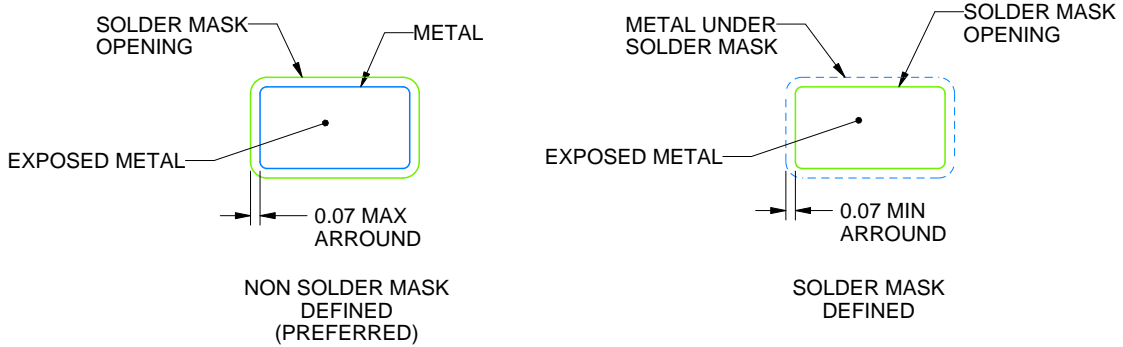
DBV0006A

SOT-23 - 1.45 mm max height

SMALL OUTLINE TRANSISTOR



LAND PATTERN EXAMPLE  
EXPOSED METAL SHOWN  
SCALE:15X



SOLDER MASK DETAILS

4214840/E 02/2024

NOTES: (continued)

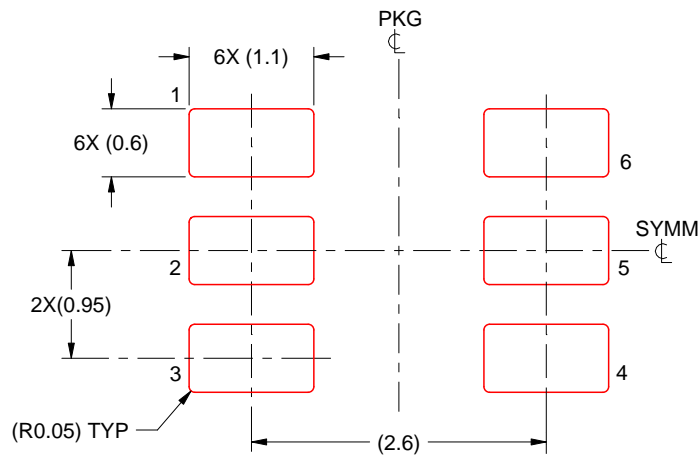
- 6. Publication IPC-7351 may have alternate designs.
- 7. Solder mask tolerances between and around signal pads can vary based on board fabrication site.

# EXAMPLE STENCIL DESIGN

DBV0006A

SOT-23 - 1.45 mm max height

SMALL OUTLINE TRANSISTOR



SOLDER PASTE EXAMPLE  
BASED ON 0.125 mm THICK STENCIL  
SCALE:15X

4214840/E 02/2024

NOTES: (continued)

8. Laser cutting apertures with trapezoidal walls and rounded corners may offer better paste release. IPC-7525 may have alternate design recommendations.
9. Board assembly site may have different recommendations for stencil design.

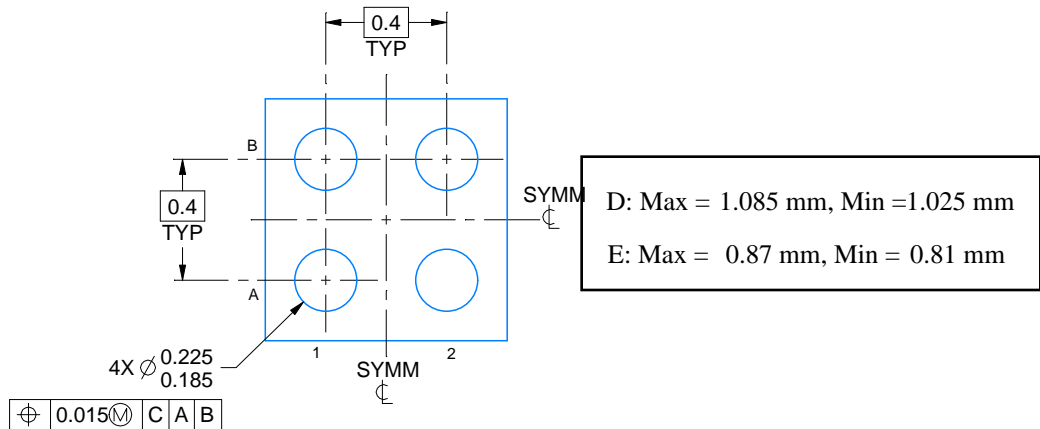
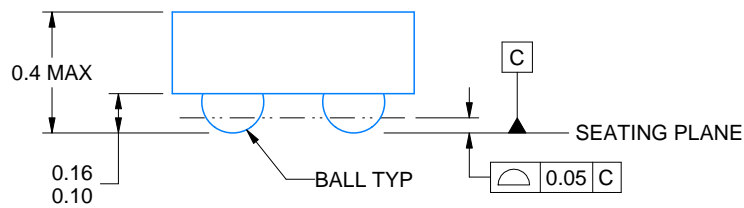
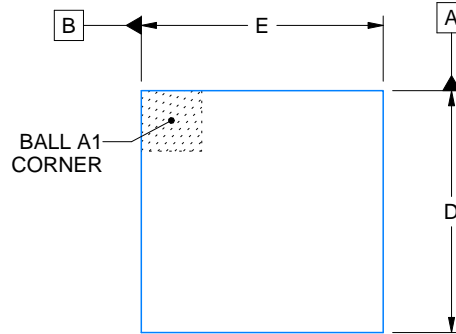
YBH0004



# PACKAGE OUTLINE

DSBGA - 0.4 mm max height

DIE SIZE BALL GRID ARRAY



4224051/A 11/2017

NOTES:

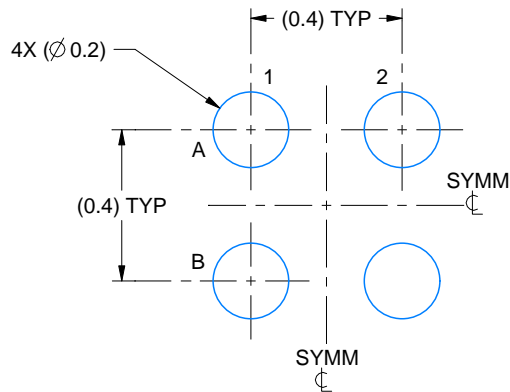
- 1. All linear dimensions are in millimeters. Any dimensions in parenthesis are for reference only. Dimensioning and tolerancing per ASME Y14.5M.
- 2. This drawing is subject to change without notice.

# EXAMPLE BOARD LAYOUT

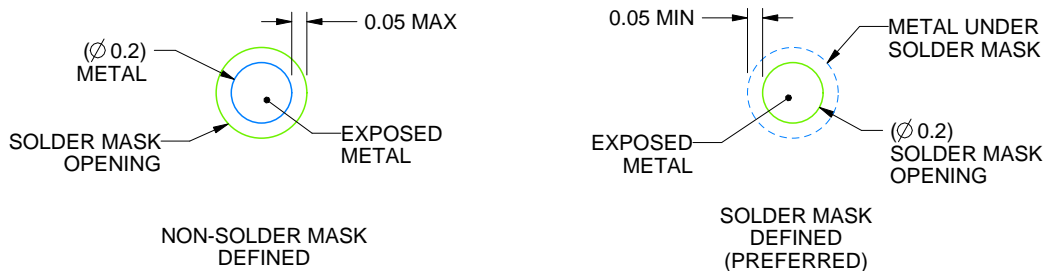
YBH0004

DSBGA - 0.4 mm max height

DIE SIZE BALL GRID ARRAY



LAND PATTERN EXAMPLE  
EXPOSED METAL SHOWN  
SCALE: 50X



SOLDER MASK DETAILS  
NOT TO SCALE

4224051/A 11/2017

NOTES: (continued)

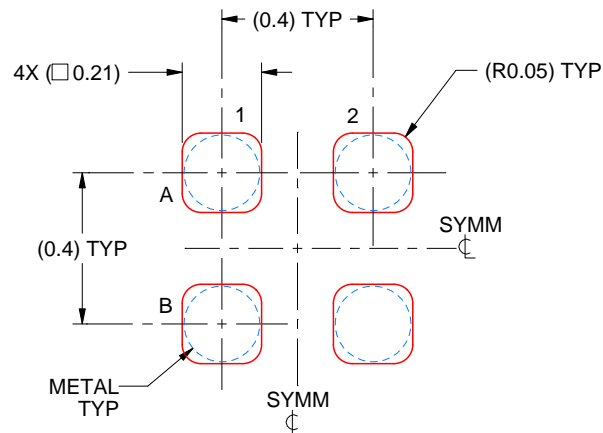
- Final dimensions may vary due to manufacturing tolerance considerations and also routing constraints. See Texas Instruments Literature No. SNVA009 ([www.ti.com/lit/snva009](http://www.ti.com/lit/snva009)).

# EXAMPLE STENCIL DESIGN

YBH0004

DSBGA - 0.4 mm max height

DIE SIZE BALL GRID ARRAY



SOLDER PASTE EXAMPLE  
BASED ON 0.075 mm THICK STENCIL  
SCALE: 50X

4224051/A 11/2017

NOTES: (continued)

4. Laser cutting apertures with trapezoidal walls and rounded corners may offer better paste release.

## IMPORTANT NOTICE AND DISCLAIMER

TI PROVIDES TECHNICAL AND RELIABILITY DATA (INCLUDING DATA SHEETS), DESIGN RESOURCES (INCLUDING REFERENCE DESIGNS), APPLICATION OR OTHER DESIGN ADVICE, WEB TOOLS, SAFETY INFORMATION, AND OTHER RESOURCES "AS IS" AND WITH ALL FAULTS, AND DISCLAIMS ALL WARRANTIES, EXPRESS AND IMPLIED, INCLUDING WITHOUT LIMITATION ANY IMPLIED WARRANTIES OF MERCHANTABILITY, FITNESS FOR A PARTICULAR PURPOSE OR NON-INFRINGEMENT OF THIRD PARTY INTELLECTUAL PROPERTY RIGHTS.

These resources are intended for skilled developers designing with TI products. You are solely responsible for (1) selecting the appropriate TI products for your application, (2) designing, validating and testing your application, and (3) ensuring your application meets applicable standards, and any other safety, security, regulatory or other requirements.

These resources are subject to change without notice. TI grants you permission to use these resources only for development of an application that uses the TI products described in the resource. Other reproduction and display of these resources is prohibited. No license is granted to any other TI intellectual property right or to any third party intellectual property right. TI disclaims responsibility for, and you will fully indemnify TI and its representatives against, any claims, damages, costs, losses, and liabilities arising out of your use of these resources.

TI's products are provided subject to [TI's Terms of Sale](#) or other applicable terms available either on [ti.com](https://www.ti.com) or provided in conjunction with such TI products. TI's provision of these resources does not expand or otherwise alter TI's applicable warranties or warranty disclaimers for TI products.

TI objects to and rejects any additional or different terms you may have proposed.

Mailing Address: Texas Instruments, Post Office Box 655303, Dallas, Texas 75265  
Copyright © 2024, Texas Instruments Incorporated