

Low-Power Differential Line Driver and Receiver Pairs

1 Features

- Designed for high-speed multipoint data transmission over long cables
- Operates with pulse widths as low as 30 ns
- Low supply current: 5 mA max
- Meets or exceeds the standard requirements of ANSI RS-485 and ISO 8482:1987(E)
- Common-mode voltage range of -7 V to 12 V
- Positive- and negative-output current limiting
- Driver thermal shutdown protection
- Pin compatible with the SN75179B

2 Description

The SN65LBC179, SN65LBC179Q, and SN75LBC179 differential driver and receiver pairs are monolithic integrated circuits designed for bidirectional data communication over long cables that take on the characteristics of transmission lines. The devices are balanced, or differential, voltage mode devices that meet or exceed the requirements of industry standards ANSIRS-485 and ISO 8482:1987(E). Both devices are designed using TI's proprietary LinBiCMOS™ with the low power consumption of CMOS and the precision and robustness of bipolar transistors in the same circuit.

The SN65LBC179, SN65LBC179Q, and SN75LBC179 combine a differential line driver and differential line receiver and operate from a single 5-V supply. The driver differential outputs and the receiver differential inputs are connected to separate terminals for full-duplex operation and are designed to present minimum loading to the bus when powered off ($V_{CC} = 0$). These parts feature a wide common-mode voltage range making them suitable for point-to-point or multipoint data bus applications. The devices also provide positive and negative-current limiting and thermal shutdown for protection from line fault conditions. The line driver shuts down at a junction temperature of approximately 172°C .

The SN65LBC179, SN65LBC179Q, and SN75LBC179 are available in the 8-pin dual-in-line and small-outline packages. The SN75LBC179 is characterized for operation over the commercial temperature range of 0°C to 70°C . The SN65LBC179 is characterized over the industrial temperature range of -40°C to 85°C . The SN65LBC179Q is characterized over the extended industrial or automotive temperature range of -40°C to 125°C .

Package Information

PART NUMBER	PACKAGE ⁽¹⁾	BODY SIZE (NOM)
SN75179B	D (SOIC)	4.9 mm x 3.91 mm
	P (PDIP)	9.81 mm x 6.35 mm

(1) For all available packages, see the orderable addendum at the end of the data sheet.

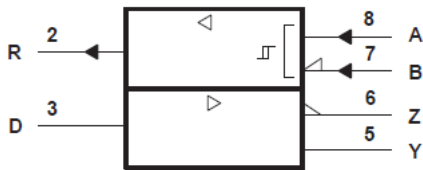

A. This symbol is in accordance with ANSI/IEEE Std 91-1984 and IEC Publication 617-12.

Logic Symbol

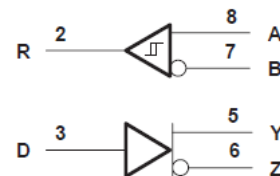

Logic Diagram (Positive Logic)



Table of Contents

1 Features	1	6 Parameter Measurement Information	10
2 Description	1	7 Detailed Description	12
3 Revision History	2	7.1 Functional Block Diagram.....	12
4 Pin Configuration and Functions	3	7.2 Device Functional Modes.....	12
5 Specifications	4	7.3 Thermal Characteristics of IC Packages.....	13
5.1 Absolute Maximum Ratings.....	4	8 Device and Documentation Support	15
5.2 Recommended Operating Conditions.....	4	8.1 Device Support.....	15
5.3 Thermal Information.....	5	8.2 Documentation Support.....	15
5.4 Dissipation Rating Table.....	5	8.3 Receiving Notification of Documentation Updates....	15
5.5 Electrical Characteristics - Driver.....	6	8.4 Support Resources.....	15
5.6 Switching Characteristics - Driver.....	6	8.5 Trademarks.....	15
5.7 Electrical Characteristics - Receiver.....	7	8.6 Electrostatic Discharge Caution.....	15
5.8 Switching Characteristics - Receiver.....	7	8.7 Glossary.....	15
5.9 Typical Characteristics.....	8	9 Mechanical, Packaging, and Orderable Information..	15

3 Revision History

NOTE: Page numbers for previous revisions may differ from page numbers in the current version.

Changes from Revision F (April 2006) to Revision G (October 2022)	Page
• Changed the data sheet format to the latest data sheet format.....	1
• Added the <i>Thermal Information</i> table.....	5

4 Pin Configuration and Functions

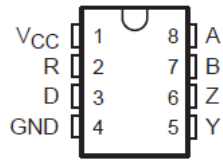

Figure 4-1. D or P Package (Top View)

Table 4-1. Pin Functions

PIN		TYPE ⁽¹⁾	DESCRIPTION
NAME	NO.		
1	V _{CC}	P	5 V Voltage Supply
2	R	O	RS485 Logic Output
3	D	I	RS485 Logic Input
4	GND	G	Ground
5	Y	O	Non-Inverting RS485 Bus Output
6	Z	O	Inverted RS485 Bus Output
7	B	I	Inverted RS485 Bus Input
8	A	I	Non-Inverting RS485 Bus Input

(1) I = Input, O = Output, I/O = Input or Output, G = Ground, P = Power.

5 Specifications

5.1 Absolute Maximum Ratings

See note ⁽¹⁾

		MIN	MAX	UNIT
V _{CC}	Supply voltage range	-0.3	7	V
	Voltage range at A, B, Y, or Z ⁽²⁾	-10	15	V
	Voltage range at D or R ⁽²⁾	-0.3	V _{CC} + 0.5	V
I _O	Receiver output current	±10		mA
	Continuous total power dissipation ⁽³⁾	Internally limited		
P _(AVG)	Average power dissipation R _L = 54 Ω, input to D is 10 Mbps 50% duty cycle square wave, V _{CC} = 5.25 V, T _J = 130°C		330	mW
T _{SD}	Thermal shutdown junction temperature		165	°C
	Total power dissipation	See Section 5.4		

- (1) Stresses beyond those listed under “absolute maximum ratings” may cause permanent damage to the device. These are stress ratings only, and functional operation of the device at these or any other conditions beyond those indicated under “recommended operating conditions” is not implied. Exposure to absolute-maximum-rated conditions for extended periods may affect device reliability.
- (2) All voltage values are with respect to GND.
- (3) The maximum operating junction temperature is internally limited. Uses the dissipation rating table to operate below this temperature.

5.2 Recommended Operating Conditions

		MIN	NOM	MAX	UNIT
V _{CC}	Supply voltage	4.75	5	5.25	V
V _{IH}	High-level input voltage	D	2		V
V _{IL}	Low-level input voltage	D		0.8	V
V _{ID}	Differential input voltage	-6 ⁽¹⁾		6	V
V _O , V _I , or V _{IC}	Voltage at any bus terminal (separately or common-mode)	A, B, Y, or Z	-7	12	V
I _{OH}	High-level output current	Y or Z		-60	mA
		R		-8	
I _{OL}	Low-level output current	Y or Z		60	mA
		R		8	
T _J	Junction temperature			140	°C
T _A	Operating free-air temperature	SN65LBC179	-40	85	°C
		SN65LBC179Q	-40	125	
		SN75LBC179	0	70	

- (1) The algebraic convention, in which the least positive (most negative) limit is designated as minimum, is used in this data sheet for differential input voltage, voltage at any bus terminal (separately or common mode), operating temperature, input threshold voltage, and common-mode output voltage.

5.3 Thermal Information

THERMAL METRIC ⁽¹⁾		D (SOIC)	P (PDIP)	UNIT
		8 Pins	8 Pins	
$R_{\theta JA}$	Junction-to-ambient thermal resistance	116.7	65.6.4	°C/W
$R_{\theta JC(top)}$	Junction-to-case (top) thermal resistance	63.4	54.6	°C/W
$R_{\theta JB}$	Junction-to-board thermal resistance	56.3	42.1	°C/W
Ψ_{JT}	Junction-to-top characterization parameter	8.8	22.9	°C/W
Ψ_{JB}	Junction-to-board characterization parameter	62.6	41.6	°C/W
$R_{\theta JC(bot)}$	Junction-to-case (bottom) thermal resistance	n/a	n/a	°C/W

- (1) See TI application note literature number [SZZA003](#), Package Thermal Characterization Methodologies, for an explanation of this parameter.

5.4 Dissipation Rating Table

PACKAGE	THERMAL MODEL	$T_A < 25^\circ\text{C}$ POWER RATING	DERATING FACTOR ABOVE $T_A = 25^\circ\text{C}$	$T_A = 70^\circ\text{C}$ POWER RATING	$T_A = 85^\circ\text{C}$ POWER RATING
D	Low K ⁽¹⁾	526 mW	5.0 mW/°C	301 mW	226 mW
		882 mW	8.4 mW/°C	504 mW	378 mW
P	High K ⁽²⁾	840 mW	8.0 mW/°C	480 mW	360 mW

- (1) In accordance with the low effective thermal conductivity metric definitions of EIA/JESD 51-3.
 (2) In accordance with the high effective thermal conductivity metric definitions of EIA/JESD 51-7.

5.5 Electrical Characteristics - Driver

over recommended operating conditions (unless otherwise noted)

PARAMETER		TEST CONDITIONS		MIN	TYP ⁽¹⁾	MAX	UNIT
V_{IK}	Input clamp voltage	$I_I = -18 \text{ mA}$				-1.5	V
$ V_{OD} $	Differential output voltage ⁽²⁾	$R_L = 54 \Omega$ See Figure 6-1	SN65LBC179, SN65LBC179Q	1.1	2.2	5	V
			SN75LBC179	1.5	2.2	5	
		$R_L = 60 \Omega$ See Figure 6-2	SN65LBC179, SN65LBC179Q	1.1	2.2	5	
			SN75LBC179	1.5	2.2	5	
$\Delta V_{OD} $	Change in magnitude of differential output voltage ⁽³⁾	See Figure 6-1 and Figure 6-2				± 0.2	V
V_{OC}	Common-mode output voltage			1	2.5	3	V
$\Delta V_{OC} $	Change in magnitude of common-mode output voltage ⁽³⁾	$R_L = 54 \Omega$	See Figure 6-1			± 0.2	V
I_O	Output current with power off	$V_{CC} = 0,$	$V_O = -7 \text{ V to } 12 \text{ V}$			± 100	μA
I_{IH}	High-level input current	$V_I = 2.4 \text{ V}$				-100	μA
I_{IL}	Low-level input current	$V_I = 0.4 \text{ V}$				-100	μA
I_{OS}	Short-circuit output current	$-7 \text{ V} \leq V_O \leq 12 \text{ V}$				± 250	mA
I_{CC}	Supply current	No load	SN65LBC179, SN75LBC179		4.2	5	mA
			SN65LBC179Q		4.2	7	mA

(1) All typical values are at $V_{CC} = 5 \text{ V}$ and $T_A = 25^\circ\text{C}$.

(2) The minimum V_{OD} specification of the SN65179 may not fully comply with ANSI RS-485 at operating temperatures below 0°C . System designers should take the possibly lower output signal into account in determining the maximum signal transmission distance.

(3) $\Delta|V_{OD}|$ and $\Delta|V_{OC}|$ are the changes in the steady-state magnitude of V_{OD} and V_{OC} , respectively, that occur when the input is changed from a high level to a low level.

5.6 Switching Characteristics - Driver

$V_{CC} = 5 \text{ V}, T_A = 25^\circ\text{C}$

PARAMETER		TEST CONDITIONS		MIN	MAX	UNIT
$t_{d(OD)}$	Differential-output delay time	$R_L = 54 \Omega$	See Figure 6-3	7	18	ns
$t_{t(OD)}$	Differential transition time			5	20	ns

5.7 Electrical Characteristics - Receiver

over recommended operating conditions (unless otherwise noted)

PARAMETER		TEST CONDITIONS		MIN	TYP	MAX	UNIT
V_{IT+}	Positive-going input threshold voltage	$I_O = -8\text{ mA}$				0.2	V
V_{IT-}	Negative-going input threshold voltage	$I_O = 8\text{ mA}$		-0.2			V
V_{hys}	Hysteresis voltage ($V_{IT+} - V_{IT-}$)				45		mV
V_{OH}	High-level output voltage	$V_{ID} = 200\text{ mV}$,	$I_{OH} = -8\text{ mA}$	3.5	4.5		V
V_{OL}	Low-level output voltage	$V_{ID} = -200\text{ mV}$,	$I_{OL} = 8\text{ mA}$		0.3	0.5	V
I_I	Bus input current	$V_I = 12\text{ V}$, Other inputs at 0 V,	SN65LBC179, SN75LBC179		0.7	1	mA
		$V_{CC} = 5\text{ V}$	SN65LBC179Q		0.7	1.2	mA
		$V_I = 12\text{ V}$, Other inputs at 0 V,	SN65LBC179, SN75LBC179		0.8	1	mA
		$V_{CC} = 0\text{ V}$	SN65LBC179Q		0.8	1.2	mA
		$V_I = -7\text{ V}$, Other inputs at 0 V,	SN65LBC179, SN75LBC179		-0.5	-0.8	mA
		$V_{CC} = 5\text{ V}$	SN65LBC179Q		-0.5	-1.0	mA
		$V_I = -7\text{ V}$, Other inputs at 0 V,	SN65LBC179, SN75LBC179		-0.5	-0.8	mA
		$V_{CC} = 0\text{ V}$	SN65LBC179Q		-0.5	-1.0	mA

5.8 Switching Characteristics - Receiver

$V_{CC} = 5\text{ V}$, $T_A = 25^\circ\text{C}$

PARAMETER		TEST CONDITIONS		MIN	TYP	MAX	UNIT
t_{PHL}	Propagation delay time, high- to low-level output	$V_{ID} = -1.5\text{ V to }1.5\text{ V}$,	See Figure 6-4	15		30	ns
t_{PLH}	Propagation delay time, low- to high-level output			15		30	ns
$t_{sk(p)}$	Pulse skew ($ t_{PHL} - t_{PLH} $)	See Figure 6-4			3	6	ns
t_t	Transition time				3	5	ns

5.9 Typical Characteristics

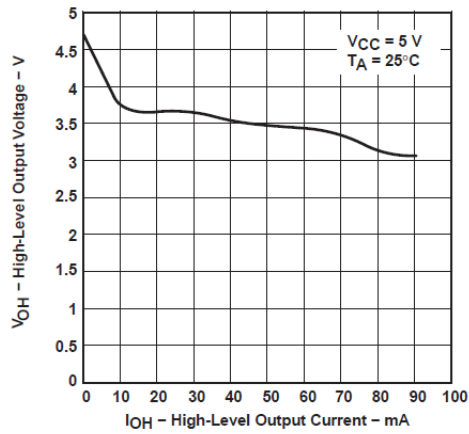

Figure 5-1. Driver High-Level Output Voltage vs High-Level Output Current

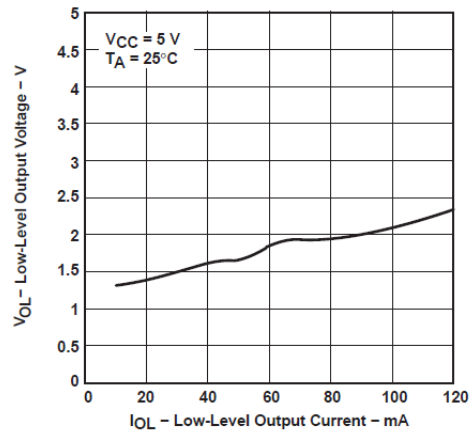

Figure 5-2. Driver Low-Level Output Voltage vs Low-Level Output Current

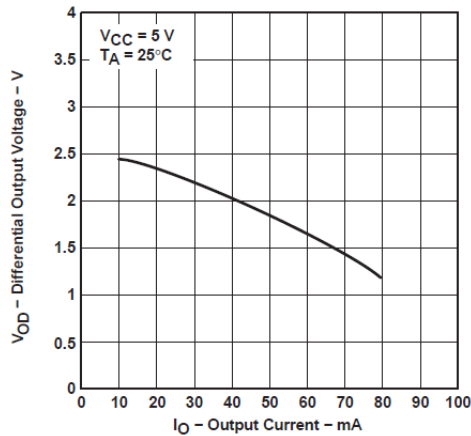

Figure 5-3. Driver Differential Output Voltage vs Output Current

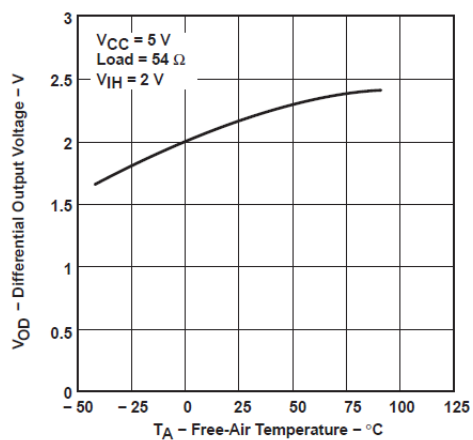

Figure 5-4. Driver Differential Output Voltage vs Free-Air Temperature

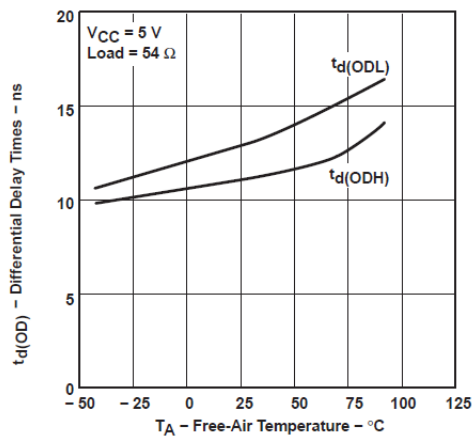

Figure 5-5. Driver Differential Delay Time vs Free-Air Temperature

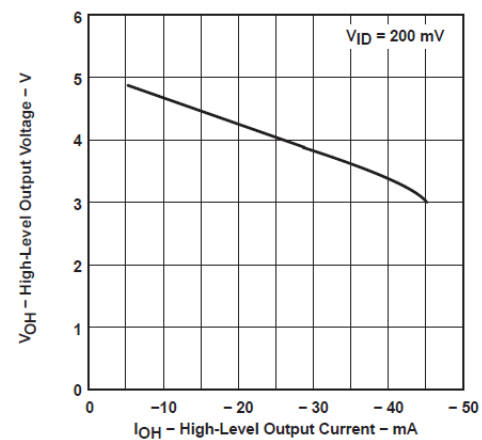

Figure 5-6. Receiver High-Level Output Voltage vs High-Level Output Current

5.9 Typical Characteristics (continued)

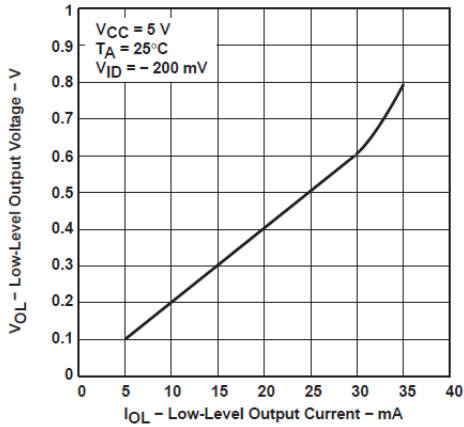

Figure 5-7. Receiver Low-Level Output Voltage vs Low-Level Output Current

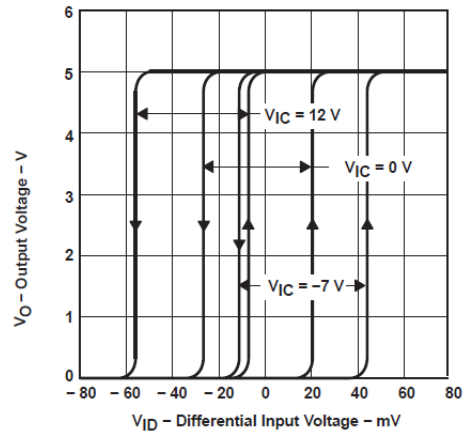

Figure 5-8. Receiver Output Voltage vs Differential Input Voltage

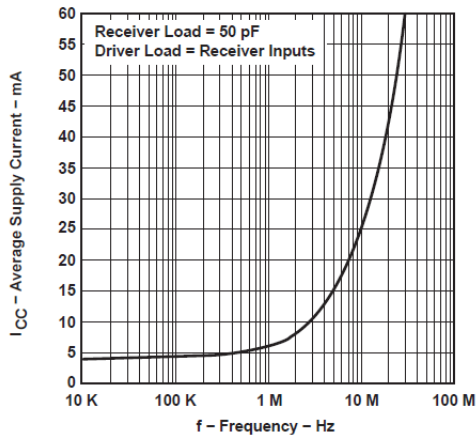

Figure 5-9. Average Supply Current vs Frequency

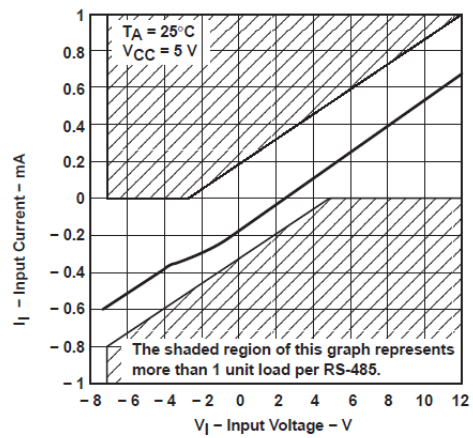

Figure 5-10. Receiver Input Current vs Input Voltage (Complementary Input at 0 V)

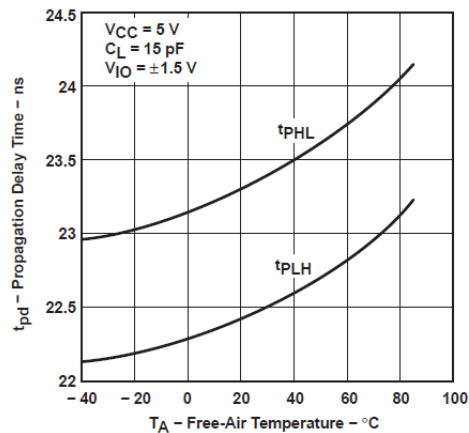

Figure 5-11. Receiver Propagation Delay Time vs Free-Air Temperature

6 Parameter Measurement Information

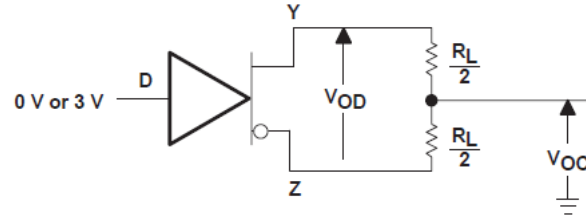

Figure 6-1. Differential and Common-Mode Output Voltage Test Circuit

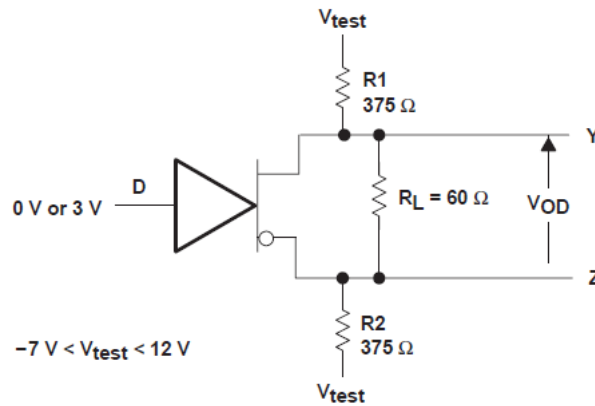
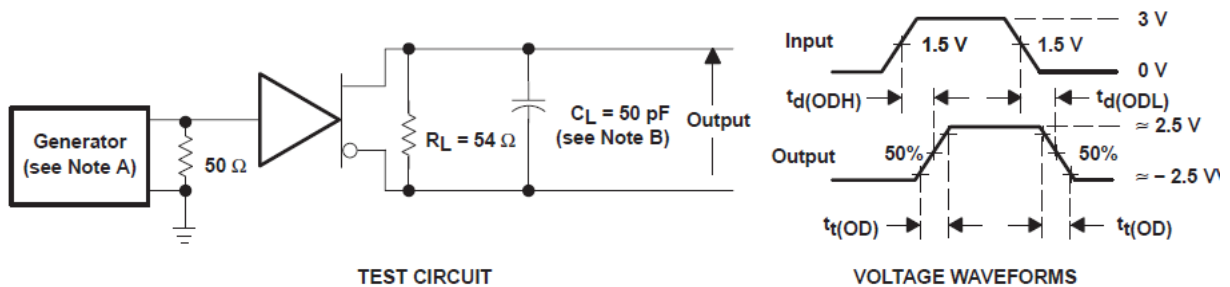
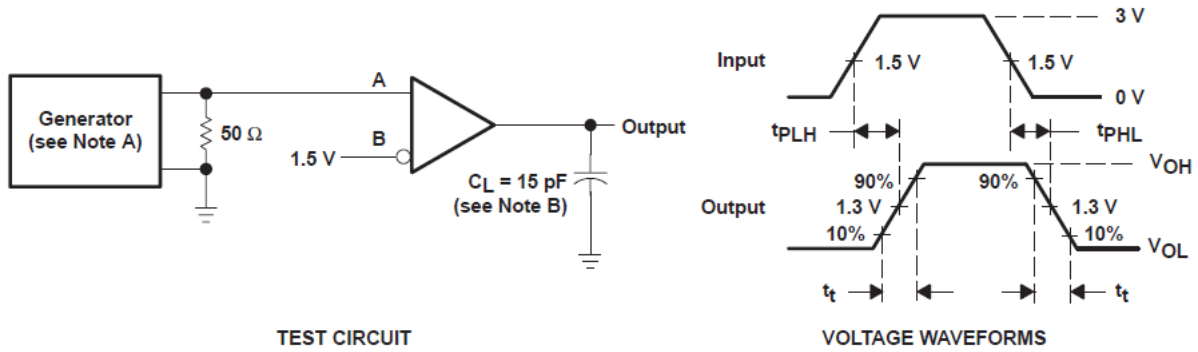

Figure 6-2. Differential Output Voltage Test Circuit



- A. The input pulse is supplied by a generator having the following characteristics: PRR \leq 1 MHz, 50% duty cycle, $t_r \leq$ 6 ns, $t_f \leq$ 6 ns, $Z_O = 50 \Omega$.
- B. C_L includes probe and jig capacitance.

Figure 6-3. Driver Test Circuits and Differential Output Delay and Transition Time Voltage Waveforms



- A. The input pulse is supplied by a generator having the following characteristics: PRR \leq 1 MHz, 50% duty cycle, $t_r \leq$ 6 ns, $t_f \leq$ 6 ns, $Z_O = 50 \Omega$.
- B. C_L includes probe and jig capacitance.

Figure 6-4. Receiver Test Circuit and Propagation Delay and Transition Time Voltage Waveforms

7 Detailed Description

7.1 Functional Block Diagram

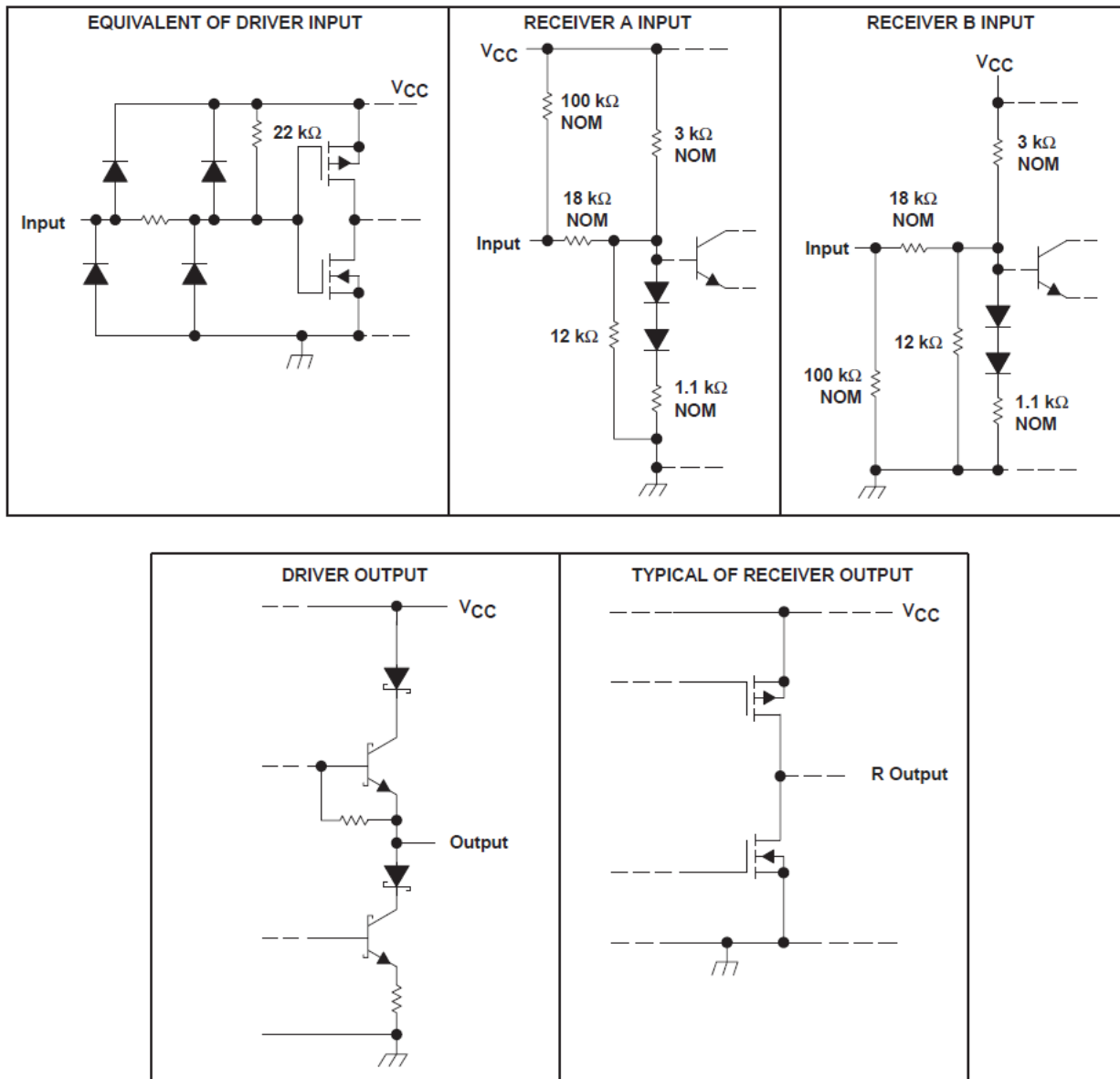

Figure 7-1. Schematics of Inputs and Outputs

7.2 Device Functional Modes

Function Tables

Table 7-1. Driver⁽¹⁾

INPUT D	OUTPUTS	
	Y	Z
H	H	L
L	L	H

(1) H = high level, L = low level, ? = indeterminate

Table 7-2. Receiver⁽¹⁾

DIFFERENTIAL INPUTS A-B	OUTPUT R
$V_{ID} \geq 0.2 \text{ V}$	H
$-0.2 \text{ V} < V_{ID} < 0.2 \text{ V}$?
$V_{ID} \leq -0.2 \text{ V}$	L
Open circuit	H

(1) H = high level, L = low level, ? = indeterminate

7.3 Thermal Characteristics of IC Packages

θ_{JA} (Junction-to-Ambient Thermal Resistance) is defined as the difference in junction temperature to ambient temperature divided by the operating power.

θ_{JA} is not a constant and is a strong function of:

- the PCB design (50% variation)
- altitude (20% variation)
- device power (5% variation)

θ_{JA} can be used to compare the thermal performance of packages if the specific test conditions are defined and used. Standardized testing includes specification of PCB construction, test chamber volume, sensor locations, and the thermal characteristics of holding fixtures. θ_{JA} is often misused when it is used to calculate junction temperatures for other installations.

TI uses two test PCBs as defined by JEDEC specifications. The low-k board gives *average* in-use condition thermal performance and consists of a single trace layer 25 mm long and 2-oz thick copper. The high-k board gives *best case* in-use condition and consists of two 1-oz buried power planes with a single trace layer 25 mm long with 2-oz thick copper. A 4% to 50% difference in θ_{JA} can be measured between these two test cards.

θ_{JC} (Junction-to-Case Thermal Resistance) is defined as difference in junction temperature to case divided by the operating power. It is measured by putting the mounted package up against a copper block cold plate to force heat to flow from die, through the mold compound into the copper block.

θ_{JC} is a useful thermal characteristic when a heatsink is applied to package. It is not a useful characteristic to predict junction temperature as it provides pessimistic numbers if the case temperature is measured in a non-standard system and junction temperatures are backed out. It can be used with θ_{jb} in 1-dimensional thermal simulation of a package system.

θ_{JB} (Junction-to-Board Thermal Resistance) is defined to be the difference in the junction temperature and the PCB temperature at the center of the package (closest to the die) when the PCB is clamped in a cold-plate structure. θ_{jb} is only defined for the high-k test card.

θ_{JB} provide an overall thermal resistance between the die and the PCB. It includes a bit of the PCB thermal resistance (especially for BGAs with thermal balls) and can be used for simple 1-dimensional network analysis of package system (see [Figure 7-2](#)).

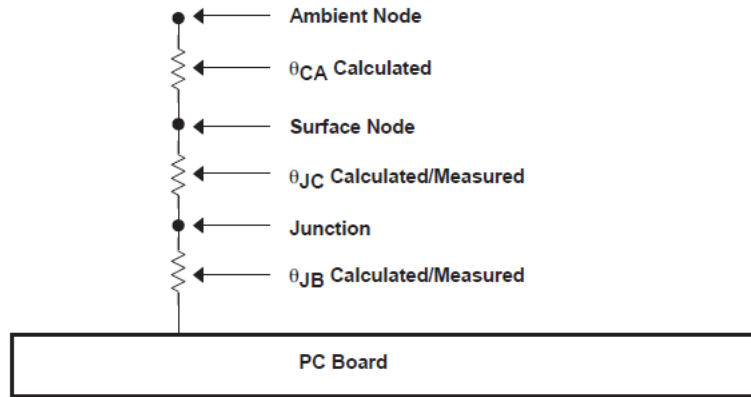

Figure 7-2. Thermal Resistance

8 Device and Documentation Support

TI offers an extensive line of development tools. Tools and software to evaluate the performance of the device, generate code, and develop solutions are listed below.

8.1 Device Support

8.2 Documentation Support

8.2.1 Related Documentation

8.3 Receiving Notification of Documentation Updates

To receive notification of documentation updates, navigate to the device product folder on ti.com. Click on *Subscribe to updates* to register and receive a weekly digest of any product information that has changed. For change details, review the revision history included in any revised document.

8.4 Support Resources

TI E2E™ [support forums](#) are an engineer's go-to source for fast, verified answers and design help — straight from the experts. Search existing answers or ask your own question to get the quick design help you need.

Linked content is provided "AS IS" by the respective contributors. They do not constitute TI specifications and do not necessarily reflect TI's views; see TI's [Terms of Use](#).

8.5 Trademarks

LinBiCMOS™ is a trademark of LinBiCMOS.

TI E2E™ is a trademark of Texas Instruments.

All trademarks are the property of their respective owners.

8.6 Electrostatic Discharge Caution



This integrated circuit can be damaged by ESD. Texas Instruments recommends that all integrated circuits be handled with appropriate precautions. Failure to observe proper handling and installation procedures can cause damage.

ESD damage can range from subtle performance degradation to complete device failure. Precision integrated circuits may be more susceptible to damage because very small parametric changes could cause the device not to meet its published specifications.

8.7 Glossary

[TI Glossary](#) This glossary lists and explains terms, acronyms, and definitions.

9 Mechanical, Packaging, and Orderable Information

The following pages include mechanical, packaging, and orderable information. This information is the most current data available for the designated devices. This data is subject to change without notice and revision of this document. For browser-based versions of this data sheet, refer to the left-hand navigation.

PACKAGING INFORMATION

Orderable part number	Status (1)	Material type (2)	Package Pins	Package qty Carrier	RoHS (3)	Lead finish/ Ball material (4)	MSL rating/ Peak reflow (5)	Op temp (°C)	Part marking (6)
SN65LBC179DR	Active	Production	SOIC (D) 8	2500 LARGE T&R	Yes	NIPDAU	Level-1-260C-UNLIM	-40 to 85	6LB179
SN65LBC179P	Active	Production	PDIP (P) 8	50 TUBE	Yes	NIPDAU	N/A for Pkg Type	-40 to 85	65LBC179
SN65LBC179QD	Obsolete	Production	SOIC (D) 8	-	-	Call TI	Call TI	-40 to 125	LB179Q
SN65LBC179QDR	Active	Production	SOIC (D) 8	2500 LARGE T&R	Yes	NIPDAU	Level-1-260C-UNLIM	-40 to 125	LB179Q
SN65LBC179QDRG4	Obsolete	Production	SOIC (D) 8	-	-	Call TI	Call TI	-40 to 125	LB179Q
SN75LBC179D	Obsolete	Production	SOIC (D) 8	-	-	Call TI	Call TI	0 to 70	7LB179
SN75LBC179P	Active	Production	PDIP (P) 8	50 TUBE	Yes	NIPDAU	N/A for Pkg Type	0 to 70	75LBC179

(1) **Status:** For more details on status, see our [product life cycle](#).

(2) **Material type:** When designated, preproduction parts are prototypes/experimental devices, and are not yet approved or released for full production. Testing and final process, including without limitation quality assurance, reliability performance testing, and/or process qualification, may not yet be complete, and this item is subject to further changes or possible discontinuation. If available for ordering, purchases will be subject to an additional waiver at checkout, and are intended for early internal evaluation purposes only. These items are sold without warranties of any kind.

(3) **RoHS values:** Yes, No, RoHS Exempt. See the [TI RoHS Statement](#) for additional information and value definition.

(4) **Lead finish/Ball material:** Parts may have multiple material finish options. Finish options are separated by a vertical ruled line. Lead finish/Ball material values may wrap to two lines if the finish value exceeds the maximum column width.

(5) **MSL rating/Peak reflow:** The moisture sensitivity level ratings and peak solder (reflow) temperatures. In the event that a part has multiple moisture sensitivity ratings, only the lowest level per JEDEC standards is shown. Refer to the shipping label for the actual reflow temperature that will be used to mount the part to the printed circuit board.

(6) **Part marking:** There may be an additional marking, which relates to the logo, the lot trace code information, or the environmental category of the part.

Multiple part markings will be inside parentheses. Only one part marking contained in parentheses and separated by a "~" will appear on a part. If a line is indented then it is a continuation of the previous line and the two combined represent the entire part marking for that device.

Important Information and Disclaimer: The information provided on this page represents TI's knowledge and belief as of the date that it is provided. TI bases its knowledge and belief on information provided by third parties, and makes no representation or warranty as to the accuracy of such information. Efforts are underway to better integrate information from third parties. TI has taken and continues to take reasonable steps to provide representative and accurate information but may not have conducted destructive testing or chemical analysis on incoming materials and chemicals. TI and TI suppliers consider certain information to be proprietary, and thus CAS numbers and other limited information may not be available for release.

In no event shall TI's liability arising out of such information exceed the total purchase price of the TI part(s) at issue in this document sold by TI to Customer on an annual basis.

TAPE AND REEL INFORMATION

QUADRANT ASSIGNMENTS FOR PIN 1 ORIENTATION IN TAPE

*All dimensions are nominal

Device	Package Type	Package Drawing	Pins	SPQ	Reel Diameter (mm)	Reel Width W1 (mm)	A0 (mm)	B0 (mm)	K0 (mm)	P1 (mm)	W (mm)	Pin1 Quadrant
SN65LBC179DR	SOIC	D	8	2500	330.0	12.4	6.4	5.2	2.1	8.0	12.0	Q1

TAPE AND REEL BOX DIMENSIONS

*All dimensions are nominal

Device	Package Type	Package Drawing	Pins	SPQ	Length (mm)	Width (mm)	Height (mm)
SN65LBC179DR	SOIC	D	8	2500	356.0	356.0	35.0

TUBE

*All dimensions are nominal

Device	Package Name	Package Type	Pins	SPQ	L (mm)	W (mm)	T (μm)	B (mm)
SN65LBC179P	P	PDIP	8	50	506	13.97	11230	4.32
SN75LBC179P	P	PDIP	8	50	506	13.97	11230	4.32



D0008A

PACKAGE OUTLINE

SOIC - 1.75 mm max height

SMALL OUTLINE INTEGRATED CIRCUIT



4214825/C 02/2019

NOTES:

1. Linear dimensions are in inches [millimeters]. Dimensions in parenthesis are for reference only. Controlling dimensions are in inches. Dimensioning and tolerancing per ASME Y14.5M.
2. This drawing is subject to change without notice.
3. This dimension does not include mold flash, protrusions, or gate burrs. Mold flash, protrusions, or gate burrs shall not exceed $.006$ [0.15] per side.
4. This dimension does not include interlead flash.
5. Reference JEDEC registration MS-012, variation AA.

EXAMPLE BOARD LAYOUT

D0008A

SOIC - 1.75 mm max height

SMALL OUTLINE INTEGRATED CIRCUIT



LAND PATTERN EXAMPLE
EXPOSED METAL SHOWN
SCALE:8X



SOLDER MASK DETAILS

4214825/C 02/2019

NOTES: (continued)

6. Publication IPC-7351 may have alternate designs.

7. Solder mask tolerances between and around signal pads can vary based on board fabrication site.

EXAMPLE STENCIL DESIGN

D0008A

SOIC - 1.75 mm max height

SMALL OUTLINE INTEGRATED CIRCUIT



SOLDER PASTE EXAMPLE
BASED ON .005 INCH [0.125 MM] THICK STENCIL
SCALE:8X

4214825/C 02/2019

NOTES: (continued)

8. Laser cutting apertures with trapezoidal walls and rounded corners may offer better paste release. IPC-7525 may have alternate design recommendations.
9. Board assembly site may have different recommendations for stencil design.

P (R-PDIP-T8)

PLASTIC DUAL-IN-LINE PACKAGE



4040082/E 04/2010

- NOTES:
- A. All linear dimensions are in inches (millimeters).
 - B. This drawing is subject to change without notice.
 - C. Falls within JEDEC MS-001 variation BA.

IMPORTANT NOTICE AND DISCLAIMER

TI PROVIDES TECHNICAL AND RELIABILITY DATA (INCLUDING DATA SHEETS), DESIGN RESOURCES (INCLUDING REFERENCE DESIGNS), APPLICATION OR OTHER DESIGN ADVICE, WEB TOOLS, SAFETY INFORMATION, AND OTHER RESOURCES "AS IS" AND WITH ALL FAULTS, AND DISCLAIMS ALL WARRANTIES, EXPRESS AND IMPLIED, INCLUDING WITHOUT LIMITATION ANY IMPLIED WARRANTIES OF MERCHANTABILITY, FITNESS FOR A PARTICULAR PURPOSE OR NON-INFRINGEMENT OF THIRD PARTY INTELLECTUAL PROPERTY RIGHTS.

These resources are intended for skilled developers designing with TI products. You are solely responsible for (1) selecting the appropriate TI products for your application, (2) designing, validating and testing your application, and (3) ensuring your application meets applicable standards, and any other safety, security, regulatory or other requirements.

These resources are subject to change without notice. TI grants you permission to use these resources only for development of an application that uses the TI products described in the resource. Other reproduction and display of these resources is prohibited. No license is granted to any other TI intellectual property right or to any third party intellectual property right. TI disclaims responsibility for, and you will fully indemnify TI and its representatives against, any claims, damages, costs, losses, and liabilities arising out of your use of these resources.

TI's products are provided subject to [TI's Terms of Sale](#) or other applicable terms available either on [ti.com](https://www.ti.com) or provided in conjunction with such TI products. TI's provision of these resources does not expand or otherwise alter TI's applicable warranties or warranty disclaimers for TI products.

TI objects to and rejects any additional or different terms you may have proposed.

Mailing Address: Texas Instruments, Post Office Box 655303, Dallas, Texas 75265

Copyright © 2025, Texas Instruments Incorporated