

- Standard '245-Type Pinout
- 5-Ω Switch Connection Between Two Ports
- TTL-Compatible Input Levels

**DB, DBQ, DGV, DW, OR PW PACKAGE  
(TOP VIEW)**

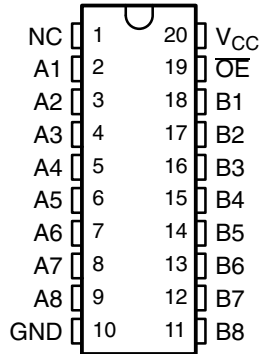

NC – No internal connection

**RGY PACKAGE  
(TOP VIEW)**

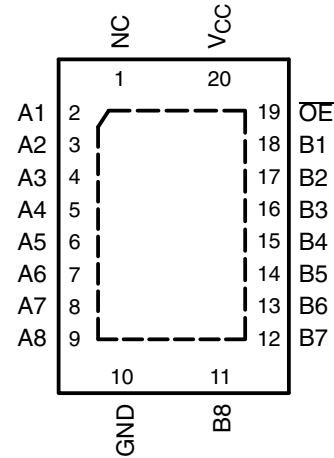

NC – No internal connection

**GQN OR ZQN PACKAGE  
(TOP VIEW)**

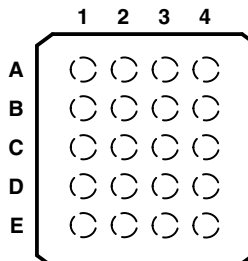

### terminal assignments

	1	2	3	4
A	A1	NC	V <sub>CC</sub>	OE
B	A3	B2	A2	B1
C	A5	A4	B4	B3
D	A7	B6	A6	B5
E	GND	A8	B8	B7

NC – No internal connection

### description/ordering information

The SN74CBT3245A provides eight bits of high-speed TTL-compatible bus switching. The SOIC, SSOP, TSSOP, and TVSOP packages provide a standard '245 device pinout. The low on-state resistance of the switch allows connections to be made with minimal propagation delay.

The device is organized as one 8-bit switch. When the output-enable ( $\overline{OE}$ ) input is low, the switch is on, and port A is connected to port B. When  $\overline{OE}$  is high, the switch is open, and the high-impedance state exists between the two ports.

To ensure the high-impedance state during power up or power down,  $\overline{OE}$  should be tied to V<sub>CC</sub> through a pullup resistor; the minimum value of the resistor is determined by the current-sinking capability of the driver.



Please be aware that an important notice concerning availability, standard warranty, and use in critical applications of Texas Instruments semiconductor products and disclaimers thereto appears at the end of this data sheet.

**PRODUCTION DATA** information is current as of publication date. Products conform to specifications per the terms of Texas Instruments standard warranty. Production processing does not necessarily include testing of all parameters.

**TEXAS  
INSTRUMENTS**

POST OFFICE BOX 655303 • DALLAS, TEXAS 75265

Copyright © 2004, Texas Instruments Incorporated

# SN74CBT3245A OCTAL FET BUS SWITCH

SCDS002Q – NOVEMBER 1992 – REVISED DECEMBER 2004

## description/ordering information (continued)

### ORDERING INFORMATION

T <sub>A</sub>	PACKAGE†		ORDERABLE PART NUMBER	TOP-SIDE MARKING
-40°C to 85°C	QFN – RGY	Tape and reel	SN74CBT3245ARGYR	CU245A
	SOIC – DW	Tube	SN74CBT3245ADW	CBT3245A
		Tape and reel	SN74CBT3245ADWR	
	SSOP – DB	Tape and reel	SN74CBT3245ADBR	CU245A
	SSOP (QSOP) – DBQ	Tape and reel	SN74CBT3245ADBQR	CBT3245A
	TSSOP – PW	Tube	SN74CBT3245APW	CU245A
		Tape and reel	SN74CBT3245APWR	
	TVSOP – DGV	Tape and reel	SN74CBT3245ADGVR	CU245A
VFBGA – QQN	Tape and reel	SN74CBT3245AGQNR	CU245A	
		SN74CBT3245AZQNR		

† Package drawings, standard packing quantities, thermal data, symbolization, and PCB design guidelines are available at [www.ti.com/sc/package](http://www.ti.com/sc/package).

### FUNCTION TABLE

INPUT OE	FUNCTION
L	A port = B port
H	Disconnect

### logic diagram (positive logic)

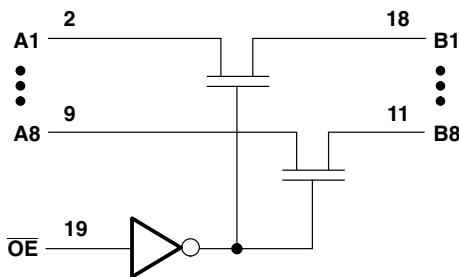

Pin numbers shown are for the DB, DBQ, DGV, DW, PW, and RGY packages.

**absolute maximum ratings over operating free-air temperature range (unless otherwise noted)†**

Supply voltage range, $V_{CC}$ .....	-0.5 V to 7 V
Input voltage range, $V_I$ (see Note 1) .....	-0.5 V to 7 V
Continuous channel current .....	128 mA
Input clamp current, $I_{IK}$ ( $V_{I/O} < 0$ ) .....	-50 mA
Package thermal impedance, $\theta_{JA}$ (see Note 2): DB package .....	70°C/W
(see Note 2): DBQ package .....	68°C/W
(see Note 2): DGV package .....	92°C/W
(see Note 2): DW package .....	58°C/W
(see Note 2): GQN/ZQN package .....	78°C/W
(see Note 2): PW package .....	83°C/W
(see Note 3): RGY package .....	37°C/W
Storage temperature range, $T_{stg}$ .....	-65°C to 150°C

† Stresses beyond those listed under “absolute maximum ratings” may cause permanent damage to the device. These are stress ratings only, and functional operation of the device at these or any other conditions beyond those indicated under “recommended operating conditions” is not implied. Exposure to absolute-maximum-rated conditions for extended periods may affect device reliability.

- NOTES: 1. The input and output negative-voltage ratings may be exceeded if the input and output clamp-current ratings are observed.  
 2. The package thermal impedance is calculated in accordance with JESD 51-7.  
 3. The package thermal impedance is calculated in accordance with JESD 51-5.

**recommended operating conditions (see Note 4)**

	MIN	MAX	UNIT
$V_{CC}$ Supply voltage	4	5.5	V
$V_{IH}$ High-level control input voltage	2		V
$V_{IL}$ Low-level control input voltage		0.8	V
$T_A$ Operating free-air temperature	-40	85	°C

NOTE 4: All unused control inputs of the device must be held at  $V_{CC}$  or GND to ensure proper device operation. Refer to the TI application report, *Implications of Slow or Floating CMOS Inputs*, literature number SCBA004.

**electrical characteristics over recommended operating free-air temperature range (unless otherwise noted)**

PARAMETER	TEST CONDITIONS		MIN	TYP‡	MAX	UNIT	
$V_{IK}$	$V_{CC} = 4.5$ V,	$I_I = -18$ mA			-1.2	V	
$I_I$	$V_{CC} = 5.5$ V,	$V_I = 5.5$ V or GND			±5	µA	
$I_{CC}$	$V_{CC} = 5.5$ V,	$I_O = 0$ , $V_I = V_{CC}$ or GND			50	µA	
$\Delta I_{CC}^{\S}$ Control inputs	$V_{CC} = 5.5$ V,	One input at 3.4 V, Other inputs at $V_{CC}$ or GND			3.5	mA	
$C_i$ Control inputs	$V_I = 3$ V or 0			4		pF	
$C_{iO(OFF)}$	$V_O = 3$ V or 0,	$\overline{OE} = V_{CC}$		4		pF	
$r_{on}^{\parallel}$	$V_{CC} = 4.5$ V	$V_I = 0$		5	7	Ω	
			$I_I = 64$ mA				
			$I_I = 30$ mA		5		7
		$V_I = 2.4$ V,	$I_I = 15$ mA		10	15	

‡ All typical values are at  $V_{CC} = 5$  V (unless otherwise noted),  $T_A = 25^\circ\text{C}$ .

§ This is the increase in supply current for each input that is at the specified TTL voltage level, rather than  $V_{CC}$  or GND.

∥ Measured by the voltage drop between the A and B terminals at the indicated current through the switch. On-state resistance is determined by the lowest voltage of the two (A or B) terminals.

# SN74CBT3245A OCTAL FET BUS SWITCH

SCDS002Q – NOVEMBER 1992 – REVISED DECEMBER 2004

switching characteristics over recommended operating free-air temperature range,  $C_L = 50$  pF (unless otherwise noted) (see Figure 1)

PARAMETER	FROM (INPUT)	TO (OUTPUT)	$V_{CC} = 4$ V		$V_{CC} = 5$ V $\pm 0.5$ V		UNIT
			MIN	MAX	MIN	MAX	
$t_{pd}^\dagger$	A or B	B or A	0.35		0.25		ns
$t_{en}$	$\overline{OE}$	A or B	6.4		1.9	5.9	ns
$t_{dis}$	$\overline{OE}$	A or B	5.7		2.1	6	ns

$^\dagger$  The propagation delay is the calculated RC time constant of the typical on-state resistance of the switch and the specified load capacitance, when driven by an ideal voltage source (zero output impedance).

## PARAMETER MEASUREMENT INFORMATION

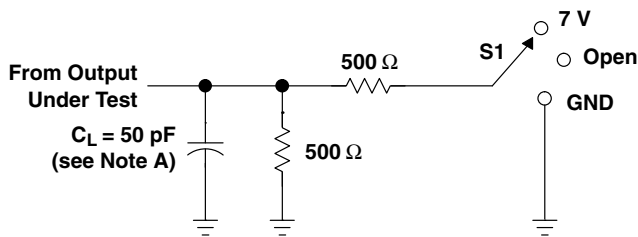

LOAD CIRCUIT

TEST	S1
$t_{pd}$	Open
$t_{PLZ}/t_{PZH}$	7 V
$t_{PHZ}/t_{PZH}$	Open

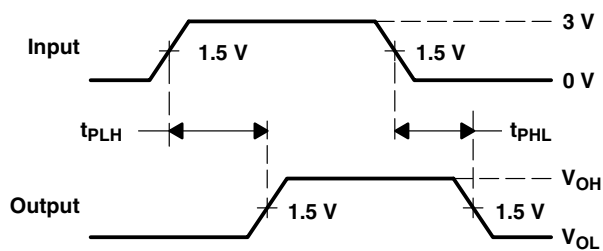

VOLTAGE WAVEFORMS  
PROPAGATION DELAY TIMES

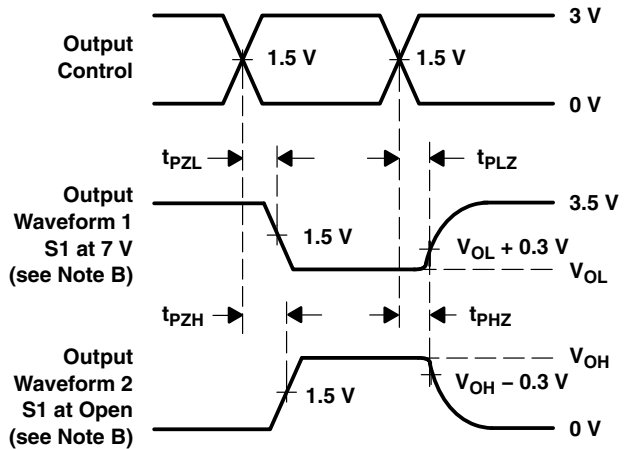

VOLTAGE WAVEFORMS  
ENABLE AND DISABLE TIMES

- NOTES:
- $C_L$  includes probe and jig capacitance.
  - Waveform 1 is for an output with internal conditions such that the output is low, except when disabled by the output control. Waveform 2 is for an output with internal conditions such that the output is high, except when disabled by the output control.
  - All input pulses are supplied by generators having the following characteristics:  $PRR \leq 10$  MHz,  $Z_O = 50 \Omega$ ,  $t_r \leq 2.5$  ns,  $t_f \leq 2.5$  ns.
  - The outputs are measured one at a time, with one transition per measurement.
  - $t_{PLZ}$  and  $t_{PHZ}$  are the same as  $t_{dis}$ .
  - $t_{PZL}$  and  $t_{PZH}$  are the same as  $t_{en}$ .
  - $t_{PLH}$  and  $t_{PHL}$  are the same as  $t_{pd}$ .
  - All parameters and waveforms are not applicable to all devices.

Figure 1. Load Circuit and Voltage Waveforms

**PACKAGING INFORMATION**

Orderable part number	Status (1)	Material type (2)	Package   Pins	Package qty   Carrier	RoHS (3)	Lead finish/ Ball material (4)	MSL rating/ Peak reflow (5)	Op temp (°C)	Part marking (6)
SN74CBT3245ADBR	NRND	Production	SSOP (DB)   20	2000   LARGE T&R	Yes	NIPDAU	Level-1-260C-UNLIM	-40 to 85	CU245A
SN74CBT3245ADGVR	Obsolete	Production	TVSOP (DGV)   20	-	-	Call TI	Call TI	-40 to 85	CU245A
SN74CBT3245ADW	Obsolete	Production	SOIC (DW)   20	-	-	Call TI	Call TI	-40 to 85	CBT3245A
SN74CBT3245ADWR	Obsolete	Production	SOIC (DW)   20	-	-	Call TI	Call TI	-40 to 85	CBT3245A
SN74CBT3245APW	Obsolete	Production	TSSOP (PW)   20	-	-	Call TI	Call TI	-40 to 85	CU245A
SN74CBT3245APWR	Obsolete	Production	TSSOP (PW)   20	-	-	Call TI	Call TI	-40 to 85	CU245A
SN74CBT3245ARGYR	Obsolete	Production	VQFN (RGY)   20	-	-	Call TI	Call TI	-40 to 85	CU245A

(1) **Status:** For more details on status, see our [product life cycle](#).

(2) **Material type:** When designated, preproduction parts are prototypes/experimental devices, and are not yet approved or released for full production. Testing and final process, including without limitation quality assurance, reliability performance testing, and/or process qualification, may not yet be complete, and this item is subject to further changes or possible discontinuation. If available for ordering, purchases will be subject to an additional waiver at checkout, and are intended for early internal evaluation purposes only. These items are sold without warranties of any kind.

(3) **RoHS values:** Yes, No, RoHS Exempt. See the [TI RoHS Statement](#) for additional information and value definition.

(4) **Lead finish/Ball material:** Parts may have multiple material finish options. Finish options are separated by a vertical ruled line. Lead finish/Ball material values may wrap to two lines if the finish value exceeds the maximum column width.

(5) **MSL rating/Peak reflow:** The moisture sensitivity level ratings and peak solder (reflow) temperatures. In the event that a part has multiple moisture sensitivity ratings, only the lowest level per JEDEC standards is shown. Refer to the shipping label for the actual reflow temperature that will be used to mount the part to the printed circuit board.

(6) **Part marking:** There may be an additional marking, which relates to the logo, the lot trace code information, or the environmental category of the part.

Multiple part markings will be inside parentheses. Only one part marking contained in parentheses and separated by a "-" will appear on a part. If a line is indented then it is a continuation of the previous line and the two combined represent the entire part marking for that device.

**Important Information and Disclaimer:**The information provided on this page represents TI's knowledge and belief as of the date that it is provided. TI bases its knowledge and belief on information provided by third parties, and makes no representation or warranty as to the accuracy of such information. Efforts are underway to better integrate information from third parties. TI has taken and continues to take reasonable steps to provide representative and accurate information but may not have conducted destructive testing or chemical analysis on incoming materials and chemicals. TI and TI suppliers consider certain information to be proprietary, and thus CAS numbers and other limited information may not be available for release.

In no event shall TI's liability arising out of such information exceed the total purchase price of the TI part(s) at issue in this document sold by TI to Customer on an annual basis.



**TAPE AND REEL INFORMATION**

**QUADRANT ASSIGNMENTS FOR PIN 1 ORIENTATION IN TAPE**

\*All dimensions are nominal

Device	Package Type	Package Drawing	Pins	SPQ	Reel Diameter (mm)	Reel Width W1 (mm)	A0 (mm)	B0 (mm)	K0 (mm)	P1 (mm)	W (mm)	Pin1 Quadrant
SN74CBT3245ADBR	SSOP	DB	20	2000	330.0	16.4	8.2	7.5	2.5	12.0	16.0	Q1

**TAPE AND REEL BOX DIMENSIONS**

\*All dimensions are nominal

Device	Package Type	Package Drawing	Pins	SPQ	Length (mm)	Width (mm)	Height (mm)
SN74CBT3245ADBR	SSOP	DB	20	2000	356.0	356.0	35.0



# DB0020A



# PACKAGE OUTLINE

## SSOP - 2 mm max height

SMALL OUTLINE PACKAGE



4214851/B 08/2019

### NOTES:

1. All linear dimensions are in millimeters. Any dimensions in parenthesis are for reference only. Dimensioning and tolerancing per ASME Y14.5M.
2. This drawing is subject to change without notice.
3. This dimension does not include mold flash, protrusions, or gate burrs. Mold flash, protrusions, or gate burrs shall not exceed 0.15 mm per side.
4. This dimension does not include interlead flash. Interlead flash shall not exceed 0.25 mm per side.
5. Reference JEDEC registration MO-150.

# EXAMPLE BOARD LAYOUT

DB0020A

SSOP - 2 mm max height

SMALL OUTLINE PACKAGE



LAND PATTERN EXAMPLE  
EXPOSED METAL SHOWN  
SCALE: 10X



4214851/B 08/2019

NOTES: (continued)

- 6. Publication IPC-7351 may have alternate designs.
- 7. Solder mask tolerances between and around signal pads can vary based on board fabrication site.

# EXAMPLE STENCIL DESIGN

DB0020A

SSOP - 2 mm max height

SMALL OUTLINE PACKAGE

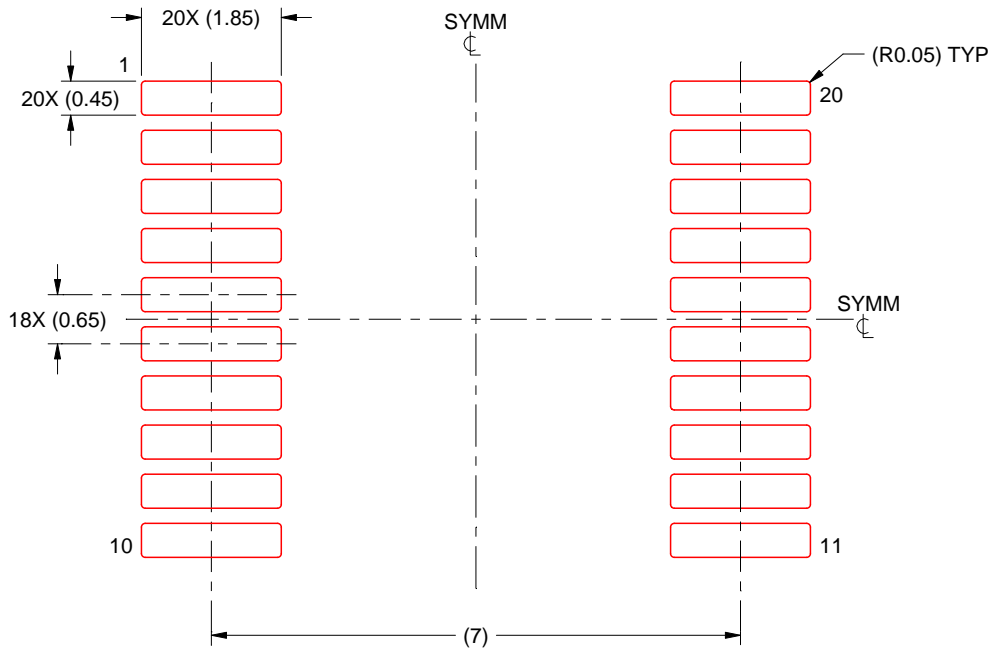

SOLDER PASTE EXAMPLE  
BASED ON 0.125 mm THICK STENCIL  
SCALE: 10X

4214851/B 08/2019

NOTES: (continued)

8. Laser cutting apertures with trapezoidal walls and rounded corners may offer better paste release. IPC-7525 may have alternate design recommendations.
9. Board assembly site may have different recommendations for stencil design.

DGV (R-PDSO-G\*\*)

PLASTIC SMALL-OUTLINE

24 PINS SHOWN



- NOTES: A. All linear dimensions are in millimeters.  
 B. This drawing is subject to change without notice.  
 C. Body dimensions do not include mold flash or protrusion, not to exceed 0,15 per side.  
 D. Falls within JEDEC: 24/48 Pins – MO-153  
 14/16/20/56 Pins – MO-194

## GENERIC PACKAGE VIEW

**RGY 20**

**VQFN - 1 mm max height**

3.5 x 4.5, 0.5 mm pitch

PLASTIC QUAD FGLATPACK - NO LEAD

This image is a representation of the package family, actual package may vary.  
Refer to the product data sheet for package details.

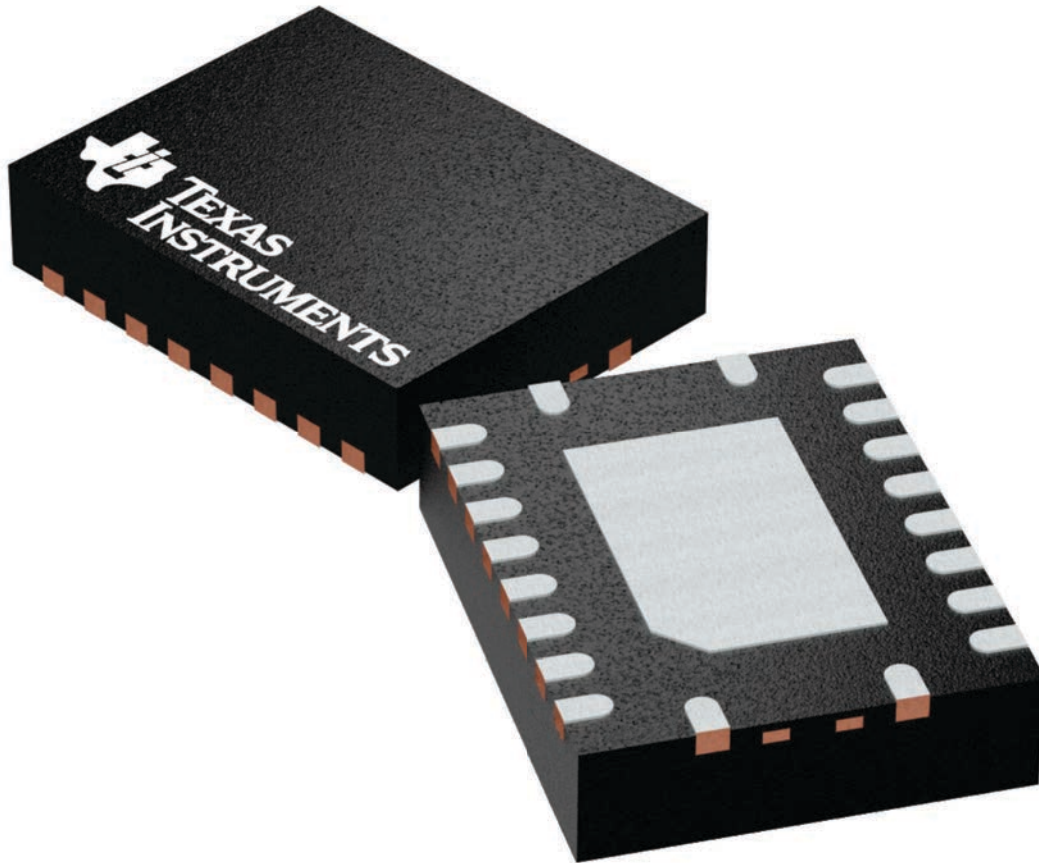

4225264/A

# DW0020A



# PACKAGE OUTLINE

## SOIC - 2.65 mm max height

SOIC



4220724/A 05/2016

# EXAMPLE BOARD LAYOUT

DW0020A

SOIC - 2.65 mm max height

SOIC



LAND PATTERN EXAMPLE  
SCALE:6X



SOLDER MASK DETAILS

4220724/A 05/2016

NOTES: (continued)

- 6. Publication IPC-7351 may have alternate designs.
- 7. Solder mask tolerances between and around signal pads can vary based on board fabrication site.

# EXAMPLE STENCIL DESIGN

DW0020A

SOIC - 2.65 mm max height

SOIC



SOLDER PASTE EXAMPLE  
BASED ON 0.125 mm THICK STENCIL  
SCALE:6X

4220724/A 05/2016

NOTES: (continued)

8. Laser cutting apertures with trapezoidal walls and rounded corners may offer better paste release. IPC-7525 may have alternate design recommendations.
9. Board assembly site may have different recommendations for stencil design.



PW0020A



# PACKAGE OUTLINE

## TSSOP - 1.2 mm max height

SMALL OUTLINE PACKAGE



4220206/A 02/2017

NOTES:

1. All linear dimensions are in millimeters. Any dimensions in parenthesis are for reference only. Dimensioning and tolerancing per ASME Y14.5M.
2. This drawing is subject to change without notice.
3. This dimension does not include mold flash, protrusions, or gate burrs. Mold flash, protrusions, or gate burrs shall not exceed 0.15 mm per side.
4. This dimension does not include interlead flash. Interlead flash shall not exceed 0.25 mm per side.
5. Reference JEDEC registration MO-153.

# EXAMPLE BOARD LAYOUT

PW0020A

TSSOP - 1.2 mm max height

SMALL OUTLINE PACKAGE



LAND PATTERN EXAMPLE  
EXPOSED METAL SHOWN  
SCALE: 10X



SOLDER MASK DETAILS

4220206/A 02/2017

NOTES: (continued)

- 6. Publication IPC-7351 may have alternate designs.
- 7. Solder mask tolerances between and around signal pads can vary based on board fabrication site.

# EXAMPLE STENCIL DESIGN

PW0020A

TSSOP - 1.2 mm max height

SMALL OUTLINE PACKAGE



SOLDER PASTE EXAMPLE  
BASED ON 0.125 mm THICK STENCIL  
SCALE: 10X

4220206/A 02/2017

NOTES: (continued)

8. Laser cutting apertures with trapezoidal walls and rounded corners may offer better paste release. IPC-7525 may have alternate design recommendations.
9. Board assembly site may have different recommendations for stencil design.

## IMPORTANT NOTICE AND DISCLAIMER

TI PROVIDES TECHNICAL AND RELIABILITY DATA (INCLUDING DATA SHEETS), DESIGN RESOURCES (INCLUDING REFERENCE DESIGNS), APPLICATION OR OTHER DESIGN ADVICE, WEB TOOLS, SAFETY INFORMATION, AND OTHER RESOURCES "AS IS" AND WITH ALL FAULTS, AND DISCLAIMS ALL WARRANTIES, EXPRESS AND IMPLIED, INCLUDING WITHOUT LIMITATION ANY IMPLIED WARRANTIES OF MERCHANTABILITY, FITNESS FOR A PARTICULAR PURPOSE OR NON-INFRINGEMENT OF THIRD PARTY INTELLECTUAL PROPERTY RIGHTS.

These resources are intended for skilled developers designing with TI products. You are solely responsible for (1) selecting the appropriate TI products for your application, (2) designing, validating and testing your application, and (3) ensuring your application meets applicable standards, and any other safety, security, regulatory or other requirements.

These resources are subject to change without notice. TI grants you permission to use these resources only for development of an application that uses the TI products described in the resource. Other reproduction and display of these resources is prohibited. No license is granted to any other TI intellectual property right or to any third party intellectual property right. TI disclaims responsibility for, and you will fully indemnify TI and its representatives against, any claims, damages, costs, losses, and liabilities arising out of your use of these resources.

TI's products are provided subject to [TI's Terms of Sale](#) or other applicable terms available either on [ti.com](https://www.ti.com) or provided in conjunction with such TI products. TI's provision of these resources does not expand or otherwise alter TI's applicable warranties or warranty disclaimers for TI products.

TI objects to and rejects any additional or different terms you may have proposed.

Mailing Address: Texas Instruments, Post Office Box 655303, Dallas, Texas 75265

Copyright © 2025, Texas Instruments Incorporated