

SN74LV123A-EP

DUAL RETRIGGERABLE MONOSTABLE MULTIVIBRATOR WITH SCHMITT-TRIGGER INPUTS

SCLS498A – MAY 2003 – REVISED MAY 2004

- **Controlled Baseline**
 - One Assembly/Test Site, One Fabrication Site
- **Extended Temperature Performance of –40°C to 105°C**
- **Enhanced Diminishing Manufacturing Sources (DMS) Support**
- **Enhanced Product-Change Notification**
- **Qualification Pedigree†**
- **Typical V_{OLP} (Output Ground Bounce) <0.8 V at $V_{CC} = 3.3$ V, $T_A = 25^\circ\text{C}$**
- **Typical V_{OHV} (Output V_{OH} Undershoot) >2.3 V at $V_{CC} = 3.3$ V, $T_A = 25^\circ\text{C}$**
- **Supports Mixed-Mode Voltage Operation on All Ports**
- **Schmitt-Trigger Circuitry on \overline{A} , B, and \overline{CLR} Inputs for Slow Input Transition Rates**
- **Edge Triggered From Active-High or Active-Low Gated Logic Inputs**
- **I_{off} Supports Partial-Power-Down Mode Operation**
- **Retriggerable for Very Long Output Pulses, Up To 100% Duty Cycle**
- **Overriding Clear Terminates Output Pulse**
- **Glitch-Free Power-Up Reset on Outputs**
- **ESD Protection Exceeds JESD 22**
 - 2000-V Human-Body Model (A114-A)
 - 200-V Machine Model (A115-A)
 - 1000-V Charged-Device Model (C101)

† Component qualification in accordance with JEDEC and industry standards to ensure reliable operation over an extended temperature range. This includes, but is not limited to, Highly Accelerated Stress Test (HAST) or biased 85/85, temperature cycle, autoclave or unbiased HAST, electromigration, bond intermetallic life, and mold compound life. Such qualification testing should not be viewed as justifying use of this component beyond specified performance and environmental limits.

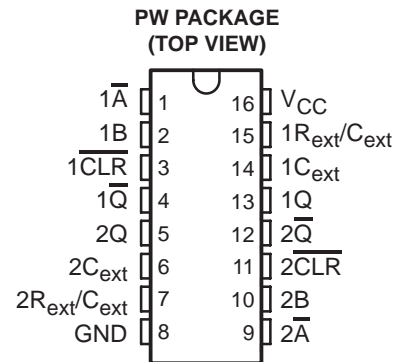

description/ordering information

The SN74LV123A is a dual retriggerable monostable multivibrator designed for 2-V to 5.5-V V_{CC} operation.

This edge-triggered multivibrator features output pulse-duration control by three methods. In the first method, the \overline{A} input is low, and the B input goes high. In the second method, the B input is high, and the \overline{A} input goes low. In the third method, the \overline{A} input is low, the B input is high, and the clear (\overline{CLR}) input goes high.

The output pulse duration is programmable by selecting external resistance and capacitance values. The external timing capacitor must be connected between C_{ext} and R_{ext}/C_{ext} (positive) and an external resistor connected between R_{ext}/C_{ext} and V_{CC} . To obtain variable pulse durations, connect an external variable resistance between R_{ext}/C_{ext} and V_{CC} . The output pulse duration also can be reduced by taking \overline{CLR} low.

Pulse triggering occurs at a particular voltage level and is not directly related to the transition time of the input pulse. The \overline{A} , B, and \overline{CLR} inputs have Schmitt triggers with sufficient hysteresis to handle slow input transition rates with jitter-free triggering at the outputs.

ORDERING INFORMATION

T_A	PACKAGE‡		ORDERABLE PART NUMBER	TOP-SIDE MARKING
–40°C to 105°C	TSSOP – PW	Tape and reel	SN74LV123ATPWREP	L123AEP

‡ Package drawings, standard packing quantities, thermal data, symbolization, and PCB design guidelines are available at www.ti.com/sc/package.



Please be aware that an important notice concerning availability, standard warranty, and use in critical applications of Texas Instruments semiconductor products and disclaimers thereto appears at the end of this data sheet.

PRODUCTION DATA information is current as of publication date. Products conform to specifications per the terms of Texas Instruments standard warranty. Production processing does not necessarily include testing of all parameters.

**TEXAS
INSTRUMENTS**

POST OFFICE BOX 655303 • DALLAS, TEXAS 75265

Copyright © 2004, Texas Instruments Incorporated

SN74LV123A-EP DUAL RETRIGGERABLE MONOSTABLE MULTIVIBRATOR WITH SCHMITT-TRIGGER INPUTS

SCLS498A – MAY 2003 – REVISED MAY 2004

description/ordering information (continued)

Once triggered, the basic pulse duration can be extended by retriggering the gated low-level-active (\bar{A}) or high-level-active (B) input. Pulse duration can be reduced by taking $\overline{\text{CLR}}$ low. The input/output timing diagram illustrates pulse control by retriggering the inputs and early clearing.

During power up, Q outputs are in the low state, and \bar{Q} outputs are in the high state. The outputs are glitch free, without applying a reset pulse.

This device is fully specified for partial-power-down applications using I_{off} . The I_{off} circuitry disables the outputs, preventing damaging current backflow through the device when it is powered down.

FUNCTION TABLE
(each multivibrator)

INPUTS			OUTPUTS	
$\overline{\text{CLR}}$	\bar{A}	B	Q	\bar{Q}
L	X	X	L	H
X	H	X	L†	H†
X	X	L	L†	H†
H	L	↑	⌋	⌋
H	↓	H	⌋	⌋
↑	L	H	⌋	⌋

† These outputs are based on the assumption that the indicated steady-state conditions at the A and B inputs have been set up long enough to complete any pulse started before the setup.

logic diagram, each multivibrator (positive logic)

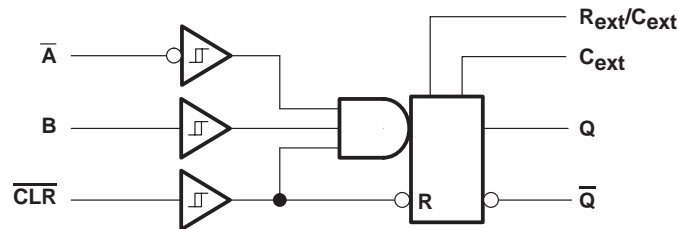

SN74LV123A-EP DUAL RETRIGGERABLE MONOSTABLE MULTIVIBRATOR WITH SCHMITT-TRIGGER INPUTS

SCLS498A – MAY 2003 – REVISED MAY 2004

input/output timing diagram

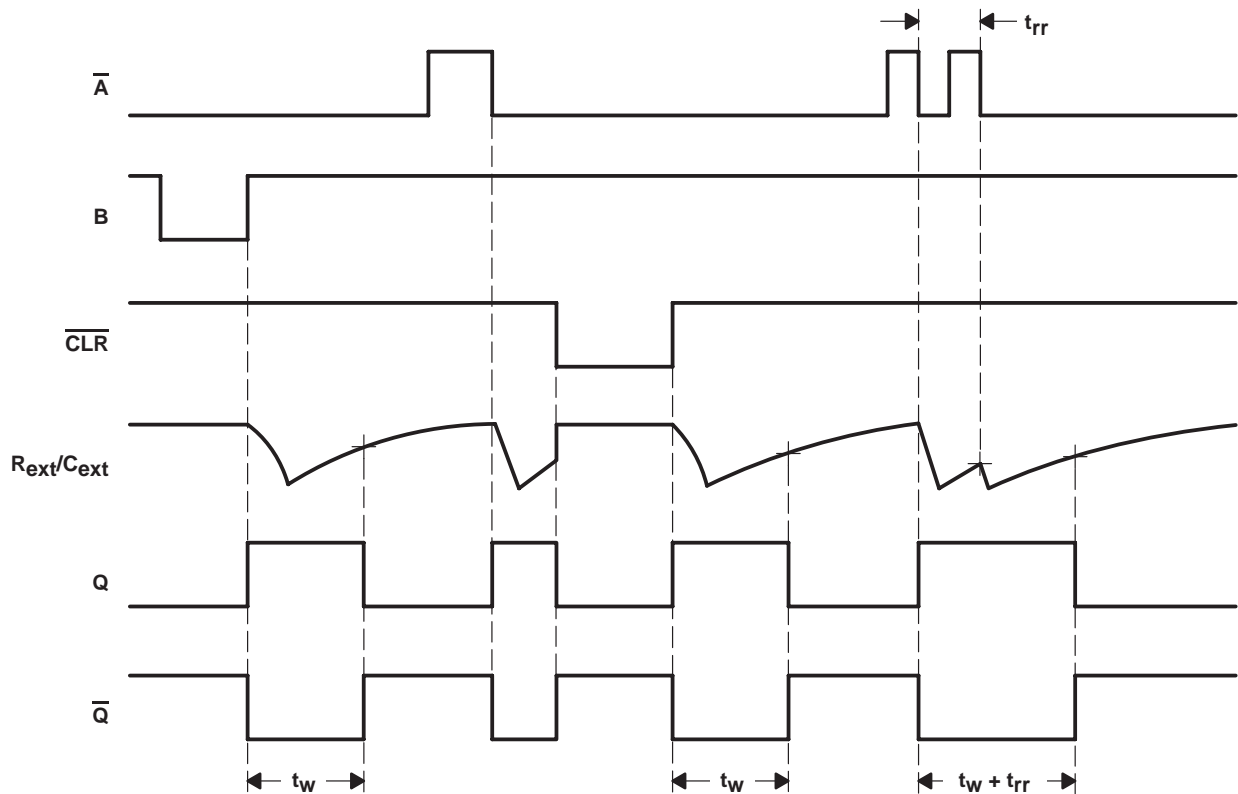

absolute maximum ratings over operating free-air temperature (unless otherwise noted)†

Supply voltage range, V_{CC}	-0.5 V to 7 V
Input voltage range, V_I (see Note 1)	-0.5 V to 7 V
Voltage range applied to any output in the high-impedance or power-off state, V_O (see Note 1)	-0.5 V to 7 V
Output voltage range in high or low state, V_O (see Notes 1 and 2)	-0.5 V to $V_{CC} + 0.5$ V
Output voltage range in power-off state, V_O (see Note 1)	-0.5 V to 7 V
Input clamp current, I_{IK} ($V_I < 0$)	-20 mA
Output clamp current, I_{OK} ($V_O < 0$)	-50 mA
Continuous output current, I_O ($V_O = 0$ to V_{CC})	± 25 mA
Continuous current through V_{CC} or GND	± 50 mA
Package thermal impedance, θ_{JA} (see Note 3)	113°C/W
Storage temperature range, T_{stg}	-65°C to 150°C

† Stresses beyond those listed under “absolute maximum ratings” may cause permanent damage to the device. These are stress ratings only, and functional operation of the device at these or any other conditions beyond those indicated under “recommended operating conditions” is not implied. Exposure to absolute-maximum-rated conditions for extended periods may affect device reliability.

- NOTES: 1. The input and output negative-voltage ratings may be exceeded if the input and output current ratings are observed.
 2. This value is limited to 5.5 V maximum.
 3. The package thermal impedance is calculated in accordance with JESD 51-7.

SN74LV123A-EP

DUAL RETRIGGERABLE MONOSTABLE MULTIVIBRATOR WITH SCHMITT-TRIGGER INPUTS

SCLS498A – MAY 2003 – REVISED MAY 2004

recommended operating conditions (see Note 4)

		MIN	MAX	UNIT
V_{CC}	Supply voltage	2	5.5	V
V_{IH}	High-level input voltage	$V_{CC} = 2\text{ V}$	1.5	V
		$V_{CC} = 2.3\text{ V to }2.7\text{ V}$	$V_{CC} \times 0.7$	
		$V_{CC} = 3\text{ V to }3.6\text{ V}$	$V_{CC} \times 0.7$	
		$V_{CC} = 4.5\text{ V to }5.5\text{ V}$	$V_{CC} \times 0.7$	
V_{IL}	Low-level input voltage	$V_{CC} = 2\text{ V}$	0.5	V
		$V_{CC} = 2.3\text{ V to }2.7\text{ V}$	$V_{CC} \times 0.3$	
		$V_{CC} = 3\text{ V to }3.6\text{ V}$	$V_{CC} \times 0.3$	
		$V_{CC} = 4.5\text{ V to }5.5\text{ V}$	$V_{CC} \times 0.3$	
V_I	Input voltage	0	5.5	V
V_O	Output voltage	0	V_{CC}	V
I_{OH}	High-level output current	$V_{CC} = 2\text{ V}$	-50	μA
		$V_{CC} = 2.3\text{ V to }2.7\text{ V}$	-2	mA
		$V_{CC} = 3\text{ V to }3.6\text{ V}$	-6	
		$V_{CC} = 4.5\text{ V to }5.5\text{ V}$	-12	
I_{OL}	Low-level output current	$V_{CC} = 2\text{ V}$	50	μA
		$V_{CC} = 2.3\text{ V to }2.7\text{ V}$	2	mA
		$V_{CC} = 3\text{ V to }3.6\text{ V}$	6	
		$V_{CC} = 4.5\text{ V to }5.5\text{ V}$	12	
R_{ext}	External timing resistance	$V_{CC} = 2\text{ V}$	5k	Ω
		$V_{CC} \geq 3\text{ V}$	1k	
C_{ext}	External timing capacitance	No restriction		pF
$\Delta t/\Delta V_{CC}$	Power-up ramp rate	1		ms/V
T_A	Operating free-air temperature	-40	105	$^{\circ}\text{C}$

NOTE 4: All unused inputs of the device must be held at V_{CC} or GND to ensure proper device operation. Refer to the TI application report, *Implications of Slow or Floating CMOS Inputs*, literature number SCBA004.

SN74LV123A-EP

DUAL RETRIGGERABLE MONOSTABLE MULTIVIBRATOR WITH SCHMITT-TRIGGER INPUTS

SCLS498A – MAY 2003 – REVISED MAY 2004

electrical characteristics over recommended operating free-air temperature range (unless otherwise noted)

PARAMETER		TEST CONDITIONS	V _{CC}	MIN	TYP	MAX	UNIT
V _{OH}		I _{OH} = -50 μA	2 V to 5.5 V	V _{CC} -0.1			V
		I _{OH} = -2 mA	2.3 V	2			
		I _{OH} = -6 mA	3 V	2.48			
		I _{OH} = -12 mA	4.5 V	3.8			
V _{OL}		I _{OL} = 50 μA	2 V to 5.5 V			0.1	V
		I _{OL} = 2 mA	2.3 V			0.4	
		I _{OL} = 6 mA	3 V			0.44	
		I _{OL} = 12 mA	4.5 V			0.55	
I _I	R _{ext} /C _{ext} [†]	V _I = 5.5 V or GND	2 V to 5.5 V			±2.5	μA
	\overline{A} , B, and \overline{CLR}	V _I = 5.5 V or GND	0			±1	
			0 to 5.5 V			±1	
I _{CC}	Quiescent	V _I = V _{CC} or GND, I _O = 0	5.5 V			20	μA
I _{CC}	Active state (per circuit)	V _I = V _{CC} or GND, R _{ext} /C _{ext} = 0.5 V _{CC}	3 V			280	μA
			4.5 V			650	
			5.5 V			975	
I _{off}		V _I or V _O = 0 to 5.5 V	0			5	μA
C _i		V _I = V _{CC} or GND	3.3 V			1.9	pF
			5 V			1.9	

[†] This test is performed with the terminal in the off-state condition.

timing requirements over recommended operating free-air temperature range, V_{CC} = 3.3 V ± 0.3 V (unless otherwise noted) (see Figure 1)

		TEST CONDITIONS		T _A = 25°C			MIN	MAX	UNIT
				MIN	TYP	MAX			
t _w	Pulse duration	\overline{CLR}		5			5	ns	
		\overline{A} or B trigger		5			5		
t _{rr}	Pulse retrigger time	R _{ext} = 1 kΩ	C _{ext} = 100 pF	‡	76	‡	ns		
			C _{ext} = 0.01 μF	‡	1.8	‡	μs		

[‡] See retriggering data in the *application information* section.

timing requirements over recommended operating free-air temperature range, V_{CC} = 5 V ± 0.5 V (unless otherwise noted) (see Figure 1)

		TEST CONDITIONS		T _A = 25°C			MIN	MAX	UNIT
				MIN	TYP	MAX			
t _w	Pulse duration	\overline{CLR}		5			5	ns	
		\overline{A} or B trigger		5			5		
t _{rr}	Pulse retrigger time	R _{ext} = 1 kΩ	C _{ext} = 100 pF	‡	59	‡	ns		
			C _{ext} = 0.01 μF	‡	1.5	‡	μs		

[‡] See retriggering data in the *application information* section.



SN74LV123A-EP

DUAL RETRIGGERABLE MONOSTABLE MULTIVIBRATOR WITH SCHMITT-TRIGGER INPUTS

SCLS498A – MAY 2003 – REVISED MAY 2004

switching characteristics over recommended operating free-air temperature range, $V_{CC} = 3.3\text{ V} \pm 0.3\text{ V}$ (unless otherwise noted) (see Figure 1)

PARAMETER	FROM (INPUT)	TO (OUTPUT)	TEST CONDITIONS	$T_A = 25^\circ\text{C}$			MIN	MAX	UNIT
				MIN	TYP	MAX			
t_{pd}	\bar{A} or B	Q or \bar{Q}	$C_L = 50\text{ pF}$	11.8	24.1		1	27.5	ns
	$\overline{\text{CLR}}$	Q or \bar{Q}		10.5	19.3		1	22	
	$\overline{\text{CLR}}$ trigger	Q or \bar{Q}		12.3	25.9		1	29.5	
t_w^\dagger		Q or \bar{Q}	$C_L = 50\text{ pF}$, $C_{ext} = 28\text{ pF}$, $R_{ext} = 2\text{ k}\Omega$	182	240			300	ns
			$C_L = 50\text{ pF}$, $C_{ext} = 0.01\text{ }\mu\text{F}$, $R_{ext} = 10\text{ k}\Omega$	90	100	110	90	110	μs
			$C_L = 50\text{ pF}$, $C_{ext} = 0.1\text{ }\mu\text{F}$, $R_{ext} = 10\text{ k}\Omega$	0.9	1	1.1	0.9	1.1	ms
Δt_w^\ddagger			$C_L = 50\text{ pF}$	± 1					%

$^\dagger t_w$ = Duration of pulse at Q and \bar{Q} outputs

$^\ddagger \Delta t_w$ = Output pulse-duration variation (Q and \bar{Q}) between circuits in same package

switching characteristics over recommended operating free-air temperature range, $V_{CC} = 5\text{ V} \pm 0.5\text{ V}$ (unless otherwise noted) (see Figure 1)

PARAMETER	FROM (INPUT)	TO (OUTPUT)	TEST CONDITIONS	$T_A = 25^\circ\text{C}$			MIN	MAX	UNIT
				MIN	TYP	MAX			
t_{pd}	\bar{A} or B	Q or \bar{Q}	$C_L = 50\text{ pF}$	8.3	14		1	16	ns
	$\overline{\text{CLR}}$	Q or \bar{Q}		7.4	11.4		1	13	
	$\overline{\text{CLR}}$ trigger	Q or \bar{Q}		8.7	14.9		1	17	
t_w^\dagger		Q or \bar{Q}	$C_L = 50\text{ pF}$, $C_{ext} = 28\text{ pF}$, $R_{ext} = 2\text{ k}\Omega$	167	200			240	ns
			$C_L = 50\text{ pF}$, $C_{ext} = 0.01\text{ }\mu\text{F}$, $R_{ext} = 10\text{ k}\Omega$	90	100	110	90	110	μs
			$C_L = 50\text{ pF}$, $C_{ext} = 0.1\text{ }\mu\text{F}$, $R_{ext} = 10\text{ k}\Omega$	0.9	1	1.1	0.9	1.1	ms
Δt_w^\ddagger				± 1					%

$^\dagger t_w$ = Duration of pulse at Q and \bar{Q} outputs

$^\ddagger \Delta t_w$ = Output pulse-duration variation (Q and \bar{Q}) between circuits in same package

operating characteristics, $T_A = 25^\circ\text{C}$

PARAMETER	TEST CONDITIONS	V_{CC}	TYP	UNIT
C_{pd} Power dissipation capacitance	$C_L = 50\text{ pF}$, $f = 10\text{ MHz}$	3.3 V	44	pF
		5 V	49	



SN74LV123A-EP DUAL RETRIGGERABLE MONOSTABLE MULTIVIBRATOR WITH SCHMITT-TRIGGER INPUTS

SCLS498A – MAY 2003 – REVISED MAY 2004

PARAMETER MEASUREMENT INFORMATION

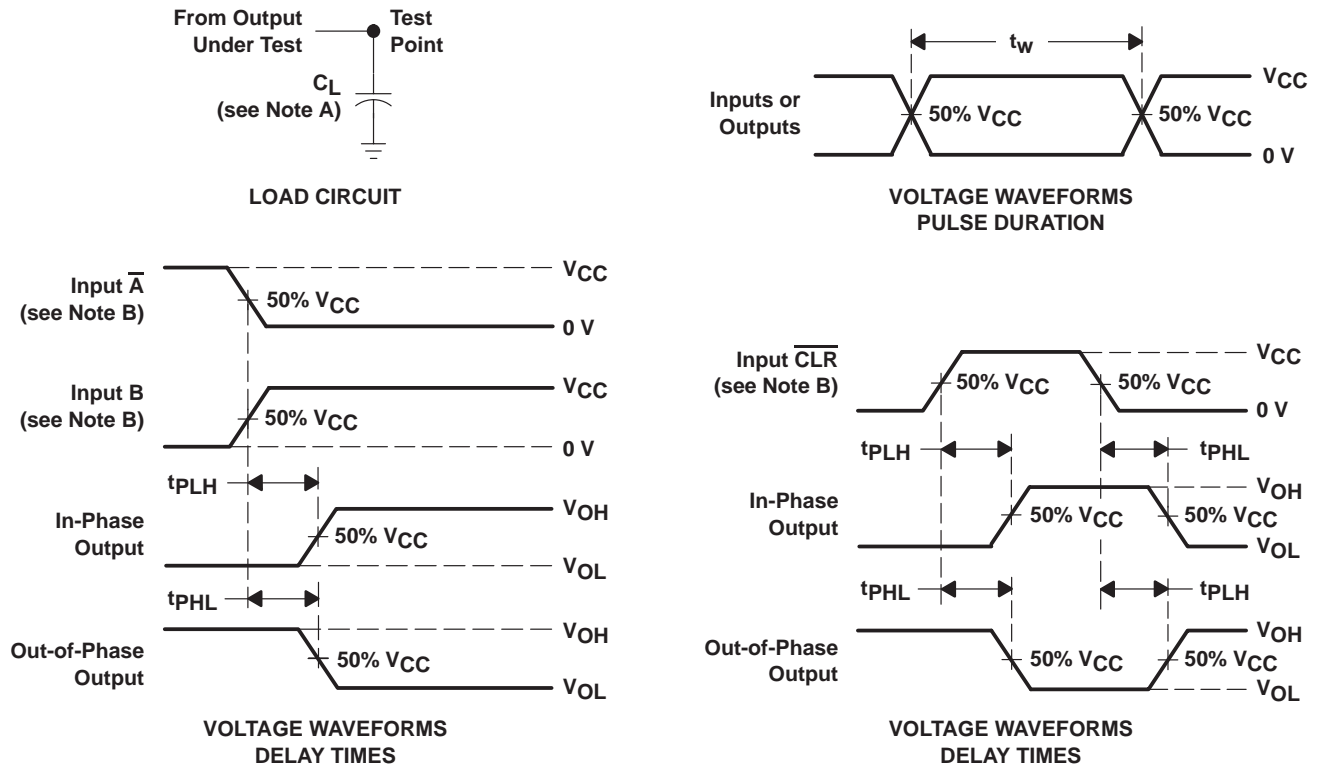

- NOTES: A. C_L includes probe and jig capacitance.
 B. All input pulses are supplied by generators having the following characteristics: PRR ≤ 1 MHz, $Z_O = 50 \Omega$, $t_r = 3$ ns, $t_f = 3$ ns.
 C. The outputs are measured one at a time, with one input transition per measurement.

Figure 1. Load Circuit and Voltage Waveforms

SN74LV123A-EP DUAL RETRIGGERABLE MONOSTABLE MULTIVIBRATOR WITH SCHMITT-TRIGGER INPUTS

SCLS498A – MAY 2003 – REVISED MAY 2004

APPLICATION INFORMATION†

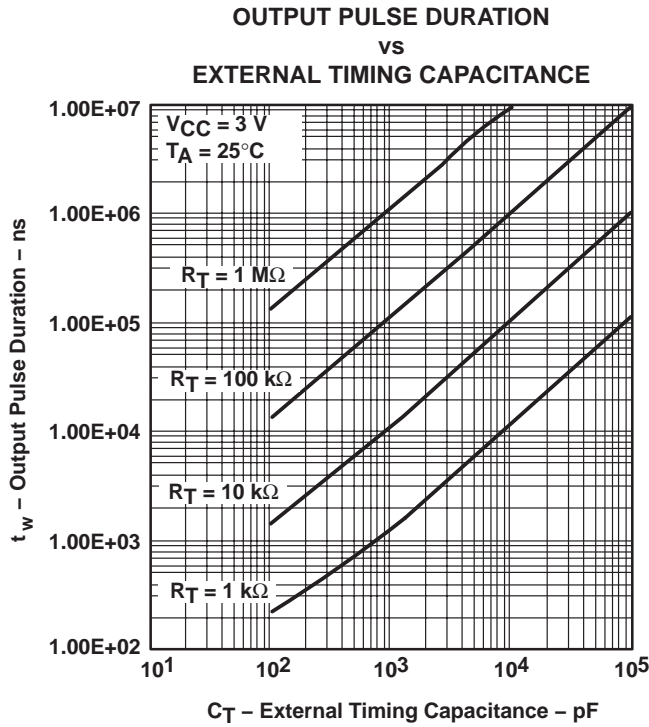

Figure 2

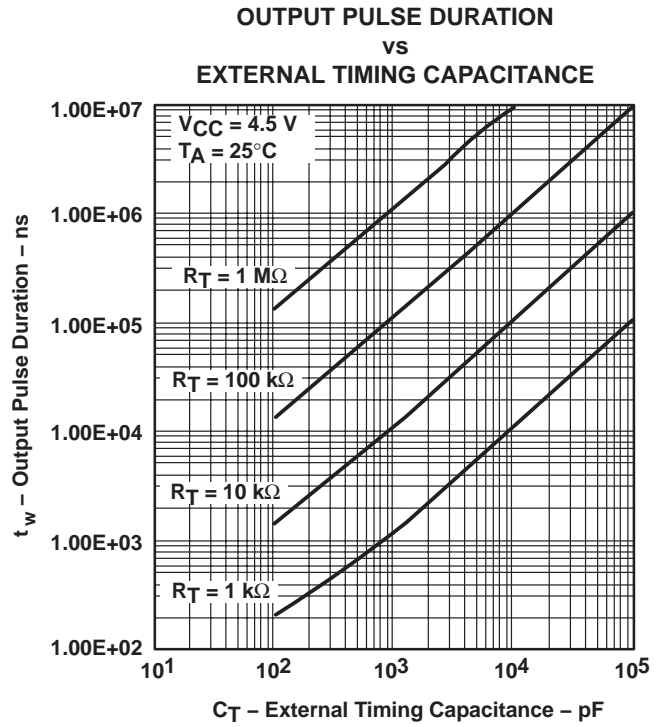

Figure 3

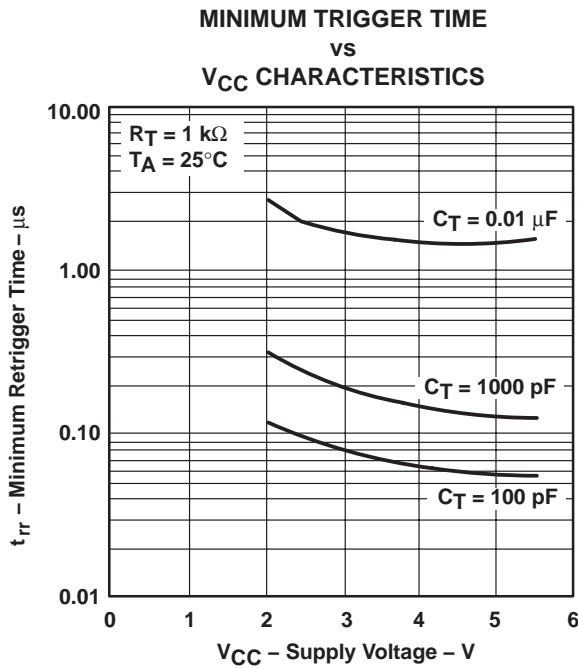

Figure 4

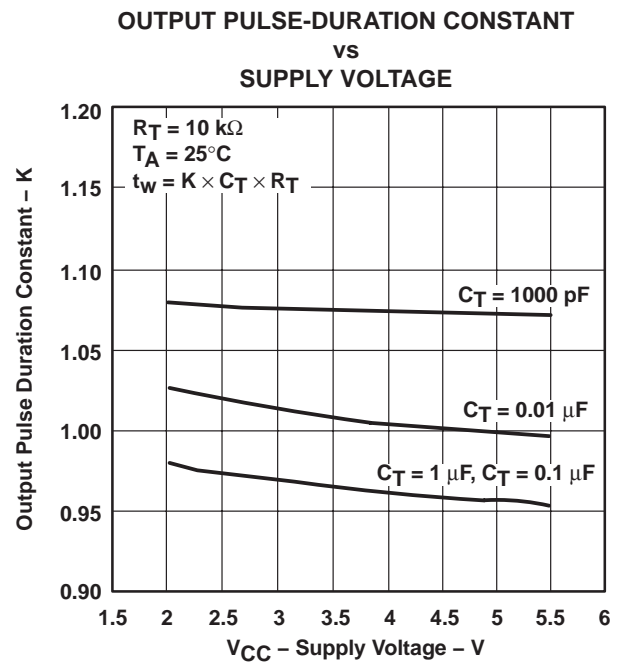

Figure 5

† Operation of the device at these or any other conditions beyond those indicated under "recommended operating conditions" is not implied.

PACKAGING INFORMATION

Orderable part number	Status (1)	Material type (2)	Package Pins	Package qty Carrier	RoHS (3)	Lead finish/ Ball material (4)	MSL rating/ Peak reflow (5)	Op temp (°C)	Part marking (6)
SN74LV123ATPWREP	Active	Production	TSSOP (PW) 16	2000 LARGE T&R	Yes	NIPDAU	Level-1-260C-UNLIM	-40 to 125	L123AEP

(1) **Status:** For more details on status, see our [product life cycle](#).

(2) **Material type:** When designated, preproduction parts are prototypes/experimental devices, and are not yet approved or released for full production. Testing and final process, including without limitation quality assurance, reliability performance testing, and/or process qualification, may not yet be complete, and this item is subject to further changes or possible discontinuation. If available for ordering, purchases will be subject to an additional waiver at checkout, and are intended for early internal evaluation purposes only. These items are sold without warranties of any kind.

(3) **RoHS values:** Yes, No, RoHS Exempt. See the [TI RoHS Statement](#) for additional information and value definition.

(4) **Lead finish/Ball material:** Parts may have multiple material finish options. Finish options are separated by a vertical ruled line. Lead finish/Ball material values may wrap to two lines if the finish value exceeds the maximum column width.

(5) **MSL rating/Peak reflow:** The moisture sensitivity level ratings and peak solder (reflow) temperatures. In the event that a part has multiple moisture sensitivity ratings, only the lowest level per JEDEC standards is shown. Refer to the shipping label for the actual reflow temperature that will be used to mount the part to the printed circuit board.

(6) **Part marking:** There may be an additional marking, which relates to the logo, the lot trace code information, or the environmental category of the part.

Multiple part markings will be inside parentheses. Only one part marking contained in parentheses and separated by a "-" will appear on a part. If a line is indented then it is a continuation of the previous line and the two combined represent the entire part marking for that device.

Important Information and Disclaimer:The information provided on this page represents TI's knowledge and belief as of the date that it is provided. TI bases its knowledge and belief on information provided by third parties, and makes no representation or warranty as to the accuracy of such information. Efforts are underway to better integrate information from third parties. TI has taken and continues to take reasonable steps to provide representative and accurate information but may not have conducted destructive testing or chemical analysis on incoming materials and chemicals. TI and TI suppliers consider certain information to be proprietary, and thus CAS numbers and other limited information may not be available for release.

In no event shall TI's liability arising out of such information exceed the total purchase price of the TI part(s) at issue in this document sold by TI to Customer on an annual basis.

OTHER QUALIFIED VERSIONS OF SN74LV123A-EP :

- Catalog : [SN74LV123A](#)
- Automotive : [SN74LV123A-Q1](#)

NOTE: Qualified Version Definitions:

- Catalog - TI's standard catalog product
- Automotive - Q100 devices qualified for high-reliability automotive applications targeting zero defects

TAPE AND REEL INFORMATION

QUADRANT ASSIGNMENTS FOR PIN 1 ORIENTATION IN TAPE

*All dimensions are nominal

Device	Package Type	Package Drawing	Pins	SPQ	Reel Diameter (mm)	Reel Width W1 (mm)	A0 (mm)	B0 (mm)	K0 (mm)	P1 (mm)	W (mm)	Pin1 Quadrant
SN74LV123ATPWREP	TSSOP	PW	16	2000	330.0	12.4	6.9	5.6	1.6	8.0	12.0	Q1

TAPE AND REEL BOX DIMENSIONS

*All dimensions are nominal

Device	Package Type	Package Drawing	Pins	SPQ	Length (mm)	Width (mm)	Height (mm)
SN74LV123ATPWREP	TSSOP	PW	16	2000	356.0	356.0	35.0

IMPORTANT NOTICE AND DISCLAIMER

TI PROVIDES TECHNICAL AND RELIABILITY DATA (INCLUDING DATA SHEETS), DESIGN RESOURCES (INCLUDING REFERENCE DESIGNS), APPLICATION OR OTHER DESIGN ADVICE, WEB TOOLS, SAFETY INFORMATION, AND OTHER RESOURCES "AS IS" AND WITH ALL FAULTS, AND DISCLAIMS ALL WARRANTIES, EXPRESS AND IMPLIED, INCLUDING WITHOUT LIMITATION ANY IMPLIED WARRANTIES OF MERCHANTABILITY, FITNESS FOR A PARTICULAR PURPOSE OR NON-INFRINGEMENT OF THIRD PARTY INTELLECTUAL PROPERTY RIGHTS.

These resources are intended for skilled developers designing with TI products. You are solely responsible for (1) selecting the appropriate TI products for your application, (2) designing, validating and testing your application, and (3) ensuring your application meets applicable standards, and any other safety, security, regulatory or other requirements.

These resources are subject to change without notice. TI grants you permission to use these resources only for development of an application that uses the TI products described in the resource. Other reproduction and display of these resources is prohibited. No license is granted to any other TI intellectual property right or to any third party intellectual property right. TI disclaims responsibility for, and you will fully indemnify TI and its representatives against, any claims, damages, costs, losses, and liabilities arising out of your use of these resources.

TI's products are provided subject to [TI's Terms of Sale](#) or other applicable terms available either on [ti.com](https://www.ti.com) or provided in conjunction with such TI products. TI's provision of these resources does not expand or otherwise alter TI's applicable warranties or warranty disclaimers for TI products.

TI objects to and rejects any additional or different terms you may have proposed.

Mailing Address: Texas Instruments, Post Office Box 655303, Dallas, Texas 75265

Copyright © 2025, Texas Instruments Incorporated