

- **Controlled Baseline**
 - One Assembly/Test Site, One Fabrication Site
- **Enhanced Diminishing Manufacturing Sources (DMS) Support**
- **Enhanced Product-Change Notification**
- **Qualification Pedigree†**
- **Supports 5-V V_{CC} Operation**
- **Inputs Accept Voltages to 5.5 V**
- **Max t_{pd} of 6.3 ns at 3.3 V**
- **Low Power Consumption, 10- μ A Max I_{CC}**
- **± 24 -mA Output Drive at 3.3 V**
- **I_{off} Supports Partial-Power-Down Mode Operation**
- **Latch-Up Performance Exceeds 100 mA Per JESD 78, Class II**
- **ESD Protection Exceeds JESD 22**
 - 2000-V Human-Body Model (A114-A)
 - 200-V Machine Model (A115-A)
 - 1000-V Charged-Device Model (C101)
- **Choose From Nine Specific Logic Functions**

† Component qualification in accordance with JEDEC and industry standards to ensure reliable operation over an extended temperature range. This includes, but is not limited to, Highly Accelerated Stress Test (HAST) or biased 85/85, temperature cycle, autoclave or unbiased HAST, electromigration, bond intermetallic life, and mold compound life. Such qualification testing should not be viewed as justifying use of this component beyond specified performance and environmental limits.

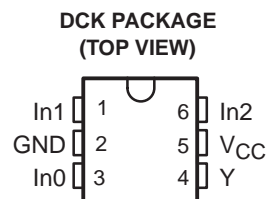

description/ordering information

This configurable multiple-function gate is designed for 1.65-V to 5.5-V V_{CC} operation.

The SN74LVC1G97 features configurable multiple functions. The output state is determined by eight patterns of 3-bit input. The user can choose the logic functions MUX, AND, OR, NAND, NOR, inverter, and noninverter. All inputs can be connected to V_{CC} or GND.

This device functions as an independent gate, but because of Schmitt action, it may have different input threshold levels for positive-going (V_{T+}) and negative-going (V_{T-}) signals.

This device is fully specified for partial-power-down applications using I_{off} . The I_{off} circuitry disables the outputs, preventing damaging current backflow through the device when it is powered down.

ORDERING INFORMATION

T _A	PACKAGE‡	ORDERABLE PART NUMBER	TOP-SIDE MARKING
–40°C to 85°C	SOT (SC-70) – DCK Tape and reel	SN74LVC1G97IDCKREP	CSR

‡ Package drawings, standard packing quantities, thermal data, symbolization, and PCB design guidelines are available at www.ti.com/sc/package.



Please be aware that an important notice concerning availability, standard warranty, and use in critical applications of Texas Instruments semiconductor products and disclaimers thereto appears at the end of this data sheet.

PRODUCTION DATA information is current as of publication date. Products conform to specifications per the terms of Texas Instruments standard warranty. Production processing does not necessarily include testing of all parameters.



POST OFFICE BOX 655303 • DALLAS, TEXAS 75265

Copyright © 2005, Texas Instruments Incorporated

SN74LVC1G97-EP CONFIGURABLE MULTIPLE-FUNCTION GATE

SCES461B – JUNE 2003 – REVISED FEBRUARY 2005

FUNCTION TABLE

INPUTS			OUTPUT
In2	In1	In0	Y
L	L	L	L
L	L	H	L
L	H	L	H
L	H	H	H
H	L	L	L
H	L	H	H
H	H	L	L
H	H	H	H

logic diagram (positive logic)

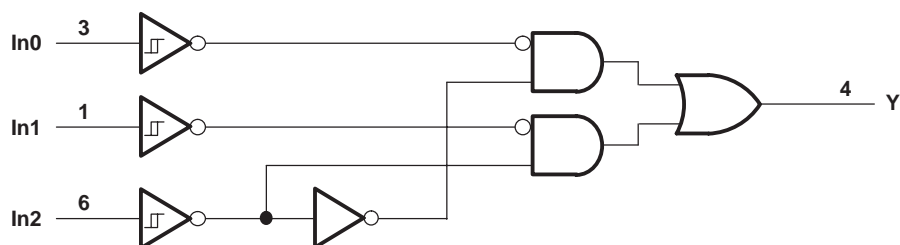

FUNCTION SELECTION TABLE

LOGIC FUNCTION	FIGURE NO.
2-to-1 data selector	1
2-input AND gate	2
2-input OR gate with one inverted input	3
2-input NAND gate with one inverted input	3
2-input AND gate with one inverted input	4
2-input NOR gate with one inverted input	4
2-input OR gate	5
Inverter	6
Noninverted buffer	7

logic configurations

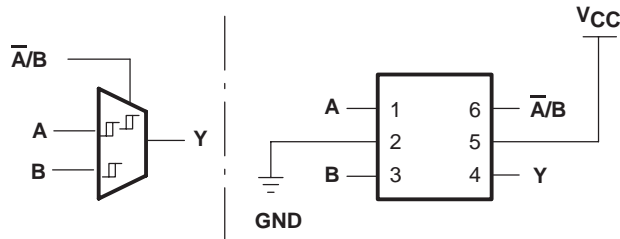

Figure 1. 2-to-1 Data Selector

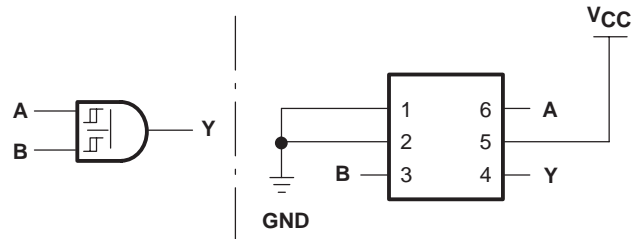

Figure 2. 2-Input AND Gate

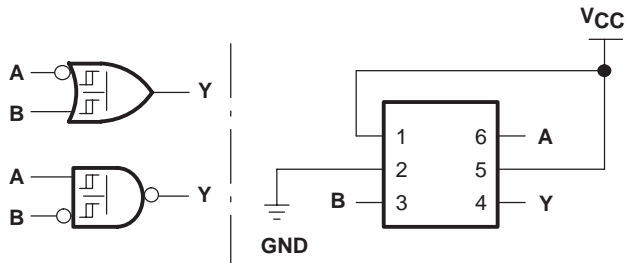

Figure 3. 2-Input OR Gate With One Inverted Input
2-Input NAND Gate With One Inverted Input

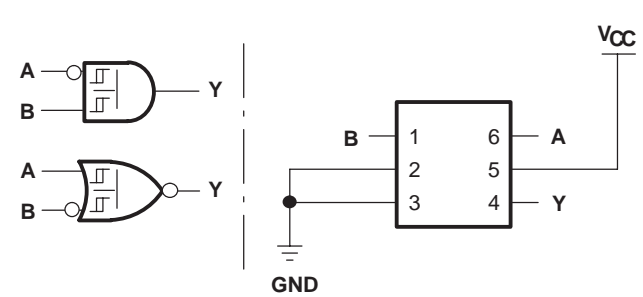

Figure 4. 2-Input AND Gate With One Inverted Input
2-Input NOR Gate With One Inverted Input

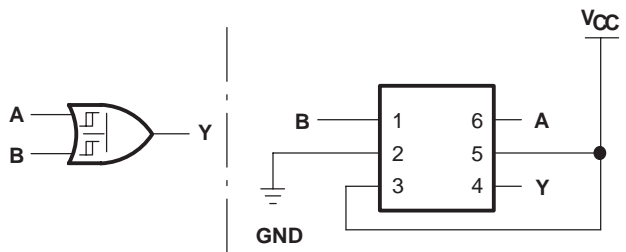

Figure 5. 2-Input OR Gate

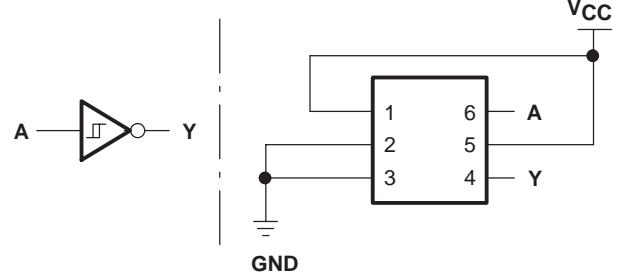

Figure 6. Inverter

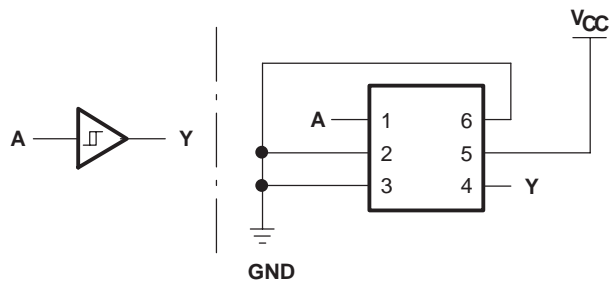

Figure 7. Noninverted Buffer

SN74LVC1G97-EP

CONFIGURABLE MULTIPLE-FUNCTION GATE

SCES461B – JUNE 2003 – REVISED FEBRUARY 2005

absolute maximum ratings over operating free-air temperature range (unless otherwise noted)†

Supply voltage range, V_{CC}	–0.5 V to 6.5 V
Input voltage range, V_I (see Note 1)	–0.5 V to 6.5 V
Voltage range applied to any output in the high-impedance or power-off state, V_O (see Note 1)	–0.5 V to 6.5 V
Voltage range applied to any output in the high or low state, V_O (see Notes 1 and 2)	–0.5 V to $V_{CC} + 0.5$ V
Input clamp current, I_{IK} ($V_I < 0$)	–50 mA
Output clamp current, I_{OK} ($V_O < 0$)	–50 mA
Continuous output current, I_O	±50 mA
Continuous current through V_{CC} or GND	±100 mA
Package thermal impedance, θ_{JA} (see Note 3)	259°C/W
Storage temperature range, T_{stg}	–65°C to 150°C

† Stresses beyond those listed under “absolute maximum ratings” may cause permanent damage to the device. These are stress ratings only, and functional operation of the device at these or any other conditions beyond those indicated under “recommended operating conditions” is not implied. Exposure to absolute-maximum-rated conditions for extended periods may affect device reliability.

- NOTES: 1. The input and output negative-voltage ratings may be exceeded if the input and output current ratings are observed.
 2. The value of V_{CC} is provided in the recommended operating conditions table.
 3. The package thermal impedance is calculated in accordance with JESD 51-7.

recommended operating conditions (see Note 4)

		MIN	MAX	UNIT	
V_{CC}	Supply voltage	Operating	1.65	5.5	V
		Data retention only	1.5		
V_I	Input voltage	0	5.5	V	
V_O	Output voltage	0	V_{CC}	V	
I_{OH}	High-level output current	$V_{CC} = 1.65$ V		–4	mA
		$V_{CC} = 2.3$ V		–8	
		$V_{CC} = 3$ V		–16	
				–24	
$V_{CC} = 4.5$ V		–32			
I_{OL}	Low-level output current	$V_{CC} = 1.65$ V		4	mA
		$V_{CC} = 2.3$ V		8	
		$V_{CC} = 3$ V		16	
				24	
$V_{CC} = 4.5$ V		32			
T_A	Operating free-air temperature	–40	85	°C	

NOTE 4: All unused inputs of the device must be held at V_{CC} or GND to ensure proper device operation. Refer to the TI application report, *Implications of Slow or Floating CMOS Inputs*, literature number SCBA004.



SN74LVC1G97-EP CONFIGURABLE MULTIPLE-FUNCTION GATE

SCES461B – JUNE 2003 – REVISED FEBRUARY 2005

electrical characteristics over recommended operating free-air temperature range (unless otherwise noted)

PARAMETER	TEST CONDITIONS	V _{CC}	MIN	TYP†	MAX	UNIT
V _{T+} Positive-going input threshold voltage		1.65 V	0.79		1.16	V
		2.3 V	1.11		1.56	
		3 V	1.5		1.87	
		4.5 V	2.16		2.74	
		5.5 V	2.61		3.33	
V _{T-} Negative-going input threshold voltage		1.65 V	0.35		0.62	V
		2.3 V	0.58		0.87	
		3 V	0.84		1.19	
		4.5 V	1.41		1.9	
		5.5 V	1.87		2.29	
ΔV _T Hysteresis (V _{T+} – V _{T-})		1.65 V	0.3		0.62	V
		2.3 V	0.4		0.8	
		3 V	0.53		0.87	
		4.5 V	0.71		1.04	
		5.5 V	0.71		1.11	
V _{OH}	I _{OH} = –100 μA	1.65 V to 5.5 V	V _{CC} – 0.1			V
	I _{OH} = –4 mA	1.65 V	1.2			
	I _{OH} = –8 mA	2.3 V	1.9			
	I _{OH} = –16 mA	3 V	2.4			
	I _{OH} = –24 mA		2.3			
	I _{OH} = –32 mA	4.5 V	3.8			
V _{OL}	I _{OL} = 100 μA	1.65 V to 5.5 V			0.1	V
	I _{OL} = 4 mA	1.65 V			0.45	
	I _{OL} = 8 mA	2.3 V			0.3	
	I _{OL} = 16 mA	3 V			0.4	
	I _{OL} = 24 mA				0.55	
	I _{OL} = 32 mA	4.5 V			0.55	
I _I	V _I = 5.5 V or GND	0 to 5.5 V			±5	μA
I _{off}	V _I or V _O = 5.5 V	0			±10	μA
I _{CC}	V _I = 5.5 V or GND, I _O = 0	1.65 V to 5.5 V			10	μA
ΔI _{CC}	One input at V _{CC} – 0.6 V, Other inputs at V _{CC} or GND	3 V to 5.5 V			500	μA
C _i	V _I = V _{CC} or GND	3.3 V			3.5	pF

† All typical values are at V_{CC} = 3.3 V, T_A = 25°C.

SN74LVC1G97-EP

CONFIGURABLE MULTIPLE-FUNCTION GATE

SCES461B – JUNE 2003 – REVISED FEBRUARY 2005

switching characteristics over recommended operating free-air temperature range (unless otherwise noted) (see Figure 8)

PARAMETER	FROM (INPUT)	TO (OUTPUT)	V _{CC} = 1.8 V ± 0.15 V		V _{CC} = 2.5 V ± 0.2 V		V _{CC} = 3.3 V ± 0.3 V		V _{CC} = 5 V ± 0.5 V		UNIT
			MIN	MAX	MIN	MAX	MIN	MAX	MIN	MAX	
t _{pd}	Any In	Y	3.2	14.4	2	8.3	1.5	6.3	1.1	5.1	ns

operating characteristics, T_A = 25°C

PARAMETER	TEST CONDITIONS	V _{CC} = 1.8 V	V _{CC} = 2.5 V	V _{CC} = 3.3 V	V _{CC} = 5 V	UNIT
		TYP	TYP	TYP	TYP	
C _{pd} Power dissipation capacitance	f = 10 MHz	22	23	23	26	pF



PARAMETER MEASUREMENT INFORMATION

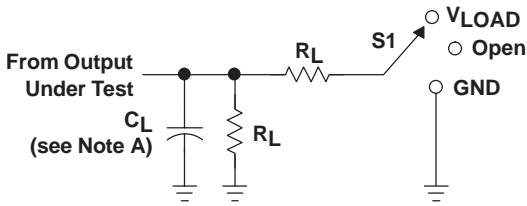

LOAD CIRCUIT

TEST	S1
t _{PLH} /t _{PHL}	Open
t _{PLZ} /t _{PZL}	V _{LOAD}
t _{PHZ} /t _{PZH}	GND

V _{CC}	INPUTS		V _M	V _{LOAD}	C _L	R _L	V _Δ
	V _I	t _r /t _f					
1.8 V ± 0.15 V	V _{CC}	≤ 2 ns	V _{CC} /2	2 × V _{CC}	30 pF	1 kΩ	0.15 V
2.5 V ± 0.2 V	V _{CC}	≤ 2 ns	V _{CC} /2	2 × V _{CC}	30 pF	500 Ω	0.15 V
3.3 V ± 0.3 V	3 V	≤ 2.5 ns	1.5 V	6 V	50 pF	500 Ω	0.3 V
5 V ± 0.5 V	V _{CC}	≤ 2.5 ns	V _{CC} /2	2 × V _{CC}	50 pF	500 Ω	0.3 V

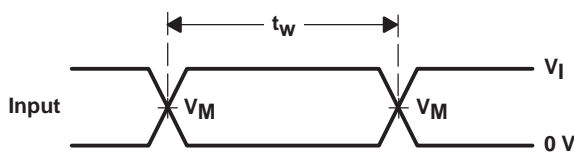

VOLTAGE WAVEFORMS
PULSE DURATION

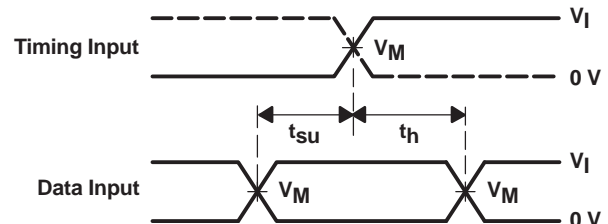

VOLTAGE WAVEFORMS
SETUP AND HOLD TIMES

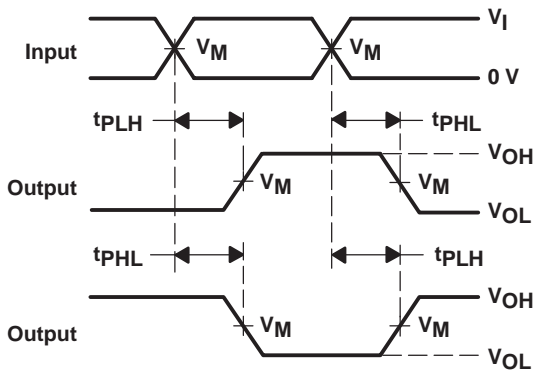

VOLTAGE WAVEFORMS
PROPAGATION DELAY TIMES
INVERTING AND NONINVERTING OUTPUTS

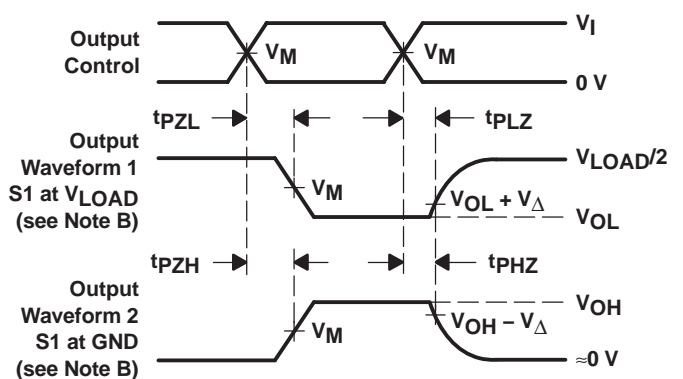

VOLTAGE WAVEFORMS
ENABLE AND DISABLE TIMES
LOW- AND HIGH-LEVEL ENABLING

- NOTES:
- A. C_L includes probe and jig capacitance.
 - B. Waveform 1 is for an output with internal conditions such that the output is low, except when disabled by the output control. Waveform 2 is for an output with internal conditions such that the output is high, except when disabled by the output control.
 - C. All input pulses are supplied by generators having the following characteristics: PRR ≤ 10 MHz, Z_O = 50 Ω.
 - D. The outputs are measured one at a time, with one transition per measurement.
 - E. t_{PLZ} and t_{PHZ} are the same as t_{dis}.
 - F. t_{PZL} and t_{PZH} are the same as t_{en}.
 - G. t_{PLH} and t_{PHL} are the same as t_{pd}.
 - H. All parameters and waveforms are not applicable to all devices.

Figure 8. Load Circuit and Voltage Waveforms

PACKAGING INFORMATION

Orderable Device	Status (1)	Package Type	Package Drawing	Pins	Package Qty	Eco Plan (2)	Lead finish/ Ball material (6)	MSL Peak Temp (3)	Op Temp (°C)	Device Marking (4/5)	Samples
SN74LVC1G97IDCKREP	ACTIVE	SC70	DCK	6	3000	RoHS & Green	NIPDAU	Level-1-260C-UNLIM	-40 to 85	CSR	Samples
V62/03642-01XE	ACTIVE	SC70	DCK	6	3000	RoHS & Green	NIPDAU	Level-1-260C-UNLIM	-40 to 85	CSR	Samples

(1) The marketing status values are defined as follows:

ACTIVE: Product device recommended for new designs.

LIFEBUY: TI has announced that the device will be discontinued, and a lifetime-buy period is in effect.

NRND: Not recommended for new designs. Device is in production to support existing customers, but TI does not recommend using this part in a new design.

PREVIEW: Device has been announced but is not in production. Samples may or may not be available.

OBSOLETE: TI has discontinued the production of the device.

(2) **RoHS:** TI defines "RoHS" to mean semiconductor products that are compliant with the current EU RoHS requirements for all 10 RoHS substances, including the requirement that RoHS substance do not exceed 0.1% by weight in homogeneous materials. Where designed to be soldered at high temperatures, "RoHS" products are suitable for use in specified lead-free processes. TI may reference these types of products as "Pb-Free".

RoHS Exempt: TI defines "RoHS Exempt" to mean products that contain lead but are compliant with EU RoHS pursuant to a specific EU RoHS exemption.

Green: TI defines "Green" to mean the content of Chlorine (Cl) and Bromine (Br) based flame retardants meet JS709B low halogen requirements of <=1000ppm threshold. Antimony trioxide based flame retardants must also meet the <=1000ppm threshold requirement.

(3) MSL, Peak Temp. - The Moisture Sensitivity Level rating according to the JEDEC industry standard classifications, and peak solder temperature.

(4) There may be additional marking, which relates to the logo, the lot trace code information, or the environmental category on the device.

(5) Multiple Device Markings will be inside parentheses. Only one Device Marking contained in parentheses and separated by a "~" will appear on a device. If a line is indented then it is a continuation of the previous line and the two combined represent the entire Device Marking for that device.

(6) Lead finish/Ball material - Orderable Devices may have multiple material finish options. Finish options are separated by a vertical ruled line. Lead finish/Ball material values may wrap to two lines if the finish value exceeds the maximum column width.

Important Information and Disclaimer:The information provided on this page represents TI's knowledge and belief as of the date that it is provided. TI bases its knowledge and belief on information provided by third parties, and makes no representation or warranty as to the accuracy of such information. Efforts are underway to better integrate information from third parties. TI has taken and continues to take reasonable steps to provide representative and accurate information but may not have conducted destructive testing or chemical analysis on incoming materials and chemicals. TI and TI suppliers consider certain information to be proprietary, and thus CAS numbers and other limited information may not be available for release.

In no event shall TI's liability arising out of such information exceed the total purchase price of the TI part(s) at issue in this document sold by TI to Customer on an annual basis.

OTHER QUALIFIED VERSIONS OF SN74LVC1G97-EP :

- Catalog: [SN74LVC1G97](#)
- Automotive: [SN74LVC1G97-Q1](#)

NOTE: Qualified Version Definitions:

- Catalog - TI's standard catalog product
- Automotive - Q100 devices qualified for high-reliability automotive applications targeting zero defects

TAPE AND REEL INFORMATION



QUADRANT ASSIGNMENTS FOR PIN 1 ORIENTATION IN TAPE



*All dimensions are nominal

Device	Package Type	Package Drawing	Pins	SPQ	Reel Diameter (mm)	Reel Width W1 (mm)	A0 (mm)	B0 (mm)	K0 (mm)	P1 (mm)	W (mm)	Pin1 Quadrant
SN74LVC1G97IDCKREP	SC70	DCK	6	3000	180.0	8.4	2.4	2.5	1.2	4.0	8.0	Q3

TAPE AND REEL BOX DIMENSIONS



*All dimensions are nominal

Device	Package Type	Package Drawing	Pins	SPQ	Length (mm)	Width (mm)	Height (mm)
SN74LVC1G97IDCKREP	SC70	DCK	6	3000	202.0	201.0	28.0

DCK (R-PDSO-G6)

PLASTIC SMALL OUTLINE



- NOTES:
- All linear dimensions are in millimeters.
 - This drawing is subject to change without notice.
 - Customers should place a note on the circuit board fabrication drawing not to alter the center solder mask defined pad.
 - Publication IPC-7351 is recommended for alternate designs.
 - Laser cutting apertures with trapezoidal walls and also rounding corners will offer better paste release. Customers should contact their board assembly site for stencil design recommendations. Example stencil design based on a 50% volumetric metal load solder paste. Refer to IPC-7525 for other stencil recommendations.

IMPORTANT NOTICE AND DISCLAIMER

TI PROVIDES TECHNICAL AND RELIABILITY DATA (INCLUDING DATASHEETS), DESIGN RESOURCES (INCLUDING REFERENCE DESIGNS), APPLICATION OR OTHER DESIGN ADVICE, WEB TOOLS, SAFETY INFORMATION, AND OTHER RESOURCES "AS IS" AND WITH ALL FAULTS, AND DISCLAIMS ALL WARRANTIES, EXPRESS AND IMPLIED, INCLUDING WITHOUT LIMITATION ANY IMPLIED WARRANTIES OF MERCHANTABILITY, FITNESS FOR A PARTICULAR PURPOSE OR NON-INFRINGEMENT OF THIRD PARTY INTELLECTUAL PROPERTY RIGHTS.

These resources are intended for skilled developers designing with TI products. You are solely responsible for (1) selecting the appropriate TI products for your application, (2) designing, validating and testing your application, and (3) ensuring your application meets applicable standards, and any other safety, security, or other requirements. These resources are subject to change without notice. TI grants you permission to use these resources only for development of an application that uses the TI products described in the resource. Other reproduction and display of these resources is prohibited. No license is granted to any other TI intellectual property right or to any third party intellectual property right. TI disclaims responsibility for, and you will fully indemnify TI and its representatives against, any claims, damages, costs, losses, and liabilities arising out of your use of these resources.

TI's products are provided subject to TI's Terms of Sale (www.ti.com/legal/termsofsale.html) or other applicable terms available either on ti.com or provided in conjunction with such TI products. TI's provision of these resources does not expand or otherwise alter TI's applicable warranties or warranty disclaimers for TI products.

Mailing Address: Texas Instruments, Post Office Box 655303, Dallas, Texas 75265
Copyright © 2020, Texas Instruments Incorporated