

# SN75374 QUADRUPLE MOSFET DRIVER

SLRS028A – SEPTEMBER 1988 – REVISED NOVEMBER 2004

- Quadruple Circuits Capable of Driving High-Capacitance Loads at High Speeds
- Output Supply Voltage Range From 5 V to 24 V
- Low Standby Power Dissipation
- $V_{CC3}$  Supply Maximizes Output Source Voltage

## description/ordering information

The SN75374 is a quadruple NAND interface circuit designed to drive power MOSFETs from TTL inputs. It provides the high current and voltage necessary to drive large capacitive loads at high speeds.

The outputs can be switched very close to the  $V_{CC2}$  supply rail when  $V_{CC3}$  is about 3 V higher than  $V_{CC2}$ .  $V_{CC3}$  also can be tied directly to  $V_{CC2}$  when the source voltage requirements are lower.

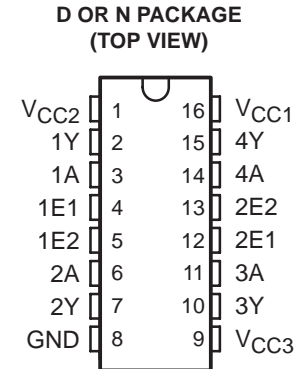

## ORDERING INFORMATION

$T_A$	PACKAGE†		ORDERABLE PART NUMBER	TOP-SIDE MARKING
0°C to 70°C	PDIP (N)	Tube of 25	SN75374N	SN75374N
	SOIC (D)	Tube of 40	SN75374D	SN75374
		Reel of 2500	SN75374DR	

† Package drawings, standard packing quantities, thermal data, symbolization, and PCB design guidelines are available at [www.ti.com/sc/package](http://www.ti.com/sc/package).

## logic diagram (positive logic)

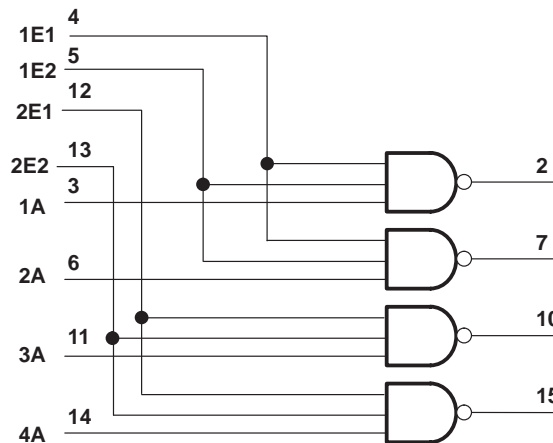

Please be aware that an important notice concerning availability, standard warranty, and use in critical applications of Texas Instruments semiconductor products and disclaimers thereto appears at the end of this data sheet.

PRODUCTION DATA information is current as of publication date. Products conform to specifications per the terms of Texas Instruments standard warranty. Production processing does not necessarily include testing of all parameters.

 **TEXAS  
INSTRUMENTS**

POST OFFICE BOX 655303 • DALLAS, TEXAS 75265

Copyright © 2004, Texas Instruments Incorporated

# SN75374 QUADRUPLE MOSFET DRIVER

SLRS028A – SEPTEMBER 1988 – REVISED NOVEMBER 2004

## schematic (each driver)

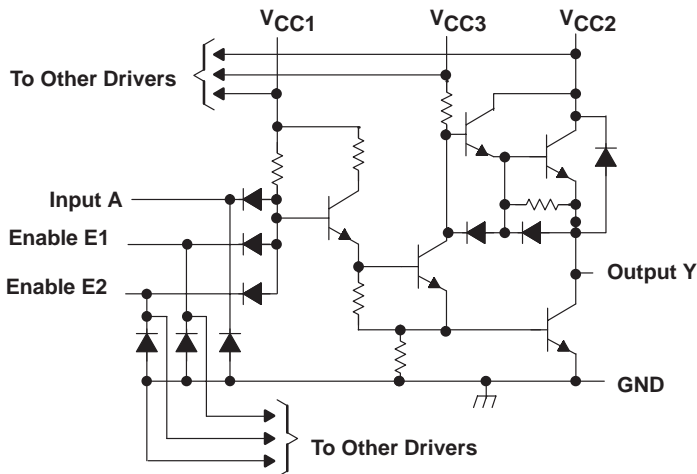

## absolute maximum ratings over operating free-air temperature range (unless otherwise noted)†

Supply voltage range (see Note 1):	$V_{CC1}$ .....	-0.5 V to 7 V
	$V_{CC2}$ .....	-0.5 V to 25 V
	$V_{CC3}$ .....	-0.5 V to 30 V
Input voltage, $V_I$ .....		5.5 V
Peak output current, $I_O$ ( $t_W < 10$ ms, duty cycle < 50%) .....		500 mA
Package thermal impedance, $\theta_{JA}$ (see Notes 2 and 3):	D package .....	73°C/W
	N package .....	67°C/W
Operating virtual junction temperature, $T_J$ .....		150°C
Storage temperature range, $T_{stg}$ .....		-65°C to 150°C

† Stresses beyond those listed under “absolute maximum ratings” may cause permanent damage to the device. These are stress ratings only, and functional operation of the device at these or any other conditions beyond those indicated under “recommended operating conditions” is not implied. Exposure to absolute-maximum-rated conditions for extended periods may affect device reliability.

- NOTES:
1. Voltage values are with respect to network ground terminal.
  2. Maximum power dissipation is a function of  $T_J(\max)$ ,  $\theta_{JA}$ , and  $T_A$ . The maximum allowable power dissipation at any allowable ambient temperature is  $P_D = (T_J(\max) - T_A)/\theta_{JA}$ . Operating at the absolute maximum  $T_J$  of 150°C can affect reliability.
  3. The package thermal impedance is calculated in accordance with JESD 51-7.

## recommended operating conditions

		MIN	NOM	MAX	UNIT
$V_{CC1}$	Supply voltage	4.75	5	5.25	V
$V_{CC2}$	Supply voltage	4.75	20	24	V
$V_{CC3}$	Supply voltage	$V_{CC2}$	24	28	V
$V_{CC3} - V_{CC2}$	Voltage difference between supply voltages	0	4	10	V
$V_{IH}$	High-level input voltage	2			V
$V_{IL}$	Low-level input voltage			0.8	V
$I_{OH}$	High-level output current			-10	mA
$I_{OL}$	Low-level output current			40	mA
$T_A$	Operating free-air temperature	0		70	°C



# SN75374 QUADRUPLE MOSFET DRIVER

SLRS028A – SEPTEMBER 1988 – REVISED NOVEMBER 2004

**electrical characteristics over recommended ranges of  $V_{CC1}$ ,  $V_{CC2}$ ,  $V_{CC3}$ , and operating free-air temperature (unless otherwise noted)**

PARAMETER		TEST CONDITIONS	MIN	TYP†	MAX	UNIT
$V_{IK}$	Input clamp voltage	$I_I = -12 \text{ mA}$			-1.5	V
$V_{OH}$	High-level output voltage	$V_{CC3} = V_{CC2} + 3 \text{ V}$ , $V_{IL} = 0.8 \text{ V}$ , $I_{OH} = -100 \mu\text{A}$	$V_{CC2} - 0.3$	$V_{CC2} - 0.1$		V
		$V_{CC3} = V_{CC2} + 3 \text{ V}$ , $V_{IL} = 0.8 \text{ V}$ , $I_{OH} = -10 \text{ mA}$	$V_{CC2} - 1.3$	$V_{CC2} - 0.9$		
		$V_{CC3} = V_{CC2}$ , $V_{IL} = 0.8 \text{ V}$ , $I_{OH} = -50 \mu\text{A}$	$V_{CC2} - 1$	$V_{CC2} - 0.7$		
		$V_{CC3} = V_{CC2}$ , $V_{IL} = 0.8 \text{ V}$ , $I_{OH} = -10 \text{ mA}$	$V_{CC2} - 2.5$	$V_{CC2} - 1.8$		
$V_{OL}$	Low-level output voltage	$V_{IH} = 2 \text{ V}$ , $I_{OL} = 10 \text{ mA}$		0.15	0.3	V
		$V_{CC2} = 15 \text{ V to } 28 \text{ V}$ , $V_{IH} = 2 \text{ V}$ , $I_{OL} = 40 \text{ mA}$		0.25	0.5	
$V_F$	Output clamp-diode forward voltage	$V_I = 0$ , $I_F = 20 \text{ mA}$			1.5	V
$I_I$	Input current at maximum input voltage	$V_I = 5.5 \text{ V}$			1	mA
$I_{IH}$	High-level input current	Any A Any E $V_I = 2.4 \text{ V}$			40	$\mu\text{A}$
					80	
$I_{IL}$	Low-level input current	Any A Any E $V_I = 0.4 \text{ V}$		-1	-1.6	mA
				-2	-3.2	
$I_{CC1(H)}$	Supply current from $V_{CC1}$ , all outputs high	$V_{CC1} = 5.25 \text{ V}$ , All inputs at 0 V, $V_{CC2} = 24 \text{ V}$ , $V_{CC3} = 28 \text{ V}$ , No load		4	8	mA
$I_{CC2(H)}$	Supply current from $V_{CC2}$ , all outputs high			-2.2	0.25	
$I_{CC3(H)}$	Supply current from $V_{CC3}$ , all outputs high			2.2	3.5	
$I_{CC1(L)}$	Supply current from $V_{CC1}$ , all outputs low	$V_{CC1} = 5.25 \text{ V}$ , All inputs at 5 V, $V_{CC2} = 24 \text{ V}$ , $V_{CC3} = 28 \text{ V}$ , No load		31	47	mA
$I_{CC2(L)}$	Supply current from $V_{CC2}$ , all outputs low				2	
$I_{CC3(L)}$	Supply current from $V_{CC3}$ , all outputs low			16	27	
$I_{CC2(H)}$	Supply current from $V_{CC2}$ , all outputs high	$V_{CC1} = 5.25 \text{ V}$ , All inputs at 0 V, $V_{CC2} = 24 \text{ V}$ , $V_{CC3} = 24 \text{ V}$ , No load			0.25	mA
$I_{CC3(H)}$	Supply current from $V_{CC3}$ , all outputs high				0.5	
$I_{CC2(S)}$	Supply current from $V_{CC2}$ , standby condition	$V_{CC1} = 0$ , All inputs at 0 V, $V_{CC2} = 24 \text{ V}$ , $V_{CC3} = 24 \text{ V}$ , No load			0.25	mA
$I_{CC3(S)}$	Supply current from $V_{CC3}$ , standby condition				0.5	

† All typical values are at  $V_{CC1} = 5 \text{ V}$ ,  $V_{CC2} = 20 \text{ V}$ ,  $V_{CC3} = 24 \text{ V}$ , and  $T_A = 25^\circ\text{C}$ , except for  $V_{OH}$  for which  $V_{CC2}$  and  $V_{CC3}$  are as stated under test conditions.

**switching characteristics,  $V_{CC1} = 5 \text{ V}$ ,  $V_{CC2} = 20 \text{ V}$ ,  $V_{CC3} = 24 \text{ V}$ ,  $T_A = 25^\circ\text{C}$**

PARAMETER		TEST CONDITIONS	MIN	TYP	MAX	UNIT	
$t_{DLH}$	Delay time, low- to high-level output	$C_L = 200 \text{ pF}$ , $R_D = 24 \Omega$ , See Figure 1		20	30	ns	
$t_{DHL}$	Delay time, high- to low-level output			10	20	ns	
$t_{PLH}$	Propagation delay time, low- to high-level output			10	40	60	ns
$t_{PHL}$	Propagation delay time, high- to low-level output			10	30	50	ns
$t_{TLH}$	Transition time, low- to high-level output				20	30	ns
$t_{THL}$	Transition time, high- to low-level output				20	30	ns



# SN75374 QUADRUPLE MOSFET DRIVER

SLRS028A – SEPTEMBER 1988 – REVISED NOVEMBER 2004

## PARAMETER MEASUREMENT INFORMATION

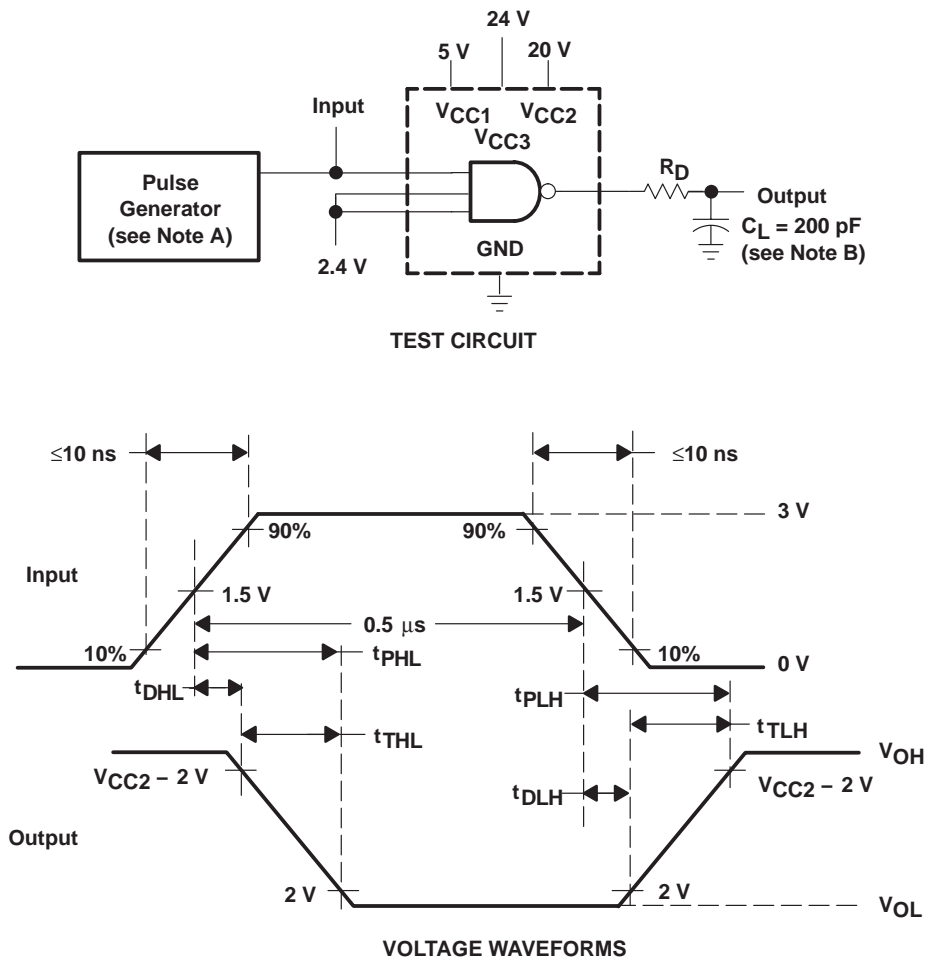

NOTES: A. The pulse generator has the following characteristics: PRR = 1 MHz,  $Z_O \approx 50 \Omega$ .  
B.  $C_L$  includes probe and jig capacitance.

Figure 1. Test Circuit and Voltage Waveforms, Each Driver

TYPICAL CHARACTERISTICS

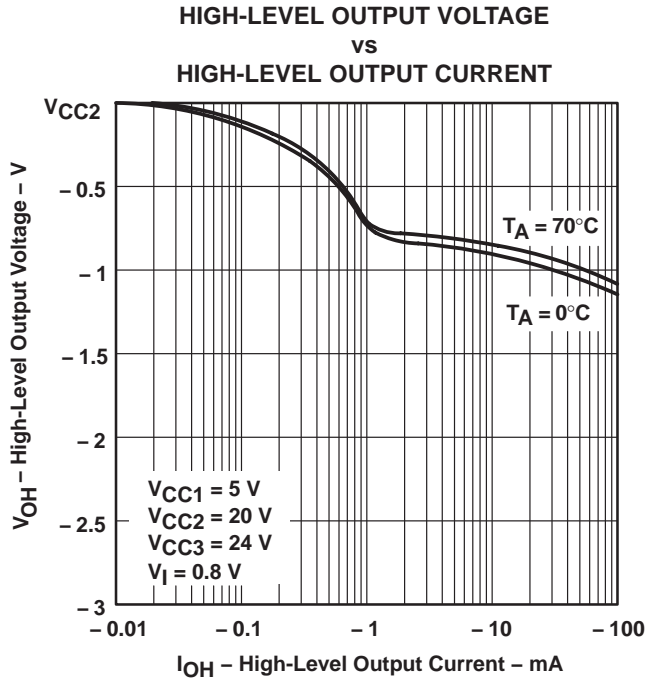

Figure 2

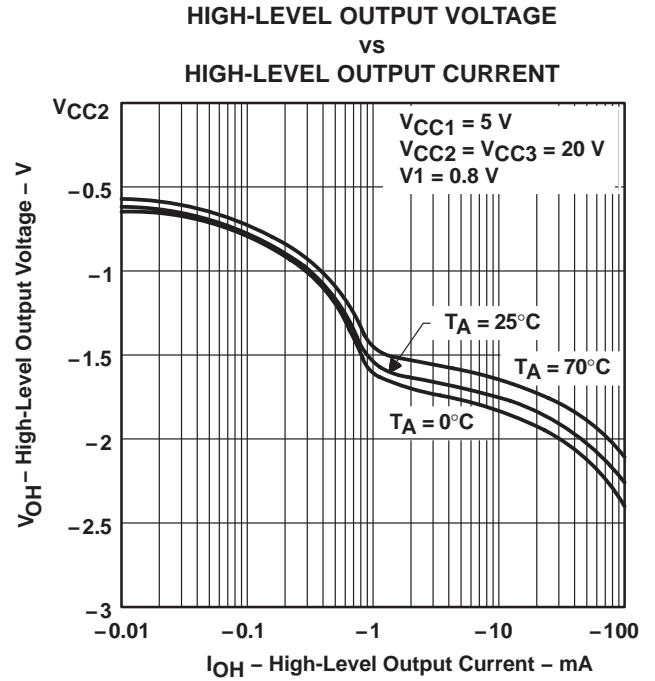

Figure 3

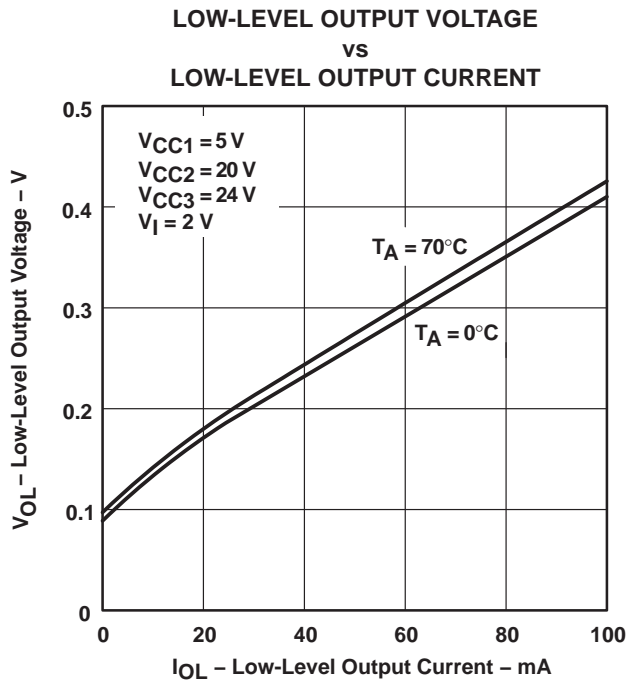

Figure 4

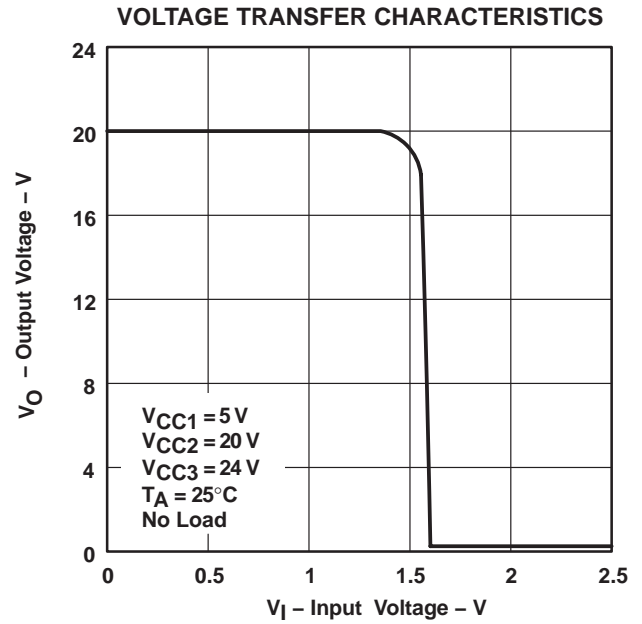

Figure 5

# SN75374 QUADRUPLE MOSFET DRIVER

SLRS028A – SEPTEMBER 1988 – REVISED NOVEMBER 2004

## TYPICAL CHARACTERISTICS

PROPAGATION DELAY TIME  
LOW- TO HIGH-LEVEL OUTPUT  
vs  
FREE-AIR TEMPERATURE

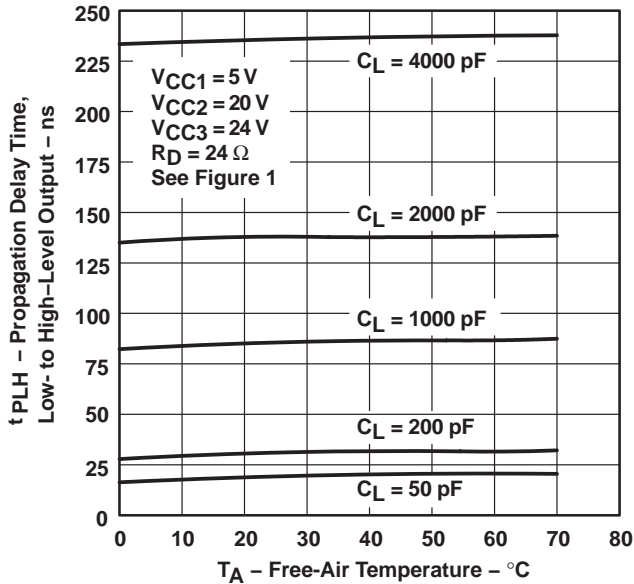

Figure 6

PROPAGATION DELAY TIME  
HIGH- TO LOW-LEVEL OUTPUT  
vs  
FREE-AIR TEMPERATURE

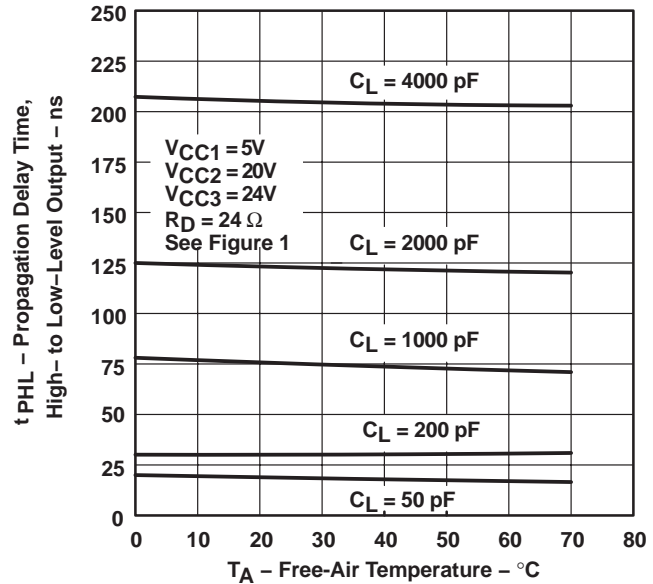

Figure 7

PROPAGATION DELAY TIME  
LOW-TO HIGH-LEVEL OUTPUT  
vs  
 $V_{CC2}$  SUPPLY VOLTAGE

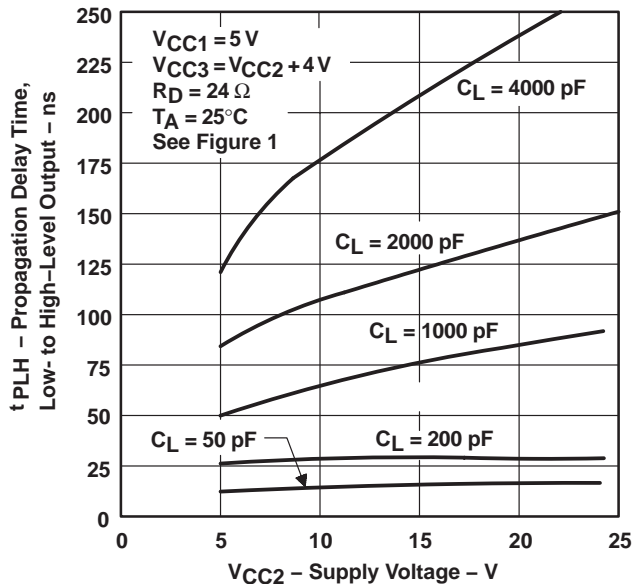

Figure 8

PROPAGATION DELAY TIME  
HIGH- TO LOW-LEVEL OUTPUT  
vs  
 $V_{CC2}$  SUPPLY VOLTAGE

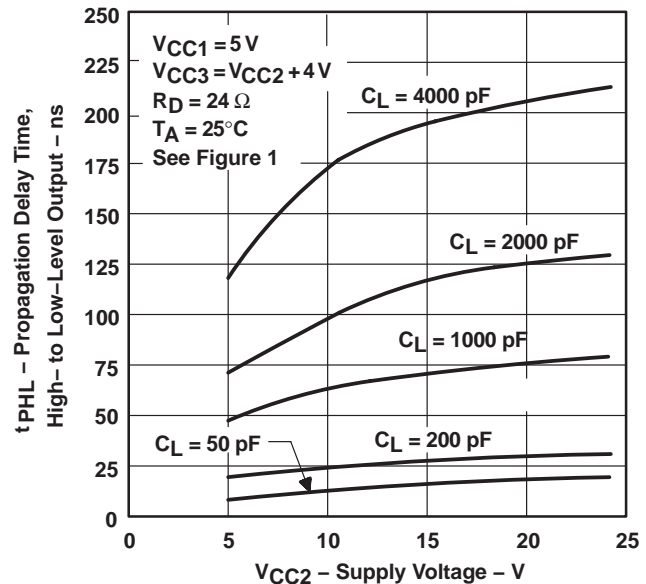
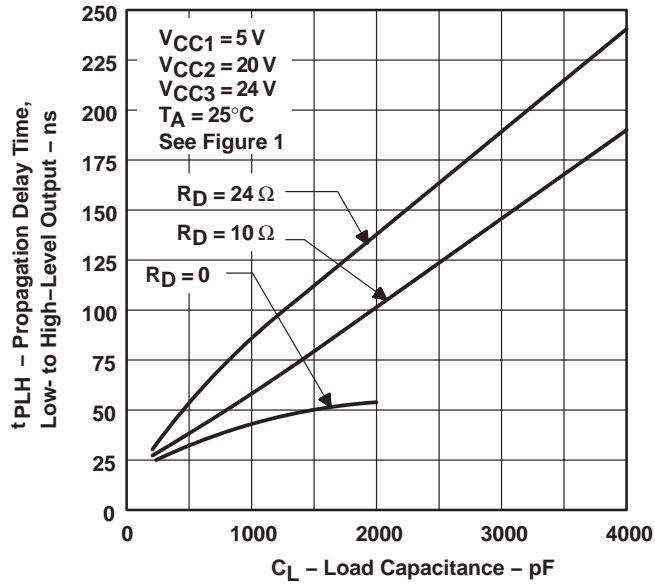

Figure 9

**TYPICAL CHARACTERISTICS**

**PROPAGATION DELAY TIME  
LOW- TO HIGH-LEVEL OUTPUT  
vs  
LOAD CAPACITANCE**



**Figure 10**

**PROPAGATION DELAY TIME  
HIGH- TO LOW-LEVEL OUTPUT  
vs  
LOAD CAPACITANCE**

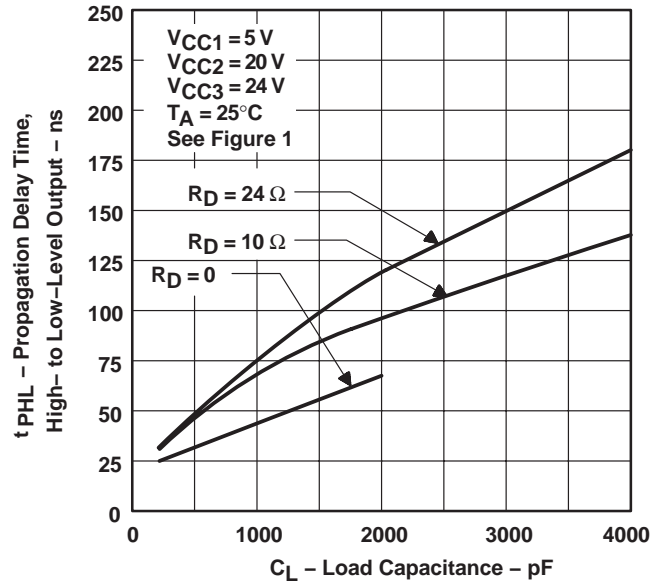

**Figure 11**

**POWER DISSIPATION (ALL DRIVERS)  
vs  
FREQUENCY**

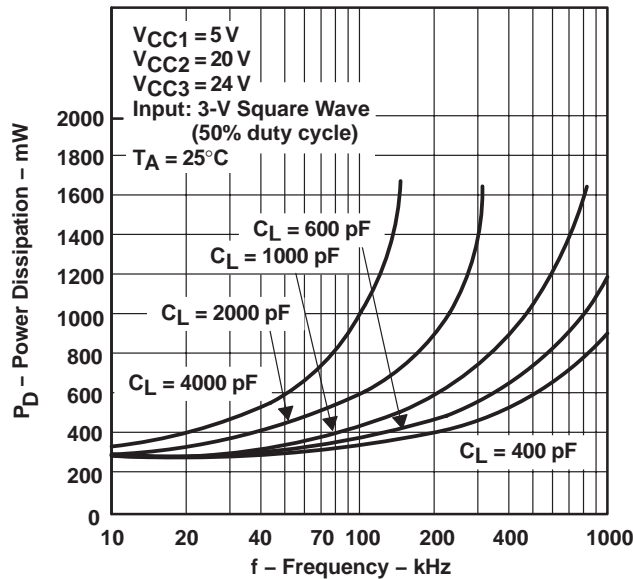

**Figure 12**

NOTE: For  $R_D = 0$ , operation with  $C_L > 2000\text{ pF}$  violates absolute maximum current rating.

# SN75374 QUADRUPLE MOSFET DRIVER

SLRS028A – SEPTEMBER 1988 – REVISED NOVEMBER 2004

## THERMAL INFORMATION

### power-dissipation precautions

Significant power may be dissipated in the SN75374 driver when charging and discharging high-capacitance loads over a wide voltage range at high frequencies. Figure 12 shows the power dissipated in a typical SN75374 as a function of frequency and load capacitance. Average power dissipated by this driver is derived from the equation:

$$P_{T(AV)} = P_{DC(AV)} + P_{C(AV)} + P_{S(AV)}$$

where  $P_{DC(AV)}$  is the steady-state power dissipation with the output high or low,  $P_{C(AV)}$  is the power level during charging or discharging of the load capacitance, and  $P_{S(AV)}$  is the power dissipation during switching between the low and high levels. None of these include energy transferred to the load, and all are averaged over a full cycle.

The power components per driver channel are:

$$P_{DC(AV)} = \frac{(P_H t_H + P_L t_L)}{T}$$

$$P_{C(AV)} \approx CV^2 f$$

$$P_{S(AV)} = \frac{(P_{LH} t_{LH} + P_{HL} t_{HL})}{T}$$

where the times are as defined in Figure 15.

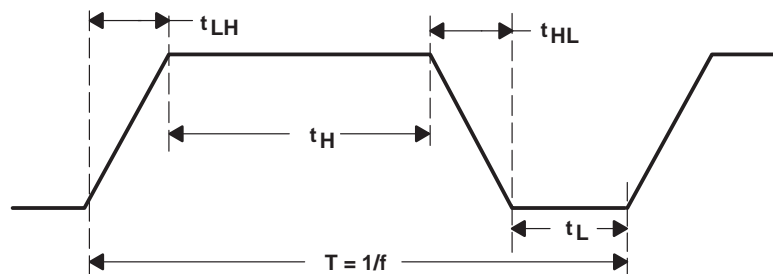

Figure 13. Output-Voltage Waveform



## THERMAL INFORMATION

### power-dissipation precautions (continued)

$P_L$ ,  $P_H$ ,  $P_{LH}$ , and  $P_{HL}$  are the respective instantaneous levels of power dissipation, and  $C$  is the load capacitance.  $V_C$  is the voltage across the load capacitance during the charge cycle shown by the equation:

$$V_C = V_{OH} - V_{OL}$$

$P_{S(AV)}$  may be ignored for power calculations at low frequencies.

In the following power calculation, all four channels are operating under identical conditions:  $f = 0.2$  MHz,  $V_{OH} = 19.9$  V and  $V_{OL} = 0.15$  V with  $V_{CC1} = 5$  V,  $V_{CC2} = 20$  V,  $V_{CC3} = 24$  V,  $V_C = 19.75$  V,  $C = 1000$  pF, and the duty cycle = 60%. At 0.2 MHz for  $C_L < 2000$  pF,  $P_{S(AV)}$  is negligible and can be ignored. When the output voltage is low,  $I_{CC2}$  is negligible and can be ignored.

On a per-channel basis using data-sheet values,

$$P_{DC(AV)} = \left[ 5 \text{ V} \left( \frac{4 \text{ mA}}{4} \right) + 20 \text{ V} \left( \frac{-2.2 \text{ mA}}{4} \right) + 24 \text{ V} \left( \frac{2.2 \text{ mA}}{4} \right) \right] 0.6 +$$

$$\left[ 5 \text{ V} \left( \frac{31 \text{ mA}}{4} \right) + 20 \text{ V} \left( \frac{0 \text{ mA}}{4} \right) + 24 \text{ V} \left( \frac{16 \text{ mA}}{4} \right) \right] 0.4$$

$$P_{DC(AV)} = 58.2 \text{ mW per channel}$$

Power during the charging time of the load capacitance is

$$P_{C(AV)} = (1000 \text{ pF})(19.75 \text{ V})^2(0.2 \text{ MHz}) = 78 \text{ mW per channel}$$

Total power for each driver is:

$$P_{T(AV)} = 58.2 \text{ mW} + 78 \text{ mW} = 136.2 \text{ mW}$$

The total package power is:

$$P_{T(AV)} = (136.2)(4) = 544.8 \text{ mW}$$

# SN75374 QUADRUPLE MOSFET DRIVER

SLRS028A – SEPTEMBER 1988 – REVISED NOVEMBER 2004

## APPLICATION INFORMATION

### driving power MOSFETs

The drive requirements of power MOSFETs are much lower than comparable bipolar power transistors. The input impedance of an FET consists of a reverse-biased PN junction that can be described as a large capacitance in parallel with a very high resistance. For this reason, the commonly used open-collector driver with a pullup resistor is not satisfactory for high-speed applications. In Figure 14a, an IRF151 power MOSFET switching an inductive load is driven by an open-collector transistor driver with a 470-Ω pullup resistor. The input capacitance ( $C_{ISS}$ ) specification for an IRF151 is 4000 pF maximum. The resulting long turn-on time, due to the product of input capacitance and the pullup resistor, is shown in Figure 14b.

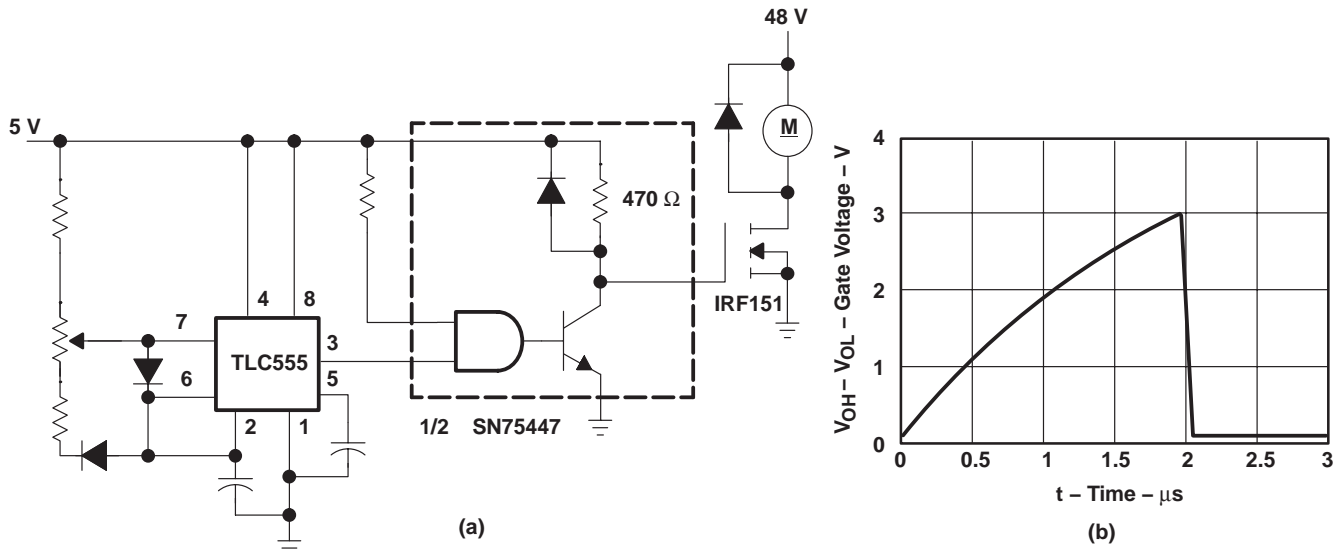

Figure 14. Power MOSFET Drive Using SN75447

A faster, more efficient drive circuit uses an active pullup, as well as an active pulldown output configuration, referred to as a totem-pole output. The SN75374 driver provides the high-speed totem-pole drive desired in an application of this type (see Figure 15a). The resulting faster switching speeds are shown in Figure 15b.

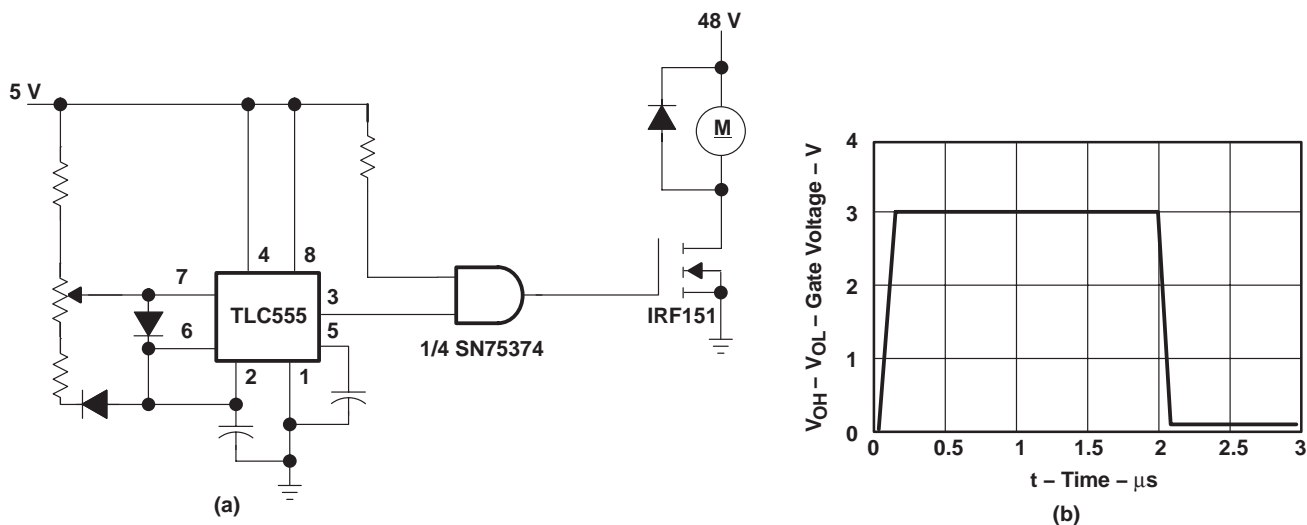

Figure 15. Power MOSFET Drive Using SN75374

---

## APPLICATION INFORMATION

### driving power MOSFETs (continued)

Power MOSFET drivers must be capable of supplying high peak currents to achieve fast switching speeds as shown by the equation:

$$I_{PK} = \frac{VC}{t_r}$$

where C is the capacitive load and  $t_r$  is the desired rise time. V is the voltage that the capacitance is charged to. In the circuit shown in Figure 14a, V is found by the equation:

$$V = V_{OH} - V_{OL}$$

Peak current required to maintain a rise time of 100 ns in the circuit of Figure 14a is:

$$I_{PK} = \frac{(3 - 0)4(10^{-9})}{100(10^{-9})} = 120 \text{ mA}$$

Circuit capacitance can be ignored because it is very small compared to the input capacitance of the IRF151. With a  $V_{CC}$  of 5 V and assuming worst-case conditions, the gate drive voltage is 3 V.

For applications in which the full voltage of  $V_{CC2}$  must be supplied to the MOSFET gate,  $V_{CC3}$  should be at least 3 V higher than  $V_{CC2}$ .

**PACKAGING INFORMATION**

Orderable Device	Status (1)	Package Type	Package Drawing	Pins	Package Qty	Eco Plan (2)	Lead finish/ Ball material (6)	MSL Peak Temp (3)	Op Temp (°C)	Device Marking (4/5)	Samples
SN75374D	ACTIVE	SOIC	D	16	40	RoHS & Green	NIPDAU	Level-1-260C-UNLIM	0 to 70	SN75374	<a href="#">Samples</a>
SN75374DE4	ACTIVE	SOIC	D	16	40	RoHS & Green	NIPDAU	Level-1-260C-UNLIM	0 to 70	SN75374	<a href="#">Samples</a>
SN75374DR	ACTIVE	SOIC	D	16	2500	RoHS & Green	NIPDAU	Level-1-260C-UNLIM	0 to 70	SN75374	<a href="#">Samples</a>
SN75374DRE4	ACTIVE	SOIC	D	16	2500	RoHS & Green	NIPDAU	Level-1-260C-UNLIM	0 to 70	SN75374	<a href="#">Samples</a>
SN75374DRG4	ACTIVE	SOIC	D	16	2500	RoHS & Green	NIPDAU	Level-1-260C-UNLIM	0 to 70	SN75374	<a href="#">Samples</a>
SN75374N	ACTIVE	PDIP	N	16	25	RoHS & Green	NIPDAU	N / A for Pkg Type	0 to 70	SN75374N	<a href="#">Samples</a>

(1) The marketing status values are defined as follows:

**ACTIVE:** Product device recommended for new designs.

**LIFEBUY:** TI has announced that the device will be discontinued, and a lifetime-buy period is in effect.

**NRND:** Not recommended for new designs. Device is in production to support existing customers, but TI does not recommend using this part in a new design.

**PREVIEW:** Device has been announced but is not in production. Samples may or may not be available.

**OBSOLETE:** TI has discontinued the production of the device.

(2) **RoHS:** TI defines "RoHS" to mean semiconductor products that are compliant with the current EU RoHS requirements for all 10 RoHS substances, including the requirement that RoHS substance do not exceed 0.1% by weight in homogeneous materials. Where designed to be soldered at high temperatures, "RoHS" products are suitable for use in specified lead-free processes. TI may reference these types of products as "Pb-Free".

**RoHS Exempt:** TI defines "RoHS Exempt" to mean products that contain lead but are compliant with EU RoHS pursuant to a specific EU RoHS exemption.

**Green:** TI defines "Green" to mean the content of Chlorine (Cl) and Bromine (Br) based flame retardants meet JS709B low halogen requirements of <=1000ppm threshold. Antimony trioxide based flame retardants must also meet the <=1000ppm threshold requirement.

(3) MSL, Peak Temp. - The Moisture Sensitivity Level rating according to the JEDEC industry standard classifications, and peak solder temperature.

(4) There may be additional marking, which relates to the logo, the lot trace code information, or the environmental category on the device.

(5) Multiple Device Markings will be inside parentheses. Only one Device Marking contained in parentheses and separated by a "~" will appear on a device. If a line is indented then it is a continuation of the previous line and the two combined represent the entire Device Marking for that device.

(6) Lead finish/Ball material - Orderable Devices may have multiple material finish options. Finish options are separated by a vertical ruled line. Lead finish/Ball material values may wrap to two lines if the finish value exceeds the maximum column width.

**Important Information and Disclaimer:** The information provided on this page represents TI's knowledge and belief as of the date that it is provided. TI bases its knowledge and belief on information provided by third parties, and makes no representation or warranty as to the accuracy of such information. Efforts are underway to better integrate information from third parties. TI has taken and continues to take reasonable steps to provide representative and accurate information but may not have conducted destructive testing or chemical analysis on incoming materials and chemicals. TI and TI suppliers consider certain information to be proprietary, and thus CAS numbers and other limited information may not be available for release.

In no event shall TI's liability arising out of such information exceed the total purchase price of the TI part(s) at issue in this document sold by TI to Customer on an annual basis.

**TAPE AND REEL INFORMATION**



**QUADRANT ASSIGNMENTS FOR PIN 1 ORIENTATION IN TAPE**



\*All dimensions are nominal

Device	Package Type	Package Drawing	Pins	SPQ	Reel Diameter (mm)	Reel Width W1 (mm)	A0 (mm)	B0 (mm)	K0 (mm)	P1 (mm)	W (mm)	Pin1 Quadrant
SN75374DR	SOIC	D	16	2500	330.0	16.4	6.5	10.3	2.1	8.0	16.0	Q1

**TAPE AND REEL BOX DIMENSIONS**



\*All dimensions are nominal

Device	Package Type	Package Drawing	Pins	SPQ	Length (mm)	Width (mm)	Height (mm)
SN75374DR	SOIC	D	16	2500	333.2	345.9	28.6





N (R-PDIP-T\*\*)

PLASTIC DUAL-IN-LINE PACKAGE

16 PINS SHOWN



- NOTES:
- A. All linear dimensions are in inches (millimeters).
  - B. This drawing is subject to change without notice.
  - Falls within JEDEC MS-001, except 18 and 20 pin minimum body length (Dim A).
  - The 20 pin end lead shoulder width is a vendor option, either half or full width.

## IMPORTANT NOTICE AND DISCLAIMER

TI PROVIDES TECHNICAL AND RELIABILITY DATA (INCLUDING DATASHEETS), DESIGN RESOURCES (INCLUDING REFERENCE DESIGNS), APPLICATION OR OTHER DESIGN ADVICE, WEB TOOLS, SAFETY INFORMATION, AND OTHER RESOURCES "AS IS" AND WITH ALL FAULTS, AND DISCLAIMS ALL WARRANTIES, EXPRESS AND IMPLIED, INCLUDING WITHOUT LIMITATION ANY IMPLIED WARRANTIES OF MERCHANTABILITY, FITNESS FOR A PARTICULAR PURPOSE OR NON-INFRINGEMENT OF THIRD PARTY INTELLECTUAL PROPERTY RIGHTS.

These resources are intended for skilled developers designing with TI products. You are solely responsible for (1) selecting the appropriate TI products for your application, (2) designing, validating and testing your application, and (3) ensuring your application meets applicable standards, and any other safety, security, or other requirements. These resources are subject to change without notice. TI grants you permission to use these resources only for development of an application that uses the TI products described in the resource. Other reproduction and display of these resources is prohibited. No license is granted to any other TI intellectual property right or to any third party intellectual property right. TI disclaims responsibility for, and you will fully indemnify TI and its representatives against, any claims, damages, costs, losses, and liabilities arising out of your use of these resources.

TI's products are provided subject to TI's Terms of Sale ([www.ti.com/legal/termsofsale.html](http://www.ti.com/legal/termsofsale.html)) or other applicable terms available either on [ti.com](http://ti.com) or provided in conjunction with such TI products. TI's provision of these resources does not expand or otherwise alter TI's applicable warranties or warranty disclaimers for TI products.

Mailing Address: Texas Instruments, Post Office Box 655303, Dallas, Texas 75265  
Copyright © 2020, Texas Instruments Incorporated