

SN75ALS197 QUADRUPLE DIFFERENTIAL LINE RECEIVER

SLLS045B – JANUARY 1989 – REVISED MAY 1995

- Meets or Exceeds the Requirements of ITU Recommendations V.10, V.11, X.26, and X.27
- Designed for Multipoint Bus Transmission on Long Bus Lines in Noisy Environments
- Designed to Operate Up to 20 Mbaud
- 3-State Outputs
- Common-Mode Input Voltage Range – 7 V to 7 V
- Input Sensitivity . . . ± 300 mV
- Input Hysteresis . . . 120 mV Typ
- High-Input Impedance . . . 12 k Ω Min
- Operates from Single 5-V Supply
- Low Supply-Current Requirement 35 mA Max
- Improved Speed and Power Consumption Compared to AM26LS32A

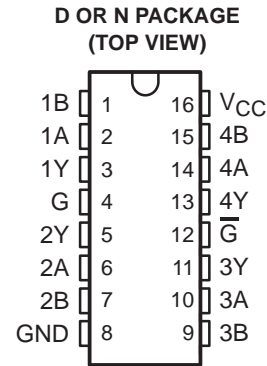

description

The SN75ALS197 is a monolithic, quadruple line receiver with 3-state outputs designed using advanced, low-power, Schottky technology. This technology provides combined improvements in bar design, tooling production, and wafer fabrication. This, in turn, provides significantly lower power requirements and permits much higher data throughput than other designs. The device meets the specifications of ITU Recommendations V.10, V.11, X.26, and X.27. It features 3-state outputs that permit direct connection to a bus-organized system with a fail-safe design that ensures the outputs will always be high if the inputs are open.

The device is optimized for balanced, multipoint bus transmission at rates up to 20 megabits per second. The input features high-input impedance, input hysteresis for increased noise immunity, and an input sensitivity of ± 300 mV over a common-mode input voltage range of –7 V to 7 V. It also features active-high and active-low enable functions that are common to the four channels. The SN75ALS197 is designed for optimum performance when used with the SN75ALS192 quadruple differential line driver.

The SN75ALS197 is characterized for operation from 0°C to 70°C.

FUNCTION TABLE
(each receiver)

DIFFERENTIAL INPUTS A–B	ENABLES		OUTPUT Y
	G	\bar{G}	
$V_{ID} \geq 0.3$ V	H	X	H
	X	L	H
-0.3 V < V_{ID} < 0.3 V	H	X	?
	X	L	?
$V_{ID} \leq -0.3$ V	H	X	L
	X	L	L
X	L	H	Z
Open	H	X	H
	X	L	H

H = high level, L = low level, X = irrelevant, ? = indeterminate, Z = high impedance (off)



Please be aware that an important notice concerning availability, standard warranty, and use in critical applications of Texas Instruments semiconductor products and disclaimers thereto appears at the end of this data sheet.

PRODUCTION DATA information is current as of publication date. Products conform to specifications per the terms of Texas Instruments standard warranty. Production processing does not necessarily include testing of all parameters.

 **TEXAS
INSTRUMENTS**

POST OFFICE BOX 655303 • DALLAS, TEXAS 75265

Copyright © 1995, Texas Instruments Incorporated

SN75ALS197 QUADRUPLE DIFFERENTIAL LINE RECEIVER

SLLS045B – JANUARY 1989 – REVISED MAY 1995

logic symbol†

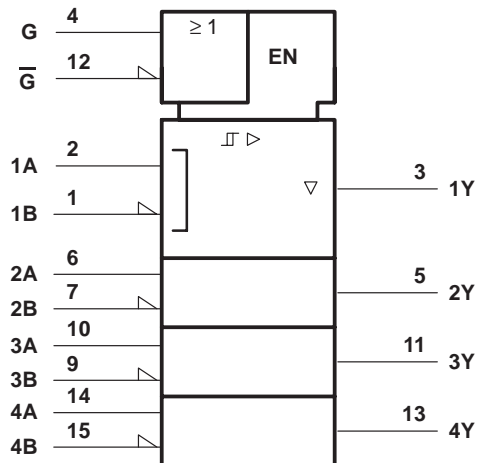

logic diagram (positive logic)

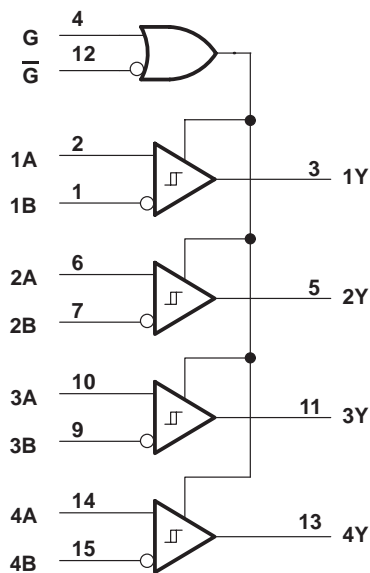

† This symbol is in accordance with ANSI/IEEE Std 91-1984 and IEC Publication 617-12.

schematics of inputs and outputs

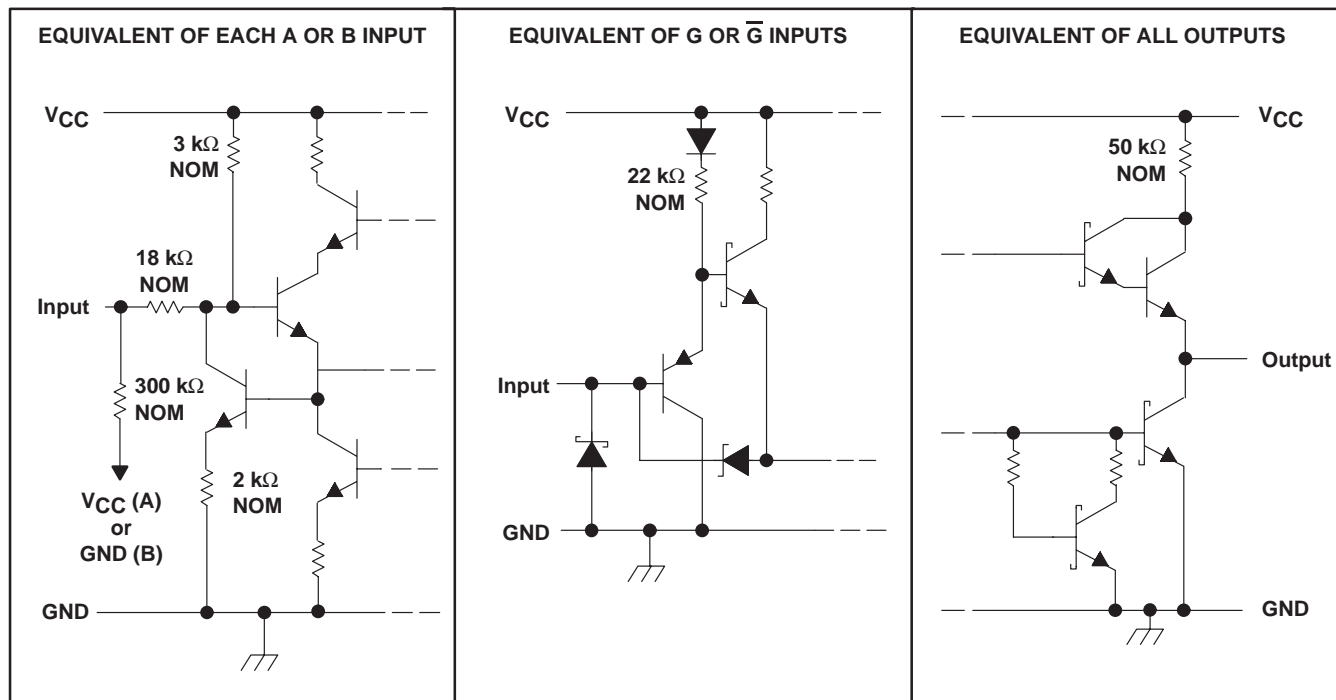

SN75ALS197 QUADRUPLE DIFFERENTIAL LINE RECEIVER

SLLS045B – JANUARY 1989 – REVISED MAY 1995

absolute maximum ratings over operating free-air temperature range (unless otherwise noted)†

Supply voltage, V_{CC} (see Note 1)	7 V
Input voltage, V_I (A or B inputs)	± 15 V
Differential input voltage, V_{ID} (see Note 2)	± 15 V
Enable input voltage, V_I	7 V
Low-level output current, I_{OL}	50 mA
Continuous total dissipation	See Dissipation Rating Table
Operating free-air temperature range, T_A	0°C to 70°C
Storage temperature range, T_{stg}	-65°C to 150°C
Lead temperature 1,6 mm (1/16 inch) from case for 10 seconds	260°C

† Stresses beyond those listed under “absolute maximum ratings” may cause permanent damage to the device. These are stress ratings only, and functional operation of the device at these or any other conditions beyond those indicated under “recommended operating conditions” is not implied. Exposure to absolute-maximum-rated conditions for extended periods may affect device reliability.

- NOTES: 1. All voltage values, except differential input voltage, are with respect to network ground terminal.
 2. Differential input voltage is measured at the noninverting input with respect to the corresponding inverting input.

DISSIPATION RATING TABLE

PACKAGE	$T_A \leq 25^\circ\text{C}$ POWER RATING	DERATING FACTOR	$T_A = 70^\circ\text{C}$ POWER RATING
D	950 mW	7.6 mW/ $^\circ\text{C}$	608 mW
N	1150 mW	9.2 mW/ $^\circ\text{C}$	736 mW

recommended operating conditions

	MIN	NOM	MAX	UNIT
Supply voltage, V_{CC}	4.75	5	5.25	V
Common-mode input voltage, V_{IC}			± 7	V
Differential input voltage, V_{ID}			± 12	V
High-level input voltage, V_{IH}	2			V
Low-level input voltage, V_{IL}			0.8	V
High-level output current, I_{OH}			-400	μA
Low-level output current, I_{OL}			16	mA
Operating free-air temperature, T_A	0		70	$^\circ\text{C}$

SN75ALS197

QUADRUPLE DIFFERENTIAL LINE RECEIVER

SLLS045B – JANUARY 1989 – REVISED MAY 1995

electrical characteristics over recommended range of common-mode input voltage, supply voltage, and operating free-air temperature (unless otherwise noted)

PARAMETER		TEST CONDITIONS	MIN	TYP†	MAX	UNIT
V _{IT+}	Positive-going input threshold voltage				300	mV
V _{IT-}	Negative-going input threshold voltage		-300‡			mV
V _{hys}	Hysteresis voltage (V _{IT+} - V _{IT-})	See Figure 4		120		mV
V _{IK}	Enable-input clamp voltage	I _I = -18 mA			-1.5	V
V _{OH}	High-level output voltage	V _{ID} = 300 mV, I _{OH} = -400 μA	2.7	3.6		V
V _{OL}	Low-level output voltage	V _{ID} = -300 mV			0.45	V
			I _{OL} = 8 mA		0.5	
I _{OZ}	High-impedance-state output current	V _{CC} = 5.25 V	V _O = 2.4 V		20	μA
			V _{OH} = 0.4 V		-20	
I _I	Line input current	Other input at 0 V, See Note 3	V _I = 15 V		0.7	mA
			V _I = -15 V		-1.0	
I _H	High-level enable-input current			20	μA	
		V _{IH} = 5.25 V		100		
I _{IL}	Low-level enable-input current	V _{IL} = 0.4 V			-100	μA
Input resistance			12	18		kΩ
I _{OS}	Short-circuit output current§	V _{ID} = 3 V, V _O = 0	-15	-78	-130	mA
I _{CC}	Supply current	Outputs disabled		22	35	mA

† All typical values are at V_{CC} = 5 V, T_A = 25°C.

‡ The algebraic convention, in which the less positive limit is designated minimum, is used in this data sheet for threshold voltage levels only.

§ Not more than one output should be shorted at a time, and the duration of the short circuit should not exceed one second.

NOTE 3: Refer to ANSI Standard EIA/TIA-422-B and EIA/TIA-423-B for exact conditions.

switching characteristics, V_{CC} = 5 V, T_A = 25°C

PARAMETER		TEST CONDITIONS	MIN	TYP	MAX	UNIT
t _{PLH}	Propagation delay time, low- to high-level output	V _{ID} = -2.5 V to 2.5 V, C _L = 15 pF,		15	22	ns
t _{PHL}	Propagation delay time, high- to low-level output	See Figure 2		15	22	
t _{PZH}	Output enable time to high level	C _L = 15 pF, See Figure 3			13	ns
t _{PZL}	Output enable time to low level				11	
t _{PHZ}	Output disable time from high level	C _L = 15 pF, See Figure 3			13	ns
t _{PLZ}	Output disable time from low level				15	



PARAMETER MEASUREMENT INFORMATION

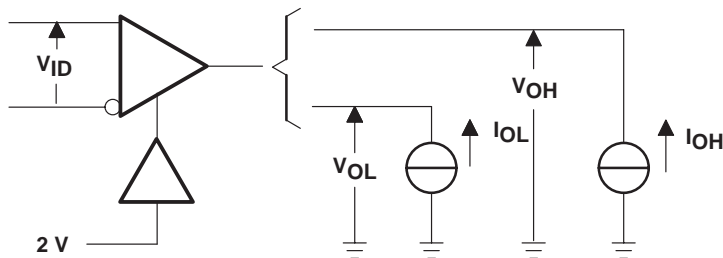
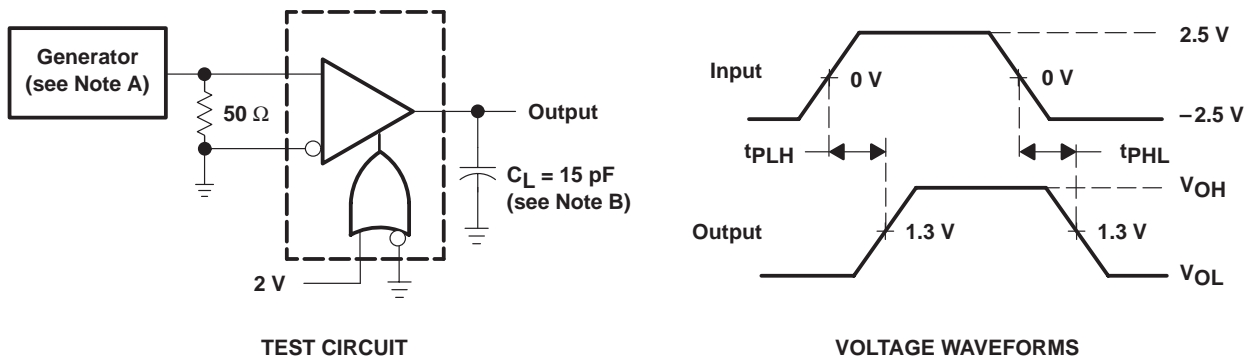

Figure 1. V_{OH} and V_{OL} Test Circuit



- NOTES: A. The input pulse is supplied by a generator having the following characteristics: $PRR \leq 1$ MHz, duty cycle $\leq 50\%$, $Z_O = 50 \Omega$, $t_r \leq 6$ ns, $t_f \leq 6$ ns.
 B. C_L includes probe and jig capacitance.

Figure 2. t_{PLH} and t_{PHL} Test Circuit and Voltage Waveforms

SN75ALS197 QUADRUPLE DIFFERENTIAL LINE RECEIVER

SLLS045B – JANUARY 1989 – REVISED MAY 1995

PARAMETER MEASUREMENT INFORMATION

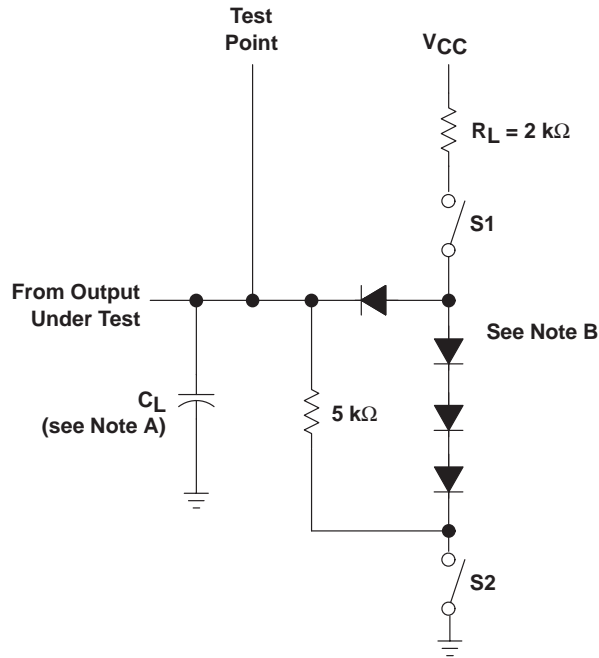

LOAD CIRCUIT

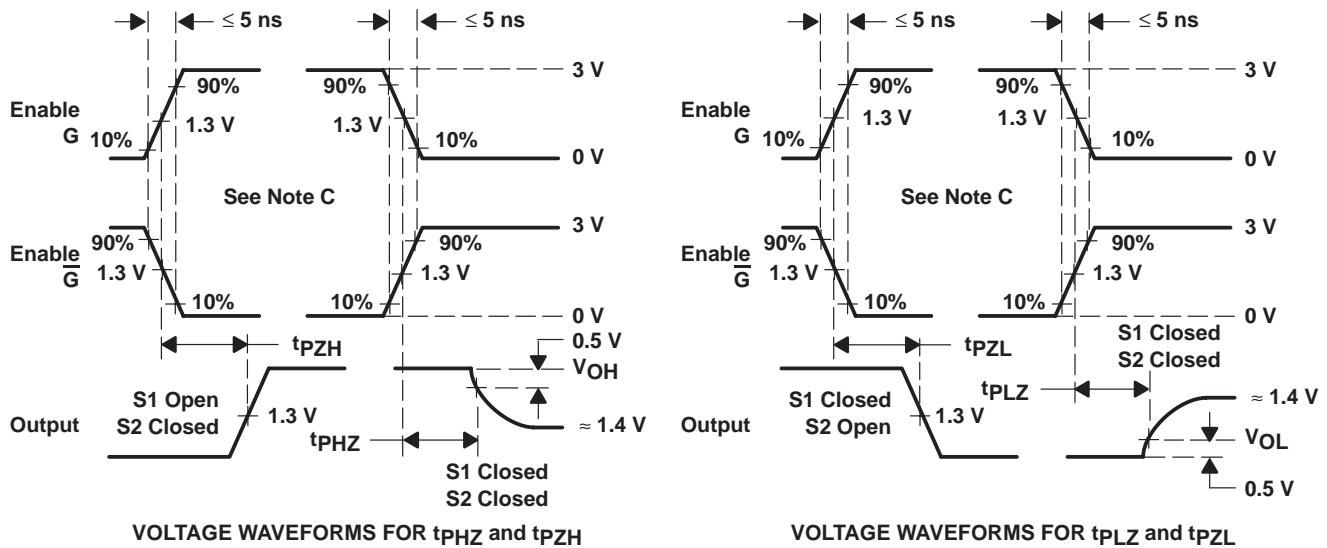

VOLTAGE WAVEFORMS FOR t_{PHZ} and t_{PZH}

VOLTAGE WAVEFORMS FOR t_{PLZ} and t_{PZL}

- NOTES: A. C_L includes probe and jig capacitance.
 B. All diodes are 1N3064 or equivalent.
 C. Enable G is tested with G high; \bar{G} is tested with G low.

Figure 3. t_{PHZ} , t_{PZH} , t_{PLZ} , and t_{PZL} Load Circuit and Voltage Waveforms

TYPICAL CHARACTERISTICS

OUTPUT VOLTAGE
 vs
 ENABLE VOLTAGE

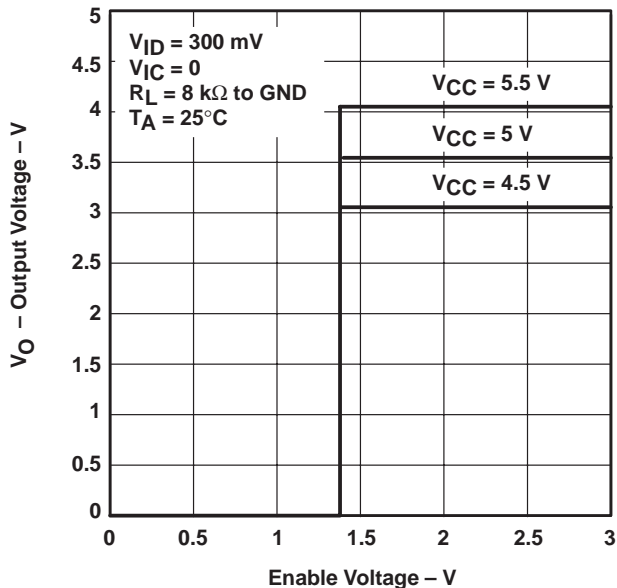

Figure 4

OUTPUT VOLTAGE
 vs
 ENABLE VOLTAGE

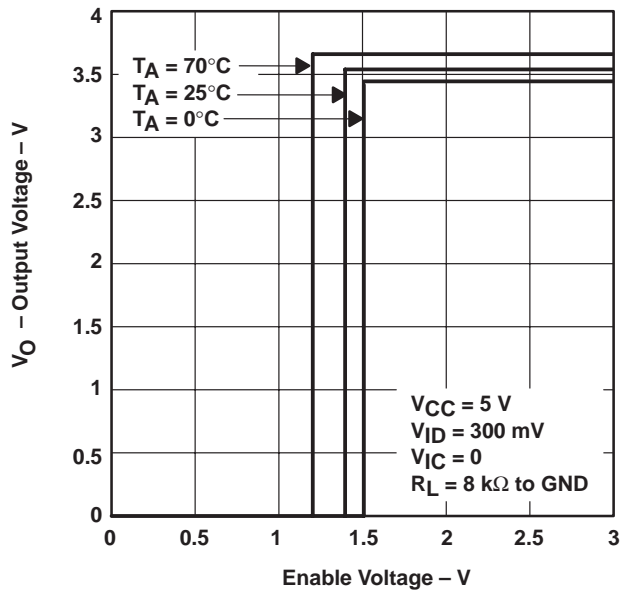

Figure 5

OUTPUT VOLTAGE
 vs
 ENABLE VOLTAGE

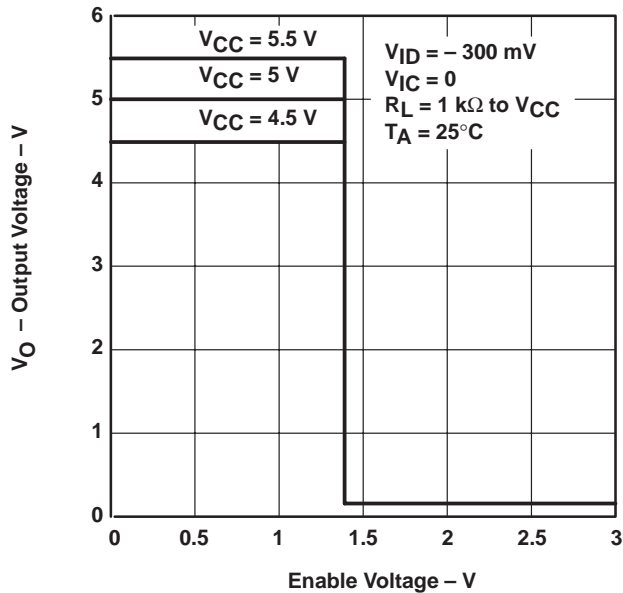

Figure 6

OUTPUT VOLTAGE
 vs
 ENABLE VOLTAGE

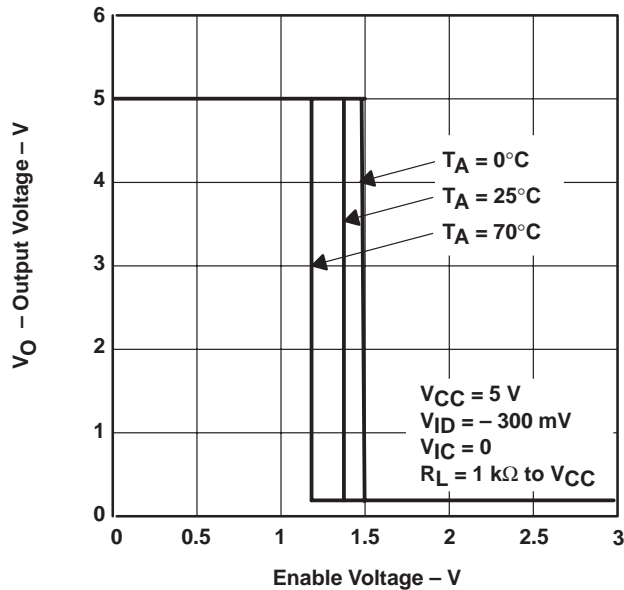
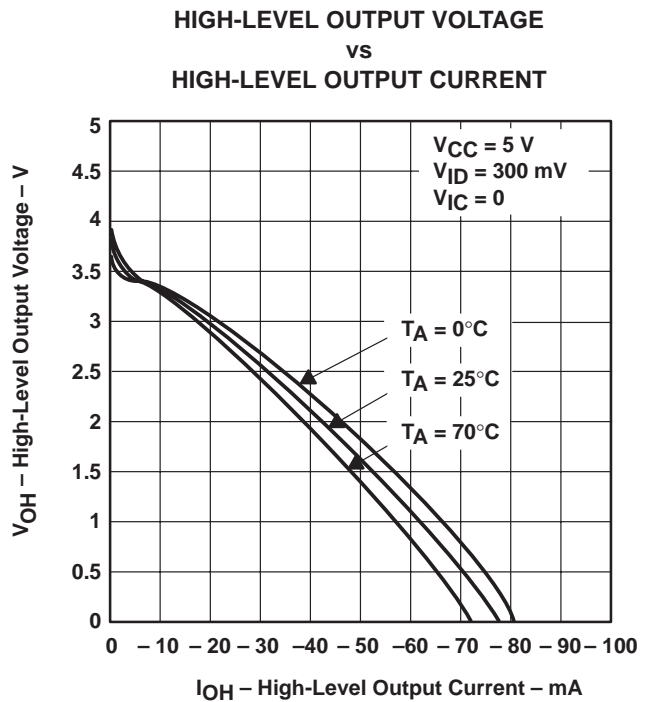
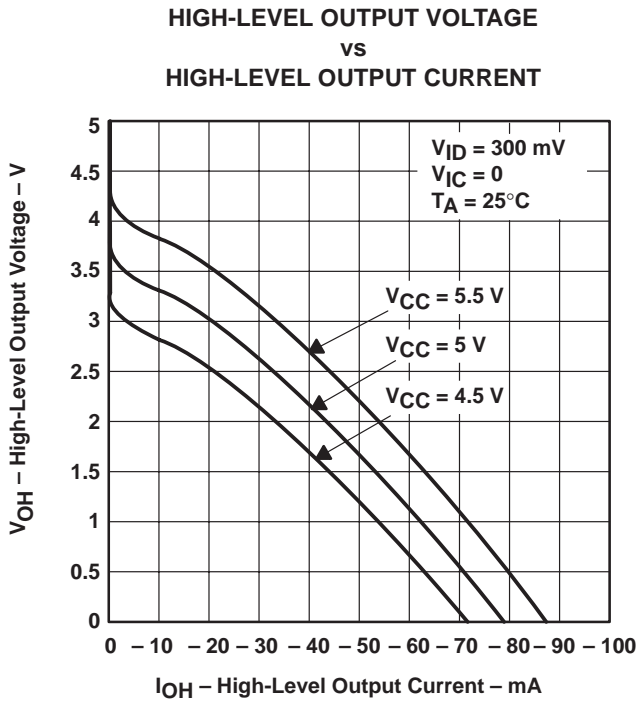
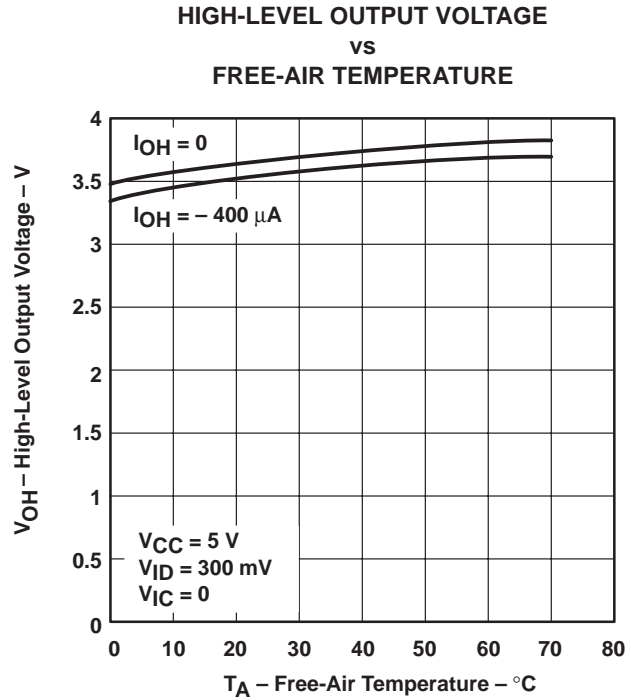
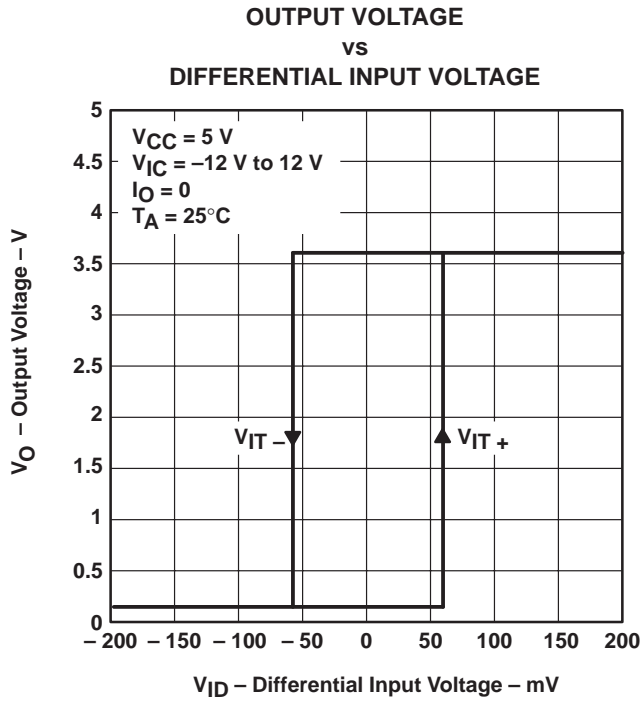

Figure 7

SN75ALS197 QUADRUPLE DIFFERENTIAL LINE RECEIVER

SLLS045B – JANUARY 1989 – REVISED MAY 1995

TYPICAL CHARACTERISTICS



TYPICAL CHARACTERISTICS

LOW-LEVEL OUTPUT VOLTAGE
 vs
 FREE-AIR TEMPERATURE

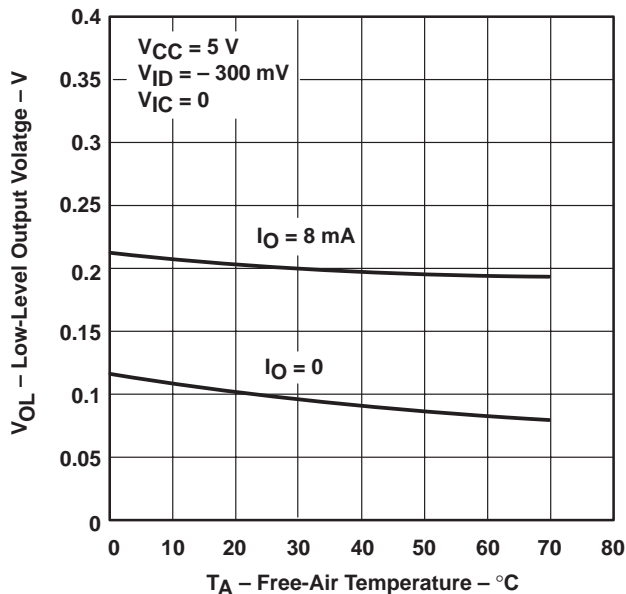

Figure 12

LOW-LEVEL OUTPUT VOLTAGE
 vs
 LOW-LEVEL OUTPUT CURRENT

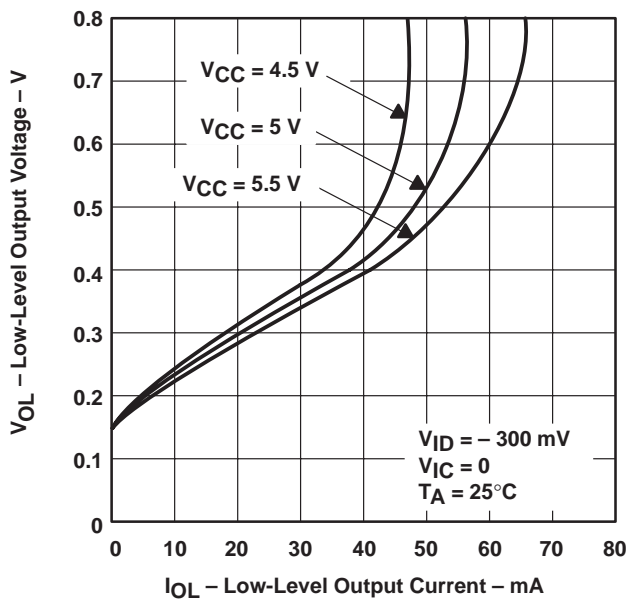

Figure 13

LOW-LEVEL OUTPUT VOLTAGE
 vs
 LOW-LEVEL OUTPUT CURRENT

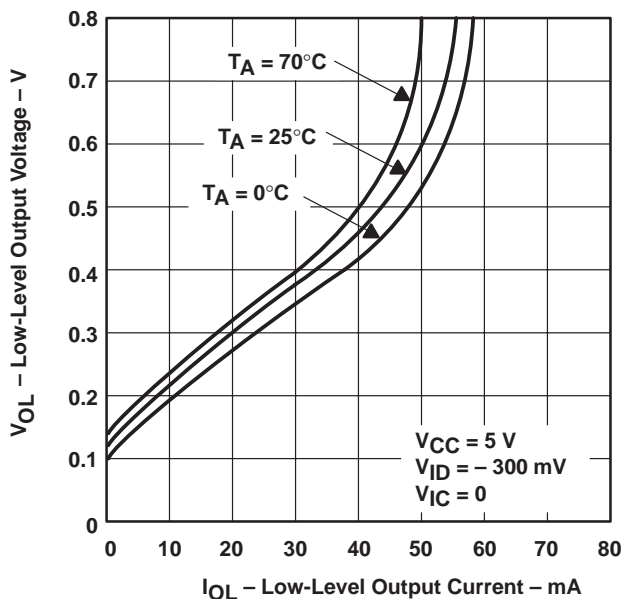

Figure 14

SN75ALS197 QUADRUPLE DIFFERENTIAL LINE RECEIVER

SLLS045B – JANUARY 1989 – REVISED MAY 1995

TYPICAL CHARACTERISTICS

**SUPPLY CURRENT
vs
SUPPLY VOLTAGE**

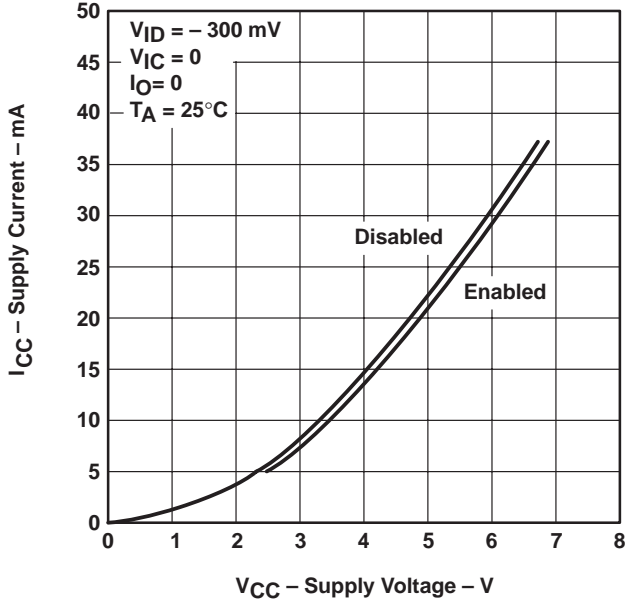

Figure 15

**SUPPLY CURRENT
vs
FREE-AIR TEMPERATURE**

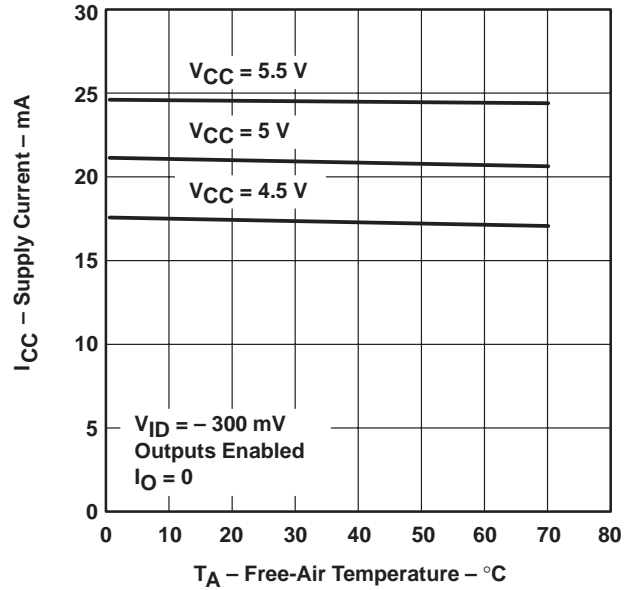

Figure 16

**SUPPLY CURRENT
vs
DIFFERENTIAL INPUT VOLTAGE**

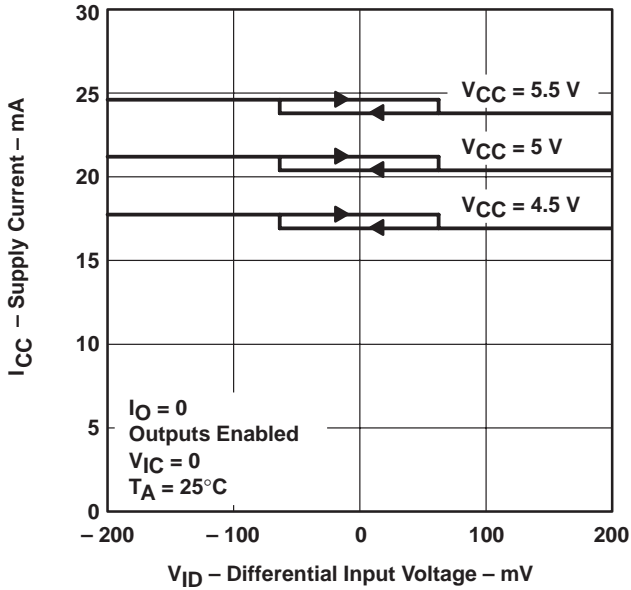

Figure 17

**SUPPLY CURRENT
vs
FREQUENCY**

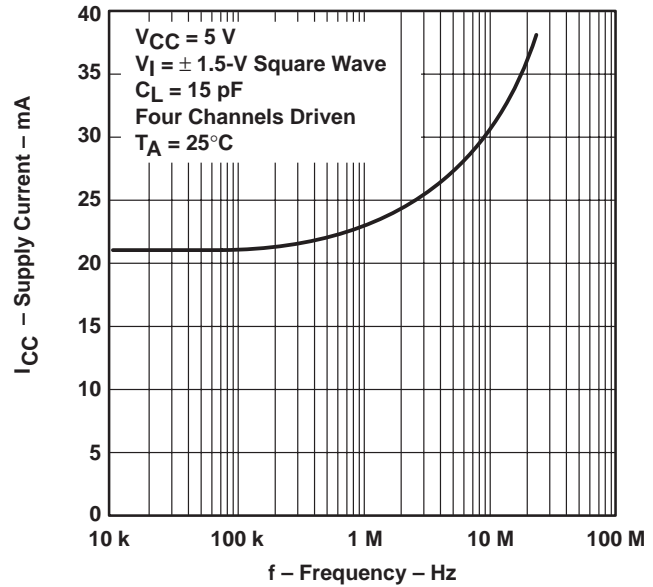

Figure 18



TYPICAL CHARACTERISTICS

INPUT RESISTANCE
 vs
 FREE-AIR TEMPERATURE

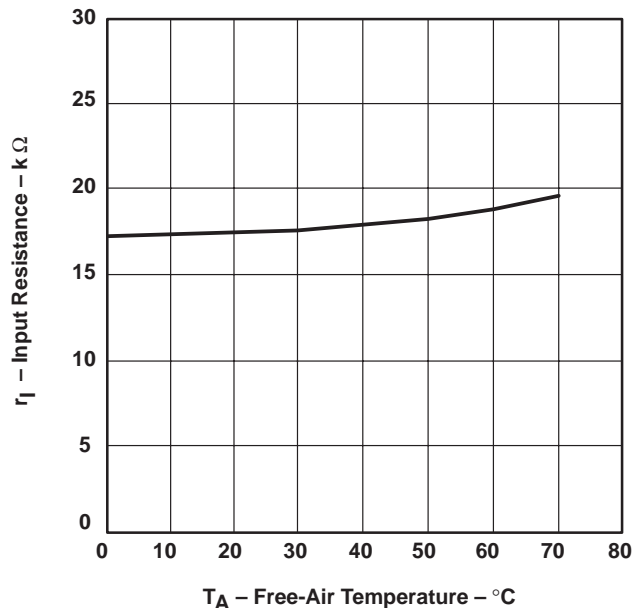

Figure 19

INPUT CURRENT
 vs
 INPUT VOLTAGE TO GND

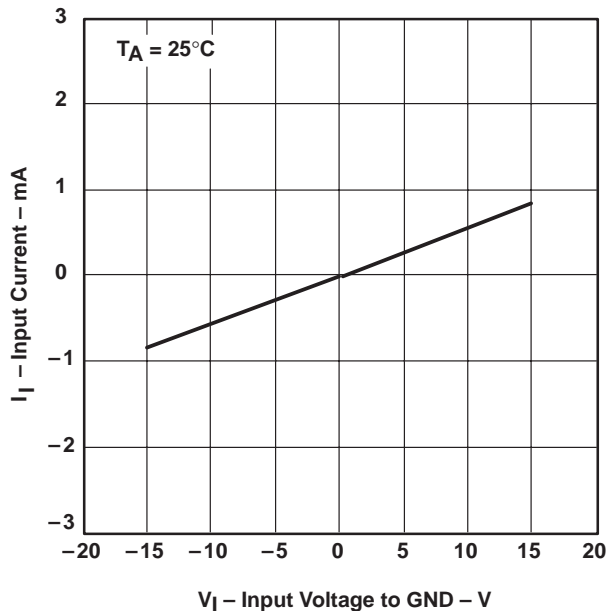

Figure 20

SWITCHING TIME
 vs
 FREE-AIR TEMPERATURE

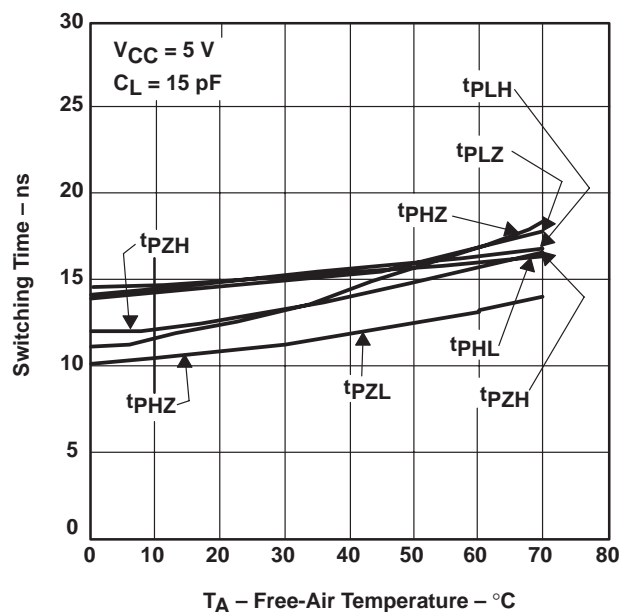

Figure 21

PROPAGATION DELAY TIME
 vs
 SUPPLY VOLTAGE

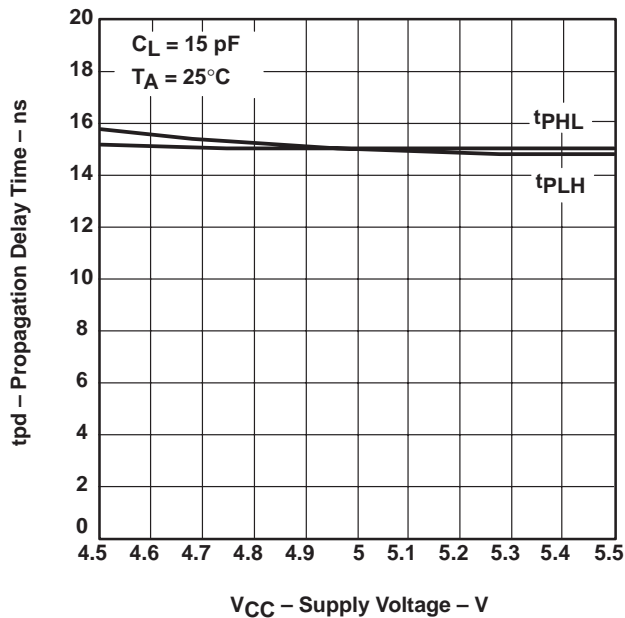

Figure 22

PACKAGING INFORMATION

Orderable Device	Status (1)	Package Type	Package Drawing	Pins	Package Qty	Eco Plan (2)	Lead/Ball Finish (6)	MSL Peak Temp (3)	Op Temp (°C)	Device Marking (4/5)	Samples
SN75ALS197D	ACTIVE	SOIC	D	16	40	Green (RoHS & no Sb/Br)	NIPDAU	Level-1-260C-UNLIM	0 to 70	75ALS197	Samples
SN75ALS197DE4	ACTIVE	SOIC	D	16	40	Green (RoHS & no Sb/Br)	NIPDAU	Level-1-260C-UNLIM	0 to 70	75ALS197	Samples
SN75ALS197DR	ACTIVE	SOIC	D	16	2500	Green (RoHS & no Sb/Br)	NIPDAU	Level-1-260C-UNLIM	0 to 70	75ALS197	Samples
SN75ALS197N	ACTIVE	PDIP	N	16	25	Green (RoHS & no Sb/Br)	NIPDAU	N / A for Pkg Type	0 to 70	SN75ALS197N	Samples
SN75ALS197NSR	ACTIVE	SO	NS	16	2000	Green (RoHS & no Sb/Br)	NIPDAU	Level-1-260C-UNLIM	0 to 70	75ALS197	Samples

(1) The marketing status values are defined as follows:

ACTIVE: Product device recommended for new designs.

LIFEBUY: TI has announced that the device will be discontinued, and a lifetime-buy period is in effect.

NRND: Not recommended for new designs. Device is in production to support existing customers, but TI does not recommend using this part in a new design.

PREVIEW: Device has been announced but is not in production. Samples may or may not be available.

OBSELETE: TI has discontinued the production of the device.

(2) **RoHS:** TI defines "RoHS" to mean semiconductor products that are compliant with the current EU RoHS requirements for all 10 RoHS substances, including the requirement that RoHS substance do not exceed 0.1% by weight in homogeneous materials. Where designed to be soldered at high temperatures, "RoHS" products are suitable for use in specified lead-free processes. TI may reference these types of products as "Pb-Free".

RoHS Exempt: TI defines "RoHS Exempt" to mean products that contain lead but are compliant with EU RoHS pursuant to a specific EU RoHS exemption.

Green: TI defines "Green" to mean the content of Chlorine (Cl) and Bromine (Br) based flame retardants meet JS709B low halogen requirements of <=1000ppm threshold. Antimony trioxide based flame retardants must also meet the <=1000ppm threshold requirement.

(3) MSL, Peak Temp. - The Moisture Sensitivity Level rating according to the JEDEC industry standard classifications, and peak solder temperature.

(4) There may be additional marking, which relates to the logo, the lot trace code information, or the environmental category on the device.

(5) Multiple Device Markings will be inside parentheses. Only one Device Marking contained in parentheses and separated by a "-" will appear on a device. If a line is indented then it is a continuation of the previous line and the two combined represent the entire Device Marking for that device.

(6) Lead/Ball Finish - Orderable Devices may have multiple material finish options. Finish options are separated by a vertical ruled line. Lead/Ball Finish values may wrap to two lines if the finish value exceeds the maximum column width.

Important Information and Disclaimer: The information provided on this page represents TI's knowledge and belief as of the date that it is provided. TI bases its knowledge and belief on information provided by third parties, and makes no representation or warranty as to the accuracy of such information. Efforts are underway to better integrate information from third parties. TI has taken and continues to take reasonable steps to provide representative and accurate information but may not have conducted destructive testing or chemical analysis on incoming materials and chemicals. TI and TI suppliers consider certain information to be proprietary, and thus CAS numbers and other limited information may not be available for release.

In no event shall TI's liability arising out of such information exceed the total purchase price of the TI part(s) at issue in this document sold by TI to Customer on an annual basis.

TAPE AND REEL INFORMATION
REEL DIMENSIONS

TAPE DIMENSIONS

A0	Dimension designed to accommodate the component width
B0	Dimension designed to accommodate the component length
K0	Dimension designed to accommodate the component thickness
W	Overall width of the carrier tape
P1	Pitch between successive cavity centers

TAPE AND REEL INFORMATION

*All dimensions are nominal

Device	Package Type	Package Drawing	Pins	SPQ	Reel Diameter (mm)	Reel Width W1 (mm)	A0 (mm)	B0 (mm)	K0 (mm)	P1 (mm)	W (mm)	Pin1 Quadrant
SN75ALS197DR	SOIC	D	16	2500	330.0	16.4	6.5	10.3	2.1	8.0	16.0	Q1
SN75ALS197NSR	SO	NS	16	2000	330.0	16.4	8.2	10.5	2.5	12.0	16.0	Q1

TAPE AND REEL BOX DIMENSIONS

*All dimensions are nominal

Device	Package Type	Package Drawing	Pins	SPQ	Length (mm)	Width (mm)	Height (mm)
SN75ALS197DR	SOIC	D	16	2500	333.2	345.9	28.6
SN75ALS197NSR	SO	NS	16	2000	367.0	367.0	38.0

D (R-PDSO-G16)

PLASTIC SMALL OUTLINE



4040047-6/M 06/11

- NOTES:
- A. All linear dimensions are in inches (millimeters).
 - B. This drawing is subject to change without notice.
 -  Body length does not include mold flash, protrusions, or gate burrs. Mold flash, protrusions, or gate burrs shall not exceed 0.006 (0,15) each side.
 -  Body width does not include interlead flash. Interlead flash shall not exceed 0.017 (0,43) each side.
 - E. Reference JEDEC MS-012 variation AC.

D (R-PDSO-G16)

PLASTIC SMALL OUTLINE



- NOTES:
- All linear dimensions are in millimeters.
 - This drawing is subject to change without notice.
 - Publication IPC-7351 is recommended for alternate designs.
 - Laser cutting apertures with trapezoidal walls and also rounding corners will offer better paste release. Customers should contact their board assembly site for stencil design recommendations. Refer to IPC-7525 for other stencil recommendations.
 - Customers should contact their board fabrication site for solder mask tolerances between and around signal pads.

MECHANICAL DATA

NS (R-PDSO-G**)

PLASTIC SMALL-OUTLINE PACKAGE

14-PINS SHOWN



- NOTES:
- A. All linear dimensions are in millimeters.
 - B. This drawing is subject to change without notice.
 - C. Body dimensions do not include mold flash or protrusion, not to exceed 0,15.

N (R-PDIP-T**)

PLASTIC DUAL-IN-LINE PACKAGE

16 PINS SHOWN



- NOTES:
- A. All linear dimensions are in inches (millimeters).
 - B. This drawing is subject to change without notice.
 - C Falls within JEDEC MS-001, except 18 and 20 pin minimum body length (Dim A).
 - D The 20 pin end lead shoulder width is a vendor option, either half or full width.

4040049/E 12/2002

IMPORTANT NOTICE AND DISCLAIMER

TI PROVIDES TECHNICAL AND RELIABILITY DATA (INCLUDING DATASHEETS), DESIGN RESOURCES (INCLUDING REFERENCE DESIGNS), APPLICATION OR OTHER DESIGN ADVICE, WEB TOOLS, SAFETY INFORMATION, AND OTHER RESOURCES "AS IS" AND WITH ALL FAULTS, AND DISCLAIMS ALL WARRANTIES, EXPRESS AND IMPLIED, INCLUDING WITHOUT LIMITATION ANY IMPLIED WARRANTIES OF MERCHANTABILITY, FITNESS FOR A PARTICULAR PURPOSE OR NON-INFRINGEMENT OF THIRD PARTY INTELLECTUAL PROPERTY RIGHTS.

These resources are intended for skilled developers designing with TI products. You are solely responsible for (1) selecting the appropriate TI products for your application, (2) designing, validating and testing your application, and (3) ensuring your application meets applicable standards, and any other safety, security, or other requirements. These resources are subject to change without notice. TI grants you permission to use these resources only for development of an application that uses the TI products described in the resource. Other reproduction and display of these resources is prohibited. No license is granted to any other TI intellectual property right or to any third party intellectual property right. TI disclaims responsibility for, and you will fully indemnify TI and its representatives against, any claims, damages, costs, losses, and liabilities arising out of your use of these resources.

TI's products are provided subject to TI's Terms of Sale (www.ti.com/legal/termsofsale.html) or other applicable terms available either on ti.com or provided in conjunction with such TI products. TI's provision of these resources does not expand or otherwise alter TI's applicable warranties or warranty disclaimers for TI products.

Mailing Address: Texas Instruments, Post Office Box 655303, Dallas, Texas 75265
Copyright © 2020, Texas Instruments Incorporated