

TAS5805M 23-W, Inductor-Less, Digital Input, Stereo, Closed-Loop Class-D Audio Amplifier with Enhanced Processing and Low Power Dissipation

1 Features

- Supports Multiple Output Configurations
 - 2 × 23 W in 2.0 Mode (8-Ω, 21 V, THD+N=1%)
 - 45 W in Mono Mode (4-Ω, 21 V, THD+N=1%)
- Excellent Audio Performance
 - THD+N ≤ 0.03% at 1 W, 1 kHz, PVDD = 12 V
 - SNR ≥ 107 dB (A-weighted), Noise Level < 40 μV_{RMS}
- Low Quiescent Current with Hybrid Modulation
 - 16.5 mA at PVDD = 13.5 V, 22 μH + 0.68 μF Filter
- Flexible Power Supply Configurations
 - PVDD: 4.5 V to 26.4 V
 - DVDD and I/O: 1.8 V or 3.3 V
- Flexible Audio I/O
 - I²S, LJ, RJ, TDM, 3-Wire Digital Audio Interface (No MCLK Required)
 - Supports 32, 44.1, 48, 88.2, 96 kHz Sample Rates
 - SDOUT for Audio Monitoring, Sub-Channel or Echo Cancellation
- Enhanced Audio Processing
 - Multi-Band Advanced DRC and AGL
 - 2×15 BQs
 - Thermal Foldback, DC Blocking
 - Input Mixer, Output Crossbar
 - Level Meter
 - 5 BQs + 1 Band DRC +THD Manager for the Subwoofer Channel
 - Sound Field Spatializer option
- Integrated Self-Protection
 - Adjacent Pin to Pin Short Without Damage
 - Over-Current Error (OCE)
 - Over-Temperature Warning (OTW)
 - Over-Temperature Error (OTE)
 - Under/Over-Voltage Lock-out (UVLO/OVLO)
- Easy System Integration
 - I²C Software Control
 - Reduced Solution Size
 - Fewer Passives Required Compared to Open-Loop Devices
 - Inductor-less Operation (Ferrite Bead) for most cases where PVDD ≤ 14V

- Soundbar, Wired Speaker, Bookshelf Stereo System
- Desktop PC, Notebook PC
- AV Receiver, Smart Home and IoT Appliance

3 Description

The TAS5805M is a high-efficiency, stereo, closed-loop Class-D amplifier offering a cost-effective digital-input solution with low power dissipation and sound enrichment. The device's integrated audio processor and 96 kHz architecture support advanced audio process flow, including SRC, 15 BQs per channel, volume control, audio mixing, 3-band 4th order DRC, full-band AGL, THD manager and level meter.

Featuring TI's proprietary Hybrid Modulation scheme, the TAS5805M consumes very-low quiescent current (16.5 mA at 13.5 V PVDD), extending battery life in portable audio applications. With advanced EMI suppression technology, designers can leverage inexpensive ferrite bead filters to reduce board space and system cost.

Device Information

PART NUMBER	PACKAGE ⁽¹⁾	BODY SIZE (NOM)
TAS5805M	TSSOP (28) PWP	9.7 mm × 4.4 mm

- (1) For all available packages, see the orderable addendum at the end of the data sheet.

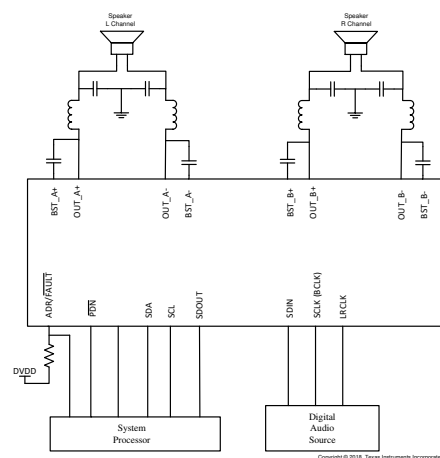

Simplified Block Diagram

2 Applications

- LCD TV, OLED TV
- Wireless Speaker, Smart Speaker with Voice Assistant



Table of Contents

1 Features	1	7.4 Device Functional Modes.....	36
2 Applications	1	7.5 Programming and Control.....	41
3 Description	1	7.6 Register Maps.....	47
4 Revision History	2	8 Application and Implementation	77
5 Pin Configuration and Functions	5	8.1 Application Information.....	77
6 Specifications	7	8.2 Typical Applications.....	79
6.1 Absolute Maximum Ratings.....	7	9 Layout	89
6.2 ESD Ratings.....	7	9.1 Layout Guidelines.....	89
6.3 Recommended Operating Conditions.....	7	9.2 Layout Example.....	91
6.4 Thermal Information.....	7	10 Device and Documentation Support	92
6.5 Electrical Characteristics.....	8	10.1 Device Support.....	92
6.6 Timing Requirements.....	11	10.2 Receiving Notification of Documentation Updates.....	93
6.7 Typical Characteristics.....	12	10.3 Support Resources.....	93
7 Detailed Description	29	10.4 Trademarks.....	93
7.1 Overview.....	29	10.5 Electrostatic Discharge Caution.....	93
7.2 Functional Block Diagram.....	29	10.6 Glossary.....	93
7.3 Feature Description.....	29		

4 Revision History

NOTE: Page numbers for previous revisions may differ from page numbers in the current version.

Changes from Revision C (December 2018) to Revision D (November 2020)	Page
• Added note 1 to the <i>Recommended Operating Conditions</i>	7
• Added capacitive load for each bus line, $C_b = 400$ pf to the I2C timing parameters in the <i>Timing Requirements</i>	11
• Change the I2C BUS Timing-Standard. Data Hold Time max value from 900 ns to 3450 ns in the <i>Timing Requirements</i>	11
• Added efficiency plot and 1%/10% THD+N output power vs PVDD plot for 4- Ω load.....	12
• Added notes the <i>Hybrid Modulation</i> section.....	40
• Added <i>Speaker DC Protection</i> , <i>Device Over Temperature Protection</i> , <i>Device Over Voltage/Under Voltage Protection</i> , and <i>Clock Fault</i> sections.....	46

Changes from Revision B (October 2018) to Revision C (December 2018)	Page
• Added Figure 7-14	45
• Added Figure 7-15	45

Changes from Revision A (July 2018) to Revision B (October 2018)	Page
• Changed From: (<16.5 mA at 13.5 V PVDD) To:(16.5 mA at 13.5 V PVDD) in the <i>Description</i>	1
• Changed the <i>Typical Characteristics</i> graphs.....	12
• Added the <i>Clock Halt Auto-recover</i> section.....	31
• Added the <i>Sample Rate on the Fly Change</i> section.....	31
• Added the <i>Thermal Foldback</i> section.....	37
• Changed the <i>Device State Control</i> section.....	37
• Changed the <i>DSP Memory Book, Page and BQ Coefficients Update</i> section.....	43
• Added the <i>Example Use</i> section.....	43
• Deleted 010:310K in Table 7-9	47
• Added the <i>Inductor Selections</i> section.....	77
• Added the <i>Step 2: Speaker Tuning</i> section.....	82
• Changed the <i>Development Support</i> section.....	92

Changes from Revision * (May 2018) to Revision A (July 2018)

Page

• Released as Production Data.....	1
------------------------------------	----------

Device Comparison Table

ORDERABLE PART NUMBER	RECOMMENDED PVDD RANGE	Audio Process Flows	R _{DS(ON)}
TAS5805M	4.5 V to 26.4 V	Enhanced Audio Process Flows with ROM Fixed	180 mΩ
TAS5707/TAS5711	8 V to 26 V	Basic Audio Process Flow with ROM Fixed	180 mΩ
TAS5825M	4.5 V to 26.4 V	Flexible Advanced Audio Process Flows with Smart-Amp Features	90 mΩ

5 Pin Configuration and Functions

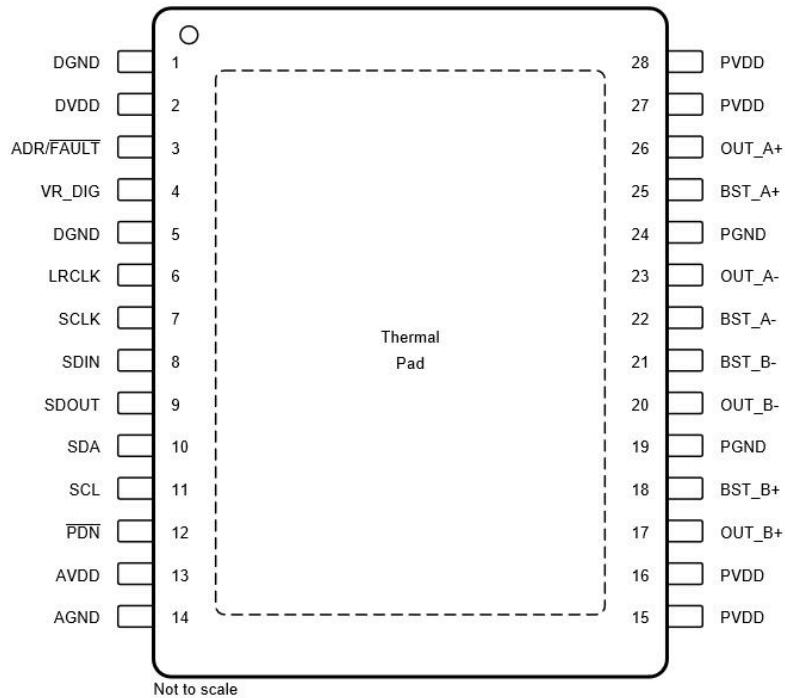

Figure 5-1. PWP Package, 28-Pin TSSOP,

Table 5-1. Pin Functions

PIN		TYPE ⁽¹⁾	DESCRIPTION
NAME	NO.		
DGND	1, 5	P	Digital ground
DVDD	2	P	3.3-V or 1.8-V digital power supply
VR_DIG	4	P	Internally regulated 1.5-V digital supply voltage. This pin must not be used to drive external devices
ADR/ FAULT	3	DI/O	Different I ² C device address can be set by selecting different pull up resistor to DVDD, see Table 7-5 for details. After power up, ADR/ FAULT can be redefine as FAULT, go to Page0, Book0, set register 0x61 = 0x0b first, then set register 0x60 = 0x01
LRCLK	6	DI	Word select clock for the digital signal that is active on the serial port's input data line. In I ² S, LJ and RJ, this corresponds to the left channel and right channel boundary. In TDM mode, this corresponds to the frame sync boundary
SCLK	7	DI	Bit clock for the digital signal that is active on the input data line of the serial data port.
SDIN	8	DI	Data line to the serial data port
SDOUT	9	DO	Serial Audio data output. The source data can be Pre-DSP or Post-DSP data, by setting the register 0x30h.
SDA	10	DI/O	I ² C serial control data interface input/output
SCL	11	DI	I ² C serial control clock input
PDN	12	DI	Power Down, active-low. PDN place the amplifier in Shutdown, turn off all internal regulators. Low, Power Down Device; High, Enable Device.
AVDD	13	P	Internally regulated 5-V analog supply voltage. This pin must not be used to drive external devices
AGND	14	P	Analog ground
PVDD	15,16,27, 28	P	PVDD voltage input
PGND	19,24	P	Ground reference for power device circuitry. Connect this pin to system ground.
OUT_A+	26	O	Positive pin for differential speaker amplifier output A+
BST_A+	25	P	Connection point for the OUT_A+ bootstrap capacitor which is used to create a power supply for the high-side gate drive for OUT_A+
OUT_A-	23	O	Negative pin for differential speaker amplifier output A-

Table 5-1. Pin Functions (continued)

PIN		TYPE ⁽¹⁾	DESCRIPTION
NAME	NO.		
BST_A-	22	P	Connection point for the OUT_A- bootstrap capacitor which is used to create a power supply for the high-side gate drive for OUT_A-
BST_B-	21	P	Connection point for the OUT_B- bootstrap capacitor which is used to create a power supply for the high-side gate drive for OUT_B-
OUT_B-	20	O	Negative pin for differential speaker amplifier output B
BST_B+	18	P	Connection point for the OUT_B+ bootstrap capacitor which is used to create a power supply for the high-side gate drive for OUT_B+
OUT_B+	17	O	Positive pin for differential speaker amplifier output B+
PowerPAD™		P	Connect to the system Ground

- (1) AI = Analog input, AO = Analog output, DI = Digital Input, DO = Digital Output, DI/O = Digital Bi-directional (input and output), P = Power, G = Ground (0 V)

6 Specifications

6.1 Absolute Maximum Ratings

Free-air room temperature 25°C (unless otherwise noted) ⁽¹⁾

		MIN	MAX	UNIT
DVDD	Low-voltage digital supply	-0.3	3.9	V
PVDD	PVDD supply	-0.3	30	V
V _{I(DigIn)}	DVDD referenced digital inputs ⁽²⁾	-0.5	V _{DVDD} + 0.5	V
V _{I(SPK_OUTxx)}	Voltage at speaker output pins	-0.3	32	V
T _A	Ambient operating temperature	-25	85	°C
T _{stg}	Storage temperature	-40	125	°C

- (1) Stresses beyond those listed under *Absolute Maximum Ratings* may cause permanent damage to the device. These are stress ratings only, which do not imply functional operation of the device at these or any other conditions beyond those indicated under *Recommended Operating Conditions*. Exposure to absolute-maximum-rated conditions for extended periods may affect device reliability.
- (2) DVDD referenced digital pins include: ADR/ $\overline{\text{FAULT}}$, LRCLK, SCLK, SCL, SDA, SDIN, $\overline{\text{PDN}}$

6.2 ESD Ratings

		VALUE	UNIT
V _(ESD)	Electrostatic discharge	Human-body model (HBM), per ANSI/ESDA/JEDEC JS-001 ⁽¹⁾	±2000
		Charged-device model (CDM), per JEDEC specification JESD22-C101 ⁽²⁾	±500

- (1) JEDEC document JEP155 states that 500-V HBM allows safe manufacturing with a standard ESD control process.
- (2) JEDEC document JEP157 states that 250-V CDM allows safe manufacturing with a standard ESD control process.

6.3 Recommended Operating Conditions

over operating free-air temperature range (unless otherwise noted) see ⁽¹⁾

			MIN	NOM	MAX	UNIT
V _(POWER)	Power supply inputs	DVDD	1.62		3.63	V
		PVDD	4.5		26.4	
R _{SPK}	Minimum speaker load	BTL Mode (4.5V ≤ PVDD ≤ 26.4V)	V _{OUT PEAK} / OCE _{THRES}		6	Ω
R _{SPK}	Minimum speaker load	PBTL Mode (4.5V ≤ PVDD ≤ 26.4V)	V _{OUT PEAK} / (2 × OCE _{THRES})		4	Ω
L _{OUT}	Minimum inductor value in LC filter under short-circuit condition		1	4.7		μH

- (1) The minimal speaker load been limited by OCE Threshold, if output peak current <5A, TAS5805M also supports lower speaker load with High PVDD. For BTL, the OCE Threshold is 5A (Typical); For PBTL, the OCE Threshold is 10A (Typical). The minimal speaker load depends on the output peak voltage.

6.4 Thermal Information

THERMAL METRIC ⁽¹⁾	TAS5805M TSSOP (PWP) 28 PINS			UNIT	
	JEDEC STANDARD 2-LAYER PCB	JEDEC STANDARD 4-LAYER PCB	TAS5805MEVM-4 4-LAYER PCB		
R _{θJA}	Junction-to-ambient thermal resistance	N/A	29.1	24	°C/W
R _{θJC(top)}	Junction-to-case (top) thermal resistance	N/A	21.8	N/A	°C/W
R _{θJB}	Junction-to-board thermal resistance	N/A	8.2	N/A	°C/W
ψ _{JT}	Junction-to-top characterization parameter	N/A	0.3	1.5	°C/W
ψ _{JB}	Junction-to-board characterization parameter	N/A	8.1	7.6	°C/W
R _{θJC(bot)}	Junction-to-case (bottom) thermal resistance	N/A	2.2	N/A	°C/W

- (1) For more information about traditional and new thermal metrics, see the [Semiconductor and IC Package Thermal Metrics](#) application report.

6.5 Electrical Characteristics

Free-air room temperature 25°C (unless otherwise noted)

PARAMETER		TEST CONDITIONS	MIN	TYP	MAX	UNIT
DIGITAL I/O						
IIH	Input logic high current level for DVDD referenced digital input pins	$V_{IN(Digin)} = V_{DVDD}$			10	μA
IIL	Input logic low current level for DVDD referenced digital input pins	$V_{IN(Digin)} = 0\text{ V}$			-10	μA
$V_{IH(Digin)}$	Input logic high threshold for DVDD referenced digital inputs		70%			V_{DVDD}
$V_{IL(Digin)}$	Input logic low threshold for DVDD referenced digital inputs				30%	V_{DVDD}
$V_{OH(Digin)}$	Output logic high voltage level	$I_{OH} = 2\text{ mA}$	80%			V_{DVDD}
$V_{OL(Digin)}$	Output logic low voltage level	$I_{OH} = -2\text{ mA}$			20%	V_{DVDD}
I²C CONTROL PORT						
$C_{L(I2C)}$	Allowable load capacitance for each I ² C line				400	pF
$f_{SCL(fast)}$	Support SCL frequency	No wait states, fast mode			400	kHz
$f_{SCL(slow)}$	Support SCL frequency	No wait states, slow mode			100	kHz
SERIAL AUDIO PORT						
t_{DLY}	Required LRCLK/FS to SCLK rising edge delay		5			ns
D_{SCLK}	Allowable SCLK duty cycle		40%		60%	
f_s	Supported input sample rates		32		96	kHz
f_{SCLK}	Supported SCLK frequencies		32		64	f_s
f_{SCLK}	SCLK frequency				24.576	MHz
SPEAKER AMPLIFIER (ALL OUTPUT CONFIGURATIONS)						
I_{cc}	Quiescent supply current on DVDD	$\overline{PDN}=2V, DVDD=3.3V, \text{ Play mode}$		18		mA
I_{cc}	Quiescent supply current on DVDD	$\overline{PDN}=2V, DVDD=3.3V, \text{ Sleep mode}$		0.75		mA
I_{cc}	Quiescent supply current on DVDD	$\overline{PDN}=2V, DVDD=3.3V, \text{ Deep Sleep mode}$		0.75		mA
I_{cc}	Quiescent supply current on DVDD	$\overline{PDN}=0V, DVDD=3.3V, \text{ Shutdown mode}$		5.5		μA
I_{cc}	Quiescent supply current on PVDD	$\overline{PDN}=2V, PVDD=13.5V, \text{ LC filter}=10\mu\text{H}+0.68\mu\text{F}, \text{ Fsw}=768\text{kHz}, \text{ BD Modulation, Play mode}$		32.5		mA
I_{cc}	Quiescent supply current on PVDD	$\overline{PDN}=2V, PVDD=13.5V, \text{ LC filter}=22\mu\text{H}+0.68\mu\text{F}, \text{ Fsw}=384\text{kHz}, \text{ Hybrid Modulation, Play mode}$		16.5		mA
I_{cc}	Quiescent supply current on PVDD	$\overline{PDN}=2V, PVDD=13.5V, \text{ Output Hiz Mode}$		10.4		mA
I_{cc}	Quiescent supply current on PVDD	$\overline{PDN}=2V, PVDD=13.5V, \text{ Sleep Mode}$		7.2		mA
I_{cc}	Quiescent supply current on PVDD	$\overline{PDN}=2V, PVDD=13.5V, \text{ Deep Sleep Mode}$		120		μA
I_{cc}	Quiescent supply current on PVDD	$\overline{PDN}=0V, PVDD=13.5V, \text{ Shutdown Mode}$		7.2		μA
t_{off}	Turn-off Time	Excluding volume ramp			10	ms
$A_{V(SP_AMP)}$	Programmable Gain	Value represents the "peak voltage" disregarding clipping due to lower PVDD). Measured at 0 dB input(1FS)	4.87		29.5	V
$\Delta A_{V(SP_AMP)}$	Amplifier gain error	Gain = 29.5 Vp/FS		0.5		dB
f_{SP_AMP}	Switching frequency of the speaker amplifier			384		kHz
				768		kHz

6.5 Electrical Characteristics (continued)

Free-air room temperature 25°C (unless otherwise noted)

PARAMETER		TEST CONDITIONS	MIN	TYP	MAX	UNIT
$R_{DS(on)}$	Drain-to-source on resistance of the individual output MOSFETs	FET + Metallization		180		mΩ
OCE_{THRES}	Over-Current Error Threshold	OUTxx Overcurrent Error Threshold		5		A
$OVE_{THRES(PVDD)}$	PVDD over voltage error threshold			28		V
$UVE_{THRES(PVDD)}$	PVDD under voltage error threshold			4.2		V
OTE_{THRES}	Over temperature error threshold			160		°C
$OTE_{Hysteresis}$	Over temperature error hysteresis			10		°C
OTW_{THRES}	Over temperature warning level	Read by register 0x73 bit3		135		°C
SPEAKER AMPLIFIER (STEREO BTL)						
$ V_{OS} $	Amplifier offset voltage	Measured differentially with zero input data, programmable gain configured with 29.5 Vp gain, $V_{PVDD} = 12\text{ V}$, BD Mode	-6.5		6.5	mV
$P_{O(SPK)}$	Continuous Output power (per channel)	$V_{PVDD} = 21\text{ V}$, $SPK_GAIN = 24.8\text{ Vp/FS}$, $R_{SPK} = 8\ \Omega$, $f = 1\text{ kHz}$, THD+N = 1%, 1SPW Mode		23		W
		$V_{PVDD} = 21\text{ V}$, $SPK_GAIN = 24.8\text{ Vp/FS}$, $R_{SPK} = 8\ \Omega$, $f = 1\text{ kHz}$, THD+N = 10%, 1SPW Mode		27.5		W
		$V_{PVDD} = 18\text{ V}$, $SPK_GAIN = 20.8\text{ Vp/FS}$, $R_{SPK} = 6\ \Omega$, $f = 1\text{ kHz}$, THD+N = 1%, BD Mode		21		W
		$V_{PVDD} = 18\text{ V}$, $SPK_GAIN = 20.8\text{ Vp/FS}$, $R_{SPK} = 6\ \Omega$, $f = 1\text{ kHz}$, THD+N = 10%, BD Mode		25		W
		$V_{PVDD} = 12\text{ V}$, $SPK_GAIN = 13.9\text{ Vp/FS}$, $R_{SPK} = 6\ \Omega$, $f = 1\text{ kHz}$ THD+N = 1%, BD Mode		9.9		W
		$V_{PVDD} = 12\text{ V}$, $SPK_GAIN = 13.9\text{ Vp/FS}$, $R_{SPK} = 6\ \Omega$, $f = 1\text{ kHz}$ THD+N = 10%, BD Mode		12		W
		$V_{PVDD} = 13.5\text{ V}$, $SPK_GAIN = 15.6\text{ Vp/FS}$, $R_{SPK} = 6\ \Omega$, $f = 1\text{ kHz}$ THD+N = 1%, BD Mode		12		W
		$V_{PVDD} = 13.5\text{ V}$, $SPK_GAIN = 15.6\text{ Vp/FS}$, $R_{SPK} = 6\ \Omega$, $f = 1\text{ kHz}$ THD+N = 10%, BD Mode		15		W
$THD+N_{SPK}$	Total harmonic distortion and noise ($P_O = 1\text{ W}$, $f = 1\text{ KHz}$, $R_{SPK} = 6\ \Omega$)	$V_{PVDD} = 12\text{ V}$, $F_{sw} = 768\text{ kHz}$, $SPK_GAIN = 13.9\text{ Vp/FS}$, LC-filter, BD Mode		0.03%		
		$V_{PVDD} = 18\text{ V}$, $F_{sw} = 768\text{ kHz}$, $SPK_GAIN = 20.8\text{ Vp/FS}$, LC-filter, BD Mode		0.03%		
$I_{CN(SPK)}$	Idle channel noise(A-weighted)	$V_{PVDD} = 12\text{ V}$, $F_{sw} = 768\text{ kHz}$, LC-filter, Load=6 Ω		37		μVrms
		$V_{PVDD} = 18\text{ V}$, $F_{sw} = 768\text{ kHz}$, LC-filter, Load=6 Ω		38		
DR	Dynamic range	A-Weighted, -60 dBFS method. $P_{VDD} = 24\text{ V}$, $SPK_GAIN = 29.5\text{ Vp/FS}$		106		dB
SNR	Signal-to-noise ratio	A-Weighted, referenced to 1% THD+N output level, $PVDD=24\text{ V}$		111		dB
		A-Weighted, referenced to 1% THD+N output level, $PVDD=13.5\text{ V}$		107.5		dB
K_{SVR}	Power supply rejection ratio	Injected Noise = 1 KHz, 1 V_{rms} , $PVDD = 12\text{ V}$, input audio signal = digital zero		72		dB
$X\text{-talk}_{SPK}$	Cross-talk (worst case between left-to-right and right-to-left coupling)	$f = 1\text{ kHz}$		100		dB
SPEAKER AMPLIFIER (MONO PBTL)						

6.5 Electrical Characteristics (continued)

Free-air room temperature 25°C (unless otherwise noted)

PARAMETER		TEST CONDITIONS	MIN	TYP	MAX	UNIT
P _{O(SPK)}	Continuous Output Power	V _{PVDD} = 12 V, SPK_GAIN = 13.9 Vp/FS, R _{SPK} = 4 Ω, f = 1kHz, THD+N = 1%, BD Mode		15.4		W
		V _{PVDD} = 12 V, SPK_GAIN = 13.9 Vp/FS, R _{SPK} = 4 Ω, f = 1kHz, THD+N = 10%, BD Mode		18.5		W
		V _{PVDD} = 18 V, SPK_GAIN = 22.1 Vp/FS, R _{SPK} = 4 Ω, f = 1kHz, THD+N = 1%, BD Mode		33.6		W
		V _{PVDD} = 18 V, SPK_GAIN = 22.1 Vp/FS, R _{SPK} = 4 Ω, f = 1kHz, THD+N = 10%, BD Mode		41		W
THD+N _{SPK}	Total harmonic distortion and noise (P _O = 1 W, f = 1 kHz)	V _{PVDD} = 12 V, SPK_GAIN = 16.5 Vp/FS, 4.7uH + 0.68uF filter, R _{SPK} = 4 Ω, BD Mode		0.06%		
		V _{PVDD} = 24 V, SPK_GAIN = 29.5 Vp/FS, 4.7uH + 0.68uF filter, R _{SPK} = 4 Ω, 1SPW Mode		0.07%		
DR	Dynamic range	A-Weighted, -60 dBFS method, PVDD = 24V, SPK_GAIN = 29.5 Vp/FS		106		dB
SNR	Signal-to-noise ratio	A-Weighted, referenced to 1% THD+N output level, PVDD=13.5V		107.7		dB
		A-Weighted, referenced to 1% THD+N output level, PVDD=24V		111		dB
K _{SVR}	Power supply rejection ratio	Injected Noise = 1 KHz, 1 V _{rms} , P _{VDD} = 19 V, input audio signal = digital zero		72		dB

6.6 Timing Requirements

		MIN	NOM	MAX	UNIT
Serial Audio Port Timing					
f _{SCLK}	SCLK frequency	1.024			MHz
t _{SCLK}	SCLK period	40			ns
t _{SCLKL}	SCLK pulse width, low	16			ns
t _{SCLKH}	SCLK pulse width, high	16			ns
t _{SL}	SCLK rising to LRCK/FS edge	8			ns
t _{LS}	LRCK/FS Edge to SCLK rising edge	8			ns
t _{SU}	Data setup time, before SCLK rising edge	8			ns
t _{DH}	Data hold time, after SCLK rising edge	8			ns
t _{DFS}	Data delay time from SCLK falling edge			15	ns
I²C Bus Timing – Standard					
f _{SCL}	SCL clock frequency			100	kHz
t _{BUF}	Bus free time between a STOP and START condition	4.7			µs
t _{LOW}	Low period of the SCL clock	4.7			µs
t _{HI}	High period of the SCL clock	4			µs
t _{RS-SU}	Setup time for (repeated) START condition	4.7			µs
t _{S-HD}	Hold time for (repeated) START condition	4			µs
t _{D-SU}	Data setup time	250			ns
t _{D-HD}	Data hold time	0		3450	ns
t _{SCL-R}	Rise time of SCL signal	20 + 0.1C _B		1000	ns
t _{SCL-R1}	Rise time of SCL signal after a repeated START condition and after an acknowledge bit	20 + 0.1C _B		1000	ns
t _{SCL-F}	Fall time of SCL signal	20 + 0.1C _B		1000	ns
t _{SDA-R}	Rise time of SDA signal	20 + 0.1C _B		1000	ns
t _{SDA-F}	Fall time of SDA signal	20 + 0.1C _B		1000	ns
t _{P-SU}	Setup time for STOP condition	4			µs
C _B	Capacitive load for each bus line			400	pf
I²C Bus Timing – Fast					
f _{SCL}	SCL clock frequency			400	kHz
t _{BUF}	Bus free time between a STOP and START condition	1.3			µs
t _{LOW}	Low period of the SCL clock	1.3			µs
t _{HI}	High period of the SCL clock	600			ns
t _{RS-SU}	Setup time for (repeated)START condition	600			ns
t _{RS-HD}	Hold time for (repeated)START condition	600			ns
t _{D-SU}	Data setup time	100			ns
t _{D-HD}	Data hold time	0		900	ns
t _{SCL-R}	Rise time of SCL signal	20 + 0.1C _B		300	ns
t _{SCL-R1}	Rise time of SCL signal after a repeated START condition and after an acknowledge bit	20 + 0.1C _B		300	ns
t _{SCL-F}	Fall time of SCL signal	20 + 0.1C _B		300	ns
t _{SDA-R}	Rise time of SDA signal	20 + 0.1C _B		300	ns
t _{SDA-F}	Fall time of SDA signal	20 + 0.1C _B		300	ns
t _{P-SU}	Setup time for STOP condition	600			ns
t _{SP}	Pulse width of spike suppressed			50	ns
C _B	Capacitive load for each bus line			400	pf

6.7 Typical Characteristics

6.7.1 Bridge Tied Load (BTL) Configuration Curves with 1SPW Mode

Free-air room temperature 25°C (unless otherwise noted.) Measurements were made using TAS5805MEVM board and Audio Precision System 2722 with Analog Analyzer filter set to 20-kHz brickwall filter. All measurements taken with audio frequency set to 1 kHz and device PWM Modulation mode set to 1SPW mode with Class D Bandwidth = 120 kHz for 576 kHz Fsw and Class D Bandwidth = 175 kHz for 768 kHz Fsw (Listed in Register 0x53) unless otherwise noted.

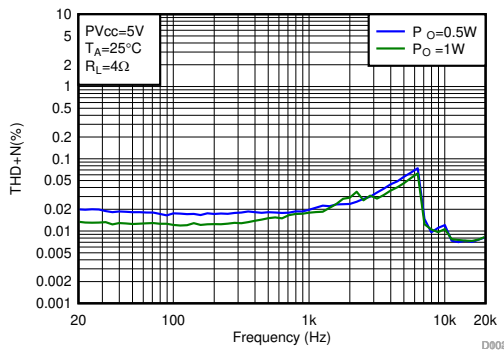

PVDD = 5 V 4.7μH+0.68μF
F_{SW} = 576 kHz 1SPW Modulation Load = 4Ω

Figure 6-1. THD+N vs Frequency-BTL

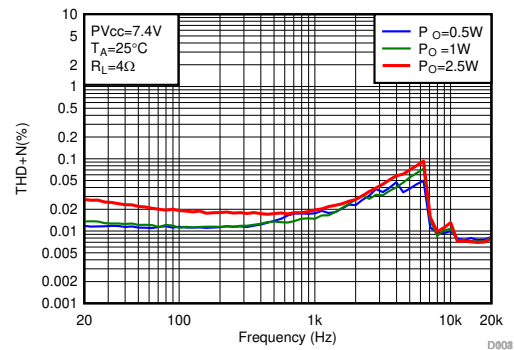

PVDD = 7.4 V 4.7μH+0.68μF
F_{SW} = 576 kHz 1SPW Modulation Load = 4Ω

Figure 6-2. THD+N vs Frequency-BTL

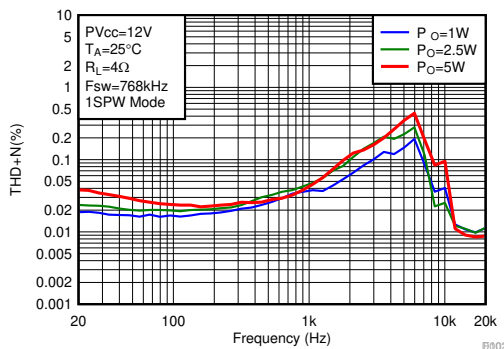

PVDD = 12 V 10μH+0.68μF
F_{SW} = 768 kHz 1SPW Modulation Load = 4Ω

Figure 6-3. THD+N vs Frequency-BTL

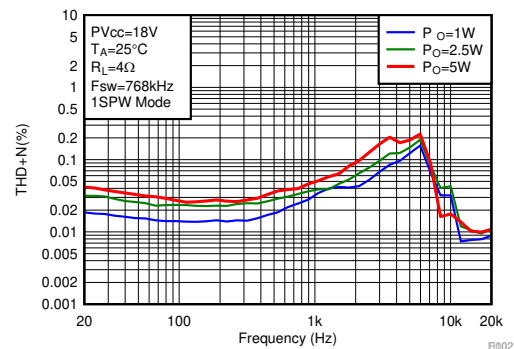

PVDD = 18 V 10μH+0.68μF
F_{SW} = 768 kHz 1SPW Modulation Load = 4Ω

Figure 6-4. THD+N vs Frequency-BTL

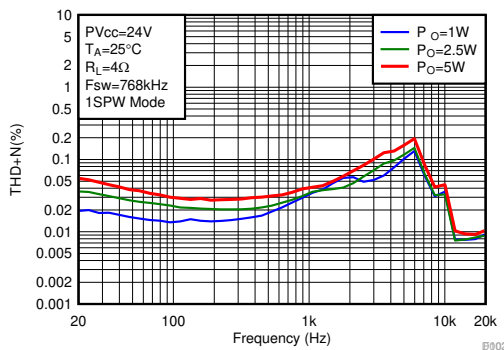

PVDD = 24 V 10μH+0.68μF
F_{SW} = 768 kHz 1SPW Modulation Load = 4Ω

Figure 6-5. THD+N vs Frequency-BTL

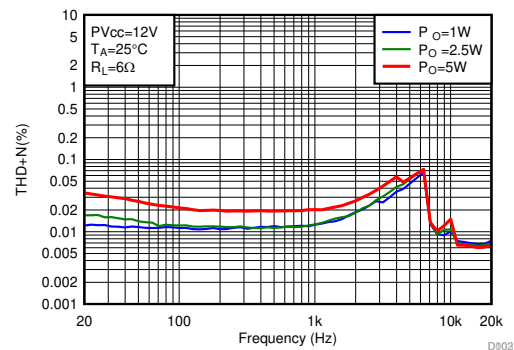

PVDD = 12 V 4.7μH+0.68μF
F_{SW} = 768 kHz 1SPW Modulation Load = 6Ω

Figure 6-6. THD+N vs Frequency-BTL

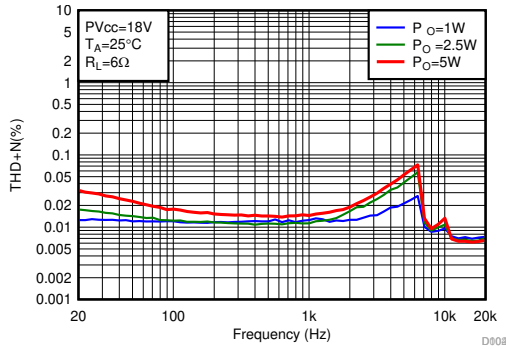

PVDD = 18 V 10μH+0.68μF
 F_{SW} = 768 kHz 1SPW Modulation Load = 6Ω

Figure 6-7. THD+N vs Frequency-BTL

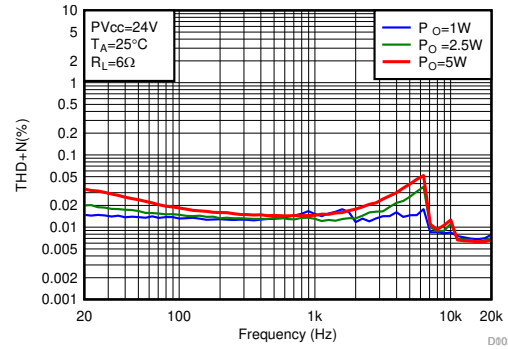

PVDD = 24 V 10μH+0.68μF
 F_{SW} = 768 kHz 1SPW Modulation Load = 6Ω

Figure 6-8. THD+N vs Frequency-BTL

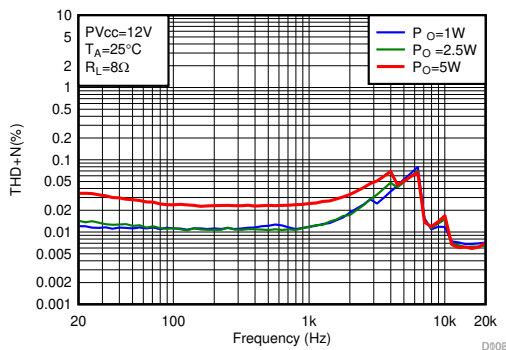

PVDD = 12 V 4.7uH+0.68uF
 F_{SW} = 768 kHz 1SPW Modulation Load = 8Ω

Figure 6-9. THD+N vs Frequency-BTL

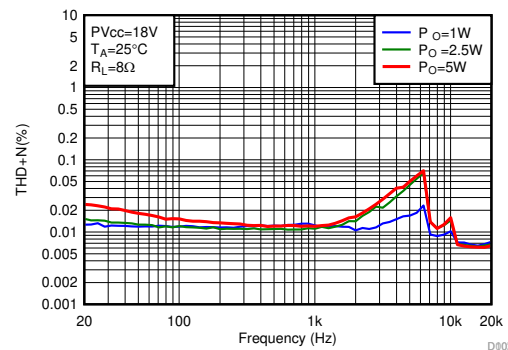

PVDD = 18 V 10μH+0.68μF
 F_{SW} = 768 kHz 1SPW Modulation Load = 8Ω

Figure 6-10. THD+N vs Frequency-BTL

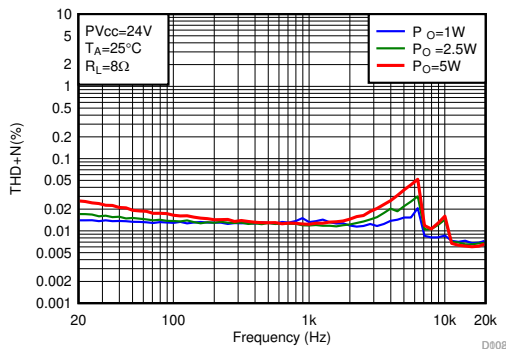

PVDD = 24 V 10μH+0.68μF
 F_{SW} = 768 kHz 1SPW Modulation Load = 8Ω

Figure 6-11. THD+N vs Frequency-BTL

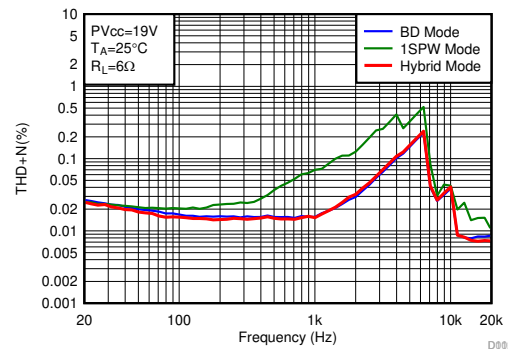

PVDD = 19 V 10μH+0.68μF P_{OUT} = 5W
 F_{SW} = 384 kHz BD/1SPW/Hybrid Load = 6Ω

Figure 6-12. THD+N vs Frequency-BTL

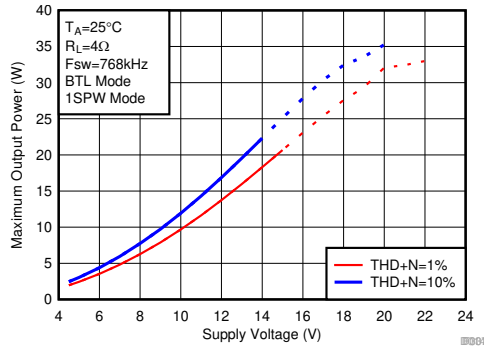

NOTE: Dashed lines represent thermally limited region for the continuous output power.

PVDD = 4.5 V~24V 10μH+0.68μF

F_{SW} = 768 kHz 1SPW Modulation Load = 4Ω

Figure 6-13. Output Power vs Supply Voltage-BTL

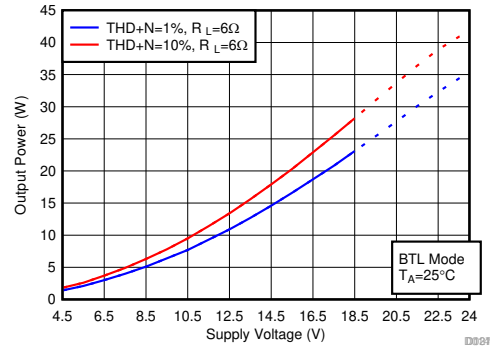

NOTE: Dashed lines represent thermally limited region for the continuous output power.

PVDD = 4.5 V~24V 10μH+0.68μF

F_{SW} = 768 kHz 1SPW Modulation Load = 6Ω

Figure 6-14. Output Power vs Supply Voltage-BTL

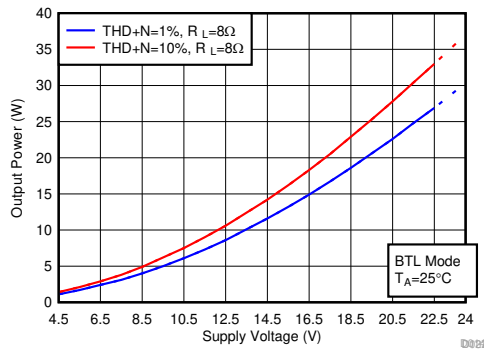

PVDD = 4.5 V~24V 10μH+0.68μF

F_{SW} = 768 kHz 1SPW Modulation Load = 8Ω

Figure 6-15. Output Power vs Supply Voltage-BTL

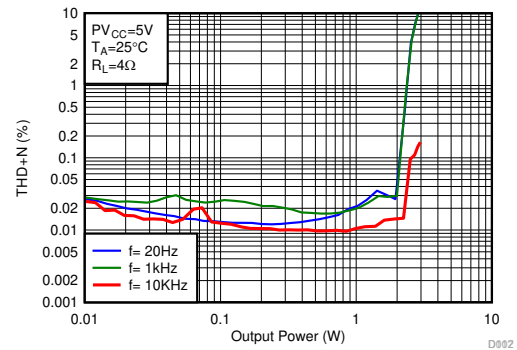

PVDD = 5V 4.7μH+0.68μF

F_{SW} = 768 kHz 1SPW Modulation Load = 4Ω

Figure 6-16. THD+N vs Output Power-BTL

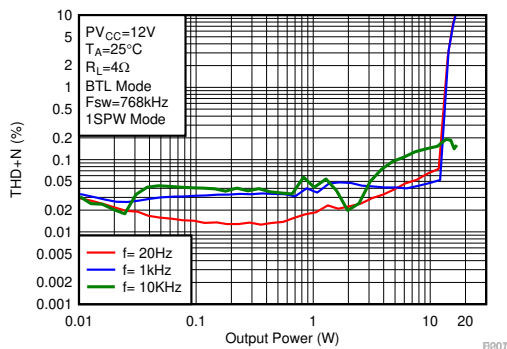

PVDD = 12V 10μH+0.68μF

F_{SW} = 768 kHz 1SPW Modulation Load = 4Ω

Figure 6-17. THD+N vs Output Power-BTL

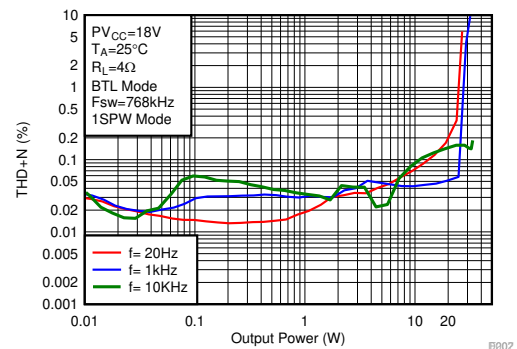

PVDD = 18V 10μH+0.68μF

F_{SW} = 768 kHz 1SPW Modulation Load = 4Ω

Figure 6-18. THD+N vs Output Power-BTL

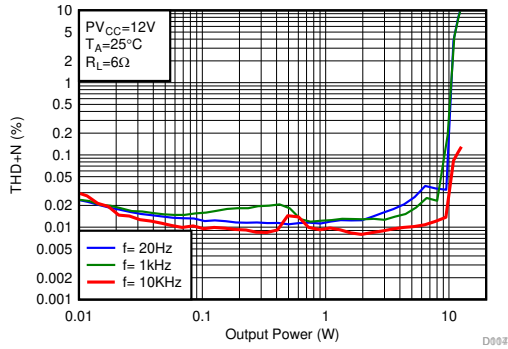

PVDD = 12V 4.7μH+0.68μF
FSW = 768 kHz 1SPW Modulation Load = 6Ω

Figure 6-19. THD+N vs Output Power-BTL

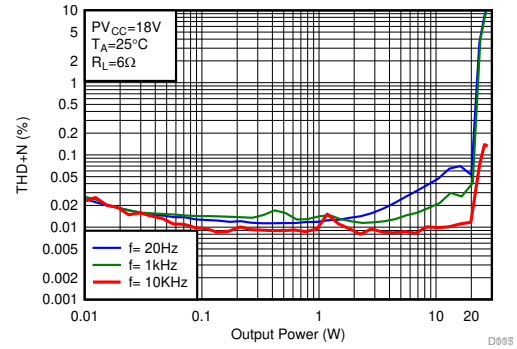

PVDD = 18V 10μH+0.68μF
FSW = 768 kHz 1SPW Modulation Load = 6Ω

Figure 6-20. THD+N vs Output Power-BTL

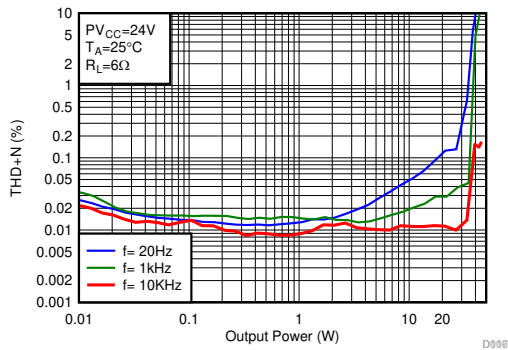

PVDD = 24V 10μH+0.68μF
FSW = 768 kHz 1SPW Modulation Load = 6Ω

Figure 6-21. THD+N vs Output Power-BTL

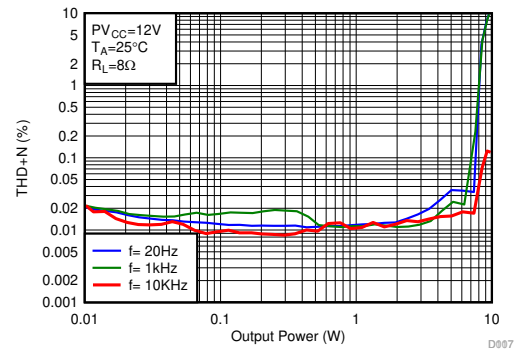

PVDD = 12V 4.7μH+0.68μF
FSW = 768 kHz 1SPW Modulation Load = 8Ω

Figure 6-22. THD+N vs Output Power-BTL

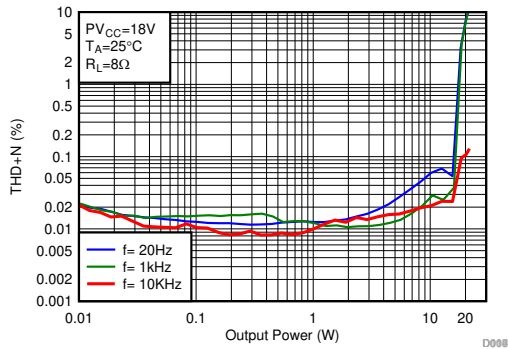

PVDD = 18V 10μH+0.68μF
FSW = 768 kHz 1SPW Modulation Load = 8Ω

Figure 6-23. THD+N vs Output Power-BTL

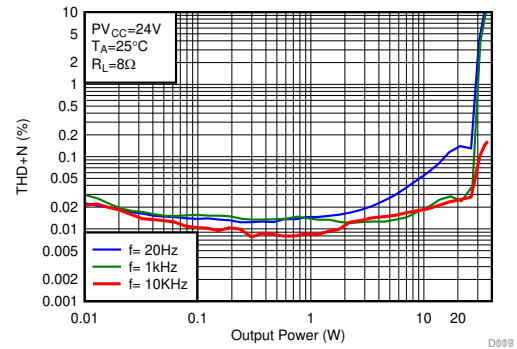

PVDD = 24V 10μH+0.68μF
FSW = 768 kHz 1SPW Modulation Load = 8Ω

Figure 6-24. THD+N vs Output Power-BTL

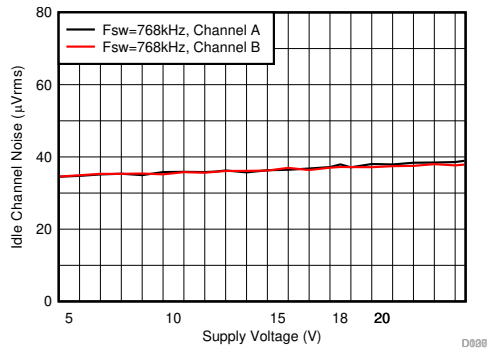

PVDD = 4.5V~24V 10µH+0.68µF
F_{SW} = 768 kHz 1SPW Modulation Load = 8Ω

Figure 6-25. Idle Channel Noise vs PVDD-BTL

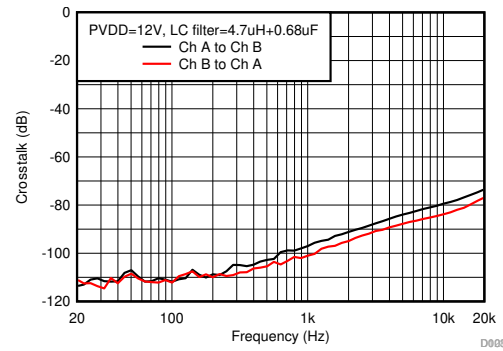

PVDD = 12V LC filter=4.7µH+0.68µF Pout=1W
F_{SW} = 768 kHz 1SPW Modulation Load = 6Ω

Figure 6-26. Crosstalk

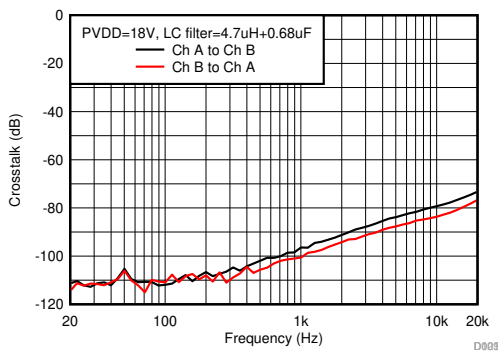

PVDD = 18V 10µH+0.68µF Pout=1W
F_{SW} = 768 kHz 1SPW Modulation Load = 6Ω

Figure 6-27. Crosstalk

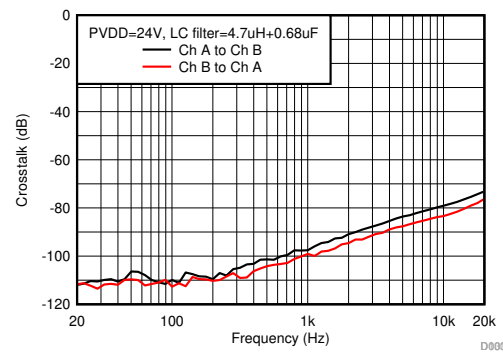

PVDD = 24V 10µH+0.68µF Pout=1W
F_{SW} = 768 kHz 1SPW Modulation Load = 6Ω

Figure 6-28. Crosstalk

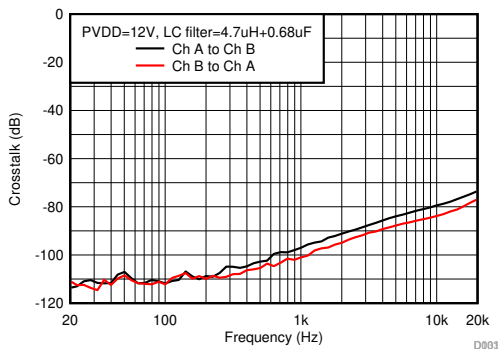

PVDD = 12V LC filter=4.7µH+0.68µF Pout=1W
F_{SW} = 768 kHz 1SPW Modulation Load = 8Ω

Figure 6-29. Crosstalk

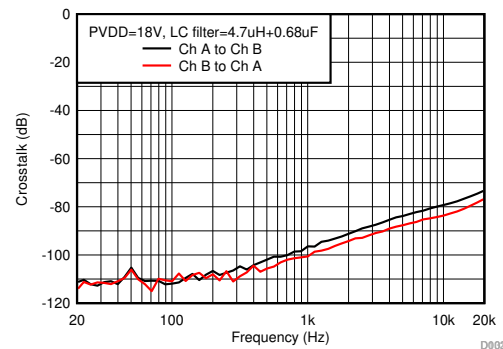

PVDD = 18V 10µH+0.68µF Pout=1W
F_{SW} = 768 kHz 1SPW Modulation Load = 8Ω

Figure 6-30. Crosstalk

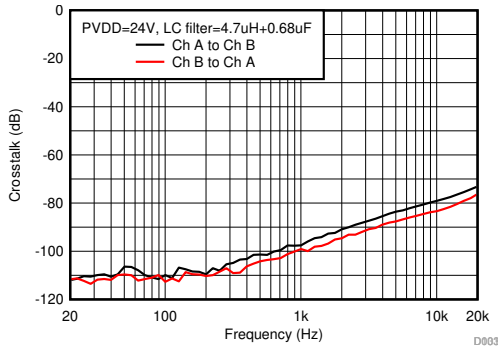

PVDD = 24V 10μH+0.68μF Pout=1W
F_{SW} = 768 kHz 1SPW Modulation Load = 8Ω

Figure 6-31. Crosstalk

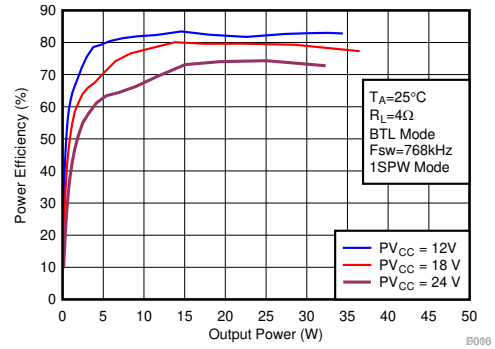

PVDD = 10μH+0.68μF
12V/18V/24V
F_{SW} = 768 kHz 1SPW Modulation Load = 4Ω

Figure 6-32. Efficiency vs Output Power-BTL

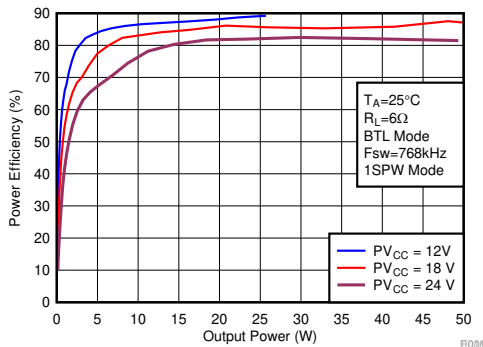

PVDD = 10μH+0.68μF
12V/18V/24V
F_{SW} = 768 kHz 1SPW Modulation Load = 6Ω

Figure 6-33. Efficiency vs Output Power-BTL

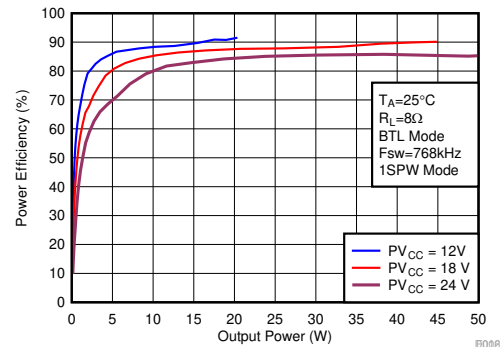

PVDD = 10μH+0.68μF
12V/18V/24V
F_{SW} = 768 kHz 1SPW Modulation Load = 8Ω

Figure 6-34. Efficiency vs Output Power-BTL

6.7.2 Bridge Tied Load (BTL) Configuration Curves with BD Mode

Free-air room temperature 25°C (unless otherwise noted.) Measurements were made using TAS5805MEVM board and Audio Precision System 2722 with Analog Analyzer filter set to 20-kHz brickwall filter. All measurements taken with audio frequency set to 1 kHz and device PWM Modulation mode set to BD mode with Class D Bandwidth = 175kHz (Listed in Register 0x53) unless otherwise noted.

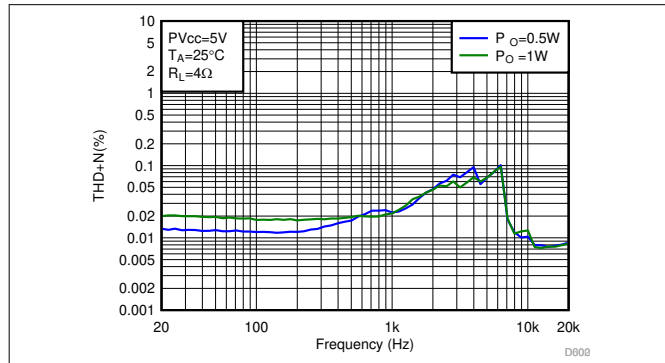

PVDD = 5V 10μH+0.68μF
F_{SW} = 768 kHz BD Modulation Load = 4Ω

Figure 6-35. THD+N vs Frequency

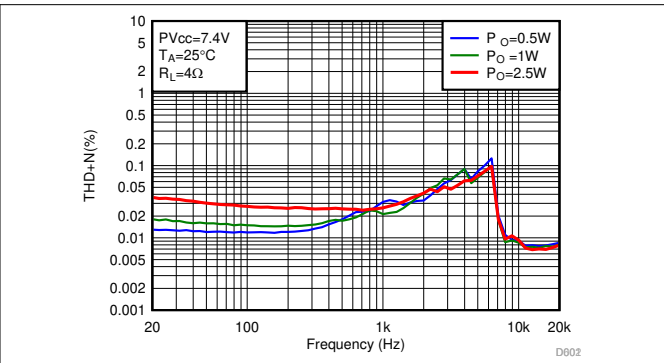

PVDD = 7.4V 10μH+0.68μF
F_{SW} = 768 kHz BD Modulation Load = 4Ω

Figure 6-36. THD+N vs Frequency

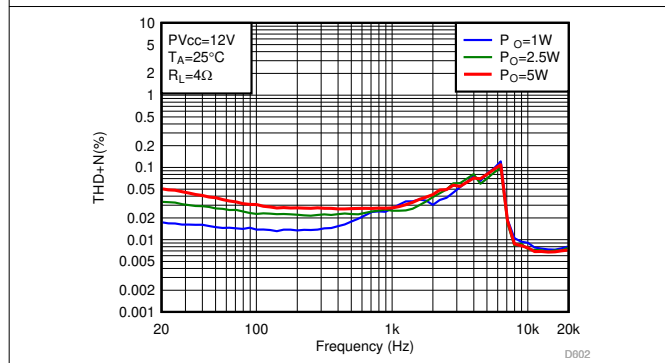

PVDD = 12V 10μH+0.68μF
F_{SW} = 768 kHz BD Modulation Load = 4Ω

Figure 6-37. THD+N vs Frequency

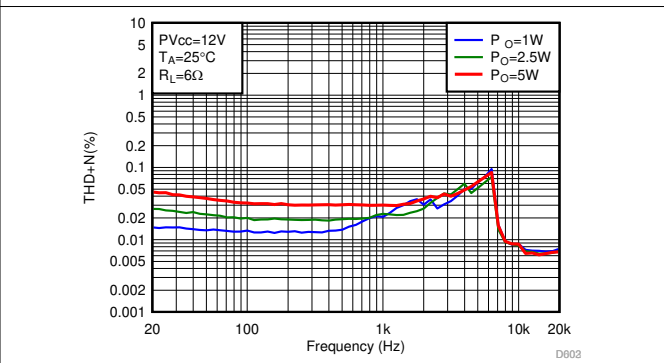

PVDD = 12V 10μH+0.68μF
F_{SW} = 768 kHz BD Modulation Load = 6Ω

Figure 6-38. THD+N vs Frequency

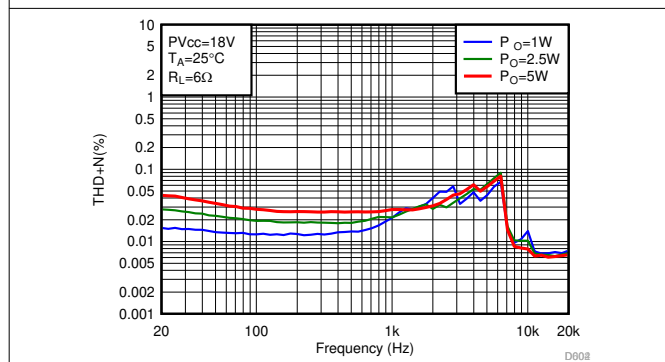

PVDD = 18V 10μH+0.68μF
F_{SW} = 768 kHz BD Modulation Load = 6Ω

Figure 6-39. THD+N vs Frequency

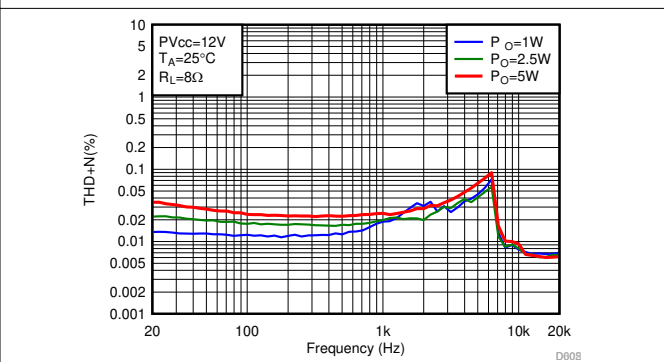

PVDD = 12V 10μH+0.68μF
F_{SW} = 768 kHz BD Modulation Load = 8Ω

Figure 6-40. THD+N vs Frequency

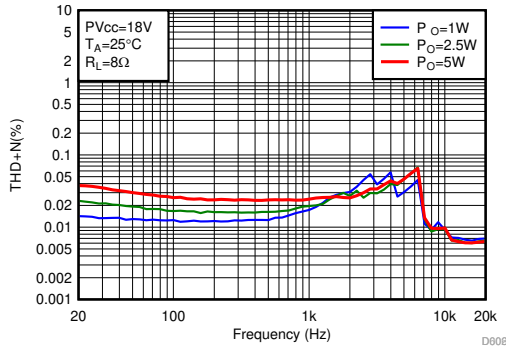

PVDD = 18V 10 μ H+0.68 μ F
 F_{SW} = 768 kHz BD Modulation Load = 8 Ω

Figure 6-41. THD+N vs Frequency

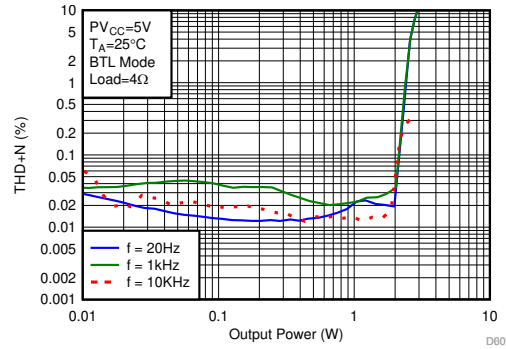

PVDD = 5V 10 μ H+0.68 μ F
 F_{SW} = 768 kHz BD Modulation Load = 4 Ω

Figure 6-42. THD+N vs Output Power

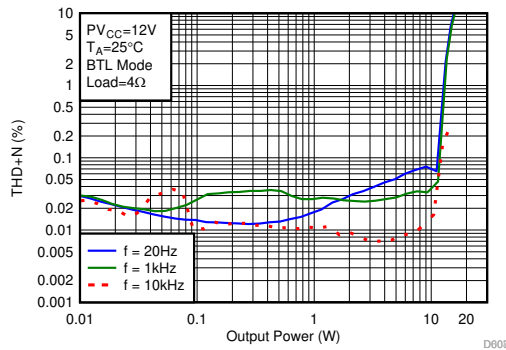

PVDD = 12V 10 μ H+0.68 μ F
 F_{SW} = 768 kHz BD Modulation Load = 4 Ω

Figure 6-43. THD+N vs Output Power

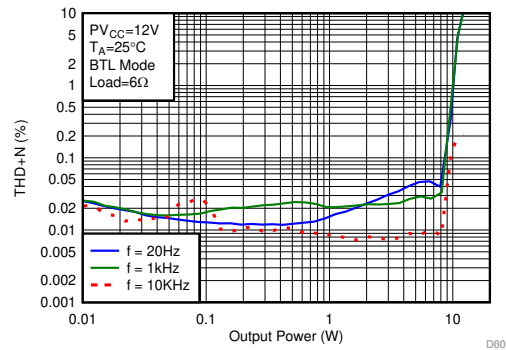

PVDD = 12V 10 μ H+0.68 μ F
 F_{SW} = 768 kHz BD Modulation Load = 6 Ω

Figure 6-44. THD+N vs Output Power

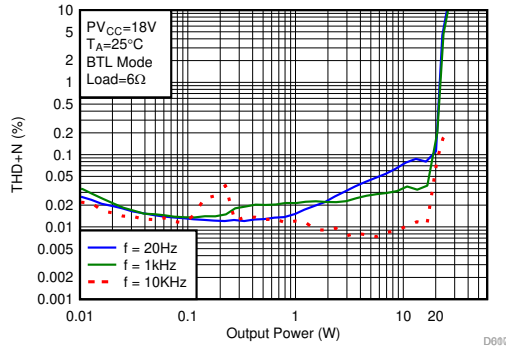

PVDD = 18V 10 μ H+0.68 μ F
 F_{SW} = 768 kHz BD Modulation Load = 6 Ω

Figure 6-45. THD+N vs Output Power

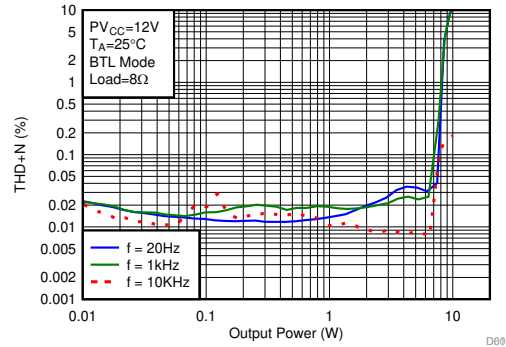

PVDD = 12V 10 μ H+0.68 μ F
 F_{SW} = 768 kHz BD Modulation Load = 8 Ω

Figure 6-46. THD+N vs Output Power

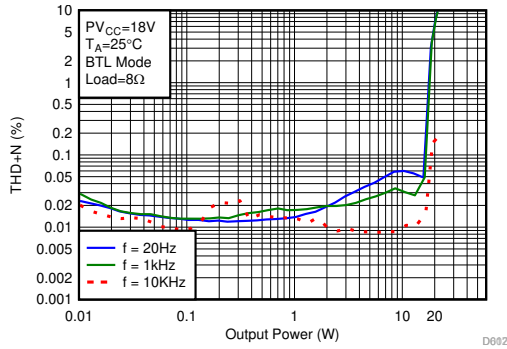

PVDD = 18V 10μH+0.68μF
F_{SW} = 768 kHz BD Modulation Load = 8Ω

Figure 6-47. THD+N vs Output Power

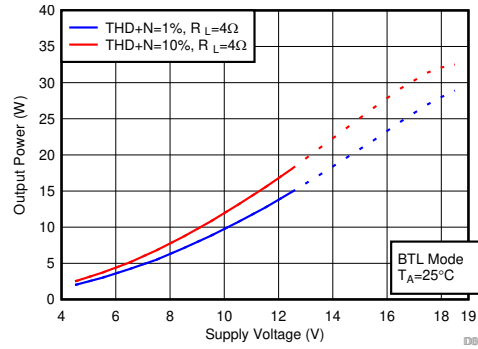

NOTE: Dashed lines represent thermally limited region for the continuous output power.

10μH+0.68μF
F_{SW} = 768 kHz BD Modulation Load = 4Ω

Figure 6-48. Output Power vs Supply Voltage

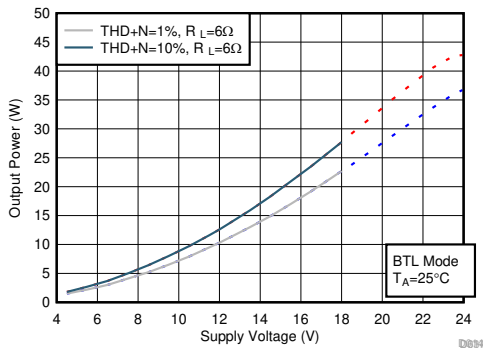

NOTE: Dashed lines represent thermally limited region for the continuous output power.

10μH+0.68μF
F_{SW} = 768 kHz BD Modulation Load = 6Ω

Figure 6-49. Output Power vs Supply Voltage

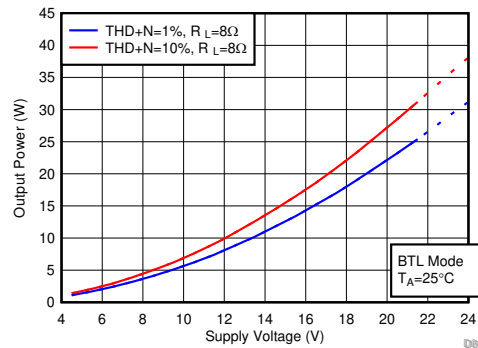

NOTE: Dashed lines represent thermally limited region for the continuous output power.

10μH+0.68μF
F_{SW} = 768 kHz BD Modulation Load = 8Ω

Figure 6-50. Output Power vs Supply Voltage

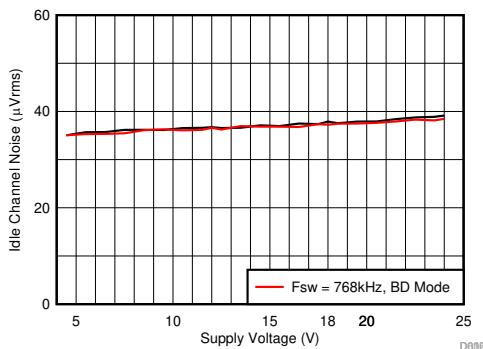

10μH+0.68μF
F_{SW} = 768 kHz BD Modulation Load = 6Ω

Figure 6-51. Idle Channel Noise vs Supply Voltage

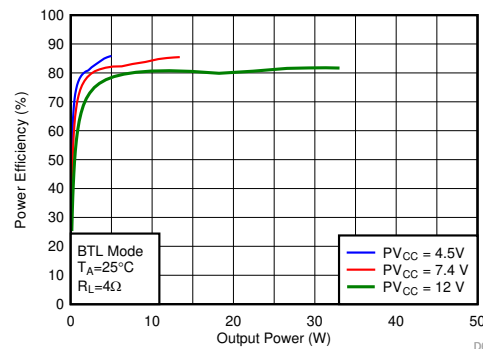

10μH+0.68μF
F_{SW} = 768 kHz BD Modulation Load = 4Ω

Figure 6-52. Efficiency vs Output Power

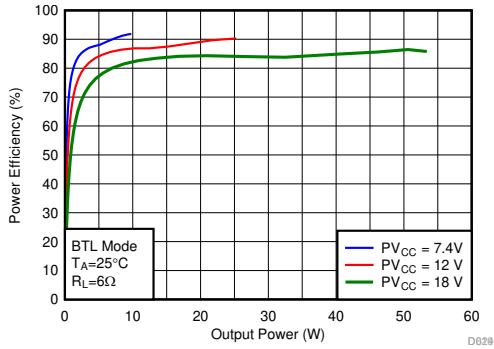

10μH+0.68μF

F_{SW} = 768 kHz BD Modulation Load = 6Ω

Figure 6-53. Efficiency vs Output Power

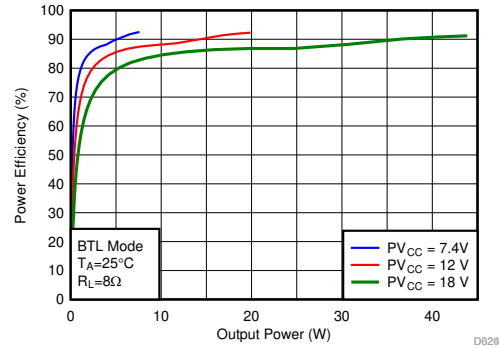

10μH+0.68μF

F_{SW} = 768 kHz BD Modulation Load = 8Ω

Figure 6-54. Efficiency vs Output Power

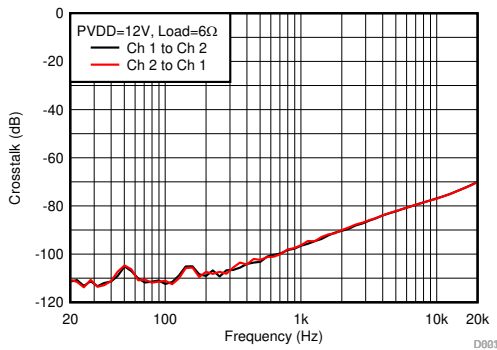

PVDD=12V 10μH+0.68μF
F_{SW} = 768 kHz BD Modulation Load = 6Ω

Figure 6-55. Crosstalk

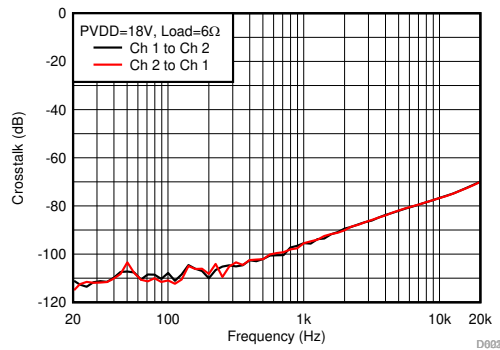

PVDD=18V 10μH+0.68μF
F_{SW} = 768 kHz BD Modulation Load = 6Ω

Figure 6-56. Crosstalk

6.7.3 Bridge Tied Load (BTL) Configuration Curves with Ferrite Bead + Capacitor as the Output Filter

Free-air room temperature 25°C (unless otherwise noted) Measurements were made using TAS5805MEVM board and Audio Precision System 2722 with Analog Analyzer filter set to 20-kHz brickwall filter. All measurements taken with audio frequency set to 1 kHz and device PWM frequency set to 384 kHz, with Class D Bandwidth = 80 kHz (Listed in Register 0x53), Spread Spectrum Enable, Ferrite bead + Capacitor as the output filter, BD Modulation, unless otherwise noted.

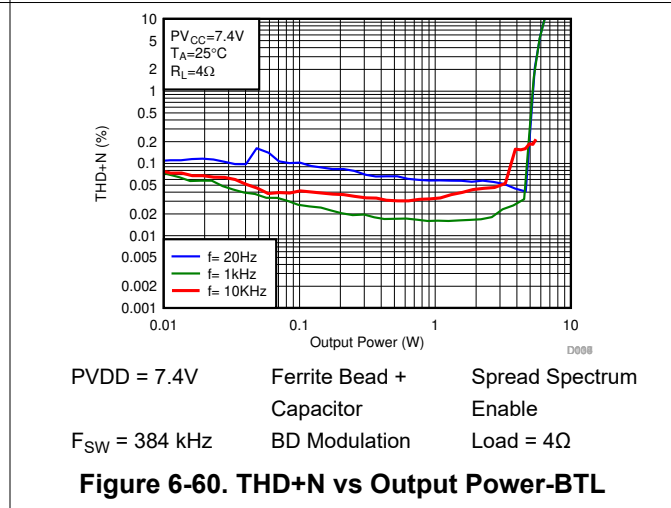
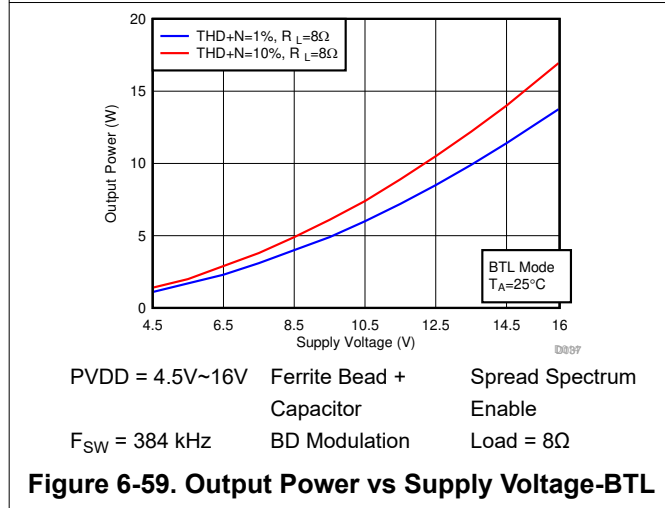
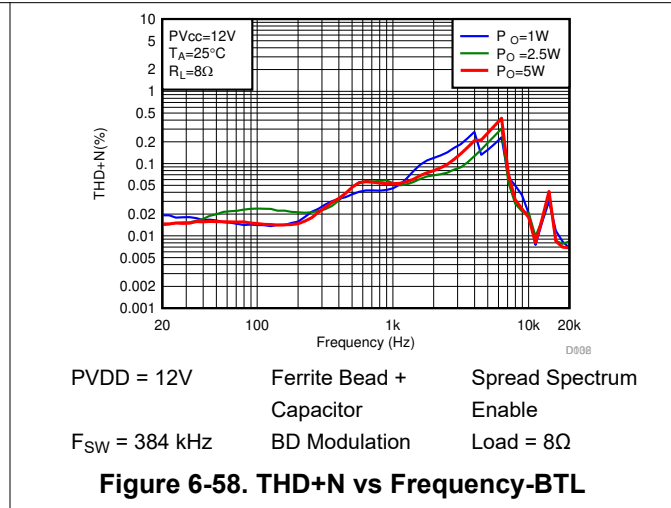
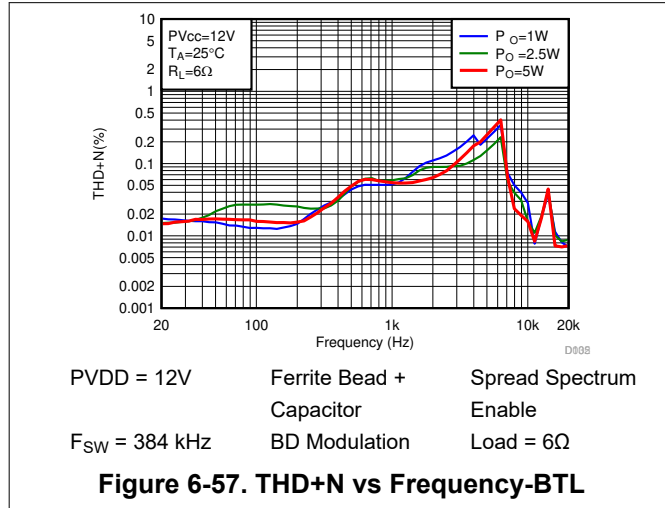

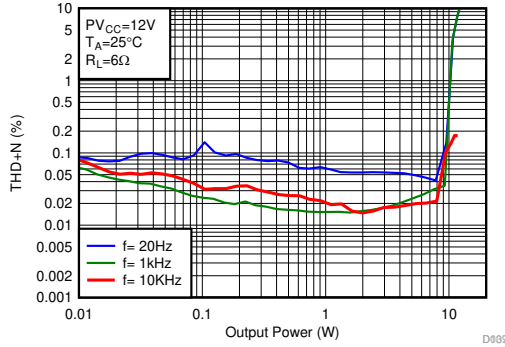

PVDD = 12V Ferrite Bead + Spread Spectrum
 Capacitor Enable
 F_{SW} = 384 kHz BD Modulation Load = 6Ω

Figure 6-61. THD+N vs Output Power-BTL

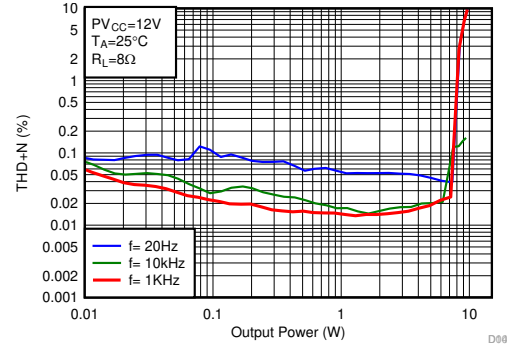

PVDD = 12V Ferrite Bead + Spread Spectrum
 Capacitor Enable
 F_{SW} = 384 kHz BD Modulation Load = 8Ω

Figure 6-62. THD+N vs Output Power-BTL

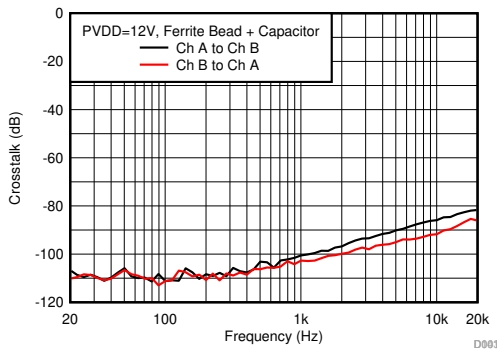

PVDD = 12V, Ferrite Bead + Spread Spectrum
 Pout=1W Capacitor Enable
 F_{SW} = 384 kHz BD Modulation Load = 6Ω

Figure 6-63. Crosstalk

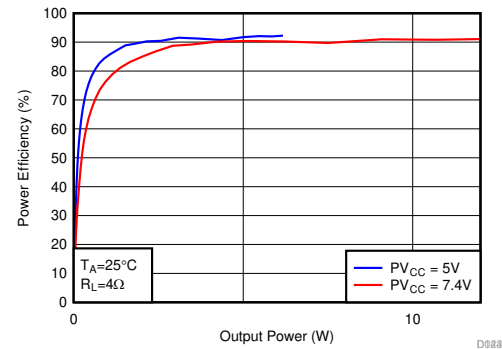

PVDD = 5V/7.4V Ferrite Bead + Spread Spectrum
 Capacitor Enable
 F_{SW} = 384 kHz BD Modulation Load = 4Ω

Figure 6-64. Efficiency vs Output Power-BTL

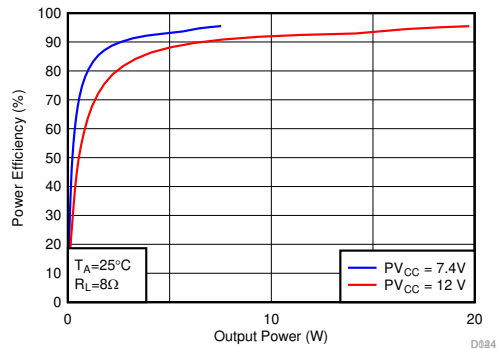

PVDD = 7.4V/12V Ferrite Bead + Spread Spectrum
 Capacitor Enable
 F_{SW} = 384 kHz BD Modulation Load = 8Ω

Figure 6-65. Efficiency vs Output Power-BTL

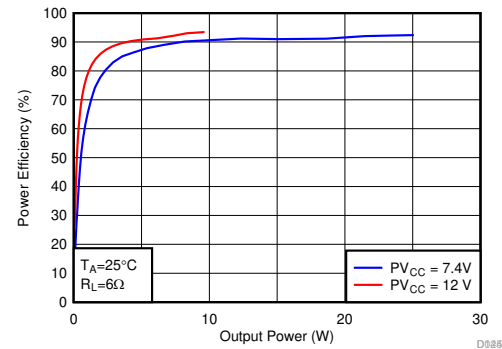

PVDD = 7.4V/12V Ferrite Bead + Spread Spectrum
 Capacitor Enable
 F_{SW} = 384 kHz BD Modulation Load = 6Ω

Figure 6-66. Efficiency vs Output Power-BTL

6.7.4 Parallel Bridge Tied Load (PBTL) Configuration with 1SPW Modulation

Free-air room temperature 25°C (unless otherwise noted.) Measurements were made using TAS5805MEVM board and Audio Precision System 2722 with Analog Analyzer filter set to 20-kHz brickwall filter. All measurements taken with audio frequency set to 1 kHz and device PWM frequency set to 576 kHz, the LC filter used was 4.7 μ H / 0.68 μ F, 1SPW modulation with Class D Bandwidth = 120kHz (Listed in Register 0x53) unless otherwise noted.

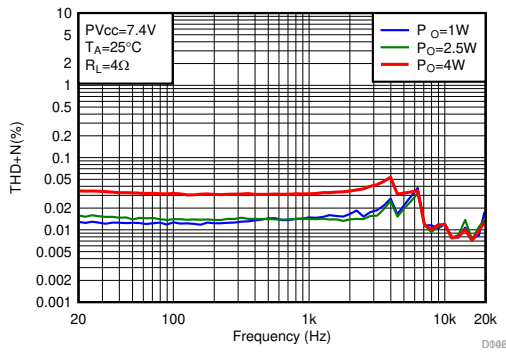

PVDD = 7.4V 4.7 μ H + 0.68 μ F
 F_{SW} = 576 kHz 1SPW Modulation Load = 4 Ω

Figure 6-67. THD+N vs Frequency-PBTL

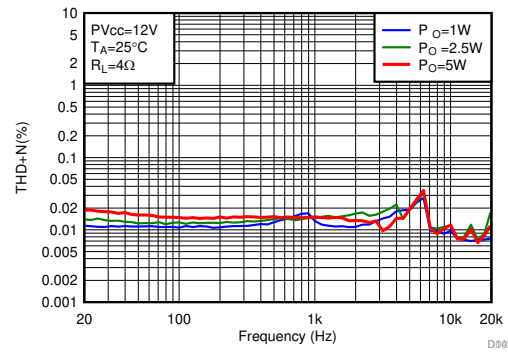

PVDD = 12V 4.7 μ H + 0.68 μ F
 F_{SW} = 576 kHz 1SPW Modulation Load = 4 Ω

Figure 6-68. THD+N vs Frequency-PBTL

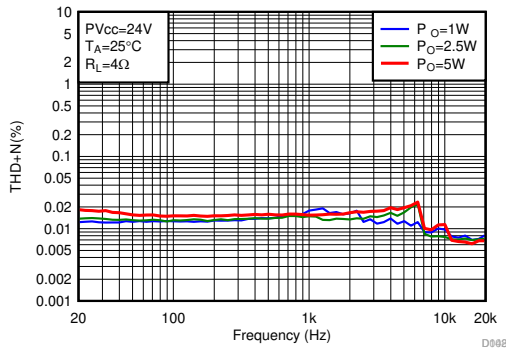

PVDD = 24V 4.7 μ H + 0.68 μ F
 F_{SW} = 576 kHz 1SPW Modulation Load = 4 Ω

Figure 6-69. THD+N vs Frequency-PBTL

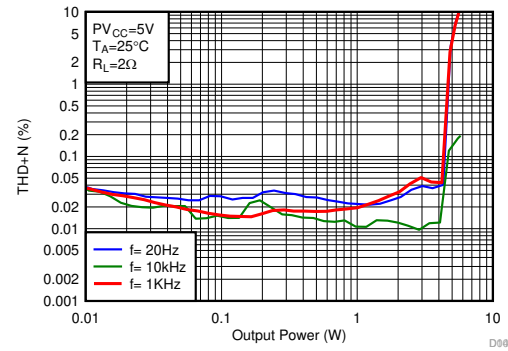

PVDD = 5V 4.7 μ H + 0.68 μ F
 F_{SW} = 576 kHz 1SPW Modulation Load = 2 Ω

Figure 6-70. THD+N vs Output Power-PBTL

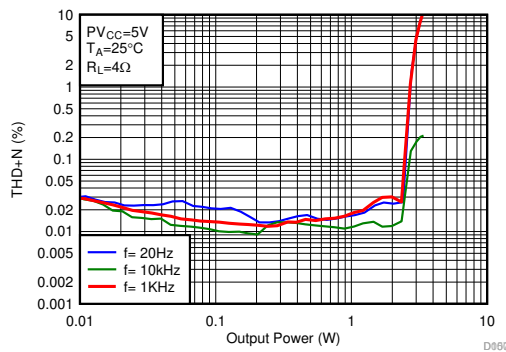

PVDD = 5V 4.7 μ H + 0.68 μ F
 F_{SW} = 576 kHz 1SPW Modulation Load = 4 Ω

Figure 6-71. THD+N vs Output Power-PBTL

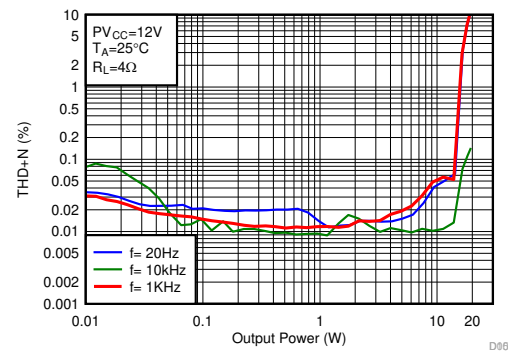

PVDD = 12V 4.7 μ H + 0.68 μ F
 F_{SW} = 576 kHz 1SPW Modulation Load = 4 Ω

Figure 6-72. THD+N vs Output Power-PBTL

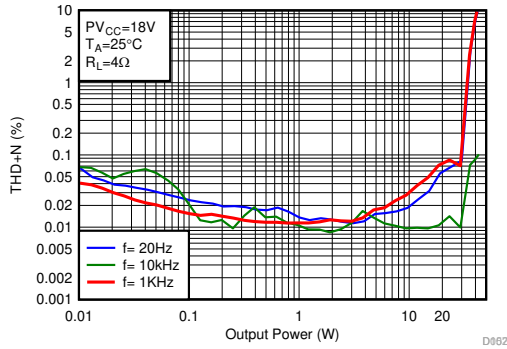

PVDD = 18V 4.7uH + 0.68uF
FSW = 576 kHz 1SPW Modulation Load = 4Ω

Figure 6-73. THD+N vs Output Power-PBTL

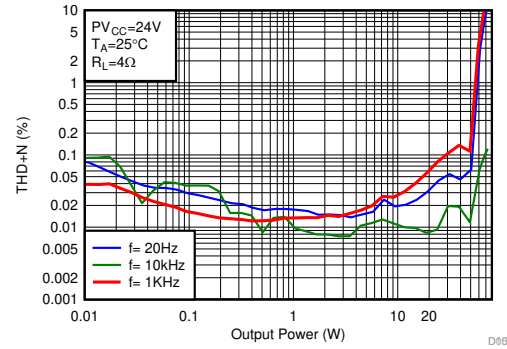

PVDD = 24V 4.7uH + 0.68uF
FSW = 576kHz 1SPW Modulation Load = 4Ω

Figure 6-74. THD+N vs Output Power-PBTL

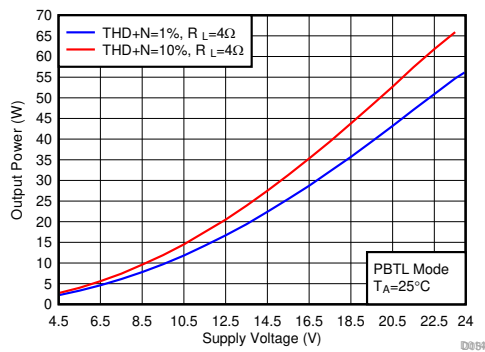

PVDD = 4.5V~24V 4.7uH + 0.68uF
FSW = 576 kHz 1SPW Modulation Load = 4Ω

Figure 6-75. Output Power vs Supply Voltage-PBTL

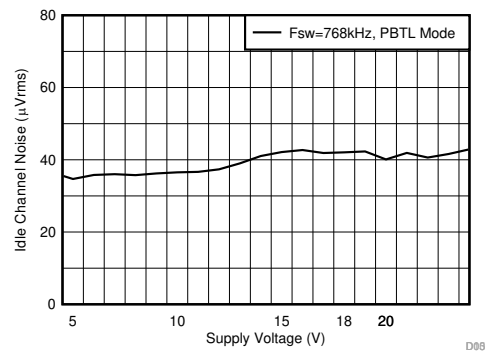

PVDD = 4.5V~24V 4.7uH + 0.68uF
FSW = 576 kHz 1SPW Modulation Load = 4Ω

Figure 6-76. Idle Channel Noise vs Supply Voltage-PBTL

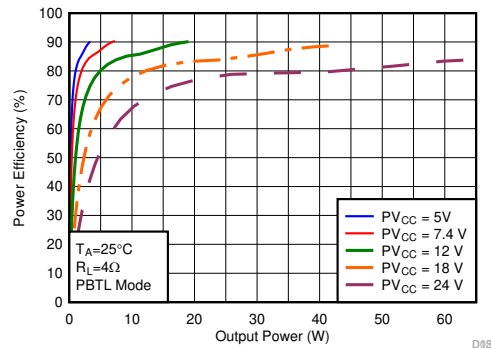

PVDD = 5V/7.4V/12V/18V/24V 4.7uH + 0.68uF
FSW = 576 kHz 1SPW Modulation Load = 4Ω

Figure 6-77. Efficiency vs Output Power

6.7.5 Parallel Bridge Tied Load (PBTL) Configuration with BD Modulation

Free-air room temperature 25°C (unless otherwise noted.) Measurements were made using TAS5805MEVM board and Audio Precision System 2722 with Analog Analyzer filter set to 20-kHz brickwall filter. All measurements taken with audio frequency set to 1 kHz and device PWM frequency set to 768 kHz, the LC filter used was 10 μ H / 0.68 μ F, BD Modulation with Class D Bandwidth = 175kHz (Listed in Register 0x53), unless otherwise noted.

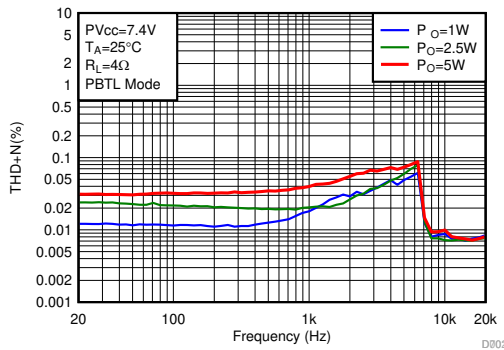

PVDD = 7.4V 10 μ H+0.68 μ F
 F_{SW} = 768 kHz BD Modulation Load = 4 Ω

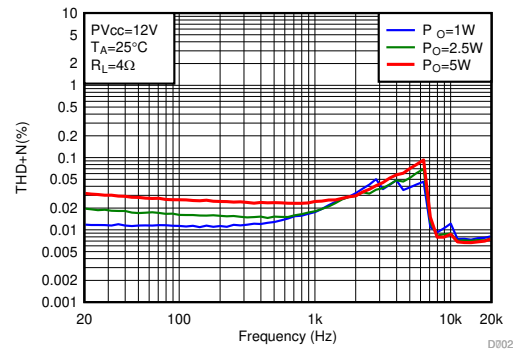
Figure 6-78. THD+N vs Frequency

PVDD = 12V 10 μ H+0.68 μ F
 F_{SW} = 768 kHz BD Modulation Load = 4 Ω

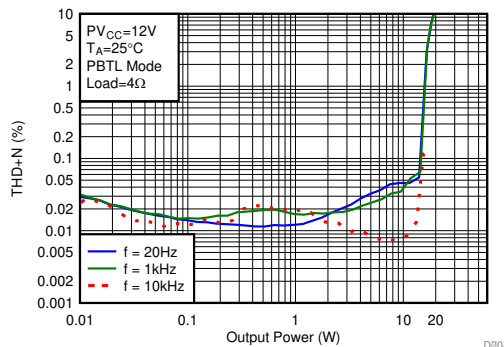
Figure 6-79. THD+N vs Frequency

PVDD = 12V 10 μ H+0.68 μ F
 F_{SW} = 768 kHz BD Modulation Load = 4 Ω

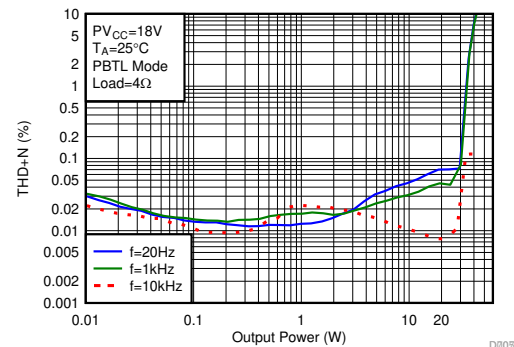
Figure 6-80. THD+N vs Output Power

PVDD = 18V 10 μ H+0.68 μ F
 F_{SW} = 768 kHz BD Modulation Load = 4 Ω

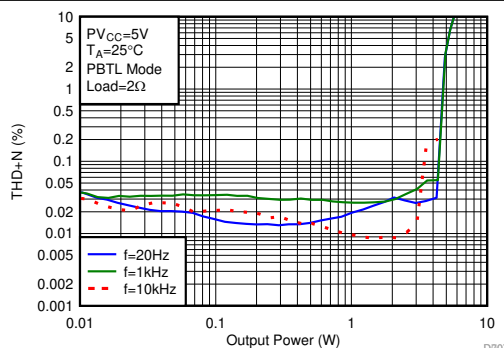
Figure 6-81. THD+N vs Output Power

PVDD = 5V 10 μ H+0.68 μ F
 F_{SW} = 768 kHz BD Modulation Load = 2 Ω

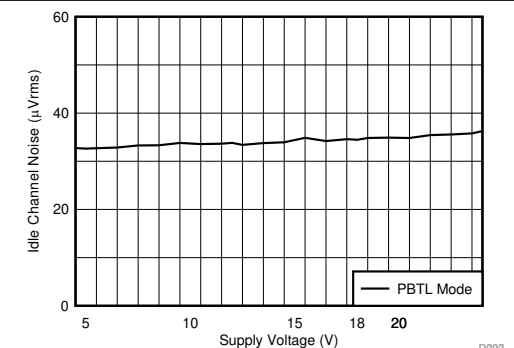
Figure 6-82. THD+N vs Output Power

F_{SW} = 768 kHz BD Modulation Load = 4 Ω

Figure 6-83. Idle Channel Noise vs Supply Voltage

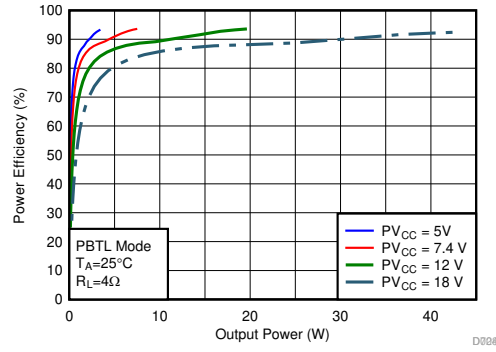

F_{SW} = 768 kHz

10μH+0.68μF

BD Modulation

Load = 4Ω

Figure 6-84. Efficiency vs Output Power

Parameter Measurement Information

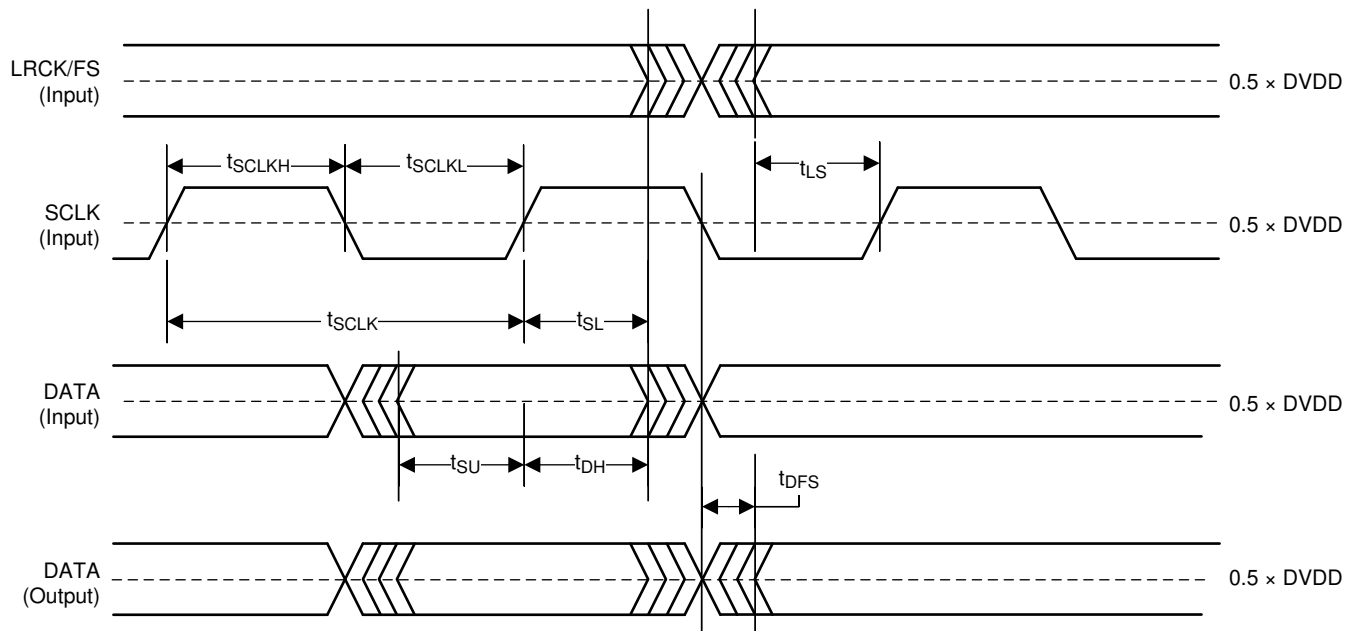

Figure 7-1. Serial Audio Port Timing in Slave Mode

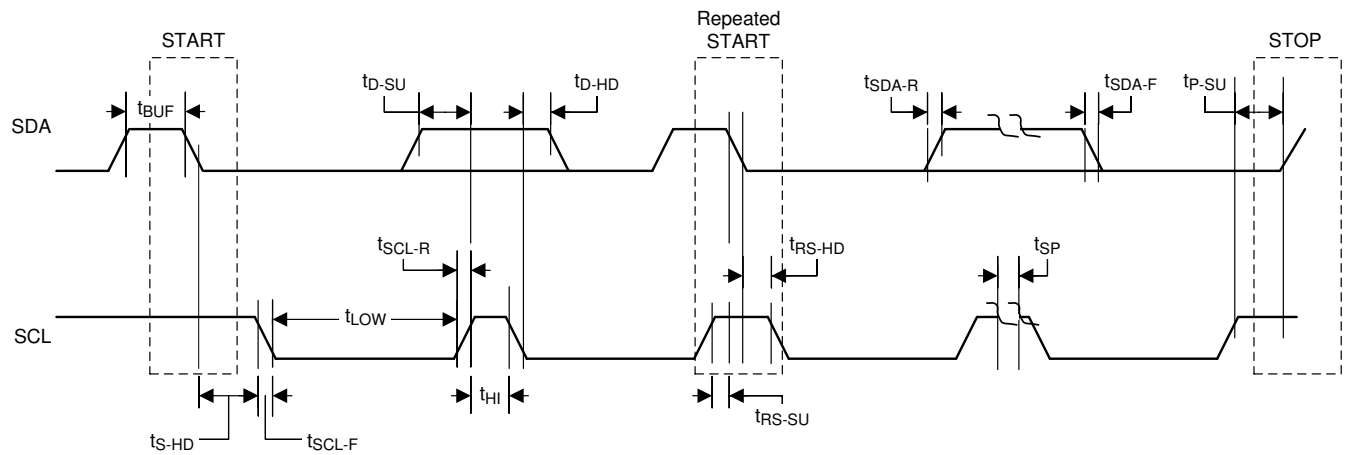

Figure 7-2. I²C Communication Port Timing Diagram

7 Detailed Description

7.1 Overview

The TAS5805M device integrates 4 main building blocks together into a single cohesive device that maximizes sound quality, flexibility, and ease of use. The 4 main building blocks are listed as follows:

- A stereo audio DAC.
- An Audio DSP subsystem.
- A flexible closed-loop amplifier capable of operating in stereo or mono, at different switching frequencies, and supporting a variety of output voltages and loads.
- An I²C control port for communication with the device

The device requires only two power supplies for proper operation. A DVDD supply is required to power the low voltage digital circuitry. Another supply, called PVDD, is required to provide power to the output stage of the audio amplifier. Two internal LDOs convert PVDD to 5 V for GVDD and AVDD and to 1.5V for DVDD respectively.

7.2 Functional Block Diagram

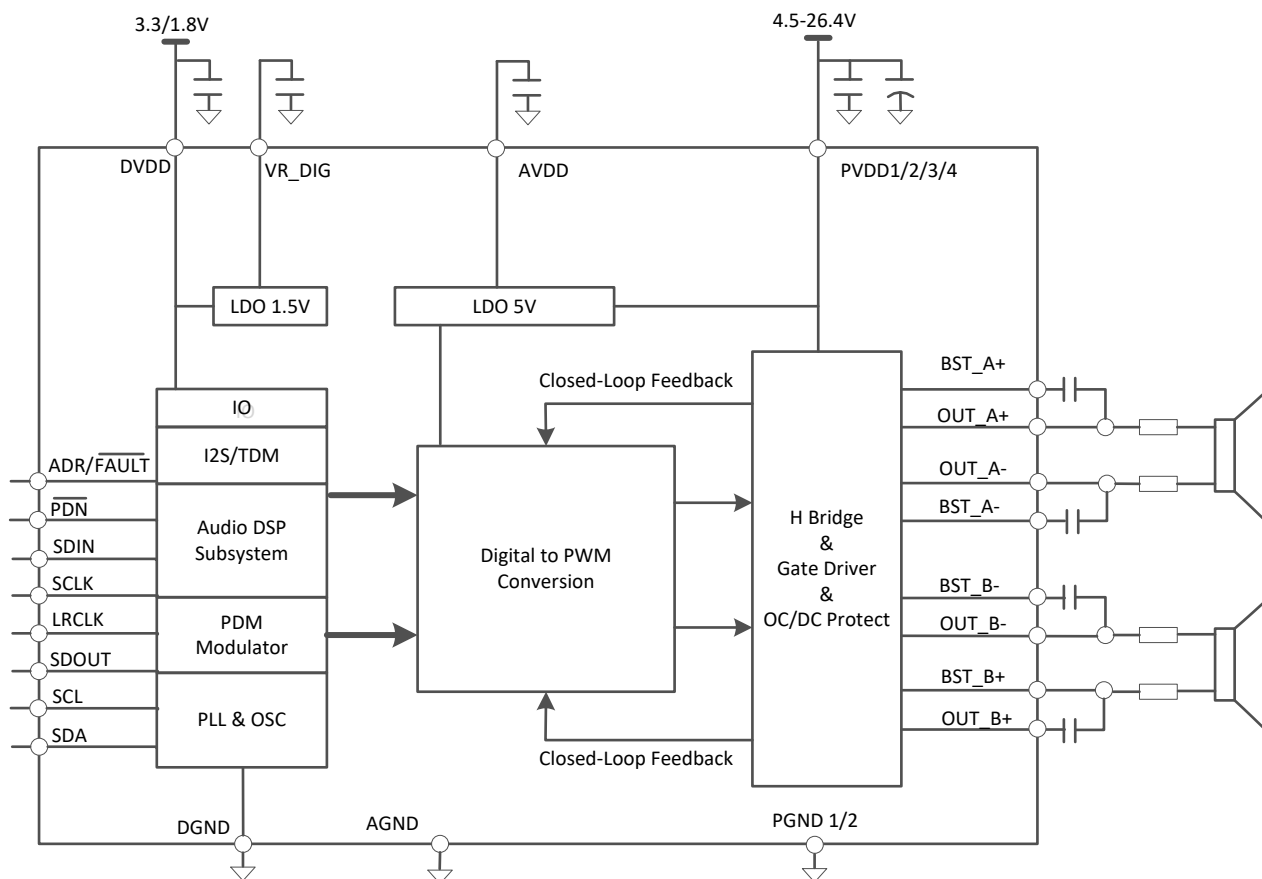

7.3 Feature Description

7.3.1 Power Supplies

To facilitate system design, TAS5805M needs only a 3.3-V or 1.8-V supply in addition to the (typical) 12-V or 24-V power-stage supply. Two internal voltage regulators provide suitable voltage levels for the gate drive circuitry and internal circuitry. The external pins are provided only as a connection point for off-chip bypass capacitors to filter the supply. Connecting external circuitry to these regulator outputs may result in reduced performance and damage to the device. Additionally, all circuitry requiring a floating voltage supply, e.g., the high-side gate drive, is accommodated by built-in bootstrap circuitry requiring only a few external capacitors. In order to provide good electrical and acoustical characteristics, the PWM signal path for the output stage is

designed as identical, independent half-bridges. For this reason, each half-bridge has separate bootstrap pins (BST_x). The gate drive voltages (AVDD) are derived from the PVDD voltage. Special attention should be paid to placing all decoupling capacitors as close to their associated pins as possible. In general, inductance between the power-supply pins and decoupling capacitors must be avoided. For a properly functioning bootstrap circuit, a small ceramic capacitor must be connected from each bootstrap pin (BST_x) to the power-stage output pin (OUT_x). When the power-stage output is low, the bootstrap capacitor is charged through an internal diode connected between the gate-drive regulator output pin (AVDD) and the bootstrap pin. When the power-stage output is high, the bootstrap capacitor potential is shifted above the output potential and thus provides a suitable voltage supply for the high-side gate driver.

7.3.2 Device Clocking

The TAS5805M devices have flexible systems for clocking. Internally, the device requires a number of clocks, mostly at related clock rates to function correctly. All of these clocks can be derived from the Serial Audio Interface.

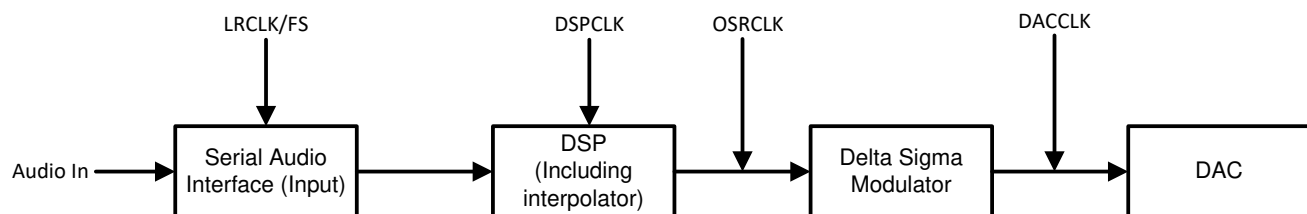

Figure 7-1. Audio Flow with Respective Clocks

Figure 7-1 shows the basic data flow and clock distribution.

The Serial Audio Interface typically has 3 connection pins which are listed as follows:

- SCLK (Bit Clock)
- LRCLK/FS (Left Right Word Clock and Frame Sync)
- SDIN (Input Data)

The device has an internal PLL that is used to take SCLK (Bit Clock) as reference clock and create the higher rate clocks required by the DSP and the DAC clock.

The TAS5805M device has an audio sampling rate detection circuit that automatically senses the sampling frequency. Common audio sampling frequencies of 32 kHz, 44.1kHz – 48 kHz, 88.2 kHz – 96 kHz are supported. The sampling frequency detector sets the clock for DAC and DSP automatically.

7.3.3 Serial Audio Port – Clock Rates

The serial audio interface port is a 3-wire serial port with the signals LRCLK/FS, SCLK, and SDIN. SCLK is the serial audio bit clock, used to clock the serial data present on SDIN into the serial shift register of the audio interface. Serial data is clocked into the TAS5805M device on the rising edge of SCLK. The LRCK/FS pin is the serial audio left/right word clock or frame sync when the device is operated in TDM Mode.

Table 7-1. Audio Data Formats, Bit Depths and Clock Rates

FORMAT	DATA BITS	MAXIMUM LRCLK/FS FREQUENCY (kHz)	SCLK RATE (f _s)
I ² S/LJ/RJ	32, 24, 20, 16	32 to 96	64, 32
TDM	32, 24, 20, 16	32	128
		44.1,48	128,256,512
		96	128,256

Before DSP register initialize with I²C during the startup, TAS5805M requires stable I²S ready. When Clock halt, non-supported SCLK to LRCLK(FS) ratio is detected, the device reports Clock Error in Register 113 (Register Address 0x71).

7.3.4 Clock Halt Auto-recovery

As some of host processor will Halt the I²S clock when there is no audio playing. When Clock halt, the device puts all channels into the Hi-Z state and reports Clock Error in Register 113 (Register Address 0x71). After audio clocks recovery, the device automatically returns to the previous state.

7.3.5 Sample Rate on the Fly Change

TAS5805M supports LRCLK(FS) rate on the fly change. For example, change LCRLK from 32kHz to 48kHz or 96kHz, Host processor needs to put the LRCLK(FS)/SCLK to Halt state at least 100us before changing to the new sample rate.

7.3.6 Serial Audio Port - Data Formats and Bit Depths

The device supports industry-standard audio data formats, including standard I2S, left-justified, right-justified and TDM/DSP data. Data formats are selected via Register (P0-R51-D[5:4]). If the high width of LRCK/FS in TDM/DSP mode is less than 8 cycles of SCK, the register (P0-R51-D[3:2]) should be set to 01. All formats require binary two's complement, MSB-first audio data; up to 32-bit audio data is accepted. All the data formats, word length and clock rate supported by this device are shown in Table 7-1. The data formats are detailed in Figure 7-2 through Figure 7-6. The word length are selected via Register (P0-R51-D[1:0]). The offsets of data are selected via Register (P0-R51-D[7]) and Register (P0-R52-D[7:0]). Default setting is I2S and 24 bit word length.

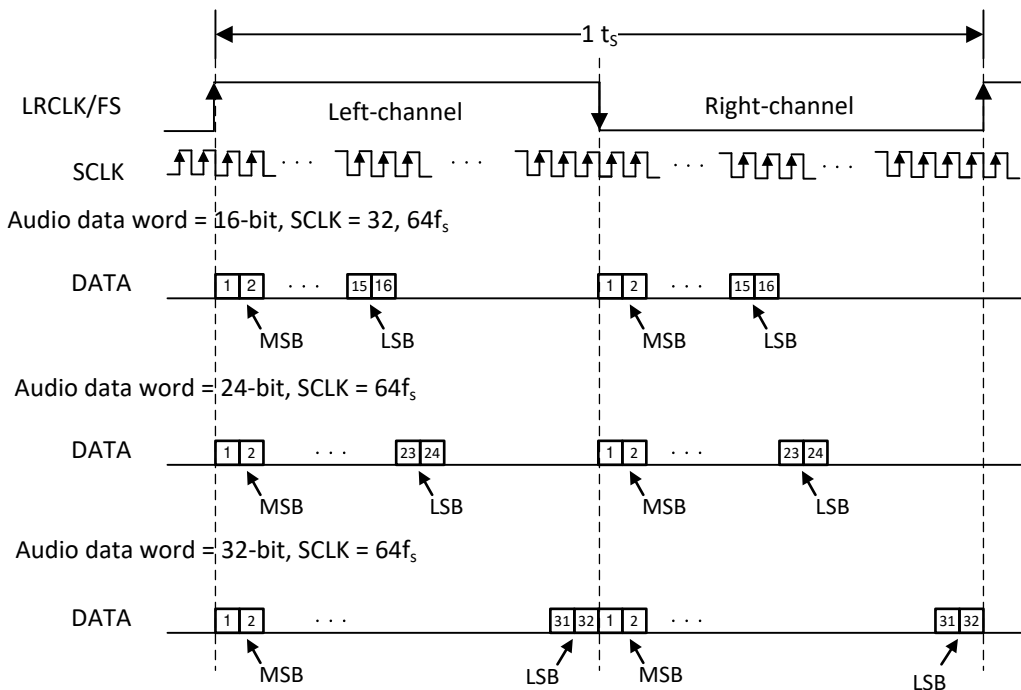
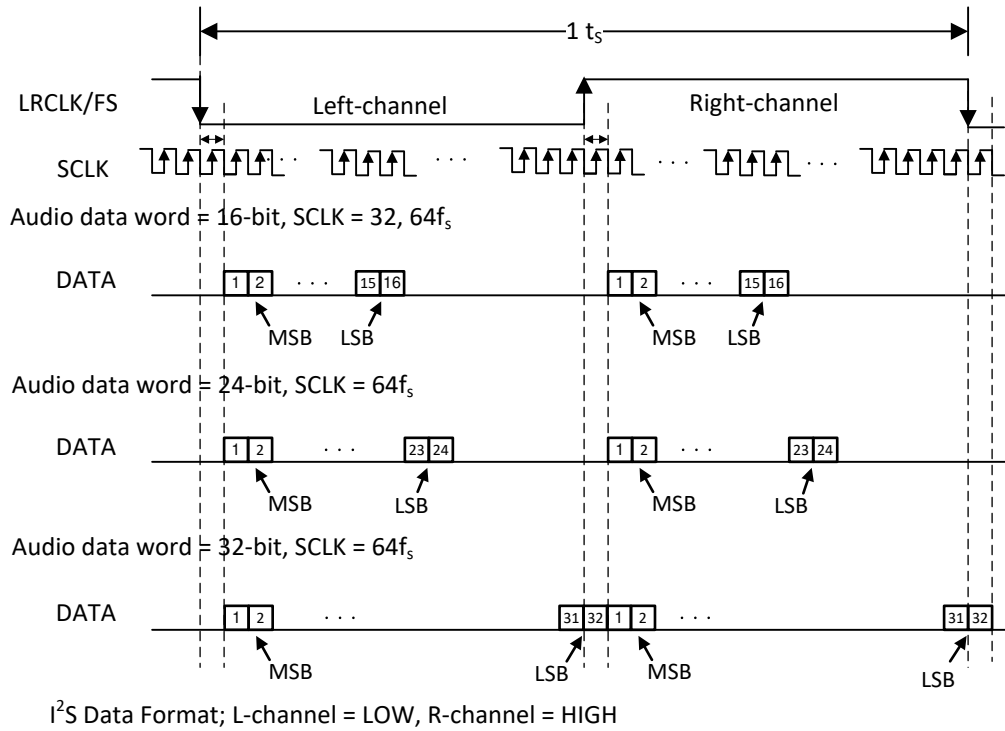
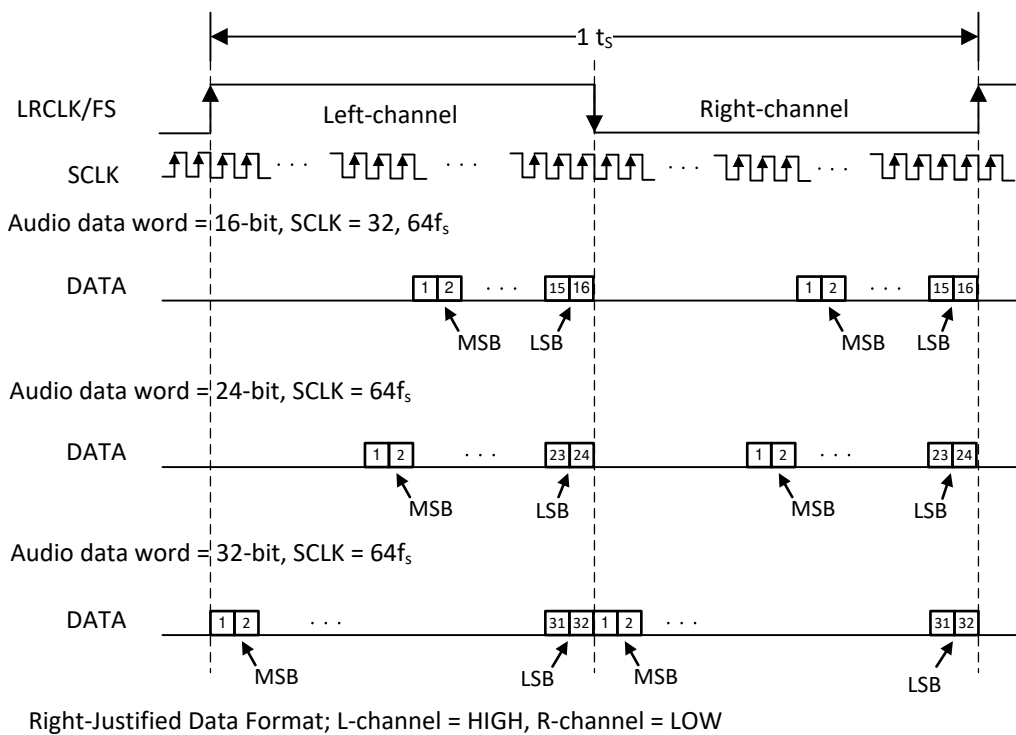

Figure 7-2. Left-Justified Audio Data Format



I²S Data Format; L-channel = LOW, R-channel = HIGH

Figure 7-3. I²S Audio Data Format



Right-Justified Data Format; L-channel = HIGH, R-channel = LOW

Figure 7-4. Right-Justified Audio Data Format

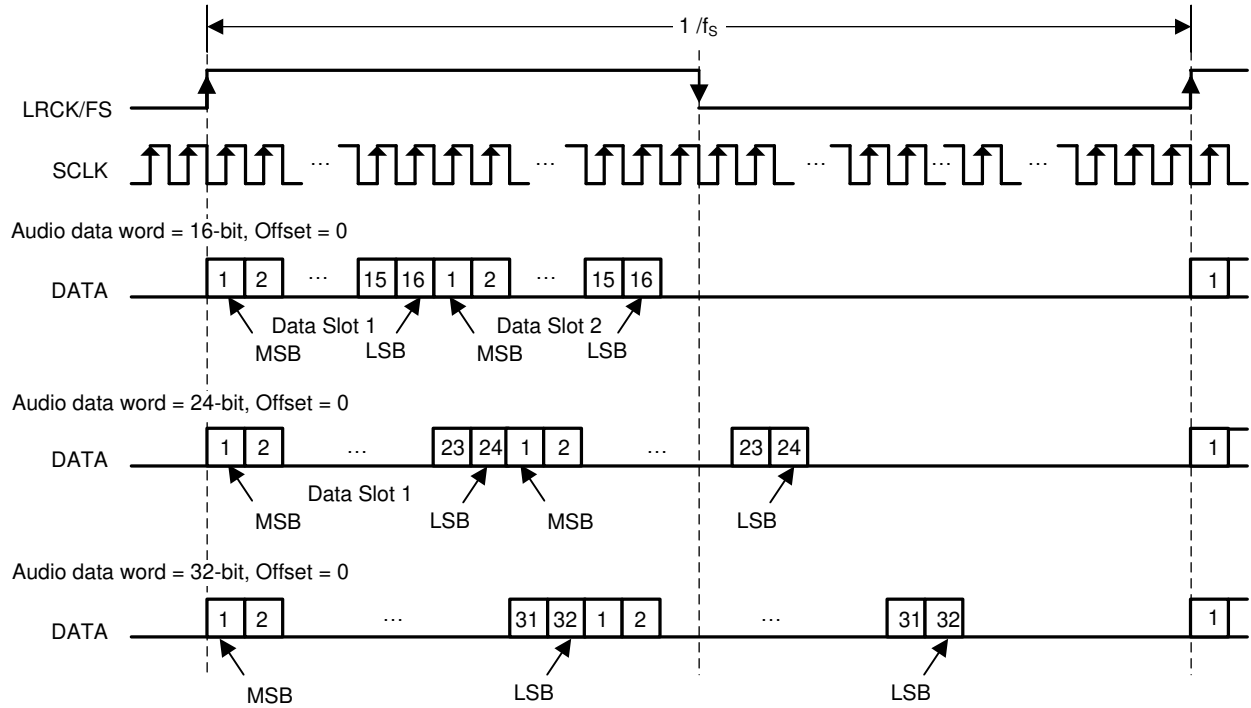

TDM Data Format with OFFSET = 0

In TDM Modes, Duty Cycle of LRCK/FS should be 1x SCLK at minimum. Rising edge is considered frame start.

Figure 7-5. TDM 1 Audio Data Format

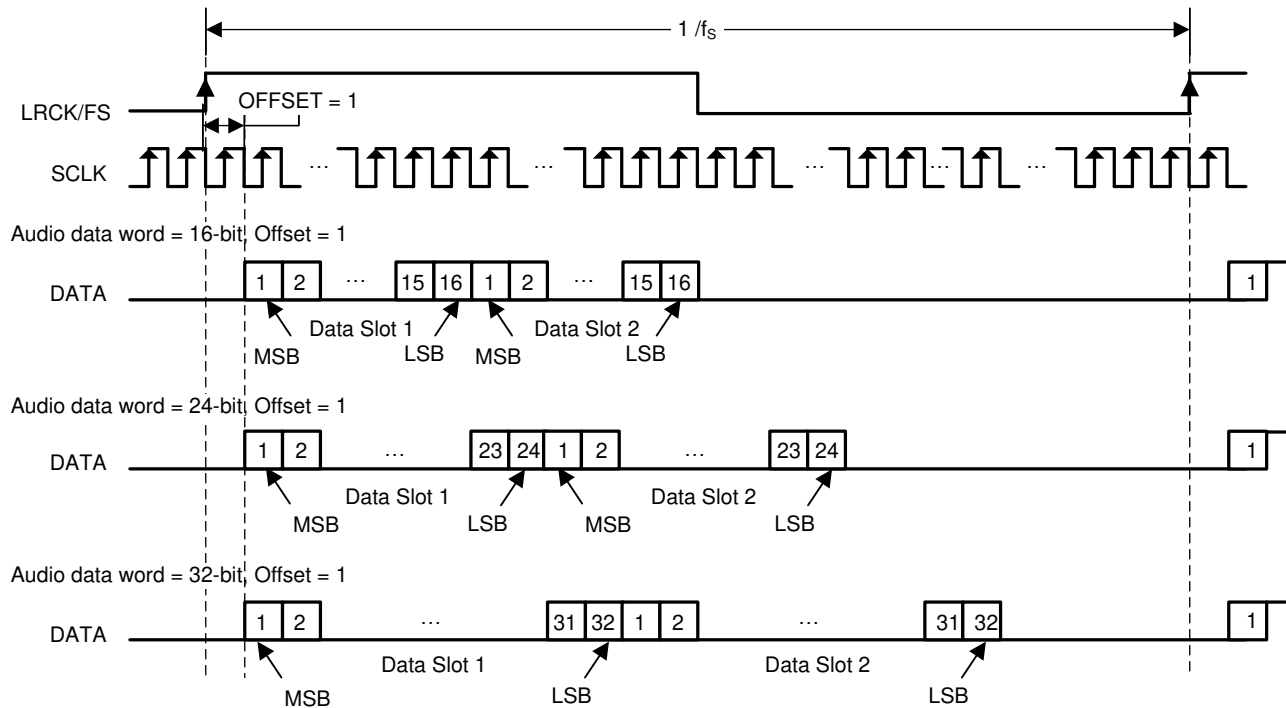

TDM Data Format with OFFSET = 1

In TDM Modes, Duty Cycle of LRCK/FS should be 1x SCLK at minimum. Rising edge is considered frame start.

Figure 7-6. TDM 2 Audio Data Format

7.3.7 Digital Audio Processing

TAS5805M DSP has advanced process flows for different applications, refer to application note, [TAS5805 Process Flows](#) for details or request the PPC3 access for TAS5805M app .

7.3.8 Class D Audio Amplifier

Following the digital clipper, the interpolated audio data is next sent to the closed-Loop Class-D amplifier, whose first stage is Digital to PWM Conversion (DPC) block. In this block, the stereo audio data is translated into two pairs of complimentary pulse-width- modulated (PWM) signals which are used to drive the outputs of the speaker amplifier. Feedback loops around the DPC ensure constant gain across supply voltages, reducing distortion and improving immunity to the power supply noise. The analog gain is also applied in the Class-D amplifier section of the device.

7.3.8.1 Speaker Amplifier Gain Select

A combination of digital gain and analog gain is used to provide the overall gain of the speaker amplifier. As seen in [Figure 7-7](#), the audio path of the TAS5805M consists of a digital audio input port, a digital audio path, a digital to PWM converter (DPC), a gate driver stage, a Class-D power stage, and a feedback loop which feeds the output information back into the DPC block to correct for distortion sensed on the output pins. The total amplifier gain consists of digital gain shown in the digital audio path, and the analog gain from the input of the analog modulator to the output of the speaker amplifier power stage.

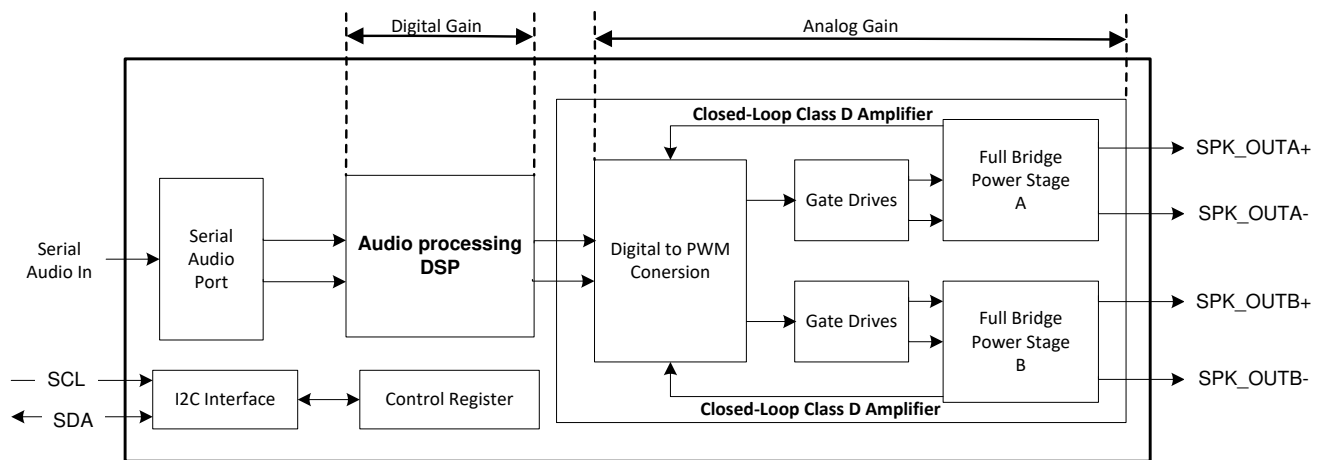

Copyright © 2018, Texas Instruments Incorporated

Figure 7-7. Speaker Amplifier Gain

As shown in [Figure 7-7](#), the first gain stage of the speaker amplifier is present in the digital audio path. Digital gain consists of the volume control, input Mixer or output Crossbar. The digital gain is set to 0dB by default. Change analog gain via register 0x54, AGAIN[4:0] which supports 32 steps analog gain setting (0.5dB per step). These analog gain settings ensure that the output signal is not clipped at different PVDD levels. 0dBFS output corresponds to 29.5-V peak output voltage.

Table 7-2. Analog Gain Setting

AGAIN <4:0>	GAIN (dBFS)	AMPLIFIER PEAK OUTPUT VOLTAGE (V)
00000	0	29.5
00001	-0.5	27.85
.....
11111	-15.5	4.95

7.3.8.2 Class D Loop Bandwidth and Switching Frequency Setting

TAS5805M closed loop structure provides Loop bandwidth setting option (Setting by register 83 -Register address 0x53h-D[6-5]) to co-work with different switching frequency (Setting by register 2 -Register address

0x02h-D[6-4]). [Table 7-3](#) shows recommended settings for the Loop Bandwidth and Switching Frequency selection. Same Fsw, Better THD+N performance with higher BW.

Table 7-3. Loop Bandwidth and Switching Frequency Setting

Modulation Scheme	Fsw	BW (Loop Band Width)	Notes
Hybrid, 1SPW	384kHz	80kHz	Principle: Fsw (Switching Frequency) $\geq 4.2 \times$ Loop Bandwidth
	480kHz	80kHz, 100kHz	
	576kHz	80kHz, 100kHz, 120kHz	
	768kHz	80kHz, 100kHz, 120kHz, 175kHz	
BD	384kHz	80kHz, 100kHz, 120kHz	Principle: Fsw (Switching Frequency) $\geq 3 \times$ Loop Bandwidth
	480kHz	80kHz, 100kHz, 120kHz	
	576kHz	80kHz, 100kHz, 120kHz, 175kHz	
	768kHz	80kHz, 100kHz, 120kHz, 175kHz	

7.4 Device Functional Modes

7.4.1 Software Control

The TAS5805M device is configured via an I²C communication port.

The I²C Communication Protocol is detailed in the I²C Communication Port section. The I²C timing requirements are described in the I²C Bus Timing – Standard and I²C Bus Timing – Fast sections.

7.4.2 Speaker Amplifier Operating Modes

The TAS5805M device can be used in two different amplifier configurations:

- BTL Mode
- PBTL Mode

7.4.2.1 BTL Mode

In BTL mode, the TAS5805M amplifies two independent signals, which represent the left and right portions of a stereo signal. The amplified left signal is presented on differential output pair shown as OUT_A+ and OUT_A-, the amplified right signal is presented on differential output pair shown as OUT_B+ and OUT_B-.

7.4.2.2 PBTL Mode

The PBTL mode of operation is used to describe operation in which the two outputs of the device are placed in parallel with one another to increase the power sourcing capabilities of the device. On the output side of the TAS5805M device, the summation of the devices can be done before the filter in a configuration called Pre-Filter Parallel Bridge Tied Load (PBTL). However, the two outputs can be required to merge together after the inductor portion of the output filter. Doing so does require two additional inductors, but allows for smaller, less-expensive inductors to be used because the current is divided between the two inductors. The process is called Post-Filter PBTL. On the input side of the TAS5805M device, the input signal to the PBTL amplifier is left frame of I2S or TDM data.

7.4.3 Low EMI Modes

TAS5805M employs several modes to minimize EMI during playing audio, and they can be used based on different applications.

7.4.3.1 Spread Spectrum

Spread spectrum is used in some inductor free case to minimize EMI noise. The TAS5805M supports Spread Spectrum with triangle mode.

User needs to configure register SS_CTRL0 (0x6B) to enable Spread Spectrum with triangle mode, and select spread spectrum frequency and range with SS_CTRL1 (0x6C). For 384kHz F_{SW} which configured by DEVICE_CTRL1 (0x02), the Spread Spectrum frequency and range are described in [Table 7-4](#)

Table 7-4. Triangle Mode Spread Spectrum Frequency and Range Selection

SS_TRI_CTRL[3:0]	0	1	2	3	4	5	6	7
Triangle Freq	24k				48k			
Spread Spectrum Range	5%	10%	20%	25%	5%	10%	20%	25%

User Application example-Central Switching Frequency is 384kHz, Triangle Frequency is 24kHz:

```
w 58 6b 03 //Enable Spread Spectrum
```

```
w 58 6c 03 //SS_TRI_CTRL[3:0]0011, Triangle Frequency = 24kHz, Spread Spectrum Range should be 25% (336kHz~432kHz)
```

7.4.3.2 Channel to Channel Phase Shift

This device supports channel to channel 180-degree PWM phase shift to minimize the EMI.

7.4.3.3 Multi-Devices PWM Phase Synchronization

This device supports up to 4 phases selection for the multi devices application system. For example, when a system integrated 4 pieces of TAS5805M devices, user can select phase 0/1/2/3 for each device with register PHASE_CTRL (0x6A), which means there is a 45-degree phase shift between each device to minimize the EMI.

Recommend to do the Phase Synchronization with I²S clock during the Startup Phase:

1. Halt I²S clock.
2. Configure each device phase selection and enable the phase synchronization. For example: Register 0x6A = 0x03 for device 0; Register 0x6A = 0x07 for device 1; Register 0x6A = 0x0B for device 2; Register 0x6A = 0x0F for device 3. There should be a 45-degree PWM phase shift between each device to minimize the EMI.
3. Configure each device into Hi-Z mode.
4. Provide I²S to each device. Phase synchronization for all 4 devices will be automatically done by internal sequence.
5. Initialize the DSP code. (This step can be skipped if only need to do the PWM Phase Synchronization).
6. Device to Device PWM phase shift should be fixed with 45 degree.

7.4.4 Thermal Foldback

The Thermal Foldback (TFB), is designed to protect TAS5805M from excessive die temperature increases, in case the device operates beyond the recommended temperature/power limit, or with a weaker thermal system design than recommended. It allows the TAS5805M to play as loud as possible without triggering unexpected thermal shutdown. When the die temperature triggers the over-temperature warning (OTW) level (135C typ), an internal AGL (Automatic Gain Limiter) will reduce the digital gain automatically. Once the die temperature drops below the OTW, the device's digital gain gradually returns to the former setting. Both the attenuation gain and adjustable rate are programmable. The TFB gain regulation speed (attack rate and release rate) settings are the same as a regular AGL, which is also configurable with TAS5805M App in PurePath™ Console3.

7.4.5 Device State Control

TAS5805M has 5 states with different power dissipation which listed in the *Electrical Characteristics* Table.

- Shutdown Mode. With $\overline{\text{PDN}}$ pin pull down to GND. All internal LDOs (1.5V for digital core, 5V for analog) are disabled, all registers will be cleared to default value.

Note

Exit from Shutdown Mode and re-enter into Play mode, need reload all register configurations (which generated by PurePath Console3) again.

- Deep Sleep Mode. Register 0x03h -D[1:0]=00, device stays in Deep Sleep Mode. In this mode, I2C block and 1.5V LDO for digital core still working, but internal 5V LDO (For AVDD and MOSFET gate driver) is disabled for low power dissipation. This mode can be used to extend the battery life in some portable speaker applications. If the host processor stops playing audio for a long time, TAS5805M can be set to Deep Sleep Mode to minimize power dissipation until host processor starts playing audio again. Unlike the Shutdown Mode (Pulling $\overline{\text{PDN}}$ Low), entering or exiting Deep Sleep Mode, the DSP keeps active.

Note

As in Deep Sleep Mode, the internal 5V LDO (For AVDD and internal MOSFET gate driver) is disabled. Exit from Deep Sleep Mode (Register 0x03h -D[1:0]=00) and re-enter into Play mode (Register 0x03h -D[1:0]=11), Below sequence is required for internal Finite-state machine fast setting (Take TAS5805M I²C device address = 0x58 as example).

w 58 00 00 #Go to page 0

w 58 7f 00 #Change the book to 0x00

w 58 03 02 #Change the device into Hiz Mode

w 58 03 00 #Change the device into Deep Sleep Mode

w 58 00 00 #Go to page 0

w 58 7f 00 #Change the book to 0x00

w 58 03 02 #Change the device into Hiz Mode

w 58 03 03 #Change the device into Play Mode

- Sleep Mode. Register 0x03h -D[1:0]=01, device stays in Sleep Mode. In this mode, I²C block, Digital core, DSP Memory , 5V Analog LDO are stilling working. Unlike the Shutdown Mode (Pull P_{DN} Low), enter or exit Sleep Mode, DSP is kept active. Exit from this mode and re-enter into play mode, only need to set Register 0x03h -D[1:0]=11.
- Output Hiz Mode. Register 0x03h -D[1:0]=10, device stays in Hiz Mode. In this mode, only output driver is set to be Hi-Z state, all other block operate normally. Exit from this mode and re-enter into play mode, only need to set Register 0x03h -D[1:0]=11.
- Play Mode. Register 0x03h -D[1:0]=11, device stays in Play Mode.

7.4.6 Device Modulation

TAS5805M has 3 modulation schemes: BD Modulation, 1SPW modulation and Hybrid modulation. Select modulation schemes for TAS5805M with Register 0x02 [1:0]-DAMP_MOD.

7.4.6.1 BD Modulation

This is a modulation scheme that allows operation without the classic LC reconstruction filter when the amp is driving an inductive load with short speaker wires. Each output is switching from 0 volts to the supply voltage. The OUTP_x and OUTN_x are in phase with each other with no input so that there is little or no current in the speaker. The duty cycle of OUTP_x is greater than 50% and OUTN_x is less than 50% for positive output voltages. The duty cycle of OUTP_x is less than 50% and OUTN_x is greater than 50% for negative output voltages. The voltage across the load sits at 0 V throughout most of the switching period, reducing the switching current, which reduces any I²R losses in the load.

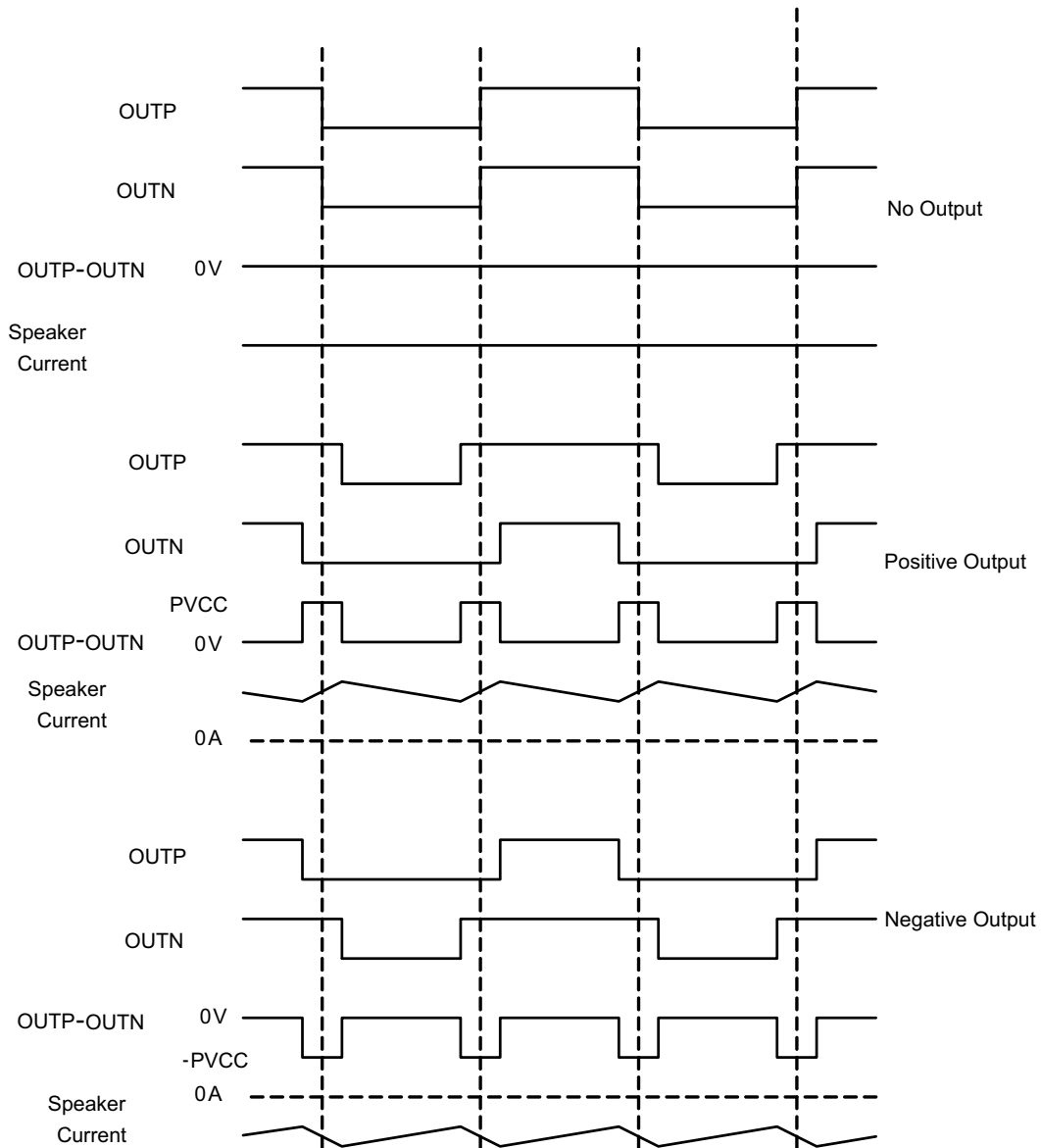

Figure 7-8. BD Mode Modulation

7.4.6.2 1SPW Modulation

The 1SPW mode alters the normal modulation scheme in order to achieve higher efficiency with a slight penalty in THD degradation and more attention required in the output filter selection. In Low Idle Current mode the outputs operate at ~14% modulation during idle conditions. When an audio signal is applied one output will decrease and one will increase. The decreasing output signal will quickly rail to GND at which point all the audio modulation takes place through the rising output. The result is that only one output is switching during a majority of the audio cycle. Efficiency is improved in this mode due to the reduction of switching losses.

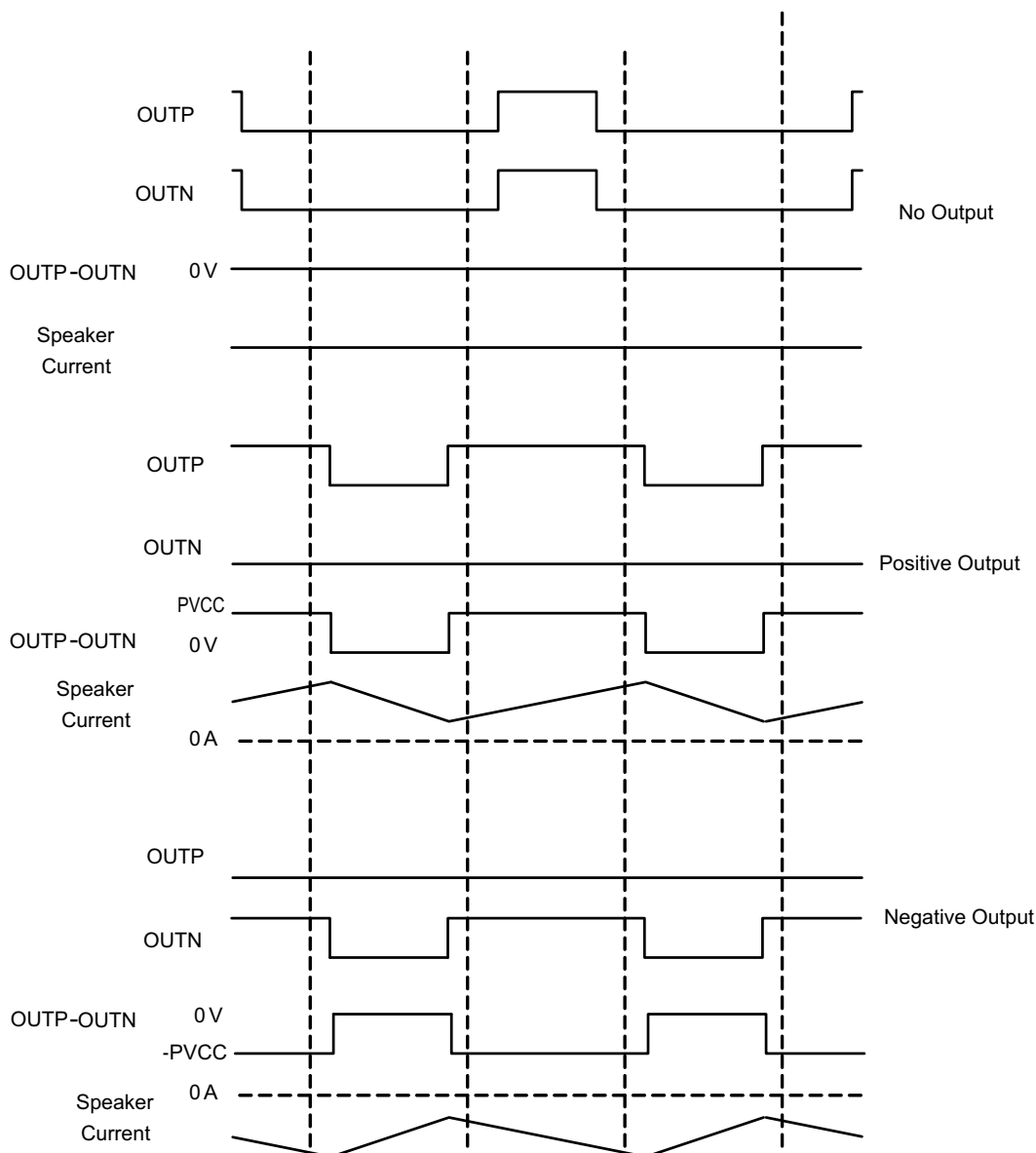

Figure 7-9. 1SPW Mode Modulation

7.4.6.3 Hybrid Modulation

Hybrid Modulation is designed to minimized power loss without compromising the THD+N performance, and is optimized for battery-powered applications. With Hybrid modulation enabled, device detects the input signal level and adjust PWM duty cycle dynamically based on PVDD. Hybrid modulation achieves ultra low idle current and maintains the same audio performance level as the BD Modulation. In order to minimize the power dissipation, low switching frequency (For example, Fsw = 384 kHz) with proper LC filter (15 μH + 0.68 μF or 22 μH + 0.68 μF) is recommended.

Note

- 1) With Hybrid Modulation, users need to input the system's PVDD value via device development App.
- 2) With Hybrid Modulation, Change device state from Deep Sleep Mode to Play Mode, specific sequence is required:
 1. Set device's PWM Modulation to BD or 1SPW mode via Register (Book0/Page0/Register0x02h, Bit [1:0]).
 2. Set device to Hi-Z state via Register (Book0/Page0/Register0x03h, Bit [1:0]).
 3. Delay 2ms.
 4. Set device's PWM Modulation to Hybrid mode via Register (Book0/Page0/Register0x02h, Bit [1:0]).
 5. Delay 15ms.
 6. Set device to Play state via Register (Book0/Page0/Register0x03h, Bit [1:0]).

7.5 Programming and Control

7.5.1 I²C Serial Communication Bus

The device has a bidirectional serial control interface that is compatible with the Inter IC (I²C) bus protocol and supports 100 and 400-kHz data transfer rates for random and sequential write and read operations as a slave device. Because the TAS5805M register map and DSP memory spans multiple pages, users should change from page to page before writing individual registers or DSP memory. Changing from page to page is accomplished by writing to register 0 on each page. Its register value selects the page address, from 0 to 255.

7.5.2 Slave Address

The TAS5805M device has 7 bits for the slave address. The first five bits (MSBs) of the slave address are factory preset to 01011(0x5x). The next two bits of address byte are the device select bits which can be user-defined by ADR pin in Table 7-5.

Table 7-5. I²C Slave Address Configuration

ADR PIN Configuration	MSBs					User Define		LSB
4.7k Ω to DVDD	0	1	0	1	1	0	0	R/ W
15kΩ to DVDD	0	1	0	1	1	0	1	R/ W
47kΩ to DVDD	0	1	0	1	1	1	0	R/ W
120kΩ to DVDD	0	1	0	1	1	1	1	R/ W

7.5.2.1 Random Write

As shown in Figure 7-10, a single-byte data-write transfer begins with the master device transmitting a start condition followed by the I²C device address and the read/write bit. The read/write bit determines the direction of the data transfer. For a write data transfer, the read/write bit is a 0. After receiving the correct I²C device address and the read/write bit, the device responds with an acknowledge bit. Next, the master transmits the address byte corresponding to the internal memory address being accessed. After receiving the address byte, the device again responds with an acknowledge bit. Next, the master device transmits the data byte to be written to the memory address being accessed. After receiving the data byte, the device again responds with an acknowledge bit. Finally, the master device transmits a stop condition to complete the single-byte data-write transfer.

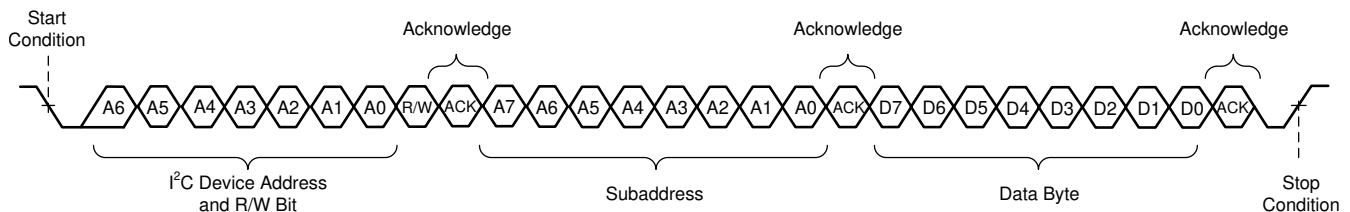

Figure 7-10. Random Write Transfer

7.5.2.2 Sequential Write

A sequential data-write transfer is identical to a single-byte data-write transfer except that multiple data bytes are transmitted by the master to the device as shown in [Figure 7-11](#). After receiving each data byte, the device responds with an acknowledge bit and the I²C subaddress is automatically incremented by one.

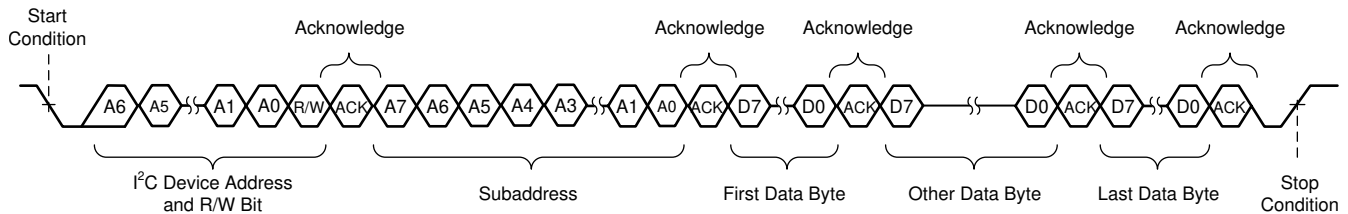

Figure 7-11. Sequential Write Transfer

7.5.2.3 Random Read

As shown in [Figure 7-12](#), a single-byte data-read transfer begins with the master device transmitting a start condition followed by the I²C device address and the read/write bit. For the data-read transfer, both a write followed by a read are actually done. Initially, a write is done to transfer the address byte of the internal memory address to be read. As a result, the read/write bit is a 0. After receiving the address and the read/write bit, the device responds with an acknowledge bit. In addition, after sending the internal memory address byte, the master device transmits another start condition followed by the address and the read/write bit again. This time the read/write bit is a 1, indicating a read transfer. After receiving the address and the read/write bit, the device again responds with an acknowledge bit. Next, the device transmits the data byte from the memory address being read. After receiving the data byte, the master device transmits a not-acknowledge followed by a stop condition to complete the single-byte data-read transfer.

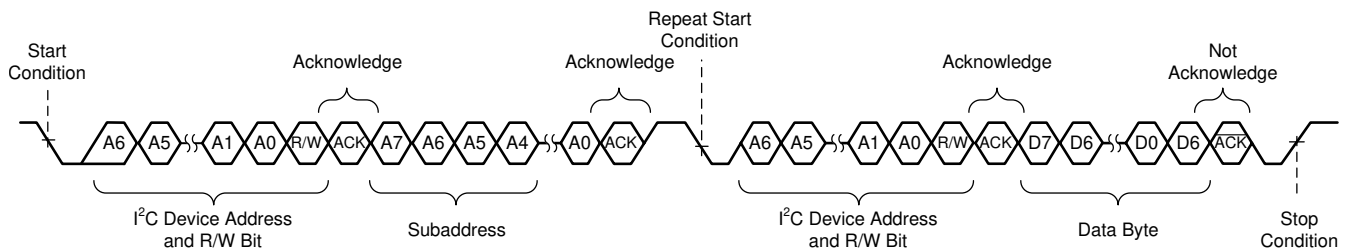

Figure 7-12. Random Read Transfer

7.5.2.4 Sequential Read

A sequential data-read transfer is identical to a single-byte data-read transfer except that multiple data bytes are transmitted by the device to the master device as shown in Figure 7-13. Except for the last data byte, the master device responds with an acknowledge bit after receiving each data byte and automatically increments the I²C sub address by one. After receiving the last data byte, the master device transmits a not-acknowledge followed by a stop condition to complete the transfer.

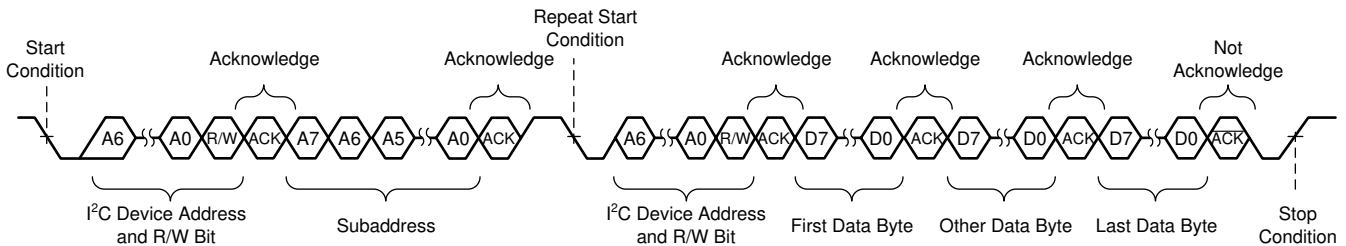

Figure 7-13. Sequential Read Transfer

7.5.2.5 DSP Memory Book, Page and BQ Coefficients Update

The TAS5805M device supports the I²C serial bus and the data transmission protocol for standard and fast mode as a slave device.

The DSP memory is arranged in books, pages, and registers. Each book has several pages and each page has several registers.

Because the TAS5805M register map spans several books and pages, the user must select the correct book and page before writing individual register bits or bytes.

To change the book, the user must be on page 0x00. In register 0x7f on page 0x00 you can change the book. On page 0x00 of each book, register 0x7f is used to change the book. Register 0x00 of each page is used to change the page. To change a book first write 0x00 to register 0x00 to switch to page 0 then write the book number to register 0x7f on page 0. To change between pages in a book, simply write the page number to register 0x00.

All the Biquad Filters coefficients are addressed in Book 0xAA. The five coefficients of every Biquad Filter should be written entirely and sequentially from the lowest address to the highest .

All DSP/Audio Process Flow Related Register are listed in Application Note, TAS5805M Process Flows

7.5.2.6 Example Use

Example 1, The following is a sample script for configuring a device on I2C slave address 0x58 and set the device switching frequency to 768kHz with Class D loop bandwidth to 175kHz, BD Modulation:

```
w 58 00 00 #Go to Page0
w 58 7f 00 #Change the Book to 0x00
w 58 00 00 #Go to Page 0x00
w 58 02 00 #Set switching frequency to 768kHz with BD Modulation
w 58 53 60 #Set Class D Loop Bandwidth to 175kHz
```

Example 2, The following is a sample script for configuring a device on I2C slave address 0x58 and using the DSP host memory to change the digital volume to the default value of 0dB:

```
w 58 00 00 #Go to Page 0
w 58 7f 8c #Change the Book to 0x8C
w 58 00 2a #Go to Page 0x2a
w 58 24 00 80 00 00 #change digital volume to 0dB
```

7.5.2.7 Checksum

This device supports two different check sum schemes, a cyclic redundancy check (CRC) checksum and an Exclusive (XOR) checksum. Register reads do not change checksum, but writes to even nonexistent registers will change the checksum. Both checksums are 8-bit checksums and both are available together simultaneously. The checksums can be reset by writing a starting value (eg. 0x 00 00 00 00) to their respective 4-byte register locations.

7.5.2.7.1 Cyclic Redundancy Check (CRC) Checksum

The 8-bit CRC checksum used is the 0x7 polynomial (CRC-8-CCITT I.432.1; ATM HEC, ISDN HEC and cell delineation, $(1 + x^1 + x^2 + x^8)$). A major advantage of the CRC checksum is that it is input order sensitive. The CRC supports all I²C transactions, excluding book and page switching. The CRC checksum is read from register 0x7E on page0 of any book (B_x, Page_0, Reg_126). The CRC checksum can be reset by writing 0x00 to the same register locations where the CRC checksum is valid.

7.5.2.7.2 Exclusive or (XOR) Checksum

The Xor checksum is a simpler checksum scheme. It performs sequential XOR of each register byte write with the previous 8-bit checksum register value. XOR supports only Book 0x8C, and excludes page switching and all registers in Page 0x00 of Book 0x8C. XOR checksum is read from location register 0x7D on page 0x00 of book 0x8C (B_140, Page_0, Reg_125). The XOR Checksum can be reset by writing 0x00 to the same register location where it is read.

7.5.3 Control via Software

- Startup Procedures
- Shutdown Procedures

7.5.3.1 Startup Procedures

1. Configure ADR/ $\overline{\text{FAULT}}$ pin with proper settings for I²C device address.
2. Bring up power supplies (it does not matter if PVDD or DVDD comes up first).
3. Once power supplies are stable, bring up $\overline{\text{PDN}}$ to High and wait 5ms at least, then start SCLK, LRCLK.
4. Once I²S clocks are stable, set the device into HiZ state and enable DSP via the I²C control port.
5. Wait 5ms at least. Then initialize the DSP Coefficient, then set the device to Play state.
6. The device is now in normal operation.

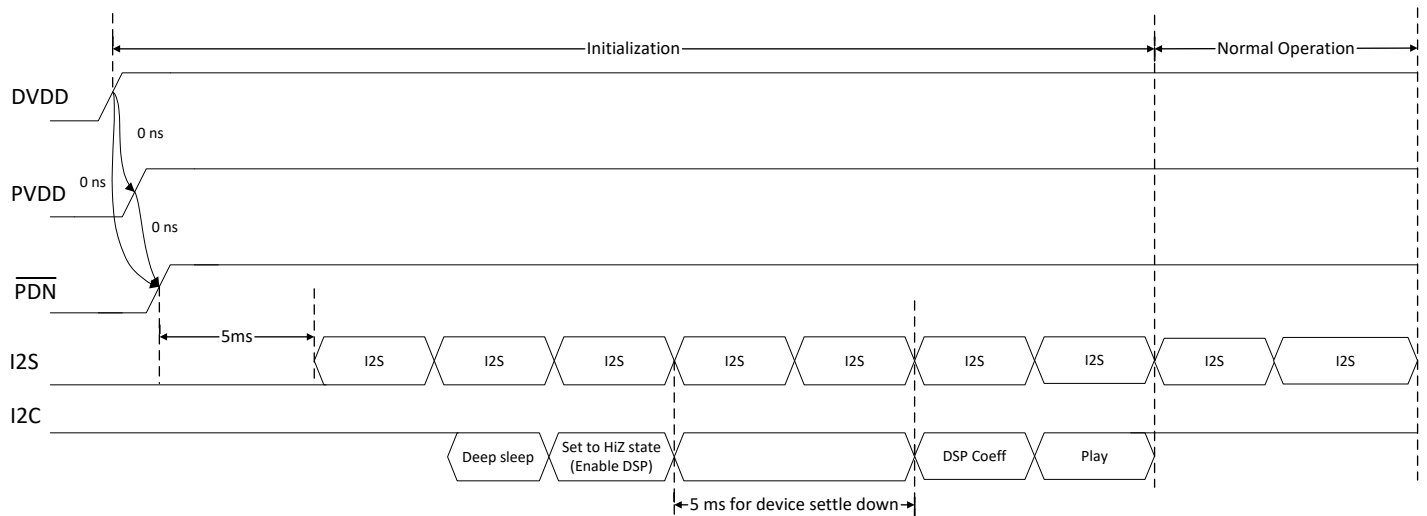
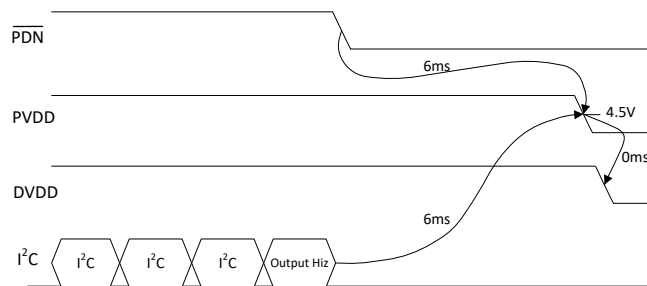

Figure 7-14. Start-up Sequence

7.5.3.2 Shutdown Procedures

1. The device is in normal operation.
2. Configure the Register 0x03h -D[1:0]= 10 (HiZ) via the I²C control port or Pull $\overline{\text{PDN}}$ low.
3. Wait at least 6ms (this time depends on the LRCLK rate ,digital volume and digital volume ramp down rate).
4. Bring down power supplies.
5. The device is now fully shut down and powered off.



- Before PVDD/DVDD power down, Class D Output driver needs to be disabled by $\overline{\text{PDN}}$ or by I²C.
- At least 6ms delay needed based on LRCLK (Fs) = 48kHz, Digital volume ramp down update every sample period, decreased by 0.5dB for each update, digital volume = 24dB. Change the value of register 0x4C and 0x4E or change the LRCLK rate, the delay changes.

Figure 7-15. Power-Down Sequence

7.5.3.3 Protection and Monitoring

7.5.3.3.1 Overcurrent Shutdown (OCSD)

Under severe short-circuit event, such as a short to PVDD or ground, the device uses a peak-current detector, and the affected channel shuts down in < 100 ns if the peak current are big enough. The shutdown speed depends on a number of factors, such as the impedance of the short circuit, supply voltage, and switching frequency. The user may restart the affected channel via I²C. An OCSD event activates the fault pin, and the I²C fault register saves a record. If the supply or ground short is strong enough to exceed the peak current threshold but not severe enough to trigger the OSCD, the peak current limiter prevents excess current from damaging the output FETs, and operation returns to normal after the short is removed.

7.5.3.3.2 Speaker DC Protection

If the device measures a >1.9 V (Typical) DC offset and continue more than 570 ms (typical) on the output stage, the ADR/ $\overline{\text{FAULT}}$ line will be pulled low and set the OUTxx outputs to Hi-Z state to protect speaker, signifying a fault in [Register 0x70](#) in Book0/Page0. This fault report bit in [Register 0x70](#) keeps 1 and device keeps in Hi-Z mode unless clear it by [Register 0x78](#) in Book0/Page0 manually.

7.5.3.3.3 Device Over Temperature Protection

Once the die temperature exceed 160°C (Typical), device will set the output driver from Play mode to Hi-Z Mode. Over temperature shutdown fault reported by [Register 0x72](#) in Book0/Page0. Set this fault's behavior to Auto-recovery mode, device will come back to play mode automatically once the die temperature drop down to 150°C or device needs re-enter into play mode by clearing fault with [Register 0x78](#) in Book0/Page0.

7.5.3.3.4 Device Over Voltage/Under Voltage Protection

7.5.3.3.4.1 Over Voltage Protection

Once the PVDD voltage exceed the $OV_{\text{THRES(PVDD)}}$ (28.1 V Typical), device will set the output driver from Play mode to Hi-Z mode. Over voltage fault reported by [Register 0x71](#) in Book0/Page0. Once PVDD drop below 27.5 V (Typical), device will come back to Play mode. But this bit still keeps 1 unless clear it by [Register 0x78](#) in Book0/Page0 manually.

7.5.3.3.4.2 Under Voltage Protection

Once the PVDD voltage drop below the $UV_{\text{THRES(PVDD)}}$ (4 V Typical), device will set the output driver from Play mode to Hi-Z mode. Under voltage fault reported by [Register 0x71](#) in Book0/Page0. Once PVDD rise above 4.25 V (Typical), device will come back to Play mode. But this bit still keeps 1 unless clear it by [Register 0x78](#) in Book0/Page0 manually.

7.5.3.3.5 Clock Fault

Once there has any Clock error occurs (Clock Halt, SCLK/LRCLK Ratio Error, Pll unlock, FS error) , [Register 0x37](#) and [Register 0x39](#) monitor these errors and real-time report with details, device will enter into Hi-Z mode. Clock Fault reported in [Register 0x71](#) in Book0/Page0. Once the clock error been removed, device will come back to play mode automatically. But this bit still keeps 1 unless clear it by [Register 0x78](#) in Book0/Page0 manually.

7.6 Register Maps

7.6.1 CONTROL PORT Registers

Table 7-6 lists the memory-mapped registers for the CONTROL PORT. All register offset addresses not listed in Table 7-6 should be considered as reserved locations and the register contents should not be modified.

Table 7-6. CONTROL PORT Registers

Offset	Acronym	Register Name	Section
1h	RESET_CTRL	Register 1	Go
2h	DEVICE_CTRL_1	Register 2	Go
3h	DEVICE_CTRL_2	Register 3	Go
Fh	I2C_PAGE_AUTO_INC	Register 15	Go
28h	SIG_CH_CTRL	Register 40	Go
29h	CLOCK_DET_CTRL	Register 41	Go
30h	SDOUT_SEL	Register 48	Go
31h	I2S_CTRL	Register 49	Go
33h	SAP_CTRL1	Register 51	Go
34h	SAP_CTRL2	Register 52	Go
35h	SAP_CTRL3	Register 53	Go
37h	FS_MON	Register 55	Go
38h	BCK_MON	Register 56	Go
39h	CLKDET_STATUS	Register 57	Go
4Ch	DIG_VOL_CTRL	Register 76	Go
4Eh	DIG_VOL_CTRL2	Register 78	Go
4Fh	DIG_VOL_CTRL3	Register 79	Go
50h	AUTO_MUTE_CTRL	Register 80	Go
51h	AUTO_MUTE_TIME	Register 81	Go
53h	ANA_CTRL	Register 83	Go
54h	AGAIN	Register 84	Go
5Ch	BQ_WR_CTRL1	Register 92	Go
5Dh	DAC_CTRL	Register 93	Go
60h	ADR_PIN_CTRL	Register 96	Go
61h	ADR_PIN_CONFIG	Register 97	Go
66h	DSP_MISC	Register 102	Go
67h	DIE_ID	Register 103	Go
68h	POWER_STATE	Register 104	Go
69h	AUTOMUTE_STATE	Register 105	Go
6Ah	PHASE_CTRL	Register 106	Go
6Bh	SS_CTRL0	Register 107	Go
6Ch	SS_CTRL1	Register 108	Go
6Dh	SS_CTRL2	Register 109	Go
6Eh	SS_CTRL3	Register 110	Go
6Fh	SS_CTRL4	Register 111	Go
70h	CHAN_FAULT	Register 112	Go
71h	GLOBAL_FAULT1	Register 113	Go
72h	GLOBAL_FAULT2	Register 114	Go
73h	OT WARNING	Register 115	Go
74h	PIN_CONTROL1	Register 116	Go
75h	PIN_CONTROL2	Register 117	Go

Table 7-6. CONTROL PORT Registers (continued)

Offset	Acronym	Register Name	Section
76h	MISC_CONTROL	Register 118	Go
78h	FAULT_CLEAR	Register 120	Go

Complex bit access types are encoded to fit into small table cells. [Table 7-7](#) shows the codes that are used for access types in this section.

Table 7-7. CONTROL PORT Access Type Codes

Access Type	Code	Description
Read Type		
R	R	Read
Write Type		
W	W	Write
Reset or Default Value		
-n		Value after reset or the default value

7.6.1.1 RESET_CTRL Register (Offset = 1h) [reset = 0x00]

RESET_CTRL is shown in [Figure 7-12](#) and described in [Table 7-8](#).

Return to [Summary Table](#).

Figure 7-12. RESET_CTRL Register

7	6	5	4	3	2	1	0
RESERVED			RST_MOD	RESERVED			RST_REG
R/W			W	R			W

Table 7-8. RESET_CTRL Register Field Descriptions

Bit	Field	Type	Reset	Description
7-5	RESERVED	R/W	000	This bit is reserved
4	RST_MOD	W	0	WRITE CLEAR BIT Reset Modules WRITE CLEAR BIT Reset full digital core This bit resets full digital signal chain (Include DSP and Control Port Registers). Since the DSP is also reset, the coefficient RAM content will also be cleared by the DSP. 0: Normal 1: Reset modules
3-1	RESERVED	R	000	This bit is reserved
0	RST_CONTROL_REG	W	0	WRITE CLEAR BIT Reset Registers This bit resets the control port registers back to their initial values. The RAM content is not cleared. 0: Normal 1: Reset control port registers

7.6.1.2 DEVICE_CTRL_1 Register (Offset = 2h) [reset = 0x00]

DEVICE_CTRL_1 is shown in [Figure 7-13](#) and described in [Table 7-9](#).

Return to [Summary Table](#).

Figure 7-13. DEVICE_CTRL_1 Register

7	6	5	4	3	2	1	0
RESERVED	FSW_SEL			RESERVED	DAMP_PBTL	DAMP_MOD	
R/W	R/W			R/W	R/W	R/W	

Table 7-9. DEVICE_CTRL_1 Register Field Descriptions

Bit	Field	Type	Reset	Description
7	RESERVED	R/W	0	This bit is reserved
6-4	FSW_SEL	R/W	000	SELECT FSW 000:768K 001:384K 011:480K 100:576K 010:Reserved 101:Reserved 110:Reserved 111:Reserved
3	RESERVED	R/W	0	This bit is reserved
2	DAMP_PBTL	R/W	0	0: SET DAMP TO BTL MODE 1: SET DAMP TO PBTL MODE
1-0	DAMP_MOD	R/W	00	00:BD MODE 01:1SPW MODE 10:HYBRID MODE

7.6.1.3 DEVICE_CTRL_2 Register (Offset = 3h) [reset = 0x10]

DEVICE_CTRL_2 is shown in [Figure 7-14](#) and described in [Table 7-10](#).

Return to [Summary Table](#).

Figure 7-14. DEVICE_CTRL_2 Register

7	6	5	4	3	2	1	0
RESERVED			DIS_DSP	MUTE	RESERVED	CTRL_STATE	
R/W			R/W	R/W	R/W	R/W	

Table 7-10. DEVICE_CTRL_2 Register Field Descriptions

Bit	Field	Type	Reset	Description
7-5	RESERVED	R/W	000	This bit is reserved
4	DIS_DSP	R/W	1	DSP reset When the bit is made 0, DSP will start powering up and send out data. This needs to be made 0 only after all the input clocks are settled so that DMA channels do not go out of sync. 0: Normal operation 1: Reset the DSP
3	MUTE	R/W	0	Mute Both Left /Right Channel This bit issues soft mute request for the left/right channel. The volume will be smoothly ramped down/up to avoid pop/click noise. 0: Normal volume 1: Mute
2	RESERVED	R/W	0	This bit is reserved
1-0	CTRL_STATE	R/W	00	Device state control register 00: Deep Sleep 01: Sleep 10: Hi-Z, 11: PLAY

7.6.1.4 I2C_PAGE_AUTO_INC Register (Offset = Fh) [reset = 0x00]

I2C_PAGE_AUTO_INC is shown in [Figure 7-15](#) and described in [Table 7-11](#).

Return to [Summary Table](#).

Figure 7-15. I2C_PAGE_AUTO_INC Register

7	6	5	4	3	2	1	0
RESERVED				PAGE_AUTOINC_REG	RESERVED		
R/W				R/W	R/W		

Table 7-11. I2C_PAGE_AUTO_INC Register Field Descriptions

Bit	Field	Type	Reset	Description
7-4	RESERVED	R/W	0000	This bit is reserved
3	PAGE_AUTOINC_REG	R/W	0	Page auto increment disable Disable page auto increment mode. for non -zero books. When end of page is reached it goes back to 8th address location of next page when this bit is 0. When this bit is 1 it goes to 0 th location of current page itself like in older part. 0: Enable Page auto increment 1: Disable Page auto increment
2-0	RESERVED	R/W	000	This bit is reserved

7.6.1.5 SIG_CH_CTRL Register (Offset = 28h) [reset = 0x00]

SIG_CH_CTRL is shown in [Figure 7-16](#) and described in [Table 7-12](#).

Return to [Summary Table](#).

Figure 7-16. SIG_CH_CTRL Register

7	6	5	4	3	2	1	0
BCK_RATIO_CONFIGURE				FS_MODE			
R/W				R/W			

Table 7-12. SIG_CH_CTRL Register Field Descriptions

Bit	Field	Type	Reset	Description
7-4	BCK_RATIO_CONFIGURE	R/W	0000	These bits indicate the configured BCK ratio, the number of BCK clocks in one audio frame. 0011: 32FS 0101: 64FS 0111: 128FS 1001: 256FS 1011: 512FS
3-0	FS_MODE	R/W	0000	FS Speed Mode These bits select the FS operation mode, which must be set according to the current audio sampling rate. 0000: Auto detection 0010: 8KHz 0100: 16KHz 0110: 32KHz 1000: 44.1KHz 1001: 48KHz 1010: 88.2KHz 1011: 96KHz Others Reserved

7.6.1.6 CLOCK_DET_CTRL Register (Offset = 29h) [reset = 0x00]

CLOCK_DET_CTRL is shown in [Figure 7-17](#) and described in [Table 7-13](#).

Return to [Summary Table](#).

Figure 7-17. CLOCK_DET_CTRL Register

7	6	5	4	3	2	1	0
RESERVED	DIS_DET_PLL	DIS_DET_BCLK_RANGE	DIS_DET_FS	DIS_DET_BCLK	DIS_DET_MISS	RESERVED	RESERVED
R/W	R/W	R/W	R/W	R/W	R/W	R/W	R/W

Table 7-13. CLOCK_DET_CTRL Register Field Descriptions

Bit	Field	Type	Reset	Description
7	RESERVED	R/W	0	This bit is reserved
6	DIS_DET_PLL	R/W	0	Ignore PLL overrate Detection This bit controls whether to ignore the PLL overrate detection. The PLL must be slow than 150MHz or an error will be reported. When ignored, a PLL overrate error will not cause a clock error. 0: Regard PLL overrate detection 1: Ignore PLL overrate detection
5	DIS_DET_BCLK_RANGE	R/W	0	Ignore BCK Range Detection This bit controls whether to ignore the BCK range detection. The BCK must be stable between 256KHz and 50MHz or an error will be reported. When ignored, a BCK range error will not cause a clock error. 0: Regard BCK Range detection 1: Ignore BCK Range detection
4	DIS_DET_FS	R/W	0	Ignore FS Error Detection This bit controls whether to ignore the FS Error detection. When ignored, FS error will not cause a clock error. But CLKDET_STATUS will report fs error. 0: Regard FS detection 1: Ignore FS detection
3	DIS_DET_BCLK	R/W	0	Ignore BCK Detection This bit controls whether to ignore the BCK detection against LRCK. The BCK must be stable between 32FS and 512FS inclusive or an error will be reported. When ignored, a BCK error will not cause a clock error. 0: Regard BCK detection 1: Ignore BCK detection
2	DIS_DET_MISS	R/W	0	Ignore BCK Missing Detection This bit controls whether to ignore the BCK missing detection. When ignored an BCK missing will not cause a clock error. 0: Regard BCK missing detection 1: Ignore BCK missing detection
1	RESERVED	R/W	0	This bit is reserved
0	RESERVED	R/W	0	This bit is reserved

7.6.1.7 SDOUT_SEL Register (Offset = 30h) [reset = 0h]

SDOUT_SEL is shown in [Figure 7-18](#) and described in [Table 7-14](#).

Return to [Summary Table](#).

Figure 7-18. SDOUT_SEL Register

7	6	5	4	3	2	1	0
RESERVED							SDOUT_SEL
							R/W

Table 7-14. SDOUT_SEL Register Field Descriptions

Bit	Field	Type	Reset	Description
7-1	RESERVED		0	This bit is reserved
0	SDOUT_SEL	R	0	SDOUT Select. This bit selects what is being output as SDOUT pin. 0: SDOUT is the DSP output (post-processing) 1: SDOUT is the DSP input (pre-processing)

7.6.1.8 I2S_CTRL Register (Offset = 31h) [reset = 0x00]

I2S_CTRL is shown in [Figure 7-19](#) and described in [Table 7-15](#).

Return to [Summary Table](#).

Figure 7-19. I2S_CTRL Register

7	6	5	4	3	2	1	0
RESERVED		BCK_INV	RESERVED		RESERVED		RESERVED
R/W		R/W	R/W	R	R		R/W

Table 7-15. I2S_CTRL Register Field Descriptions

Bit	Field	Type	Reset	Description
7-6	RESERVED	R/W	00	This bit is reserved
5	BCK_INV	R/W	0	BCK Polarity This bit sets the inverted BCK mode. In inverted BCK mode, the DAC assumes that the LRCK and DIN edges are aligned to the rising edge of the BCK. Normally they are assumed to be aligned to the falling edge of the BCK. 0: Normal BCK mode 1: Inverted BCK mode
4-0	RESERVED	R/W	00000	This bit is reserved

7.6.1.9 SAP_CTRL1 Register (Offset = 33h) [reset = 0x02]

SAP_CTRL1 is shown in [Figure 7-20](#) and described in [Table 7-16](#).

Return to [Summary Table](#).

Figure 7-20. SAP_CTRL1 Register

7	6	5	4	3	2	1	0
I2S_SHIFT_MSB	RESERVED	DATA_FORMAT		I2S_LRCLK_PULSE		WORD_LENGTH	
R/W	R/W	R/W		R/W		R/W	

Table 7-16. SAP_CTRL1 Register Field Descriptions

Bit	Field	Type	Reset	Description
7	I2S_SHIFT_MSB	R/W	0	I2S Shift MSB
6	RESERVED	R/W	0	This bit is reserved
5-4	DATA_FORMAT	R/W	00	I2S Data Format These bits control both input and output audio interface formats for DAC operation. 00: I2S 01: TDM/DSP 10: RTJ 11: LTJ
3-2	I2S_LRCLK_PULSE	R/W	00	01: lrclk pulse < 8 SCLK. If the high width of LRCLK/FS in TDM/DSP mode is less than 8 cycles of SCK, these two bits need set to 01.
1-0	WORD_LENGTH	R/W	10	I2S Word Length These bits control both input and output audio interface sample word lengths for DAC operation. 00: 16 bits 01: 20 bits 10: 24 bits 11: 32 bits

7.6.1.10 SAP_CTRL2 Register (Offset = 34h) [reset = 0x00]

SAP_CTRL2 is shown in [Figure 7-21](#) and described in [Table 7-17](#).

Return to [Summary Table](#).

Figure 7-21. SAP_CTRL2 Register

7	6	5	4	3	2	1	0
I2S_SHIFT							
R/W							

Table 7-17. SAP_CTRL2 Register Field Descriptions

Bit	Field	Type	Reset	Description
7-0	I2S_SHIFT	R/W	00000000	I2S Shift LSB These bits control the offset of audio data in the audio frame for both input and output. The offset is defined as the number of BCK from the starting (MSB) of audio frame to the starting of the desired audio sample. 000000000: offset = 0 BCK (no offset) 000000001: offset = 1 BCK 000000010: offset = 2 BCKs and 111111111: offset = 512 BCKs

7.6.1.11 SAP_CTRL3 Register (Offset = 35h) [reset = 0x11]

SAP_CTRL3 is shown in [Figure 7-22](#) and described in [Table 7-18](#).

Return to [Summary Table](#).

Figure 7-22. SAP_CTRL3 Register

7	6	5	4	3	2	1	0
RESERVED		LEFT_DAC_DPATH		RESERVED		RIGHT_DAC_DPATH	
R/W		R/W		R/W		R/W	

Table 7-18. SAP_CTRL3 Register Field Descriptions

Bit	Field	Type	Reset	Description
7-6	RESERVED	R/W	00	This bit is reserved
5-4	LEFT_DAC_DPATH	R/W	01	Left DAC Data Path. These bits control the left channel audio data path connection. 00: Zero data (mute) 01: Left channel data 10: Right channel data 11: Reserved (do not set)
3-2	RESERVED	R/W	00	This bit is reserved
1-0	RIGHT_DAC_DPATH	R/W	01	Right DAC Data Path. These bits control the right channel audio data path connection. 00: Zero data (mute) 01: Right channel data 10: Left channel data 11: Reserved (do not set)

7.6.1.12 FS_MON Register (Offset = 37h) [reset = 0x00]

FS_MON is shown in [Figure 7-23](#) and described in [Table 7-19](#).

Return to [Summary Table](#).

Figure 7-23. FS_MON Register

7	6	5	4	3	2	1	0
RESERVED		BCLK_RATIO_HIGH			FS		
R/W		R			R		

Table 7-19. FS_MON Register Field Descriptions

Bit	Field	Type	Reset	Description
7-6	RESERVED	R/W	00	This bit is reserved
5-4	BCLK_RATIO_HIGH	R	00	2 msbs of detected BCK ratio
3-0	FS	R	0000	These bits indicate the currently detected audio sampling rate. 0000: FS Error 0010: 8KHz 0100: 16KHz 0110: 32KHz 1000: Reserved 1001: 48KHz 1011: 96KHz Others Reserved

7.6.1.13 BCK_MON Register (Offset = 38h) [reset = 0x00]

BCK_MON is shown in [Figure 7-24](#) and described in [Table 7-20](#).

Return to [Summary Table](#).

Figure 7-24. BCK_MON Register

7	6	5	4	3	2	1	0
BCLK_RATIO_LOW							
R							

Table 7-20. BCK_MON Register Field Descriptions

Bit	Field	Type	Reset	Description
7-0	BCLK_RATIO_LOW	R	00000000	These bits indicate the currently detected BCK ratio, the number of BCK clocks in one audio frame. BCK = 32 FS~512 FS

7.6.1.14 CLKDET_STATUS Register (Offset = 39h) [reset = 0x00]

CLKDET_STATUS is shown in [Figure 7-25](#) and described in [Table 7-21](#).

Return to [Summary Table](#).

Figure 7-25. CLKDET_STATUS Register

7	6	5	4	3	2	1	0
RESERVED			DET_STATUS				
R/W			R				

Table 7-21. CLKDET_STATUS Register Field Descriptions

Bit	Field	Type	Reset	Description
7-6	RESERVED	R/W	00	This bit is reserved
5	DET_STATUS	R	0	This bit indicates whether the BCLK is overrate or underrate
4	DET_STATUS	R	0	This bit indicates whether the PLL is overrate
3	DET_STATUS	R	0	This bit indicates whether the PLL is locked or not. The PLL will be reported as unlocked when it is disabled.
2	DET_STATUS	R	0	This bit indicates whether the BCK is missing or not.
1	DET_STATUS	R	0	This bit indicates whether the BCK is valid or not. The BCK ratio must be stable and in the range of 32-512FS to be valid.
0	DET_STATUS	R	0	In auto detection mode(reg_fsmode=0),this bit indicated whether the audio sampling rate is valid or not. In non auto detection mode(reg_fsmode!=0), Fs error indicates that configured fs is different with detected fs. Even FS Error Detection Ignore is set, this flag will be also asserted.

7.6.1.15 DIG_VOL_CTL Register (Offset = 4Ch) [reset = 30h]

DIG_VOL_CTL is shown in [Figure 7-26](#) and described in [Table 7-22](#).

Return to [Summary Table](#).

Figure 7-26. DIG_VOL_CTL Register

7	6	5	4	3	2	1	0
PGA							
R/W							

Table 7-22. DIG_VOL_CTR Register Field Descriptions

Bit	Field	Type	Reset	Description
7-0	PGA	R/W	00110000	Digital Volume These bits control both left and right channel digital volume. The digital volume is 24 dB to -103 dB in -0.5 dB step. 00000000: +24.0 dB 00000001: +23.5 dB and 00101111: +0.5 dB 00110000: 0.0 dB 00110001: -0.5 dB 11111110: -103 dB 11111111: Mute

7.6.1.16 DIG_VOL_CTRL2 Register (Offset = 4Eh) [reset = 0x33]

DIG_VOL_CTRL2 is shown in [Figure 7-27](#) and described in [Table 7-23](#).

Return to [Summary Table](#).

Figure 7-27. DIG_VOL_CTRL2 Register

7	6	5	4	3	2	1	0
PGA_RAMP_DOWN_SPEED		PGA_RAMP_DOWN_STEP		PGA_RAMP_UP_SPEED		PGA_RAMP_UP_STEP	
R/W		R/W		R/W		R/W	

Table 7-23. DIG_VOL_CTRL2 Register Field Descriptions

Bit	Field	Type	Reset	Description
7-6	PGA_RAMP_DOWN_SPEED	R/W	00	Digital Volume Normal Ramp Down Frequency These bits control the frequency of the digital volume updates when the volume is ramping down. 00: Update every 1 FS period 01: Update every 2 FS periods 10: Update every 4 FS periods 11: Directly set the volume to zero (Instant mute)
5-4	PGA_RAMP_DOWN_STEP	R/W	11	Digital Volume Normal Ramp Down Step These bits control the step of the digital volume updates when the volume is ramping down. 00: Decrement by 4 dB for each update 01: Decrement by 2 dB for each update 10: Decrement by 1 dB for each update 11: Decrement by 0.5 dB for each update
3-2	PGA_RAMP_UP_SPEED	R/W	00	Digital Volume Normal Ramp Up Frequency These bits control the frequency of the digital volume updates when the volume is ramping up. 00: Update every 1 FS period 01: Update every 2 FS periods 10: Update every 4 FS periods 11: Directly restore the volume (Instant unmute)
1-0	PGA_RAMP_UP_STEP	R/W	11	Digital Volume Normal Ramp Up Step These bits control the step of the digital volume updates when the volume is ramping up. 00: Increment by 4 dB for each update 01: Increment by 2 dB for each update 10: Increment by 1 dB for each update 11: Increment by 0.5 dB for each update

7.6.1.17 DIG_VOL_CTRL3 Register (Offset = 4Fh) [reset = 0x30]

DIG_VOL_CTRL3 is shown in [Figure 7-28](#) and described in [Table 7-24](#).

Return to [Summary Table](#).

Figure 7-28. DIG_VOL_CTRL3 Register

7	6	5	4	3	2	1	0
FAST_RAMP_DOWN_SPEED		FAST_RAMP_DOWN_STEP		RESERVED			
R/W		R/W		R/W			

Table 7-24. DIG_VOL_CTRL3 Register Field Descriptions

Bit	Field	Type	Reset	Description
7-6	FAST_RAMP_DOWN_SPEED	R/W	00	Digital Volume Emergency Ramp Down Frequency These bits control the frequency of the digital volume updates when the volume is ramping down due to clock error or power outage, which usually needs faster ramp down compared to normal soft mute. 00: Update every 1 FS period 01: Update every 2 FS periods 10: Update every 4 FS periods 11: Directly set the volume to zero (Instant mute)
5-4	FAST_RAMP_DOWN_STEP	R/W	11	Digital Volume Emergency Ramp Down Step These bits control the step of the digital volume updates when the volume is ramping down due to clock error or power outage, which usually needs faster ramp down compared to normal soft mute. 00: Decrement by 4 dB for each update 01: Decrement by 2 dB for each update 10: Decrement by 1 dB for each update 11: Decrement by 0.5 dB for each update
3-0	RESERVED	R/W	0000	This bit is reserved

7.6.1.18 AUTO_MUTE_CTRL Register (Offset = 50h) [reset = 0x07]

AUTO_MUTE_CTRL is shown in [Figure 7-29](#) and described in [Table 7-25](#).

Return to [Summary Table](#).

Figure 7-29. AUTO_MUTE_CTRL Register

7	6	5	4	3	2	1	0
RESERVED				REG_AUTO_MUTE_CTRL			
R/W				R/W			

Table 7-25. AUTO_MUTE_CTRL Register Field Descriptions

Bit	Field	Type	Reset	Description
7-3	RESERVED	R/W	00000	This bit is reserved
2	REG_AUTO_MUTE_CTRL	R/W	1	0: Auto mute left channel and right channel independently. 1: Auto mute left and right channels only when both channels are about to be auto muted
1	REG_AUTO_MUTE_CTRL	R/W	1	0: Disable right channel auto mute 1: Enable right channel auto mute
0	REG_AUTO_MUTE_CTRL	R/W	1	0: Disable left channel auto mute 1: Enable left channel auto mute bit2: .

7.6.1.19 AUTO_MUTE_TIME Register (Offset = 51h) [reset = 0x00]

AUTO_MUTE_TIME is shown in [Figure 7-30](#) and described in [Table 7-26](#).

Return to [Summary Table](#).

Figure 7-30. AUTO_MUTE_TIME Register

7	6	5	4	3	2	1	0
RESERVED	AUTOMUTE_TIME_LEFT			RESERVED	AUTOMUTE_TIME_RIGHT		
R/W	R/W			R/W	R/W		

Table 7-26. AUTO_MUTE_TIME Register Field Descriptions

Bit	Field	Type	Reset	Description
7	RESERVED	R/W	0	This bit is reserved
6-4	AUTOMUTE_TIME_LEFT	R/W	000	Auto Mute Time for Left Channel These bits specify the length of consecutive zero samples at left channel before the channel can be auto muted. The times shown are for 96 kHz sampling rate and will scale with other rates. 000: 11.5 ms 001: 53 ms 010: 106.5 ms 011: 266.5 ms 100: 0.535 sec 101: 1.065 sec 110: 2.665 sec 111: 5.33 sec
3	RESERVED	R/W	0	This bit is reserved
2-0	AUTOMUTE_TIME_RIGHT	R/W	000	Auto Mute Time for Right Channel These bits specify the length of consecutive zero samples at right channel before the channel can be auto muted. The times shown are for 96 kHz sampling rate and will scale with other rates. 000: 11.5 ms 001: 53 ms 010: 106.5 ms 011: 266.5 ms 100: 0.535 sec 101: 1.065 sec 110: 2.665 sec 111: 5.33 sec

7.6.1.20 ANA_CTRL Register (Offset = 53h) [reset = 0x00]

ANA_CTRL is shown in [Figure 7-31](#) and described in [Table 7-27](#).

Return to [Summary Table](#).

Figure 7-31. ANA_CTRL Register

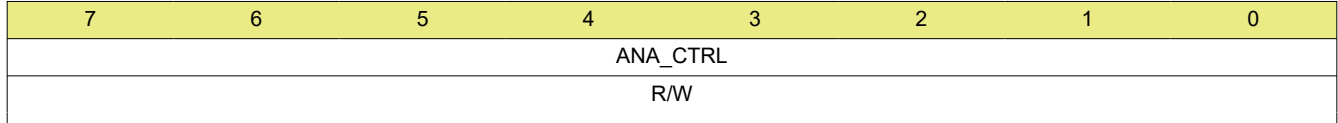

Table 7-27. ANA_CTRL Register Field Descriptions

Bit	Field	Type	Reset	Description
7	RESERVED	R/W	0	This bit is reserved
6-5	ANA_CTRL	R/W	00	Class-D bandwidth control. 00: 80kHz; 01: 100kHz; 10: 120kHz; 11: 175kHz. With Fsw=768kHz, 175kHz bandwidth should be selected for high audio performance.
4-0	RESERVED	R/W	00000	These bits are reserved

7.6.1.21 AGAIN Register (Offset = 54h) [reset = 0x00]

AGAIN is shown in [Figure 7-32](#) and described in [Table 7-28](#).

Return to [Summary Table](#).

Figure 7-32. AGAIN Register

7	6	5	4	3	2	1	0
RESERVED				ANA_GAIN			
R/W				R/W			

Table 7-28. AGAIN Register Field Descriptions

Bit	Field	Type	Reset	Description
7-5	RESERVED	R/W	000	This bit is reserved
4-0	ANA_GAIN	R/W	00000	Analog Gain Control , with 0.5dB one step This bit controls the analog gain. 00000: 0 dB (29.5V peak voltage) 00001: -0.5db 11111: -15.5 dB

7.6.1.22 BQ_WR_CTRL1 Register (Offset = 5Ch) [reset = 0x00]

BQ_WR_CTRL1 is shown in [Figure 7-33](#) and described in [Table 7-29](#).

Return to [Summary Table](#).

Figure 7-33. BQ_WR_CTRL1 Register

7	6	5	4	3	2	1	0
RESERVED							BQ_WR_FIRST_COEF
R/W							R/W

Table 7-29. BQ_WR_CTRL1 Register Field Descriptions

Bit	Field	Type	Reset	Description
7-1	RESERVED	R/W	0000000	This bit is reserved
0	BQ_WR_FIRST_COEF	R/W	0	Indicate the first coefficient of a BQ is starting to write.

7.6.1.23 DAC_CTRL Register (Offset = 5Dh) [reset = 0xF8]

DAC_CTRL is shown in [Figure 7-34](#) and described in [Table 7-30](#).

Return to [Summary Table](#).

Figure 7-34. DAC_CTRL Register

7	6	5	4	3	2	1	0
DAC_FREQUEN CY_SEL	DAC_DITHER_EN		DAC_DITHER			DAC_CTRL_DEM_SEL	
R/W	R/W		R/W			R/W	

Table 7-30. DAC_CTRL Register Field Descriptions

Bit	Field	Type	Reset	Description
7	DAC_FREQUENCY_SEL	R/W	1	DAC Frequency Select 0: 6.144MHz 1: 3.072MHz
6-5	DAC_DITHER_EN	R/W	11	DITHER_EN, 00: disable both stage dither 01: enable main stage dither 10: enable second stage dither 11: enable both stage dither
4-2	DAC_DITHER	R/W	110	Dither level 100: -2 ⁻⁷ 101: -2 ⁻⁸ 110: -2 ⁻⁹ 111: -2 ⁻¹⁰ 000: -2 ⁻¹³ 001: -2 ⁻¹⁴ 010: -2 ⁻¹⁵ 011: -2 ⁻¹⁶
1-0	DAC_CTRL_DEM_SEL	R/W	00	00: Enable DEM 11: Disable DEM

7.6.1.24 ADR_PIN_CTRL Register (Offset = 60h) [reset = 0h]

ADR_PIN_CTRL is shown in [Figure 7-35](#) and described in [Table 7-31](#).

Return to [Summary Table](#).

Figure 7-35. ADR_PIN_CTRL Register

7	6	5	4	3	2	1	0
RESERVED							ADR_OE
							R/W - 0x0

Table 7-31. ADR_PIN_CTRL Register Field Descriptions

Bit	Field	Type	Reset	Description
7-1	RESERVED	R/W	0000000	This bit is reserved
0	ADR_OE	R/W	0	ADR Output Enable This bit sets the direction of the ADR pin 0: ADR is input 1: ADR is output

7.6.1.25 ADR_PIN_CONFIG Register (Offset = 61h) [reset = 0x00]

ADR_PIN_CONFIG is shown in [Figure 7-36](#) and described in [Table 7-32](#).

Return to [Summary Table](#).

Figure 7-36. ADR_PIN_CONFIG Register

7	6	5	4	3	2	1	0
RESERVED			ADR_PIN_CONFIG				
R/W							

Table 7-32. ADR_PIN_CONFIG Register Field Descriptions

Bit	Field	Type	Reset	Description
7-5	RESERVED	R/W	000	These bits are reserved
4-0	ADR_PIN_CONFIG	R/W	00000	00000: off (low) 00011: Auto mute flag (asserted when both L and R channels are auto muted) 00100: Auto mute flag for left channel 0101: Auto mute flag for right channel 00110: Clock invalid flag (clock error or clock missing) 00111: Reserved 01001: Reserved 01011: ADR as FAULTZ output

7.6.1.26 DSP_MISC Register (Offset = 66h) [reset = 0h]

DSP_MISC is shown in [Figure 7-37](#) and described in [Table 7-33](#).

Return to [Summary Table](#).

Figure 7-37. DSP_MISC Register

7	6	5	4	3	2	1	0
BYPASS_CONTROL							
R/W							

Table 7-33. DSP_MISC Register Field Descriptions

Bit	Field	Type	Reset	Description
7-4	RESERVED	R/W	0000	These bits are reserved
3	BYPASS CONTROL	R/W	0	1: Left and Right will have use unique coef 0->Right channel will share left channel coefficient
2	BYPASS CONTROL	R/W	0	1: bypass 128 tap FIR
1	BYPASS CONTROL	R/W	0	1: bypass DRC (Only bypass DRC in L/R channel)
0	BYPASS CONTROL	R/W	0	1: bypass EQ (Only bypass EQs in L/R channel)

7.6.1.27 DIE_ID Register (Offset = 67h) [reset = 0h]

DIE_ID is shown in [Figure 7-38](#) and described in [Table 7-34](#).

Return to [Summary Table](#).

Figure 7-38. DIE_ID Register

7	6	5	4	3	2	1	0
DIE_ID							
R-0h							

Table 7-34. DIE_ID Register Field Descriptions

Bit	Field	Type	Reset	Description
7-0	DIE_ID	R	0h	DIE ID

7.6.1.28 POWER_STATE Register (Offset = 68h) [reset = 0x00]

POWER_STATE is shown in [Figure 7-39](#) and described in [Table 7-35](#).

Return to [Summary Table](#).

Figure 7-39. POWER_STATE Register

7	6	5	4	3	2	1	0
STATE_RPT							
R							

Table 7-35. POWER_STATE Register Field Descriptions

Bit	Field	Type	Reset	Description
7-0	STATE_RPT	R	00000000	0: Deep sleep 1: Sleep 2: HIZ 3: Play Others: reserved

7.6.1.29 AUTOMUTE_STATE Register (Offset = 69h) [reset = 0x00]

AUTOMUTE_STATE is shown in [Figure 7-40](#) and described in [Table 7-36](#).

Return to [Summary Table](#).

Figure 7-40. AUTOMUTE_STATE Register

7	6	5	4	3	2	1	0
RESERVED						ZERO_RIGHT_MON	ZERO_LEFT_MON
R						R	R

Table 7-36. AUTOMUTE_STATE Register Field Descriptions

Bit	Field	Type	Reset	Description
7-2	RESERVED	R	000000	This bit is reserved
1	ZERO_RIGHT_MON	R	0	This bit indicates the auto mute status for right channel. 0: Not auto muted 1: Auto muted
0	ZERO_LEFT_MON	R	0	This bit indicates the auto mute status for left channel. 0: Not auto muted 1: Auto muted

7.6.1.30 PHASE_CTRL Register (Offset = 6Ah) [reset = 0x00]

PHASE_CTRL is shown in [Figure 7-41](#) and described in [Table 7-37](#).

Return to [Summary Table](#).

Figure 7-41. PHASE_CTR Register

7	6	5	4	3	2	1	0
RESERVED				RAMP_PHASE_SEL	PHASE_SYNC_SEL	PHASE_SYNC_EN	
R/W				R/W	R/W	R/W	R/W

Table 7-37. PHASE_CTR Register Field Descriptions

Bit	Field	Type	Reset	Description
7-4	RESERVED	R/W	0000	This bit is reserved
3-2	RAMP_PHASE_SEL	R/W	00	Select ramp clock phase when multi devices integrated in one system to reduce EMI and peak supply peak current, it is recommended set all devices the same RAMP frequency and same spread spectrum. it must be set before driving device into PLAY mode if this feature is needed. 00: phase 0 01: phase1 10: phase2 11: phase3
1	I2S_SYNC_EN	R/W	0	Use I2S to synchronize output PWM phase 0: Disable 1: Enable
0	PHASE_SYNC_EN	R/W	0	0: RAMP phase sync disable 1: RAMP phase sync enable

7.6.1.31 SS_CTRL0 Register (Offset = 6Bh) [reset = 0x00]

SS_CTRL0 is shown in [Figure 7-42](#) and described in [Table 7-38](#).

Return to [Summary Table](#).

Figure 7-42. SS_CTRL0 Register

7	6	5	4	3	2	1	0
RESERVED	RESERVED	SS_PRE_DIV_SEL	SS_MANUAL_MODE	RESERVED		SS_RDM_EN	SS_TRI_EN
R/W	R/W	R/W	R/W	R/W		R/W	R/W

Table 7-38. SS_CTRL0 Register Field Descriptions

Bit	Field	Type	Reset	Description
7	RESERVED	R/W	0	This bit is reserved
6	RESERVED	R/W	0	This bit is reserved
5	SS_PRE_DIV_SEL	R/W	0	Select pll clock divide 2 as source clock in manual mode
4	SS_MANUAL_MODE	R/W	0	Set ramp ss controller to manual mode
3-2	RESERVED	R/W	0	This bit is reserved
1	SS_RDM_EN	R/W	0	Random SS enable
0	SS_TRI_EN	R/W	0	Triangle SS enable

7.6.1.32 SS_CTRL1 Register (Offset = 6Ch) [reset = 0x00]

SS_CTRL1 is shown in [Figure 7-43](#) and described in [Table 7-39](#).

Return to [Summary Table](#).

Figure 7-43. SS_CTRL1 Register

7	6	5	4	3	2	1	0
RESERVED	SS_RDM_CTRL			SS_TRI_CTRL			
R/W	R/W			R/W			

Table 7-39. SS_CTRL1 Register Field Descriptions

Bit	Field	Type	Reset	Description
7	RESERVED	R/W	0	This bit is reserved
6-4	SS_RDM_CTRL	R/W	000	Random SS range control
3-0	SS_TRI_CTRL	R/W	0000	Triangle SS frequency and range control

7.6.1.33 SS_CTRL2 Register (Offset = 6Dh) [reset = 0x50]

SS_CTRL2 is shown in [Figure 7-44](#) and described in [Table 7-40](#).

Return to [Summary Table](#).

Figure 7-44. SS_CTRL2 Register

7	6	5	4	3	2	1	0
TM_FREQ_CTRL							
R/W							

Table 7-40. SS_CTRL2 Register Field Descriptions

Bit	Field	Type	Reset	Description
7-0	TM_FREQ_CTRL	R/W	01010000	Control ramp frequency in manual mode, F=61440000/N

7.6.1.34 SS_CTRL3 Register (Offset = 6Eh) [reset = 0x11]

SS_CTRL3 is shown in [Figure 7-45](#) and described in [Table 7-41](#).

Return to [Summary Table](#).

Figure 7-45. SS_CTRL3 Register

7	6	5	4	3	2	1	0
TM_DSTEP_CTRL				TM_USTEP_CTRL			
R/W				R/W			

Table 7-41. SS_CTRL3 Register Field Descriptions

Bit	Field	Type	Reset	Description
7-4	SS_TM_DSTEP_CTRL	R/W	0001	Control triangle mode spread spectrum fall step in ramp ss manual mode
3-0	SS_TM_USTEP_CTRL	R/W	0001	Control triangle mode spread spectrum rise step in ramp ss manual mode

7.6.1.35 SS_CTRL4 Register (Offset = 6Fh) [reset = 0x24]

SS_CTRL4 is shown in [Figure 7-46](#) and described in [Table 7-42](#).

Return to [Summary Table](#).

Figure 7-46. SS_CTRL4 Register

7	6	5	4	3	2	1	0
RESERVED	TM_AMP_CTRL		SS_TM_PERIOD_BOUNDRY				
R/W	R/W		R/W				

Table 7-42. SS_CTRL4 Register Field Descriptions

Bit	Field	Type	Reset	Description
7	RESERVED	R/W	0	This bit is reserved
6-5	TM_AMP_CTRL	R/W	01	Control ramp amp ctrl in ramp ss manual model
4-0	SS_TM_PERIOD_BOUNDRY	R/W	00100	Control triangle mode spread spectrum boundary in ramp ss manual mode

7.6.1.36 CHAN_FAULT Register (Offset = 70h) [reset = 0x00]

CHAN_FAULT is shown in [Figure 7-47](#) and described in [Table 7-43](#).

Return to [Summary Table](#).

Figure 7-47. CHAN_FAULT Register

7	6	5	4	3	2	1	0
RESERVED				CH1_DC_1	CH2_DC_1	CH1_OC_I	CH2_OC_I
R				R	R	R	R

Table 7-43. CHAN_FAULT Register Field Descriptions

Bit	Field	Type	Reset	Description
7-4	RESERVED	R	0000	This bit is reserved
3	CH1_DC_1	R	0	Left channel DC fault
2	CH2_DC_1	R	0	Right channel DC fault
1	CH1_OC_I	R	0	Left channel over current fault
0	CH2_OC_I	R	0	Right channel over current fault

7.6.1.37 GLOBAL_FAULT1 Register (Offset = 71h) [reset = 0h]

GLOBAL_FAULT1 is shown in [Figure 7-48](#) and described in [Table 7-44](#).

Return to [Summary Table](#).

Figure 7-48. GLOBAL_FAULT1 Register

7	6	5	4	3	2	1	0
OTP_CRC_ER ROR	BQ_WR_ERRO R				CLK_FAULT_I	PVDD_OV_I	PVDD_UV_I
R	R				R	R	R

Table 7-44. GLOBAL_FAULT1 Register Field Descriptions

Bit	Field	Type	Reset	Description
7	OTP_CRC_ERROR	R	0h	Indicate OTP CRC check error.
6	BQ_WR_ERROR	R	0h	The recent BQ is written failed
5-3	RESERVED	R	0h	This bit is reserved
2	CLK_FAULT_I	R	0h	Clock fault
1	PVDD_OV_I	R	0h	PVDD OV fault
0	PVDD_UV_I	R	0h	PVDD UV fault

7.6.1.38 GLOBAL_FAULT2 Register (Offset = 72h) [reset = 0h]

GLOBAL_FAULT2 is shown in [Figure 7-49](#) and described in [Table 7-45](#).

Return to [Summary Table](#).

Figure 7-49. GLOBAL_FAULT2 Register

7	6	5	4	3	2	1	0
RESERVED				RESERVED		OTSD_I	
R				R		R	

Table 7-45. GLOBAL_FAULT2 Register Field Descriptions

Bit	Field	Type	Reset	Description
7-1	RESERVED	R	0000000	This bit is reserved
0	OTSD_I	R	0	Over temperature shut down fault

7.6.1.39 OT_WARNING Register (Offset = 73h) [reset = 0x00]

OT_WARNING is shown in [Figure 7-50](#) and described in [Table 7-46](#).

Return to [Summary Table](#).

Figure 7-50. OT_WARNING Register

7	6	5	4	3	2	1	0
RESERVED		RESERVED			OTW	RESERVED	
R		R			R	R	

Table 7-46. OT_WARNING Register Field Descriptions

Bit	Field	Type	Reset	Description
7-6	RESERVED	R	00	This bit is reserved
5-3	RESERVED	R	000	This bit is reserved
2	OTW	R	0	Over temperature warning ,135C
1-0	RESERVED	R	00	This bit is reserved

7.6.1.40 PIN_CONTROL1 Register (Offset = 74h) [reset = 0x00]

PIN_CONTROL1 is shown in [Figure 7-51](#) and described in [Table 7-47](#).

Return to [Summary Table](#).

Figure 7-51. PIN_CONTROL1 Register

7	6	5	4	3	2	1	0
MASK_OTSD	MASK_DVDD_ UV	MASK_DVDD_ OV	MASK_CLK_FA ULT	MASK_PVDD_ UV	MASK_PVDD_ OV	MASK_DC	MASK_OC
R/W	R/W	R/W	R/W	R/W	R/W	R/W	R/W

Table 7-47. PIN_CONTROL1 Register Field Descriptions

Bit	Field	Type	Reset	Description
7	MASK_OTSD	R/W	0	Mask OTSD fault report
6	MASK_DVDD_UV	R/W	0	Mask DVDD UV fault report
5	MASK_DVDD_OV	R/W	0	Mask DVDD OV fault report
4	MASK_CLK_FAULT	R/W	0	Mask clock fault report
3	MASK_PVDD_UV	R/W	0	Mask PVDD UV fault report
2	MASK_PVDD_OV	R/W	0	Mask PVDD OV fault report
1	MASK_DC	R/W	0	Mask DC fault report
0	MASK_OC	R/W	0	Mask OC fault report

7.6.1.41 PIN_CONTROL2 Register (Offset = 75h) [reset = 0xF8]

PIN_CONTROL2 is shown in [Figure 7-52](#) and described in [Table 7-48](#).

Return to [Summary Table](#).

Figure 7-52. PIN_CONTROL2 Register

7	6	5	4	3	2	1	0
RESERVED	RESERVED	CLKFLT_LATC H_EN	OTSD_LATCH_ EN	OTW_LATCH_ EN	MASK_OTW	RESERVED	RESERVED
		R/W	R/W	R/W	R/W		

Table 7-48. PIN_CONTROL2 Register Field Descriptions

Bit	Field	Type	Reset	Description
7-6	RESERVED	R/W	11	This bit is reserved
5	CLKFLT_LATCH_EN	R/W	1	Enable clock fault latch
4	OTSD_LATCH_EN	R/W	1	Enable OTSD fault latch
3	OTW_LATCH_EN	R/W	1	Enable OT warning latch
2	MASK_OTW	R/W	0	Mask OT warning report
1-0	RESERVED	R/W	00	This bit is reserved

7.6.1.42 MISC_CONTROL Register (Offset = 76h) [reset = 0x00]

MISC_CONTROL is shown in [Figure 7-53](#) and described in [Table 7-49](#).

Return to [Summary Table](#).

Figure 7-53. MISC_CONTROL Register

7	6	5	4	3	2	1	0
DET_STATUS_LATCH	RESERVED		OTSD_AUTO_REC_EN	RESERVED			
R/W	R/W		R/W	R/W			

Table 7-49. MISC_CONTROL Register Field Descriptions

Bit	Field	Type	Reset	Description
7	DET_STATUS_LATCH	R/W	0	1:Latch clock detection status 0:Don't latch clock detection status
6-5	RESERVED	R/W	00	This bit is reserved
4	OTSD_AUTO_REC_EN	R/W	0	OTSD auto recovery enable
3-0	RESERVED	R/W	0000	This bit is reserved

7.6.1.43 FAULT_CLEAR Register (Offset = 78h) [reset = 0x00]

FAULT_CLEAR is shown in [Figure 7-54](#) and described in [Table 7-50](#).

Return to [Summary Table](#).

Figure 7-54. FAULT_CLEAR Register

7	6	5	4	3	2	1	0
ANALOG_FAULT_CLEAR	RESERVED						
W	R/W						

Table 7-50. FAULT_CLEAR Register Field Descriptions

Bit	Field	Type	Reset	Description
7	ANALOG_FAULT_CLEAR	W	0	WRITE CLEAR BIT. Once write this bit to 1, device will clear analog fault
6-0	RESERVED	R/W	0000000	This bit is reserved

8 Application and Implementation

Note

Information in the following applications sections is not part of the TI component specification, and TI does not warrant its accuracy or completeness. TI's customers are responsible for determining suitability of components for their purposes. Customers should validate and test their design implementation to confirm system functionality.

8.1 Application Information

This section details the information required to configure the device for several popular configurations and provides guidance on integrating the TAS5805M device into the larger system.

8.1.1 Bootstrap Capacitors

The output stage of the TAS5805M uses a high-side NMOS driver, rather than a PMOS driver. To generate the gate driver voltage for the high-side NMOS, a bootstrap capacitor for each output terminal acts as a floating power supply for the switching cycle. Use 0.22- μ F capacitors to connect the appropriate output pin (OUT_X) to the bootstrap pin (BST_X). For example, connect a 0.22- μ F capacitor between OUT_A and BST_A for bootstrapping the A channel. Similarly, connect another 0.22- μ F capacitor between the OUT_B and BST_B pins for the B channel inverting output.

8.1.2 Inductor Selections

It is required that the peak current is smaller than the OCP (Over current protection) value which is 5A, there are 3 cases which cause high peak current flow through inductor.

1. During power up (idle state, no audio input), the duty cycle increases from 0 to θ .

$$I_{peak_power_up} \approx PVDD \times \sqrt{C/L} \times \sin(1/\sqrt{L \times C} \times \theta / F_{sw}) \quad (1)$$

Note

$\theta=0.5$ (BD Modulation), 0.14 (1SPW Modulation), 0.14 (Hybrid Modulation). This formula just provide a rough estimation, suggest to measure the start-up current based on your LC filter.

Table 8-1. Peak current during power up

PVDD	L (μ H)	C (μ F)	Fsw (kHz)	$I_{peak_power_up}$
24	4.7	0.68	384	6.07A (>5A OCP), not recommended
24	4.7	0.68	768	3.25A
24	10	0.68	384	3A
24	10	0.68	768	1.55A
12	4.7	0.68	384	3.32A
12	10	0.68	384	1.55A

2. During music playing, some audio burst signal (high frequency) with very hard PVDD clipping will cause PWM duty cycle increase dramatically. This is the worst case and it rarely happens.

$$I_{peak_clipping} \approx PVDD \times (1 - \theta) / (F_{sw} \times L) \quad (2)$$

3. Peak current due to Max output power. Ignore the ripple current flow through capacitor here.

$$I_{peak_output_power} \approx \sqrt{2 \times Max_Output_Power / R_{speaker_Load}} \quad (3)$$

Same PVDD and switching frequency, larger inductance means smaller idle current for lower power dissipation.

It's suggested that inductor's saturation current I_{sat} , is larger than the amplifier's peak current during power-up and play audio.

$$I_{SAT} \geq \max(I_{peak_power_up}, I_{peak_clipping}, I_{peak_output_power}) \quad (4)$$

In addition, the effective inductance at the peak current is required to be at least 80% of the inductance value in [Table 8-2](#), to meet datasheet specifications.

The minimum inductance is given in [Table 8-2](#)

Table 8-2. LC filter recommendation

PVDD (V)	Switching Frequency (kHz)	Modulation Scheme	Recommended Minimum Inductance (uH) for LC filter design
≤12	384	BD	4.7uH + 0.68uF
>12			10uH + 0.68uF
≤12	384	1SPW/Hybrid	10uH + 0.68uF
>12			15uH + 0.68uF

For higher switching frequency (F_{sw}), select inductors with minimum inductance to be $384\text{kHz}/F_{sw} \times L$.

8.1.3 Power Supply Decoupling

To ensure high efficiency, low THD, and high PSRR, proper power supply decoupling is necessary. Noise transients on the power supply lines are short duration voltage spikes. These spikes can contain frequency components that extend into the hundreds of megahertz. The power supply input must be decoupled with some good quality, low ESL, Low ESR capacitors larger than 22 μF . These capacitors bypasses low frequency noise to the ground plane. For high frequency decoupling, place 1- μF or 0.1- μF capacitors as close as possible to the PVDD pins of the device.

8.1.4 Output EMI Filtering

The TAS5805M device is often used with a low-pass filter, which is used to filter out the carrier frequency of the PWM modulated output. This filter is frequently referred to as the L-C Filter, due to the presence of an inductive element L and a capacitive element C to make up the 2-pole filter.

The L-C filter removes the carrier frequency, reducing electromagnetic emissions and smoothing the current waveform which is drawn from the power supply. The presence and size of the L-C filter is determined by several system level constraints. In some low-power use cases that have no other circuits which are sensitive to EMI, a simple ferrite bead or a ferrite bead plus a capacitor can replace the tradition large inductor and capacitor that are commonly used. In other high-power applications, large toroid inductors are required for maximum power and film capacitors can be used due to audio characteristics. Refer to the application report Class-D LC Filter Design ([SLOA119](#)) for a detailed description on the proper component selection and design of an L-C filter based upon the desired load and response.

8.2 Typical Applications

8.2.1 2.0 (Stereo BTL) System

In the 2.0 system, two channels are presented to the amplifier via the digital input signal. These two channels are amplified and then sent to two separate speakers. In some cases, the amplified signal is further separated based upon frequency by a passive crossover network after the L-C filter. Even so, the application is considered 2.0.

Most commonly, the two channels are a pair of signals called a stereo pair, with one channel containing the audio for the left channel and the other channel containing the audio for the right channel. While certainly the two channels can contain any two audio channels, such as two surround channels of a multi-channel speaker system, the most popular occurrence in two channels systems is a stereo pair.

Figure 8-1 shows the 2.0 (Stereo BTL) system application.

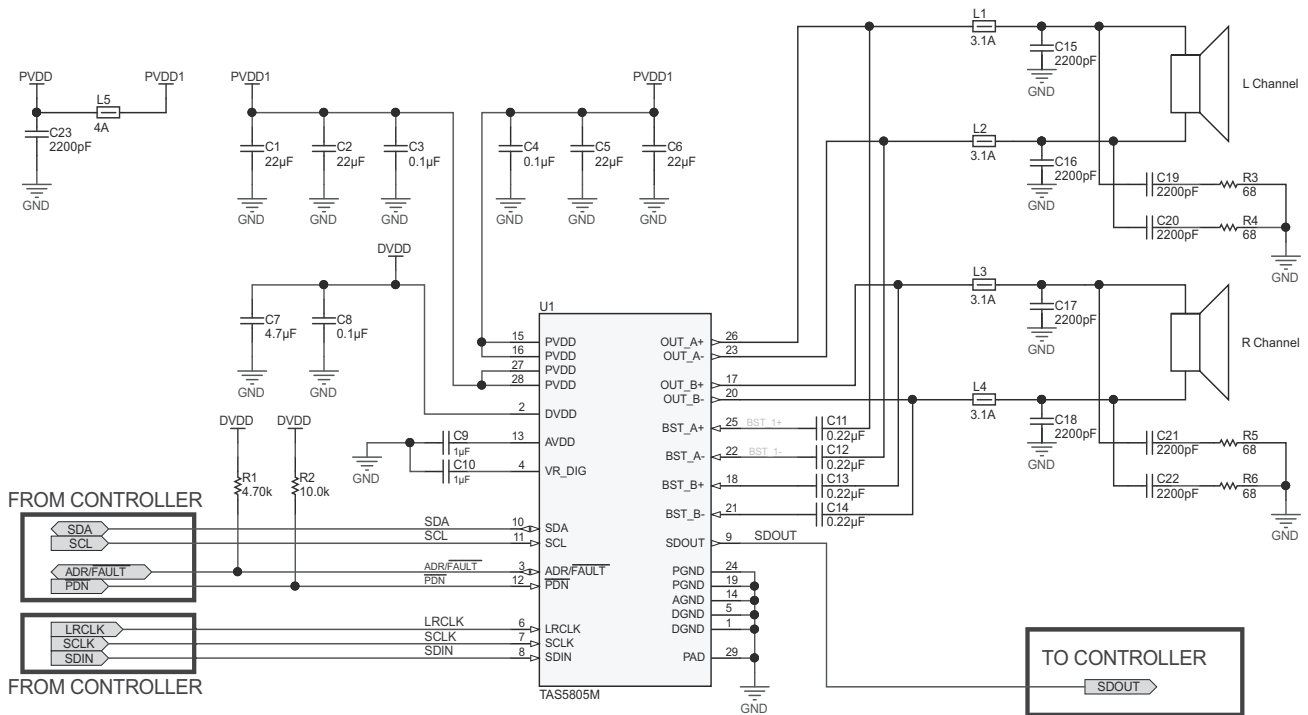

Figure 8-1. 2.0 (Stereo BTL) System Application Schematic with Ferrite Bead as the output filter

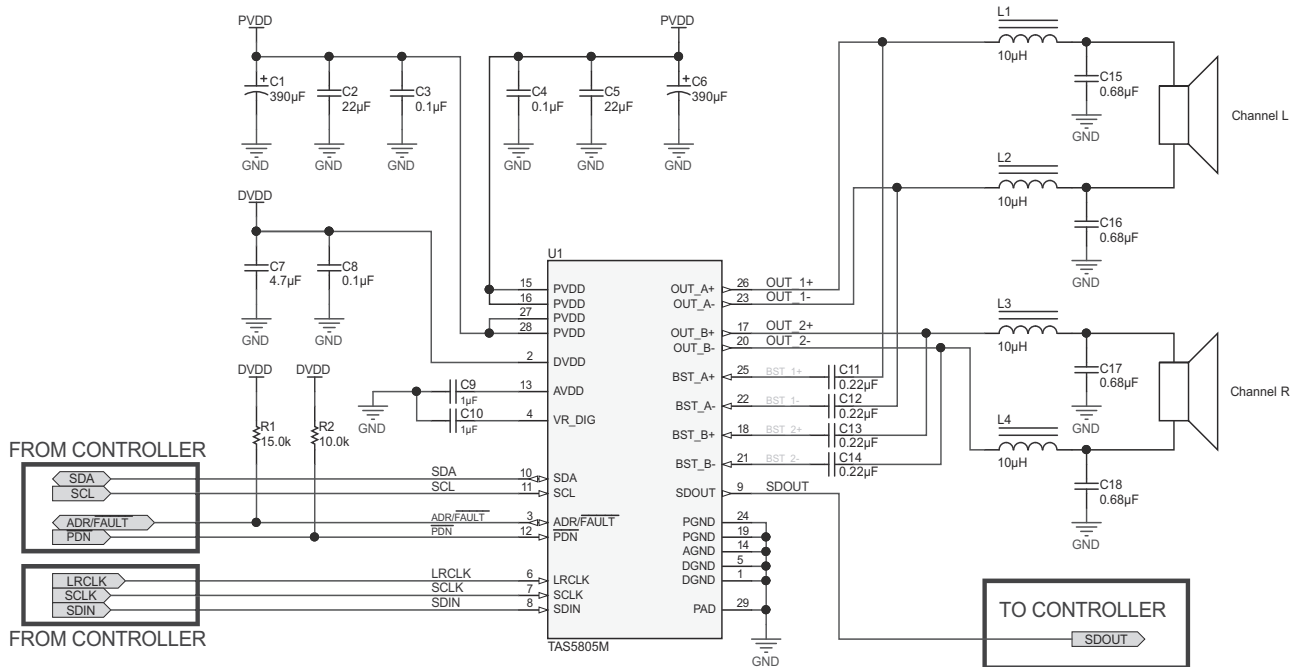

Figure 8-2. 2.0 (Stereo BTL) System Application Schematic with Inductor as the output filter

8.2.1.1 Design Requirements

- Power supplies:
 - 3.3-V or 1.8-V supply
 - 4.5-V to 24-V supply
- Communication: host processor serving as I²C compliant master
- External memory (Such as EEPROM and FLASH) used for coefficients

The requirement for the supporting components for the TAS5805M device in a Stereo 2.0 (BTL) system is provide in [Table 8-3](#) and [Table 8-4](#)

Table 8-3. Supporting Component Requirements for Stereo 2.0 (BTL) system (With Ferrite bead as output filter)

REFERENCE DESIGNATOR	VALUE	SIZE	DETAILED DESCRIPTION
C1,C2,C5,C6	22uF	0805	CAP, CERM, 22 µF, 35 V, +/- 20%, JB, 0805
C3,C4	0.1uF	0402	CAP, CERM, 0.1 µF, 50 V, +/- 10%, X7R, 0402
C7	4.7uF	0603	CAP, CERM, 4.7 µF, 10 V, +/- 10%, X5R, 0603
C8	0.1uF	0603	CAP, CERM, 0.1 µF, 16 V, +/- 10%, X7R, 0603
C9,C10	1uF	0603	CAP, CERM, 1 µF, 16 V, +/- 10%, X5R, 0603

Table 8-3. Supporting Component Requirements for Stereo 2.0 (BTL) system (With Ferrite bead as output filter) (continued)

REFERENCE DESIGNATOR	VALUE	SIZE	DETAILED DESCRIPTION
R1	4.70k	0402	RES, 4.70 k, 1%, 0.0625 W, 0402
R2	10.0k	0404	RES, 10.0 k, 1%, 0.063 W, 0402
C11,C12,C13,C14	0.22uF	0603	CAP, CERM, 0.22 μF, 50 V, +/- 10%, X7R, 0603
C15,C16,C17,C18,C19,C20,C21,C22,C23	2200pF	0603	CAP, CERM, 2200 pF, 100 V,+/- 10%, X7R, 0603
R3,R4,R5,R6	68 ohm	0603	ES, 68, 5%, 0.1 W, 0603
L1,L2,L3,L4	300 ohm	0806	Ferrite Bead, 300 ohm @ 100 MHz, 3.1 A, 0806
L5	100 ohm	0806	Ferrite Bead, 100 ohm @ 100 MHz, 4 A, 0806

With Low EMI technology, TAS5805M keeps enough EMI margin for most of application cases where PVDD < 14V with ferrite bead (Low BOM cost). With Ferrite Bead and capacitor as the output filter, [Figure 8-1](#) and [Table 8-3](#) includes a good configuration (Proper value of Ferrite bead, Capacitor, Resistor) to achieve enough EMI margin for the typical case which PVDD = 12V, Speaker Load = 8Ω/6Ω, each speaker wire with 1m length, Output Power = 1W/4W/8W for each channel.

- Select Ferrite bead (L1~L5). The trade-off is impedance and rated current. If the rated current meet the system's requirement, larger impedance means larger EMI margin for the EMI, especially for the frequency band 5 MHz~50 MHz. The typical ferrite bead recommend for TAS5805M is NFZ2MSM series (Murata) and UPZ2012E series (Sunlord). 300 ohm at 100 MHz ferrite bead is a typical value which can pass EMI for most of application cases.
- Select capacitor (C15~C23). The trade-off is capacitor value and idle current. Larger capacitor means larger idle current, increase the capacitor value from 1nF to 2.2nF makes much help for frequency band 5 MHz~100 MHz.
- Using Ferrite bead as the output filter, recommend designer to use Fsw = 384 kHz with Spread spectrum enable, BD Modulation, refer to [Section 7.4.3.1](#)
- With Ferrite bead as the output power. In order to pass EMI (AC Conducted Emission) standard, an AC to DC adapter with EMI filter in it is needed. For most of applications (TV/Voice Control Speaker/Wireless speaker/Soundbar) which need a 110 V~220 V power supply usually has a EMI filter in the AC to DC adapter. Some cases use DC power supply and also need to test the DC Conducted Emission , this applications (Automotive/Industry) need a simple EMI filter on PVDD for TAS5805M. Refer to application note: AN-2162 Simple Success With Conducted EMI From DC to DC Converters.

Table 8-4. Supporting Component Requirements for Stereo 2.0 (BTL) system (With Inductor as output filter)

REFERENCE DESIGNATOR	VALUE	SIZE	DETAILED DESCRIPTION
C1,C6	390 μF	10mmx10mm	CAP, AL, 390 μF, 35 V, ±20%, 0.08 ohm, SMD
C2,C5	22 μF	0603	CAP, CERM, 22 μF, 35 V, ±20%, JB, 0805
C3,C4	0.1 μF	0402	CAP, CERM, 0.1 μF, 50 V, ±10%, X7R, 0402
C7	4.7 μF	0603	CAP, CERM, 4.7 μF, 10 V, ±10%, X5R, 0603
C8	0.1 μF	0603	CAP, CERM, 0.1 μF, 16 V, ±10%, X7R, 0603
C9,C10	1 μF	0603	CAP, CERM, 1 μF, 16 V, ±10%, X5R, 0603
R1	4.70 k	0402	RES, 4.70 k, 1%, 0.0625 W, 0402
R2	10.0 k	0404	RES, 10.0 k, 1%, 0.063 W, 0402
C11,C12,C13,C14	0.22 μF	0603	CAP, CERM, 0.22 μF, 50 V, ±10%, X7R, 0603
C15,C16,C17,C18	0.68 μF	0805	CAP, CERM, 0.68 μF, 50 V, ±10%, X7R, 0805
L1,L2,L3,L4	10 μH		Inductor, Shielded, 10 μH, 4.4 A, 0.023 ohm, SMD

With Inductor as the output filter, designers can achieve ultra low idle current (with Hybrid Modulation or 1SPW Modulation) and keep large EMI margin. As the switching frequency of TAS5805M can be adjustable from 384 kHz to 768 kHz. Higher switching frequency means smaller Inductor value needed.

- With 768 kHz switching frequency. Designers can select 10uH + 0.68 μ F or 4.7 μ H + 0.68 μ F as the output filter, this will help customer to save the Inductor size with the same rated current during the inductor selection. With 4.7uH + 0.68uF, make sure PVDD \leq 12V to avoid the large ripple current to trigger the OC threshold (5A).
- With 384 kHz switching frequency. Designers can select 22 μ H + 0.68 μ F or 15 μ H + 0.68 μ F or 10 μ H + 0.68 μ F as the output filter, this will help customer to save power dissipation for some battery power supply application. With 10 μ H + 0.68 μ F, make sure PVDD \leq 12 V to avoid the large ripple current to trigger the OC threshold (5 A).

8.2.1.2 Detailed Design Procedures

The design procedure can be used for Stereo 2.0, Mono, 2.1 system.

8.2.1.2.1 Step 1: Hardware Integration

- Use the Typical Application Schematic as a guide, integrate the hardware into the system schematic.
- Follow the recommended component placement, board layout, and routing given in the example layout above, integrate the device and its supporting components into the system PCB file.
 - The most critical sections of the circuit are the power supply inputs, the amplifier output signals, and the high-frequency signals, all of which go to the serial audio port. Constructing these signals to ensure they are given precedent as design trade-offs are made is recommended.
 - For questions and support, go to the E2E forums ([E2E.ti.com](https://e2e.ti.com)). If deviating from the recommended layout is necessary, go to the E2E forum to request a layout review.

8.2.1.2.2 Step 2: Speaker Tuning

Use the TAS5805MEVM evaluation module and the PPC3 app to configure the desired device settings.

8.2.1.2.3 Step 3: Software Integration

- Use the End System Integration feature of the PPC3 app to generate a baseline configuration file.
- Generate additional configuration files based upon operating modes of the end-equipment and integrate static configuration information into initialization files.
- Integrate dynamic controls (such as volume controls, mute commands, and mode-based EQ curves) into the main system program.

8.2.1.3 Application Curves

8.2.1.3.1 Audio Performance

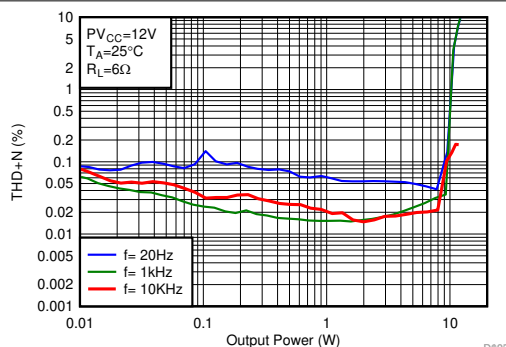

Figure 8-3. THD+N vs Frequency (Ferrite bead as Output Filter, BD Modulation, BTL Mode)

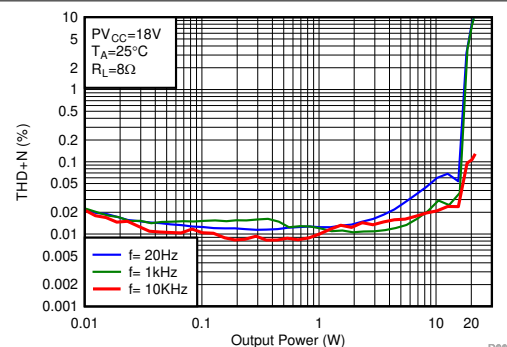

Figure 8-4. THD+N vs Frequency (Inductor as Output Filter, Hybrid Modulation, BTL Mode)

8.2.1.3.2 EN55022 Conducted Emissions Results with Ferrite Bead as output filter

With (Ferrite Bead as the output filter), 220 V to 12 V adapter from a major TV customer, 8-Ω speaker, Spread Spectrum Enabled, Stereo Output Power = 8W/CH, 1 meter speaker cable for each channel.

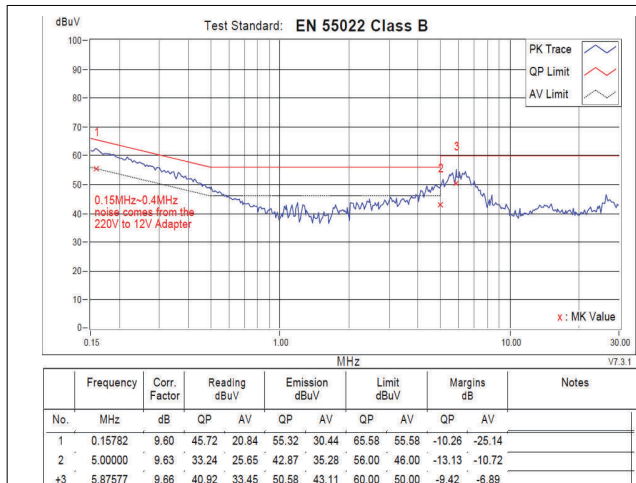

Figure 8-5. Conducted Emission with Ferrite Bead Filter - Line

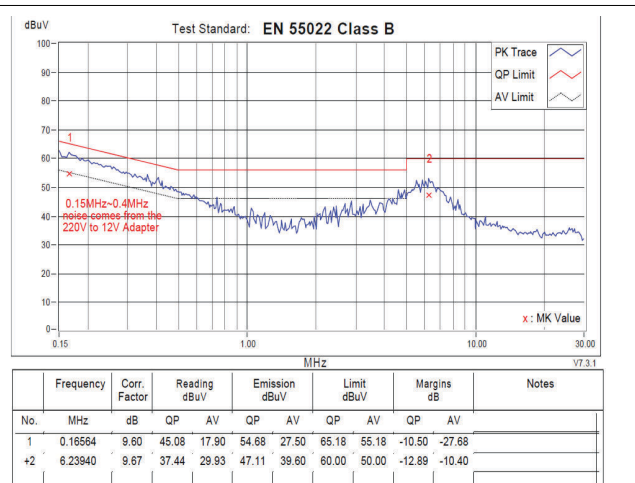

Figure 8-6. Conducted Emission with Ferrite Bead Filter - Neutral

8.2.1.3.3 EN55022 Radiated Emissions Results with Ferrite Bead as output filter

With (Ferrite Bead as the output filter), 220 V to 12 V adapter from a major TV customer, 8-Ω speaker, Spread Spectrum Enabled, Stereo Output Power = 8W/CH, 1 meter speaker cable for each channel.

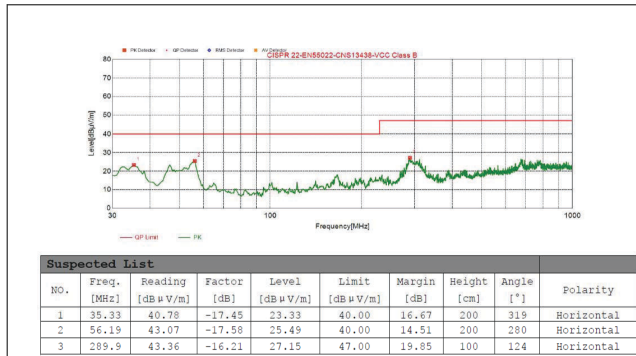

Figure 8-7. Radiated Emission with Ferrite Bead Filter - Horizontal

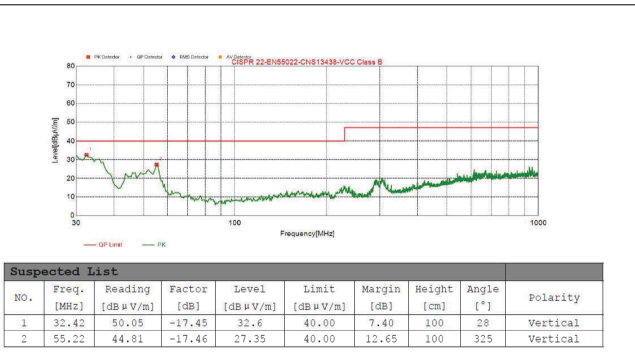

Figure 8-8. Radiated Emission with Ferrite Bead Filter - Vertical

With Inductor as the output filter, the EMI margin reserve ≥ 15 dB Margin for both Conducted Emission and Radiated Emission. More data are included in the application note -TAS5805M Design Considerations for EMC.

8.2.2 MONO (PBTl) Systems

In MONO mode, TAS5805M can be used as PBTl mode to drive sub-woofer with more output power.

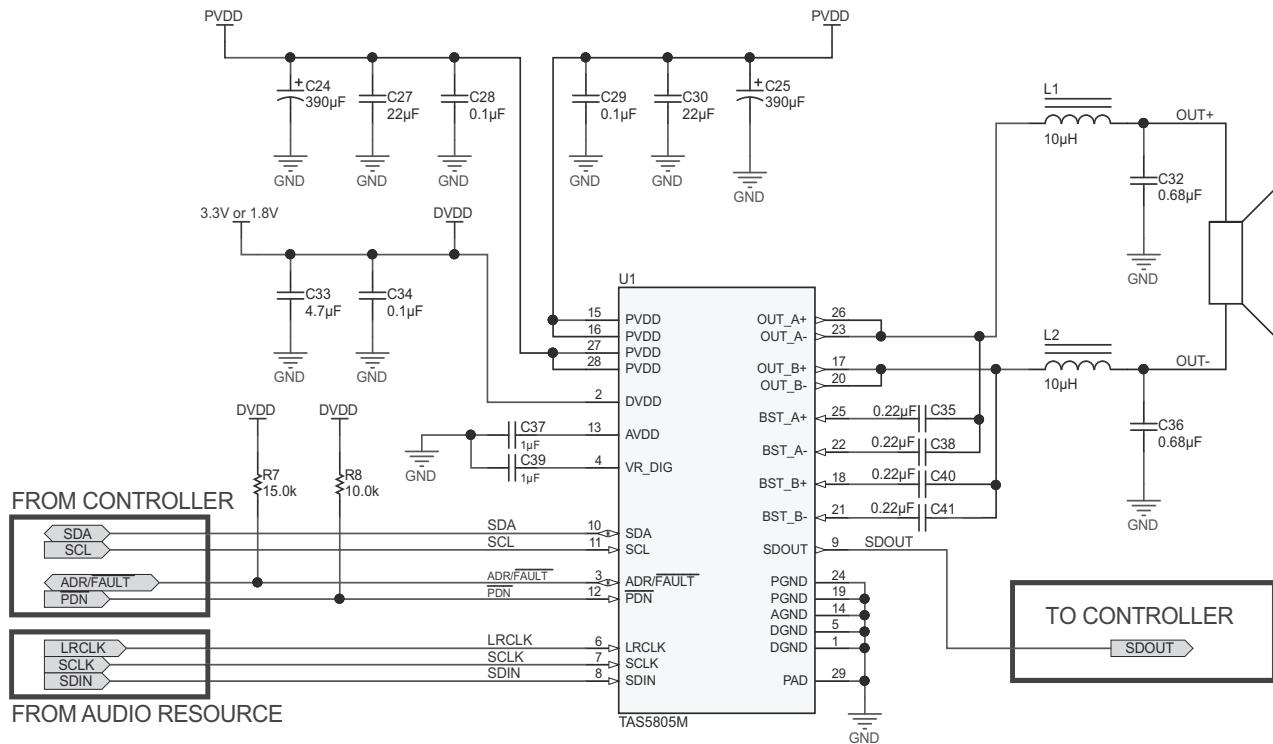

Figure 8-9. Mono (PBTl) System Application Schematic

8.2.2.1 Design Requirements

- Power supplies:
 - 3.3-V or 1.8-V supply
 - 4.5-V to 24-V supply
- Communication: host processor serving as I²C compliant master
- External memory (Such as EEPROM and FLASH) used for coefficients

The requirement for the supporting components for the TAS5805M device in a MONO (PBTl) system is provide in [Table 8-5](#)

Table 8-5. Supporting Component Requirements for MONO (PBTL) system (With Inductor as output filter)

REFERENCE DESIGNATOR	VALUE	SIZE	DETAILED DESCRIPTION
C24,C25	390uF	10mmx10mm	CAP, AL, 390 μF, 35 V, +/- 20%, 0.08 ohm, SMD
C27,C30	22uF	0603	CAP, CERM, 22 μF, 35 V, +/- 20%, JB, 0805
C28,C29	0.1uF	0402	CAP, CERM, 0.1 μF, 50 V, +/- 10%, X7R, 0402
C33	4.7uF	0603	CAP, CERM, 4.7 μF, 10 V, +/- 10%, X5R, 0603
C34	0.1uF	0603	CAP, CERM, 0.1 μF, 16 V, +/- 10%, X7R, 0603
C37,C39	1uF	0603	CAP, CERM, 1 μF, 16 V, +/- 10%, X5R, 0603
R7	4.70k	0402	RES, 4.70 k, 1%, 0.0625 W, 0402
R8	10.0k	0404	RES, 10.0 k, 1%, 0.063 W, 0402
C35,C38,C40,C41	0.22uF	0603	CAP, CERM, 0.22 μF, 50 V, +/- 10%, X7R, 0603
C32,C36	0.68uF	0805	CAP, CERM, 0.68 μF, 50 V, +/- 10%, X7R, 0805
L1,L2	10uH		Inductor, Shielded, 10 μH, 7A, 0.023 ohm, SMD

8.2.2.2 Detailed Design Procedure

For information about the Detailed Design Procedure, see the [Section 8.2.1.2](#) section.

8.2.2.3 Application Curves

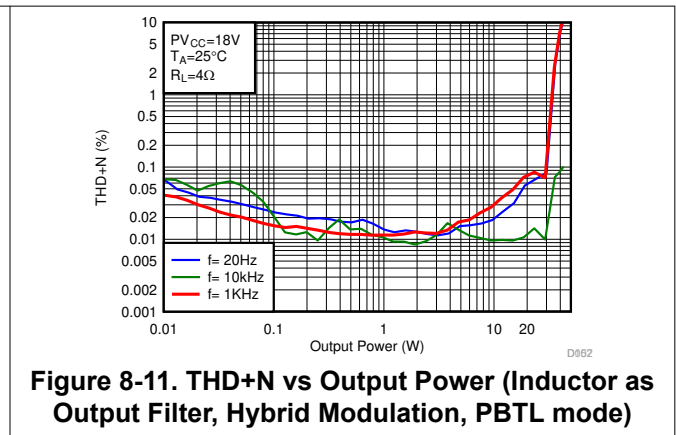
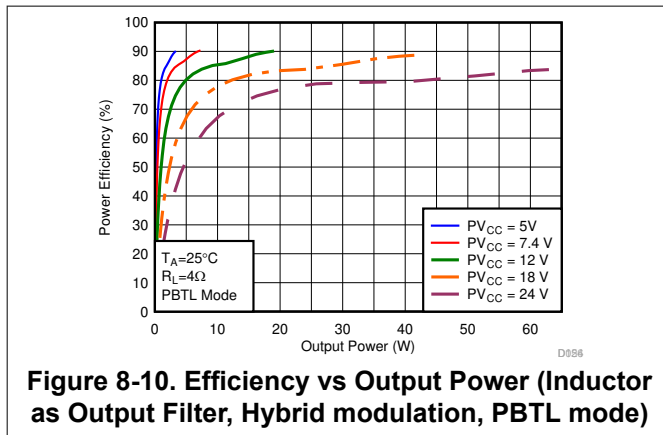

TAS5805M

SLASEH5D – MAY 2018 – REVISED NOVEMBER 2020

8.2.3 Advanced 2.1 System (Two TAS5805M Devices)

In higher performance systems, the subwoofer output can be enhanced using digital audio processing as was done in the high-frequency channels. To accomplish this, two TAS5805M devices are used - one for the high frequency left and right speakers and one for the mono subwoofer speaker. In this system, the audio signal can be sent from the TAS5805M device through the SDOUT pin. Alternatively, the subwoofer amplifier can accept the same digital input as the stereo, which might come from a central systems processor. Figure 8-12 shows the 2.1 (Stereo BTL with Two TAS5805M devices) system application.

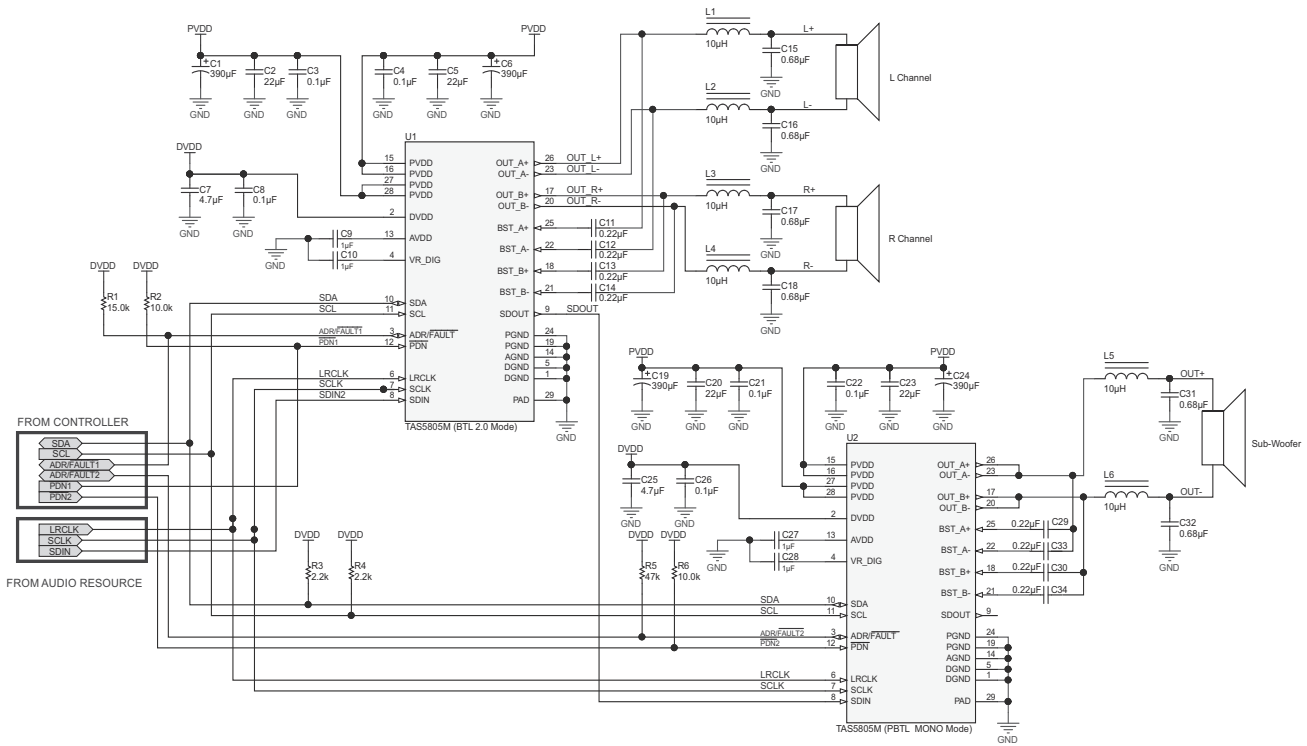

Figure 8-12. 2.1 (2.1 CH with Two TAS5805M Devices) Application Schematic

Power Supply Recommendations

The TAS5805M device requires two power supplies for proper operation. A high-voltage supply calls PVDD is required to power the output stage of the speaker amplifier and its associated circuitry. Additionally, one low-voltage power supply which is calls DVDD is required to power the various low-power portions of the device. The allowable voltage range for both PVDD and DVDD supply are listed in the *Recommended Operating Conditions* table. Once the device has been initialized, PVDD must keep within the normal operation voltage. Once PVDD lower than 3.5V, all registers need re-initialize again.

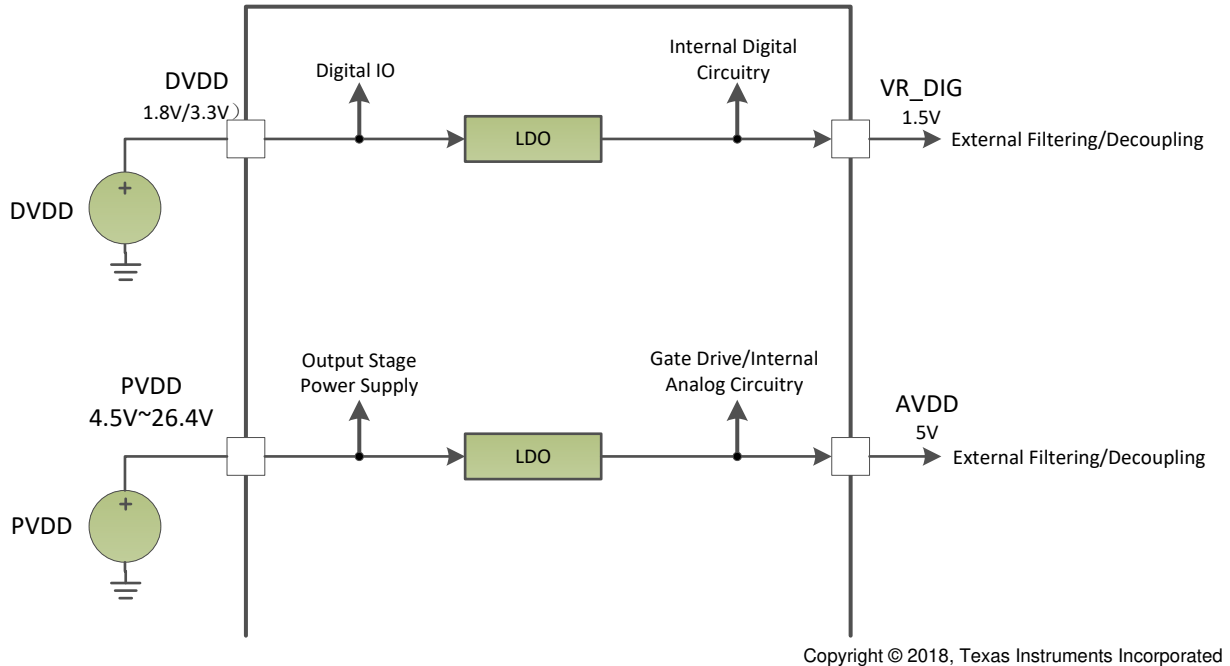

Figure 9-1. Power Supply Function Block Diagram

9.1 DVDD Supply

The DVDD supply that is required from the system is used to power several portions of the device. As shown in [Figure 9-1](#), it provides power to the DVDD pin. Proper connection, routing and decoupling techniques are highlighted in the [Section 8](#) section and the [Section 9.2](#) section and must be followed as closely as possible for proper operation and performance.

Some portions of the device also require a separate power supply that is a lower voltage than the DVDD supply. To simplify the power supply requirements for the system, the TAS5805M device includes an integrated low dropout (LDO) linear regulator to create this supply. This linear regulator is internally connected to the DVDD supply and its output is presented on the DVDD_REG pin, providing a connection point for an external bypass capacitor. It is important to note that the linear regulator integrated in the device has only been designed to support the current requirements of the internal circuitry, and should not be used to power any additional external circuitry. Additional loading on this pin could cause the voltage to sag, negatively affecting the performance and operation of the device.

9.2 PVDD Supply

The output stage of the speaker amplifier drives the load using the PVDD supply. This is the power supply which provides the drive current to the load during playback. Proper connection, routing, and decoupling techniques are highlighted in the TAS5805MEVM and must be followed as closely as possible for proper operation and performance. Due to the high-voltage switching of the output stage, it is particularly important to properly decouple the output power stages in the manner described in the TAS5805M device [Section 8](#). Lack of proper decoupling, like that shown in the [Section 8](#), results in voltage spikes which can damage the device.

A separate power supply is required to drive the gates of the MOSFETs used in the output stage of the speaker amplifier. This power supply is derived from the PVDD supply via an integrated linear regulator. A GVDD pin is provided for the attachment of decoupling capacitor for the gate drive voltage regulator. It is important to note that the linear regulator integrated in the device has only been designed to support the current requirements of the internal circuitry, and should not be used to power any additional external circuitry. Additional loading on this pin could cause the voltage to sag, negatively affecting the performance and operation of the device.

Another separate power supply is derived from the PVDD supply via an integrated linear regulator is AVDD. AVDD pin is provided for the attachment of decoupling capacitor for the TAS5805M internal circuitry. It is important to note that the linear regulator integrated in the device has only been designed to support the current requirements of the internal circuitry, and should not be used to power any additional external circuitry. Additional loading on this pin could cause the voltage to sag, negatively affecting the performance and operation of the device.

9 Layout

9.1 Layout Guidelines

9.1.1 General Guidelines for Audio Amplifiers

Audio amplifiers which incorporate switching output stages must have special attention paid to their layout and the layout of the supporting components used around them. The system level performance metrics, including thermal performance, electromagnetic compliance (EMC), device reliability, and audio performance are all affected by the device and supporting component layout.

Ideally, the guidance provided in the applications section with regard to device and component selection can be followed by precise adherence to the layout guidance shown in the [Section 9.2](#) section. These examples represent exemplary baseline balance of the engineering trade-offs involved with laying out the device. These designs can be modified slightly as needed to meet the needs of a given application. In some applications, for instance, solution size can be compromised to improve thermal performance through the use of additional contiguous copper near the device. Conversely, EMI performance can be prioritized over thermal performance by routing on internal traces and incorporating a via picket-fence and additional filtering components. In all cases, it is recommended to start from the guidance shown in the [Section 9.2](#) section and work with TI field application engineers or through the E2E community to modify it based upon the application specific goals.

9.1.2 Importance of PVDD Bypass Capacitor Placement on PVDD Network

Placing the bypassing and decoupling capacitors close to supply has long been understood in the industry. This applies to DVDD, AVDD, GVDD and PVDD. However, the capacitors on the PVDD net for the TAS5805M device deserve special attention.

The small bypass capacitors on the PVDD lines of the DUT must be placed as close to the PVDD pins as possible. Not only does placing these devices far away from the pins increase the electromagnetic interference in the system, but doing so can also negatively affect the reliability of the device. Placement of these components too far from the TAS5805M device can cause ringing on the output pins that can cause the voltage on the output pin to exceed the maximum allowable ratings shown in the *Absolute Maximum Ratings* table, damaging the device. For that reason, the capacitors on the PVDD net must be no further away from their associated PVDD pins than what is shown in the example layouts in the [Section 9.2](#) section.

9.1.3 Optimizing Thermal Performance

Follow the layout example shown in the [Figure 9-1](#) to achieve the best balance of solution size, thermal, audio, and electromagnetic performance. In some cases, deviation from this guidance can be required due to design constraints which cannot be avoided. In these instances, the system designer should ensure that the heat can get out of the device and into the ambient air surrounding the device. Fortunately, the heat created in the device naturally travels away from the device and into the lower temperature structures around the device.

9.1.3.1 Device, Copper, and Component Layout

Primarily, the goal of the PCB design is to minimize the thermal impedance in the path to those cooler structures. These tips should be followed to achieve that goal:

- Avoid placing other heat producing components or structures near the amplifier (including above or below in the end equipment).
- If possible, use a higher layer count PCB to provide more heat sinking capability for the TAS5805M device and to prevent traces and copper signal and power planes from breaking up the contiguous copper on the top and bottom layer.
- Place the TAS5805M device away from the edge of the PCB when possible to ensure that the heat can travel away from the device on all four sides.
- Avoid cutting off the flow of heat from the TAS5805M device to the surrounding areas with traces or via strings. Instead, route traces perpendicular to the device and line up vias in columns which are perpendicular to the device.
- Unless the area between two pads of a passive component is large enough to allow copper to flow in between the two pads, orient it so that the narrow end of the passive component is facing the TAS5805M device.

- Because the ground pins are the best conductors of heat in the package, maintain a contiguous ground plane from the ground pins to the PCB area surrounding the device for as many of the ground pins as possible.

9.1.3.2 Stencil Pattern

The recommended drawings for the TAS5805M device PCB foot print and associated stencil pattern are shown at the end of this document in the package addendum. Additionally, baseline recommendations for the via arrangement under and around the device are given as a starting point for the PCB design. This guidance is provided to suit the majority of manufacturing capabilities in the industry and prioritizes manufacturability over all other performance criteria. In elevated ambient temperature or under high-power dissipation use-cases, this guidance may be too conservative and advanced PCB design techniques may be used to improve thermal performance of the system.

Note

The customer must verify that deviation from the guidance shown in the package addendum, including the deviation explained in this section, meets the customer's quality, reliability, and manufacturability goals.

9.1.3.2.1 PCB footprint and Via Arrangement

The PCB footprint (also known as a symbol or land pattern) communicates to the PCB fabrication vendor the shape and position of the copper patterns to which the TAS5805M device will be soldered. This footprint can be followed directly from the guidance in the package addendum at the end of this data sheet. It is important to make sure that the thermal pad, which connects electrically and thermally to the PowerPAD™ of the TAS5805M device, be made no smaller than what is specified in the package addendum. This ensures that the TAS5805M device has the largest interface possible to move heat from the device to the board.

The via pattern shown in the package addendum provides an improved interface to carry the heat from the device through to the layers of the PCB, because small diameter plated vias (with minimally-sized annular rings) present a low thermal-impedance path from the device into the PCB. Once into the PCB, the heat travels away from the device and into the surrounding structures and air. By increasing the number of vias, as shown in the [Section 9.2](#) section, this interface can benefit from improved thermal performance.

Note

Vias can obstruct heat flow if they are not constructed properly.

More notes on the construction and placement of vias are as follows:

- Remove thermal reliefs on thermal vias, because they impede the flow of heat through the via.
- Vias filled with thermally conductive material are best, but a simple plated via can be used to avoid the additional cost of filled vias.
- The diameter of the drill must be 8 mm or less. Also, the distance between the via barrel and the surrounding planes should be minimized to help heat flow from the via into the surrounding copper material. In all cases, minimum spacing should be determined by the voltages present on the planes surrounding the via and minimized wherever possible.
- Vias should be arranged in columns, which extend in a line radially from the heat source to the surrounding area. This arrangement is shown in the [Section 9.2](#) section.
- Ensure that vias do not cut off power current flow from the power supply through the planes on internal layers. If needed, remove some vias that are farthest from the TAS5805M device to open up the current path to and from the device.

9.1.3.2.2 Solder Stencil

During the PCB assembly process, a piece of metal called a stencil on top of the PCB and deposits solder paste on the PCB wherever there is an opening (called an aperture) in the stencil. The stencil determines the quantity and the location of solder paste that is applied to the PCB in the electronic manufacturing process. In most cases, the aperture for each of the component pads is almost the same size as the pad itself. However, the thermal pad on the PCB is large and depositing a large, single deposition of solder paste would lead to

manufacturing issues. Instead, the solder is applied to the board in multiple apertures, to allow the solder paste to outgas during the assembly process and reduce the risk of solder bridging under the device. This structure is called an aperture array, and is shown in the [Section 9.2](#) section. It is important that the total area of the aperture array (the area of all of the small apertures combined) covers between 70% and 80% of the area of the thermal pad itself.

9.2 Layout Example

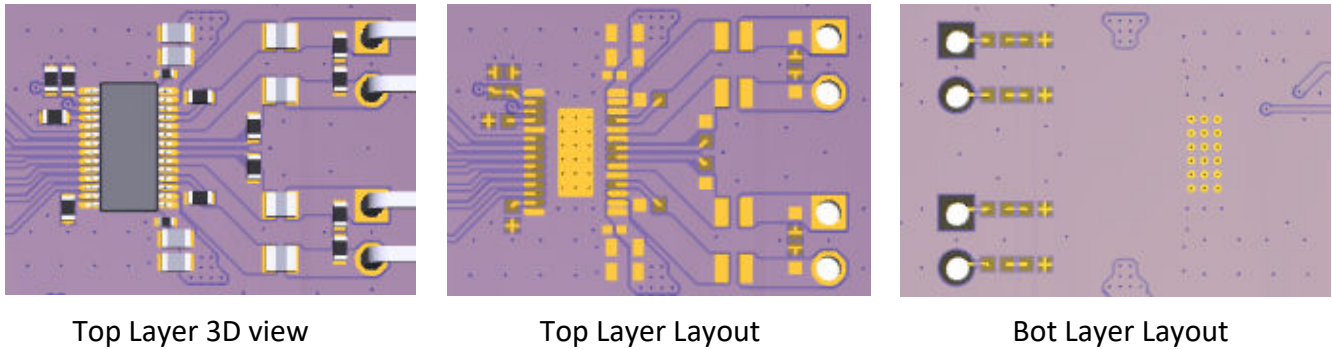

Figure 9-1. 2.0 (Stereo BTL with Ferrite Bead as Output Filter) Layout View

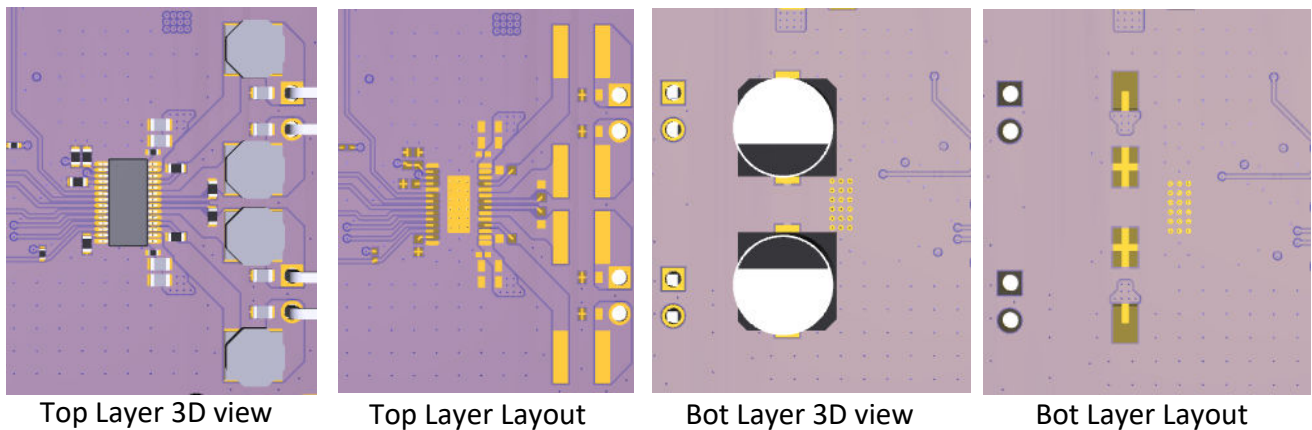

Figure 9-2. 2.0 (Stereo BTL with Inductor as Output Filter) Layout View

10 Device and Documentation Support

10.1 Device Support

10.1.1 Device Nomenclature

The glossary is general commonly used acronyms and words which are defined in accordance with a broad TI initiative to comply with industry standards such as JEDEC, IPC, IEEE, and others. The glossary provided in this section defines words, phrases, and acronyms that are unique to this product and documentation, collateral, or support tools and software used with this product. For any additional questions regarding definitions and terminology, please see the [e2e Audio Amplifier Forum](#).

Bridge tied load (BTL) is an output configuration in which one terminal of the speaker is connected to one half-bridge and the other terminal is connected to another half-bridge.

DUT refers to a *device under test* to differentiate one device from another.

Closed-loop architecture describes a topology in which the amplifier monitors the output terminals, comparing the output signal to the input signal and attempts to correct for non-linearities in the output.

Dynamic controls are those which are changed during normal use by either the system or the end-user.

GPIO is a general purpose input/output pin. It is a highly configurable, bi-directional digital pin which can perform many functions as required by the system.

Host processor (also known as System Processor, Scalar, Host, or System Controller) refers to device which serves as a central system controller, providing control information to devices connected to it as well as gathering audio source data from devices upstream from it and distributing it to other devices. This device often configures the controls of the audio processing devices (like the TAS5805M) in the audio path in order to optimize the audio output of a loudspeaker based on frequency response, time alignment, target sound pressure level, safe operating area of the system, and user preference.

Maximum continuous output power refers to the maximum output power that the amplifier can continuously deliver without shutting down when operated in a 25°C ambient temperature. Testing is performed for the period of time required that their temperatures reach thermal equilibrium and are no longer increasing

Parallel bridge tied load (PBTL) is an output configuration in which one terminal of the speaker is connected to two half-bridges which have been placed in parallel and the other terminal is connected to another pair of half bridges placed in parallel

$r_{DS(on)}$ is a measure of the on-resistance of the MOSFETs used in the output stage of the amplifier.

Static controls/Static configurations are controls which do not change while the system is in normal use.

Vias are copper-plated through-hole in a PCB.

10.1.2 Development Support

For TAS5805M Evaluation Module, [TAS5805MEVM](#)

Request PurePath™ Console Graphical Development Suite for Audio System Design and Development, [PUREPATHCONSOLE](#)

Request TAS5805M PPC3 app access by click 'Request Now' in TAS5805M product folder, [TAS5805M](#)

Or contact TI field support team to get the PPC3 platform access and TAS5805M app access.

Application notes: [Minimize Idle Current in Portable Audio With TAS5805M Hybrid Mode](#)

Application notes: [TAS5805M Process Flows](#)

Class-D LC Filter Design, [Class-D LC Filter Design](#)

10.2 Receiving Notification of Documentation Updates

To receive notification of documentation updates, navigate to the device product folder on ti.com. In the upper right corner, click on *Alert me* to register and receive a weekly digest of any product information that has changed. For change details, review the revision history included in any revised document.

10.3 Support Resources

TI E2E™ support forums are an engineer's go-to source for fast, verified answers and design help — straight from the experts. Search existing answers or ask your own question to get the quick design help you need.

Linked content is provided "AS IS" by the respective contributors. They do not constitute TI specifications and do not necessarily reflect TI's views; see TI's [Terms of Use](#).

10.4 Trademarks

PowerPAD™ and TI E2E™ are trademarks of Texas Instruments.
All trademarks are the property of their respective owners.

10.5 Electrostatic Discharge Caution



This integrated circuit can be damaged by ESD. Texas Instruments recommends that all integrated circuits be handled with appropriate precautions. Failure to observe proper handling and installation procedures can cause damage.

ESD damage can range from subtle performance degradation to complete device failure. Precision integrated circuits may be more susceptible to damage because very small parametric changes could cause the device not to meet its published specifications.

10.6 Glossary

[TI Glossary](#) This glossary lists and explains terms, acronyms, and definitions.

Mechanical, Packaging, and Orderable Information

The following pages include mechanical, packaging, and orderable information. This information is the most current data available for the designated devices. This data is subject to change without notice and revision of this document. For browser-based versions of this data sheet, refer to the left-hand navigation.

PACKAGING INFORMATION

Orderable Device	Status (1)	Package Type	Package Drawing	Pins	Package Qty	Eco Plan (2)	Lead finish/ Ball material (6)	MSL Peak Temp (3)	Op Temp (°C)	Device Marking (4/5)	Samples
TAS5805MPWP	ACTIVE	HTSSOP	PWP	28	50	RoHS & Green	NIPDAU	Level-3-260C-168 HR	-25 to 85	5805	Samples
TAS5805MPWPR	ACTIVE	HTSSOP	PWP	28	2000	RoHS & Green	NIPDAU	Level-3-260C-168 HR	-25 to 85	5805	Samples

(1) The marketing status values are defined as follows:

ACTIVE: Product device recommended for new designs.

LIFEBUY: TI has announced that the device will be discontinued, and a lifetime-buy period is in effect.

NRND: Not recommended for new designs. Device is in production to support existing customers, but TI does not recommend using this part in a new design.

PREVIEW: Device has been announced but is not in production. Samples may or may not be available.

OBSOLETE: TI has discontinued the production of the device.

(2) **RoHS:** TI defines "RoHS" to mean semiconductor products that are compliant with the current EU RoHS requirements for all 10 RoHS substances, including the requirement that RoHS substance do not exceed 0.1% by weight in homogeneous materials. Where designed to be soldered at high temperatures, "RoHS" products are suitable for use in specified lead-free processes. TI may reference these types of products as "Pb-Free".

RoHS Exempt: TI defines "RoHS Exempt" to mean products that contain lead but are compliant with EU RoHS pursuant to a specific EU RoHS exemption.

Green: TI defines "Green" to mean the content of Chlorine (Cl) and Bromine (Br) based flame retardants meet JS709B low halogen requirements of <=1000ppm threshold. Antimony trioxide based flame retardants must also meet the <=1000ppm threshold requirement.

(3) MSL, Peak Temp. - The Moisture Sensitivity Level rating according to the JEDEC industry standard classifications, and peak solder temperature.

(4) There may be additional marking, which relates to the logo, the lot trace code information, or the environmental category on the device.

(5) Multiple Device Markings will be inside parentheses. Only one Device Marking contained in parentheses and separated by a "~" will appear on a device. If a line is indented then it is a continuation of the previous line and the two combined represent the entire Device Marking for that device.

(6) Lead finish/Ball material - Orderable Devices may have multiple material finish options. Finish options are separated by a vertical ruled line. Lead finish/Ball material values may wrap to two lines if the finish value exceeds the maximum column width.

Important Information and Disclaimer:The information provided on this page represents TI's knowledge and belief as of the date that it is provided. TI bases its knowledge and belief on information provided by third parties, and makes no representation or warranty as to the accuracy of such information. Efforts are underway to better integrate information from third parties. TI has taken and continues to take reasonable steps to provide representative and accurate information but may not have conducted destructive testing or chemical analysis on incoming materials and chemicals. TI and TI suppliers consider certain information to be proprietary, and thus CAS numbers and other limited information may not be available for release.

In no event shall TI's liability arising out of such information exceed the total purchase price of the TI part(s) at issue in this document sold by TI to Customer on an annual basis.

TAPE AND REEL INFORMATION

QUADRANT ASSIGNMENTS FOR PIN 1 ORIENTATION IN TAPE

*All dimensions are nominal

Device	Package Type	Package Drawing	Pins	SPQ	Reel Diameter (mm)	Reel Width W1 (mm)	A0 (mm)	B0 (mm)	K0 (mm)	P1 (mm)	W (mm)	Pin1 Quadrant
TAS5805MPWPR	HTSSOP	PWP	28	2000	330.0	16.4	6.9	10.2	1.8	12.0	16.0	Q1

TAPE AND REEL BOX DIMENSIONS

*All dimensions are nominal

Device	Package Type	Package Drawing	Pins	SPQ	Length (mm)	Width (mm)	Height (mm)
TAS5805MPWPR	HTSSOP	PWP	28	2000	356.0	356.0	35.0

TUBE

*All dimensions are nominal

Device	Package Name	Package Type	Pins	SPQ	L (mm)	W (mm)	T (μm)	B (mm)
TAS5805MPWP	PWP	HTSSOP	28	50	530	10.2	3600	3.5
TAS5805MPWP	PWP	HTSSOP	28	50	530	10.2	3600	3.5

GENERIC PACKAGE VIEW

PWP 28

PowerPAD™ TSSOP - 1.2 mm max height

4.4 x 9.7, 0.65 mm pitch

SMALL OUTLINE PACKAGE

This image is a representation of the package family, actual package may vary.
Refer to the product data sheet for package details.

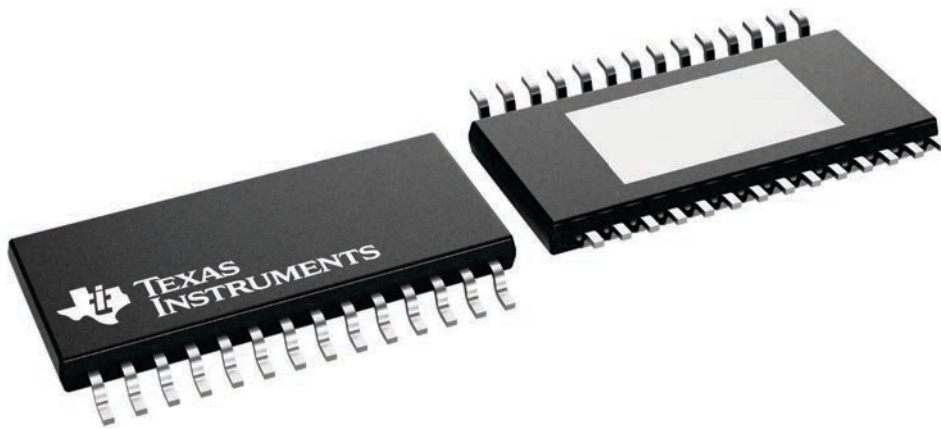

4224765/B

PWP0028M

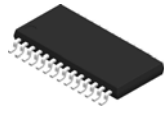

PACKAGE OUTLINE

PowerPAD™ TSSOP - 1.2 mm max height

SMALL OUTLINE PACKAGE

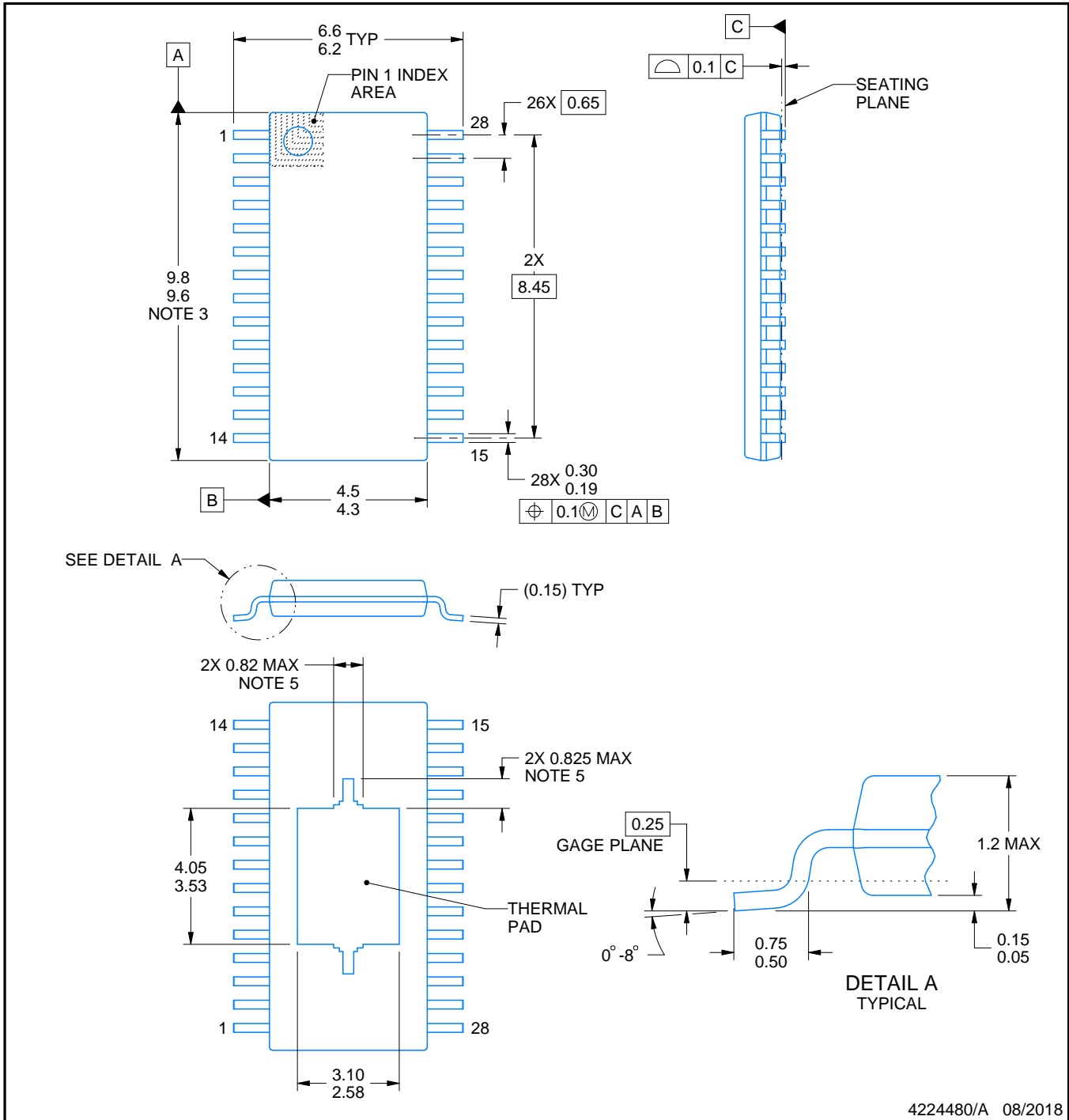

NOTES:

PowerPAD is a trademark of Texas Instruments.

1. All linear dimensions are in millimeters. Any dimensions in parenthesis are for reference only. Dimensioning and tolerancing per ASME Y14.5M.
2. This drawing is subject to change without notice.
3. This dimension does not include mold flash, protrusions, or gate burrs. Mold flash, protrusions, or gate burrs shall not exceed 0.15 mm per side.
4. Reference JEDEC registration MO-153.
5. Features may differ or may not be present.

EXAMPLE BOARD LAYOUT

PWP0028M

PowerPAD™ TSSOP - 1.2 mm max height

SMALL OUTLINE PACKAGE

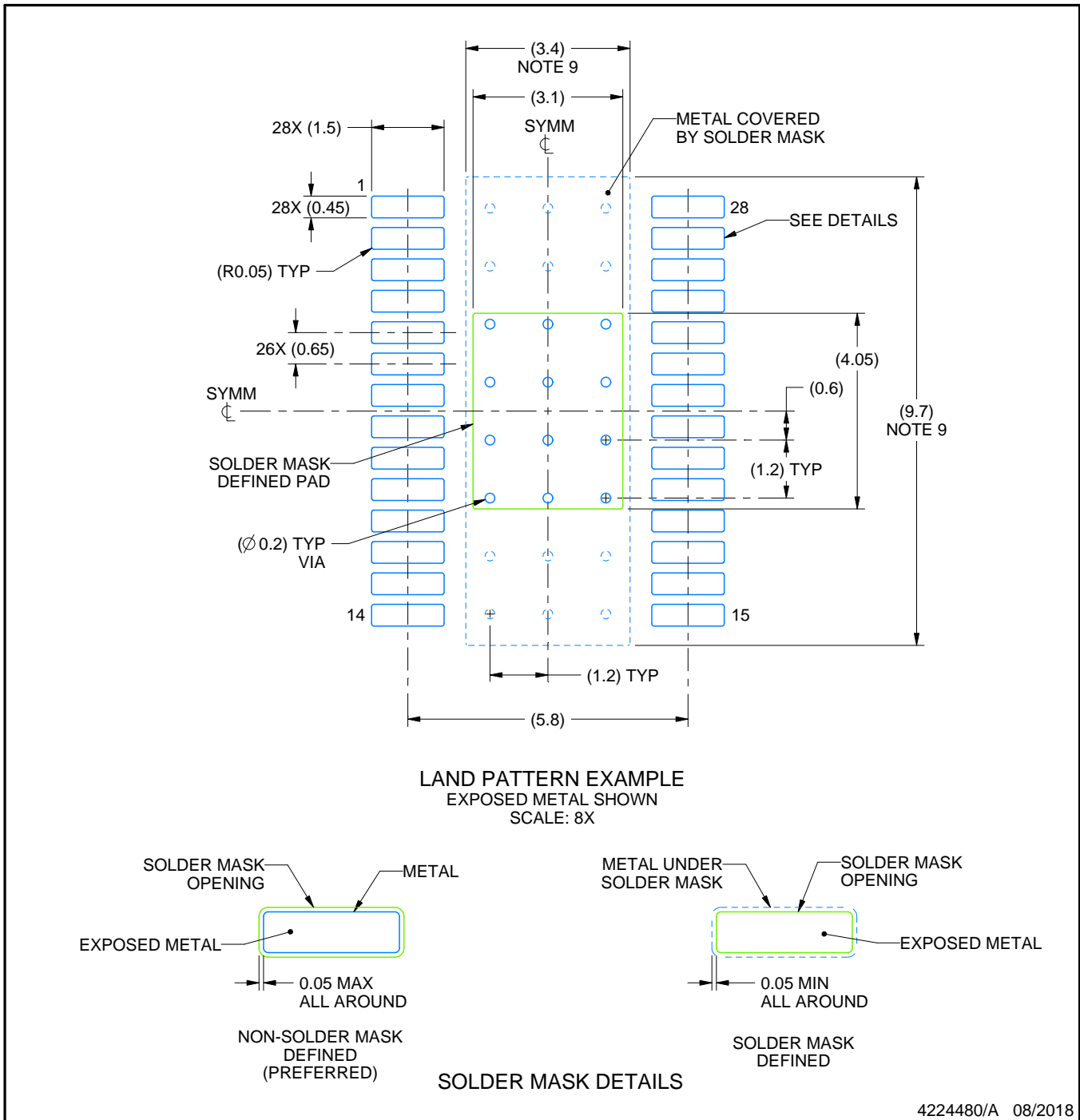

4224480/A 08/2018

NOTES: (continued)

6. Publication IPC-7351 may have alternate designs.
7. Solder mask tolerances between and around signal pads can vary based on board fabrication site.
8. This package is designed to be soldered to a thermal pad on the board. For more information, see Texas Instruments literature numbers SLMA002 (www.ti.com/lit/slma002) and SLMA004 (www.ti.com/lit/slma004).
9. Size of metal pad may vary due to creepage requirement.
10. Vias are optional depending on application, refer to device data sheet. It is recommended that vias under paste be filled, plugged or tented.

EXAMPLE STENCIL DESIGN

PWP0028M

PowerPAD™ TSSOP - 1.2 mm max height

SMALL OUTLINE PACKAGE

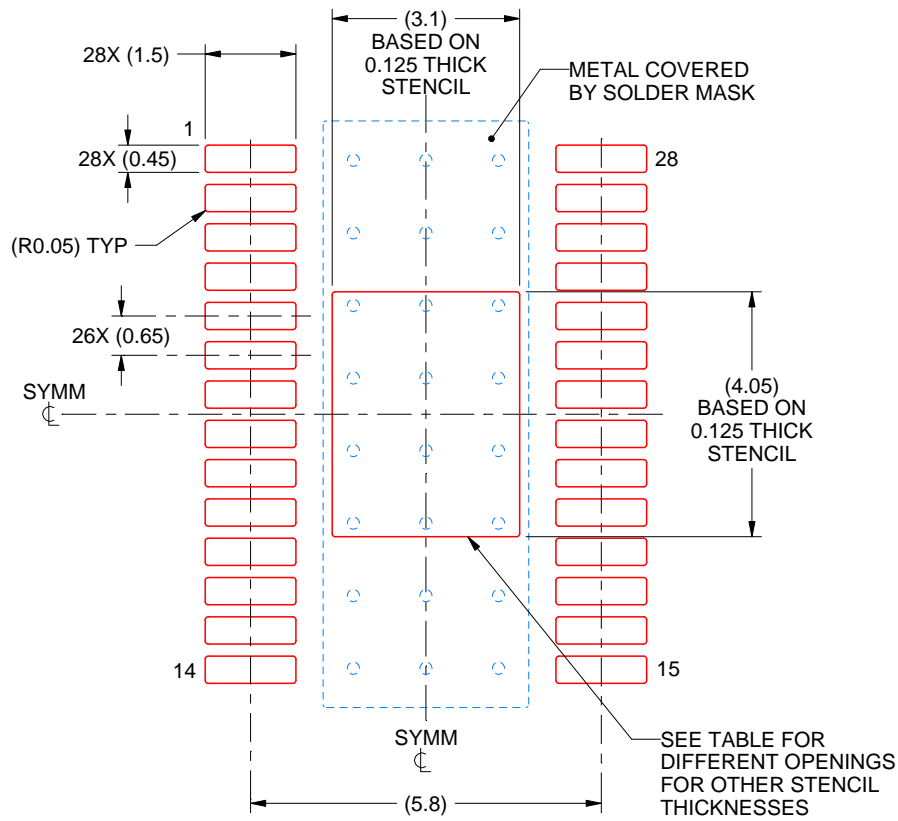

SOLDER PASTE EXAMPLE
 BASED ON 0.125 mm THICK STENCIL
 SCALE: 8X

STENCIL THICKNESS	SOLDER STENCIL OPENING
0.1	3.47 X 4.53
0.125	3.10 X 4.05 (SHOWN)
0.15	2.83 X 3.70
0.175	2.62 X 3.42

4224480/A 08/2018

NOTES: (continued)

11. Laser cutting apertures with trapezoidal walls and rounded corners may offer better paste release. IPC-7525 may have alternate design recommendations.
12. Board assembly site may have different recommendations for stencil design.

IMPORTANT NOTICE AND DISCLAIMER

TI PROVIDES TECHNICAL AND RELIABILITY DATA (INCLUDING DATA SHEETS), DESIGN RESOURCES (INCLUDING REFERENCE DESIGNS), APPLICATION OR OTHER DESIGN ADVICE, WEB TOOLS, SAFETY INFORMATION, AND OTHER RESOURCES "AS IS" AND WITH ALL FAULTS, AND DISCLAIMS ALL WARRANTIES, EXPRESS AND IMPLIED, INCLUDING WITHOUT LIMITATION ANY IMPLIED WARRANTIES OF MERCHANTABILITY, FITNESS FOR A PARTICULAR PURPOSE OR NON-INFRINGEMENT OF THIRD PARTY INTELLECTUAL PROPERTY RIGHTS.

These resources are intended for skilled developers designing with TI products. You are solely responsible for (1) selecting the appropriate TI products for your application, (2) designing, validating and testing your application, and (3) ensuring your application meets applicable standards, and any other safety, security, regulatory or other requirements.

These resources are subject to change without notice. TI grants you permission to use these resources only for development of an application that uses the TI products described in the resource. Other reproduction and display of these resources is prohibited. No license is granted to any other TI intellectual property right or to any third party intellectual property right. TI disclaims responsibility for, and you will fully indemnify TI and its representatives against, any claims, damages, costs, losses, and liabilities arising out of your use of these resources.

TI's products are provided subject to [TI's Terms of Sale](#) or other applicable terms available either on ti.com or provided in conjunction with such TI products. TI's provision of these resources does not expand or otherwise alter TI's applicable warranties or warranty disclaimers for TI products.

TI objects to and rejects any additional or different terms you may have proposed.

Mailing Address: Texas Instruments, Post Office Box 655303, Dallas, Texas 75265
Copyright © 2022, Texas Instruments Incorporated