

70-MHz HIGH-SPEED AMPLIFIERS

FEATURES

- **High Speed:**
 - 70 MHz Bandwidth ($G = 1$, -3 dB)
 - 240 V/ μ s Slew Rate
 - 60-ns Settling Time (0.1%)
- **High Output Drive, $I_O = 100$ mA (typ)**
- **Excellent Video Performance:**
 - 0.1 dB Bandwidth of 30 MHz ($G = 1$)
 - 0.01% Differential Gain
 - 0.01° Differential Phase
- **Very Low Distortion:**
 - THD = -82 dBc ($f = 1$ MHz, $R_L = 150 \Omega$)
 - THD = -89 dBc ($f = 1$ MHz, $R_L = 1$ k Ω)
- **Wide Range of Power Supplies:**
 - $V_{CC} = \pm 5$ V to ± 15 V
- **Available in Standard SOIC, MSOP, PowerPAD™, JG, or FK Packages**
- **Evaluation Module Available**

DESCRIPTION

The THS4051 and THS4052 are general-purpose, single/dual, high-speed voltage feedback amplifiers ideal for a wide range of applications including video, communication, and imaging. The devices offer very good ac performance with 70-MHz bandwidth, 240-V/ μ s slew rate, and 60-ns settling time (0.1%). The THS4051/2 are stable at all gains for both inverting and non-inverting configurations. These amplifiers have a high output drive capability of 100 mA and draw only 8.5-mA supply current per channel. Excellent professional video results can be obtained with the low differential gain/phase errors of 0.01%/ 0.01° and wide 0.1-dB flatness to 30 MHz. For applications requiring low distortion, the THS4051/2 is ideally suited with total harmonic distortion of -82 dBc at 1 MHz.

RELATED DEVICES	
DEVICE	DESCRIPTION
THS4011/2	290-MHz Low Distortion High-Speed Amplifiers
THS4031/2	100-MHz Low Noise High-Speed Amplifiers
THS4081/2	175-MHz Low Power High-Speed Amplifiers

**THS4051
D, DGN, AND JG PACKAGES
(TOP VIEW)**

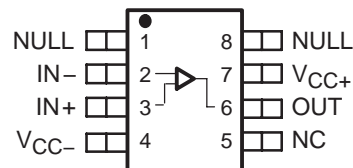

NC – No internal connection

**THS4052
D AND DGN† PACKAGES
(TOP VIEW)**

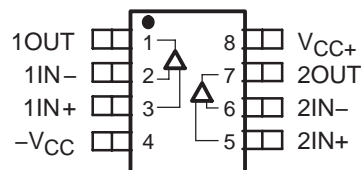

Cross Section View Showing PowerPAD™ Option (DGN)

† This device is in the Product Preview stage of development. Please contact your local TI sales office for availability.

**THS4051
FK PACKAGE
(TOP VIEW)**

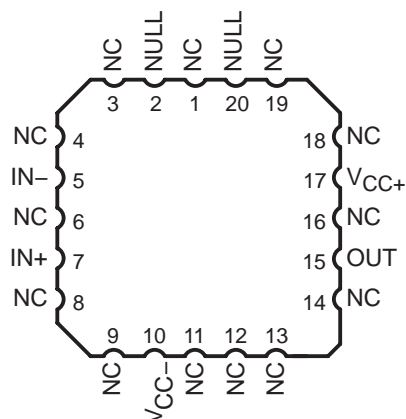

Please be aware that an important notice concerning availability, standard warranty, and use in critical applications of Texas Instruments semiconductor products and disclaimers thereto appears at the end of this data sheet.

DLP is a registered trademark of Texas Instruments. SMBus is a trademark of Intel Corp. All other trademarks are the property of their respective owners.



CAUTION: The THS4051 and THS4052 provide ESD protection circuitry. However, permanent damage can still occur if this device is subjected to high-energy electrostatic discharges. Proper ESD precautions are recommended to avoid any performance degradation or loss of functionality.

ABSOLUTE MAXIMUM RATINGS OVER OPERATING FREE-AIR TEMPERATURE (UNLESS OTHERWISE NOTED)⁽¹⁾

Supply voltage, V_{CC}	± 16.5 V
Input voltage, V_I	$\pm V_{CC}$
Output current, I_O	150 mA
Differential input voltage, V_{IO}	± 4 V
Continuous total power dissipation	See Dissipation Rating Table
Maximum junction temperature, T_J	150°C
Operating free-air temperature, T_A :	C-suffix	0°C to 70°C
	I-suffix	-40°C to 85°C
	M-suffix	-55°C to 125°C
Storage temperature, T_{stg}	-65°C to 150°C
Lead temperature 1,6 mm (1/16 inch) from case for 10 seconds	300°C
Lead temperature 1,6 mm (1/16 inch) from case for 60 seconds, JG package	300°C
Case temperature for 60 seconds, FK package	260°C

⁽¹⁾ Stresses beyond those listed under absolute maximum ratings may cause permanent damage to the device. These are stress ratings only and functional operation of the device at these or any other conditions beyond those indicated under “recommended operating conditions” is not implied. Exposure to absolute-maximum-rated conditions for extended periods may affect device reliability.

DISSIPATION RATING TABLE

PACKAGE	θ_{JA} (°C/W)	θ_{JC} (°C/W)	$T_A = 25^\circ\text{C}$ POWER RATING
D	167‡	38.3	740 mW
DGN§	58.4	4.7	2.14 W
JG	119	28	1050 mW
FK	87.7	20	1375 mW

‡ This data was taken using the JEDEC standard Low-K test PCB. For the JEDEC Proposed High-K test PCB, the θ_{JA} is 95°C/W with a power rating at $T_A = 25^\circ\text{C}$ of 1.32 W.

§ This data was taken using 2 oz. trace and copper pad that is soldered directly to a 3 in. x 3 in. PC. For further information, refer to *Application Information* section of this data sheet.

RECOMMENDED OPERATING CONDITIONS

		MIN	NOM	MAX	UNIT
Supply voltage, V_{CC+} and V_{CC-}	Dual supply	± 4.5		± 16	V
	Single supply	9		32	
Operating free-air temperature, T_A	C-suffix	0		70	°C
	I-suffix	-40		85	
	M-suffix	-55		125	

AVAILABLE OPTIONS(1)

T _A	NUMBER OF CHANNELS	PACKAGED DEVICES					EVALUATION MODULE
		PLASTIC SMALL OUTLINE† (D)	PLASTIC MSOP† (DGN)		CERAMIC DIP (JG)	CHIP CARRIER (FK)	
			DEVICE	SYMBOL			
0°C to 70°C	1	THS4051CD	THS4051CDGN	ACQ	—	—	THS4051EVM
	2	THS4052CD	THS4052CDGN‡	ACE	—	—	THS4052EVM
-40°C to 85°C	1	THS4051ID	THS4051IDGN	ACR	—	—	—
	2	THS4052ID	THS4052IDGN‡	ACF	—	—	—
-55°C to 125°C	1	—	—	—	THS4051MJG	THS4051MFK	—

(1) For the most current package and ordering information see the Package Option Addendum at the end of this document, or see the TI web site at www.ti.com.

† The D and DGN packages are available taped and reeled. Add an R suffix to the device type (i.e., THS4051CDGN).

‡ This device is in the Product Preview stage of development. Please contact your local TI sales office for availability.

FUNCTIONAL BLOCK DIAGRAM

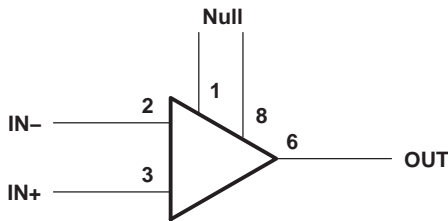

Figure 1. THS4051 – Single Channel

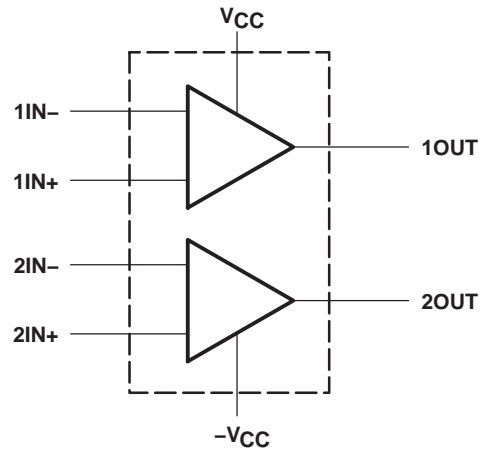
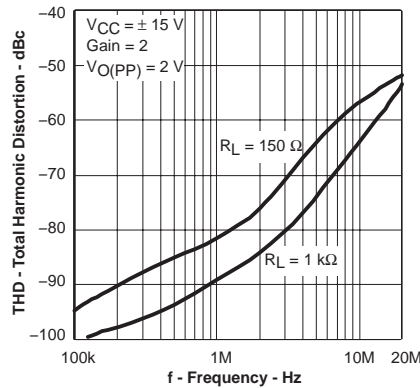

Figure 2. THS4052 – Dual Channel

T HARMONIC DISTORTION
vs
FREQUENCY



ELECTRICAL CHARACTERISTICS AT $T_A = 25^\circ\text{C}$, $V_{CC} = \pm 15\text{ V}$, $R_L = 150\ \Omega$ (unless otherwise noted)

dynamic performance

PARAMETER		TEST CONDITIONS†		THS405xC, THS405xI			UNIT
				MIN	TYP	MAX	
BW	Dynamic performance small-signal bandwidth (-3 dB)	$V_{CC} = \pm 15\text{ V}$	Gain = 1	70			MHz
		$V_{CC} = \pm 5\text{ V}$		70			
		$V_{CC} = \pm 15\text{ V}$	Gain = 2	38			MHz
		$V_{CC} = \pm 5\text{ V}$		38			
	Bandwidth for 0.1 dB flatness	$V_{CC} = \pm 15\text{ V}$	Gain = 1	30			MHz
		$V_{CC} = \pm 5\text{ V}$		30			
Full power bandwidth‡	$V_{O(pp)} = 20\text{ V}$, $V_{CC} = \pm 15\text{ V}$		3.8			MHz	
	$V_{O(pp)} = 5\text{ V}$, $V_{CC} = \pm 5\text{ V}$		12.7				
SR	Slew rate‡	$V_{CC} = \pm 15\text{ V}$, 20-V step,	Gain = 5	240			V/ μs
		$V_{CC} = \pm 5\text{ V}$, 5-V step	Gain = -1	200			
t_s	Settling time to 0.1%	$V_{CC} = \pm 15\text{ V}$, 5-V step	Gain = -1	60			ns
		$V_{CC} = \pm 5\text{ V}$, 2-V step		60			
	Settling time to 0.01%	$V_{CC} = \pm 15\text{ V}$, 5-V step	Gain = -1	130			ns
		$V_{CC} = \pm 5\text{ V}$, 2-V step		140			

† Full range = 0°C to 70°C for C suffix and -40°C to 85°C for I suffix

‡ Slew rate is measured from an output level range of 25% to 75%.

§ Full power bandwidth = $\text{slew rate} / 2\pi V_{O(\text{Peak})}$.

noise/distortion performance

PARAMETER		TEST CONDITIONS†			THS405xC, THS405xI			UNIT
					MIN	TYP	MAX	
THD	Total harmonic distortion	$V_{O(pp)} = 2\text{ V}$, $f = 1\text{ MHz}$, Gain = 2	$V_{CC} = \pm 15\text{ V}$	$R_L = 150\ \Omega$	-82			dBc
				$R_L = 1\text{ k}\Omega$	-89			
			$V_{CC} = \pm 5\text{ V}$	$R_L = 150\ \Omega$	-78			
				$R_L = 1\text{ k}\Omega$	-87			
V_n	Input voltage noise	$V_{CC} = \pm 5\text{ V}$ or $\pm 15\text{ V}$,	$f = 10\text{ kHz}$		14		$\text{nV}/\sqrt{\text{Hz}}$	
I_n	Input current noise	$V_{CC} = \pm 5\text{ V}$ or $\pm 15\text{ V}$,	$f = 10\text{ kHz}$		0.9		$\text{pA}/\sqrt{\text{Hz}}$	
	Differential gain error	Gain = 2, 40 IRE modulation,	NTSC, $\pm 100\text{ IRE ramp}$	$V_{CC} = \pm 15\text{ V}$	0.01%			
				$V_{CC} = \pm 5\text{ V}$	0.01%			
	Differential phase error	Gain = 2, 40 IRE modulation,	NTSC, $\pm 100\text{ IRE ramp}$	$V_{CC} = \pm 15\text{ V}$	0.01°			
				$V_{CC} = \pm 5\text{ V}$	0.03°			
	Channel-to-channel crosstalk (THS4052 only)	$V_{CC} = \pm 5\text{ V}$ or $\pm 15\text{ V}$,	$f = 1\text{ MHz}$		-57		dB	

† Full range = 0°C to 70°C for C suffix and -40°C to 85°C for I suffix.

electrical characteristics at $T_A = 25^\circ\text{C}$, $V_{CC} = \pm 15\text{ V}$, $R_L = 150\ \Omega$ (unless otherwise noted) (continued)
dc performance

PARAMETER	TEST CONDITIONS†	THS405xC, THS405xI			UNIT
		MIN	TYP	MAX	
Open loop gain	$V_{CC} = \pm 15\text{ V}$, $R_L = 1\text{ k}\Omega$ $V_O = \pm 10\text{ V}$	$T_A = 25^\circ\text{C}$	5	9	V/mV
		$T_A = \text{full range}$	3		
	$V_{CC} = \pm 5\text{ V}$, $R_L = 250\ \Omega$ $V_O = \pm 2.5\text{ V}$	$T_A = 25^\circ\text{C}$	2.5	6	V/mV
		$T_A = \text{full range}$	2		
V_{OS} Input offset voltage	$V_{CC} = \pm 5\text{ V}$ or $\pm 15\text{ V}$	$T_A = 25^\circ\text{C}$	2.5	10	mV
		$T_A = \text{full range}$		12	
Offset voltage drift	$V_{CC} = \pm 5\text{ V}$ or $\pm 15\text{ V}$	$T_A = \text{full range}$	15		$\mu\text{V}/^\circ\text{C}$
I_{IB} Input bias current	$V_{CC} = \pm 5\text{ V}$ or $\pm 15\text{ V}$	$T_A = 25^\circ\text{C}$	2.5	6	μA
		$T_A = \text{full range}$		8	
I_{OS} Input offset current	$V_{CC} = \pm 5\text{ V}$ or $\pm 15\text{ V}$	$T_A = 25^\circ\text{C}$	35	250	nA
		$T_A = \text{full range}$		400	
Offset current drift	$T_A = \text{full range}$		0.3		$\text{nA}/^\circ\text{C}$

† Full range = 0°C to 70°C for C suffix and -40°C to 85°C for I suffix

input characteristics

PARAMETER	TEST CONDITIONS†	THS405xC, THS405xI			UNIT
		MIN	TYP	MAX	
V_{ICR} Common-mode input voltage range	$V_{CC} = \pm 15\text{ V}$	± 13.8	± 14.3		V
	$V_{CC} = \pm 5\text{ V}$	± 3.8	± 4.3		
$CMRR$ Common mode rejection ratio	$V_{CC} = \pm 15\text{ V}$, $V_{ICR} = \pm 12\text{ V}$	$T_A = \text{full range}$	70	100	dB
	$V_{CC} = \pm 5\text{ V}$, $V_{ICR} = \pm 2.5\text{ V}$		70	100	
r_i Input resistance			1		$\text{M}\Omega$
C_i Input capacitance			1.5		pF

† Full range = 0°C to 70°C for C suffix and -40°C to 85°C for I suffix

output characteristics

PARAMETER	TEST CONDITIONS†	THS405xC, THS405xI			UNIT
		MIN	TYP	MAX	
V_O Output voltage swing	$V_{CC} = \pm 15\text{ V}$ $R_L = 250\ \Omega$	± 11.5	± 13		V
	$V_{CC} = \pm 5\text{ V}$ $R_L = 150\ \Omega$	± 3.2	± 3.5		
	$V_{CC} = \pm 15\text{ V}$ $R_L = 1\text{ k}\Omega$	± 13	± 13.6		V
	$V_{CC} = \pm 5\text{ V}$ $R_L = 1\text{ k}\Omega$	± 3.5	± 3.8		
I_O Output current‡	$V_{CC} = \pm 15\text{ V}$ $R_L = 20\ \Omega$	80	100		mA
	$V_{CC} = \pm 5\text{ V}$ $R_L = 20\ \Omega$	50	75		
I_{SC} Short-circuit current‡	$V_{CC} = \pm 15\text{ V}$		150		mA
R_O Output resistance	Open loop		13		Ω

† Full range = 0°C to 70°C for C suffix and -40°C to 85°C for I suffix

‡ Observe power dissipation ratings to keep the junction temperature below the absolute maximum rating when the output is heavily loaded or shorted. See the absolute maximum ratings section of this data sheet for more information.

electrical characteristics at $T_A = 25^\circ\text{C}$, $V_{CC} = \pm 15\text{ V}$, $R_L = 150\ \Omega$ (unless otherwise noted) (continued)

power supply

PARAMETER	TEST CONDITIONS†	THS405xC, THS405xI			UNIT
		MIN	TYP	MAX	
V_{CC} Supply voltage operating range	Dual supply	±4.5		±16.5	V
	Single supply	9		33	
I_{CC} Supply current (per amplifier)	$V_{CC} = \pm 15\text{ V}$	$T_A = 25^\circ\text{C}$	8.5	10.5	mA
		$T_A = \text{full range}$	11.5		
	$V_{CC} = \pm 5\text{ V}$	$T_A = 25^\circ\text{C}$	7.5	9.5	
		$T_A = \text{full range}$	10.5		
PSRR Power supply rejection ratio	$V_{CC} = \pm 5\text{ V}$ or $\pm 15\text{ V}$	$T_A = 25^\circ\text{C}$	70	84	dB
		$T_A = \text{full range}$	68		

† Full range = 0°C to 70°C for C suffix and -40°C to 85°C for I suffix

ELECTRICAL CHARACTERISTICS AT $T_A = \text{FULL RANGE}$, $V_{CC} = \pm 15\text{ V}$, $R_L = 1\text{ k}\Omega$ (UNLESS OTHERWISE NOTED)

dynamic performance

PARAMETER	TEST CONDITIONS†	THS4051M			UNIT	
		MIN	TYP	MAX		
BW	Unity gain bandwidth	$V_{CC} = \pm 15\text{ V}$, Closed loop	$R_L = 1\text{ k}\Omega$	50§	70	MHz
	Dynamic performance small-signal bandwidth (–3 dB)	$V_{CC} = \pm 15\text{ V}$	Gain = 1	70		MHz
		$V_{CC} = \pm 5\text{ V}$		70		
		$V_{CC} = \pm 15\text{ V}$	Gain = 2	38		
		$V_{CC} = \pm 5\text{ V}$		38		
	Bandwidth for 0.1 dB flatness	$V_{CC} = \pm 15\text{ V}$	Gain = 1	30		MHz
		$V_{CC} = \pm 5\text{ V}$		30		
	Full power bandwidth‡	$V_{O(\text{pp})} = 20\text{ V}$, $V_{CC} = \pm 15\text{ V}$		3.8		MHz
$V_{O(\text{pp})} = 5\text{ V}$, $V_{CC} = \pm 5\text{ V}$		12.7				
SR Slew rate	$V_{CC} = \pm 15\text{ V}$,	$R_L = 1\text{ k}\Omega$	240§	300	$\text{V}/\mu\text{s}$	
	$V_{CC} = \pm 5\text{ V}$, 5-V step		Gain = –1			200
t_s	Settling time to 0.1%	$V_{CC} = \pm 15\text{ V}$, 5-V step	Gain = –1	60		ns
		$V_{CC} = \pm 5\text{ V}$, 2-V step		60		
	Settling time to 0.01%	$V_{CC} = \pm 15\text{ V}$, 5-V step	Gain = –1	130		ns
		$V_{CC} = \pm 5\text{ V}$, 2-V step		140		

† Full range = -55°C to 125°C for the THS4051M.

‡ Full power bandwidth = $\text{slew rate}/2\pi V_{O(\text{Peak})}$.

§ This parameter is not tested.

electrical characteristics at T_A = full range, $V_{CC} = \pm 15$ V, $R_L = 1$ k Ω (unless otherwise noted)

noise/distortion performance

PARAMETER	TEST CONDITIONS†			THS4051M			UNIT
				MIN	TYP	MAX	
THD Total harmonic distortion	$V_{O(pp)} = 2$ V, $f = 1$ MHz, Gain = 2, $T_A = 25^\circ\text{C}$	$V_{CC} = \pm 15$ V	$R_L = 150 \Omega$	-82			dBc
			$R_L = 1$ k Ω	-89			
		$V_{CC} = \pm 5$ V	$R_L = 150 \Omega$	-78			
			$R_L = 1$ k Ω	-87			
V_n Input voltage noise	$V_{CC} = \pm 5$ V or ± 15 V, $T_A = 25^\circ\text{C}$	$f = 10$ kHz,	$R_L = 150 \Omega$	14			nV/ $\sqrt{\text{Hz}}$
I_n Input current noise	$V_{CC} = \pm 5$ V or ± 15 V, $T_A = 25^\circ\text{C}$	$f = 10$ kHz,	$R_L = 150 \Omega$	0.9			pA/ $\sqrt{\text{Hz}}$
Differential gain error	Gain = 2, 40 IRE modulation, $T_A = 25^\circ\text{C}$,	NTSC, ± 100 IRE ramp, $R_L = 150 \Omega$	$V_{CC} = \pm 15$ V	0.01%			
			$V_{CC} = \pm 5$ V	0.01%			
Differential phase error	Gain = 2, 40 IRE modulation, $T_A = 25^\circ\text{C}$,	NTSC, ± 100 IRE ramp, $R_L = 150 \Omega$	$V_{CC} = \pm 15$ V	0.01°			
			$V_{CC} = \pm 5$ V	0.03°			

† Full range = -55°C to 125°C for the THS4051M.

dc performance

PARAMETER	TEST CONDITIONS†			THS4051M			UNIT
				MIN	TYP	MAX	
Open loop gain	$V_{CC} = \pm 15$ V, $V_O = \pm 10$ V	$T_A = 25^\circ\text{C}$	$T_A = 25^\circ\text{C}$	5	9		V/mV
			$T_A = \text{full range}$	3			
	$V_{CC} = \pm 5$ V, $V_O = \pm 2.5$ V	$T_A = 25^\circ\text{C}$	$T_A = 25^\circ\text{C}$	2.5	6		V/mV
			$T_A = \text{full range}$	2			
V_{IO} Input offset voltage	$V_{CC} = \pm 5$ V or ± 15 V	$T_A = 25^\circ\text{C}$	$T_A = 25^\circ\text{C}$	2.5	10		mV
$T_A = \text{full range}$				13			
Offset voltage drift	$V_{CC} = \pm 5$ V or ± 15 V	$T_A = \text{full range}$		15			$\mu\text{V}/^\circ\text{C}$
I_{IB} Input bias current	$V_{CC} = \pm 5$ V or ± 15 V	$T_A = 25^\circ\text{C}$	$T_A = 25^\circ\text{C}$	2.5	6		μA
			$T_A = \text{full range}$		8		
I_{IO} Input offset current	$V_{CC} = \pm 5$ V or ± 15 V	$T_A = 25^\circ\text{C}$	$T_A = 25^\circ\text{C}$	35	250		nA
			$T_A = \text{full range}$		400		
Offset current drift	$T_A = \text{full range}$			0.3			nA/ $^\circ\text{C}$

† Full range = -55°C to 125°C for the THS4051M.

input characteristics

PARAMETER	TEST CONDITIONS†			THS4051M			UNIT
				MIN	TYP	MAX	
V_{ICR} Common-mode input voltage range	$V_{CC} = \pm 15$ V			± 13.8	± 14.3		V
	$V_{CC} = \pm 5$ V			± 3.8	± 4.3		
CMRR Common mode rejection ratio	$V_{CC} = \pm 15$ V, $V_{ICR} = \pm 12$ V	$T_A = \text{full range}$		70	100		dB
	$V_{CC} = \pm 5$ V, $V_{ICR} = \pm 2.5$ V			70	100		
r_i Input resistance				1			M Ω
C_i Input capacitance				1.5			pF

† Full range = -55°C to 125°C for the THS4051M.

**electrical characteristics at T_A = full range, $V_{CC} = \pm 15$ V, $R_L = 1$ k Ω (unless otherwise noted)
(continued)**

output characteristics

PARAMETER	TEST CONDITIONS†		THS4051M			UNIT
			MIN	TYP	MAX	
V_O Output voltage swing	$V_{CC} = \pm 15$ V	$R_L = 250 \Omega$	± 12	± 13	V	
	$V_{CC} = \pm 5$ V	$R_L = 150 \Omega$	± 3.2	± 3.5		
	$V_{CC} = \pm 15$ V	$R_L = 1$ k Ω	± 13	± 13.6	V	
	$V_{CC} = \pm 5$ V		± 3.5	± 3.8		
I_O Output current‡	$V_{CC} = \pm 15$ V, $T_A = 25^\circ\text{C}$	$R_L = 20 \Omega$	80	100	mA	
	$V_{CC} = \pm 15$ V, $T_A = \text{full range}$		70			
	$V_{CC} = \pm 5$ V		50	75		
I_{SC} Short-circuit current‡	$V_{CC} = \pm 15$ V		150		mA	
R_O Output resistance	Open loop		13		W	

† Full range = -55°C to 125°C for the THS4051M.

‡ Observe power dissipation ratings to keep the junction temperature below the absolute maximum rating when the output is heavily loaded or shorted. See the absolute maximum ratings section of this data sheet for more information.

power supply

PARAMETER	TEST CONDITIONS†		THS4051M			UNIT
			MIN	TYP	MAX	
V_{CC} Supply voltage operating range	Dual supply		± 4.5		± 16.5	V
	Single supply		9		33	
I_{CC} Supply current (per amplifier)	$V_{CC} = \pm 15$ V	$T_A = 25^\circ\text{C}$	8.5		10.5	mA
		$T_A = \text{full range}$			11.5	
	$V_{CC} = \pm 5$ V	$T_A = 25^\circ\text{C}$	7.5		9.5	
		$T_A = \text{full range}$			10.5	
PSRR Power supply rejection ratio	$V_{CC} = \pm 5$ V or ± 15 V	$T_A = \text{full range}$	70	84		dB

† Full range = -55°C to 125°C for the THS4051M.

TYPICAL CHARACTERISTICS

INPUT OFFSET VOLTAGE
vs
FREE-AIR TEMPERATURE

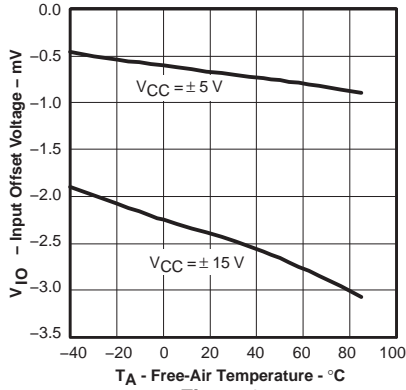

Figure 3

INPUT BIAS CURRENT
vs
FREE-AIR TEMPERATURE

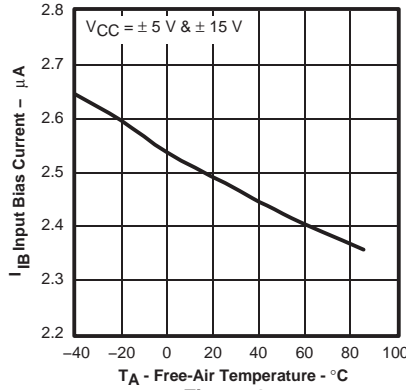

Figure 4

OUTPUT VOLTAGE
vs
SUPPLY VOLTAGE

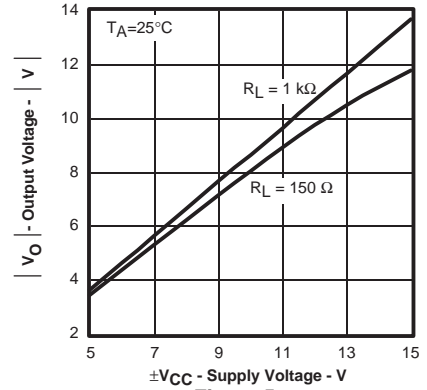

Figure 5

COMMON-MODE INPUT VOLTAGE
vs
SUPPLY VOLTAGE

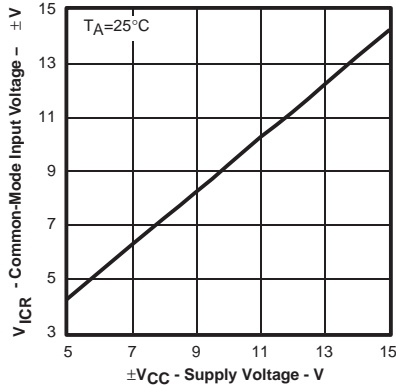

Figure 6

OUTPUT VOLTAGE
vs
FREE-AIR TEMPERATURE

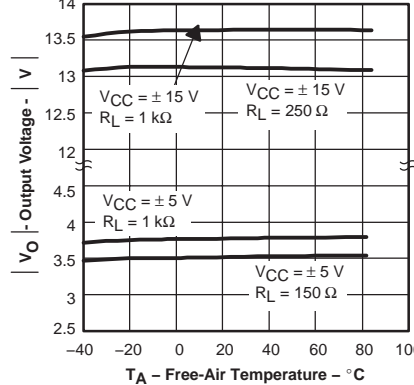

Figure 7

SUPPLY CURRENT
vs
SUPPLY VOLTAGE

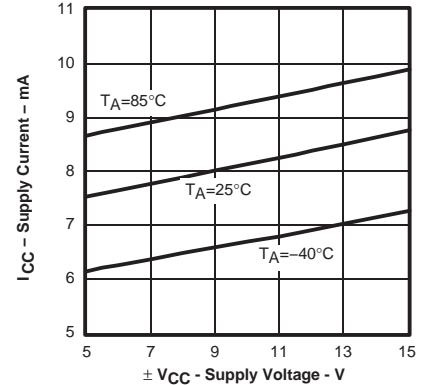

Figure 8

VOLTAGE & CURRENT NOISE
vs
FREQUENCY

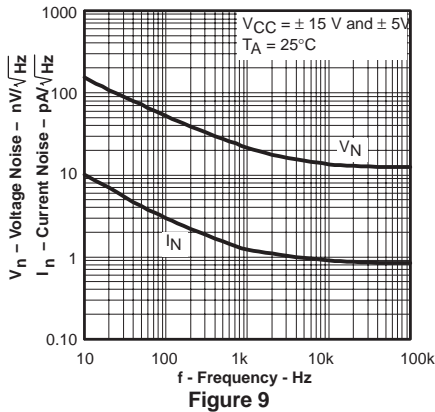

Figure 9

POWER-SUPPLY REJECTION
RATIO
vs
FREQUENCY

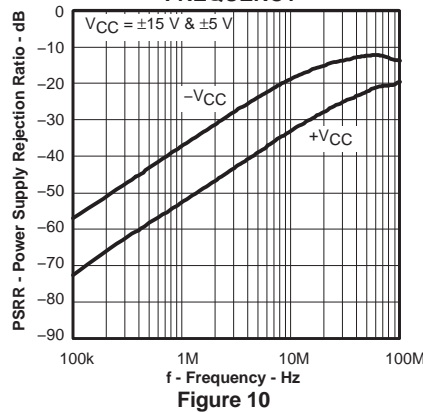

Figure 10

CMRR
vs
FREQUENCY

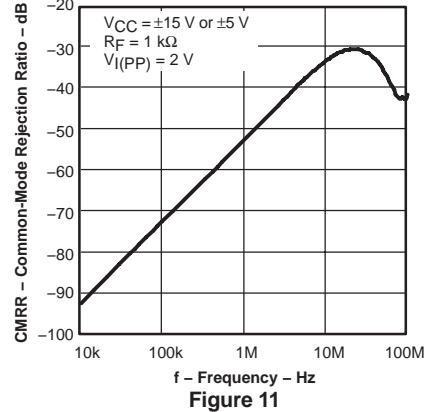

Figure 11

TYPICAL CHARACTERISTICS

CROSSTALK
vs
FREQUENCY

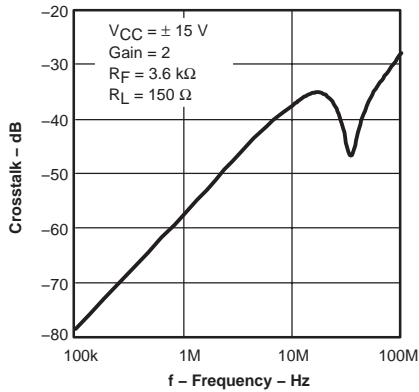

Figure 12

OPEN LOOP GAIN AND
PHASE RESPONSE
vs
FREQUENCY

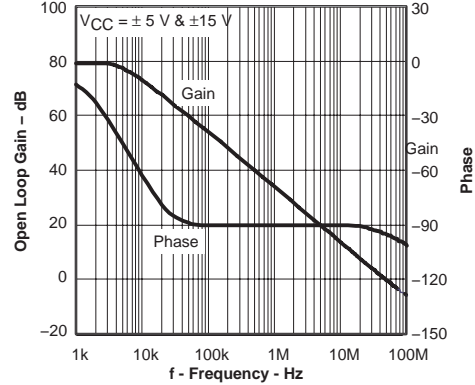

Figure 13

T HARMONIC DISTORTION
vs
FREQUENCY

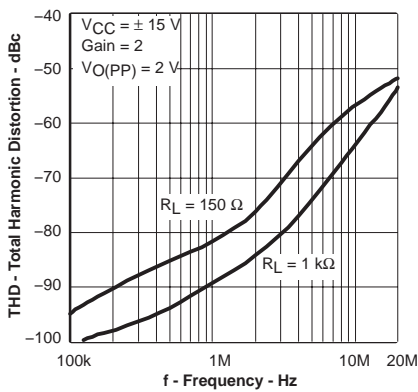

Figure 14

DISTORTION
vs
OUTPUT VOLTAGE

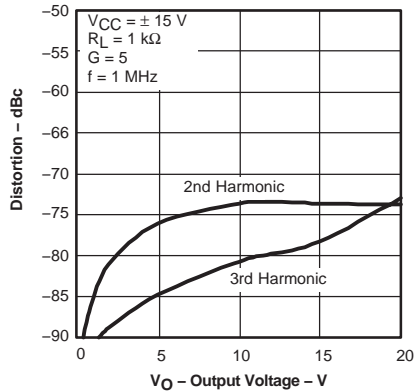

Figure 15

DISTORTION
vs
OUTPUT VOLTAGE

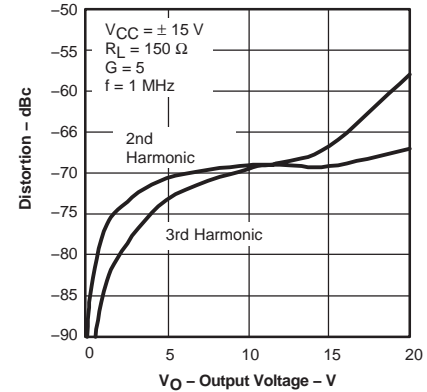

Figure 16

DISTORTION
vs
FREQUENCY

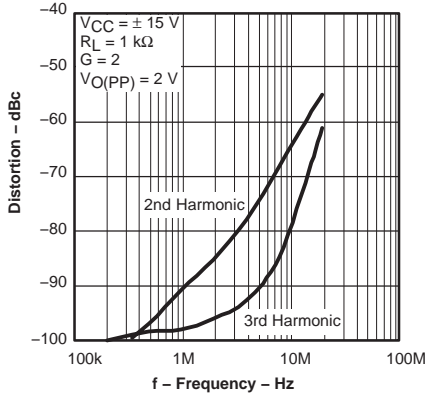

Figure 17

DISTORTION
vs
FREQUENCY

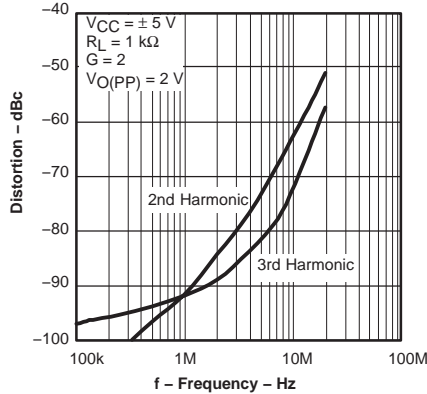

Figure 18

DISTORTION
vs
FREQUENCY

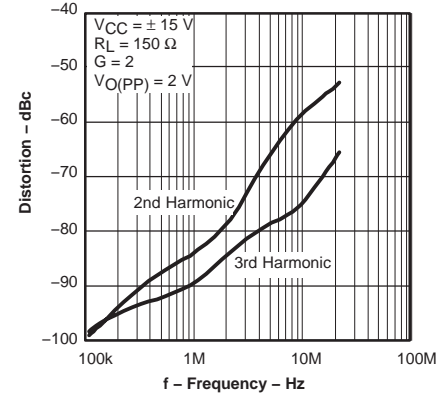
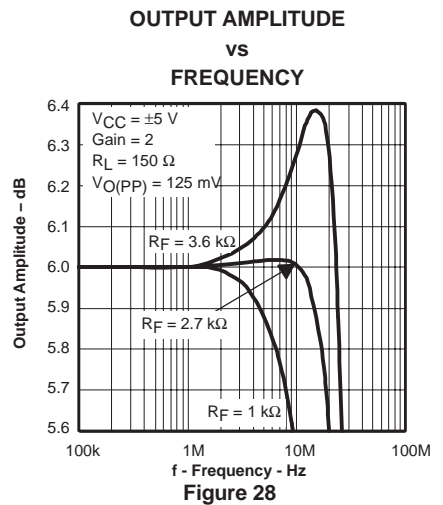
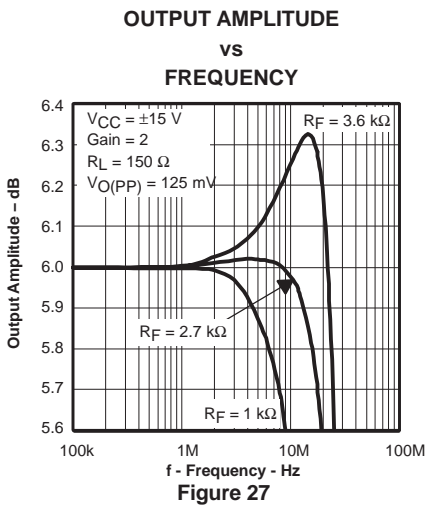
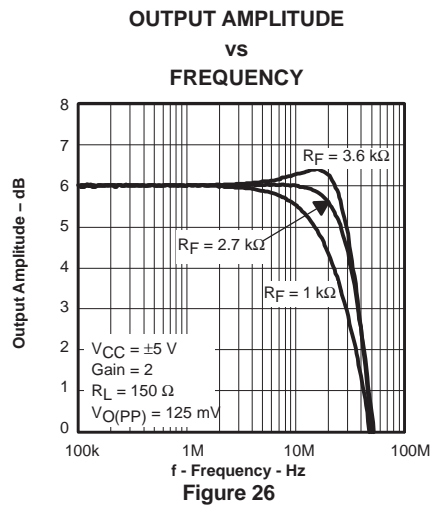
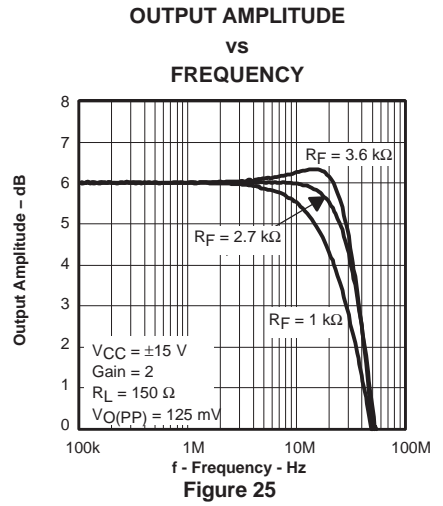
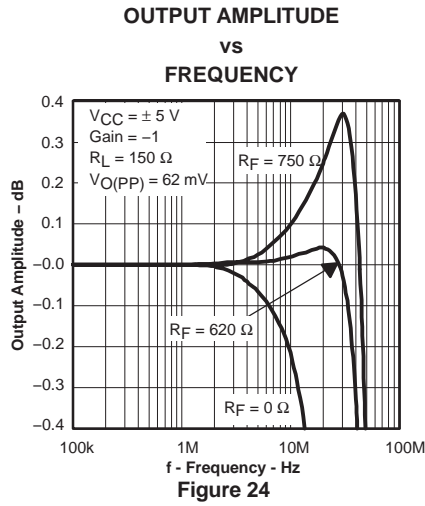
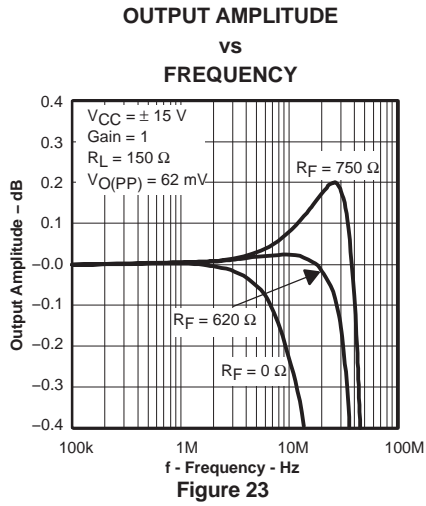
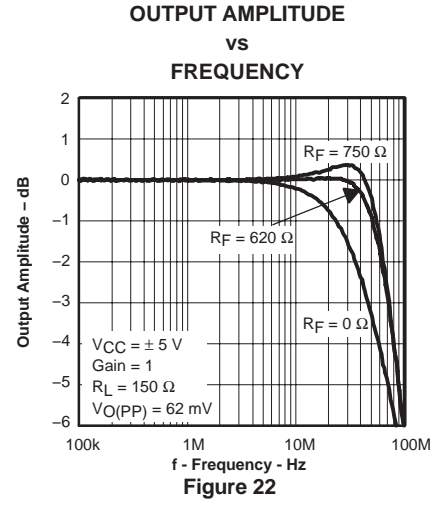
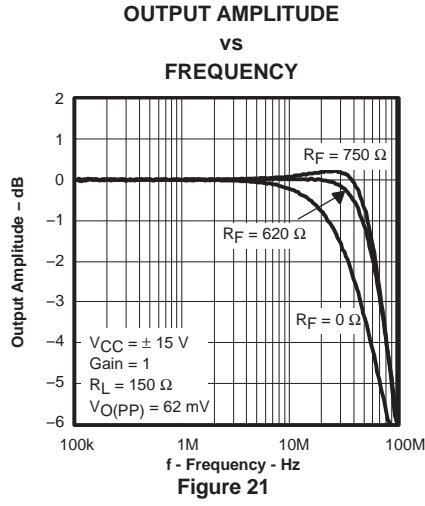
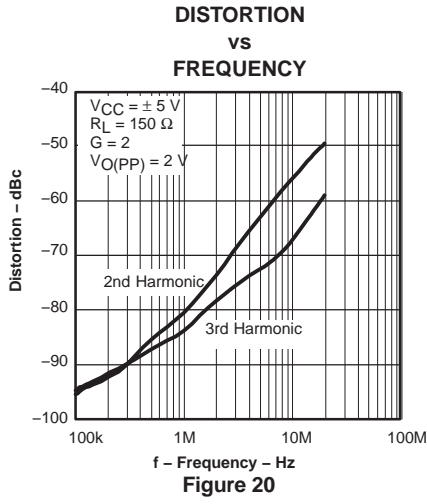
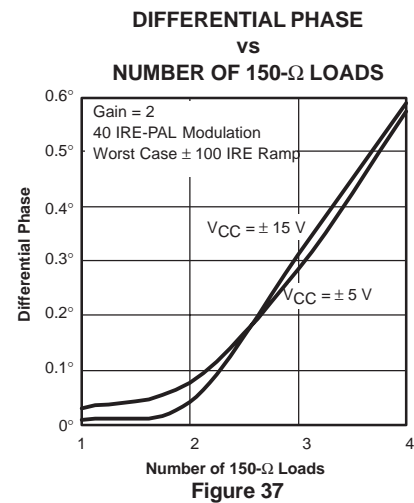
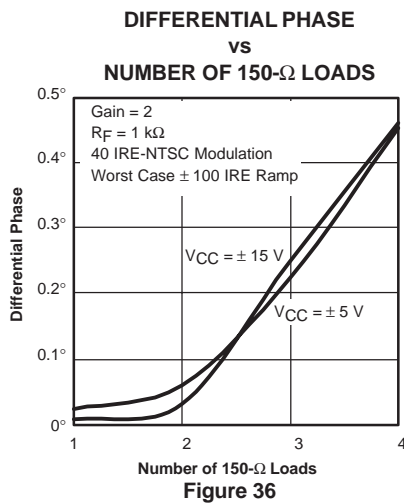
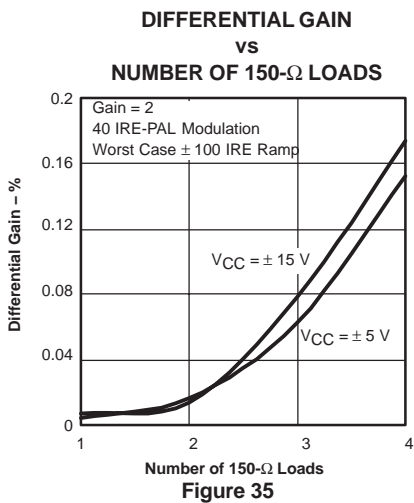
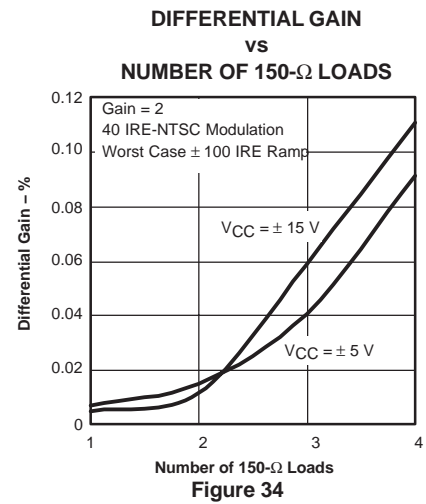
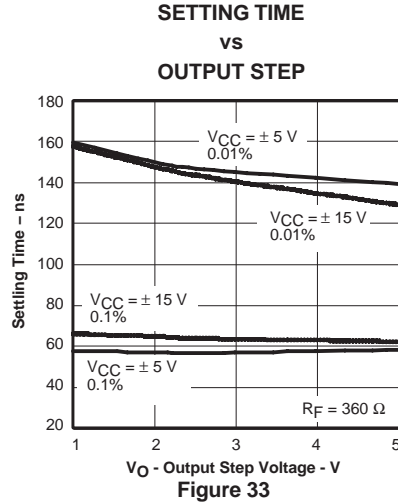
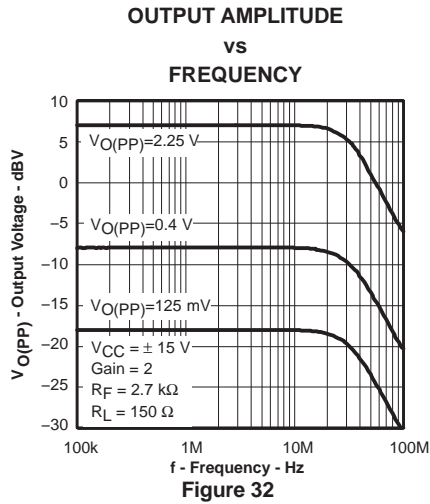
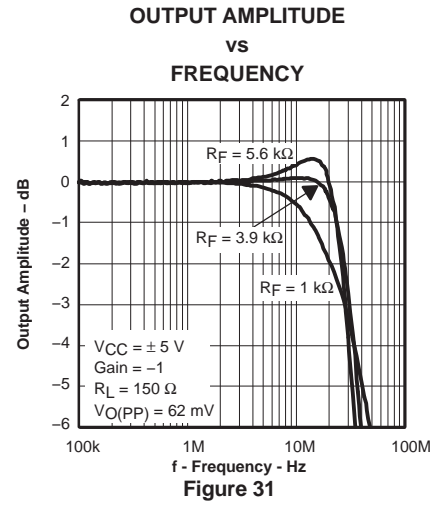
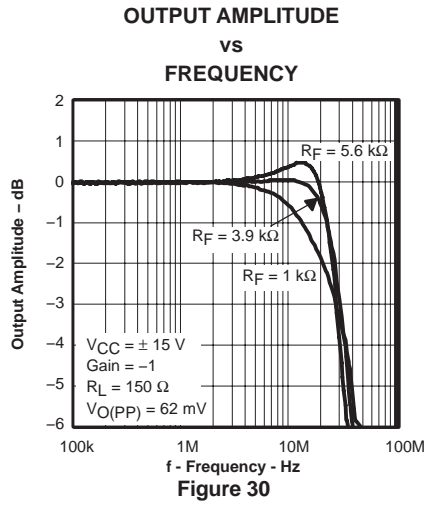
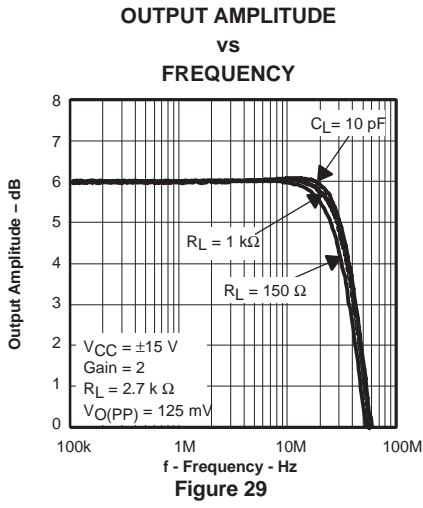

Figure 19

TYPICAL CHARACTERISTICS



TYPICAL CHARACTERISTICS



TYPICAL CHARACTERISTICS

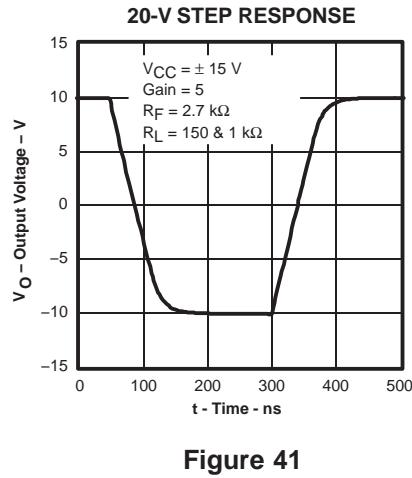
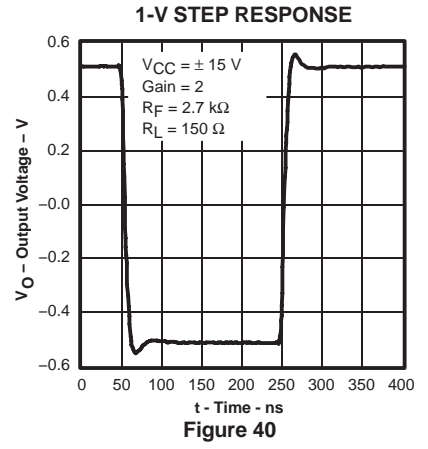
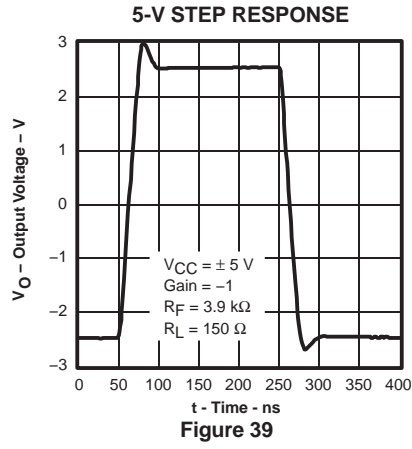
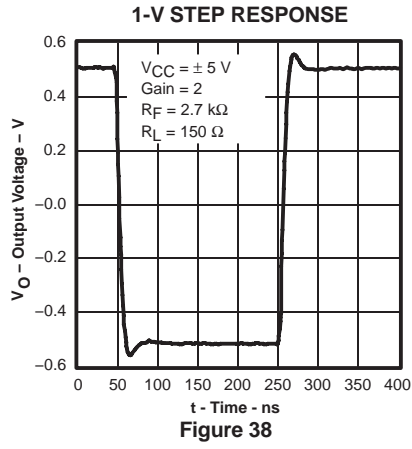

APPLICATION INFORMATION

THEORY OF OPERATION

The THS405x is a high-speed operational amplifier configured in a voltage feedback architecture. It is built using a 30-V, dielectrically isolated, complementary

bipolar process with NPN and PNP transistors possessing f_T s of several GHz. This results in an exceptionally high performance amplifier that has a wide bandwidth, high slew rate, fast settling time, and low distortion. A simplified schematic is shown in Figure 42.

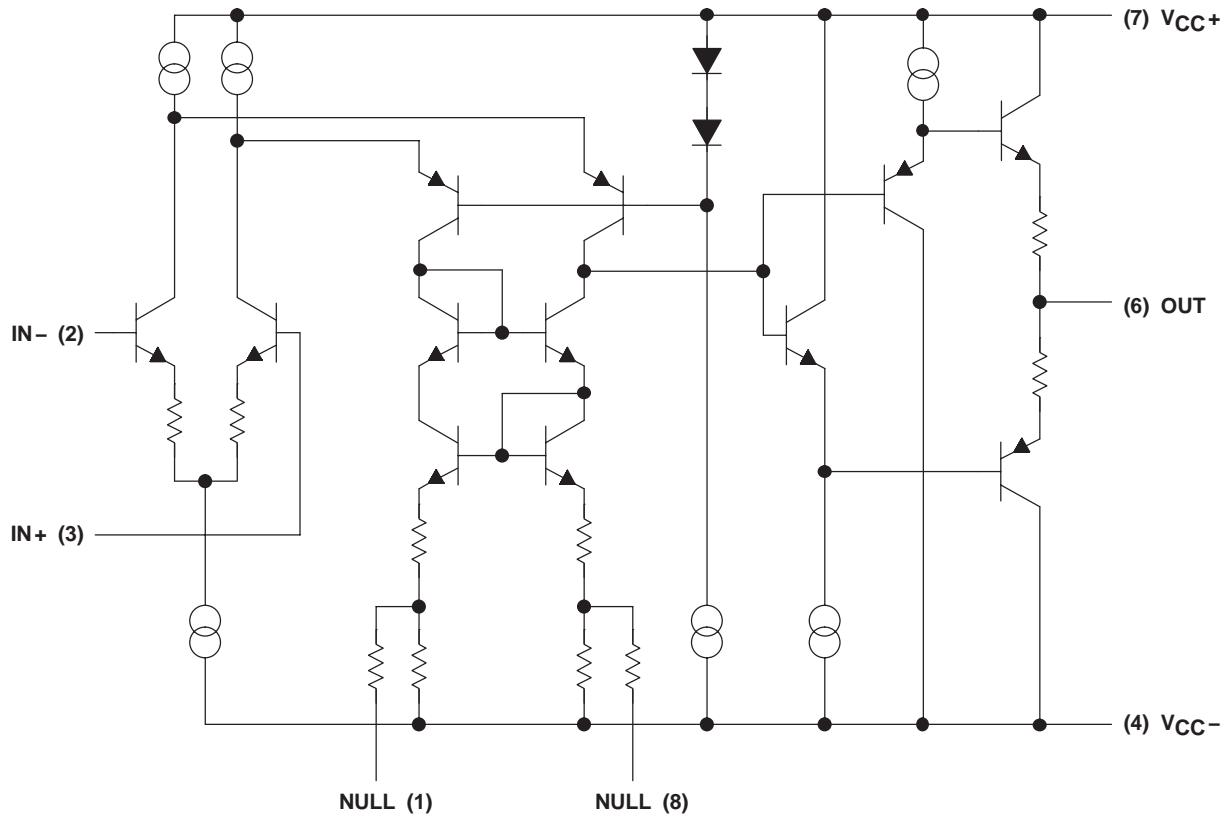

Figure 42. THS405x Simplified Schematic

NOISE CALCULATIONS AND NOISE FIGURE

Noise can cause errors on very small signals. This is especially true when amplifying small signals, where signal-to-noise ratio (SNR) is very important. The noise model for the THS405x is shown in Figure 43. This model includes all of the noise sources as follows:

- e_n = Amplifier internal voltage noise (nV/\sqrt{Hz})
- $IN+$ = Noninverting current noise (pA/\sqrt{Hz})
- $IN-$ = Inverting current noise (pA/\sqrt{Hz})
- e_{RX} = Thermal voltage noise associated with each resistor ($e_{RX} = 4 kTR_X$)

APPLICATION INFORMATION

NOISE CALCULATIONS AND NOISE FIGURE (CONTINUED)

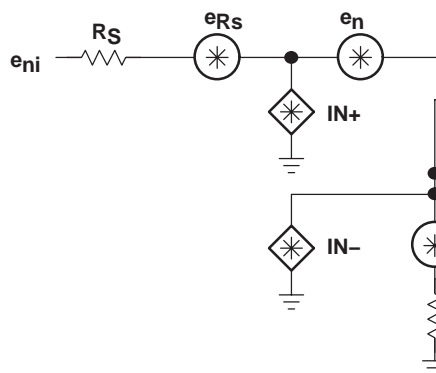

Figure 43. Noise Model

The total equivalent input noise density (e_{ni}) is calculated by using the following equation:

$$e_{ni} = \sqrt{(e_n)^2 + (IN+ \times R_S)^2 + (IN- \times (R_F \parallel R_G))^2 + 4kTR_S + 4kT(R_F \parallel R_G)}$$

Where:

k = Boltzmann's constant = 1.380658×10^{-23}

T = Temperature in degrees Kelvin ($273 + ^\circ\text{C}$)

$R_F \parallel R_G$ = Parallel resistance of R_F and R_G

To get the equivalent output noise of the amplifier, just multiply the equivalent input noise density (e_{ni}) by the overall amplifier gain (A_V).

$$e_{no} = e_{ni} A_V = e_{ni} \left(1 + \frac{R_F}{R_G} \right) \text{ (noninverting case)}$$

As the previous equations show, to keep noise at a minimum, small value resistors should be used. As the closed-loop gain is increased (by reducing R_G), the input noise is reduced considerably because of the parallel resistance term. This leads to the general conclusion that the most dominant noise sources are the source resistor (R_S) and the internal amplifier noise voltage (e_n). Because noise is summed in a root-mean-squares method, noise sources smaller than 25% of the largest noise source can be effectively ignored. This can greatly simplify the formula and make noise calculations much easier to calculate.

For more information on noise analysis, please refer to the *Noise Analysis* section in *Operational Amplifier Circuits Applications Report* (literature number SLVA043).

APPLICATION INFORMATION

NOISE CALCULATIONS AND NOISE FIGURE (CONTINUED)

This brings up another noise measurement usually preferred in RF applications, the noise figure (NF). Noise figure is a measure of noise degradation caused by the amplifier. The value of the source resistance must be defined and is typically 50 Ω in RF applications.

$$NF = 10\log \left[\frac{e_{ni}^2}{(e_{Rs})^2} \right]$$

Because the dominant noise components are generally the source resistance and the internal amplifier noise voltage, we can approximate noise figure as:

$$NF = 10\log \left[1 + \frac{\left[(e_n)^2 + (IN + \times R_S)^2 \right]}{4 kTR_S} \right]$$

Figure 44 shows the noise figure graph for the THS405x.

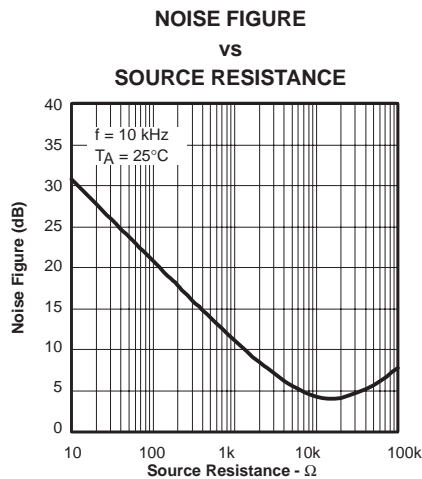

Figure 44. Noise Figure vs Source Resistance

APPLICATION INFORMATION

DRIVING A CAPACITIVE LOAD

Driving capacitive loads with high performance amplifiers is not a problem as long as certain precautions are taken. The first is to realize that the THS405x has been internally compensated to maximize its bandwidth and slew rate performance. When the amplifier is compensated in this manner, capacitive loading directly on the output will decrease the device's phase margin leading to high frequency ringing or oscillations. Therefore, for capacitive loads of greater than 10 pF, it is recommended that a resistor be placed in series with the output of the amplifier, as shown in Figure 45. A minimum value of 20 Ω should work well for most applications. For example, in 75-Ω transmission systems, setting the series resistor value to 75 Ω both isolates any capacitance loading and provides the proper line impedance matching at the source end.

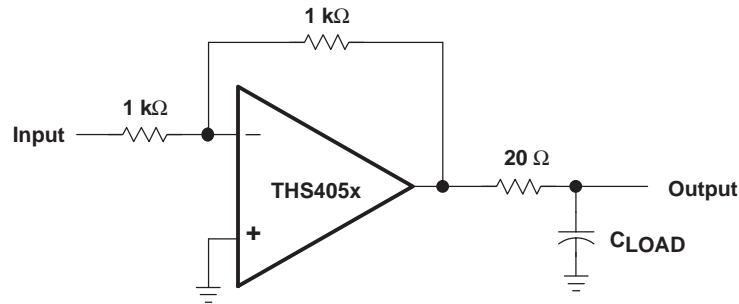

Figure 45. Driving a Capacitive Load

OFFSET NULLING

The THS405x has very low input offset voltage for a high-speed amplifier. However, if additional correction is required, an offset nulling function has been provided on the THS4051. The input offset can be adjusted by placing a potentiometer between terminals 1 and 8 of the device and tying the wiper to the negative supply. This is shown in Figure 46.

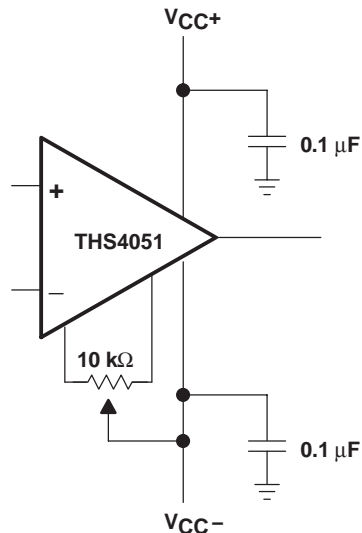
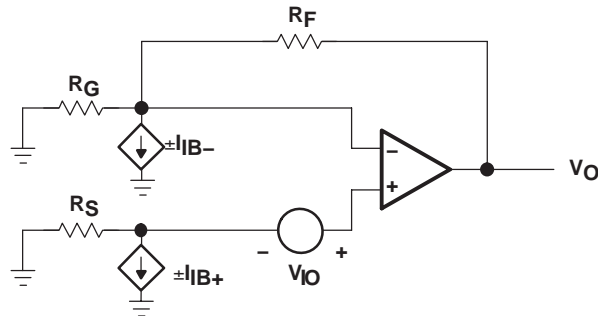

Figure 46. Offset Nulling Schematic

APPLICATION INFORMATION

OFFSET VOLTAGE

The output offset voltage, (V_{OO}) is the sum of the input offset voltage (V_{IO}) and both input bias currents (I_{IB}) times the corresponding gains. The following schematic and formula can be used to calculate the output offset voltage:



$$V_{OO} = V_{IO} \left(1 + \frac{R_F}{R_G} \right) \pm I_{IB+} R_S \left(1 + \frac{R_F}{R_G} \right) \pm I_{IB-} R_F$$

Figure 47. Output Offset Voltage Model

OPTIMIZING UNITY GAIN RESPONSE

Internal frequency compensation of the THS405x was selected to provide very wideband performance yet still maintain stability when operated in a noninverting unity gain configuration. When amplifiers are compensated in this manner there is usually peaking in the closed loop response and some ringing in the step response for very fast input edges, depending upon the application. This is because a minimum phase margin is maintained for the $G=+1$ configuration. For optimum settling time and minimum ringing, a feedback resistor of 620Ω should be used as shown in Figure 48. Additional capacitance can also be used in parallel with the feedback resistance if even finer optimization is required.

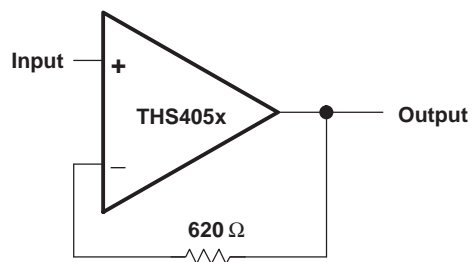

Figure 48. Noninverting, Unity Gain Schematic

APPLICATION INFORMATION

GENERAL CONFIGURATIONS

When receiving low-level signals, limiting the bandwidth of the incoming signals into the system is often required. The simplest way to accomplish this is to place an RC filter at the noninverting terminal of the amplifier (see Figure 49).

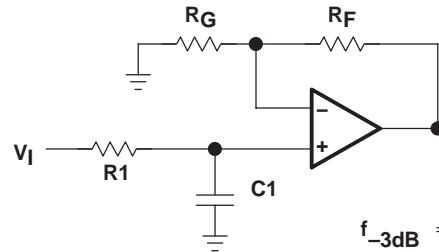

Figure 49. Single-Pole Low-Pass Filter

If even more attenuation is needed, a multiple pole filter is required. The Sallen-Key filter can be used for this task. For best results, the amplifier should have a bandwidth that is 8 to 10 times the filter frequency bandwidth. Failure to do this can result in phase shift of the amplifier.

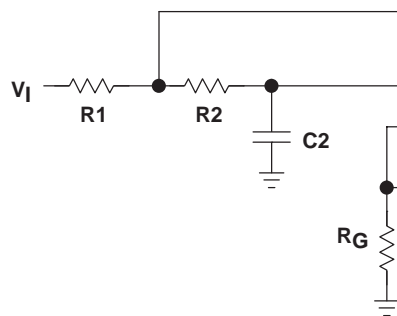

Figure 50. 2-Pole Low-Pass Sallen-Key Filter

APPLICATION INFORMATION

CIRCUIT LAYOUT CONSIDERATIONS

To achieve the levels of high frequency performance of the THS405x, follow proper printed-circuit board high frequency design techniques. A general set of guidelines is given below. In addition, a THS405x evaluation board is available to use as a guide for layout or for evaluating the device performance.

- Ground planes – It is highly recommended that a ground plane be used on the board to provide all components with a low inductive ground connection. However, in the areas of the amplifier inputs and output, the ground plane can be removed to minimize the stray capacitance.
- Proper power supply decoupling – Use a 6.8- μ F tantalum capacitor in parallel with a 0.1- μ F ceramic capacitor on each supply terminal. It may be possible to share the tantalum among several amplifiers depending on the application, but a 0.1- μ F ceramic capacitor should always be used on the supply terminal of every amplifier. In addition, the 0.1- μ F capacitor should be placed as close as possible to the supply terminal. As this distance increases, the inductance in the connecting trace makes the capacitor less effective. The designer should strive for distances of less than 0.1 inches between the device power terminals and the ceramic capacitors.
- Sockets – Sockets are not recommended for high-speed operational amplifiers. The additional lead inductance in the socket pins will often lead to stability problems. Surface-mount packages soldered directly to the printed-circuit board is the best implementation.
- Short trace runs/compact part placements – Optimum high frequency performance is achieved when stray series inductance has been minimized. To realize this, the circuit layout should be made as compact as possible, thereby minimizing the length of all trace runs. Particular attention should be paid to the inverting input of the amplifier. Its length should be kept as short as possible. This will help to minimize stray capacitance at the input of the amplifier.
- Surface-mount passive components – Using surface-mount passive components is recommended for high frequency amplifier circuits for several reasons. First, because of the extremely low lead inductance of surface-mount components, the problem with stray series inductance is greatly reduced. Second, the small size of surface-mount components naturally leads to a more compact layout thereby minimizing both stray inductance and capacitance. If leaded components are used, it is recommended that the lead lengths be kept as short as possible.

GENERAL POWERPAD™ DESIGN CONSIDERATIONS

The THS405x is available packaged in a thermally-enhanced DGN package, which is a member of the PowerPAD™ family of packages. This package is constructed using a downset leadframe upon which the die is mounted [see Figure 51(a) and Figure 51(b)]. This arrangement results in the lead frame being exposed as a thermal pad on the underside of the package [see Figure 51(c)]. Because this thermal pad has direct thermal contact with the die, excellent thermal performance can be achieved by providing a good thermal path away from the thermal pad.

The PowerPAD™ package allows for both assembly and thermal management in one manufacturing operation. During the surface-mount solder operation (when the leads are being soldered), the thermal pad can also be soldered to a copper area underneath the package. Through the use of thermal paths within this copper area, heat can be conducted away from the package into either a ground plane or other heat dissipating device.

The PowerPAD™ package represents a breakthrough in combining the small area and ease of assembly of the surface mount with the, heretofore, awkward mechanical methods of heatsinking.

APPLICATION INFORMATION

GENERAL POWERPAD™ DESIGN CONSIDERATIONS (CONTINUED)

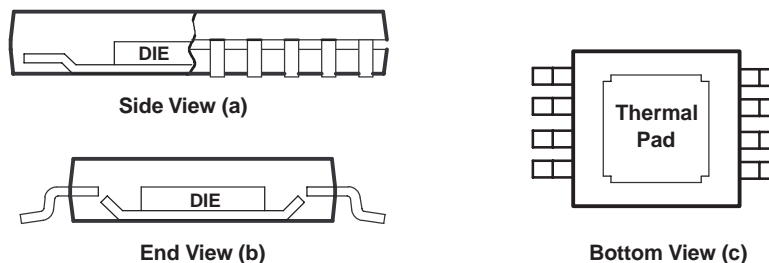

NOTE A: The thermal pad is electrically isolated from all terminals in the package.

Figure 51. Views of Thermally Enhanced DGN Package

Although there are many ways to properly heatsink this device, the following steps illustrate the recommended approach.

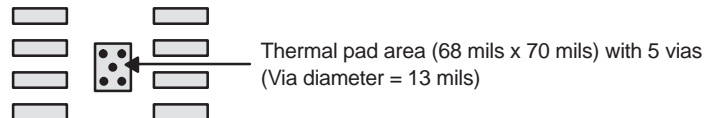

Figure 52. PowerPAD™ PCB Etch and Via Pattern

1. Prepare the PCB with a top side etch pattern as shown in Figure 52. There should be etch for the leads as well as etch for the thermal pad.
2. Place five holes in the area of the thermal pad. These holes should be 13 mils in diameter. Keep them small so that solder wicking through the holes is not a problem during reflow.
3. Additional vias may be placed anywhere along the thermal plane outside of the thermal pad area. This helps dissipate the heat generated by the THS405xDGN IC. These additional vias may be larger than the 13-mil diameter vias directly under the thermal pad. They can be larger because they are not in the thermal pad area to be soldered so that wicking is not a problem.
4. Connect all holes to the internal ground plane.
5. When connecting these holes to the ground plane, *do not* use the typical web or spoke via connection methodology. Web connections have a high thermal resistance connection that is useful for slowing the heat transfer during soldering operations. This makes the soldering of vias that have plane connections easier. In this application, however, low thermal resistance is desired for the most efficient heat transfer. Therefore, the holes under the THS405xDGN package should make their connection to the internal ground plane with a complete connection around the entire circumference of the plated-through hole.
6. The top-side solder mask should leave the terminals of the package and the thermal pad area with its five holes exposed. The bottom-side solder mask should cover the five holes of the thermal pad area. This prevents solder from being pulled away from the thermal pad area during the reflow process.
7. Apply solder paste to the exposed thermal pad area and all of the IC terminals.
8. With these preparatory steps in place, the THS405xDGN IC is simply placed in position and run through the solder reflow operation as any standard surface-mount component. This results in a part that is properly installed.

APPLICATION INFORMATION

GENERAL POWERPAD™ DESIGN CONSIDERATIONS (CONTINUED)

The actual thermal performance achieved with the THS405xDGN in its PowerPAD™ package depends on the application. In the example above, if the size of the internal ground plane is approximately 3 inches × 3 inches (or 76.2 mm × 76.2 mm), then the expected thermal coefficient, θ_{JA} , is about 58.4°C/W. For comparison, the non-PowerPAD™ version of the THS405x IC (SOIC) is shown. For a given θ_{JA} , the maximum power dissipation is shown in Figure 53 and is calculated by the following formula:

$$P_D = \left(\frac{T_{MAX} - T_A}{\theta_{JA}} \right)$$

Where:

- P_D = Maximum power dissipation of THS405x IC (watts)
- T_{MAX} = Absolute maximum junction temperature (150°C)
- T_A = Free-ambient air temperature (°C)
- θ_{JA} = $\theta_{JC} + \theta_{CA}$
- θ_{JC} = Thermal coefficient from junction to case
- θ_{CA} = Thermal coefficient from case to ambient air (°C/W)

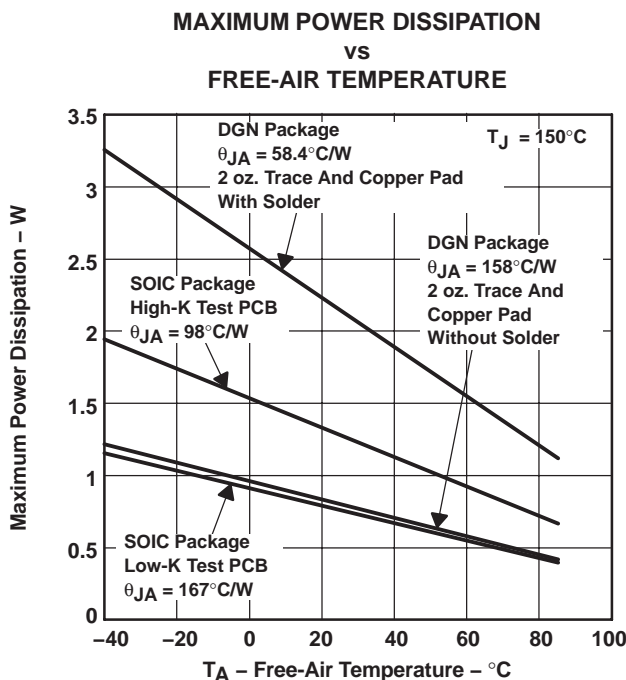

NOTE A: Results are with no air flow and PCB size = 3" × 3"

Figure 53. Maximum Power Dissipation vs Free-Air Temperature

More complete details of the PowerPAD™ installation process and thermal management techniques can be found in the Texas Instruments Technical Brief, *PowerPAD™ Thermally Enhanced Package*. This document can be found at the TI web site (www.ti.com) by searching on the key word PowerPAD™. The document can also be ordered through your local TI sales office. Refer to literature number SLMA002 when ordering.

APPLICATION INFORMATION

GENERAL POWERPAD™ DESIGN CONSIDERATIONS (CONTINUED)

The next consideration is the package constraints. The two sources of heat within an amplifier are quiescent power and output power. The designer should never forget about the quiescent heat generated within the device, especially devices with multiple amplifiers. Because these devices have linear output stages (Class A-B), most of the heat dissipation is at low output voltages with high output currents. Figure 54 to Figure 57 show this effect, along with the quiescent heat, with an ambient air temperature of 50°C. Obviously, as the ambient temperature increases, the limit lines shown will drop accordingly. The area under each respective limit line is considered the safe operating area. Any condition above this line will exceed the amplifier's limits and failure may result. When using $V_{CC} = \pm 5\text{ V}$, there is generally not a heat problem, even with SOIC packages. But, when using $V_{CC} = \pm 15\text{ V}$, the SOIC package is severely limited in the amount of heat it can dissipate. The other key factor when looking at these graphs is how the devices are mounted on the PCB. The PowerPAD™ devices are extremely useful for heat dissipation. But, the device should always be soldered to a copper plane to fully use the heat dissipation properties of the PowerPAD™. The SOIC package, on the other hand, is highly dependent on how it is mounted on the PCB. As more trace and copper area is placed around the device, θ_{JA} decreases and the heat dissipation capability increases. The currents and voltages shown in these graphs are for the total package. For the dual amplifier package (THS4052), the sum of the RMS output currents and voltages should be used to choose the proper package. The graphs shown assume that both amplifier outputs are identical.

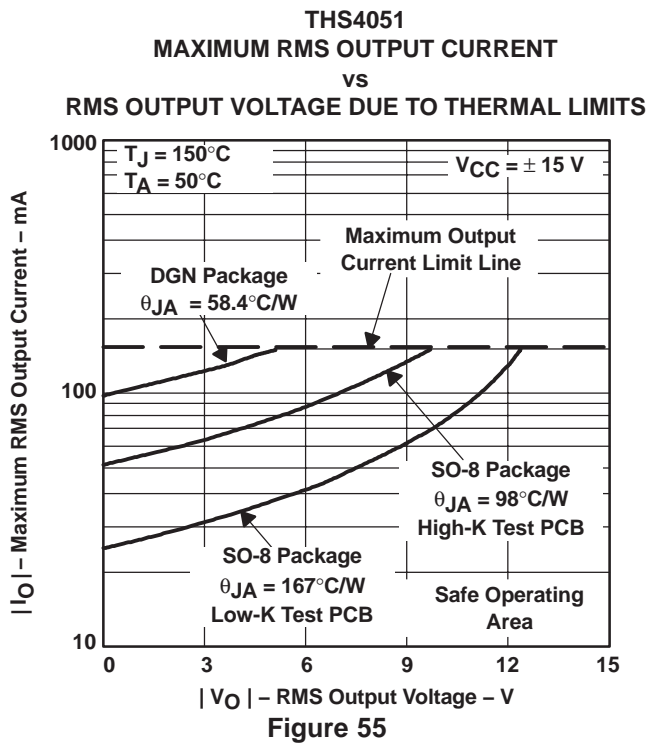
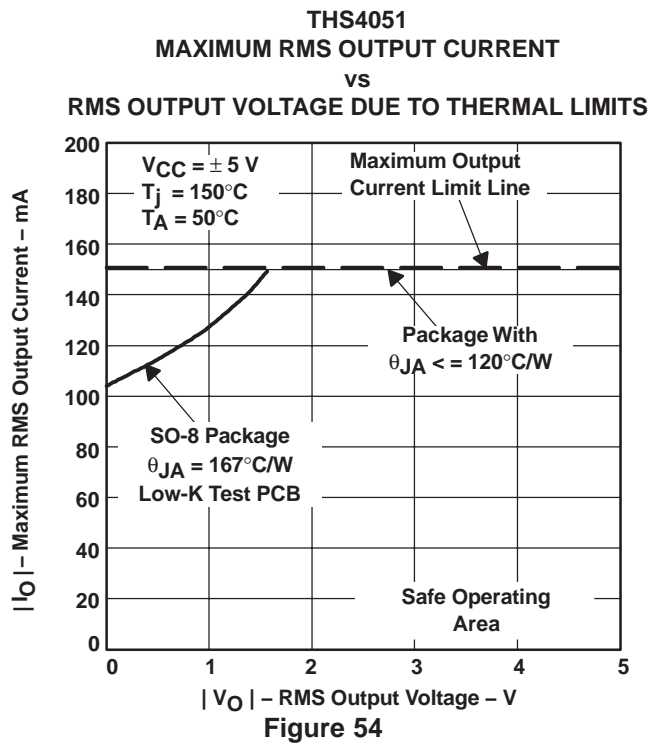

APPLICATION INFORMATION

GENERAL POWERPAD™ DESIGN CONSIDERATIONS (CONTINUED)

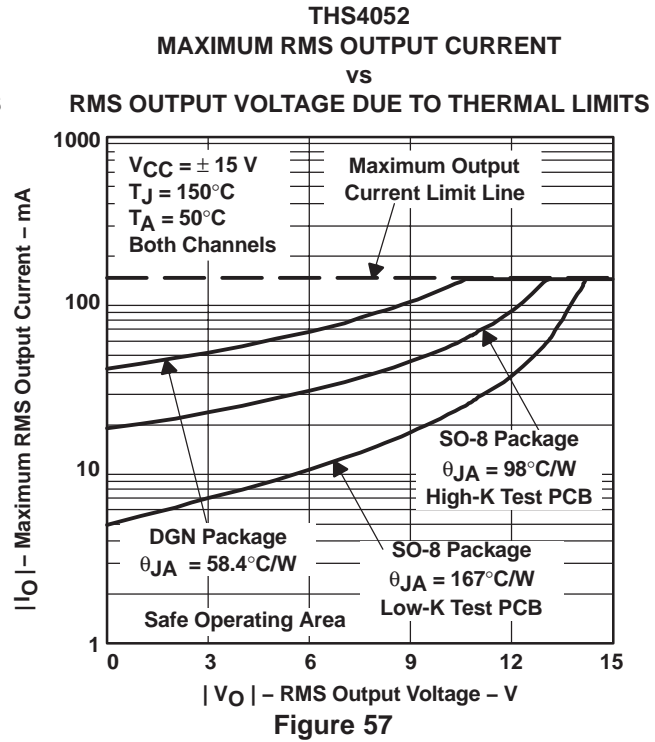
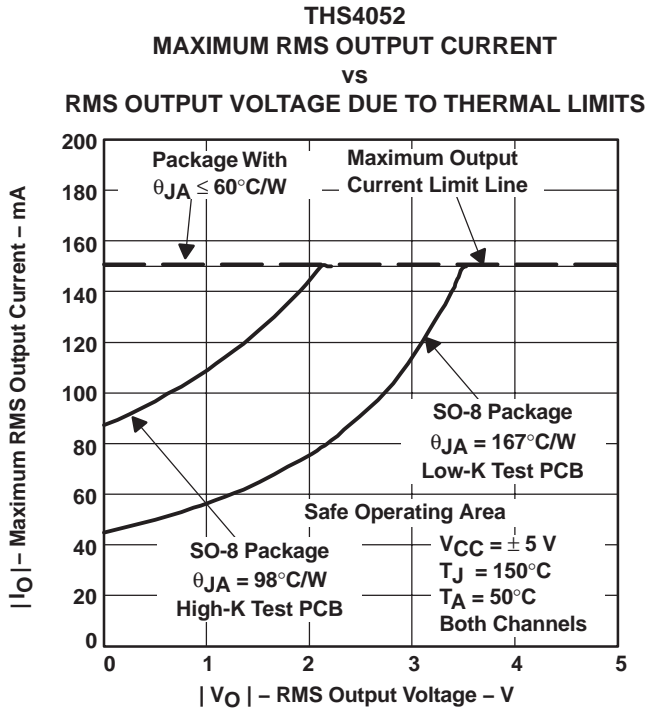

APPLICATION INFORMATION

EVALUATION BOARD

An evaluation board is available for the THS4051 (literature number SLOP220) and THS4052 (literature number SLOP234). This board has been configured for very low parasitic capacitance in order to realize the full performance of the amplifier. A schematic of the evaluation board is shown in Figure 58. The circuitry has been designed so that the amplifier may be used in either an inverting or noninverting configuration. For more information, please refer to the *THS4051 EVM User's Guide* or the *THS4052 EVM User's Guide*. To order the evaluation board, contact your local TI sales office or distributor.

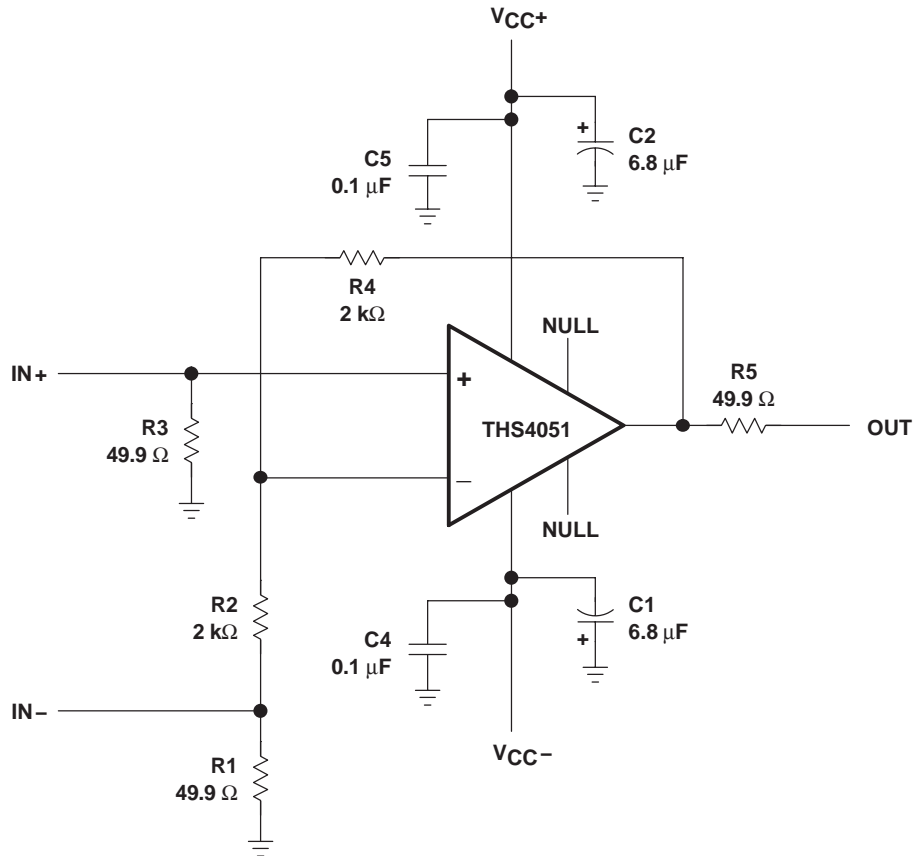

Figure 58. THS4051 Evaluation Board Schematic

PACKAGING INFORMATION

Orderable Device	Status (1)	Package Type	Package Drawing	Pins	Package Qty	Eco Plan (2)	Lead finish/ Ball material (6)	MSL Peak Temp (3)	Op Temp (°C)	Device Marking (4/5)	Samples
5962-9959901Q2A	ACTIVE	LCCC	FK	20	55	Non-RoHS & Green	SNPB	N / A for Pkg Type	-55 to 125	5962-9959901Q2A THS4051MFKB	Samples
5962-9959901QPA	ACTIVE	CDIP	JG	8	50	Non-RoHS & Green	SNPB	N / A for Pkg Type	-55 to 125	9959901QPA THS4051M	Samples
THS4051CD	ACTIVE	SOIC	D	8	75	RoHS & Green	NIPDAU	Level-1-260C-UNLIM	0 to 70	4051C	Samples
THS4051CDGN	ACTIVE	HVSSOP	DGN	8	80	RoHS & Green	NIPDAU	Level-1-260C-UNLIM	0 to 70	ACQ	Samples
THS4051CDGNR	ACTIVE	HVSSOP	DGN	8	2500	RoHS & Green	NIPDAU	Level-1-260C-UNLIM	0 to 70	ACQ	Samples
THS4051CDR	ACTIVE	SOIC	D	8	2500	RoHS & Green	NIPDAU	Level-1-260C-UNLIM	0 to 70	4051C	Samples
THS4051ID	ACTIVE	SOIC	D	8	75	RoHS & Green	NIPDAU	Level-1-260C-UNLIM	-40 to 85	4051I	Samples
THS4051IDG4	ACTIVE	SOIC	D	8	75	TBD	Call TI	Call TI	-40 to 85		Samples
THS4051IDGN	ACTIVE	HVSSOP	DGN	8	80	RoHS & Green	NIPDAU	Level-1-260C-UNLIM	-40 to 85	ACR	Samples
THS4051IDGNR	ACTIVE	HVSSOP	DGN	8	2500	RoHS & Green	NIPDAU	Level-1-260C-UNLIM	-40 to 85	ACR	Samples
THS4051IDR	ACTIVE	SOIC	D	8	2500	RoHS & Green	NIPDAU	Level-1-260C-UNLIM	-40 to 85	4051I	Samples
THS4051IDRG4	ACTIVE	SOIC	D	8	2500	TBD	Call TI	Call TI	-40 to 85		Samples
THS4051MFKB	ACTIVE	LCCC	FK	20	55	Non-RoHS & Green	SNPB	N / A for Pkg Type	-55 to 125	5962-9959901Q2A THS4051MFKB	Samples
THS4051MJG	ACTIVE	CDIP	JG	8	50	Non-RoHS & Green	SNPB	N / A for Pkg Type	-55 to 125	THS4051MJG	Samples
THS4051MJGB	ACTIVE	CDIP	JG	8	50	Non-RoHS & Green	SNPB	N / A for Pkg Type	-55 to 125	9959901QPA THS4051M	Samples
THS4052CD	ACTIVE	SOIC	D	8	75	RoHS & Green	NIPDAU	Level-1-260C-UNLIM	0 to 70	4052C	Samples
THS4052CDGN	ACTIVE	HVSSOP	DGN	8	80	RoHS & Green	NIPDAU	Level-1-260C-UNLIM	0 to 70	ACE	Samples
THS4052CDGNR	ACTIVE	HVSSOP	DGN	8	2500	RoHS & Green	NIPDAU	Level-1-260C-UNLIM	0 to 70	ACE	Samples

Orderable Device	Status (1)	Package Type	Package Drawing	Pins	Package Qty	Eco Plan (2)	Lead finish/ Ball material (6)	MSL Peak Temp (3)	Op Temp (°C)	Device Marking (4/5)	Samples
THS4052CDR	ACTIVE	SOIC	D	8	2500	RoHS & Green	NIPDAU	Level-1-260C-UNLIM	0 to 70	4052C	Samples
THS4052ID	ACTIVE	SOIC	D	8	75	RoHS & Green	NIPDAU	Level-1-260C-UNLIM	-40 to 85	4052I	Samples
THS4052IDGN	ACTIVE	HVSSOP	DGN	8	80	RoHS & Green	NIPDAU	Level-1-260C-UNLIM	-40 to 85	ACF	Samples
THS4052IDGNR	ACTIVE	HVSSOP	DGN	8	2500	RoHS & Green	NIPDAU	Level-1-260C-UNLIM	-40 to 85	ACF	Samples
THS4052IDR	ACTIVE	SOIC	D	8	2500	RoHS & Green	NIPDAU	Level-1-260C-UNLIM	-40 to 85	4052I	Samples

(1) The marketing status values are defined as follows:

ACTIVE: Product device recommended for new designs.

LIFEBUY: TI has announced that the device will be discontinued, and a lifetime-buy period is in effect.

NRND: Not recommended for new designs. Device is in production to support existing customers, but TI does not recommend using this part in a new design.

PREVIEW: Device has been announced but is not in production. Samples may or may not be available.

OBSELETE: TI has discontinued the production of the device.

(2) **RoHS:** TI defines "RoHS" to mean semiconductor products that are compliant with the current EU RoHS requirements for all 10 RoHS substances, including the requirement that RoHS substance do not exceed 0.1% by weight in homogeneous materials. Where designed to be soldered at high temperatures, "RoHS" products are suitable for use in specified lead-free processes. TI may reference these types of products as "Pb-Free".

RoHS Exempt: TI defines "RoHS Exempt" to mean products that contain lead but are compliant with EU RoHS pursuant to a specific EU RoHS exemption.

Green: TI defines "Green" to mean the content of Chlorine (Cl) and Bromine (Br) based flame retardants meet JS709B low halogen requirements of <=1000ppm threshold. Antimony trioxide based flame retardants must also meet the <=1000ppm threshold requirement.

(3) MSL, Peak Temp. - The Moisture Sensitivity Level rating according to the JEDEC industry standard classifications, and peak solder temperature.

(4) There may be additional marking, which relates to the logo, the lot trace code information, or the environmental category on the device.

(5) Multiple Device Markings will be inside parentheses. Only one Device Marking contained in parentheses and separated by a "~" will appear on a device. If a line is indented then it is a continuation of the previous line and the two combined represent the entire Device Marking for that device.

(6) Lead finish/Ball material - Orderable Devices may have multiple material finish options. Finish options are separated by a vertical ruled line. Lead finish/Ball material values may wrap to two lines if the finish value exceeds the maximum column width.

Important Information and Disclaimer:The information provided on this page represents TI's knowledge and belief as of the date that it is provided. TI bases its knowledge and belief on information provided by third parties, and makes no representation or warranty as to the accuracy of such information. Efforts are underway to better integrate information from third parties. TI has taken and

continues to take reasonable steps to provide representative and accurate information but may not have conducted destructive testing or chemical analysis on incoming materials and chemicals. TI and TI suppliers consider certain information to be proprietary, and thus CAS numbers and other limited information may not be available for release.

In no event shall TI's liability arising out of such information exceed the total purchase price of the TI part(s) at issue in this document sold by TI to Customer on an annual basis.

OTHER QUALIFIED VERSIONS OF THS4051, THS4051M :

- Catalog : [THS4051](#)
- Military : [THS4051M](#)

NOTE: Qualified Version Definitions:

- Catalog - TI's standard catalog product
- Military - QML certified for Military and Defense Applications

TAPE AND REEL INFORMATION

QUADRANT ASSIGNMENTS FOR PIN 1 ORIENTATION IN TAPE

*All dimensions are nominal

Device	Package Type	Package Drawing	Pins	SPQ	Reel Diameter (mm)	Reel Width W1 (mm)	A0 (mm)	B0 (mm)	K0 (mm)	P1 (mm)	W (mm)	Pin1 Quadrant
THS4051CDGNR	HVSSOP	DGN	8	2500	330.0	12.4	5.3	3.4	1.4	8.0	12.0	Q1
THS4051CDR	SOIC	D	8	2500	330.0	12.4	6.4	5.2	2.1	8.0	12.0	Q1
THS4051IDGNR	HVSSOP	DGN	8	2500	330.0	12.4	5.3	3.4	1.4	8.0	12.0	Q1
THS4051IDR	SOIC	D	8	2500	330.0	12.4	6.4	5.2	2.1	8.0	12.0	Q1
THS4052CDGNR	HVSSOP	DGN	8	2500	330.0	12.4	5.3	3.4	1.4	8.0	12.0	Q1
THS4052CDR	SOIC	D	8	2500	330.0	12.4	6.4	5.2	2.1	8.0	12.0	Q1
THS4052IDGNR	HVSSOP	DGN	8	2500	330.0	12.4	5.3	3.4	1.4	8.0	12.0	Q1
THS4052IDR	SOIC	D	8	2500	330.0	12.4	6.4	5.2	2.1	8.0	12.0	Q1

TAPE AND REEL BOX DIMENSIONS

*All dimensions are nominal

Device	Package Type	Package Drawing	Pins	SPQ	Length (mm)	Width (mm)	Height (mm)
THS4051CDGNR	HVSSOP	DGN	8	2500	358.0	335.0	35.0
THS4051CDR	SOIC	D	8	2500	350.0	350.0	43.0
THS4051IDGNR	HVSSOP	DGN	8	2500	358.0	335.0	35.0
THS4051IDR	SOIC	D	8	2500	350.0	350.0	43.0
THS4052CDGNR	HVSSOP	DGN	8	2500	358.0	335.0	35.0
THS4052CDR	SOIC	D	8	2500	350.0	350.0	43.0
THS4052IDGNR	HVSSOP	DGN	8	2500	358.0	335.0	35.0
THS4052IDR	SOIC	D	8	2500	350.0	350.0	43.0

TUBE

*All dimensions are nominal

Device	Package Name	Package Type	Pins	SPQ	L (mm)	W (mm)	T (μm)	B (mm)
5962-9959901Q2A	FK	LCCC	20	55	506.98	12.06	2030	NA
THS4051CD	D	SOIC	8	75	505.46	6.76	3810	4
THS4051ID	D	SOIC	8	75	505.46	6.76	3810	4
THS4051MFKB	FK	LCCC	20	55	506.98	12.06	2030	NA
THS4052CD	D	SOIC	8	75	505.46	6.76	3810	4
THS4052ID	D	SOIC	8	75	505.46	6.76	3810	4

GENERIC PACKAGE VIEW

DGN 8

PowerPAD™ HVSSOP - 1.1 mm max height

3 x 3, 0.65 mm pitch

SMALL OUTLINE PACKAGE

This image is a representation of the package family, actual package may vary.
Refer to the product data sheet for package details.



4225482/B



4225481/A 11/2019

PowerPAD is a trademark of Texas Instruments.

NOTES:

1. All linear dimensions are in millimeters. Any dimensions in parenthesis are for reference only. Dimensioning and tolerancing per ASME Y14.5M.
2. This drawing is subject to change without notice.
3. This dimension does not include mold flash, protrusions, or gate burrs. Mold flash, protrusions, or gate burrs shall not exceed 0.15 mm per side.
4. This dimension does not include interlead flash. Interlead flash shall not exceed 0.25 mm per side.
5. Reference JEDEC registration MO-187.

EXAMPLE BOARD LAYOUT

DGN0008D

PowerPAD™ VSSOP - 1.1 mm max height

SMALL OUTLINE PACKAGE



LAND PATTERN EXAMPLE
EXPOSED METAL SHOWN
SCALE: 15X



SOLDER MASK DETAILS

4225481/A 11/2019

NOTES: (continued)

6. Publication IPC-7351 may have alternate designs.
7. Solder mask tolerances between and around signal pads can vary based on board fabrication site.
8. Vias are optional depending on application, refer to device data sheet. If any vias are implemented, refer to their locations shown on this view. It is recommended that vias under paste be filled, plugged or tented.
9. Size of metal pad may vary due to creepage requirement.

EXAMPLE STENCIL DESIGN

DGN0008D

PowerPAD™ VSSOP - 1.1 mm max height

SMALL OUTLINE PACKAGE



SOLDER PASTE EXAMPLE
EXPOSED PAD 9:
100% PRINTED SOLDER COVERAGE BY AREA
SCALE: 15X

STENCIL THICKNESS	SOLDER STENCIL OPENING
0.1	1.76 X 2.11
0.125	1.57 X 1.89 (SHOWN)
0.15	1.43 X 1.73
0.175	1.33 X 1.60

4225481/A 11/2019

NOTES: (continued)

10. Laser cutting apertures with trapezoidal walls and rounded corners may offer better paste release. IPC-7525 may have alternate design recommendations.
11. Board assembly site may have different recommendations for stencil design.

GENERIC PACKAGE VIEW

FK 20

LCCC - 2.03 mm max height

8.89 x 8.89, 1.27 mm pitch

LEADLESS CERAMIC CHIP CARRIER

This image is a representation of the package family, actual package may vary.
Refer to the product data sheet for package details.



4229370VA\



D0008A

PACKAGE OUTLINE

SOIC - 1.75 mm max height

SMALL OUTLINE INTEGRATED CIRCUIT



4214825/C 02/2019

NOTES:

- Linear dimensions are in inches [millimeters]. Dimensions in parenthesis are for reference only. Controlling dimensions are in inches. Dimensioning and tolerancing per ASME Y14.5M.
- This drawing is subject to change without notice.
- This dimension does not include mold flash, protrusions, or gate burrs. Mold flash, protrusions, or gate burrs shall not exceed $.006$ [0.15] per side.
- This dimension does not include interlead flash.
- Reference JEDEC registration MS-012, variation AA.

EXAMPLE BOARD LAYOUT

D0008A

SOIC - 1.75 mm max height

SMALL OUTLINE INTEGRATED CIRCUIT



LAND PATTERN EXAMPLE
 EXPOSED METAL SHOWN
 SCALE:8X



SOLDER MASK DETAILS

4214825/C 02/2019

NOTES: (continued)

- 6. Publication IPC-7351 may have alternate designs.
- 7. Solder mask tolerances between and around signal pads can vary based on board fabrication site.

EXAMPLE STENCIL DESIGN

D0008A

SOIC - 1.75 mm max height

SMALL OUTLINE INTEGRATED CIRCUIT



SOLDER PASTE EXAMPLE
BASED ON .005 INCH [0.125 MM] THICK STENCIL
SCALE:8X

4214825/C 02/2019

NOTES: (continued)

8. Laser cutting apertures with trapezoidal walls and rounded corners may offer better paste release. IPC-7525 may have alternate design recommendations.
9. Board assembly site may have different recommendations for stencil design.

PACKAGE OUTLINE

JG0008A

CDIP - 5.08 mm max height

CERAMIC DUAL IN-LINE PACKAGE



NOTES:

1. All linear dimensions are in millimeters. Any dimensions in parenthesis are for reference only. Dimensioning and tolerancing per ASME Y14.5M.
2. This drawing is subject to change without notice.
3. This package can be hermetically sealed with a ceramic lid using glass frit.
4. Index point is provided on cap for terminal identification.
5. Falls within MIL STD 1835 GDIP1-T8

EXAMPLE BOARD LAYOUT

JG0008A

CDIP - 5.08 mm max height

CERAMIC DUAL IN-LINE PACKAGE



LAND PATTERN EXAMPLE
NON SOLDER MASK DEFINED
SCALE: 9X

4230036/A 09/2023

IMPORTANT NOTICE AND DISCLAIMER

TI PROVIDES TECHNICAL AND RELIABILITY DATA (INCLUDING DATA SHEETS), DESIGN RESOURCES (INCLUDING REFERENCE DESIGNS), APPLICATION OR OTHER DESIGN ADVICE, WEB TOOLS, SAFETY INFORMATION, AND OTHER RESOURCES "AS IS" AND WITH ALL FAULTS, AND DISCLAIMS ALL WARRANTIES, EXPRESS AND IMPLIED, INCLUDING WITHOUT LIMITATION ANY IMPLIED WARRANTIES OF MERCHANTABILITY, FITNESS FOR A PARTICULAR PURPOSE OR NON-INFRINGEMENT OF THIRD PARTY INTELLECTUAL PROPERTY RIGHTS.

These resources are intended for skilled developers designing with TI products. You are solely responsible for (1) selecting the appropriate TI products for your application, (2) designing, validating and testing your application, and (3) ensuring your application meets applicable standards, and any other safety, security, regulatory or other requirements.

These resources are subject to change without notice. TI grants you permission to use these resources only for development of an application that uses the TI products described in the resource. Other reproduction and display of these resources is prohibited. No license is granted to any other TI intellectual property right or to any third party intellectual property right. TI disclaims responsibility for, and you will fully indemnify TI and its representatives against, any claims, damages, costs, losses, and liabilities arising out of your use of these resources.

TI's products are provided subject to [TI's Terms of Sale](#) or other applicable terms available either on [ti.com](https://www.ti.com) or provided in conjunction with such TI products. TI's provision of these resources does not expand or otherwise alter TI's applicable warranties or warranty disclaimers for TI products.

TI objects to and rejects any additional or different terms you may have proposed.

Mailing Address: Texas Instruments, Post Office Box 655303, Dallas, Texas 75265

Copyright © 2025, Texas Instruments Incorporated