

## TLC227x-Q1 Advanced, Rail-To-Rail, LinCMOS™ Operational Amplifiers

### 1 Features

- AEC-Q100 qualified for automotive applications
  - Temperature grade 1:  $-40^{\circ}\text{C}$  to  $125^{\circ}\text{C}$ ,  $T_A$
- **Functional Safety-Capable**
  - [Documentation available to aid functional safety system design \(TLC2272-Q1\)](#)
  - [Documentation available to aid functional safety system design \(TLC2272A-Q1\)](#)
- Output swing includes both supply rails
- Low noise:  $9\text{ nV}/\sqrt{\text{Hz}}$  typical at  $f = 1\text{ kHz}$
- Low input bias current:  $1\text{ pA}$  typical
- Fully specified for both single-supply and split-supply operation
- Common-mode input voltage range includes negative rail
- High-gain bandwidth:  $2.2\text{ MHz}$  typical
- High slew rate:  $3.6\text{ V}/\mu\text{s}$  typical
- Low input offset voltage:  $950\text{ }\mu\text{V}$  maximum at  $T_A = 25^{\circ}\text{C}$
- Macromodel included

### 2 Applications

- [Body control module](#)
- [Battery management system](#)
- [Car audio](#)
- [DC/DC converter](#)
- [Electric power steering](#)
- [Engine control unit](#)
- [Gasoline engine](#)
- [Instrument clusters](#)
- [Inverter and motor control](#)
- [On-board charger](#)
- [Telematics control unit](#)
- [Transmission control](#)
- [White goods \(refrigerators, washing machines\)](#)

### 3 Description

The TLC227x-Q1 are dual and quad, LinCMOS™ operational amplifiers. Both devices exhibit rail-to-rail output performance for increased dynamic range in single- or split-supply applications. The TLC227x-Q1 family offers  $2\text{ MHz}$  of bandwidth and  $3\text{ V}/\mu\text{s}$  of slew rate for higher-speed applications. These devices offer comparable ac performance while having better noise, input offset voltage, and power dissipation than existing CMOS op amps. The TLC227x-Q1 has a noise voltage of  $9\text{ nV}/\sqrt{\text{Hz}}$ —two times lower than competitive solutions.

The TLC227x-Q1, exhibiting high input impedance and low noise, are excellent for small-signal

conditioning for high-impedance sources, such as piezoelectric transducers. In addition, the rail-to-rail output feature, with single- or split-supplies, makes this family a great choice when interfacing with analog-to-digital converters (ADCs).

For precision applications, the TLC227xA-Q1 family is available with a maximum input offset voltage of  $950\text{ }\mu\text{V}$ . This family is fully characterized at  $5\text{ V}$  and  $\pm 5\text{ V}$ .

These devices offer increased output dynamic range, lower noise voltage, and lower input offset voltage. This enhanced feature set allows the TLC227x-Q1 to be used in a wider range of applications. For applications that require higher output drive and wider input voltage range, see the [TLV2432-Q1](#) and [TLV2442-Q1](#). All the parameters of the TLC227x-Q1 family enables these devices to be applicable in most automotive applications.

#### Package Information

PART NUMBER	PACKAGE <sup>(1)</sup>	BODY SIZE (NOM)
TLC2272-Q1, TLC2272A-Q1	SOIC (8)	4.90 mm x 3.91 mm
	TSSOP (8)	3.00 mm x 4.40 mm
TLC2274-Q1, TLC2274A-Q1	SOIC (14)	8.65 mm x 3.91 mm
	TSSOP (14)	5.00 mm x 4.40 mm

(1) For all available packages, see the orderable addendum at the end of the data sheet.

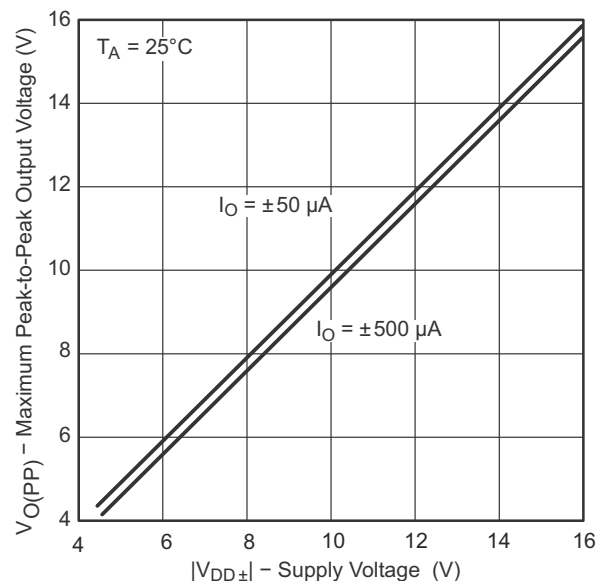

**Maximum Peak-To-Peak Output Voltage vs Supply Voltage**



## Table of Contents

<b>1 Features</b> .....	1	7.1 Overview.....	22
<b>2 Applications</b> .....	1	7.2 Functional Block Diagram.....	22
<b>3 Description</b> .....	1	7.3 Feature Description.....	22
<b>4 Revision History</b> .....	2	7.4 Device Functional Modes.....	22
<b>5 Pin Configuration and Functions</b> .....	3	<b>8 Application and Implementation</b> .....	23
<b>6 Specifications</b> .....	4	8.1 Application Information.....	23
6.1 Absolute Maximum Ratings.....	4	8.2 Typical Application.....	24
6.2 ESD Ratings.....	4	8.3 Power Supply Recommendations.....	26
6.3 Recommended Operating Conditions.....	4	8.4 Layout.....	26
6.4 Thermal Information.....	5	<b>9 Device and Documentation Support</b> .....	27
6.5 Electrical Characteristics: $V_{DD} = 5\text{ V}$ (TLC2272-Q1 and TLC2272A-Q1).....	5	9.1 Device Support.....	27
6.6 Electrical Characteristics: $V_{DD\pm} = \pm 5\text{ V}$ (TLC2272-Q1 and TLC2272A-Q1).....	6	9.2 Documentation Support.....	27
6.7 Electrical Characteristics: $V_{DD} = 5\text{ V}$ (TLC2274-Q1 and TLC2274A-Q1).....	8	9.3 Receiving Notification of Documentation Updates.....	27
6.8 Electrical Characteristics: $V_{DD\pm} = \pm 5\text{ V}$ (TLC2274-Q1 and TLC2274A-Q1).....	9	9.4 Support Resources.....	27
6.9 Typical Characteristics.....	11	9.5 Trademarks.....	27
<b>7 Detailed Description</b> .....	22	9.6 Electrostatic Discharge Caution.....	28
		9.7 Glossary.....	28
		<b>10 Mechanical, Packaging, and Orderable Information</b> .....	28

## 4 Revision History

NOTE: Page numbers for previous revisions may differ from page numbers in the current version.

<b>Changes from Revision F (March 2016) to Revision G (August 2022)</b>	<b>Page</b>
• Updated the numbering format for tables, figures, and cross-references throughout the document.....	1
• Added functional safety information to <i>Features</i> bullets.....	1
<hr/>	
<b>Changes from Revision E (January 2012) to Revision F (March 2016)</b>	<b>Page</b>
• Added <i>Pin Configuration and Functions</i> section, <i>Feature Description</i> section, <i>Device Functional Modes, Application and Implementation</i> section, <i>Power Supply Recommendations</i> section, <i>Layout</i> section, <i>Device and Documentation Support</i> section, and <i>Mechanical, Packaging, and Orderable Information</i> section.....	1
• Added <i>ESD ratings</i> table.....	4
<hr/>	
<b>Changes from Revision D (March 2009) to Revision E (January 2012)</b>	<b>Page</b>
• Deleted <i>ESD ratings</i> table.....	4

## 5 Pin Configuration and Functions

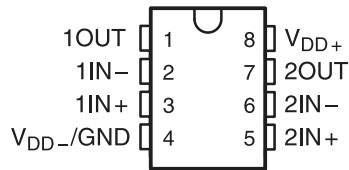

**Figure 5-1. TLC2272-Q1 and TLC2272A-Q1:  
D (8-Pin SOIC) or PW (8-Pin TSSOP)  
Packages, Top View**

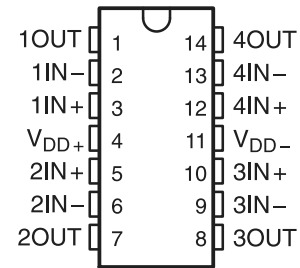

**Figure 5-2. TLC2274-Q1 and TLC2274A-Q1:  
D (14-Pin SOIC) or PW (14-Pin TSSOP)  
Packages, Top View**

**Table 5-1. Pin Functions**

NAME	PIN		TYPE	DESCRIPTION
	NO.			
	TLC2272-Q1, TLC2272A-Q1	TLC2274-Q1, TLC2274A-Q1		
1IN+	3	3	Input	Noninverting input, channel 1
1IN-	2	2	Input	Inverting input, channel 1
1OUT	1	1	Output	Output, channel 1
2IN+	5	5	Input	Noninverting input, channel 2
2IN-	6	6	Input	Inverting input, channel 2
2OUT	7	7	Output	Output, channel 2
3IN+	—	10	Input	Noninverting input, channel 3
3IN-	—	9	Input	Inverting input, channel 3
3OUT	—	8	Output	Output, channel 3
4IN+	—	12	Input	Noninverting input, channel 4
4IN-	—	13	Input	Inverting input, channel 4
4OUT	—	14	Output	Output, channel 4
V <sub>DD+</sub>	8	4	Input	Positive (highest) supply
V <sub>DD-</sub>	4	11	Input	Negative (lowest) supply

## 6 Specifications

### 6.1 Absolute Maximum Ratings

over operating free-air temperature range (unless otherwise noted)<sup>(1)</sup>

	MIN	MAX	UNIT
Supply voltage, $V_{DD+}$ <sup>(2)</sup>		8	V
$V_{DD-}$ <sup>(2)</sup>	-8		V
Differential input voltage, $V_{ID}$ <sup>(3)</sup>		±16	V
Input voltage, $V_I$ (any input) <sup>(2)</sup>	$V_{DD-} - 0.3$	$V_{DD+}$	V
Input current, $I_I$ (any input)		±5	mA
Output current, $I_O$		±50	mA
Total current into $V_{DD+}$		±50	mA
Total current out of $V_{DD-}$		±50	mA
Duration of short-circuit current at (or below) 25°C <sup>(4)</sup>	Unlimited		
Operating free-air temperature range, $T_A$	-40	125	°C
Lead temperature 1,6 mm (1/16 inch) from case for 10 seconds	D or PW package		260
Storage temperature, $T_{stg}$	-65	150	°C

- (1) Stresses beyond those listed under *Absolute Maximum Ratings* may cause permanent damage to the device. These are stress ratings only, which do not imply functional operation of the device at these or any other conditions beyond those indicated under [Section 6.3](#). Exposure to absolute-maximum-rated conditions for extended periods may affect device reliability.
- (2) All voltage values, except differential voltages, are with respect to the midpoint between  $V_{DD+}$  and  $V_{DD-}$ .
- (3) Differential voltages are at  $IN+$  with respect to  $IN-$ . Excessive current will flow if input is brought below  $V_{DD-} - 0.3$  V.
- (4) The output can be shorted to either supply. Temperature or supply voltages must be limited so that the maximum dissipation rating is not exceeded.

### 6.2 ESD Ratings

		VALUE	UNIT
$V_{(ESD)}$	Electrostatic discharge	Human-body model (HBM), per AEC Q100-002 <sup>(1)</sup> HBM ESD classification level 2	±2000
		Charged-device model (CDM), per AEC Q100-011 CDM ESD classification level C6	±1000

- (1) AEC Q100-002 indicates that HBM stressing shall be in accordance with the ANSI/ESDA/JEDEC JS-001 specification.

### 6.3 Recommended Operating Conditions

over operating free-air temperature range (unless otherwise noted)

		MIN	MAX	UNIT
$V_{DD±}$	Supply voltage	±2.2	±8	V
$V_I$	Input voltage	$V_{DD-}$	$V_{DD+} - 1.5$	V
$V_{IC}$	Common-mode input voltage	$V_{DD-}$	$V_{DD+} - 1.5$	V
$T_A$	Operating free-air temperature	-40	125	°C

## 6.4 Thermal Information

THERMAL METRIC <sup>(1)</sup>		TLC2272-Q1, TLC2272A-Q1		TLC2274-Q1, TLC2274A-Q1		UNIT
		D (SOIC)	PW (TSSOP)	D (SOIC)	PW (TSSOP)	
		8 PINS	8 PINS	14 PINS	14 PINS	
R <sub>θJA</sub>	Junction-to-ambient thermal resistance	115.6	175.8	83.8	111.6	°C/W
R <sub>θJC(top)</sub>	Junction-to-case (top) thermal resistance	61.8	58.8	43.2	41.2	°C/W
R <sub>θJB</sub>	Junction-to-board thermal resistance	55.9	104.3	38.4	54.7	°C/W
ψ <sub>JT</sub>	Junction-to-top characterization parameter	14.3	5.9	9.4	3.9	°C/W
ψ <sub>JB</sub>	Junction-to-board characterization parameter	55.4	102.3	38.1	53.9	°C/W
R <sub>θJC(bot)</sub>	Junction-to-case (bottom) thermal resistance	—	—	—	—	°C/W

(1) For more information about traditional and new thermal metrics, see the [Semiconductor and IC Package Thermal Metrics application report](#).

## 6.5 Electrical Characteristics: V<sub>DD</sub> = 5 V (TLC2272-Q1 and TLC2272A-Q1)

at specified free-air temperature, V<sub>DD</sub> = 5 V; T<sub>A</sub> = 25°C, unless otherwise noted.

PARAMETER		TEST CONDITIONS		MIN	TYP	MAX	UNIT
V <sub>IO</sub>	Input offset voltage	V <sub>IC</sub> = 0 V, V <sub>DD±</sub> = ±2.5 V, V <sub>O</sub> = 0 V, R <sub>S</sub> = 50 Ω	TLC2272-Q1	T <sub>A</sub> = 25°C	300	2500	μV
			TLC2272A-Q1		300	950	
			TLC2272-Q1	Full Range <sup>(1)</sup>		3000	
			TLC2272A-Q1		1500		
α <sub>VIO</sub>	Temperature coefficient of input offset voltage	V <sub>IC</sub> = 0 V, V <sub>DD±</sub> = ±2.5 V, V <sub>O</sub> = 0 V, R <sub>S</sub> = 50 Ω		2		μV/°C	
	Input offset voltage long-term drift <sup>(2)</sup>	V <sub>IC</sub> = 0 V, V <sub>DD±</sub> = ±2.5 V, V <sub>O</sub> = 0 V, R <sub>S</sub> = 50 Ω		0.002		μV/mo	
I <sub>IO</sub>	Input offset current	V <sub>IC</sub> = 0 V, V <sub>DD±</sub> = ±2.5 V, V <sub>O</sub> = 0 V, R <sub>S</sub> = 50 Ω	T <sub>A</sub> = 25°C	0.5	60	pA	
			Full Range <sup>(1)</sup>		800		
I <sub>IB</sub>	Input bias current	V <sub>IC</sub> = 0 V, V <sub>DD±</sub> = ±2.5 V, V <sub>O</sub> = 0 V, R <sub>S</sub> = 50 Ω	T <sub>A</sub> = 25°C	1	60	pA	
			Full Range <sup>(1)</sup>		800		
V <sub>ICR</sub>	Common-mode input voltage	R <sub>S</sub> = 50 Ω;  V <sub>IO</sub>   ≤ 5 mV	T <sub>A</sub> = 25°C	-0.3	2.5	4	V
			Full Range <sup>(1)</sup>	0	2.5	3.5	
V <sub>OH</sub>	High-level output voltage	I <sub>OH</sub> = -200 μA	I <sub>OH</sub> = -20 μA		4.99		V
			T <sub>A</sub> = 25°C	4.85	4.93		
			Full Range <sup>(1)</sup>	4.85			
			T <sub>A</sub> = 25°C	4.25	4.65		
V <sub>OL</sub>	Low-level output voltage	V <sub>IC</sub> = 2.5 V	I <sub>OH</sub> = -1 mA	Full Range <sup>(1)</sup>	4.25		V
			I <sub>OL</sub> = 50 μA		0.01		
			I <sub>OL</sub> = 500 μA	T <sub>A</sub> = 25°C	0.09	0.15	
			Full Range <sup>(1)</sup>		0.15		
A <sub>VD</sub>	Large-signal differential voltage amplification	V <sub>IC</sub> = 2.5 V, V <sub>O</sub> = 1 V to 4 V	I <sub>OL</sub> = 5 mA	T <sub>A</sub> = 25°C	0.9	1.5	V/mV
			Full Range <sup>(1)</sup>		1.5		
			R <sub>L</sub> = 10 kΩ <sup>(3)</sup>	T <sub>A</sub> = 25°C	10	35	
			Full Range <sup>(1)</sup>	10			
			R <sub>L</sub> = 1 MΩ <sup>(3)</sup>		175		
r <sub>id</sub>	Differential input resistance				10 <sup>12</sup>	Ω	
r <sub>i</sub>	Common-mode input resistance				10 <sup>12</sup>	Ω	
c <sub>i</sub>	Common-mode input capacitance	f = 10 kHz, P package			8	pF	
z <sub>o</sub>	Closed-loop output impedance	f = 1 MHz, A <sub>v</sub> = 10			140	Ω	
CMRR	Common-mode rejection ratio	V <sub>IC</sub> = 0 V to 2.7 V, V <sub>O</sub> = 2.5 V, R <sub>S</sub> = 50 Ω	T <sub>A</sub> = 25°C	70	75	dB	
			Full Range <sup>(1)</sup>	70			
k <sub>SVR</sub>	Supply-voltage rejection ratio (ΔV <sub>DD</sub> / ΔV <sub>IO</sub> )	V <sub>DD</sub> = 4.4 V to 16 V, V <sub>IC</sub> = V <sub>DD</sub> / 2, no load	T <sub>A</sub> = 25°C	80	95	dB	
			Full Range <sup>(1)</sup>	80			

## 6.5 Electrical Characteristics: $V_{DD} = 5\text{ V}$ (TLC2272-Q1 and TLC2272A-Q1) (continued)

 at specified free-air temperature,  $V_{DD} = 5\text{ V}$ ;  $T_A = 25^\circ\text{C}$ , unless otherwise noted.

PARAMETER		TEST CONDITIONS		MIN	TYP	MAX	UNIT
$I_{DD}$	Supply current	$V_O = 2.5\text{ V}$ , no load	$T_A = 25^\circ\text{C}$		2.2	3	mA
			Full Range <sup>(1)</sup>			3	
SR	Slew rate at unity gain	$V_O = 0.5\text{ V}$ to $2.5\text{ V}$ , $R_L = 10\text{ k}\Omega$ <sup>(3)</sup> , $C_L = 100\text{ pF}$ <sup>(3)</sup>	$T_A = 25^\circ\text{C}$		2.3	3.6	V/ $\mu\text{s}$
			Full Range <sup>(1)</sup>		1.7		
$V_n$	Equivalent input noise voltage	f = 10 Hz			50		nV/ $\sqrt{\text{Hz}}$
			f = 1 kHz			9	
$V_{NPP}$	Peak-to-peak equivalent input noise voltage	f = 0.1 Hz to 1 Hz			1		$\mu\text{V}$
			f = 0.1 Hz to 10 Hz			1.4	
$I_n$	Equivalent input noise current				0.6		fA/ $\sqrt{\text{Hz}}$
THD+N	Total harmonic distortion + noise	$V_O = 0.5\text{ V}$ to $2.5\text{ V}$ , f = 20 kHz, $R_L = 10\text{ k}\Omega$ <sup>(3)</sup>	$A_V = 1$		0.0013%		
			$A_V = 10$		0.004%		
			$A_V = 100$		0.03%		
	Gain-bandwidth product	f = 10 kHz, $R_L = 10\text{ k}\Omega$ <sup>(3)</sup> , $C_L = 100\text{ pF}$ <sup>(3)</sup>			2.18		MHz
$B_{OM}$	Maximum output-swing bandwidth	$V_{O(PP)} = 2\text{ V}$ , $A_V = 1$ , $R_L = 10\text{ k}\Omega$ <sup>(3)</sup> , $C_L = 100\text{ pF}$ <sup>(3)</sup>			1		MHz
$t_s$	Settling time	$A_V = -1$ , $R_L = 10\text{ k}\Omega$ <sup>(3)</sup> , Step = 0.5 V to 2.5 V, $C_L = 100\text{ pF}$ <sup>(3)</sup>	To 0.1%		1.5		$\mu\text{s}$
			To 0.01%		2.6		
$\phi_m$	Phase margin at unity gain	$R_L = 10\text{ k}\Omega$ <sup>(3)</sup> , $C_L = 100\text{ pF}$ <sup>(3)</sup>			50°		
	Gain margin	$R_L = 10\text{ k}\Omega$ <sup>(3)</sup> , $C_L = 100\text{ pF}$ <sup>(3)</sup>			10		dB

 (1)  $T_A = -40^\circ\text{C}$  to  $125^\circ\text{C}$ .

 (2) Typical values are based on the input offset voltage shift observed through 168 hours of operating life test at  $T_A = 150^\circ\text{C}$  extrapolated to  $T_A = 25^\circ\text{C}$  using the Arrhenius equation and assuming an activation energy of 0.96 eV.

(3) Referenced to 0 V.

## 6.6 Electrical Characteristics: $V_{DD\pm} = \pm 5\text{ V}$ (TLC2272-Q1 and TLC2272A-Q1)

 at specified free-air temperature,  $V_{DD\pm} = \pm 5\text{ V}$ ;  $T_A = 25^\circ\text{C}$ , unless otherwise noted.

PARAMETER		TEST CONDITIONS		MIN	TYP	MAX	UNIT	
$V_{IO}$	Input offset voltage	$V_{IC} = 0\text{ V}$ , $V_O = 0\text{ V}$ , $R_S = 50\ \Omega$	TLC2272-Q1	$T_A = 25^\circ\text{C}$	300	2500	$\mu\text{V}$	
			TLC2272A-Q1		300	950		
			TLC2272-Q1	Full Range <sup>(1)</sup>		3000		
			TLC2272A-Q1			1500		
$\alpha_{VIO}$	Temperature coefficient of input offset voltage	$V_{IC} = 0\text{ V}$ , $V_O = 0\text{ V}$ , $R_S = 50\ \Omega$			2		$\mu\text{V}/^\circ\text{C}$	
	Input offset voltage long-term drift <sup>(2)</sup>	$V_{IC} = 0\text{ V}$ , $V_O = 0\text{ V}$ , $R_S = 50\ \Omega$			0.002		$\mu\text{V}/\text{mo}$	
$I_{IO}$	Input offset current	$V_{IC} = 0\text{ V}$ , $V_O = 0\text{ V}$ , $R_S = 50\ \Omega$	$T_A = 25^\circ\text{C}$		0.5	60	pA	
			Full Range <sup>(1)</sup>			800		
$I_{IB}$	Input bias current	$V_{IC} = 0\text{ V}$ , $V_O = 0\text{ V}$ , $R_S = 50\ \Omega$	$T_A = 25^\circ\text{C}$		1	60	pA	
			Full Range <sup>(1)</sup>			800		
$V_{ICR}$	Common-mode input voltage	$R_S = 50\ \Omega$ ; $ V_{IO}  \leq 5\text{ mV}$	$T_A = 25^\circ\text{C}$		-5.3	0	4	V
			Full Range <sup>(1)</sup>		-5	0	3.5	
$V_{OM+}$	Maximum positive peak output voltage	$I_O = -20\ \mu\text{A}$	$T_A = 25^\circ\text{C}$		4.85	4.93	V	
			Full Range <sup>(1)</sup>		4.85			
			$T_A = 25^\circ\text{C}$		4.25	4.65		
			Full Range <sup>(1)</sup>		4.25			
$V_{OM-}$	Maximum negative peak output voltage	$V_{IC} = 0\text{ V}$	$I_O = 50\ \mu\text{A}$		-4.99		V	
			$I_O = 500\ \mu\text{A}$	$T_A = 25^\circ\text{C}$		-4.85		-4.91
				Full Range <sup>(1)</sup>		-4.85		
			$I_O = 5\text{ mA}$	$T_A = 25^\circ\text{C}$		-3.5		-4.1
Full Range <sup>(1)</sup>		-3.5						

## 6.6 Electrical Characteristics: $V_{DD\pm} = \pm 5\text{ V}$ (TLC2272-Q1 and TLC2272A-Q1) (continued)

at specified free-air temperature,  $V_{DD\pm} = \pm 5\text{ V}$ ;  $T_A = 25^\circ\text{C}$ , unless otherwise noted.

PARAMETER		TEST CONDITIONS		MIN	TYP	MAX	UNIT
$A_{VD}$	Large-signal differential voltage amplification	$V_O = \pm 4\text{ V}$	$R_L = 10\text{ k}\Omega$	$T_A = 25^\circ\text{C}$	20	50	V/mV
				Full Range <sup>(1)</sup>	20		
			$R_L = 1\text{ M}\Omega$			300	
$r_{id}$	Differential input resistance				$10^{12}$		$\Omega$
$r_i$	Common-mode input resistance				$10^{12}$		$\Omega$
$c_i$	Common-mode input capacitance	$f = 10\text{ kHz}$ , P package			8		pF
$z_o$	Closed-loop output impedance	$f = 1\text{ MHz}$ , $A_V = 10$			130		$\Omega$
CMRR	Common-mode rejection ratio	$V_{IC} = -5\text{ V to } 2.7\text{ V}$ , $V_O = 0\text{ V}$ , $R_S = 50\ \Omega$	$T_A = 25^\circ\text{C}$	75	80		dB
			Full Range <sup>(1)</sup>	75			
$k_{SVR}$	Supply-voltage rejection ratio ( $\Delta V_{DD} / \Delta V_{IO}$ )	$V_{DD+} = 2.2\text{ V to } \pm 8\text{ V}$ , $V_{IC} = 0\text{ V}$ , no load	$T_A = 25^\circ\text{C}$	80	95		dB
			Full Range <sup>(1)</sup>	80			
$I_{DD}$	Supply current	$V_O = 0\text{ V}$ , no load	$T_A = 25^\circ\text{C}$		2.4	3	mA
			Full Range <sup>(1)</sup>			3	
SR	Slew rate at unity gain	$V_O = \pm 2.3\text{ V}$ , $R_L = 10\text{ k}\Omega$ , $C_L = 100\text{ pF}$	$T_A = 25^\circ\text{C}$	2.3	3.6		V/ $\mu\text{s}$
			Full Range <sup>(1)</sup>	1.7			
$V_n$	Equivalent input noise voltage	$f = 10\text{ Hz}$			50		nV/ $\sqrt{\text{Hz}}$
		$f = 1\text{ kHz}$			9		
$V_{NPP}$	Peak-to-peak equivalent input noise voltage	$f = 0.1\text{ Hz to } 1\text{ Hz}$			1		$\mu\text{V}$
		$f = 0.1\text{ Hz to } 10\text{ Hz}$			1.4		
$I_n$	Equivalent input noise current				0.6		fA/ $\sqrt{\text{Hz}}$
THD+N	Total harmonic distortion + noise	$V_O = \pm 2.3$ , $f = 20\text{ kHz}$ , $R_L = 10\text{ k}\Omega$	$A_V = 1$		0.0011%		
			$A_V = 10$		0.004%		
			$A_V = 100$		0.03%		
	Gain-bandwidth product	$f = 10\text{ kHz}$ , $R_L = 10\text{ k}\Omega$ , $C_L = 100\text{ pF}$			2.25		MHz
$B_{OM}$	Maximum output-swing bandwidth	$V_{O(PP)} = 4.6\text{ V}$ , $A_V = 1$ , $R_L = 10\text{ k}\Omega$ , $C_L = 100\text{ pF}$			0.54		MHz
$t_s$	Settling time	$A_V = -1$ , $R_L = 10\text{ k}\Omega$ , Step = $-2.3\text{ V to } 2.3\text{ V}$ , $C_L = 100\text{ pF}$	To 0.1%		1.5		$\mu\text{s}$
			To 0.01%		3.2		
$\phi_m$	Phase margin at unity gain	$R_L = 10\text{ k}\Omega$ , $C_L = 100\text{ pF}$			52°		
	Gain margin	$R_L = 10\text{ k}\Omega$ , $C_L = 100\text{ pF}$			10		dB

(1)  $T_A = -40^\circ\text{C to } 125^\circ\text{C}$ .

(2) Typical values are based on the input offset voltage shift observed through 168 hours of operating life test at  $T_A = 150^\circ\text{C}$  extrapolated to  $T_A = 25^\circ\text{C}$  using the Arrhenius equation and assuming an activation energy of 0.96 eV.

## 6.7 Electrical Characteristics: $V_{DD} = 5\text{ V}$ (TLC2274-Q1 and TLC2274A-Q1)

at specified free-air temperature,  $V_{DD} = 5\text{ V}$ ;  $T_A = 25^\circ\text{C}$ , unless otherwise noted.

PARAMETER		TEST CONDITIONS		MIN	TYP	MAX	UNIT
$V_{IO}$	Input offset voltage	$V_{IC} = 0\text{ V}$ , $V_{DD\pm} = \pm 2.5\text{ V}$ , $V_O = 0\text{ V}$ , $R_S = 50\ \Omega$	TLC2274-Q1	$T_A = 25^\circ\text{C}$	300	2500	$\mu\text{V}$
			TLC2274A-Q1		300	950	
			TLC2274-Q1	Full Range <sup>(1)</sup>		3000	
			TLC2274A-Q1		1500		
$\alpha_{VIO}$	Temperature coefficient of input offset voltage	$V_{IC} = 0\text{ V}$ , $V_{DD\pm} = \pm 2.5\text{ V}$ , $V_O = 0\text{ V}$ , $R_S = 50\ \Omega$		2			$\mu\text{V}/^\circ\text{C}$
	Input offset voltage long-term drift <sup>(2)</sup>	$V_{IC} = 0\text{ V}$ , $V_{DD\pm} = \pm 2.5\text{ V}$ , $V_O = 0\text{ V}$ , $R_S = 50\ \Omega$		0.002			$\mu\text{V}/\text{mo}$
$I_{IO}$	Input offset current	$V_{IC} = 0\text{ V}$ , $V_{DD\pm} = \pm 2.5\text{ V}$ , $V_O = 0\text{ V}$ , $R_S = 50\ \Omega$	$T_A = 25^\circ\text{C}$	0.5	60	$\text{pA}$	
			Full Range <sup>(1)</sup>	800			
$I_{IB}$	Input bias current	$V_{IC} = 0\text{ V}$ , $V_{DD\pm} = \pm 2.5\text{ V}$ , $V_O = 0\text{ V}$ , $R_S = 50\ \Omega$	$T_A = 25^\circ\text{C}$	1	60	$\text{pA}$	
			Full Range <sup>(1)</sup>	800			
$V_{ICR}$	Common-mode input voltage	$R_S = 50\ \Omega$ ; $ V_{IO}  \leq 5\text{ mV}$	$T_A = 25^\circ\text{C}$	-0.3	2.5	4	V
			Full Range <sup>(1)</sup>	0	2.5	3.5	
$V_{OH}$	High-level output voltage	$I_{OH} = -20\ \mu\text{A}$		4.99		V	
			$T_A = 25^\circ\text{C}$	4.85	4.93		
			Full Range <sup>(1)</sup>	4.85			
			$T_A = 25^\circ\text{C}$	4.25	4.65		
$V_{OL}$	Low-level output voltage	$V_{IC} = 2.5\text{ V}$	$I_{OL} = 50\ \mu\text{A}$	0.01		V	
			$I_{OL} = 500\ \mu\text{A}$	$T_A = 25^\circ\text{C}$	0.09		0.15
				Full Range <sup>(1)</sup>	0.15		
			$I_{OL} = 5\text{ mA}$	$T_A = 25^\circ\text{C}$	0.9		1.5
Full Range <sup>(1)</sup>	1.5						
$A_{VD}$	Large-signal differential voltage amplification	$V_{IC} = 2.5\text{ V}$ , $V_O = 1\text{ V to }4\text{ V}$	$R_L = 10\ \text{k}\Omega^{(3)}$	$T_A = 25^\circ\text{C}$	10	35	V/mV
			$R_L = 1\ \text{M}\Omega^{(3)}$	Full Range <sup>(1)</sup>	10		
				175			
$r_{id}$	Differential input resistance			$10^{12}$		$\Omega$	
$r_i$	Common-mode input resistance			$10^{12}$		$\Omega$	
$c_i$	Common-mode input capacitance	$f = 10\ \text{kHz}$ , P package		8		pF	
$z_o$	Closed-loop output impedance	$f = 1\ \text{MHz}$ , $A_V = 10$		140		$\Omega$	
CMRR	Common-mode rejection ratio	$V_{IC} = 0\text{ V to }2.7\text{ V}$ , $V_O = 2.5\text{ V}$ , $R_S = 50\ \Omega$	$T_A = 25^\circ\text{C}$	70	75	dB	
			Full Range <sup>(1)</sup>	70			
$k_{SVR}$	Supply-voltage rejection ratio ( $\Delta V_{DD} / \Delta V_{IO}$ )	$V_{DD} = 4.4\text{ V to }16\text{ V}$ , $V_{IC} = V_{DD} / 2$ , no load	$T_A = 25^\circ\text{C}$	80	95	dB	
			Full Range <sup>(1)</sup>	80			
$I_{DD}$	Supply current	$V_O = 2.5\text{ V}$ , no load	$T_A = 25^\circ\text{C}$	4.4	6	mA	
			Full Range <sup>(1)</sup>	6			
SR	Slew rate at unity gain	$V_O = 0.5\text{ V to }2.5\text{ V}$ , $R_L = 10\ \text{k}\Omega^{(3)}$ , $C_L = 100\ \text{pF}^{(3)}$	$T_A = 25^\circ\text{C}$	2.3	3.6	V/ $\mu\text{s}$	
			Full Range <sup>(1)</sup>	1.7			
$V_n$	Equivalent input noise voltage	$f = 10\ \text{Hz}$		50	nV/ $\sqrt{\text{Hz}}$		
		$f = 1\ \text{kHz}$		9			
$V_{NPP}$	Peak-to-peak equivalent input noise voltage	$f = 0.1\ \text{Hz to }1\ \text{Hz}$		1	$\mu\text{V}$		
		$f = 0.1\ \text{Hz to }10\ \text{Hz}$		1.4			
$I_n$	Equivalent input noise current			0.6	fA/ $\sqrt{\text{Hz}}$		
THD+N	Total harmonic distortion + noise	$V_O = 0.5\text{ V to }2.5\text{ V}$ , $f = 20\ \text{kHz}$ , $R_L = 10\ \text{k}\Omega^{(3)}$	$A_V = 1$	0.0013%			
			$A_V = 10$	0.004%			
			$A_V = 100$	0.03%			
	Gain-bandwidth product	$f = 10\ \text{kHz}$ , $R_L = 10\ \text{k}\Omega^{(3)}$ , $C_L = 100\ \text{pF}^{(3)}$		2.18	MHz		
$B_{OM}$	Maximum output-swing bandwidth	$V_{O(PP)} = 2\text{ V}$ , $A_V = 1$ , $R_L = 10\ \text{k}\Omega^{(3)}$ , $C_L = 100\ \text{pF}^{(3)}$		1	MHz		



## 6.7 Electrical Characteristics: $V_{DD} = 5\text{ V}$ (TLC2274-Q1 and TLC2274A-Q1) (continued)

at specified free-air temperature,  $V_{DD} = 5\text{ V}$ ;  $T_A = 25^\circ\text{C}$ , unless otherwise noted.

PARAMETER		TEST CONDITIONS		MIN	TYP	MAX	UNIT
$t_s$	Settling time	$A_V = -1$ , $R_L = 10\text{ k}\Omega^{(3)}$ , Step = $0.5\text{ V}$ to $2.5\text{ V}$ , $C_L = 100\text{ pF}^{(3)}$	To 0.1%		1.5		$\mu\text{s}$
			To 0.01%		2.6		
$\phi_m$	Phase margin at unity gain	$R_L = 10\text{ k}\Omega^{(3)}$ , $C_L = 100\text{ pF}^{(3)}$			50°		
	Gain margin	$R_L = 10\text{ k}\Omega^{(3)}$ , $C_L = 100\text{ pF}^{(3)}$			10		dB

- $T_A = -40^\circ\text{C}$  to  $125^\circ\text{C}$ .
- Typical values are based on the input offset voltage shift observed through 168 hours of operating life test at  $T_A = 150^\circ\text{C}$  extrapolated to  $T_A = 25^\circ\text{C}$  using the Arrhenius equation and assuming an activation energy of  $0.96\text{ eV}$ .
- Referenced to  $0\text{ V}$ .

## 6.8 Electrical Characteristics: $V_{DD\pm} = \pm 5\text{ V}$ (TLC2274-Q1 and TLC2274A-Q1)

at specified free-air temperature,  $V_{DD\pm} = \pm 5\text{ V}$ ;  $T_A = 25^\circ\text{C}$ , unless otherwise noted.

PARAMETER		TEST CONDITIONS		MIN	TYP	MAX	UNIT	
$V_{IO}$	Input offset voltage	$V_{IC} = 0\text{ V}$ , $V_O = 0\text{ V}$ , $R_S = 50\ \Omega$	TLC2274-Q1	$T_A = 25^\circ\text{C}$	300	2500	$\mu\text{V}$	
			TLC2274A-Q1		300	950		
			TLC2274-Q1	Full Range <sup>(1)</sup>		3000		
			TLC2274A-Q1			1500		
$\alpha_{VIO}$	Temperature coefficient of input offset voltage	$V_{IC} = 0\text{ V}$ , $V_O = 0\text{ V}$ , $R_S = 50\ \Omega$			2		$\mu\text{V}/^\circ\text{C}$	
	Input offset voltage long-term drift <sup>(2)</sup>	$V_{IC} = 0\text{ V}$ , $V_O = 0\text{ V}$ , $R_S = 50\ \Omega$			0.002		$\mu\text{V}/\text{mo}$	
$I_{IO}$	Input offset current	$V_{IC} = 0\text{ V}$ , $V_O = 0\text{ V}$ , $R_S = 50\ \Omega$	$T_A = 25^\circ\text{C}$	0.5	60	$\text{pA}$		
			Full Range <sup>(1)</sup>		800			
$I_{IB}$	Input bias current	$V_{IC} = 0\text{ V}$ , $V_O = 0\text{ V}$ , $R_S = 50\ \Omega$	$T_A = 25^\circ\text{C}$	1	60	$\text{pA}$		
			Full Range <sup>(1)</sup>		800			
$V_{ICR}$	Common-mode input voltage	$R_S = 50\ \Omega$ ; $ V_{IO}  \leq 5\text{ mV}$	$T_A = 25^\circ\text{C}$	-5.3	0	4	V	
			Full Range <sup>(1)</sup>	-5	0	3.5		
$V_{OM+}$	Maximum positive peak output voltage	$I_O = -20\ \mu\text{A}$ $I_O = -200\ \mu\text{A}$ $I_O = -1\text{ mA}$	$T_A = 25^\circ\text{C}$	4.85	4.93	V		
			Full Range <sup>(1)</sup>	4.85				
			$T_A = 25^\circ\text{C}$	4.25	4.65			
			Full Range <sup>(1)</sup>	4.25				
$V_{OM-}$	Maximum negative peak output voltage	$V_{IC} = 0\text{ V}$	$I_O = 50\ \mu\text{A}$		-4.99	V		
			$I_O = 500\ \mu\text{A}$	$T_A = 25^\circ\text{C}$	-4.85		-4.91	
				Full Range <sup>(1)</sup>	-4.85			
			$I_O = 5\text{ mA}$	$T_A = 25^\circ\text{C}$	-3.5		-4.1	
Full Range <sup>(1)</sup>	-3.5							
$A_{VD}$	Large-signal differential voltage amplification	$V_O = \pm 4\text{ V}$	$R_L = 10\text{ k}\Omega$	$T_A = 25^\circ\text{C}$	20	50	V/mV	
			$R_L = 1\text{ M}\Omega$	Full Range <sup>(1)</sup>	20			
					300			
$r_{id}$	Differential input resistance				$10^{12}$	$\Omega$		
$r_i$	Common-mode input resistance				$10^{12}$	$\Omega$		
$c_i$	Common-mode input capacitance	$f = 10\text{ kHz}$ , P package			8	pF		
$z_o$	Closed-loop output impedance	$f = 1\text{ MHz}$ , $A_V = 10$			130	$\Omega$		
CMRR	Common-mode rejection ratio	$V_{IC} = -5\text{ V}$ to $2.7\text{ V}$ , $V_O = 0\text{ V}$ , $R_S = 50\ \Omega$	$T_A = 25^\circ\text{C}$	75	80	dB		
			Full Range <sup>(1)</sup>	75				
$k_{SVR}$	Supply-voltage rejection ratio ( $\Delta V_{DD} / \Delta V_{IO}$ )	$V_{DD+} = 2.2\text{ V}$ to $\pm 8\text{ V}$ , $V_{IC} = 0\text{ V}$ , no load	$T_A = 25^\circ\text{C}$	80	95	dB		
			Full Range <sup>(1)</sup>	80				
$I_{DD}$	Supply current	$V_O = 0\text{ V}$ , no load	$T_A = 25^\circ\text{C}$	4.8	6	mA		
			Full Range <sup>(1)</sup>		6			

## 6.8 Electrical Characteristics: $V_{DD\pm} = \pm 5\text{ V}$ (TLC2274-Q1 and TLC2274A-Q1) (continued)

at specified free-air temperature,  $V_{DD\pm} = \pm 5\text{ V}$ ;  $T_A = 25^\circ\text{C}$ , unless otherwise noted.

PARAMETER		TEST CONDITIONS		MIN	TYP	MAX	UNIT
SR	Slew rate at unity gain	$V_O = \pm 2.3\text{ V}$ , $R_L = 10\text{ k}\Omega$ , $C_L = 100\text{ pF}$	$T_A = 25^\circ\text{C}$	2.3	3.6		V/ $\mu\text{s}$
			Full Range <sup>(1)</sup>	1.7			
$V_n$	Equivalent input noise voltage		$f = 10\text{ Hz}$		50		nV/ $\sqrt{\text{Hz}}$
			$f = 1\text{ kHz}$		9		
$V_{NPP}$	Peak-to-peak equivalent input noise voltage		$f = 0.1\text{ Hz to }1\text{ Hz}$		1		$\mu\text{V}$
			$f = 0.1\text{ Hz to }10\text{ Hz}$		1.4		
$I_n$	Equivalent input noise current				0.6		fA/ $\sqrt{\text{Hz}}$
THD+N	Total harmonic distortion + noise	$V_O = \pm 2.3$ , $f = 20\text{ kHz}$ , $R_L = 10\text{ k}\Omega$	$A_V = 1$		0.0011%		
			$A_V = 10$		0.004%		
			$A_V = 100$		0.03%		
	Gain-bandwidth product	$f = 10\text{ kHz}$ , $R_L = 10\text{ k}\Omega$ , $C_L = 100\text{ pF}$			2.25		MHz
$B_{OM}$	Maximum output-swing bandwidth	$V_{O(PP)} = 4.6\text{ V}$ , $A_V = 1$ , $R_L = 10\text{ k}\Omega$ , $C_L = 100\text{ pF}$			0.54		MHz
$t_s$	Settling time	$A_V = -1$ , $R_L = 10\text{ k}\Omega$ , Step = $-2.3\text{ V to }2.3\text{ V}$ , $C_L = 100\text{ pF}$	To 0.1%		1.5		$\mu\text{s}$
			To 0.01%		3.2		
$\phi_m$	Phase margin at unity gain	$R_L = 10\text{ k}\Omega$ , $C_L = 100\text{ pF}$			52°		
	Gain margin	$R_L = 10\text{ k}\Omega$ , $C_L = 100\text{ pF}$			10		dB

(1)  $T_A = -40^\circ\text{C to }125^\circ\text{C}$ .

(2) Typical values are based on the input offset voltage shift observed through 168 hours of operating life test at  $T_A = 150^\circ\text{C}$  extrapolated to  $T_A = 25^\circ\text{C}$  using the Arrhenius equation and assuming an activation energy of 0.96 eV.

## 6.9 Typical Characteristics

**Table 6-1. Table of Graphs**

			FIGURE <sup>(1)</sup>
$V_{IO}$	Input offset voltage	Distribution	1, 2, 3, 4
		vs Common-mode voltage	5, 6
$\alpha_{VIO}$	Input offset voltage temperature coefficient	Distribution	7, 8, 9, 10 <sup>(2)</sup>
$I_B / I_{IO}$	Input bias and input offset current	vs Free-air temperature	11 <sup>(2)</sup>
$V_I$	Input voltage	vs Supply voltage	12
		vs Free-air temperature	13 <sup>(2)</sup>
$V_{OH}$	High-level output voltage	vs High-level output current	14 <sup>(2)</sup>
$V_{OL}$	Low-level output voltage	vs Low-level output current	15, 16 <sup>(2)</sup>
$V_{OM+}$	Maximum positive peak output voltage	vs Output current	17 <sup>(2)</sup>
$V_{OM-}$	Maximum negative peak output voltage	vs Output current	18 <sup>(2)</sup>
$V_{O(PP)}$	Maximum peak-to-peak output voltage	vs Frequency	19
$I_{OS}$	Short-circuit output current	vs Supply voltage	20
		vs Free-air temperature	21 <sup>(2)</sup>
$V_O$	Output voltage	vs Differential input voltage	22, 23
$A_{VD}$	Large-signal differential voltage amplification	vs Load resistance	24
	Large-signal differential voltage amplification and phase margin	vs Frequency	25, 26
	Large-signal differential voltage amplification	vs Free-air temperature	27 <sup>(2)</sup> , 28 <sup>(2)</sup>
$Z_0$	Output impedance	vs Frequency	29, 30
CMRR	Common-mode rejection ratio	vs Frequency	31
		vs Free-air temperature	32
$k_{SVR}$	Supply-voltage rejection ratio	vs Frequency	33, 34
		vs Free-air temperature	35 <sup>(2)</sup>
$I_{DD}$	Supply current	vs Supply voltage	36 <sup>(2)</sup> , 37 <sup>(2)</sup>
		vs Free-air temperature	38 <sup>(2)</sup> , 39 <sup>(2)</sup>
SR	Slew rate	vs Load Capacitance	40
		vs Free-air temperature	41 <sup>(2)</sup>
$V_O$	Inverting large-signal pulse response		42, 43
	Voltage-follower large-signal pulse response		44, 45
	Inverting small-signal pulse response		46, 47
	Voltage-follower small-signal pulse response		48, 49
$V_n$	Equivalent input noise voltage	vs Frequency	50, 51
	Noise voltage over a 10-second period		52
	Integrated noise voltage	vs Frequency	53
THD+N	Total harmonic distortion + noise	vs Frequency	54
	Gain-bandwidth product	vs Supply voltage	55
		vs Free-air temperature	56 <sup>(2)</sup>
$\Phi_m$	Phase margin	vs Load capacitance	57
	Gain margin	vs Load capacitance	58

(1) For all graphs where  $V_{DD} = 5$  V, all loads are referenced to 2.5 V.

(2) Data at high and low temperatures are applicable only within the rated operating free-air temperature ranges of the various devices.

## 6.9 Typical Characteristics (continued)

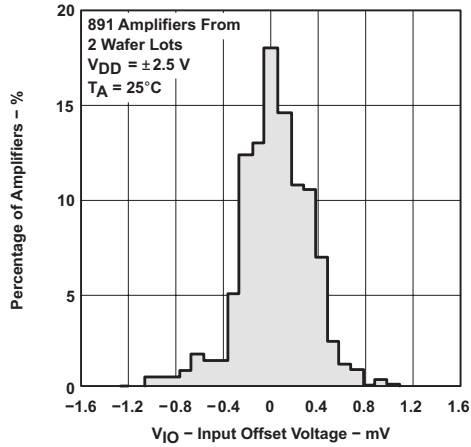

Figure 6-1. Distribution of TLC2272-Q1 Input Offset Voltage

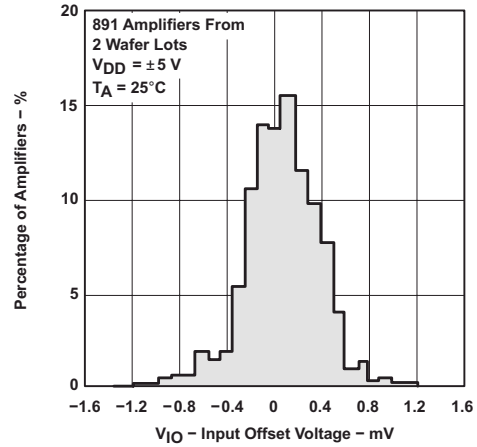

Figure 6-2. Distribution of TLC2272-Q1 Input Offset Voltage

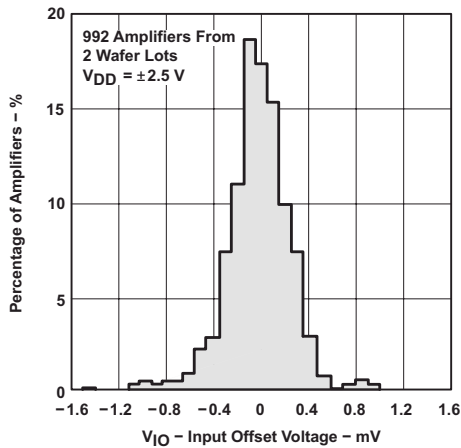

Figure 6-3. Distribution of TLC2274-Q1 Input Offset Voltage

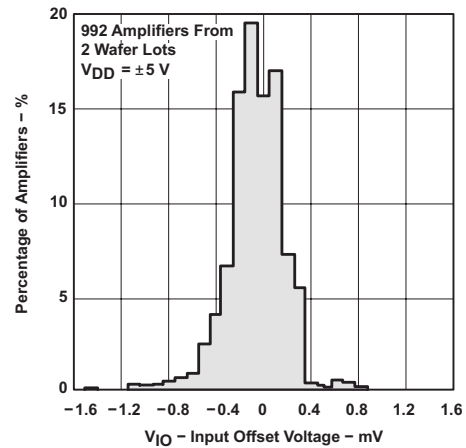

Figure 6-4. Distribution of TLC2274-Q1 Input Offset Voltage

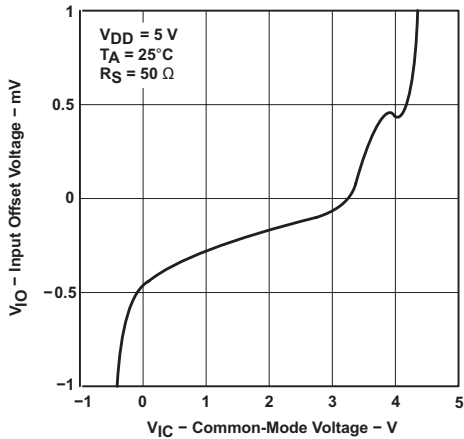

Figure 6-5. Input Offset Voltage vs Common-Mode Voltage

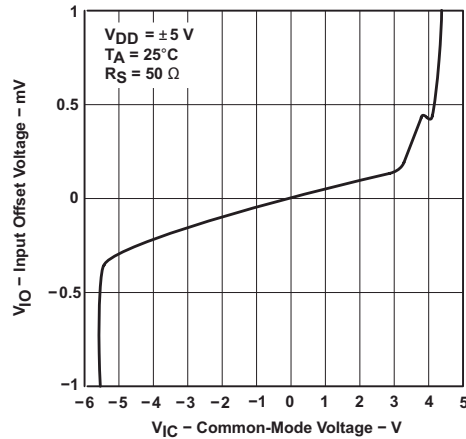

Figure 6-6. Input Offset Voltage vs Common-Mode Voltage

## 6.9 Typical Characteristics (continued)

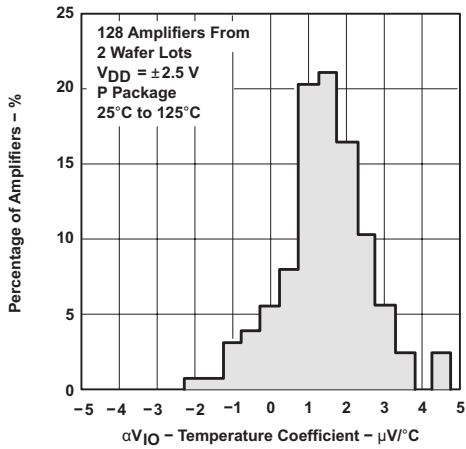

Figure 6-7. Distribution of TLC2272-Q1 vs Input Offset Voltage Temperature Coefficient

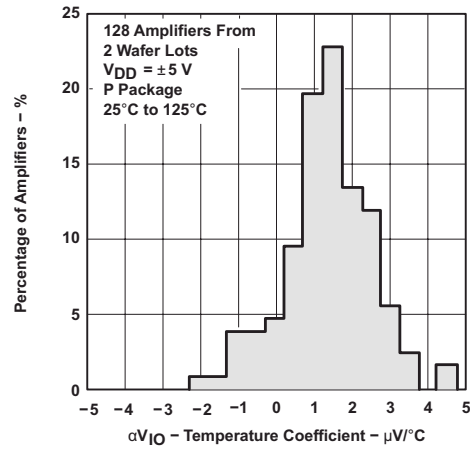

Figure 6-8. Distribution of TLC2272-Q1 vs Input Offset Voltage Temperature Coefficient

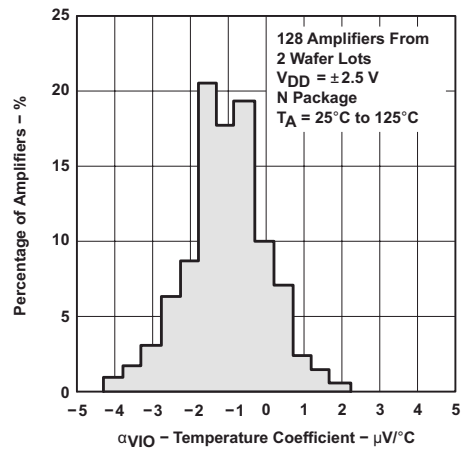

Figure 6-9. Distribution of TLC2274-Q1 vs Input Offset Voltage Temperature Coefficient

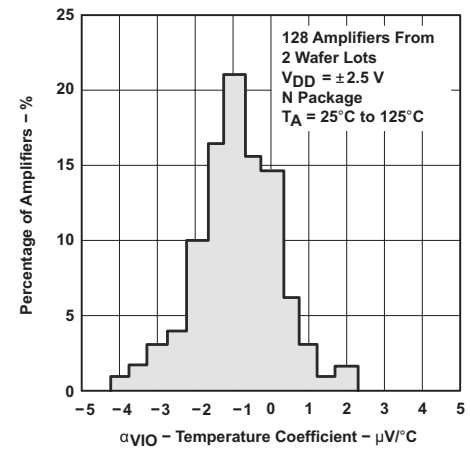

Figure 6-10. Distribution of TLC2274-Q1 vs Input Offset Voltage Temperature Coefficient

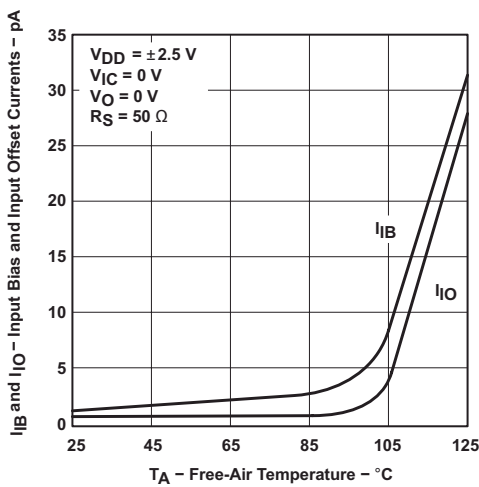

Figure 6-11. Input Bias and Input Offset Current vs Free-Air Temperature

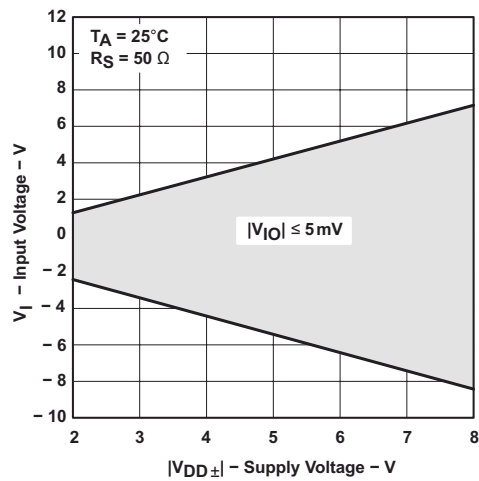

Figure 6-12. Input Voltage vs Supply Voltage

### 6.9 Typical Characteristics (continued)

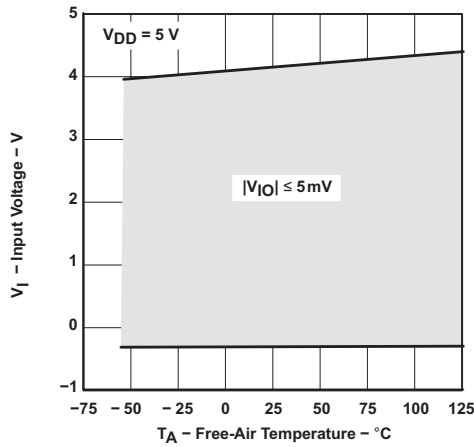

Figure 6-13. Input Voltage vs Free-Air Temperature

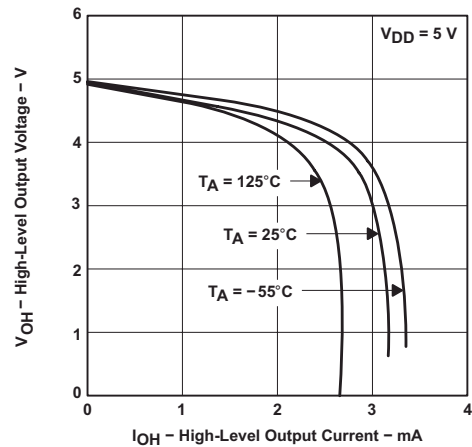

Figure 6-14. High-Level Output Voltage vs High-Level Output Current

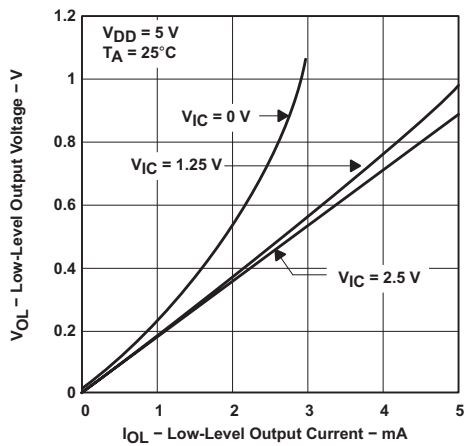

Figure 6-15. Low-Level Output Voltage vs Low-Level Output Current

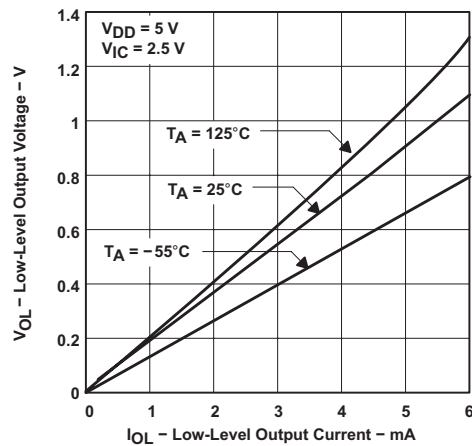

Figure 6-16. Low-Level Output Voltage vs Low-Level Output Current

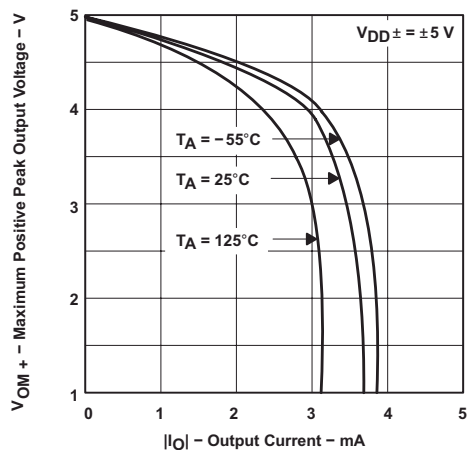

Figure 6-17. Maximum Positive Peak Output Voltage vs Output Current

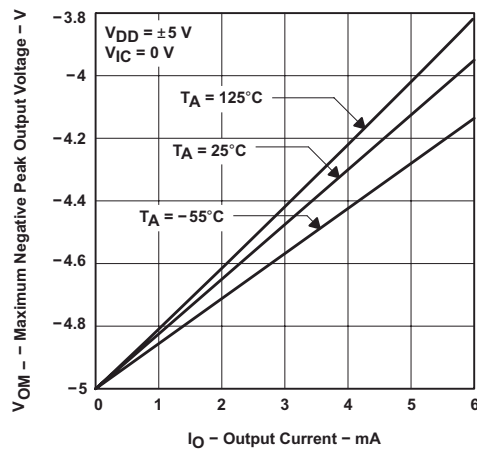
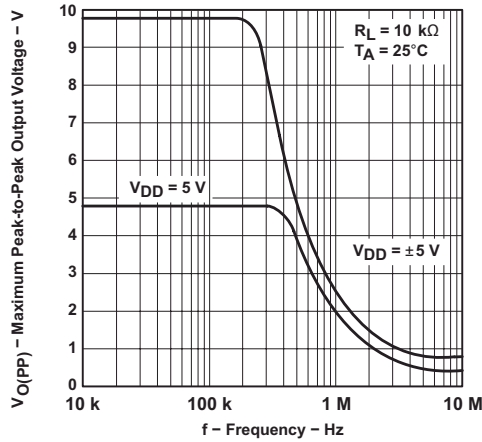
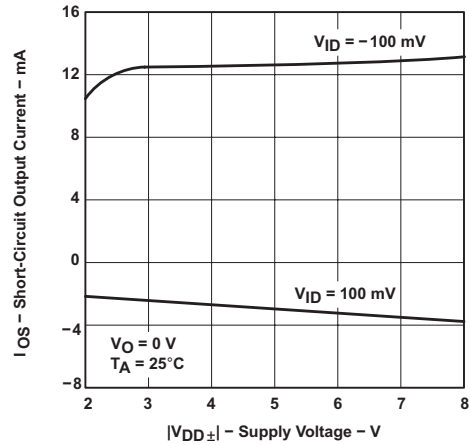

Figure 6-18. Maximum Positive Peak Output Voltage vs Output Current

### 6.9 Typical Characteristics (continued)



**Figure 6-19. Maximum Peak-to-Peak Output Voltage vs Frequency**



**Figure 6-20. Short-Circuit Output Current vs Supply Voltage**

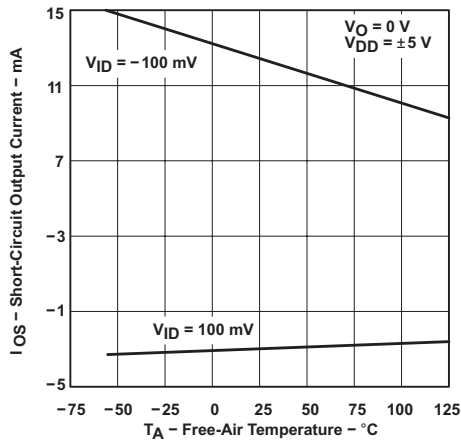

**Figure 6-21. Short-Circuit Output Current vs Free-Air Temperature**

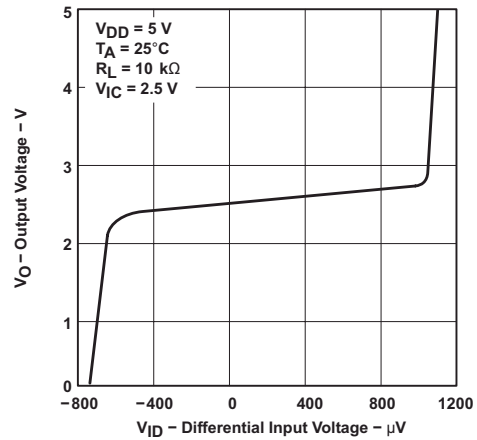

**Figure 6-22. Output Voltage vs Differential Input Voltage**

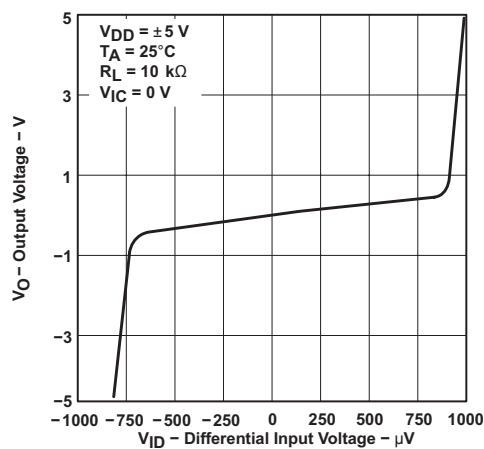

**Figure 6-23. Output Voltage vs Differential Input Voltage**

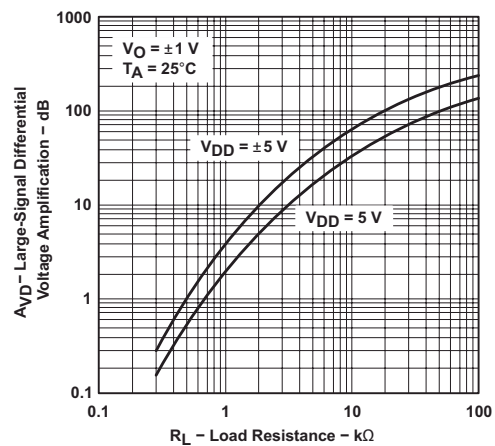

**Figure 6-24. Large-Signal Differential Voltage Amplification vs Load Resistance**

### 6.9 Typical Characteristics (continued)

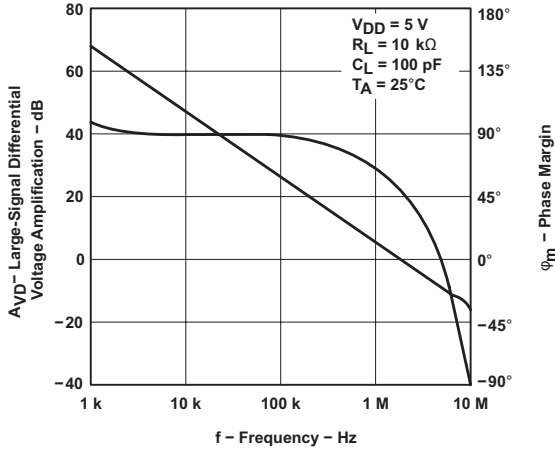

Figure 6-25. Large-Signal Differential Voltage Amplification and Phase Margin vs Frequency

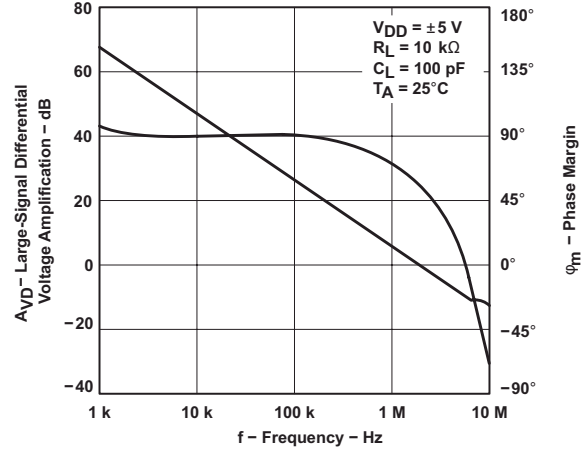

Figure 6-26. Large-Signal Differential Voltage Amplification and Phase Margin vs Frequency

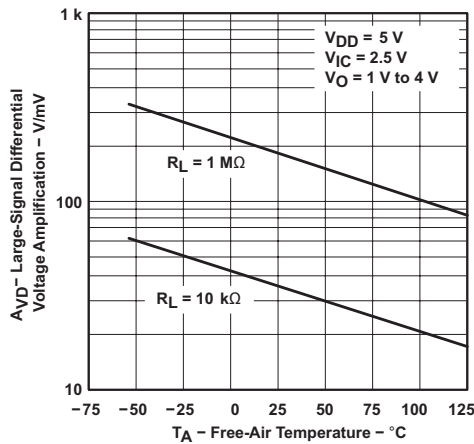

Figure 6-27. Large-Signal Differential Voltage Amplification vs Free-Air Temperature

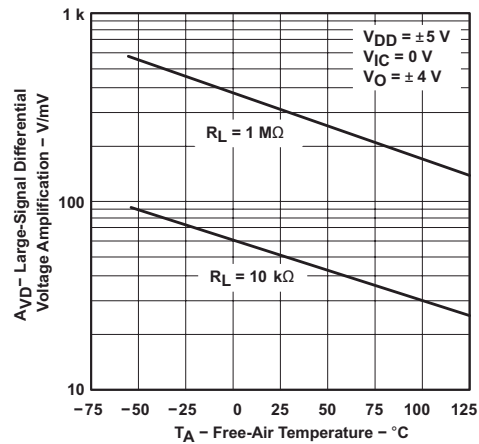

Figure 6-28. Large-Signal Differential Voltage Amplification vs Free-Air Temperature

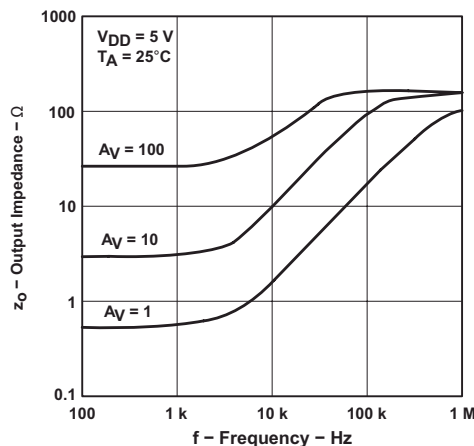

Figure 6-29. Output Impedance vs Frequency

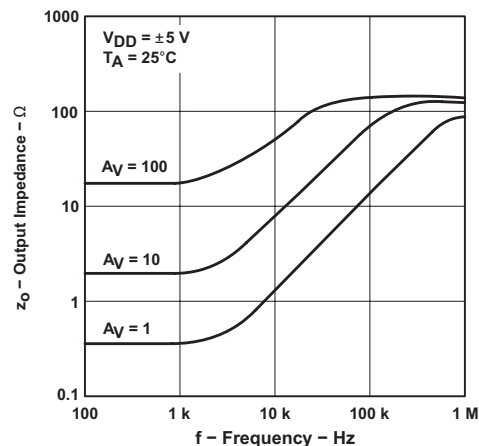

Figure 6-30. Output Impedance vs Frequency



### 6.9 Typical Characteristics (continued)

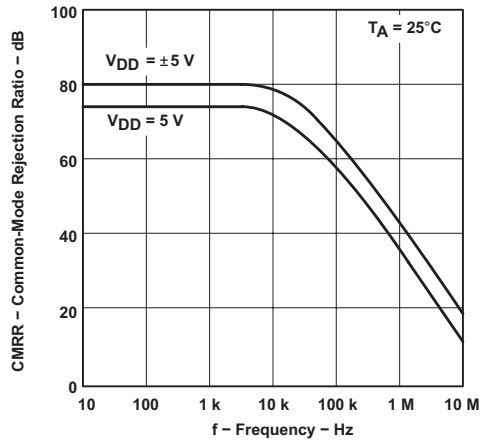

Figure 6-31. Common-Mode Rejection Ratio vs Frequency

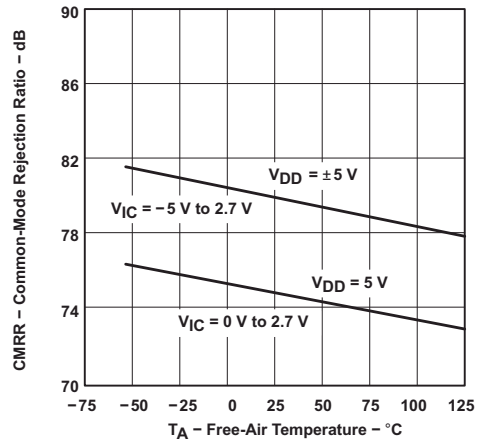

Figure 6-32. Common-Mode Rejection Ratio vs Free-Air Temperature

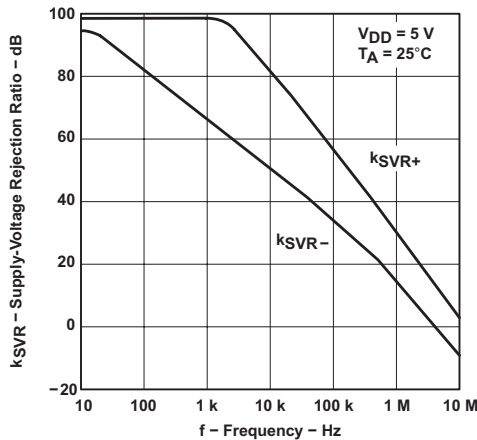

Figure 6-33. Supply-Voltage Rejection Ratio vs Frequency

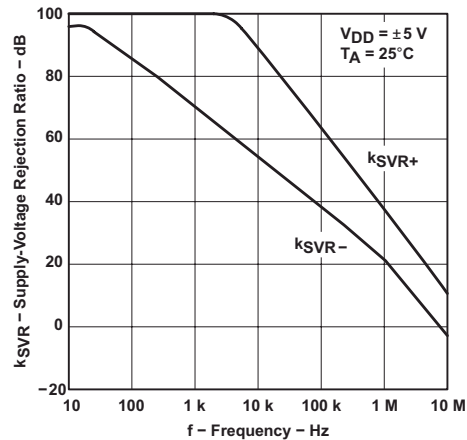

Figure 6-34. Supply-Voltage Rejection Ratio vs Frequency

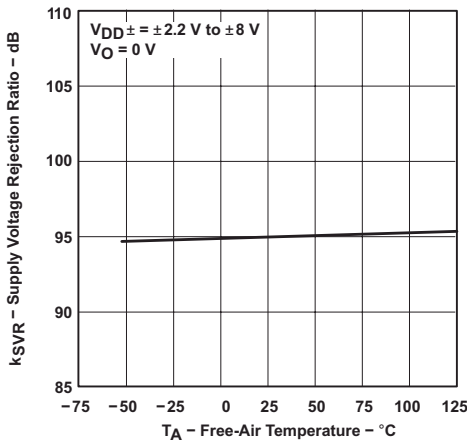

Figure 6-35. Supply-Voltage Rejection Ratio vs Free-Air Temperature

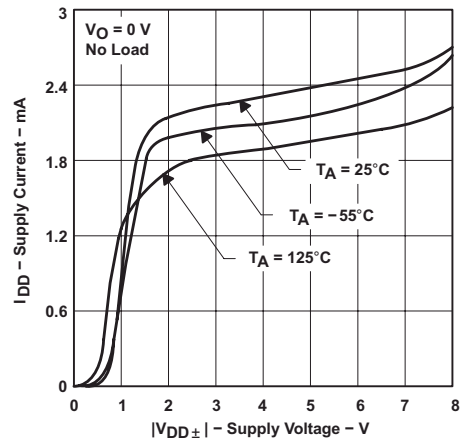

Figure 6-36. TLC2272-Q1 Supply Current vs Supply Voltage

### 6.9 Typical Characteristics (continued)

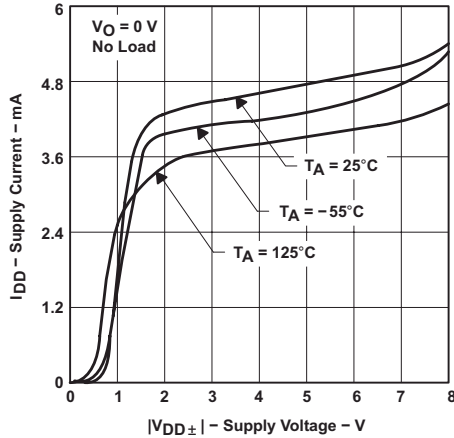

Figure 6-37. TLC2274-Q1 Supply Current vs Supply Voltage

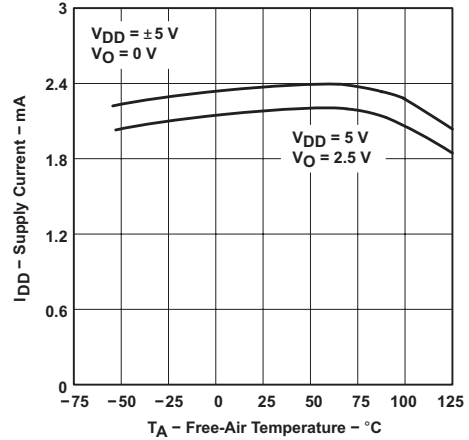

Figure 6-38. TLC2272-Q1 Supply Current vs Free-Air Temperature

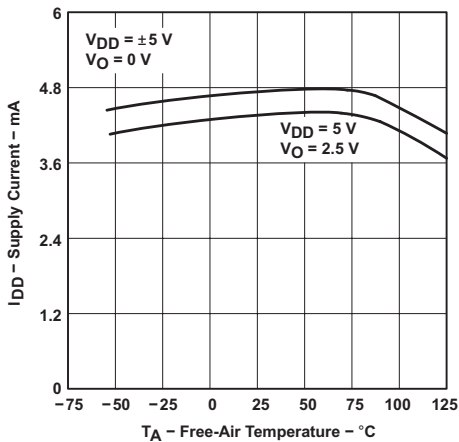

Figure 6-39. TLC2274-Q1 Supply Current vs Free-Air Temperature

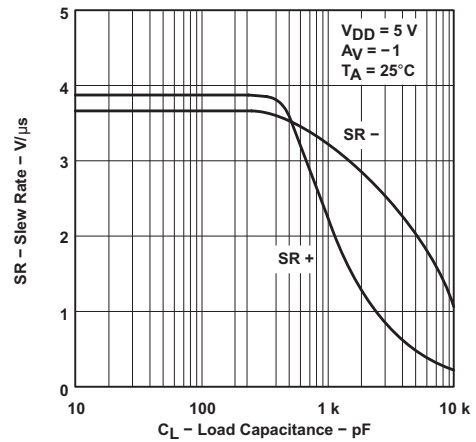

Figure 6-40. Slew Rate vs Load Capacitance

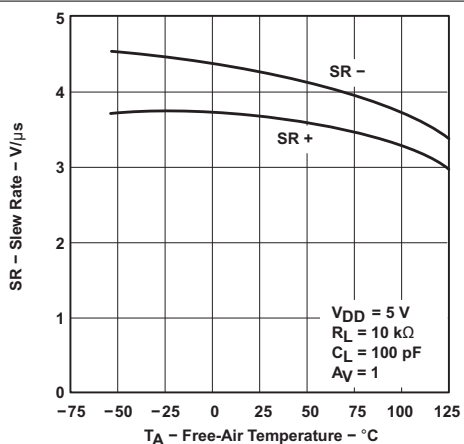

Figure 6-41. Slew Rate vs Free-Air Temperature

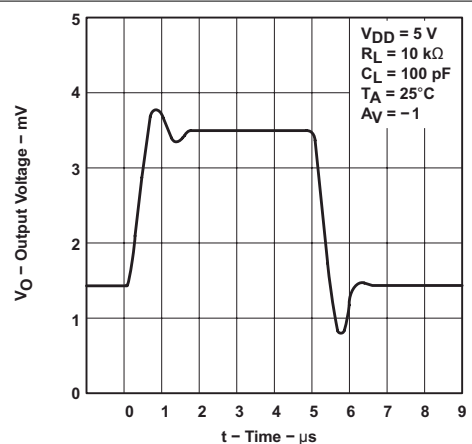

Figure 6-42. Inverting Large-Signal Pulse Response

## 6.9 Typical Characteristics (continued)

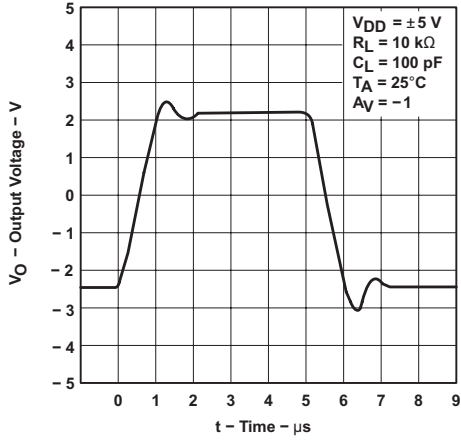

Figure 6-43. Inverting Large-Signal Pulse Response

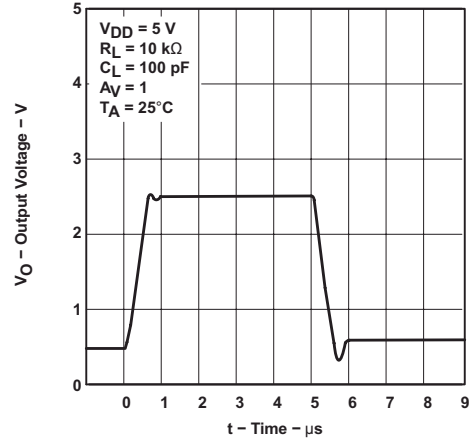

Figure 6-44. Voltage-Follower Large-Signal Pulse Response

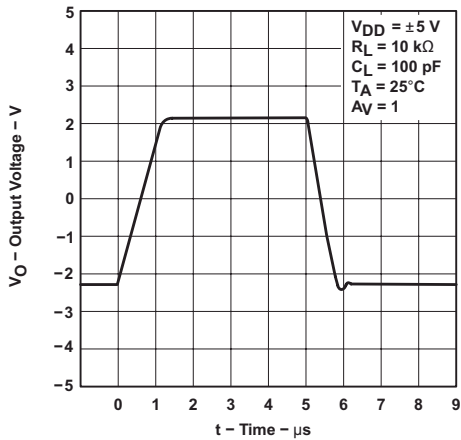

Figure 6-45. Voltage-Follower Large-Signal Pulse Response

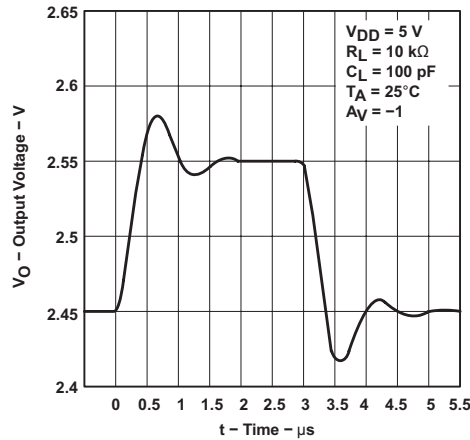

Figure 6-46. Inverting Small-Signal Pulse Response

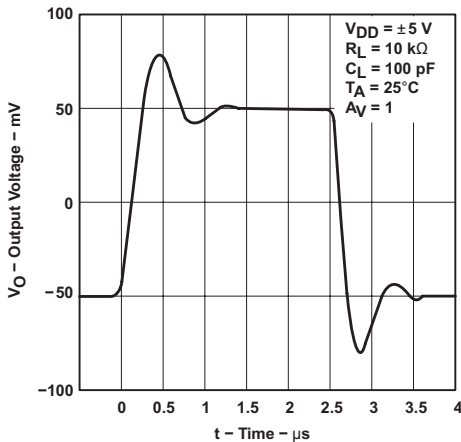

Figure 6-47. Inverting Small-Signal Pulse Response

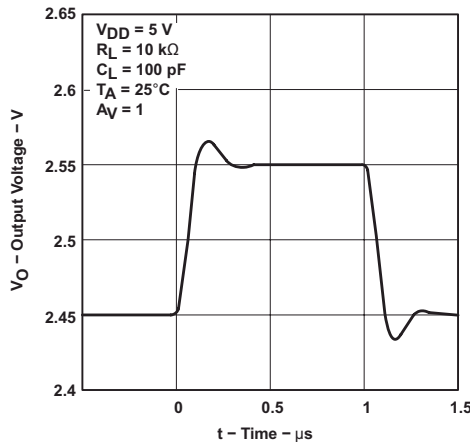

Figure 6-48. Voltage-Follower Small-Signal Pulse Response

## 6.9 Typical Characteristics (continued)

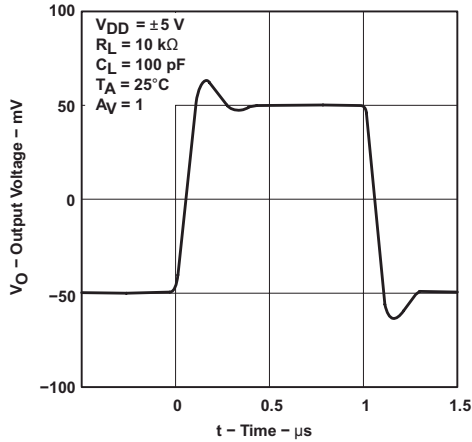

Figure 6-49. Voltage-Follower Small-Signal Pulse Response

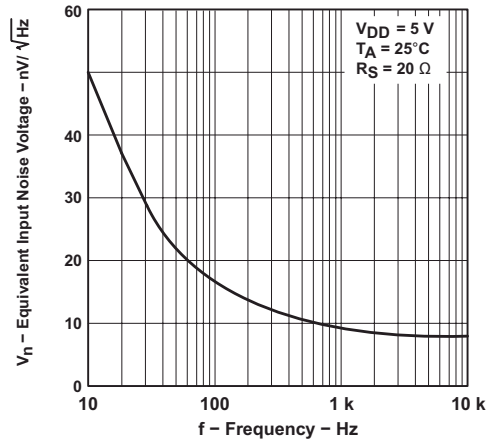

Figure 6-50. Equivalent Input Noise Voltage vs Frequency

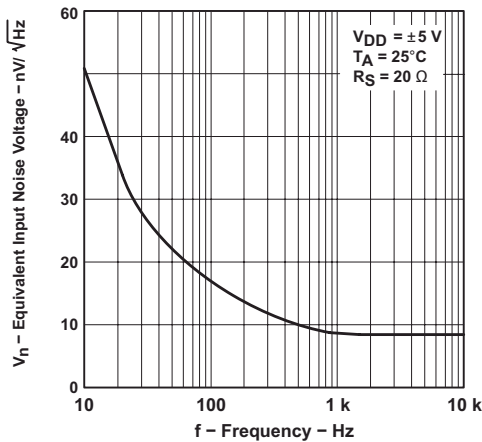

Figure 6-51. Equivalent Input Noise Voltage vs Frequency

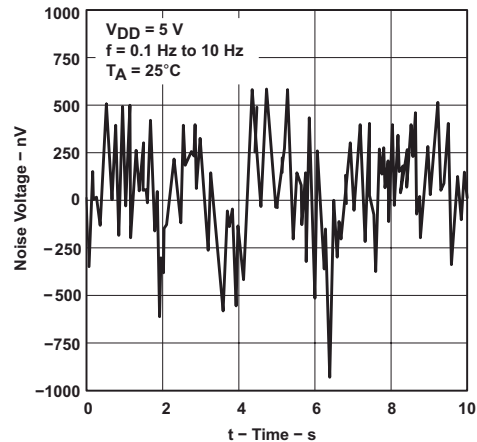

Figure 6-52. Noise Voltage Over a 10 Second Period

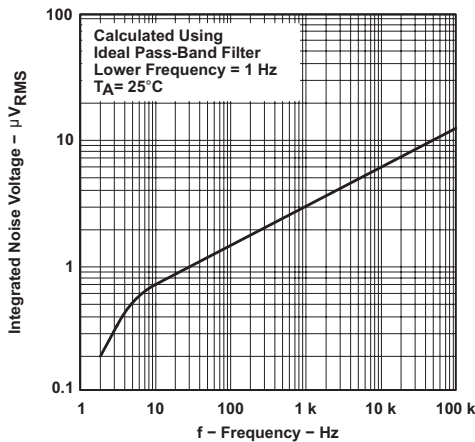

Figure 6-53. Integrated Noise Voltage vs Frequency

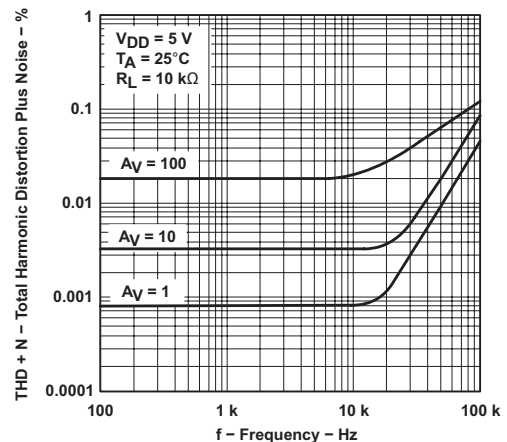
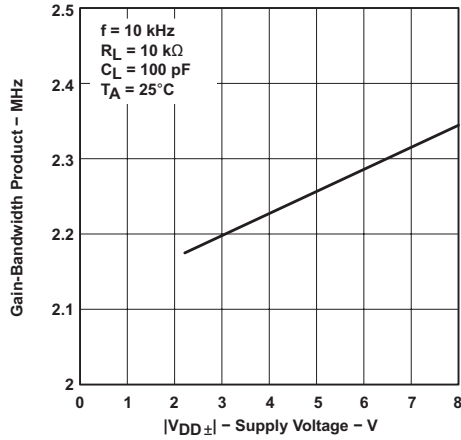
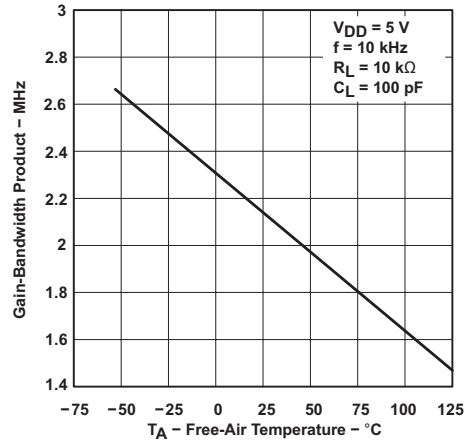

Figure 6-54. Total Harmonic Distortion + Noise vs Frequency

### 6.9 Typical Characteristics (continued)



**Figure 6-55. Gain-Bandwidth Product vs Supply Voltage**



**Figure 6-56. Gain-Bandwidth Product vs Free-Air Temperature**

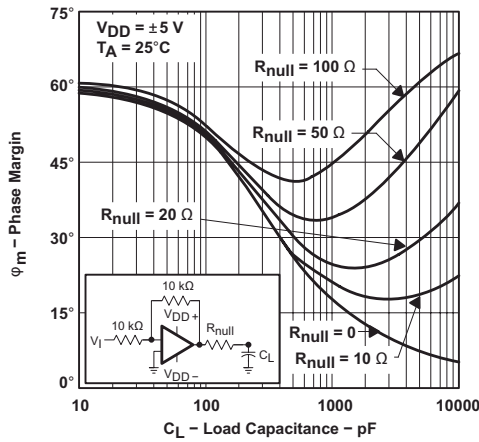

**Figure 6-57. Phase Margin vs Load Capacitance**

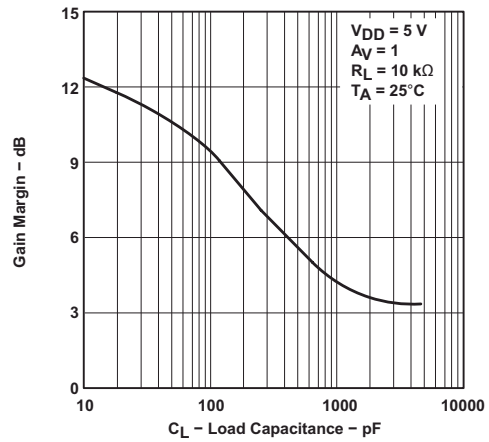

**Figure 6-58. Gain Margin vs Load Capacitance**

## 7 Detailed Description

### 7.1 Overview

The TLC227x-Q1 devices are a rail-to-rail output operational amplifiers. These devices operate from a 4.4-V to 16-V single supply and a  $\pm 2.2$ -V  $\pm 8$ -V dual supply, are unity-gain stable, and are an excellent choice for a wide range of general-purpose applications.

### 7.2 Functional Block Diagram

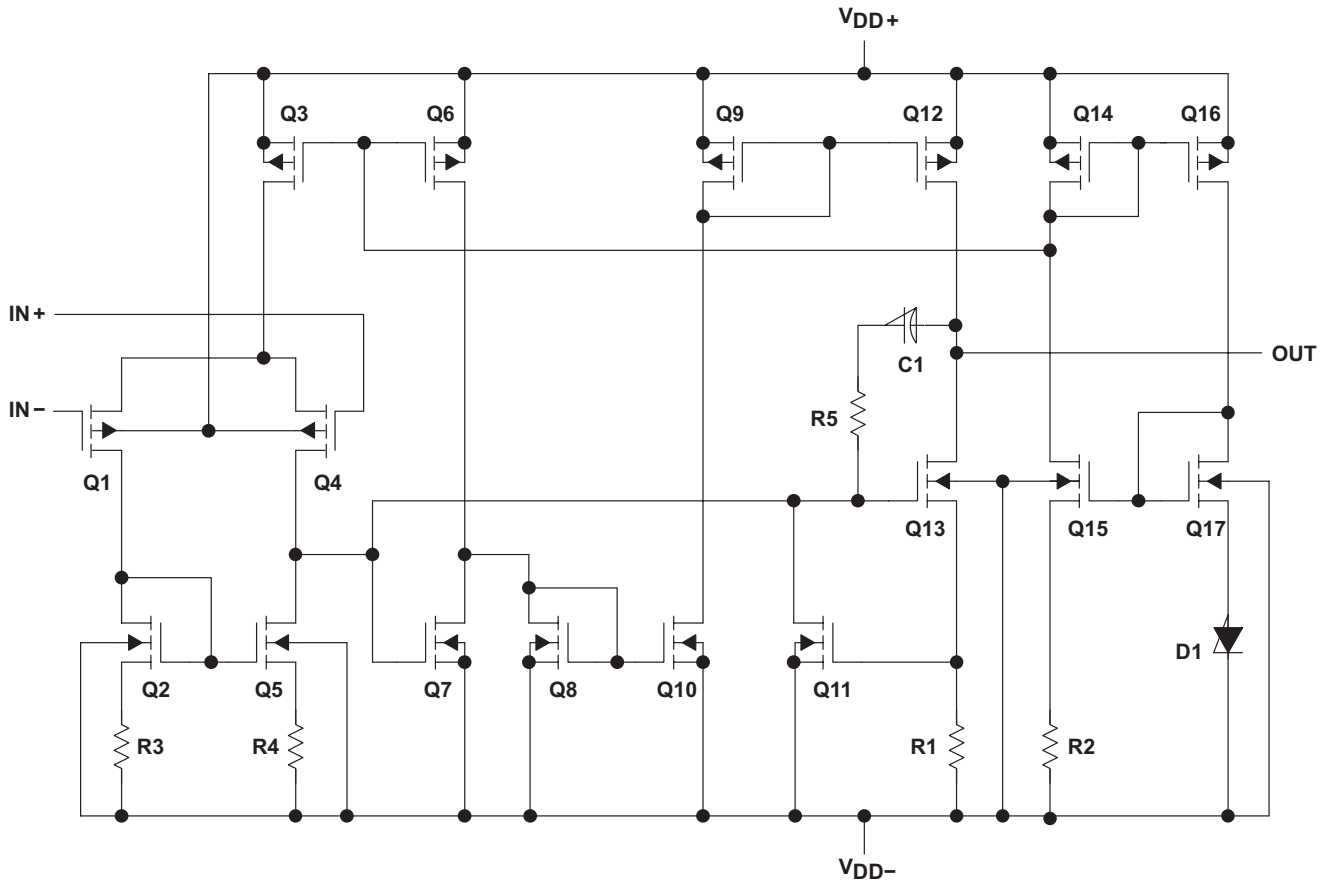

**Table 7-1. Actual Device Component Count<sup>(1)</sup>**

COMPONENT	TLC2272-Q1	TLC2274-Q1
Transistors	38	76
Resistors	26	52
Diodes	9	18
Capacitors	3	6

(1) Includes both amplifiers and all ESD, bias, and trim circuitry.

### 7.3 Feature Description

The TLC227x-Q1 family features 2-MHz bandwidth and voltage noise of  $9 \text{ nV}/\sqrt{\text{Hz}}$  with performance rated from 4.4 V to 16 V across an automotive temperature range ( $-40^\circ\text{C}$  to  $+125^\circ\text{C}$ ). LinMOS is a great choice for a wide range of audio, automotive, industrial, and instrumentation applications.

### 7.4 Device Functional Modes

The TLC227x-Q1 family of devices is powered on when the supply is connected. The device can operate with single or dual supply, depending on the application. The device is in full performance after the supply is greater than the recommended value.

## 8 Application and Implementation

### Note

Information in the following applications sections is not part of the TI component specification, and TI does not warrant its accuracy or completeness. TI's customers are responsible for determining suitability of components for their purposes, as well as validating and testing their design implementation to confirm system functionality.

### 8.1 Application Information

#### 8.1.1 Macromodel Information

Macromodel information provided was derived using MicroSim Parts, the model generation software used with PSpice®. The Boyle macromodel (see also [Section 9.2.1](#)) and subcircuit in [Figure 8-1](#) were generated using the TLC227x typical electrical and operating characteristics at  $T_A = 25^\circ\text{C}$ . Using this information, output simulations of the following key parameters can be generated to a tolerance of 20% (in most cases):

- Maximum positive output voltage swing
- Maximum negative output voltage swing
- Slew rate
- Quiescent power dissipation
- Input bias current
- Open-loop voltage amplification
- Unity gain frequency
- Common-mode rejection ratio
- Phase margin
- DC output resistance
- AC output resistance
- Short-circuit output current limit

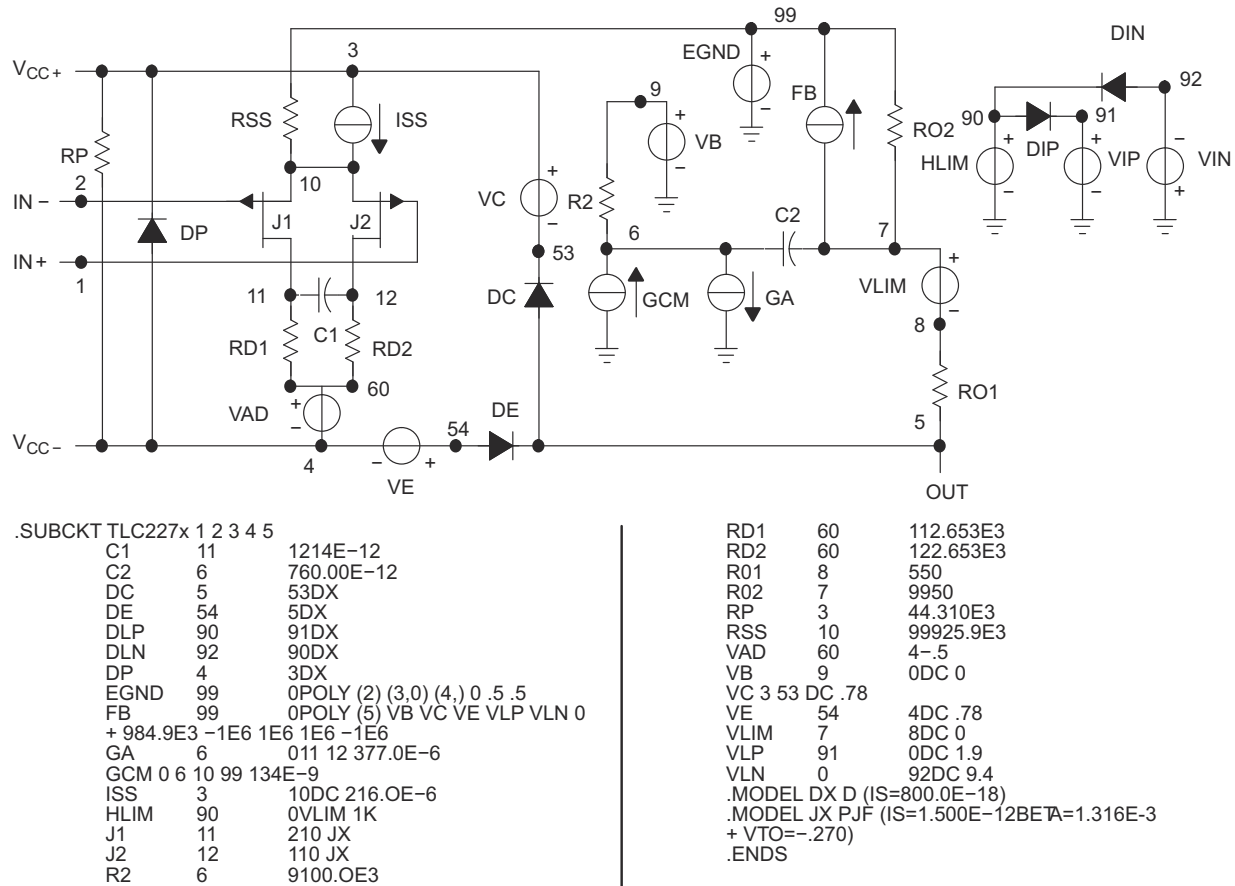

Figure 8-1. Boyle Macromodels and Subcircuit

## 8.2 Typical Application

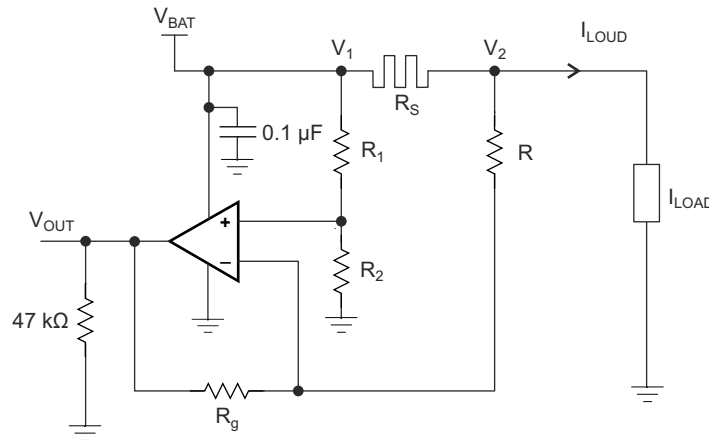

Figure 8-2. High-Side Current Monitor Equivalent Schematic (Each Amplifier)

### 8.2.1 Design Requirements

For this design example, use these parameters listed in [Table 8-1](#) as the input parameters.

Table 8-1. Design Parameters

PARAMETER		VALUE
V <sub>BAT</sub>	Battery voltage	12 V
R <sub>SENSE</sub>	Sense resistor	0.1 Ω
I <sub>LOAD</sub>	Load current	0 A to 10 A
	Operational amplifier	Set in differential configuration with gain = 10

### 8.2.2 Detailed Design Procedure

This circuit is designed for measuring the high-side current in automotive body control modules with a 12-V battery or similar applications. The operational amplifier is set as differential with an external resistor network.

#### 8.2.2.1 Differential Amplifier Equations

[Equation 1](#) and [Equation 2](#) are used to calculate V<sub>OUT</sub>.

$$V_{OUT} = \frac{R_g}{R} \left( \frac{\frac{R}{R_g} - \frac{R_1}{R_2}}{1 + \frac{R_1}{R_2}} \times \frac{V_1 + V_2}{2} + \frac{1 + \frac{1}{2} \left( \frac{R_1}{R_2} + \frac{R}{R_g} \right)}{1 + \frac{R_1}{R_2}} (V_1 - V_2) \right) \quad (1)$$

$$V_{OUT} = \frac{R_g}{R} \left( \frac{\frac{R}{R_g} - \frac{R_1}{R_2}}{1 + \frac{R_1}{R_2}} \times V_{BAT} + \frac{1 + \frac{1}{2} \left( \frac{R_1}{R_2} + \frac{R}{R_g} \right)}{1 + \frac{R_1}{R_2}} \times R_S \times I_{Load} \right) \quad (2)$$

In an ideal case, [Equation 3](#) then calculates R<sub>1</sub> = R and R<sub>2</sub> = R<sub>g</sub>, and V<sub>OUT</sub>:

$$V_{OUT} = \frac{R_g}{R} \times R_S \times I_{Load} \quad (3)$$



However, the resistors have tolerances; therefore, the resistors cannot be perfectly matched.

$$R_1 = R \pm \Delta R_1$$

$$R_2 = R_2 \pm \Delta R_2$$

$$R = R \pm \Delta R$$

$$R_g = R_g \pm \Delta R_g$$

$$\text{Tol} = \frac{\Delta R}{R} \tag{4}$$

Equation 5 shows that by developing the equations and neglecting the second order, the worst case is when the tolerances add up:

$$V_{\text{OUT}} = \pm (4 \text{ Tol}) \frac{R_g}{R + R_g} \times V_{\text{BAT}} + \left( 1 \pm 2 \text{ Tol} \left( 1 + \frac{2R}{R + R_g} \right) \right) \frac{R_g}{R} \times R_S \times I_{\text{LOAD}} \tag{5}$$

where

- Tol = 0.01 for 1%
- Tol = 0.001 for 0.1%

If the resistors are perfectly matched, then Tol = 0 and Equation 6 calculates  $V_{\text{OUT}}$ :

$$V_{\text{OUT}} = \frac{R_g}{R} \times R_S \times I_{\text{LOAD}} \tag{6}$$

The highest error is from the common mode:

$$4 (\text{Tol}) \frac{R_g}{R + R_g} \times V_{\text{BAT}} \tag{7}$$

Gain of 10,  $R_g / R = 10$ , and Tol = 1%:

$$\text{Common mode error} = ((4 \times 0.01) / 1.1) \times 12 \text{ V} = 0.436 \text{ V}$$

Gain of 10 and Tol = 0.1%:

$$\text{Common mode error} = 43.6 \text{ mV}$$

The resistors were chosen from 2% batches.

$R_1$  and R 12 k $\Omega$

$R_2$  and  $R_g$  120 k $\Omega$

$$\text{Ideal Gain} = 120 / 12 = 10$$

The measured value of the resistors:

$$R_1 = 11.835 \text{ k}\Omega$$

$$R = 11.85 \text{ k}\Omega$$

$$R_2 = 117.92 \text{ k}\Omega$$

$$R_g = 118.07 \text{ k}\Omega$$

### 8.2.3 Application Curves

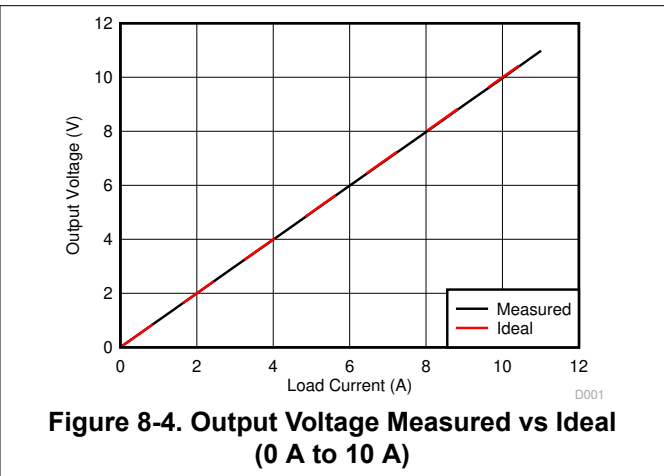
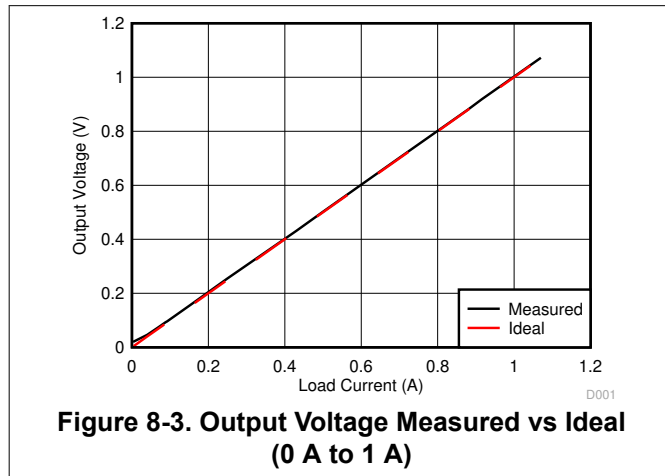

### 8.3 Power Supply Recommendations

Supply voltage is 4.4 V to 16 V for single supply and  $\pm 2.2$  V to  $\pm 8$  V for dual. In the high-side sensing application, the supply is connected to a 12-V battery.

### 8.4 Layout

#### 8.4.1 Layout Guidelines

The TLC227x-Q1 is a wideband amplifier. To realize the full operational performance of the device, good high frequency printed-circuit-board (PCB) layout practices are required. Low-loss 0.1- $\mu$ F bypass capacitors must be connected between each supply pin and ground as close to the device as possible. The bypass capacitor traces must be designed for minimum inductance.

#### 8.4.2 Layout Example

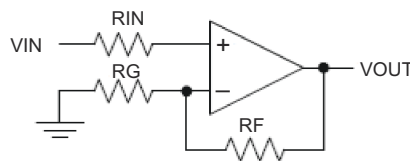

**Figure 8-5. Schematic Representation**

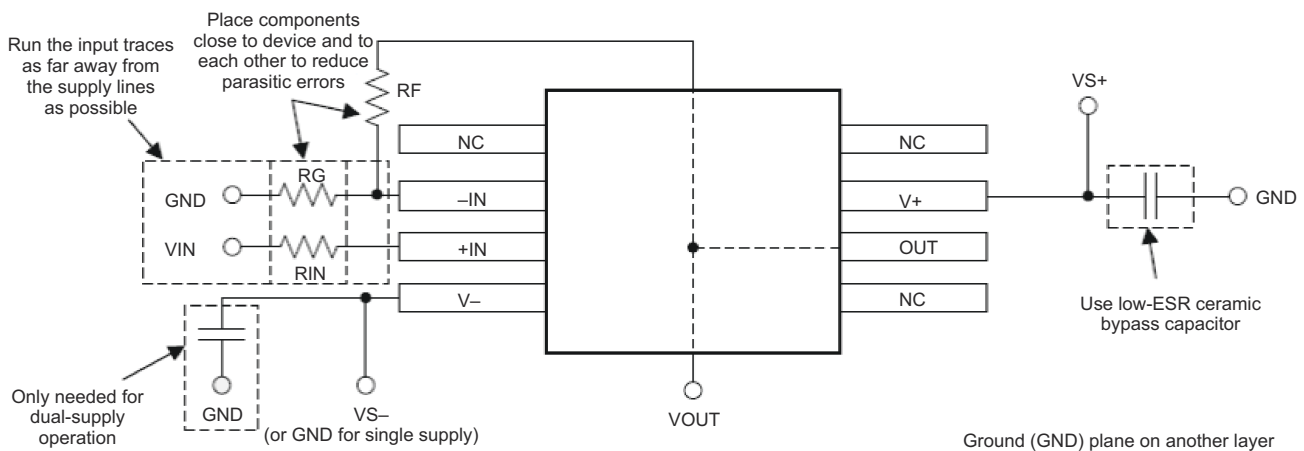

**Figure 8-6. Operational Amplifier Board Layout for Noninverting Configuration**

## 9 Device and Documentation Support

### 9.1 Device Support

#### 9.1.1 Development Support

##### 9.1.1.1 PSpice® for TI

PSpice® for TI is a design and simulation environment that helps evaluate performance of analog circuits. Create subsystem designs and prototype solutions before committing to layout and fabrication, reducing development cost and time to market.

##### 9.1.1.2 TINA-TI™ Simulation Software (Free Download)

TINA-TI™ simulation software is a simple, powerful, and easy-to-use circuit simulation program based on a SPICE engine. TINA-TI simulation software is a free, fully-functional version of the TINA™ software, preloaded with a library of macromodels, in addition to a range of both passive and active models. TINA-TI simulation software provides all the conventional dc, transient, and frequency domain analysis of SPICE, as well as additional design capabilities.

Available as a [free download](#) from the [Design tools and simulation](#) web page, TINA-TI simulation software offers extensive post-processing capability that allows users to format results in a variety of ways. Virtual instruments offer the ability to select input waveforms and probe circuit nodes, voltages, and waveforms, creating a dynamic quick-start tool.

---

#### Note

These files require that either the TINA software or TINA-TI software be installed. Download the free TINA-TI simulation software from the [TINA-TI™ software folder](#).

---

### 9.2 Documentation Support

#### 9.2.1 Related Documentation

For related documentation see the following:

- G.R. Boyle, D.O. Pederson, B.M. Cohn, J.E. Solomon (Dec. 1974). *Macromodeling of Integrated Circuit Operational Amplifiers*. IEEE Journal of Solid-State Circuits, Volume 9, Issue 6, pages 353–364. Retrieved from <https://ieeexplore.ieee.org/document/1050528>

#### 9.3 Receiving Notification of Documentation Updates

To receive notification of documentation updates, navigate to the device product folder on [ti.com](#). Click on *Subscribe to updates* to register and receive a weekly digest of any product information that has changed. For change details, review the revision history included in any revised document.

#### 9.4 Support Resources

[TI E2E™ support forums](#) are an engineer's go-to source for fast, verified answers and design help — straight from the experts. Search existing answers or ask your own question to get the quick design help you need.

Linked content is provided "AS IS" by the respective contributors. They do not constitute TI specifications and do not necessarily reflect TI's views; see TI's [Terms of Use](#).

#### 9.5 Trademarks

LinCMOS™, TINA-TI™, and TI E2E™ are trademarks of Texas Instruments.

TINA™ is a trademark of DesignSoft, Inc.

PSpice® is a registered trademark of Cadence Design Systems, Inc.

All trademarks are the property of their respective owners.

## 9.6 Electrostatic Discharge Caution



This integrated circuit can be damaged by ESD. Texas Instruments recommends that all integrated circuits be handled with appropriate precautions. Failure to observe proper handling and installation procedures can cause damage.

ESD damage can range from subtle performance degradation to complete device failure. Precision integrated circuits may be more susceptible to damage because very small parametric changes could cause the device not to meet its published specifications.

## 9.7 Glossary

[TI Glossary](#) This glossary lists and explains terms, acronyms, and definitions.

## 10 Mechanical, Packaging, and Orderable Information

The following pages include mechanical, packaging, and orderable information. This information is the most current data available for the designated devices. This data is subject to change without notice and revision of this document. For browser-based versions of this data sheet, refer to the left-hand navigation.

**PACKAGING INFORMATION**

Orderable part number	Status (1)	Material type (2)	Package   Pins	Package qty   Carrier	RoHS (3)	Lead finish/ Ball material (4)	MSL rating/ Peak reflow (5)	Op temp (°C)	Part marking (6)
<a href="#">TLC2272AQDRG4Q1</a>	Active	Production	SOIC (D)   8	2500   LARGE T&R	Yes	NIPDAU	Level-1-260C-UNLIM	-40 to 125	2272AQ
TLC2272AQDRG4Q1.Z	Active	Production	SOIC (D)   8	2500   LARGE T&R	Yes	NIPDAU	Level-1-260C-UNLIM	-40 to 125	2272AQ
<a href="#">TLC2272AQDRQ1</a>	Active	Production	SOIC (D)   8	2500   LARGE T&R	Yes	NIPDAU	Level-1-260C-UNLIM	-40 to 125	2272AQ
TLC2272AQDRQ1.Z	Active	Production	SOIC (D)   8	2500   LARGE T&R	Yes	NIPDAU	Level-1-260C-UNLIM	-40 to 125	2272AQ
<a href="#">TLC2272AQPWRG4Q1</a>	Active	Production	TSSOP (PW)   8	2000   LARGE T&R	Yes	NIPDAU	Level-1-260C-UNLIM	-40 to 125	2272AQ
TLC2272AQPWRG4Q1.Z	Active	Production	TSSOP (PW)   8	2000   LARGE T&R	Yes	NIPDAU	Level-1-260C-UNLIM	-40 to 125	2272AQ
<a href="#">TLC2272AQPWRQ1</a>	Active	Production	TSSOP (PW)   8	2000   LARGE T&R	Yes	NIPDAU	Level-1-260C-UNLIM	-40 to 125	2272AQ
TLC2272AQPWRQ1.Z	Active	Production	TSSOP (PW)   8	2000   LARGE T&R	Yes	NIPDAU	Level-1-260C-UNLIM	-40 to 125	2272AQ
<a href="#">TLC2272QDRG4Q1</a>	Active	Production	SOIC (D)   8	2500   LARGE T&R	Yes	NIPDAU	Level-1-260C-UNLIM	-40 to 125	2272Q1
TLC2272QDRG4Q1.Z	Active	Production	SOIC (D)   8	2500   LARGE T&R	Yes	NIPDAU	Level-1-260C-UNLIM	-40 to 125	2272Q1
<a href="#">TLC2272QDRQ1</a>	Active	Production	SOIC (D)   8	2500   LARGE T&R	Yes	NIPDAU	Level-1-260C-UNLIM	-40 to 125	2272Q1
TLC2272QDRQ1.Z	Active	Production	SOIC (D)   8	2500   LARGE T&R	Yes	NIPDAU	Level-1-260C-UNLIM	-40 to 125	2272Q1
<a href="#">TLC2272QPWRG4Q1</a>	Active	Production	TSSOP (PW)   8	2000   LARGE T&R	Yes	NIPDAU	Level-1-260C-UNLIM	-40 to 125	2272Q1
TLC2272QPWRG4Q1.Z	Active	Production	TSSOP (PW)   8	2000   LARGE T&R	Yes	NIPDAU	Level-1-260C-UNLIM	-40 to 125	2272Q1
<a href="#">TLC2272QPWRQ1</a>	Active	Production	TSSOP (PW)   8	2000   LARGE T&R	Yes	NIPDAU	Level-1-260C-UNLIM	-40 to 125	2272Q1
TLC2272QPWRQ1.Z	Active	Production	TSSOP (PW)   8	2000   LARGE T&R	Yes	NIPDAU	Level-1-260C-UNLIM	-40 to 125	2272Q1
<a href="#">TLC2274AQDRG4Q1</a>	Active	Production	SOIC (D)   14	2500   LARGE T&R	Yes	NIPDAU	Level-1-260C-UNLIM	-40 to 125	2274AQ1
TLC2274AQDRG4Q1.Z	Active	Production	SOIC (D)   14	2500   LARGE T&R	Yes	NIPDAU	Level-1-260C-UNLIM	-40 to 125	2274AQ1
<a href="#">TLC2274AQDRQ1</a>	Active	Production	SOIC (D)   14	2500   LARGE T&R	Yes	NIPDAU	Level-1-260C-UNLIM	-40 to 125	2274AQ1
TLC2274AQDRQ1.Z	Active	Production	SOIC (D)   14	2500   LARGE T&R	Yes	NIPDAU	Level-1-260C-UNLIM	-40 to 125	2274AQ1
<a href="#">TLC2274AQPWRG4Q1</a>	Active	Production	TSSOP (PW)   14	2000   LARGE T&R	Yes	NIPDAU	Level-1-260C-UNLIM	-40 to 125	2274AQ1
TLC2274AQPWRG4Q1.Z	Active	Production	TSSOP (PW)   14	2000   LARGE T&R	Yes	NIPDAU	Level-1-260C-UNLIM	-40 to 125	2274AQ1
<a href="#">TLC2274AQPWRQ1</a>	Active	Production	TSSOP (PW)   14	2000   LARGE T&R	Yes	NIPDAU	Level-1-260C-UNLIM	-40 to 125	2274AQ1
TLC2274AQPWRQ1.Z	Active	Production	TSSOP (PW)   14	2000   LARGE T&R	Yes	NIPDAU	Level-1-260C-UNLIM	-40 to 125	2274AQ1
<a href="#">TLC2274QDRG4Q1</a>	Obsolete	Production	SOIC (D)   14	-	-	Call TI	Call TI	-40 to 125	2274Q1
<a href="#">TLC2274QDRQ1</a>	Obsolete	Production	SOIC (D)   14	-	-	Call TI	Call TI	-40 to 125	2274Q1
<a href="#">TLC2274QPWRG4Q1</a>	Obsolete	Production	TSSOP (PW)   14	-	-	Call TI	Call TI	-40 to 125	2274Q1
<a href="#">TLC2274QPWRQ1</a>	Active	Production	TSSOP (PW)   14	2000   LARGE T&R	Yes	NIPDAU	Level-1-260C-UNLIM	-40 to 125	2274Q1
TLC2274QPWRQ1.Z	Active	Production	TSSOP (PW)   14	2000   LARGE T&R	Yes	NIPDAU	Level-1-260C-UNLIM	-40 to 125	2274Q1

(1) **Status:** For more details on status, see our [product life cycle](#).

(2) **Material type:** When designated, preproduction parts are prototypes/experimental devices, and are not yet approved or released for full production. Testing and final process, including without limitation quality assurance, reliability performance testing, and/or process qualification, may not yet be complete, and this item is subject to further changes or possible discontinuation. If available for ordering, purchases will be subject to an additional waiver at checkout, and are intended for early internal evaluation purposes only. These items are sold without warranties of any kind.

(3) **RoHS values:** Yes, No, RoHS Exempt. See the [TI RoHS Statement](#) for additional information and value definition.

(4) **Lead finish/Ball material:** Parts may have multiple material finish options. Finish options are separated by a vertical ruled line. Lead finish/Ball material values may wrap to two lines if the finish value exceeds the maximum column width.

(5) **MSL rating/Peak reflow:** The moisture sensitivity level ratings and peak solder (reflow) temperatures. In the event that a part has multiple moisture sensitivity ratings, only the lowest level per JEDEC standards is shown. Refer to the shipping label for the actual reflow temperature that will be used to mount the part to the printed circuit board.

(6) **Part marking:** There may be an additional marking, which relates to the logo, the lot trace code information, or the environmental category of the part.

Multiple part markings will be inside parentheses. Only one part marking contained in parentheses and separated by a "~" will appear on a part. If a line is indented then it is a continuation of the previous line and the two combined represent the entire part marking for that device.

**Important Information and Disclaimer:** The information provided on this page represents TI's knowledge and belief as of the date that it is provided. TI bases its knowledge and belief on information provided by third parties, and makes no representation or warranty as to the accuracy of such information. Efforts are underway to better integrate information from third parties. TI has taken and continues to take reasonable steps to provide representative and accurate information but may not have conducted destructive testing or chemical analysis on incoming materials and chemicals. TI and TI suppliers consider certain information to be proprietary, and thus CAS numbers and other limited information may not be available for release.

In no event shall TI's liability arising out of such information exceed the total purchase price of the TI part(s) at issue in this document sold by TI to Customer on an annual basis.

**OTHER QUALIFIED VERSIONS OF TLC2272-Q1, TLC2272A-Q1, TLC2274-Q1, TLC2274A-Q1 :**

● Catalog : [TLC2272](#), [TLC2272A](#), [TLC2274](#), [TLC2274A](#)

● Enhanced Product : [TLC2272A-EP](#), [TLC2274-EP](#), [TLC2274A-EP](#)

● Military : [TLC2272M](#), [TLC2272AM](#), [TLC2274AM](#)

NOTE: Qualified Version Definitions:

● Catalog - TI's standard catalog product

- Enhanced Product - Supports Defense, Aerospace and Medical Applications
- Military - QML certified for Military and Defense Applications

**TAPE AND REEL INFORMATION**

**QUADRANT ASSIGNMENTS FOR PIN 1 ORIENTATION IN TAPE**

\*All dimensions are nominal

Device	Package Type	Package Drawing	Pins	SPQ	Reel Diameter (mm)	Reel Width W1 (mm)	A0 (mm)	B0 (mm)	K0 (mm)	P1 (mm)	W (mm)	Pin1 Quadrant
TLC2272AQPWRG4Q1	TSSOP	PW	8	2000	330.0	12.4	7.0	3.6	1.6	8.0	12.0	Q1
TLC2272AQPWRQ1	TSSOP	PW	8	2000	330.0	12.4	7.0	3.6	1.6	8.0	12.0	Q1
TLC2272QPWRG4Q1	TSSOP	PW	8	2000	330.0	12.4	7.0	3.6	1.6	8.0	12.0	Q1
TLC2272QPWRQ1	TSSOP	PW	8	2000	330.0	12.4	7.0	3.6	1.6	8.0	12.0	Q1
TLC2274AQPWRG4Q1	TSSOP	PW	14	2000	330.0	12.4	6.9	5.6	1.6	8.0	12.0	Q1
TLC2274AQPWRQ1	TSSOP	PW	14	2000	330.0	12.4	6.9	5.6	1.6	8.0	12.0	Q1
TLC2274QPWRQ1	TSSOP	PW	14	2000	330.0	12.4	6.9	5.6	1.6	8.0	12.0	Q1



**TAPE AND REEL BOX DIMENSIONS**

\*All dimensions are nominal

Device	Package Type	Package Drawing	Pins	SPQ	Length (mm)	Width (mm)	Height (mm)
TLC2272AQPWRG4Q1	TSSOP	PW	8	2000	356.0	356.0	35.0
TLC2272AQPWRQ1	TSSOP	PW	8	2000	356.0	356.0	35.0
TLC2272QPWRG4Q1	TSSOP	PW	8	2000	356.0	356.0	35.0
TLC2272QPWRQ1	TSSOP	PW	8	2000	356.0	356.0	35.0
TLC2274AQPWRG4Q1	TSSOP	PW	14	2000	356.0	356.0	35.0
TLC2274AQPWRQ1	TSSOP	PW	14	2000	356.0	356.0	35.0
TLC2274QPWRQ1	TSSOP	PW	14	2000	356.0	356.0	35.0



# D0014A

# PACKAGE OUTLINE

## SOIC - 1.75 mm max height

SMALL OUTLINE INTEGRATED CIRCUIT



4220718/A 09/2016

### NOTES:

1. All linear dimensions are in millimeters. Dimensions in parenthesis are for reference only. Dimensioning and tolerancing per ASME Y14.5M.
2. This drawing is subject to change without notice.
3. This dimension does not include mold flash, protrusions, or gate burrs. Mold flash, protrusions, or gate burrs shall not exceed 0.15 mm, per side.
4. This dimension does not include interlead flash. Interlead flash shall not exceed 0.43 mm, per side.
5. Reference JEDEC registration MS-012, variation AB.

# EXAMPLE BOARD LAYOUT

D0014A

SOIC - 1.75 mm max height

SMALL OUTLINE INTEGRATED CIRCUIT



LAND PATTERN EXAMPLE  
SCALE:8X



SOLDER MASK DETAILS

4220718/A 09/2016

NOTES: (continued)

- 6. Publication IPC-7351 may have alternate designs.
- 7. Solder mask tolerances between and around signal pads can vary based on board fabrication site.

# EXAMPLE STENCIL DESIGN

D0014A

SOIC - 1.75 mm max height

SMALL OUTLINE INTEGRATED CIRCUIT



SOLDER PASTE EXAMPLE  
BASED ON 0.125 mm THICK STENCIL  
SCALE:8X

4220718/A 09/2016

NOTES: (continued)

8. Laser cutting apertures with trapezoidal walls and rounded corners may offer better paste release. IPC-7525 may have alternate design recommendations.
9. Board assembly site may have different recommendations for stencil design.



D0008A

# PACKAGE OUTLINE

SOIC - 1.75 mm max height

SMALL OUTLINE INTEGRATED CIRCUIT



4214825/C 02/2019

NOTES:

1. Linear dimensions are in inches [millimeters]. Dimensions in parenthesis are for reference only. Controlling dimensions are in inches. Dimensioning and tolerancing per ASME Y14.5M.
2. This drawing is subject to change without notice.
3. This dimension does not include mold flash, protrusions, or gate burrs. Mold flash, protrusions, or gate burrs shall not exceed .006 [0.15] per side.
4. This dimension does not include interlead flash.
5. Reference JEDEC registration MS-012, variation AA.

# EXAMPLE BOARD LAYOUT

D0008A

SOIC - 1.75 mm max height

SMALL OUTLINE INTEGRATED CIRCUIT



LAND PATTERN EXAMPLE  
 EXPOSED METAL SHOWN  
 SCALE:8X



SOLDER MASK DETAILS

4214825/C 02/2019

NOTES: (continued)

- 6. Publication IPC-7351 may have alternate designs.
- 7. Solder mask tolerances between and around signal pads can vary based on board fabrication site.

# EXAMPLE STENCIL DESIGN

D0008A

SOIC - 1.75 mm max height

SMALL OUTLINE INTEGRATED CIRCUIT



SOLDER PASTE EXAMPLE  
BASED ON .005 INCH [0.125 MM] THICK STENCIL  
SCALE:8X

4214825/C 02/2019

NOTES: (continued)

8. Laser cutting apertures with trapezoidal walls and rounded corners may offer better paste release. IPC-7525 may have alternate design recommendations.
9. Board assembly site may have different recommendations for stencil design.

PW0014A



**PACKAGE OUTLINE**  
**TSSOP - 1.2 mm max height**

SMALL OUTLINE PACKAGE



4220202/B 12/2023

NOTES:

1. All linear dimensions are in millimeters. Any dimensions in parenthesis are for reference only. Dimensioning and tolerancing per ASME Y14.5M.
2. This drawing is subject to change without notice.
3. This dimension does not include mold flash, protrusions, or gate burrs. Mold flash, protrusions, or gate burrs shall not exceed 0.15 mm per side.
4. This dimension does not include interlead flash. Interlead flash shall not exceed 0.25 mm per side.
5. Reference JEDEC registration MO-153.



# EXAMPLE BOARD LAYOUT

PW0014A

TSSOP - 1.2 mm max height

SMALL OUTLINE PACKAGE



LAND PATTERN EXAMPLE  
EXPOSED METAL SHOWN  
SCALE: 10X



4220202/B 12/2023

NOTES: (continued)

- 6. Publication IPC-7351 may have alternate designs.
- 7. Solder mask tolerances between and around signal pads can vary based on board fabrication site.

# EXAMPLE STENCIL DESIGN

PW0014A

TSSOP - 1.2 mm max height

SMALL OUTLINE PACKAGE



SOLDER PASTE EXAMPLE  
BASED ON 0.125 mm THICK STENCIL  
SCALE: 10X

4220202/B 12/2023

NOTES: (continued)

8. Laser cutting apertures with trapezoidal walls and rounded corners may offer better paste release. IPC-7525 may have alternate design recommendations.
9. Board assembly site may have different recommendations for stencil design.

PW0008A



PACKAGE OUTLINE

TSSOP - 1.2 mm max height

SMALL OUTLINE PACKAGE

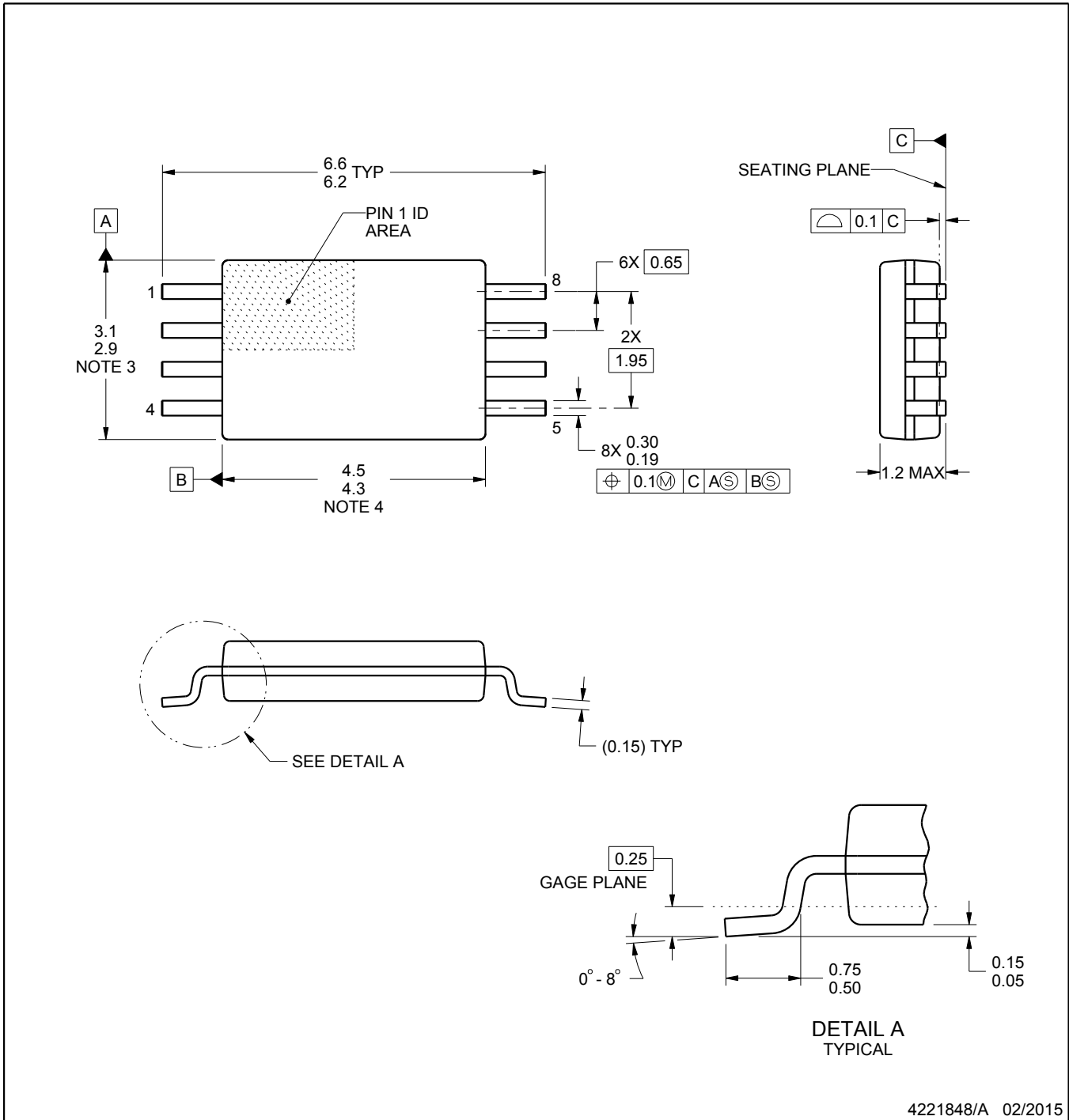

4221848/A 02/2015

NOTES:

1. All linear dimensions are in millimeters. Any dimensions in parenthesis are for reference only. Dimensioning and tolerancing per ASME Y14.5M.
2. This drawing is subject to change without notice.
3. This dimension does not include mold flash, protrusions, or gate burrs. Mold flash, protrusions, or gate burrs shall not exceed 0.15 mm per side.
4. This dimension does not include interlead flash. Interlead flash shall not exceed 0.25 mm per side.
5. Reference JEDEC registration MO-153, variation AA.

# EXAMPLE BOARD LAYOUT

PW0008A

TSSOP - 1.2 mm max height

SMALL OUTLINE PACKAGE



LAND PATTERN EXAMPLE  
SCALE:10X



SOLDER MASK DETAILS  
NOT TO SCALE

4221848/A 02/2015

NOTES: (continued)

- 6. Publication IPC-7351 may have alternate designs.
- 7. Solder mask tolerances between and around signal pads can vary based on board fabrication site.

# EXAMPLE STENCIL DESIGN

PW0008A

TSSOP - 1.2 mm max height

SMALL OUTLINE PACKAGE



SOLDER PASTE EXAMPLE  
BASED ON 0.125 mm THICK STENCIL  
SCALE:10X

4221848/A 02/2015

NOTES: (continued)

8. Laser cutting apertures with trapezoidal walls and rounded corners may offer better paste release. IPC-7525 may have alternate design recommendations.
9. Board assembly site may have different recommendations for stencil design.

## IMPORTANT NOTICE AND DISCLAIMER

TI PROVIDES TECHNICAL AND RELIABILITY DATA (INCLUDING DATA SHEETS), DESIGN RESOURCES (INCLUDING REFERENCE DESIGNS), APPLICATION OR OTHER DESIGN ADVICE, WEB TOOLS, SAFETY INFORMATION, AND OTHER RESOURCES "AS IS" AND WITH ALL FAULTS, AND DISCLAIMS ALL WARRANTIES, EXPRESS AND IMPLIED, INCLUDING WITHOUT LIMITATION ANY IMPLIED WARRANTIES OF MERCHANTABILITY, FITNESS FOR A PARTICULAR PURPOSE OR NON-INFRINGEMENT OF THIRD PARTY INTELLECTUAL PROPERTY RIGHTS.

These resources are intended for skilled developers designing with TI products. You are solely responsible for (1) selecting the appropriate TI products for your application, (2) designing, validating and testing your application, and (3) ensuring your application meets applicable standards, and any other safety, security, regulatory or other requirements.

These resources are subject to change without notice. TI grants you permission to use these resources only for development of an application that uses the TI products described in the resource. Other reproduction and display of these resources is prohibited. No license is granted to any other TI intellectual property right or to any third party intellectual property right. TI disclaims responsibility for, and you will fully indemnify TI and its representatives against, any claims, damages, costs, losses, and liabilities arising out of your use of these resources.

TI's products are provided subject to [TI's Terms of Sale](#) or other applicable terms available either on [ti.com](https://www.ti.com) or provided in conjunction with such TI products. TI's provision of these resources does not expand or otherwise alter TI's applicable warranties or warranty disclaimers for TI products.

TI objects to and rejects any additional or different terms you may have proposed.

Mailing Address: Texas Instruments, Post Office Box 655303, Dallas, Texas 75265

Copyright © 2025, Texas Instruments Incorporated