

# TLC2933A HIGH PERFORMANCE PHASE LOCKED LOOP

SLES149 – OCTOBER 2005

- **VCO (Voltage-Controlled Oscillator):**
  - Complete Oscillator Using Only One External Bias Resistor (RBIAS)
  - Lock Frequency:
    - 30 MHz to 55 MHz (VDD = 3 V ±5%,  
T<sub>A</sub> = –20°C to 75°C, x1 Output)
    - 30 MHz to 60 MHz (VDD = 3.3 V ±5%,  
T<sub>A</sub> = –20°C to 75°C, x1 Output)
    - 43 MHz to 110 MHz (VDD = 5 V ±5%,  
T<sub>A</sub> = –20°C to 75°C, x1 Output)
  - Selectable Output Frequency
- **PFD (Phase Frequency Detector):**  
High Speed, Edge-Triggered Detector with Internal Charge Pump

- Independent VCO, PFD Power-Down Mode
- Thin Small-Outline Package (14 Terminal)
- CMOS Technology
- Pin Compatible TLC2933IPW

14-PIN TSOP (PW PACKAGE)  
(TOP VIEW)

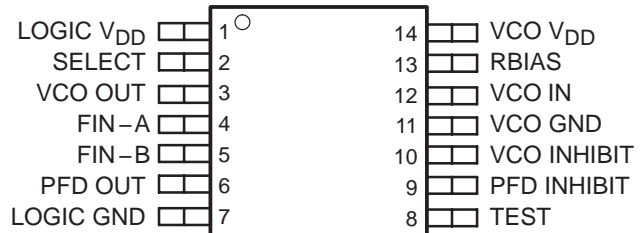

## description

The TLC2933A is designed for phase-locked loop (PLL) systems and is composed of a voltage-controlled oscillator (VCO) and an edge-triggered type phase frequency detector (PFD). The oscillation frequency range of the VCO is set by an external bias resistor (R<sub>BIA</sub>S). The VCO has a 1/2 frequency divider at the output stage. The high speed PFD with internal charge pump detects the phase difference between the reference frequency input and signal frequency input from the external counter. Both the VCO and the PFD have inhibit functions, which can be used as power-down mode. Due to the TLC2933A high speed and stable oscillation capability, the TLC2933A is suitable for use as a high-performance PLL.

AVAILABLE OPTIONS

T <sub>A</sub>	PACKAGE
	SMALL OUTLINE (PW)
–20°C to 75°C	TLC2933AIPW



Please be aware that an important notice concerning availability, standard warranty, and use in critical applications of Texas Instruments semiconductor products and disclaimers thereto appears at the end of this data sheet.

PRODUCT PREVIEW information concerns products in the formative or design phase of development. Characteristic data and other specifications are design goals. Texas Instruments reserves the right to change or discontinue these products without notice.

 **TEXAS  
INSTRUMENTS**  
TI.COM

Copyright © 2005, Texas Instruments Incorporated

# TLC2933A HIGH PERFORMANCE PHASE LOCKED LOOP

SLES149 – OCTOBER 2005

## functional block diagram

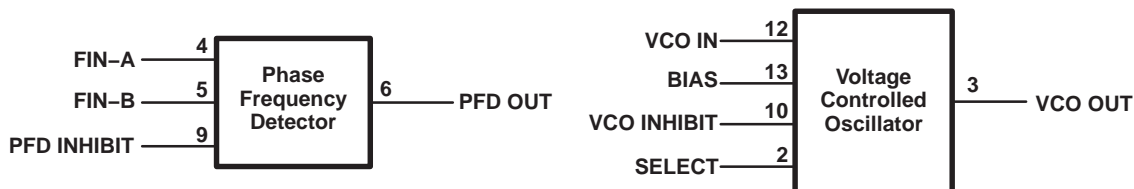

## Terminal Functions

TERMINAL NAME	NO.	I/O	DESCRIPTION
LOGIC VDD	1		Power supply for the internal logic. This power supply should be separated from VCO V <sub>DD</sub> to reduce cross-coupling between supplies.
SELECT	2	I	VCO output frequency select. When SELECT is high, the VCO output frequency is $\times 1/2$ and when low. The output frequency is $\times 1$ .
VCO OUT	3	O	VCO output. When the VCO INHIBIT is high, VCO output is low.
FIN-A	4	I	Input reference frequency $f_{(REF IN)}$ is applied to FIN-A.
FIN-B	5	I	Input for VCO external counter output frequency $f_{(FIN-B)}$ . FIN-B is nominally provided from the external counter.
PFD OUT	6	O	PFD output. When the PFD INHIBIT is high, PFD output is in the high-impedance state.
LOGIC GND	7		GND for the internal logic.
TEST	8		Connect to GND.
PFD INHIBIT	9	I	PFD inhibit control. When PFD INHIBIT is high, PFD output is in the high-impedance state.
VCO INHIBIT	10	I	VCO inhibit control. When VCO INHIBIT is high, VCO output is low.
VCO GND	11		GND for VCO.
VCO IN	12	I	VCO control voltage input. Nominally the external loop filter output connects to VCO IN to control VCO oscillation frequency.
RBIAS	13	I	Bias supply. An external resistor (R <sub>BIAS</sub> ) between VCO V <sub>DD</sub> and R <sub>BIAS</sub> supplies bias for adjusting the oscillation frequency range.
VCO V <sub>DD</sub>	14		Power supply for VCO. This power supply should be separated from LOGIC V <sub>DD</sub> to reduce cross-coupling between supplies.

**detailed description**

**VCO oscillation frequency**

The VCO oscillation frequency is determined by an external resistor ( $R_{BIAS}$ ) connected between the VCO  $V_{DD}$  and the BIAS terminals. The oscillation frequency and range depends on this Resistor value. For the lock frequency range, refer to the recommended operating conditions. Figure 1 shows the typical frequency variation and VCO control voltage.

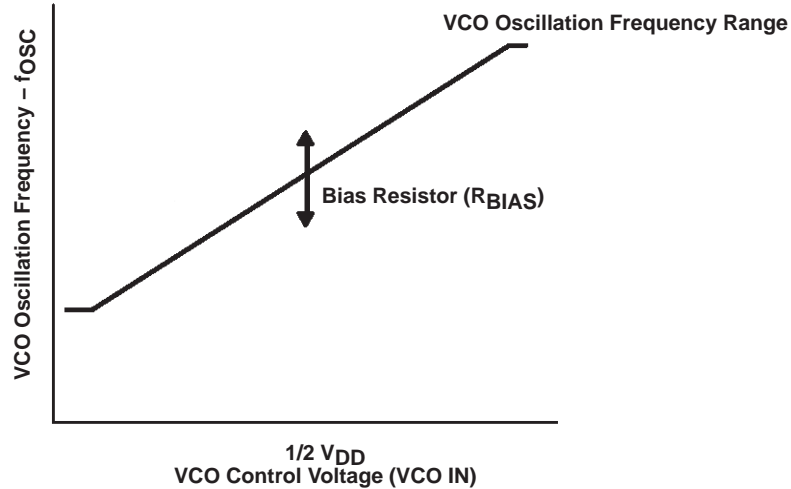

**Figure 1. Oscillation Frequency**

**VCO output frequency 1/2 divider**

The TLC2933A SELECT terminal sets the  $f_{OSC}$  VCO output frequency as shown in Table 1. The  $1/2 f_{OSC}$  output should be used for minimum VCO output jitter.

**Table 1. VCO Output 1/2 Divider Function**

SELECT	VCO OUTPUT
Low	$f_{OSC}$
High	$1/2 f_{OSC}$

**VCO inhibit function**

The VCO has an externally controlled inhibit function which inhibit the VCO output. A high level on the VCO INHIBIT terminal stops the VCO oscillation and powers down the VCO. The output maintains a low level during the power-down mode as shown in Table 2.

**Table 2. VCO Inhibit Function**

VCO INHIBIT	VCO OSCILLATOR	VCO OUT	$I_{DD}(VCO)$
Low	Active	Active	Normal
High	Stopped	Low level	Power Down

**PFD operation**

The PFD is a high-speed, edge-triggered detector with an internal charge pump. The PFD detects the phase difference between two frequency inputs supplied to FIN-A and FIN-B as shown in Figure 2. Normally the reference is supplied to FIN-A and the frequency from the external counter output is fed to FIN-B. For clock recovery PLL system, other types of phase detectors should be used.

# TLC2933A HIGH PERFORMANCE PHASE LOCKED LOOP

SLES149 – OCTOBER 2005

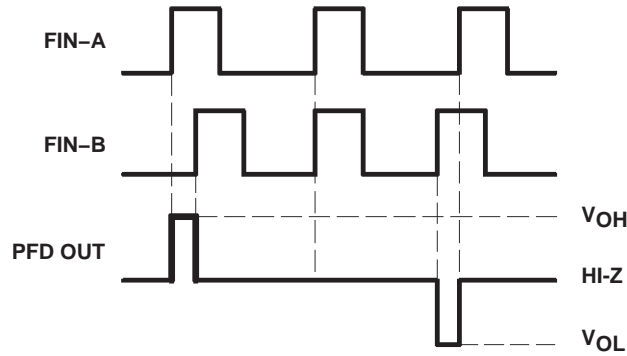

Figure 2. PFD Function Timing Chart

## PFD inhibit control

A high level on the PFD INHIBIT terminal places PFD OUT in the high-impedance state and the PFD stops phase detection as shown in Table 3. A high level on the PFD INHIBIT terminal can also be used as the power-down mode for the PFD.

Table 3. VCO Output Control Function

PFD INHIBIT	DETECTION	PFD OUT	I <sub>DD</sub> (PFD)
Low	Active	Active	Normal
High	Stopped	Hi-Z	Power Down

## VCO block schematic

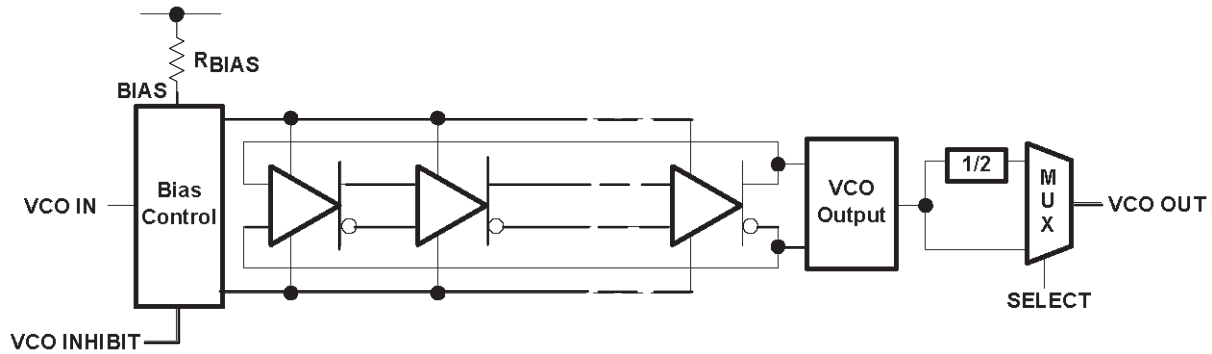

## PFD block schematic

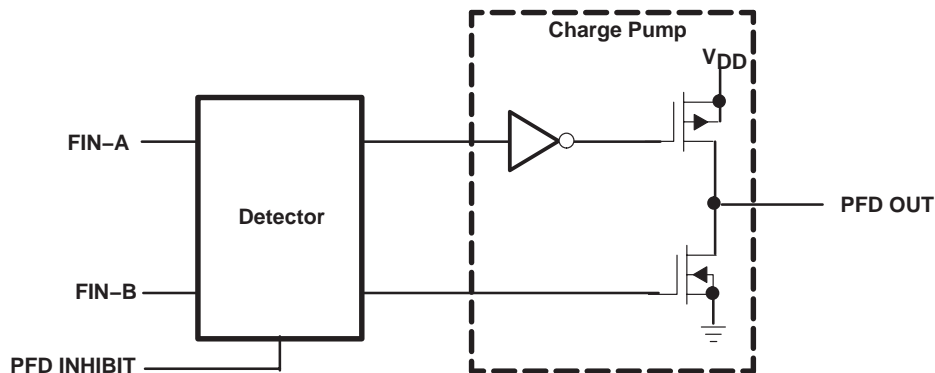

**absolute maximum ratings over operating free-air temperature range (unless otherwise noted)†**

Supply voltage (each supply), $V_{DD}$ (see Note 1) .....	7 V
Input voltage range (each input), $V_{IN}$ (see Note 1) .....	-0.5 V to $V_{DD} + 0.5$ V
Input current (each input), $I_{IN}$ .....	$\pm 20$ mA
Output current (each output), $I_O$ .....	$\pm 20$ mA
Operating free-air temperature range, $T_A$ .....	-20°C to 75°C
Storage temperature range, $T_{Stg}$ .....	-65°C to 150°C

† Stresses beyond those listed under “absolute maximum ratings” may cause permanent damage to the device. These are stress ratings only, and functional operation of the device at these or any other conditions beyond those indicated under “recommended operating conditions” is not implied. Exposure to absolute-maximum-rated conditions for extended periods may affect device reliability.

- NOTES: 1. All voltages are with respect to GND.  
2. For operation above 25°C free-air temperature, derate linearly at the rate of 5.6 mW/°C.

**recommended operating conditions**

PARAMETERS		MIN	TYP	MAX	UNIT
Supply voltage (each supply, see Note 3)	$V_{DD} = 3$ V	2.85	3	3.15	V
	$V_{DD} = 3.3$ V	3.135	3.3	3.465	
	$V_{DD} = 5$ V	4.75	5	5.25	
Input voltage, (inputs except VCO IN)		0		$V_{DD}$	V
Output current, (each output)		0		$\pm 2$	mA
VCO control voltage at VCO IN		0.9		$V_{DD}$	V
Lock frequency	$V_{DD} = 3$ V	30		55	MHz
	$V_{DD} = 3.3$ V	30		60	
	$V_{DD} = 5$ V	43		110	
Bias resistor	$V_{DD} = 3$ V	2.2		5.1	k $\Omega$
	$V_{DD} = 3.3$ V	2.2		5.1	
	$V_{DD} = 5$ V	2.2		5.1	

NOTE 3: It is recommended that the logic supply terminal (LOGIC  $V_{DD}$ ) and the VCO supply terminal (VCO  $V_{DD}$ ) should be at the same voltage and separated from each other.

**electrical characteristics,  $V_{DD} = 3$  V,  $T_A = 25^\circ\text{C}$  (unless otherwise noted)**

**VCO section**

PARAMETER	TEST CONDITIONS	MIN	TYP	MAX	UNIT	
$V_{OH}$	High level output voltage	$I_{OH} = -2$ mA	2.4		V	
$V_{OL}$	Low level output voltage	$I_{OL} = 2$ mA		0.3	V	
$V_{TH}$	Input threshold voltage at select, VCO inhibit		0.9	1.5	2.1	V
$I_I$	Input current at Select, VCO inhibit	$V_I = V_{DD}$ or GND			$\pm 1$	$\mu\text{A}$
$Z_I(\text{VCON})$	VCO IN input impedance	VCO IN = 1/2 $V_{DD}$		10		M $\Omega$
$I_{DD}(\text{INH})$	VCO supply current (inhibit)	See Note 4	0.41	1		$\mu\text{A}$
$I_{DD}(\text{VCO})$	VCO supply current	See Note 5	11.7	23		mA

- NOTES: 4. Current into VCO  $V_{DD}$ , when VCO INHIBIT = high, PFD is inhibited.  
5. Current into VCO  $V_{DD}$ , when VCO IN = 1/2  $V_{DD}$ ,  $R_{BIAS} = 3.3$  k $\Omega$ , VCOOUT = 15-pF Load, VCO INHIBIT = GND, and PFD INHIBIT = GND.

# TLC2933A

## HIGH PERFORMANCE PHASE LOCKED LOOP

SLES149 – OCTOBER 2005

electrical characteristics,  $V_{DD} = 3\text{ V}$ ,  $T_A = 25^\circ\text{C}$  (unless otherwise noted) (continued)

### PFD section

PARAMETER	TEST CONDITIONS	MIN	TYP	MAX	UNIT
$V_{OH}$	High level output voltage	$I_{OH} = -2\text{ mA}$		2.4	V
$V_{OL}$	Low level output voltage	$I_{OL} = 2\text{ mA}$		0.3	V
$I_{OZ}$	High impedance state output current	PFD inhibit = high, $V_O = V_{DD}$ or GND		$\pm 1$	$\mu\text{A}$
$V_{IH}$	High level input voltage at Fin-A, Fin-B			2.1	V
$V_{IL}$	Low level input voltage at Fin-A, Fin-B			0.5	V
$V_{TH}$	Input threshold voltage at PFD inhibit	0.9	1.5	2.1	
$C_{IN}$	Input capacitance at Fin-A, Fin-B			5.6	pF
$Z_{IN}$	Input impedance at Fin-A, Fin-B			10	$M\Omega$
$I_{DD}(Z)$	High impedance state PFD supply current	See Note 6		1	$\mu\text{A}$
$I_{DD}(\text{PFD})$	PFD supply current	See Note 7		3	mA

NOTES: 6. The current into LOGIC  $V_{DD}$  when FIN-A and FIN-B = ground, PFD INHIBIT =  $V_{DD}$ , PFD OUT open, and VCO OUT is inhibited.  
7. The current into LOGIC  $V_{DD}$  when FIN-A = 1 MHz and FIN-B = 1 MHz ( $V_{I(PP)} = 3\text{ V}$ , rectangular wave), PFD INHIBIT = GND, PFD OUT open, and VCO OUT is inhibited.

operation characteristics,  $V_{DD} = 3\text{ V}$ ,  $T_A = 25^\circ\text{C}$  (unless otherwise noted)

### VCO section

Parameter	TEST CONDITIONS	MIN	TYP	MAX	UNIT		
$f_{OSC}$	Operation oscillation frequency	$R_{BIAS} = 3.3\text{ k}\Omega$ , VCO IN = $1/2 V_{DD}$		32	47	63	MHz
$t_{STB}$	Time to stable oscillation (see Note 8)					10	$\mu\text{s}$
$t_r$	Rise time	$C_L = 15\text{ pF}$			8.6	14	ns
$t_f$	Fall time	$C_L = 15\text{ pF}$			7.1	12	ns
	Duty cycle at VCO OUT	$R_{BIAS} = 3.3\text{ k}\Omega$ , VCO IN = $1/2 V_{DD}$		45%	50%	55%	
$\alpha (f_{OSC})$	Temperature coefficient of oscillation frequency	VCO IN = $1/2 V_{DD}$ , $T_A = -20^\circ\text{C}$ to $75^\circ\text{C}$			-0.21		$\%/^\circ\text{C}$
$k_{SVS}$ (fosc)	Supply voltage coefficient of oscillation frequency	VCO IN = $1/2 V_{DD}$ , $V_{DD} = 4.75\text{ V}$ to $5.25\text{ V}$			0.002		$\%/mV$
	Jitter absolute (see Note 9)	PLL jitter, N = 128			262		ps

NOTES: 8. The time period to the stable VCO oscillation frequency after the VCO INHIBIT terminal is changed to a low level.  
9. Jitter performance is highly dependent on circuit layout and external device characteristics. The jitter specification was made with a carefully designed PCB with no device socket.

### PFD section

PARAMETER	TEST CONDITIONS	MIN	TYP	MAX	UNIT		
$f_{max}$	Maximum operation frequency			32	MH		
$t_{PLZ}$	PFD output disable time from low level			22	50	ns	
$t_{PHZ}$	PFD output disable time from high level			21	50	ns	
$t_{PZL}$	PFD output enable time to low level			6.5	30	ns	
$t_{PZH}$	PFD output enable time to high level			7	30	ns	
$t_r$	Rise time	$C_L = 15\text{ pF}$			3.4	10	ns
$t_f$	Fall time	$C_L = 15\text{ pF}$			1.9	10	ns

**electrical characteristics,  $V_{DD} = 3.3\text{ V}$ ,  $T_A = 25^\circ\text{C}$  (unless otherwise noted)**

**VCO section**

	PARAMETER	TEST CONDITIONS	MIN	TYP	MAX	UNIT
$V_{OH}$	High level output voltage	$I_{OH} = -2\text{ mA}$	2.64			V
$V_{OL}$	Low level output voltage	$I_{OL} = 2\text{ mA}$			0.33	V
$V_{TH}$	Input threshold voltage at select, VCO inhibit		1.05	1.65	2.25	V
$I_I$	Input current at Select, VCO inhibit	$V_I = V_{DD}$ or GND			$\pm 1$	$\mu\text{A}$
$Z_I(\text{VCON})$	VCO IN input impedance	VCO IN = $1/2 V_{DD}$		10		$\text{M}\Omega$
$I_{DD}(\text{INH})$	VCO supply current (inhibit)	See Note 10		0.44	1	$\mu\text{A}$
$I_{DD}(\text{VCO})$	VCO supply current	See Note 11		14.7	28	mA

NOTES: 10. Current into VCO  $V_{DD}$ , when VCO INHIBIT = high, PFD is inhibited.

11. Current into VCO  $V_{DD}$ , when VCO IN =  $1/2 V_{DD}$ ,  $R_{BIAS} = 3.3\text{ k}\Omega$ , VCOOUT = 15-pF Load, VCO INHIBIT = GND, and PFD INHIBIT = GND.

**PFD section**

	PARAMETER	TEST CONDITIONS	MIN	TYP	MAX	UNIT
$V_{OH}$	High level output voltage	$I_{OH} = -2\text{ mA}$	2.97			V
$V_{OL}$	Low level output voltage	$I_{OL} = 2\text{ mA}$			0.2	V
$I_{OZ}$	High impedance state output current	PFD inhibit = high, $V_O = V_{DD}$ or GND			$\pm 1$	$\mu\text{A}$
$V_{IH}$	High level input voltage at Fin-A, Fin-B		2.1			V
$V_{IL}$	Low level input voltage at Fin-A, Fin-B				0.5	V
$V_{TH}$	Input threshold voltage at PFD inhibit		1.05	1.65	2.25	
$C_{IN}$	Input capacitance at Fin-A, Fin-B			5.6		pF
$Z_{IN}$	Input impedance at Fin-A, Fin-B			10		$\text{M}\Omega$
$I_{DD}(Z)$	High impedance state PFD supply current	See Note 12			1	$\mu\text{A}$
$I_{DD}(\text{PFD})$	PFD supply current	See Note 13			3	mA

NOTES: 12. The current into LOGIC  $V_{DD}$  when FIN-A and FIN-B = ground, PFD INHIBIT =  $V_{DD}$ , PFD OUT open, and VCO OUT is inhibited.

13. The current into LOGIC  $V_{DD}$  when FIN-A = 1 MHz and FIN-B = 1 MHz ( $V_{I(\text{PP})} = 3.3\text{ V}$ , rectangular wave), PFD INHIBIT = GND, PFD OUT open, and VCO OUT is inhibited.

**operation characteristics,  $V_{DD} = 3.3\text{ V}$ ,  $T_A = 25^\circ\text{C}$  (unless otherwise noted)**

**VCO section**

	PARAMETER	TEST CONDITIONS	MIN	TYP	MAX	UNIT
$f_{\text{OSC}}$	Operation oscillation frequency	$R_{BIAS} = 3.3\text{ k}\Omega$ , VCO IN = $1/2 V_{DD}$	35	55	80	MHz
$t_{\text{stb}}$	Time to stable oscillation (see Note 14)				10	$\mu\text{s}$
$t_r$	Rise time	$C_L = 15\text{ pF}$		8.3	14	ns
$t_f$	Fall time	$C_L = 15\text{ pF}$		6.7	12	ns
$f_{\text{DUTY}}$	Duty cycle at VCO OUT	$R_{BIAS} = 3.3\text{ k}\Omega$ , VCO IN = $1/2 V_{DD}$	45%	50%	55%	
$\alpha(f_{\text{OSC}})$	Temperature coefficient of oscillation frequency	VCO IN = $1/2 V_{DD}$ , $T_A = -20^\circ\text{C}$ to $75^\circ\text{C}$		-0.232		$\%/^\circ\text{C}$
$k_{\text{SVS}}(f_{\text{OSC}})$	Supply voltage coefficient of oscillation frequency	VCO IN = $1/2 V_{DD}$ , $V_{DD} = 4.75\text{ V}$ to $5.25\text{ V}$		0.002		$\%/m\text{V}$
	Jitter absolute (see Note 15)	PLL jitter, N = 128		211		ps

NOTES: 14. The time period to the stable VCO oscillation frequency after the VCO INHIBIT terminal is changed to a low level.

15. Jitter performance is highly dependent on circuit layout and external device characteristics. The jitter specification was made with a carefully deigned PCB with no device socket.

# TLC2933A

## HIGH PERFORMANCE PHASE LOCKED LOOP

SLES149 – OCTOBER 2005

operation characteristics,  $V_{DD} = 3.3\text{ V}$ ,  $T_A = 25^\circ\text{C}$  (unless otherwise noted) (continued)

### PFD section

PARAMETER	TEST CONDITIONS	MIN	TYP	MAX	UNIT
$f_{max}$	Maximum operation frequency	40			MHz
$t_{PLZ}$	PFD output disable time from low level		21	50	ns
$t_{PHZ}$	PFD output disable time from high level		21	50	ns
$t_{PZL}$	PFD output enable time to low level		5.8	30	ns
$t_{PZH}$	PFD output enable time to high level		6.2	30	ns
$t_r$	Rise time	$C_L = 15\text{ pF}$	3	10	ns
$t_f$	Fall time	$C_L = 15\text{ pF}$	1.7	10	ns

electrical characteristics,  $V_{DD} = 5\text{ V}$ ,  $T_A = 25^\circ\text{C}$  (unless otherwise noted)

### VCO section

PARAMETER	TEST CONDITIONS	MIN	TYP	MAX	UNIT	
$V_{OH}$	High level output voltage	$I_{OH} = -2\text{ mA}$	4		V	
$V_{OL}$	Low level output voltage	$I_{OL} = 2\text{ mA}$		0.5	V	
$V_{TH}$	Input threshold voltage at select, VCO inhibit		1.5	2.5	3.5	V
$I_I$	Input current at select, VCO inhibit	$V_I = V_{DD}$ or GND		$\pm 1$	$\mu\text{A}$	
$Z_I(\text{VCOIN})$	VCO IN input impedance	$V_{CO\ IN} = 1/2 V_{DD}$	10		M( $\Omega$ )	
$I_{DD}(\text{inh})$	VCO supply current (inhibit)	See Note 16	0.61	1	$\mu\text{A}$	
$I_{DD}(\text{vco})$	VCO supply current	See Note 17	35.5	55	mA	

NOTES: 16. Current into VCO  $V_{DD}$ , when VCO INHIBIT = high, PFD is inhibited.

17. Current into VCO  $V_{DD}$ , when VCO IN =  $1/2 V_{DD}$ ,  $R_{BIAS} = 3.3\text{ k}\Omega$ ,  $V_{COOUT} = 15\text{-pF Load}$ , VCO INHIBIT = GND, and PFD INHIBIT = GND.

### PFD section

PARAMETER	TEST CONDITIONS	MIN	TYP	MAX	UNIT	
$V_{OH}$	High level output voltage	$I_{OH} = -2\text{ mA}$	4.5		V	
$V_{OL}$	Low level output voltage	$I_{OL} = 2\text{ mA}$		0.2	V	
$I_{OZ}$	High impedance state output current	PFD inhibit = high, $V_O = V_{DD}$ or GND		$\pm 1$	$\mu\text{A}$	
$V_{IH}$	High level input voltage at Fin-A, Fin-B		4.5		V	
$V_{IL}$	Low level input voltage at Fin-A, Fin-B			1	V	
$V_{TH}$	Input threshold voltage at PFD inhibit		1.5	2.5	3.5	V
$C_{IN}$	Input capacitance at Fin-A, Fin-B		5.6		pF	
$Z_{IN}$	Input impedance at Fin-A, Fin-B		10		$M\Omega$	
$I_{DD}(Z)$	High impedance state PFD supply current	See Note 18		1	$\mu\text{A}$	
$I_{DD}(\text{PFD})$	PFD supply current	See Note 19	0.48	3	mA	

NOTES: 18. The current into LOGIC  $V_{DD}$  when FIN-A and FIN-B = ground, PFD INHIBIT =  $V_{DD}$ , PFD OUT open, and VCO OUT is inhibited.

19. The current into LOGIC  $V_{DD}$  when FIN-A = 1 MHz and FIN-B = 1 MHz ( $V_{I(PP)} = 5\text{ V}$ , rectangular wave), PFD INHIBIT = GND, PFD OUT open, and VCO OUT is inhibited



operation characteristics,  $V_{DD} = 5\text{ V}$ ,  $T_A = 25^\circ\text{C}$  (unless otherwise noted)

**VCO section**

PARAMETER		TEST CONDITIONS	MIN	TYP	MAX	UNIT
$f_{OSC}$	Operation oscillation frequency	$R_{BIAS} = 3.3\text{ k}\Omega$ , $V_{CO\ IN} = 1/2 V_{DD}$	70	99	130	MHz
$f_{STB}$	Time to stable oscillation (see Note 20)				10	us
$t_r$	Rise time	$C_L = 15\text{ pF}$		5.4	10	ns
$t_f$	Fall time	$C_L = 15\text{ pF}$		5	10	ns
$f_{DUTY}$	Duty cycle at VCO OUT	$R_{BIAS} = 3.3\text{ k}\Omega$ , $V_{CO\ IN} = 1/2 V_{DD}$	45%	50%	55%	
$\alpha (f_{OSC})$	Temperature coefficient of oscillation frequency	$V_{CO\ IN} = 1/2 V_{DD}$ , $T_A = -20^\circ\text{C}$ to $75^\circ\text{C}$		-0.309		%/ $^\circ\text{C}$
$k_{SVS}(f_{OSC})$	Supply voltage coefficient of oscillation frequency	$V_{CO\ IN} = 1/2 V_{DD}$ , $V_{DD} = 4.75\text{ V}$ to $5.25\text{ V}$		0.001		%/mV
	Jitter absolute (see Note 21)	PLL jitter, $N = 128$		140		ps

NOTES: 20. The time period to the stable VCO oscillation frequency after the VCO INHIBIT terminal is changed to a low level.

21. Jitter performance is highly dependent on circuit layout and external device characteristics. The jitter specification was made with a carefully deigned PCB with no device socket.

**PFD section**

PARAMETER		TEST CONDITIONS	MIN	TYP	MAX	UNIT
$f_{max}$	Maximum operation frequency		65			MHz
$t_{PLZ}$	PFD output disable time from low level			20	40	ns
$t_{PHZ}$	PFD output disable time from high level			20	40	ns
$t_{PZL}$	PFD output enable time to low level			4	20	ns
$t_{PZH}$	PFD output enable time to high level			4.3	20	ns
$t_r$	Rise time	$C_L = 15\text{ pF}$		2.1	10	ns
$t_f$	Fall time	$C_L = 15\text{ pF}$		1.3	10	ns

# TLC2933A HIGH PERFORMANCE PHASE LOCKED LOOP

SLES149 – OCTOBER 2005

## PARAMETER MEASUREMENT INFORMATION

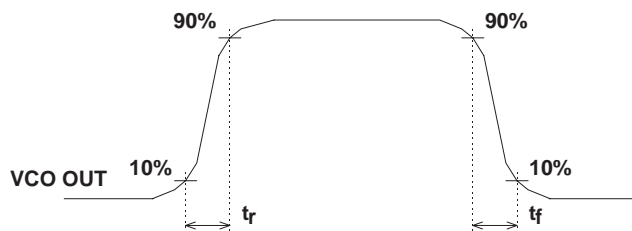

Figure 3. VCO Output Voltage Waveform

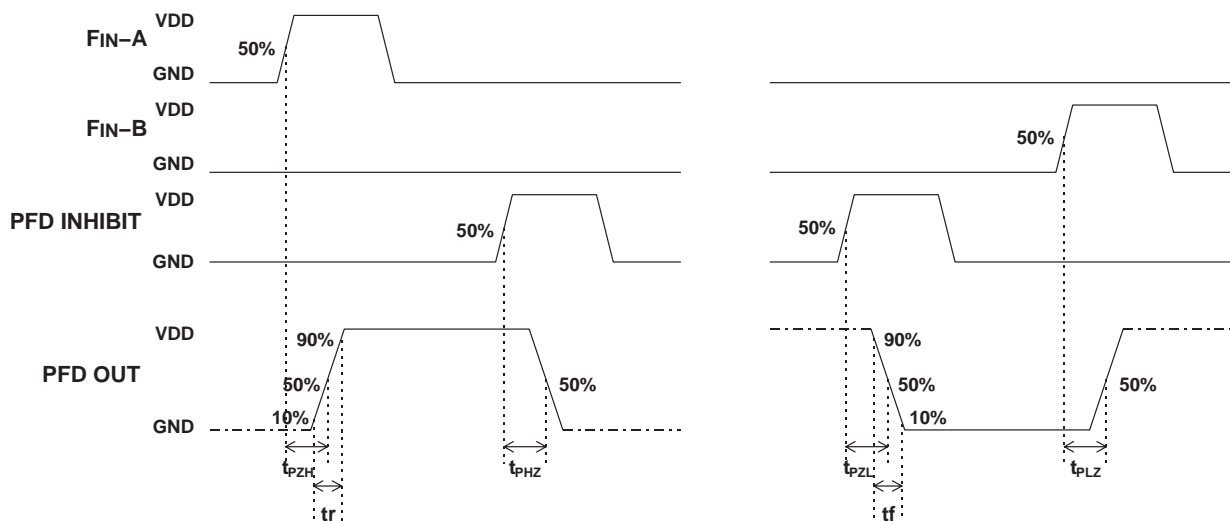

Figure 4. PFD Output Voltage Waveform

Table 4. PFD Output Test Conditions

PARAMETER	$R_L$	$C_L$	S1	S2
$t_{PZH}$	1 k $\Omega$	15 pF	OPEN	CLOSE
$t_{PHZ}$				
$t_r$				
$t_{PZL}$			CLOSE	OPEN
$t_{PLZ}$				
$t_f$				

PARAMETER MEASUREMENT INFORMATION

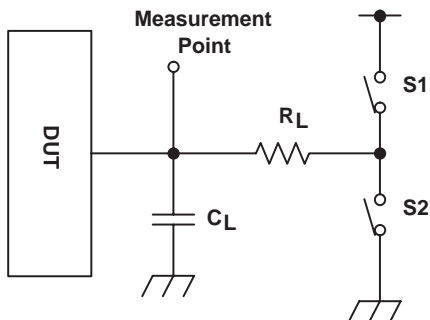

Figure 5. PFD Output Test Conditions

TYPICAL CHARACTERISTICS

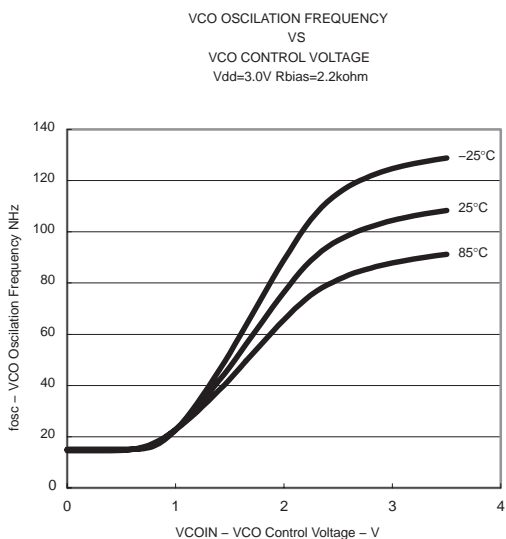

Figure 6.

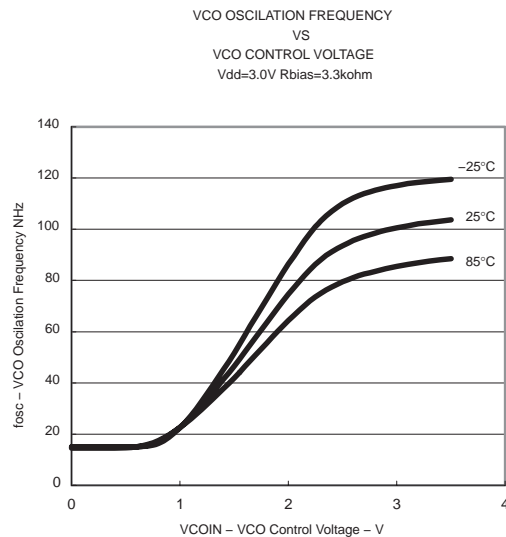

Figure 7.

# TLC2933A HIGH PERFORMANCE PHASE LOCKED LOOP

SLES149 – OCTOBER 2005

## TYPICAL CHARACTERISTICS

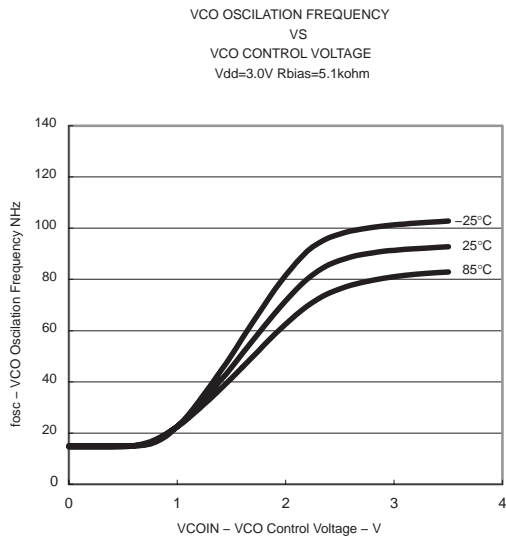

Figure 8.

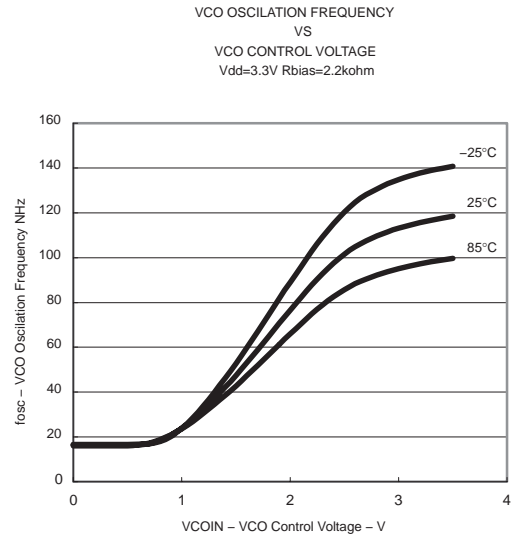

Figure 9.

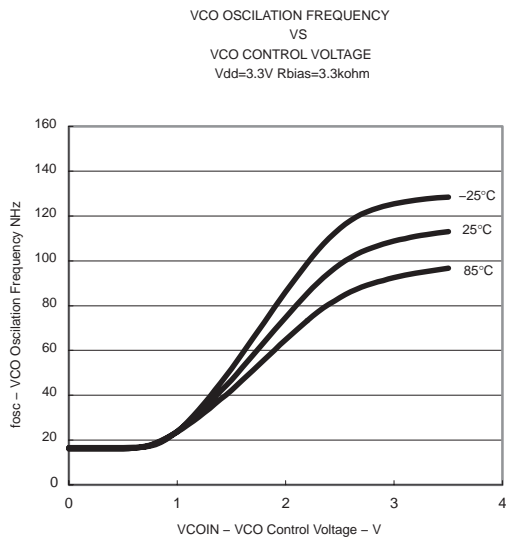

Figure 10.

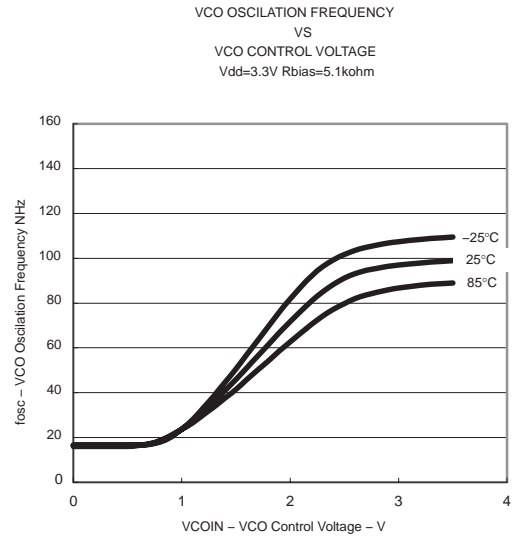

Figure 11.

TYPICAL CHARACTERISTICS

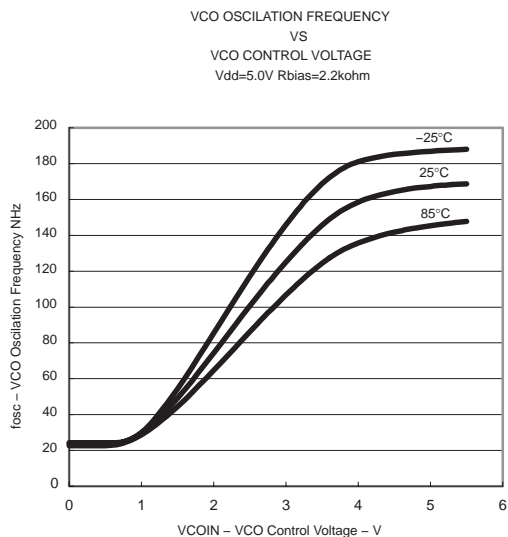

Figure 12.

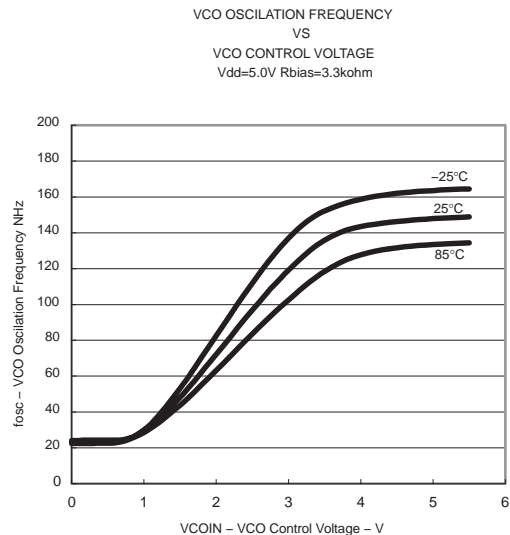

Figure 13.

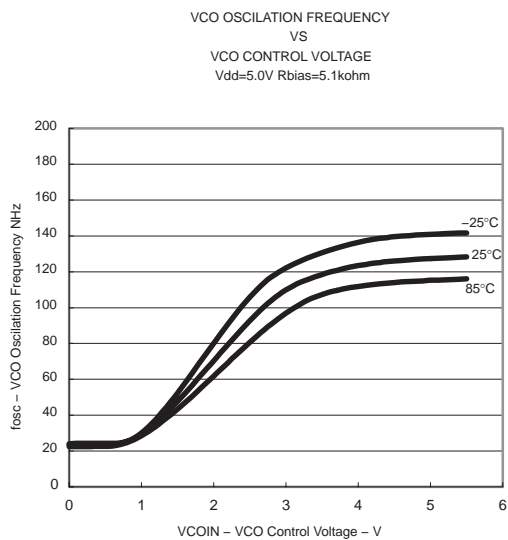

Figure 14.

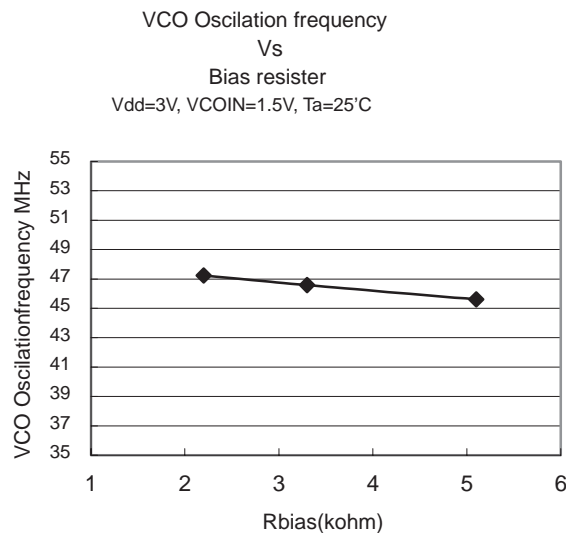

Figure 15.

# TLC2933A HIGH PERFORMANCE PHASE LOCKED LOOP

SLES149 – OCTOBER 2005

## TYPICAL CHARACTERISTICS

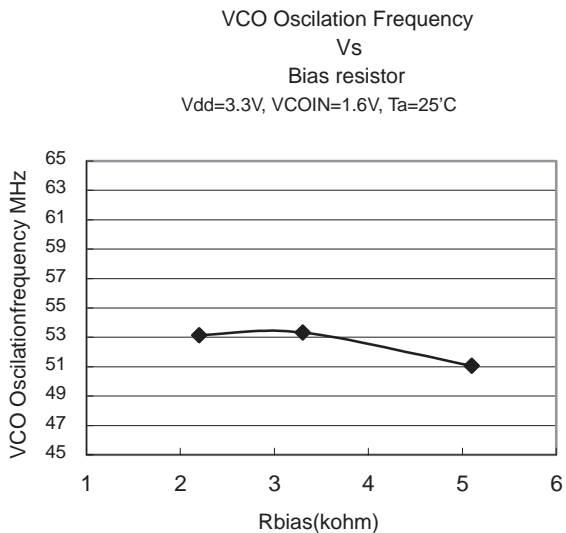

Figure 16.

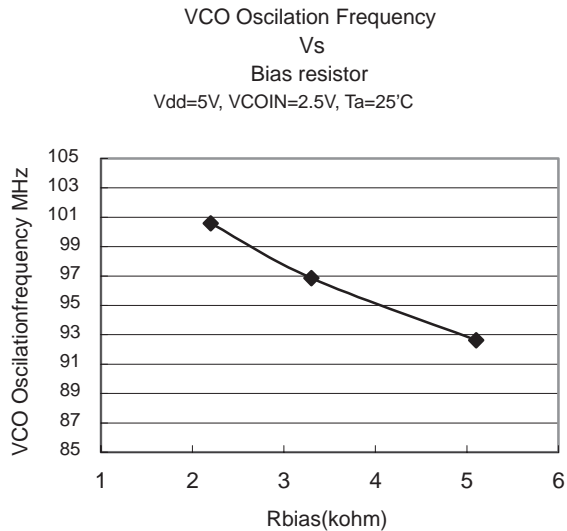

Figure 17.

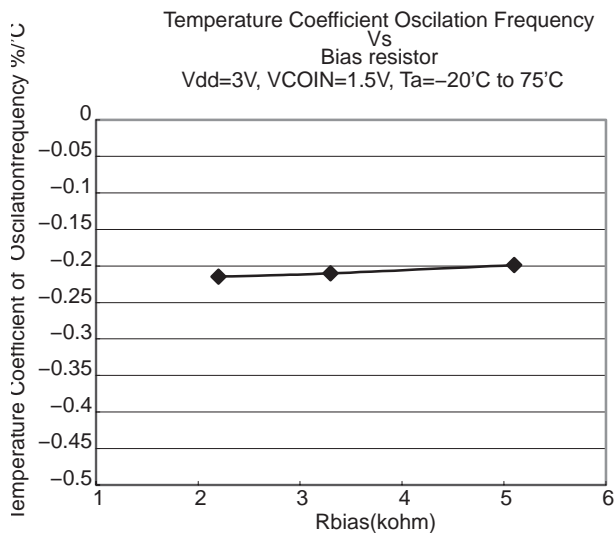

Figure 18.

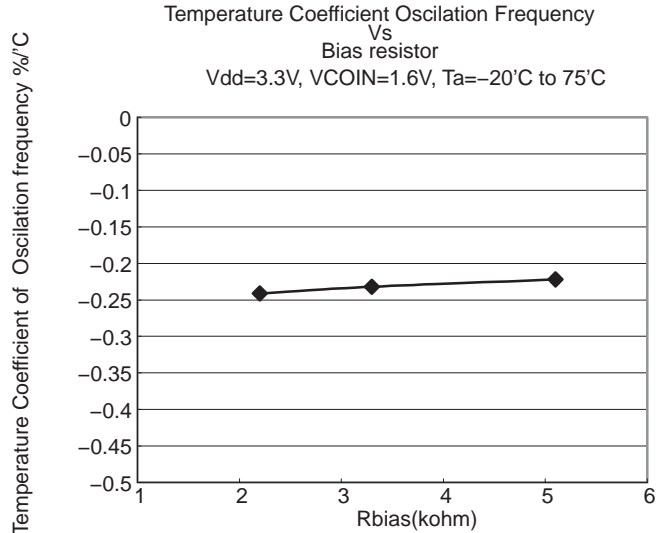

Figure 19.

TYPICAL CHARACTERISTICS

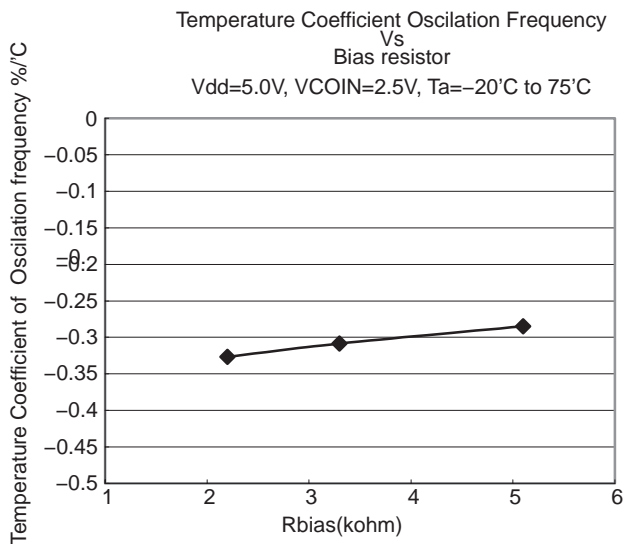

Figure 20.

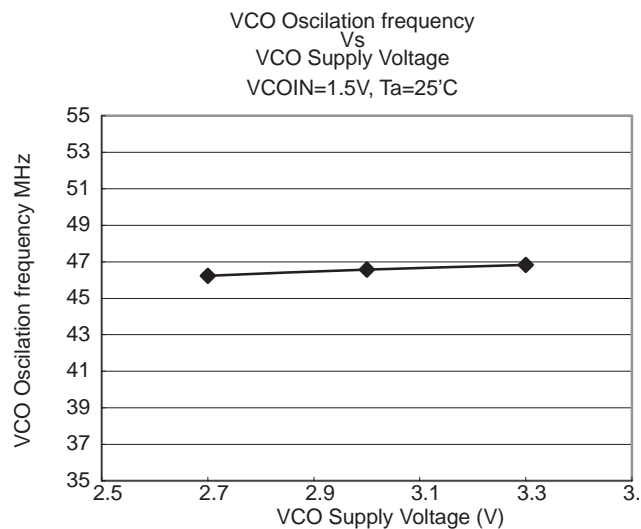

Figure 21.

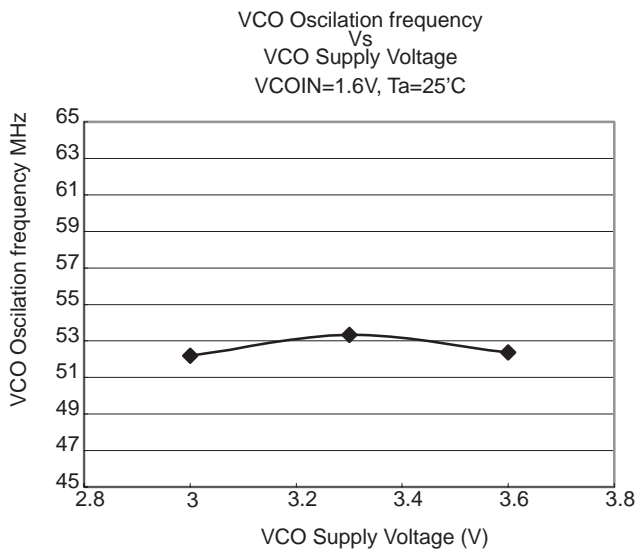

Figure 22.

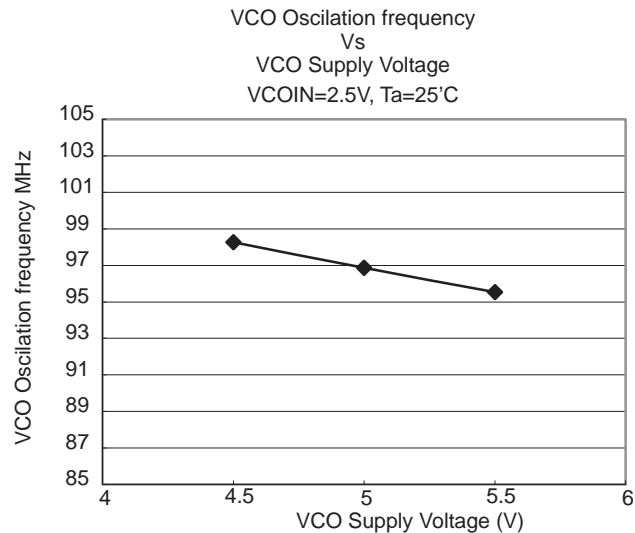

Figure 23.

# TLC2933A HIGH PERFORMANCE PHASE LOCKED LOOP

SLES149 – OCTOBER 2005

## TYPICAL CHARACTERISTICS

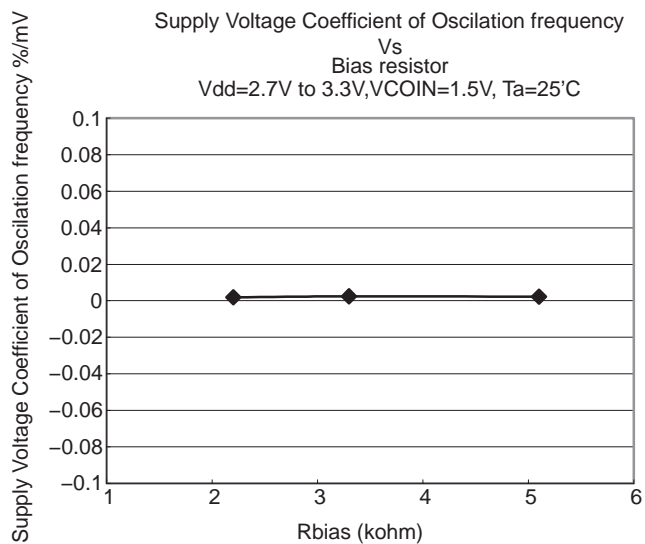

Figure 24.

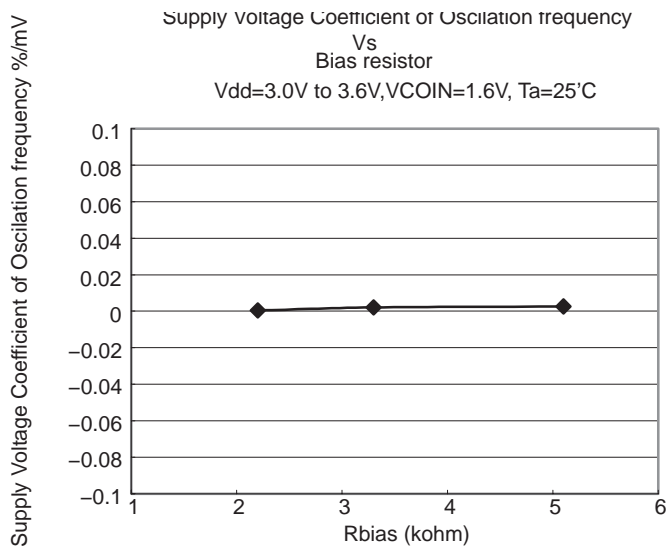

Figure 25.

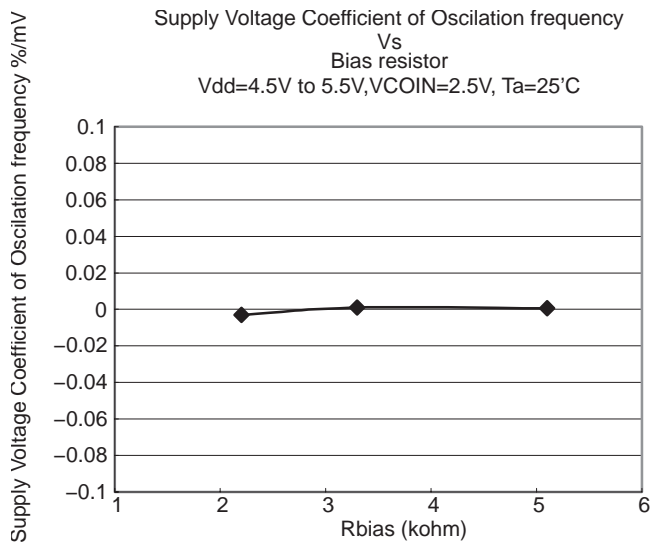

Figure 26.

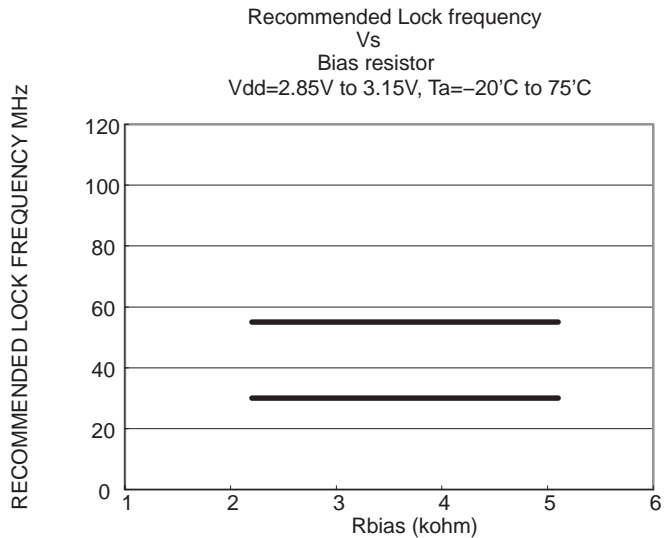

Figure 27.



TYPICAL CHARACTERISTICS

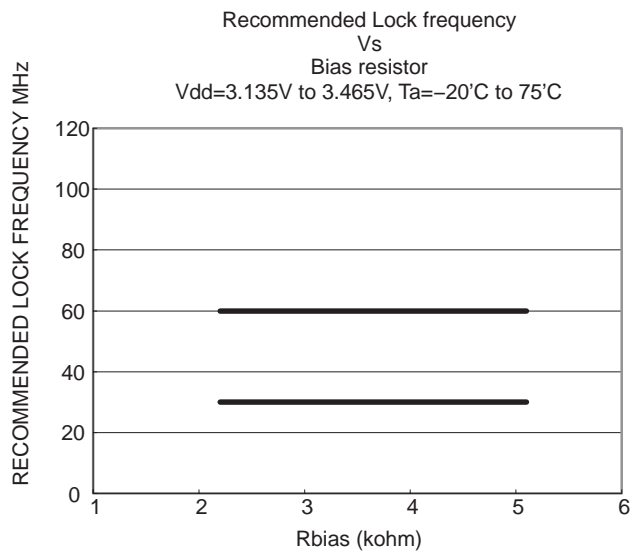

Figure 28.

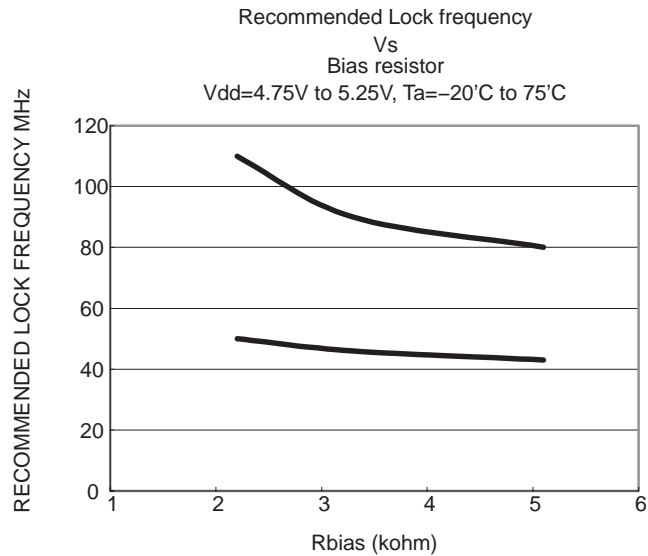

Figure 29.

**PACKAGING INFORMATION**

Orderable Device	Status (1)	Package Type	Package Drawing	Pins	Package Qty	Eco Plan (2)	Lead finish/ Ball material (6)	MSL Peak Temp (3)	Op Temp (°C)	Device Marking (4/5)	Samples
TLC2933AIPW	ACTIVE	TSSOP	PW	14	90	RoHS & Green	NIPDAU	Level-1-260C-UNLIM	-20 to 75	Y2933A	<a href="#">Samples</a>
TLC2933AIPWG4	ACTIVE	TSSOP	PW	14	90	RoHS & Green	NIPDAU	Level-1-260C-UNLIM	-20 to 75	Y2933A	<a href="#">Samples</a>
TLC2933AIPWR	ACTIVE	TSSOP	PW	14	2000	RoHS & Green	NIPDAU	Level-1-260C-UNLIM	-20 to 75	Y2933A	<a href="#">Samples</a>

(1) The marketing status values are defined as follows:

**ACTIVE:** Product device recommended for new designs.

**LIFEBUY:** TI has announced that the device will be discontinued, and a lifetime-buy period is in effect.

**NRND:** Not recommended for new designs. Device is in production to support existing customers, but TI does not recommend using this part in a new design.

**PREVIEW:** Device has been announced but is not in production. Samples may or may not be available.

**OBSELETE:** TI has discontinued the production of the device.

(2) **RoHS:** TI defines "RoHS" to mean semiconductor products that are compliant with the current EU RoHS requirements for all 10 RoHS substances, including the requirement that RoHS substance do not exceed 0.1% by weight in homogeneous materials. Where designed to be soldered at high temperatures, "RoHS" products are suitable for use in specified lead-free processes. TI may reference these types of products as "Pb-Free".

**RoHS Exempt:** TI defines "RoHS Exempt" to mean products that contain lead but are compliant with EU RoHS pursuant to a specific EU RoHS exemption.

**Green:** TI defines "Green" to mean the content of Chlorine (Cl) and Bromine (Br) based flame retardants meet JS709B low halogen requirements of <=1000ppm threshold. Antimony trioxide based flame retardants must also meet the <=1000ppm threshold requirement.

(3) MSL, Peak Temp. - The Moisture Sensitivity Level rating according to the JEDEC industry standard classifications, and peak solder temperature.

(4) There may be additional marking, which relates to the logo, the lot trace code information, or the environmental category on the device.

(5) Multiple Device Markings will be inside parentheses. Only one Device Marking contained in parentheses and separated by a "~" will appear on a device. If a line is indented then it is a continuation of the previous line and the two combined represent the entire Device Marking for that device.

(6) Lead finish/Ball material - Orderable Devices may have multiple material finish options. Finish options are separated by a vertical ruled line. Lead finish/Ball material values may wrap to two lines if the finish value exceeds the maximum column width.

**Important Information and Disclaimer:**The information provided on this page represents TI's knowledge and belief as of the date that it is provided. TI bases its knowledge and belief on information provided by third parties, and makes no representation or warranty as to the accuracy of such information. Efforts are underway to better integrate information from third parties. TI has taken and continues to take reasonable steps to provide representative and accurate information but may not have conducted destructive testing or chemical analysis on incoming materials and chemicals. TI and TI suppliers consider certain information to be proprietary, and thus CAS numbers and other limited information may not be available for release.

In no event shall TI's liability arising out of such information exceed the total purchase price of the TI part(s) at issue in this document sold by TI to Customer on an annual basis.

**TAPE AND REEL INFORMATION**

**QUADRANT ASSIGNMENTS FOR PIN 1 ORIENTATION IN TAPE**

\*All dimensions are nominal

Device	Package Type	Package Drawing	Pins	SPQ	Reel Diameter (mm)	Reel Width W1 (mm)	A0 (mm)	B0 (mm)	K0 (mm)	P1 (mm)	W (mm)	Pin1 Quadrant
TLC2933AIPWR	TSSOP	PW	14	2000	330.0	12.4	6.9	5.6	1.6	8.0	12.0	Q1

**TAPE AND REEL BOX DIMENSIONS**

\*All dimensions are nominal

Device	Package Type	Package Drawing	Pins	SPQ	Length (mm)	Width (mm)	Height (mm)
TLC2933AIPWR	TSSOP	PW	14	2000	356.0	356.0	35.0

**TUBE**

\*All dimensions are nominal

Device	Package Name	Package Type	Pins	SPQ	L (mm)	W (mm)	T (μm)	B (mm)
TLC2933AIPW	PW	TSSOP	14	90	530	10.2	3600	3.5
TLC2933AIPWG4	PW	TSSOP	14	90	530	10.2	3600	3.5

PW (R-PDSO-G14)

PLASTIC SMALL OUTLINE



- NOTES:
- A. All linear dimensions are in millimeters. Dimensioning and tolerancing per ASME Y14.5M-1994.
  - B. This drawing is subject to change without notice.
  - C. Body length does not include mold flash, protrusions, or gate burrs. Mold flash, protrusions, or gate burrs shall not exceed 0,15 each side.
  - D. Body width does not include interlead flash. Interlead flash shall not exceed 0,25 each side.
  - E. Falls within JEDEC MO-153

## IMPORTANT NOTICE AND DISCLAIMER

TI PROVIDES TECHNICAL AND RELIABILITY DATA (INCLUDING DATA SHEETS), DESIGN RESOURCES (INCLUDING REFERENCE DESIGNS), APPLICATION OR OTHER DESIGN ADVICE, WEB TOOLS, SAFETY INFORMATION, AND OTHER RESOURCES "AS IS" AND WITH ALL FAULTS, AND DISCLAIMS ALL WARRANTIES, EXPRESS AND IMPLIED, INCLUDING WITHOUT LIMITATION ANY IMPLIED WARRANTIES OF MERCHANTABILITY, FITNESS FOR A PARTICULAR PURPOSE OR NON-INFRINGEMENT OF THIRD PARTY INTELLECTUAL PROPERTY RIGHTS.

These resources are intended for skilled developers designing with TI products. You are solely responsible for (1) selecting the appropriate TI products for your application, (2) designing, validating and testing your application, and (3) ensuring your application meets applicable standards, and any other safety, security, regulatory or other requirements.

These resources are subject to change without notice. TI grants you permission to use these resources only for development of an application that uses the TI products described in the resource. Other reproduction and display of these resources is prohibited. No license is granted to any other TI intellectual property right or to any third party intellectual property right. TI disclaims responsibility for, and you will fully indemnify TI and its representatives against, any claims, damages, costs, losses, and liabilities arising out of your use of these resources.

TI's products are provided subject to [TI's Terms of Sale](#) or other applicable terms available either on [ti.com](http://ti.com) or provided in conjunction with such TI products. TI's provision of these resources does not expand or otherwise alter TI's applicable warranties or warranty disclaimers for TI products.

TI objects to and rejects any additional or different terms you may have proposed.

Mailing Address: Texas Instruments, Post Office Box 655303, Dallas, Texas 75265  
Copyright © 2022, Texas Instruments Incorporated