

TLV07 36-V Precision, Rail-to-Rail Output Operational Amplifier

1 Features

- Low Offset Voltage: 100 μV (Maximum)
- Rail-to-Rail Output
- Low Noise: 19 nV / $\sqrt{\text{Hz}}$
- Unity-Gain Stable
- RFI Filtered Inputs
- Input Range Includes Negative Supply
- Rail-to-Rail Output
- Gain Bandwidth: 1 MHz
- Low Quiescent Current: 930 μA
- Full Industrial Temperature Range: -40°C to $+125^{\circ}\text{C}$
- Offered in the Industry-Standard 8-Pin SOIC Package

2 Applications

- Battery Testers
- Tracking Amplifier in Power Modules
- Merchant Power Supplies
- Transducer Amplifiers
- Temperature Measurements
- Strain Gauge Amplifiers

3 Description

The TLV07 device is a 36-V, single-supply, low-noise, precision operational amplifier (op amp) manufactured using TI's laser trim operational amplifier technology. Each amplifiers' input offset voltage is trimmed in production to obtain a low offset voltage of 100 μV (maximum).

The TLV07 offers outstanding dc precision and ac performance, including rail-to-rail output, low offset voltage (± 100 μV , maximum) and 1-MHz bandwidth. The TLV07 is stable at $G = 1$ with capacitive loads up to 200 pF. The input can operate 100 mV below the negative rail and within 2 V of the positive rail. This wide input voltage range, combined with a high CMRR of 120 dB, make the TLV07 well-suited when operated in the non-inverting configuration.

The TLV07 op amp is specified from -40°C to $+125^{\circ}\text{C}$.

Device Information⁽¹⁾

PART NUMBER	PACKAGE	BODY SIZE (NOM)
TLV07	SOIC (8)	4.90 mm x 3.91 mm

(1) For all available packages, see the orderable addendum at the end of the data sheet.

Single Pole Low-Pass Filter With Gain

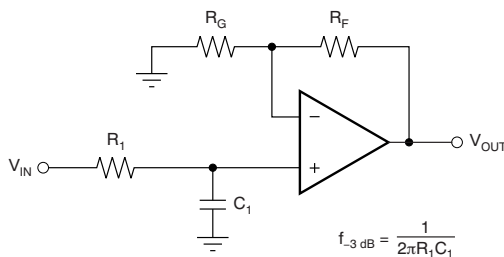

$$\frac{V_{\text{OUT}}}{V_{\text{IN}}} = \left(1 + \frac{R_F}{R_G}\right) \left(\frac{1}{1 + sR_1C_1}\right)$$



Table of Contents

1 Features	1	7.4 Device Functional Modes.....	16
2 Applications	1	8 Application and Implementation	17
3 Description	1	8.1 Application Information.....	17
4 Revision History	2	8.2 Typical Application	17
5 Pin Configuration and Functions	3	9 Power Supply Recommendations	18
6 Specifications	4	10 Layout	19
6.1 Absolute Maximum Ratings	4	10.1 Layout Guidelines	19
6.2 ESD Ratings.....	4	10.2 Layout Example	20
6.3 Recommended Operating Conditions.....	4	11 Device and Documentation Support	21
6.4 Thermal Information: TLV07	4	11.1 Device Support.....	21
6.5 Electrical Characteristics.....	5	11.2 Documentation Support	22
6.6 Typical Characteristics.....	6	11.3 Community Resources.....	22
7 Detailed Description	13	11.4 Trademarks	22
7.1 Overview	13	11.5 Electrostatic Discharge Caution.....	22
7.2 Functional Block Diagram	13	11.6 Glossary	22
7.3 Feature Description.....	14	12 Mechanical, Packaging, and Orderable Information	22

4 Revision History

NOTE: Page numbers for previous revisions may differ from page numbers in the current version.

Changes from Original (July 2017) to Revision A	Page
• First release of production-data data sheet	1

5 Pin Configuration and Functions

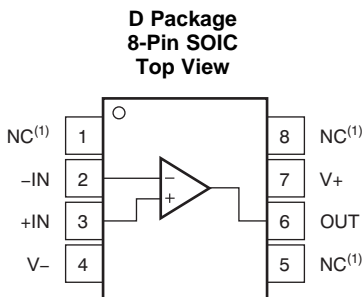

(1) NC- no internal connection

Pin Functions: TLV07

NAME	NO.	I/O	DESCRIPTION
-IN	2	I	Negative (inverting) input
+IN	3	I	Positive (non-inverting) input
NC	1, 5, 8	—	No internal connection (can be left floating)
OUT	6	O	Output
V+	7	—	Positive (highest) power supply
V-	4	—	Negative (lowest) power supply

6 Specifications

6.1 Absolute Maximum Ratings

Over operating free-air temperature range, unless otherwise noted.⁽¹⁾

	MIN	MAX	UNIT
Supply voltage	-20	20	V
Single supply voltage		40	V
Signal input pin voltage	(V-) - 0.5	(V+) + 0.5	V
Signal input pin current	-10	10	mA
Output short-circuit current ⁽²⁾	Continuous		
Operating ambient temperature, T _A	-40	125	°C
Junction temperature, T _J		150	°C
Storage temperature, T _{stg}	-65	150	°C

- (1) Stresses beyond those listed under *Absolute Maximum Ratings* may cause permanent damage to the device. These are stress ratings only, which do not imply functional operation of the device at these or any other conditions beyond those indicated under *Recommended Operating Conditions*. Exposure to absolute-maximum-rated conditions for extended periods may affect device reliability.
- (2) Short-circuit to ground, one amplifier per package.

6.2 ESD Ratings

		VALUE	UNIT
V _(ESD)	Electrostatic discharge	Human-body model (HBM), per ANSI/ESDA/JEDEC JS-001 ⁽¹⁾	±2000
		Charged-device model (CDM), per JEDEC specification JESD22-C101 ⁽²⁾	±500
			V

- (1) JEDEC document JEP155 states that 500-V HBM allows safe manufacturing with a standard ESD control process.
- (2) JEDEC document JEP157 states that 250-V CDM allows safe manufacturing with a standard ESD control process.

6.3 Recommended Operating Conditions

over operating free-air temperature range (unless otherwise noted)

		MIN	MAX	UNIT
V _S	Supply voltage (V _S = V+ - V-)	2.7	36	V
T _A	Operating temperature	-40	125	°C

6.4 Thermal Information: TLV07

THERMAL METRIC		TLV07	UNIT
		D (SOIC)	
		8 PINS	
R _{θJA}	Junction-to-ambient thermal resistance	149.5	°C/W
R _{θJC(top)}	Junction-to-case (top) thermal resistance	97.9	°C/W
R _{θJB}	Junction-to-board thermal resistance	87.7	°C/W
ψ _{JT}	Junction-to-top characterization parameter	35.5	°C/W
ψ _{JB}	Junction-to-board characterization parameter	89.5	°C/W
R _{θJC(bot)}	Junction-to-case (bottom) thermal resistance	—	°C/W

6.5 Electrical Characteristics

at $T_A = 25^\circ\text{C}$, $V_+ = +15\text{ V}$, $V_- = -15\text{ V}$, $V_{CM} = V_{OUT} = V_S / 2$, and $R_L = 10\text{ k}\Omega$ connected to $V_S / 2$ (unless otherwise noted).

PARAMETER		TEST CONDITIONS	MIN	TYP	MAX	UNIT
OFFSET VOLTAGE						
V_{OS}	Input offset voltage			50	± 100	μV
dV_{OS}/dT	Input offset voltage drift	$T_A = -40^\circ\text{C}$ to 125°C		± 0.9		$\mu\text{V}/^\circ\text{C}$
PSRR	Input offset voltage vs power supply	$V_S = 2.7\text{ V}$ to 36 V		0.3		$\mu\text{V}/\text{V}$
INPUT BIAS CURRENT						
I_B	Input bias current			± 40		pA
		$T_A = -40^\circ\text{C}$ to 125°C		± 3		nA
I_{OS}	Input offset current			± 4		pA
NOISE						
	Input voltage noise	$f = 0.1\text{ Hz}$ to 10 Hz		2.7		μV_{PP}
e_n	Input voltage noise density	$f = 1\text{ kHz}$		19		$\text{nV}/\sqrt{\text{Hz}}$
INPUT VOLTAGE						
V_{CM}	Common-mode voltage range		$(V_-) - 0.1$		$(V_+) - 2$	V
CMRR	Common-mode rejection ratio	$V_S = \pm 18\text{ V}$, $(V_-) - 0.1\text{ V} < V_{CM} < (V_+) - 2\text{ V}$	104	120		dB
INPUT IMPEDANCE						
	Differential			$100 \parallel 3$		$\text{M}\Omega \parallel \text{pF}$
	Common-mode			$6 \parallel 3$		$10^{12}\ \Omega \parallel \text{pF}$
OPEN-LOOP GAIN						
A_{OL}	Open-loop voltage gain	$(V_-) + 0.35\text{ V} < V_O < (V_+) - 0.35\text{ V}$	110	130		dB
FREQUENCY RESPONSE						
GBP	Gain bandwidth product			1		MHz
SR	Slew rate	$G = 1$		0.4		$\text{V}/\mu\text{s}$
t_S	Settling time	To 0.1%, $V_S = \pm 18\text{ V}$, $G = +1$, 10-V step		20		μs
		To 0.01% (12-bit), $V_S = \pm 18\text{ V}$, $G = 1$, 10-V step		28		μs
OUTPUT						
V_O	Voltage output swing from rail	$R_L = 10\text{ k}\Omega$		120		mV
I_{SC}	Short-circuit current			17		mA
R_O	Open-loop output resistance	$f = 1\text{ MHz}$ $I_O = 0\text{ A}$		900		Ω
POWER SUPPLY						
I_Q	Quiescent current per amplifier	$I_O = 0\text{ A}$		930	1800	μA
TEMPERATURE						
	Specified range		-40		125	$^\circ\text{C}$
	Operating range		-40		125	$^\circ\text{C}$

6.6 Typical Characteristics

$V_S = \pm 18\text{ V}$, $V_{CM} = V_S / 2$, $R_{LOAD} = 10\text{ k}\Omega$ connected to $V_S / 2$, and $C_L = 100\text{ pF}$, (unless otherwise noted)

Table 1. Characteristic Performance Measurements

DESCRIPTION	FIGURE
Offset Voltage Production Distribution	Figure 1
Offset Voltage Drift Distribution	Figure 2
Offset Voltage vs Temperature	Figure 3
Offset Voltage vs Common-Mode Voltage	Figure 4
Offset Voltage vs Power Supply	Figure 5
I_B and I_{OS} vs Common-Mode Voltage	Figure 6
Input Bias Current vs Temperature	Figure 7
Output Voltage Swing vs Output Current (Maximum Supply)	Figure 8
CMRR and PSRR vs Frequency (Referred-to-Input)	Figure 9
CMRR vs Temperature	Figure 10
PSRR vs Temperature	Figure 11
0.1-Hz to 10-Hz Noise	Figure 12
Input Voltage Noise Spectral Density vs Frequency	Figure 13
THD+N Ratio vs Frequency	Figure 14
THD+N vs Output Amplitude	Figure 15
Quiescent Current vs Temperature	Figure 16
Quiescent Current vs Supply Voltage	Figure 17
Open-Loop Gain and Phase vs Frequency	Figure 18
Closed-Loop Gain vs Frequency	Figure 19
Open-Loop Gain vs Temperature	Figure 20
Open-Loop Output Impedance vs Frequency	Figure 21
No Phase Reversal	Figure 22
Positive Overload Recovery	Figure 23
Negative Overload Recovery	Figure 24
Small-Signal Step Response	Figure 25, Figure 26
Large-Signal Step Response	Figure 27, Figure 28
Large-Signal Settling Time	Figure 29
Short-Circuit Current vs Temperature	Figure 30
Maximum Output Voltage vs Frequency	Figure 31
EMIRR IN+ vs Frequency	Figure 32

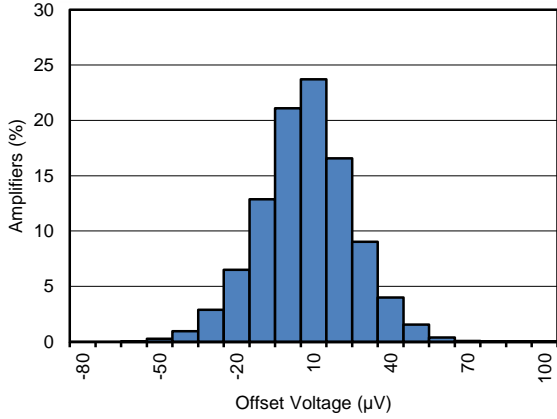

Figure 1. Input Offset Voltage Distribution

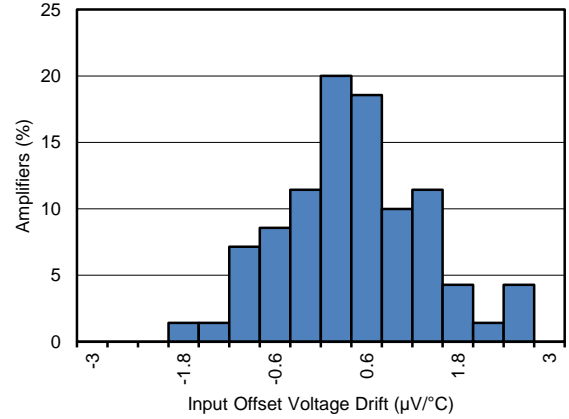

Figure 2. Input Offset Voltage Drift Distribution

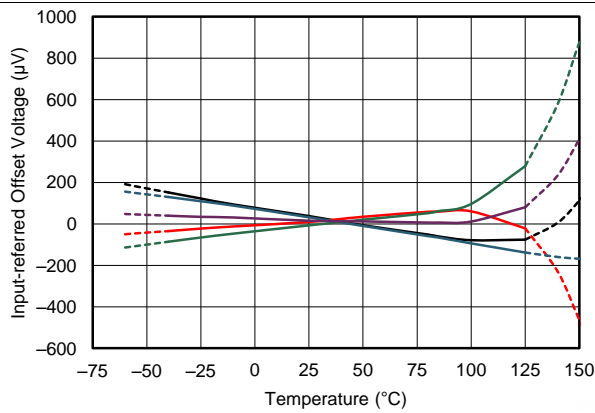

Figure 3. Input Offset Voltage vs Temperature

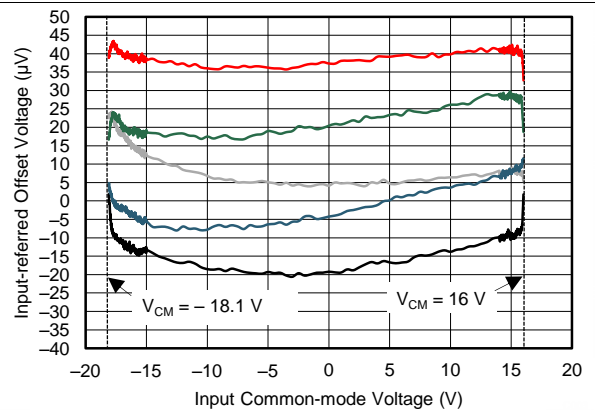

Figure 4. Input Offset Voltage vs Common-Mode Voltage

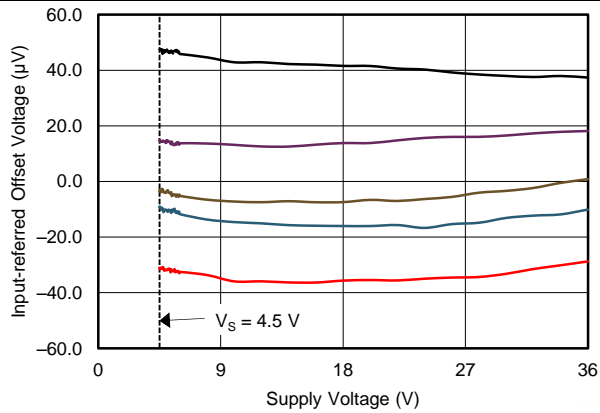

Figure 5. Offset Voltage vs Power Supply

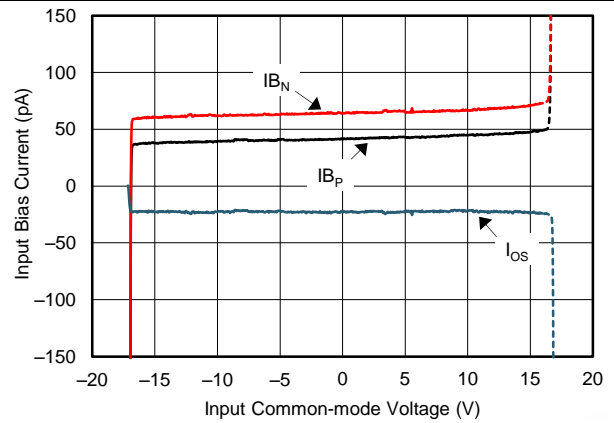

Figure 6. I_B and I_{OS} vs Common Mode Voltage

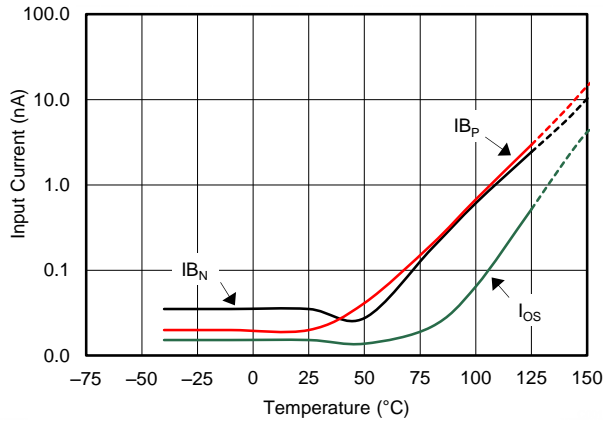

Figure 7. Input Bias Current vs Temperature

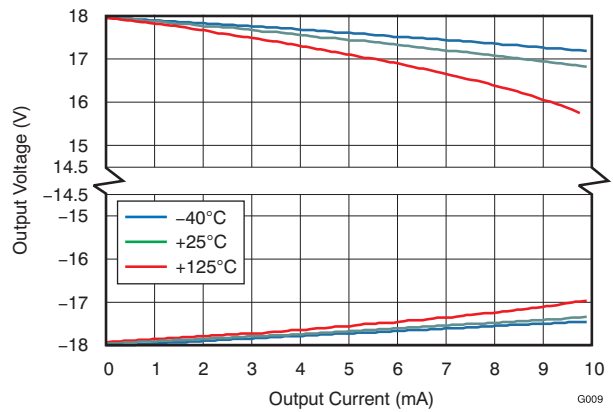

Figure 8. Output Voltage Swing vs Output Current (Maximum Supply)

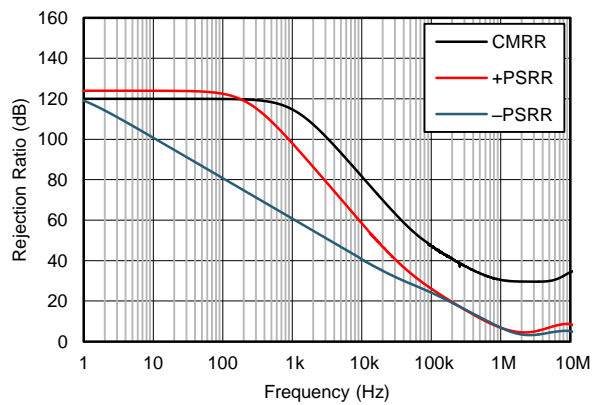

Figure 9. CMRR and PSRR vs Frequency

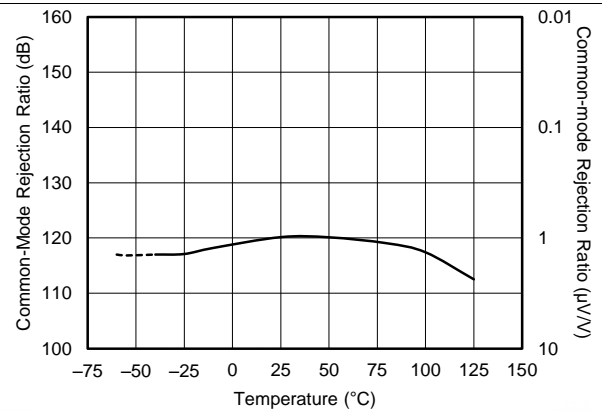

Figure 10. CMRR vs Temperature

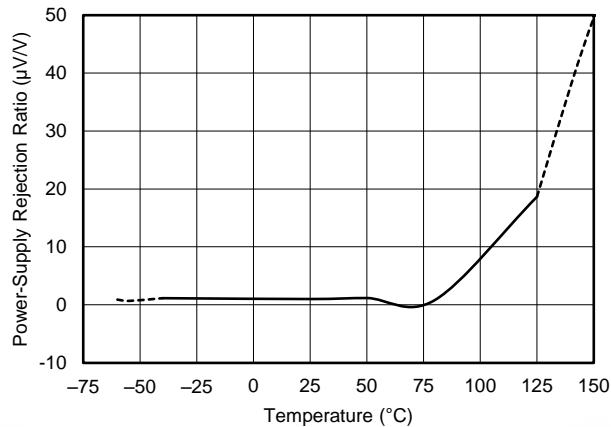

Figure 11. PSRR vs Temperature

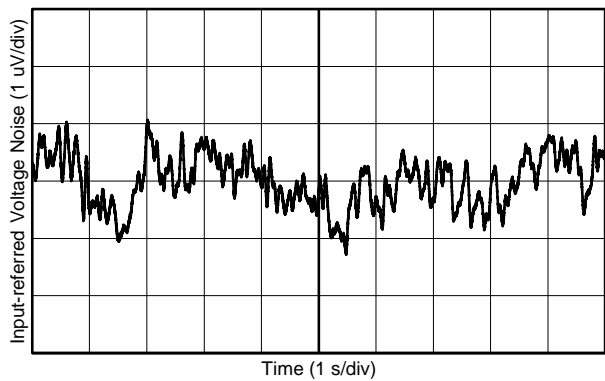

Figure 12. 0.1-Hz to 10-Hz Noise

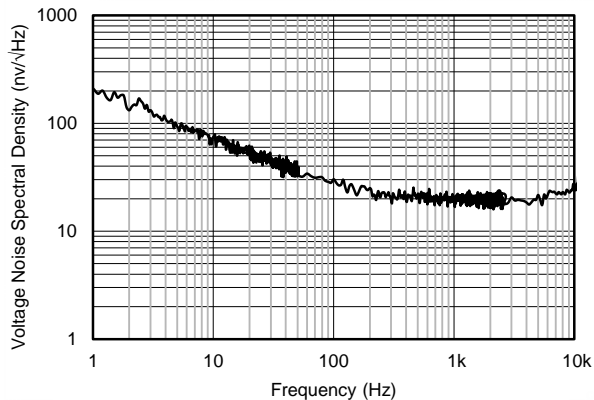

Figure 13. Input Voltage Noise Spectral Density vs Frequency

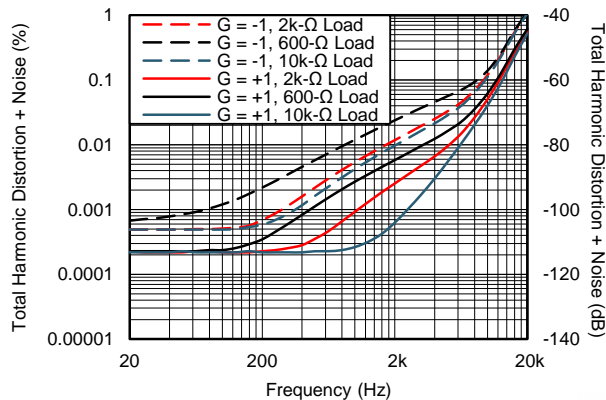

Figure 14. THD + N Ratio vs Frequency

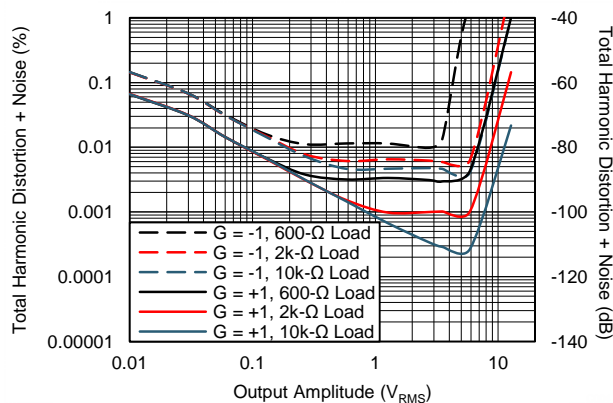

Figure 15. THD + N vs Output Amplitude

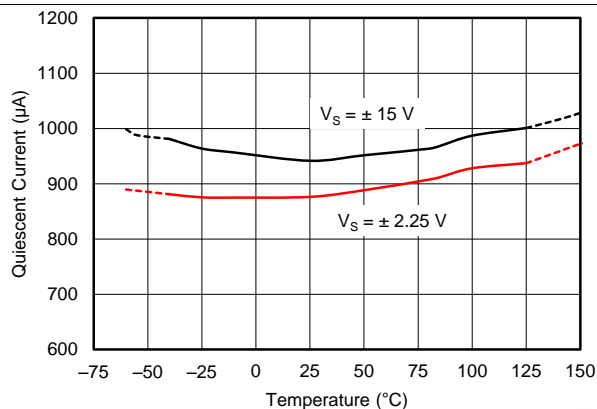

Figure 16. Quiescent Current vs Temperature

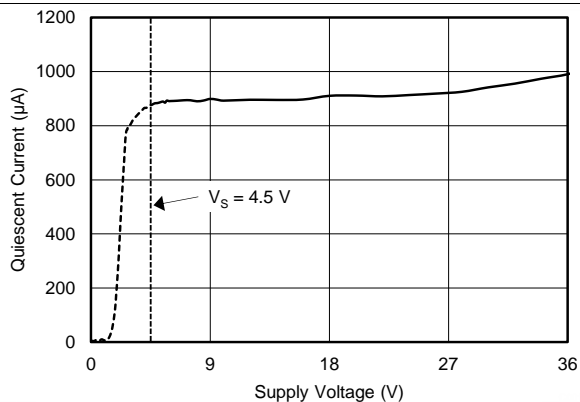

Figure 17. Quiescent Current vs Supply Voltage

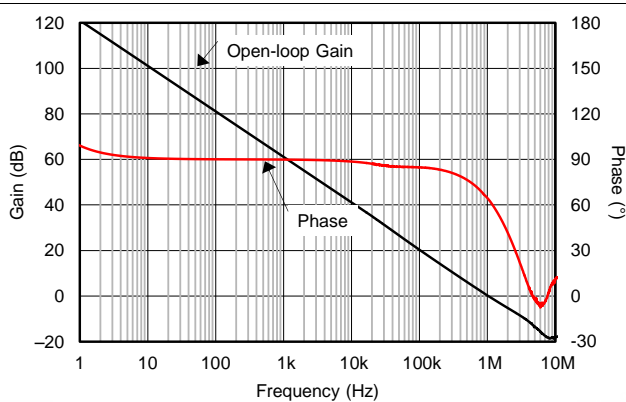

Figure 18. Open-Loop Gain and Phase vs Frequency

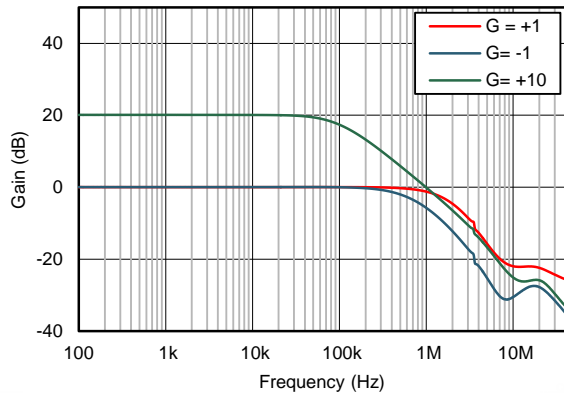

Figure 19. Closed-Loop Gain vs Frequency

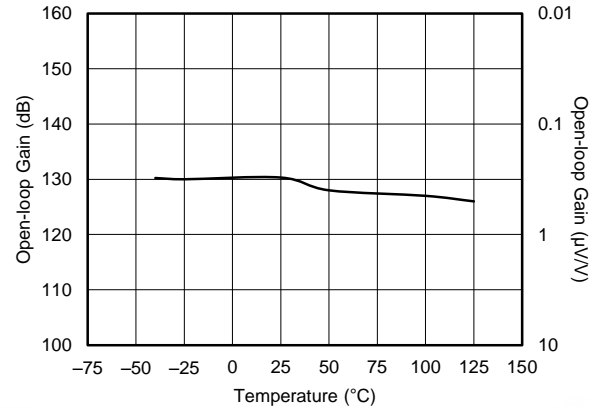

Figure 20. Open-Loop Gain vs Temperature

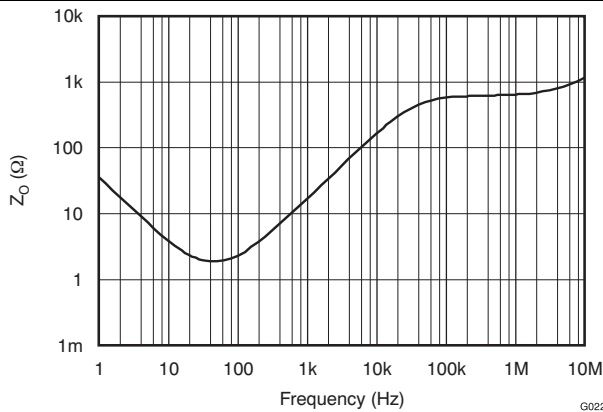

Figure 21. Open-Loop Output Impedance vs Frequency

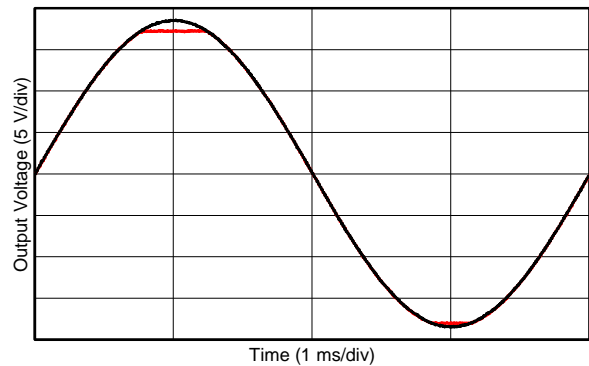

Figure 22. No Phase Reversal

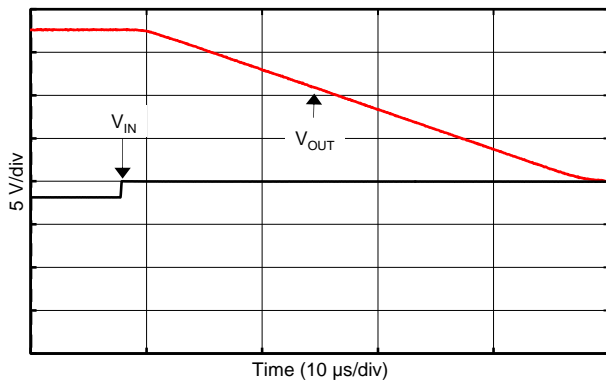

Figure 23. Positive Overload Recovery

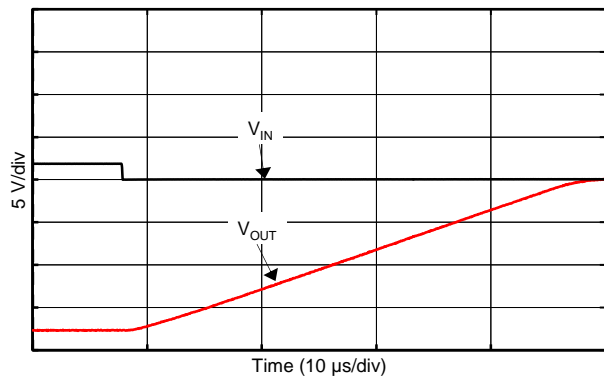
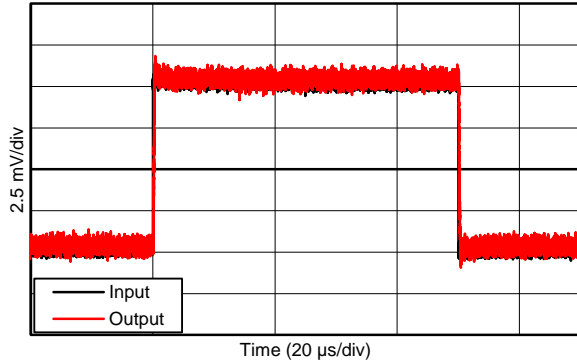
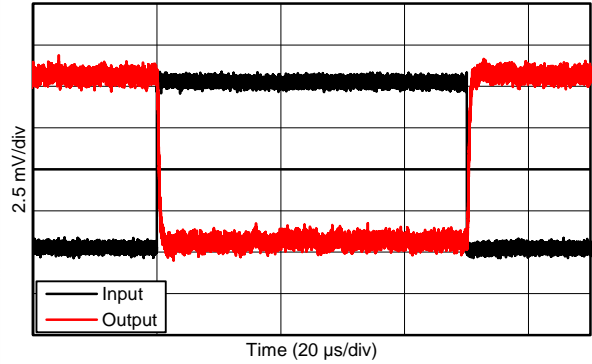

Figure 24. Negative Overload Recovery



G = +1 V/V

Figure 25. Small-Signal Step Response



G = -1 V/V

Figure 26. Small-Signal Step Response

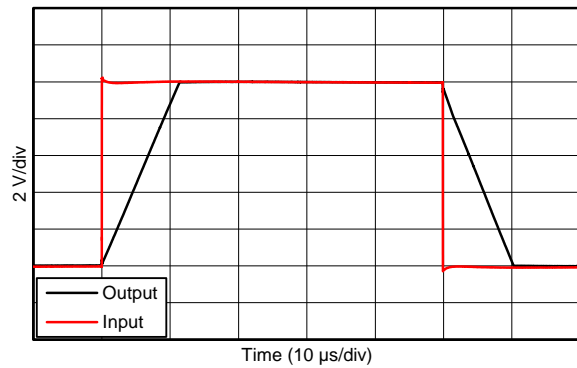

G = +1 V/V

Figure 27. Large-Signal Step Response

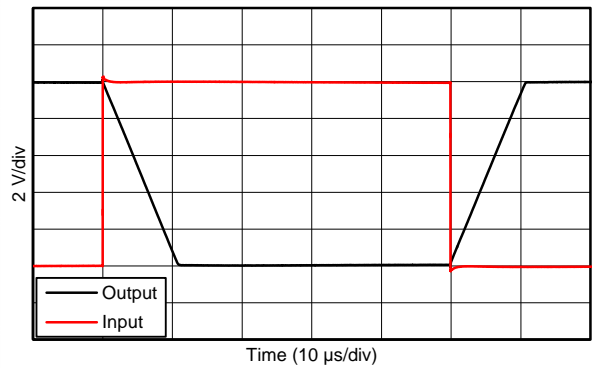

G = -1 V/V

Figure 28. Large-Signal Step Response

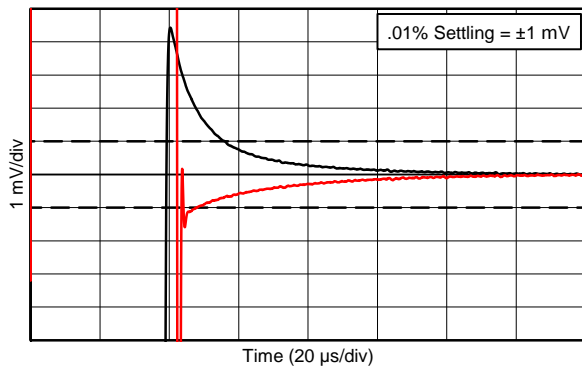

10-V positive step

Figure 29. Large-Signal Settling Time

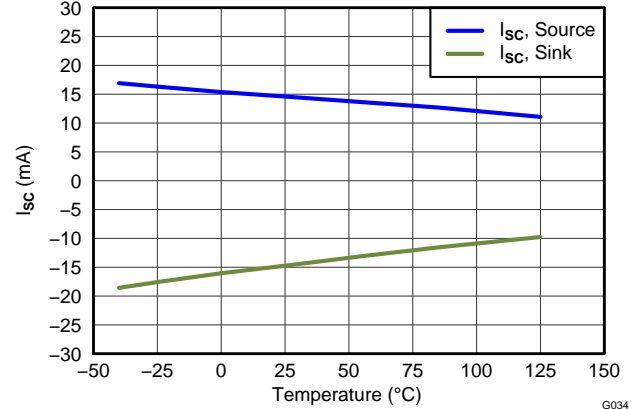
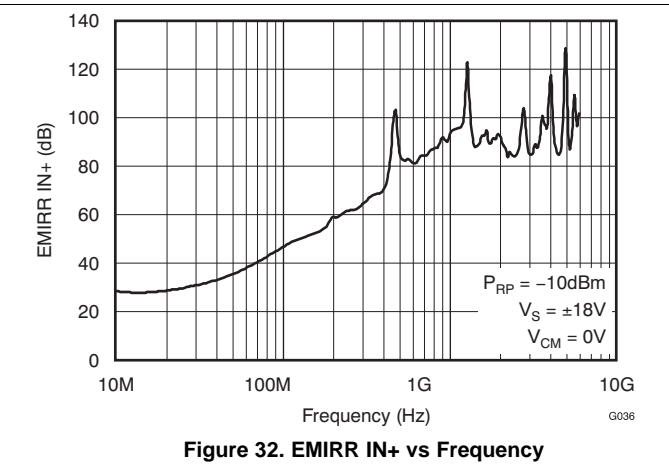
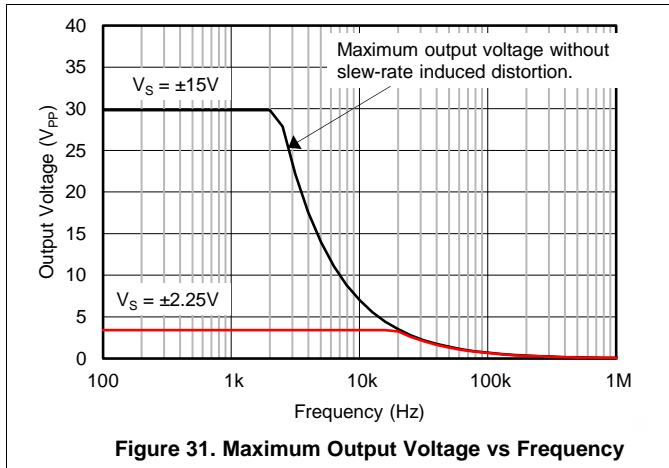

Figure 30. Short-Circuit Current vs Temperature



7 Detailed Description

7.1 Overview

The TLV07 operational amplifier provides high overall performance, making the device suitable for many general-purpose applications. The excellent offset drift of only $0.9 \mu\text{V}/^\circ\text{C}$ provides excellent stability over the entire temperature range. In addition, the device offers very good overall performance with high CMRR, PSRR, and A_{OL} .

7.2 Functional Block Diagram

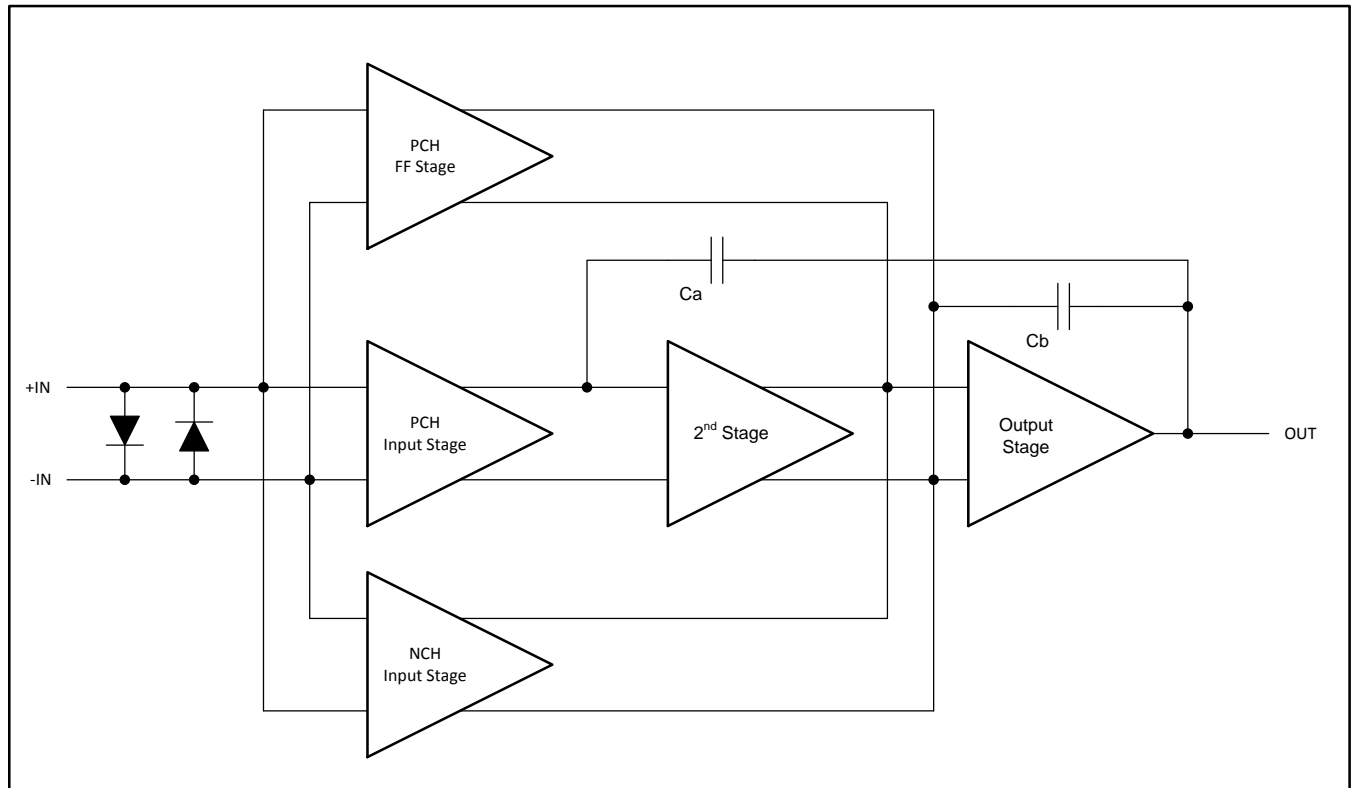

Copyright © 2017, Texas Instruments Incorporated

7.3 Feature Description

7.3.1 Operating Characteristics

The TLV07 op amp is specified for operation from 2.7 V to 36 V (± 1.35 V to ± 18 V). Many of the specifications apply from -40°C to $+125^{\circ}\text{C}$. Parameters that can exhibit significant variance with regard to operating voltage or temperature are shown in [Typical Characteristics](#).

7.3.2 Phase-Reversal Protection

The TLV07 has an internal phase-reversal protection. Many operational amplifiers exhibit a phase reversal when the input drives beyond the linear common-mode range. This condition is most often encountered in noninverting circuits when the input drives beyond the specified common-mode voltage range, which causes the output to reverse into the opposite rail. The input of the TLV07 prevents phase reversal with excessive common-mode voltage. Instead, the output limits into the appropriate rail. This performance is shown in [Figure 33](#).

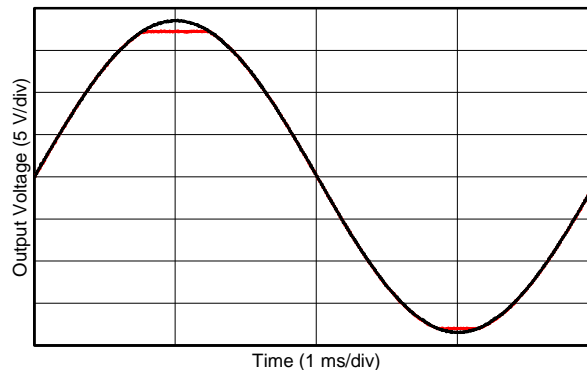

Figure 33. No Phase Reversal

7.3.3 Electrical Overstress

Designers often ask questions about the capability of an operational amplifier to withstand electrical overstress. The questions typically focus on the device inputs, but may involve the supply voltage pins or even the output pin. Each of these different pin functions have electrical stress limits determined by the voltage breakdown characteristics of the particular semiconductor fabrication process and specific circuits connected to the pin. Internal electrostatic discharge (ESD) protection is built into the circuits to protect the circuits from accidental ESD events before and during product assembly.

A good understanding of this basic ESD circuitry and the relevance of the circuitry to an electrical overstress event is helpful. [Figure 34](#) shows the ESD circuits contained in the TLV07 (indicated by the dashed line area). The ESD protection circuitry involves several current-steering diodes connected from the input and output pins and routed back to the internal power-supply lines, where the diodes meet at the power-supply ESD cell, an absorption device, internal to the operational amplifier. This protection circuitry is intended to remain inactive during normal circuit operation.

Feature Description (continued)

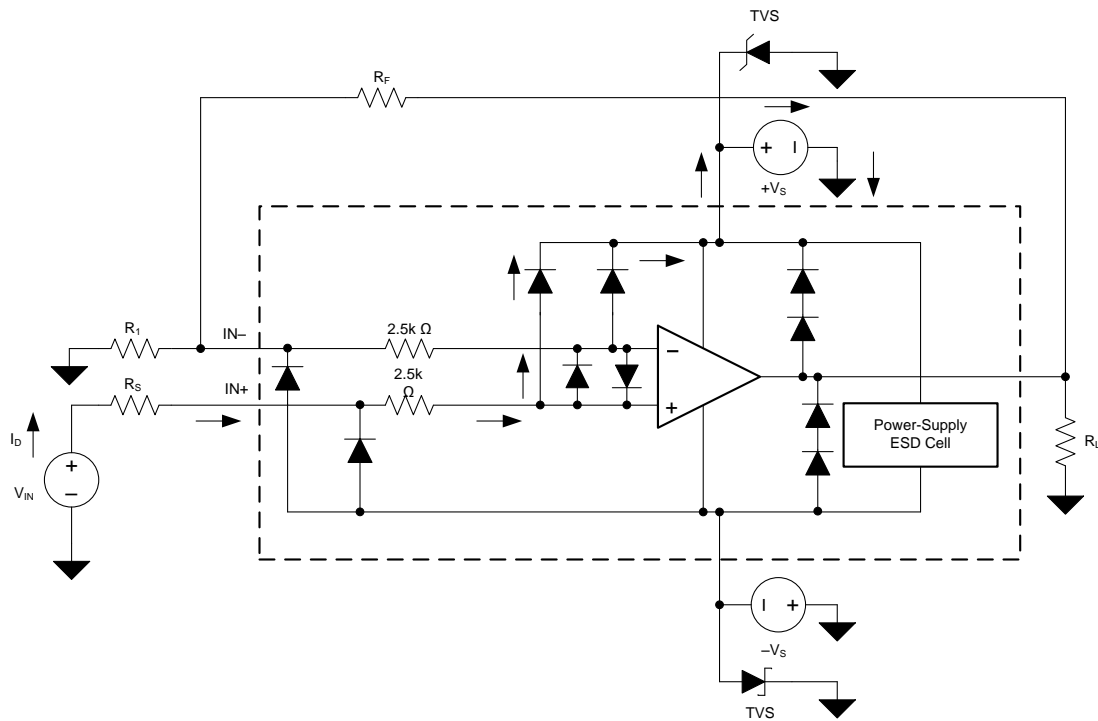

Copyright © 2017, Texas Instruments Incorporated

Figure 34. Equivalent Internal ESD Circuitry Relative to a Typical Circuit Application

An ESD event produces a short-duration, high-voltage pulse that is transformed into a short-duration, high-current pulse when discharging through a semiconductor device. The ESD protection circuits are designed to provide a current path around the operational amplifier core to prevent damage. The energy absorbed by the protection circuitry is then dissipated as heat.

When an ESD voltage develops across two or more amplifier device pins, current flows through one or more steering diodes. Depending on the path that the current takes, the absorption device can activate. The absorption device has a trigger, or threshold voltage, that is above the normal operating voltage of the TLV07, but below the device breakdown voltage level. When this threshold is exceeded, the absorption device quickly activates and clamps the voltage across the supply rails to a safe level.

When the operational amplifier connects into a circuit (see Figure 34), the ESD protection components are intended to remain inactive and do not become involved in the application circuit operation. However, circumstances may arise where an applied voltage exceeds the operating voltage range of a given pin. If this condition occurs, there is a risk that some internal ESD protection circuits can turn on and conduct current. Any such current flow occurs through steering-diode paths and rarely involves the absorption device.

Figure 34 shows a specific example where the input voltage (V_{IN}) exceeds the positive supply voltage ($V+$) by 500 mV or more. Much of what happens in the circuit depends on the supply characteristics. If $V+$ can sink the current, one of the upper input steering diodes conducts and directs current to $V+$. Excessively high current levels can flow with increasingly higher V_{IN} . As a result, the data sheet specifications recommend that applications limit the input current to 10 mA.

If the supply is not capable of sinking the current, V_{IN} sources current to the operational amplifier and becomes the source of positive supply voltage. The danger in this case is that the voltage can rise to levels that exceed the operational amplifier absolute maximum ratings.

Feature Description (continued)

Another common question involves what happens to the amplifier if an input signal is applied to the input when the power supplies ($V+$ or $V-$) are at 0 V. This question depends on the supply characteristic when at 0 V, or at a level below the input signal amplitude. If the supplies appear as high impedance, then the input source supplies the operational amplifier current through the current-steering diodes. This state is not a normal bias condition; most likely, the amplifier does not operate normally. If the supplies are low impedance, then the current through the steering diodes can become quite high. The current level depends on the ability of the input source to deliver current, and any resistance in the input path.

If there is any uncertainty about the ability of the supply to absorb this current, add external Zener diodes to the supply pins; see [Figure 34](#). Select the Zener voltage so that the diode does not turn on during normal operation. However, the Zener voltage must be low enough so that the Zener diode conducts if the supply pin begins to rise above the safe-operating, supply-voltage level.

The TLV07 input pins are protected from excessive differential voltage with back-to-back diodes; see [Figure 34](#). In most circuit applications, the input protection circuitry has no effect. However, in low-gain or $G = 1$ circuits, fast-ramping input signals can forward-bias these diodes because the output of the amplifier cannot respond rapidly enough to the input ramp. If the input signal is fast enough to create this forward-bias condition, limit the input signal current to 10 mA or less. If the input signal current is not inherently limited, use an input series resistor to limit the input signal current.

7.4 Device Functional Modes

7.4.1 Overload Recovery

Overload recovery is defined as the time required for the op amp output to recover from the saturated state to the linear state. The output devices of the op amp enter the saturation region when the output voltage exceeds the rated operating voltage resulting from the high input voltage or the high gain. After the device enters the saturation region, the charge carriers in the output devices must have time to return back to the normal state. After the charge carriers return back to the equilibrium state, the device begins to slew at the normal slew rate. As a result, the propagation delay (in case of an overload condition) is the sum of the overload recovery time and the slew time. The overload recovery time for the TLV07 is approximately 2 μ s.

8 Application and Implementation

NOTE

Information in the following applications sections is not part of the TI component specification, and TI does not warrant its accuracy or completeness. TI's customers are responsible for determining suitability of components for their purposes. Customers should validate and test their design implementation to confirm system functionality.

8.1 Application Information

The TLV07 op amp provides high overall performance in a large number of general-purpose applications. As with all amplifiers, applications with noisy or high-impedance power supplies require decoupling capacitors placed close to the device pins. In most cases, 0.1- μF capacitors are adequate. Follow the additional recommendations in [Layout Guidelines](#) to achieve the maximum performance from this device. Many applications may introduce capacitive loading to the output of the amplifier, potentially causing instability. Add an isolation resistor between the amplifier output and the capacitive load to stabilize the amplifier. [Typical Application](#) shows the design process for selecting this resistor.

8.2 Typical Application

This circuit can drive capacitive loads such as cable shields, reference buffers, MOSFET gates, and diodes. The circuit uses an isolation resistor (R_{ISO}) to stabilize the output of an op amp. R_{ISO} modifies the open-loop gain of the system to ensure the circuit has sufficient phase margin.

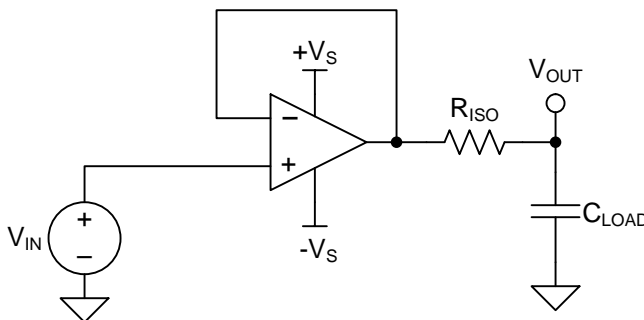

Figure 35. Unity-Gain Buffer With R_{ISO} Stability Compensation

8.2.1 Design Requirements

The design requirements are:

- Supply voltage: 30 V (± 15 V)
- Capacitive loads: 100 pF, 1000 pF, 0.01 μF , 0.1 μF , and 1 μF
- Phase margin: 45° and 60°

8.2.2 Detailed Design Procedure

Figure 35 shows a unity-gain buffer driving a capacitive load. Equation 1 shows the transfer function for the circuit in Figure 35. Figure 35 does not show the open-loop output resistance of the op amp (R_{O}).

$$T(s) = \frac{1 + C_{\text{LOAD}} \times R_{\text{ISO}} \times s}{1 + (R_{\text{O}} + R_{\text{ISO}}) \times C_{\text{LOAD}} \times s} \quad (1)$$

The transfer function shown in Equation 1 has a pole and a zero. $(R_{\text{O}} + R_{\text{ISO}})$ and C_{LOAD} determine the frequency of the pole (f_{p}). The R_{ISO} and C_{LOAD} components determine the frequency of the zero (f_{z}). A stable system is obtained by selecting R_{ISO} such that the rate of closure (ROC) between the open-loop gain (A_{OL}) and $1/\beta$ is 20 dB/decade.

Typical Application (continued)

ROC stability analysis is typically simulated. The validity of the analysis depends on multiple factors, especially the accurate modeling of R_{ISO} . In addition to simulating the ROC, a robust stability analysis includes a measurement of overshoot percentage and ac gain peaking of the circuit using a function generator, oscilloscope, and gain and phase analyzer. These measurements then calculate phase margin. Table 2 shows the overshoot percentage and ac gain peaking that correspond to phase margins of 45° and 60°. For more details on this design and other alternative devices that can be used in place of the TLV07, see [Capacitive Load Drive Solution Using an Isolation Resistor](#)

Table 2. Phase Margin versus Overshoot and AC Gain Peaking

PHASE MARGIN	OVERSHOOT	AC GAIN PEAKING
45°	23.3%	2.35 dB
60°	8.8%	0.28 dB

8.2.3 Application Curve

The values of R_{ISO} that yield phase margins of 45° and 60° for various capacitive loads are determined using the described methodology. Figure 36 shows the results.

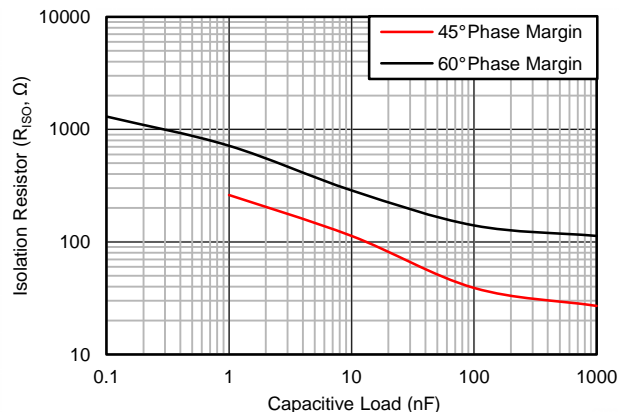

Figure 36. Isolation Resistor Required for Various Capacitive Loads to Achieve a Target Phase Margin

9 Power Supply Recommendations

The TLV07 is specified for operation from 2.7 V to 36 V (± 1.35 V to ± 18 V); many specifications apply from -40°C to $+125^{\circ}\text{C}$. Parameters that can exhibit significant variance with regard to operating voltage or temperature are presented in [Typical Characteristics](#).

CAUTION

Supply voltages larger than 40 V can permanently damage the device; see [Absolute Maximum Ratings](#).

Place 0.1- μF bypass capacitors close to the power-supply pins to reduce errors coupling in from noisy or high-impedance power supplies. For more detailed information on bypass capacitor placement, see [Layout Guidelines](#).

10 Layout

10.1 Layout Guidelines

For best operational performance of the device, use good printed-circuit board (PCB) layout practices, including:

- Noise can propagate into analog circuitry through the power pins of the circuit as a whole and the op amp itself. Bypass capacitors reduce the coupled noise by providing low-impedance power sources local to the analog circuitry.
 - Connect low-ESR, 0.1- μ F ceramic bypass capacitors between each supply pin and ground, placed as close to the device as possible. A single bypass capacitor from V+ to ground is applicable for single-supply applications.
- Separate grounding for analog and digital portions of circuitry is one of the simplest and most-effective methods of noise suppression. One or more layers on multilayer PCBs are typically devoted to ground planes. A ground plane helps distribute heat and reduces EMI noise pickup. Take care to physically separate digital and analog grounds, paying attention to the flow of the ground current.
- In order to reduce parasitic coupling, run the input traces as far away from the supply or output traces as possible. If these traces cannot be kept separate, crossing the sensitive trace perpendicularly is much better than in parallel with the noisy trace.
- Place the external components as close to the device as possible. As shown in [Figure 38](#), keeping R_F and R_G close to the inverting input minimizes parasitic capacitance.
- Keep the length of input traces as short as possible. Always remember that the input traces are the most sensitive part of the circuit.
- Consider a driven, low-impedance guard ring around the critical traces. A guard ring can significantly reduce leakage currents from nearby traces that are at different potentials.

10.2 Layout Example

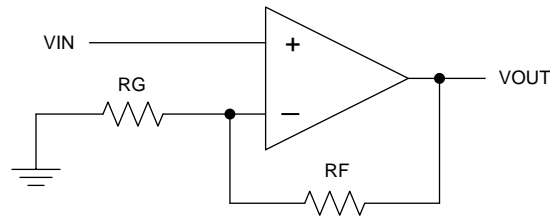

Figure 37. Schematic Representation of a Non-inverting Amplifier

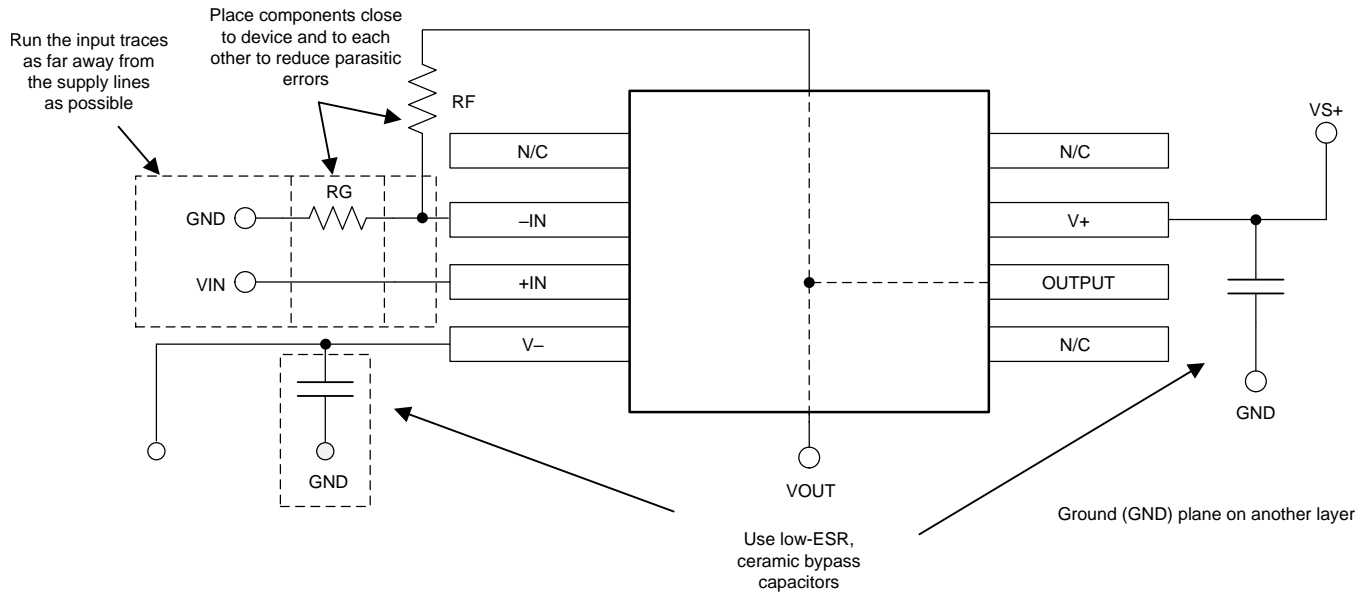

Figure 38. Operational Amplifier Board Layout for a Noninverting Configuration

11 Device and Documentation Support

11.1 Device Support

11.1.1 Third-Party Products Disclaimer

TI'S PUBLICATION OF INFORMATION REGARDING THIRD-PARTY PRODUCTS OR SERVICES DOES NOT CONSTITUTE AN ENDORSEMENT REGARDING THE SUITABILITY OF SUCH PRODUCTS OR SERVICES OR A WARRANTY, REPRESENTATION OR ENDORSEMENT OF SUCH PRODUCTS OR SERVICES, EITHER ALONE OR IN COMBINATION WITH ANY TI PRODUCT OR SERVICE.

11.1.2 Development Support

11.1.2.1 TINA-TI™ (Free Software Download)

TINA™ is a simple, powerful, and easy-to-use circuit simulation program based on a SPICE engine. TINA-TI™ is a free, fully-functional version of the TINA software, preloaded with a library of macro models in addition to a range of both passive and active models. TINA-TI provides all the conventional dc, transient, and frequency domain analysis of SPICE, as well as additional design capabilities.

Available as a [free download](#) from the WEBENCH® Design Center, TINA-TI offers extensive post-processing capability that allows users to format results in a variety of ways. Virtual instruments offer the ability to select input waveforms and probe circuit nodes, voltages, and waveforms, creating a dynamic quick-start tool.

NOTE

These files require that either the TINA software (from DesignSoft™) or TINA-TI software be installed. Download the free TINA-TI software from the [TINA-TI folder](#).

11.1.2.2 DIP Adapter EVM

The [DIP Adapter EVM](#) tool provides an easy, low-cost way to prototype small surface mount devices. The evaluation tool uses these TI packages: D or U (SOIC-8), PW (TSSOP-8), DGK (MSOP-8), DBV (SOT23-6, SOT23-5 and SOT23-3), DCK (SC70-6 and SC70-5), and DRL (SOT563-6). The DIP Adapter EVM may also be used with terminal strips or may be wired directly to existing circuits.

11.1.2.3 Universal Op Amp EVM

The [Universal Op Amp EVM](#) is a series of general-purpose, blank circuit boards that simplify prototyping circuits for a variety of device package types. The evaluation module board design allows many different circuits to be constructed easily and quickly. Five models are offered, with each model intended for a specific package type. PDIP, SOIC, MSOP, TSSOP and SOT-23 packages are all supported.

NOTE

These boards are unpopulated, so users must provide their own devices. TI recommends requesting several op amp device samples when ordering the Universal Op Amp EVM.

11.1.2.4 TI Precision Designs

TI Precision Designs are analog solutions created by TI's precision analog applications experts and offer the theory of operation, component selection, simulation, complete PCB schematic and layout, bill of materials, and measured performance of many useful circuits. TI Precision Designs are available online at <http://www.ti.com/ww/en/analog/precision-designs/>.

Device Support (continued)

11.1.2.5 WEBENCH® Filter Designer

WEBENCH® Filter Designer is a simple, powerful, and easy-to-use active filter design program. The WEBENCH® Filter Designer allows the user to create optimized filter designs using a selection of TI operational amplifiers and passive components from TI's vendor partners.

Available as a web-based tool from the WEBENCH® Design Center, WEBENCH® Filter Designer allows the user to design, optimize, and simulate complete multistage active filter solutions within minutes.

11.2 Documentation Support

11.2.1 Related Documentation

For related documentation, see the following (available for download from www.ti.com) :

- [Feedback Plots Define Op Amp AC Performance](#)
- [Capacitive Load Drive Solution Using an Isolation Resistor](#)

11.3 Community Resources

The following links connect to TI community resources. Linked contents are provided "AS IS" by the respective contributors. They do not constitute TI specifications and do not necessarily reflect TI's views; see TI's [Terms of Use](#).

TI E2E™ Online Community *TI's Engineer-to-Engineer (E2E) Community*. Created to foster collaboration among engineers. At e2e.ti.com, you can ask questions, share knowledge, explore ideas and help solve problems with fellow engineers.

Design Support *TI's Design Support* Quickly find helpful E2E forums along with design support tools and contact information for technical support.

11.4 Trademarks

TINA-TI, E2E are trademarks of Texas Instruments.
 WEBENCH is a registered trademark of Texas Instruments.
 TINA, DesignSoft are trademarks of DesignSoft, Inc.

11.5 Electrostatic Discharge Caution



These devices have limited built-in ESD protection. The leads should be shorted together or the device placed in conductive foam during storage or handling to prevent electrostatic damage to the MOS gates.

11.6 Glossary

[SLYZ022](#) — *TI Glossary*.

This glossary lists and explains terms, acronyms, and definitions.

12 Mechanical, Packaging, and Orderable Information

The following pages include mechanical, packaging, and orderable information. This information is the most current data available for the designated devices. This data is subject to change without notice and revision of this document. For browser-based versions of this data sheet, refer to the left-hand navigation.

PACKAGING INFORMATION

Orderable Device	Status (1)	Package Type	Package Drawing	Pins	Package Qty	Eco Plan (2)	Lead finish/ Ball material (6)	MSL Peak Temp (3)	Op Temp (°C)	Device Marking (4/5)	Samples
TLV07IDR	ACTIVE	SOIC	D	8	2500	RoHS & Green	NIPDAU	Level-2-260C-1 YEAR	-40 to 125	TLV07	Samples

(1) The marketing status values are defined as follows:

ACTIVE: Product device recommended for new designs.

LIFEBUY: TI has announced that the device will be discontinued, and a lifetime-buy period is in effect.

NRND: Not recommended for new designs. Device is in production to support existing customers, but TI does not recommend using this part in a new design.

PREVIEW: Device has been announced but is not in production. Samples may or may not be available.

OBSOLETE: TI has discontinued the production of the device.

(2) **RoHS:** TI defines "RoHS" to mean semiconductor products that are compliant with the current EU RoHS requirements for all 10 RoHS substances, including the requirement that RoHS substance do not exceed 0.1% by weight in homogeneous materials. Where designed to be soldered at high temperatures, "RoHS" products are suitable for use in specified lead-free processes. TI may reference these types of products as "Pb-Free".

RoHS Exempt: TI defines "RoHS Exempt" to mean products that contain lead but are compliant with EU RoHS pursuant to a specific EU RoHS exemption.

Green: TI defines "Green" to mean the content of Chlorine (Cl) and Bromine (Br) based flame retardants meet JS709B low halogen requirements of <=1000ppm threshold. Antimony trioxide based flame retardants must also meet the <=1000ppm threshold requirement.

(3) MSL, Peak Temp. - The Moisture Sensitivity Level rating according to the JEDEC industry standard classifications, and peak solder temperature.

(4) There may be additional marking, which relates to the logo, the lot trace code information, or the environmental category on the device.

(5) Multiple Device Markings will be inside parentheses. Only one Device Marking contained in parentheses and separated by a "-" will appear on a device. If a line is indented then it is a continuation of the previous line and the two combined represent the entire Device Marking for that device.

(6) Lead finish/Ball material - Orderable Devices may have multiple material finish options. Finish options are separated by a vertical ruled line. Lead finish/Ball material values may wrap to two lines if the finish value exceeds the maximum column width.

Important Information and Disclaimer: The information provided on this page represents TI's knowledge and belief as of the date that it is provided. TI bases its knowledge and belief on information provided by third parties, and makes no representation or warranty as to the accuracy of such information. Efforts are underway to better integrate information from third parties. TI has taken and continues to take reasonable steps to provide representative and accurate information but may not have conducted destructive testing or chemical analysis on incoming materials and chemicals. TI and TI suppliers consider certain information to be proprietary, and thus CAS numbers and other limited information may not be available for release.

In no event shall TI's liability arising out of such information exceed the total purchase price of the TI part(s) at issue in this document sold by TI to Customer on an annual basis.

TAPE AND REEL INFORMATION

QUADRANT ASSIGNMENTS FOR PIN 1 ORIENTATION IN TAPE

*All dimensions are nominal

Device	Package Type	Package Drawing	Pins	SPQ	Reel Diameter (mm)	Reel Width W1 (mm)	A0 (mm)	B0 (mm)	K0 (mm)	P1 (mm)	W (mm)	Pin1 Quadrant
TLV07IDR	SOIC	D	8	2500	330.0	12.5	6.4	5.2	2.1	8.0	12.0	Q1

TAPE AND REEL BOX DIMENSIONS

*All dimensions are nominal

Device	Package Type	Package Drawing	Pins	SPQ	Length (mm)	Width (mm)	Height (mm)
TLV07IDR	SOIC	D	8	2500	353.0	353.0	32.0



D0008A

PACKAGE OUTLINE

SOIC - 1.75 mm max height

SMALL OUTLINE INTEGRATED CIRCUIT



4214825/C 02/2019

NOTES:

- Linear dimensions are in inches [millimeters]. Dimensions in parenthesis are for reference only. Controlling dimensions are in inches. Dimensioning and tolerancing per ASME Y14.5M.
- This drawing is subject to change without notice.
- This dimension does not include mold flash, protrusions, or gate burrs. Mold flash, protrusions, or gate burrs shall not exceed .006 [0.15] per side.
- This dimension does not include interlead flash.
- Reference JEDEC registration MS-012, variation AA.

EXAMPLE BOARD LAYOUT

D0008A

SOIC - 1.75 mm max height

SMALL OUTLINE INTEGRATED CIRCUIT



LAND PATTERN EXAMPLE
 EXPOSED METAL SHOWN
 SCALE:8X



SOLDER MASK DETAILS

4214825/C 02/2019

NOTES: (continued)

- 6. Publication IPC-7351 may have alternate designs.
- 7. Solder mask tolerances between and around signal pads can vary based on board fabrication site.

EXAMPLE STENCIL DESIGN

D0008A

SOIC - 1.75 mm max height

SMALL OUTLINE INTEGRATED CIRCUIT



SOLDER PASTE EXAMPLE
BASED ON .005 INCH [0.125 MM] THICK STENCIL
SCALE:8X

4214825/C 02/2019

NOTES: (continued)

8. Laser cutting apertures with trapezoidal walls and rounded corners may offer better paste release. IPC-7525 may have alternate design recommendations.
9. Board assembly site may have different recommendations for stencil design.

IMPORTANT NOTICE AND DISCLAIMER

TI PROVIDES TECHNICAL AND RELIABILITY DATA (INCLUDING DATA SHEETS), DESIGN RESOURCES (INCLUDING REFERENCE DESIGNS), APPLICATION OR OTHER DESIGN ADVICE, WEB TOOLS, SAFETY INFORMATION, AND OTHER RESOURCES "AS IS" AND WITH ALL FAULTS, AND DISCLAIMS ALL WARRANTIES, EXPRESS AND IMPLIED, INCLUDING WITHOUT LIMITATION ANY IMPLIED WARRANTIES OF MERCHANTABILITY, FITNESS FOR A PARTICULAR PURPOSE OR NON-INFRINGEMENT OF THIRD PARTY INTELLECTUAL PROPERTY RIGHTS.

These resources are intended for skilled developers designing with TI products. You are solely responsible for (1) selecting the appropriate TI products for your application, (2) designing, validating and testing your application, and (3) ensuring your application meets applicable standards, and any other safety, security, regulatory or other requirements.

These resources are subject to change without notice. TI grants you permission to use these resources only for development of an application that uses the TI products described in the resource. Other reproduction and display of these resources is prohibited. No license is granted to any other TI intellectual property right or to any third party intellectual property right. TI disclaims responsibility for, and you will fully indemnify TI and its representatives against, any claims, damages, costs, losses, and liabilities arising out of your use of these resources.

TI's products are provided subject to [TI's Terms of Sale](#) or other applicable terms available either on [ti.com](https://www.ti.com) or provided in conjunction with such TI products. TI's provision of these resources does not expand or otherwise alter TI's applicable warranties or warranty disclaimers for TI products.

TI objects to and rejects any additional or different terms you may have proposed.

Mailing Address: Texas Instruments, Post Office Box 655303, Dallas, Texas 75265
Copyright © 2025, Texas Instruments Incorporated