

## NANOPOWER PUSH-PULL OUTPUT COMPARATOR

### FEATURES

- **Controlled Baseline**
  - One Assembly/Test Site, One Fabrication Site
- **Extended Temperature Performance of  $-40^{\circ}\text{C}$  to  $125^{\circ}\text{C}$**
- **Enhanced Diminishing Manufacturing Sources (DMS) Support**
- **Enhanced Product-Change Notification**
- **Qualification Pedigree†**
- **Low Supply Current . . . 560 nA**
- **Input Common-Mode Range Exceeds the Rails . . .  $-0.1\text{ V}$  to  $V_{CC} + 5\text{ V}$**
- **Supply Voltage Range . . . 2.7 V to 16 V**
- **Reverse Battery Protection Up to 18 V**
- **Push-Pull CMOS Output Stage**
- **Ultrasmall Packaging**
  - 5-Pin SOT-23
- **Universal Op-Amp EVM (Reference SLOU060 for more information)**

† Component qualification in accordance with JEDEC and industry standards to ensure reliable operation over an extended temperature range. This includes, but is not limited to, Highly Accelerated Stress Test (HAST) or biased 85/85, temperature cycle, autoclave or unbiased HAST, electromigration, bond intermetallic life, and mold compound life. Such qualification testing should not be viewed as justifying use of this component beyond specified performance and environmental limits.

### APPLICATIONS

- **Portable Battery Monitoring**
- **Security Detection Systems**

### DESCRIPTION

The TLV3701 is part of Texas Instruments' first family of nanopower comparator with only 560 nA supply current, which make this device ideal for low power applications.

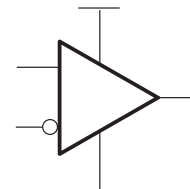

**SUPPLY CURRENT vs SUPPLY VOLTAGE**

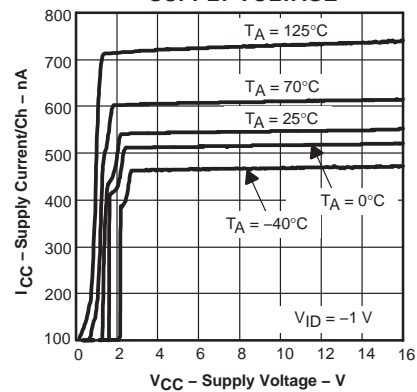

### high side voltage sense circuit

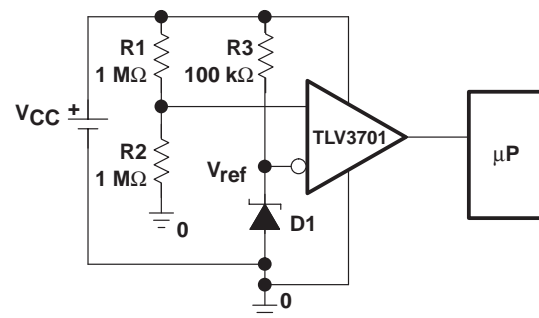

Please be aware that an important notice concerning availability, standard warranty, and use in critical applications of Texas Instruments semiconductor products and disclaimers thereto appears at the end of this data sheet.

**DESCRIPTION (continued)**

The TLV3701 has a minimum operating supply voltage of 2.7 V over the extended temperature range  $T_A = -40^{\circ}\text{C}$  to  $125^{\circ}\text{C}$ , while having an input common-mode range of  $-0.1$  to  $V_{CC} + 5$  V. The low supply current makes it an ideal choice for battery powered portable applications where quiescent current is the primary concern. Reverse battery protection guards the amplifier from an over-current condition due to improper battery installation. For harsh environments, the inputs can be taken 5 V above the positive supply rail without damage to the device.

This device is available in the small SOT-23 package. Other package options may be made available upon request.

**A SELECTION OF OUTPUT COMPARATORST**

DEVICE	V <sub>CC</sub> (V)	V <sub>IO</sub> (μV)	I <sub>CC/Ch</sub> (μA)	I <sub>B</sub> (pA)	t <sub>PLH</sub> (μs)	t <sub>PHL</sub> (μs)	t <sub>f</sub> (μs)	t <sub>r</sub> (μs)	RAIL-TO-RAIL	OUTPUT STAGE
TLV370x	2.5 – 16	250	0.56	80	56	83	22	8	I	PP
TLV340x	2.5 – 16	250	0.47	80	55	30	5	–	I	OD
TLC3702/4	3 – 16	1200	9	5	1.1	0.65	0.5	0.125	–	PP
TLC393/339	3 – 16	1400	11	5	1.1	0.55	0.22	–	–	OD
TLC372/4	3 – 16	1000	75	5	0.65	0.65	–	–	–	OD

† All specifications are typical values measured at 5 V.

**AVAILABLE OPTIONST**

T <sub>A</sub>	V <sub>IO</sub> max AT 25°C	PACKAGED DEVICES	
		SOT-23 (DBV)‡	SYMBOL
-40°C to 125°C	5000 μV	TLV3701QDBVREP	VBCE

† Contact the local TI sales office for availability of other package options.

‡ This package is only available taped and reeled with standard quantities of 3000 pieces per reel.

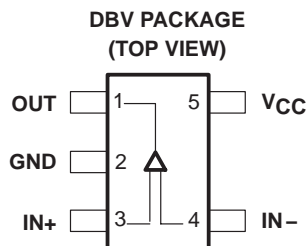

**absolute maximum ratings over operating free-air temperature range (unless otherwise noted)†**

Supply voltage, $V_{CC}$ (see Note 1)	17 V
Differential input voltage, $V_{ID}$	$\pm 20$ V
Input voltage range, $V_I$ (see Notes 1 and 2)	0 to $V_{CC} + 5$ V
Input current range, $I_I$	$\pm 10$ mA
Output current range, $I_O$	$\pm 10$ mA
Continuous total power dissipation	See Dissipation Rating Table
Operating free-air temperature range, $T_A$	$-40^\circ\text{C}$ to $125^\circ\text{C}$
Maximum junction temperature, $T_J$	$150^\circ\text{C}$
Storage temperature range, $T_{stg}$	$-65^\circ\text{C}$ to $150^\circ\text{C}$
Lead temperature 1,6 mm (1/16 inch) from case for 10 seconds	$260^\circ\text{C}$

† Stresses beyond those listed under “absolute maximum ratings” may cause permanent damage to the device. These are stress ratings only, and functional operation of the device at these or any other conditions beyond those indicated under “recommended operating conditions” is not implied. Exposure to absolute-maximum-rated conditions for extended periods may affect device reliability.

- NOTES: 1. All voltage values, except differential voltages, are with respect to GND.  
 2. Input voltage range is limited to 20 V max or  $V_{CC} + 5$  V, whichever is smaller.

**DISSIPATION RATING TABLE**

PACKAGE	$\theta_{JC}$ ( $^\circ\text{C}/\text{W}$ )	$\theta_{JA}$ ( $^\circ\text{C}/\text{W}$ )	$T_A \leq 25^\circ\text{C}$ POWER RATING	$T_A = 125^\circ\text{C}$ POWER RATING
DBV	55	324.1	385 mW	77.1 mW

**recommended operating conditions**

		MIN	MAX	UNIT
Supply voltage, $V_{CC}$	Single supply	2.7	16	V
	Split supply	$\pm 1.35$	$\pm 8$	
Common-mode input voltage range, $V_{ICR}$		-0.1	$V_{CC}+5$	V
Operating free-air temperature, $T_A$		-40	125	$^\circ\text{C}$

**electrical characteristics at specified operating free-air temperature,  $V_{CC} = 2.7$  V, 5 V, 15 V (unless otherwise noted)**

**dc performance**

PARAMETER	TEST CONDITIONS	$T_A^\dagger$	MIN	TYP	MAX	UNIT
$V_{IO}$ Input offset voltage	$V_{IC} = V_{CC}/2, R_S = 50 \Omega$	25 $^\circ\text{C}$		250	5000	$\mu\text{V}$
		Full range			7000	
$\alpha_{VIO}$ Offset voltage drift		25 $^\circ\text{C}$		3		$\mu\text{V}/^\circ\text{C}$
CMRR Common-mode rejection ratio	$V_{IC} = 0$ to 2.7 V, $R_S = 50 \Omega$	25 $^\circ\text{C}$	55	72		dB
		Full range	50			
	$V_{IC} = 0$ to 5 V, $R_S = 50 \Omega$	25 $^\circ\text{C}$	60	76		
		Full range	55			
	$V_{IC} = 0$ to 15 V, $R_S = 50 \Omega$	25 $^\circ\text{C}$	65	88		
		Full range	60			
$A_{VD}$ Large-signal differential voltage amplification		25 $^\circ\text{C}$		1000		V/mV

† Full range is  $-40^\circ\text{C}$  to  $125^\circ\text{C}$  for Q suffix.

**electrical characteristics at specified operating free-air temperature,  $V_{CC} = 2.7\text{ V}, 5\text{ V}, 15\text{ V}$  (unless otherwise noted) (continued)**

**input/output characteristics**

PARAMETER		TEST CONDITIONS	$T_A$ †	MIN	TYP	MAX	UNIT
$I_{IO}$	Input offset current	$V_{IC} = V_{CC}/2, R_S = 50\ \Omega$	25°C		20	100	pA
			Full range			1000	
$I_{IB}$	Input bias current		25°C		80	250	pA
			Full range			2000	
$r_{i(d)}$	Differential input resistance		25°C		300		M $\Omega$
$V_{OH}$	High-level output voltage	$V_{IC} = V_{CC}/2, I_{OH} = 2\ \mu\text{A}, V_{ID} = 1\text{ V}$	25°C		$V_{CC} - 0.08$		mV
			Full range		$V_{CC} - 320$		
		$V_{IC} = V_{CC}/2, I_{OH} = -50\ \mu\text{A}, V_{ID} = 1\text{ V}$			$V_{CC} - 450$		
$V_{OL}$	Low-level output voltage	$V_{IC} = V_{CC}/2, I_{OH} = 2\ \mu\text{A}, V_{ID} = -1\text{ V}$	25°C		8		mV
			Full range		80	200	
		$V_{IC} = V_{CC}/2, I_{OH} = 50\ \mu\text{A}, V_{ID} = -1\text{ V}$				300	

† Full range is -40°C to 125°C for Q suffix.

**power supply**

PARAMETER		TEST CONDITIONS	$T_A$ †	MIN	TYP	MAX	UNIT
$I_{CC}$	Supply current	Output state high	25°C		560	800	nA
			Full range			1200	
PSRR	Power supply rejection ratio	$V_{IC} = V_{CC}/2\text{ V},$ No load	$V_{CC} = 2.7\text{ V to }5\text{ V}$	25°C	75	100	dB
				Full range	70		
			$V_{CC} = 5\text{ V to }15\text{ V}$	25°C	85	105	
				Full range	80		

† Full range is -40°C to 125°C for Q suffix.

**switching characteristics at recommended operating conditions (unless otherwise noted)**

PARAMETER		TEST CONDITIONS	MIN	TYP	MAX	UNIT
$t_{(PLH)}$	Propagation response time, low-to-high-level output (see Note 3)	$f = 1\text{ kHz},$ $V_{STEP} = 100\text{ mV},$ $C_L = 10\text{ pF},$ $V_{CC} = 2.7\text{ V}$	Overdrive = 2 mV		240	$\mu\text{s}$
			Overdrive = 10 mV		64	
			Overdrive = 50 mV		36	
$t_{(PHL)}$	Propagation response time, high-to-low-level output (see Note 3)		Overdrive = 2 mV		167	
			Overdrive = 10 mV		67	
			Overdrive = 50 mV		37	
$t_r$	Rise time	$C_L = 10\text{ pF}, V_{CC} = 2.7\text{ V}$		7	$\mu\text{s}$	
$t_f$	Fall time	$C_L = 10\text{ pF}, V_{CC} = 2.7\text{ V}$		9	$\mu\text{s}$	

NOTE 3: The response time specified is the interval between the input step function and the instant when the output crosses 1.4 V. Propagation responses are longer at higher supply voltages, refer to Figures 11–16 for further details.

TYPICAL CHARACTERISTICS

Table of Graphs

			FIGURE
	Input bias/offset current	vs Free-air temperature	1
$V_{OL}$	Low-level output voltage	vs Low-level output current	2, 4, 6
$V_{OH}$	High-level output voltage	vs High-level output current	3, 5, 7
$I_{CC}$	Supply current	vs Supply voltage	8
		vs Free-air temperature	9
	Output fall time/rise time	vs Supply voltage	10
	Low-to-high level output response for various input overdrives		11, 13, 15
	High-to-low level output response for various input overdrives		12, 14, 16

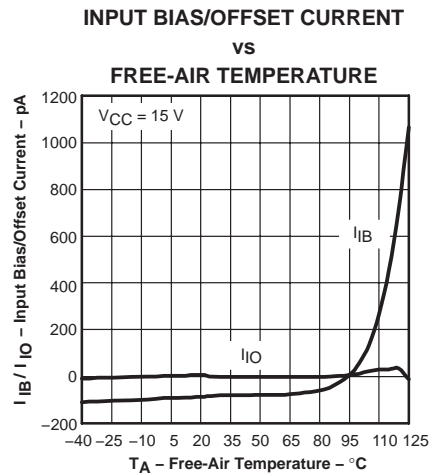

Figure 1

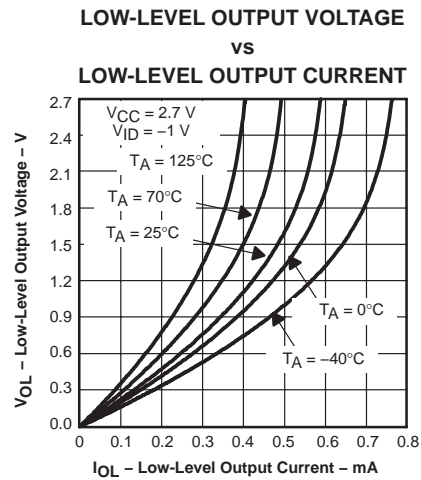

Figure 2

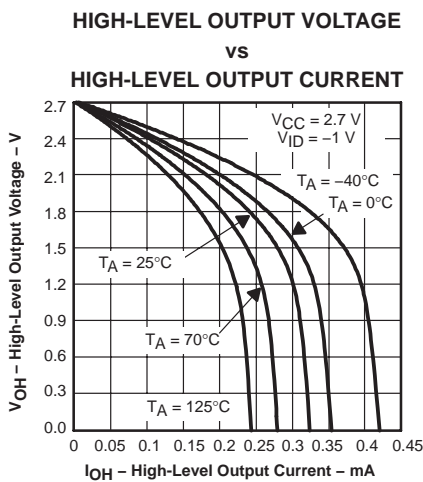

Figure 3

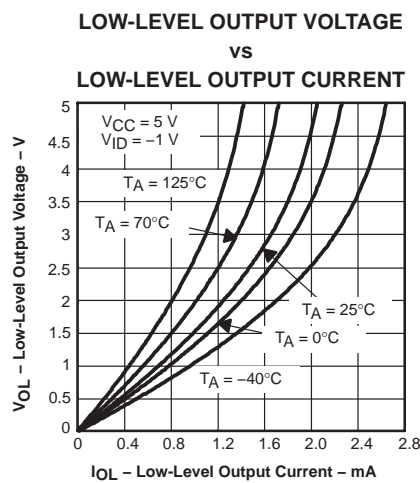

Figure 4

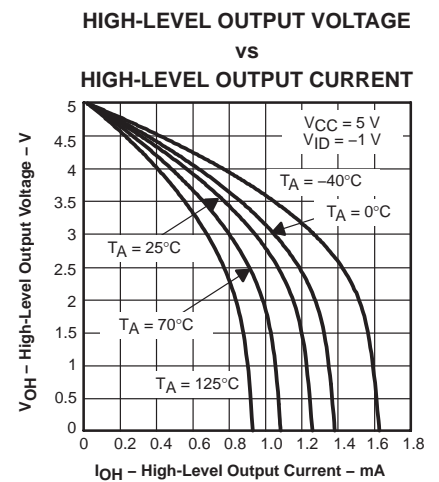

Figure 5

TYPICAL CHARACTERISTICS

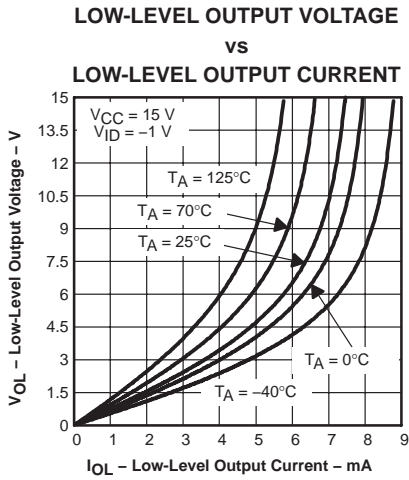

Figure 6

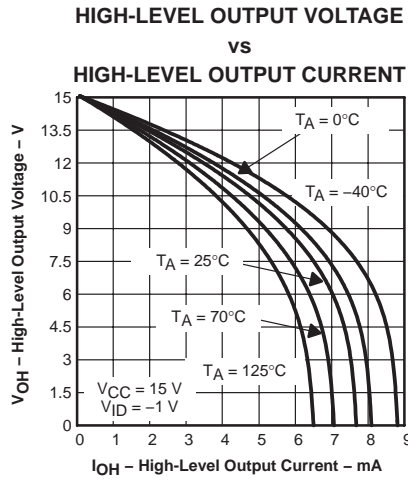

Figure 7

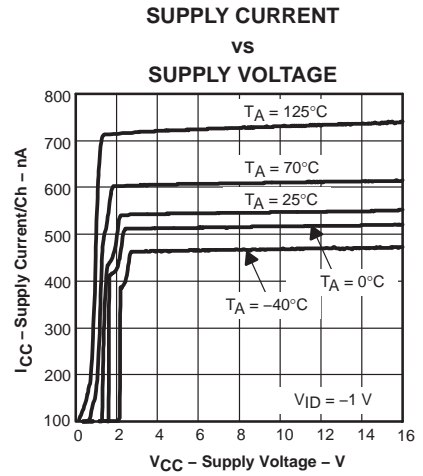

Figure 8

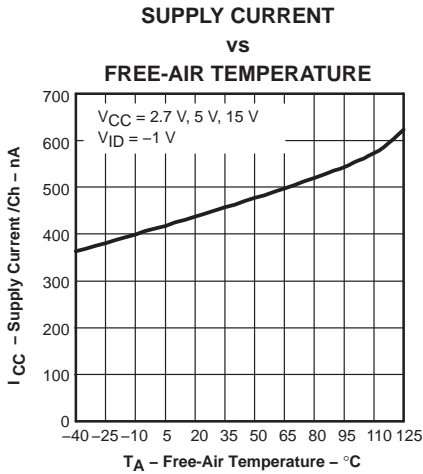

Figure 9

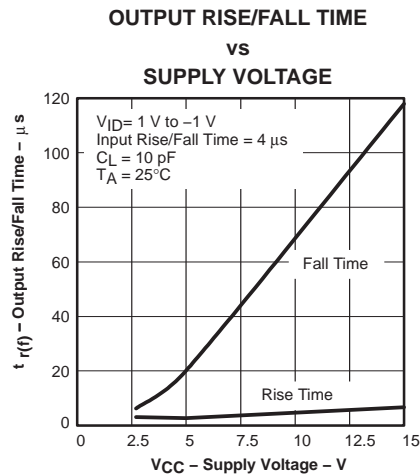

Figure 10

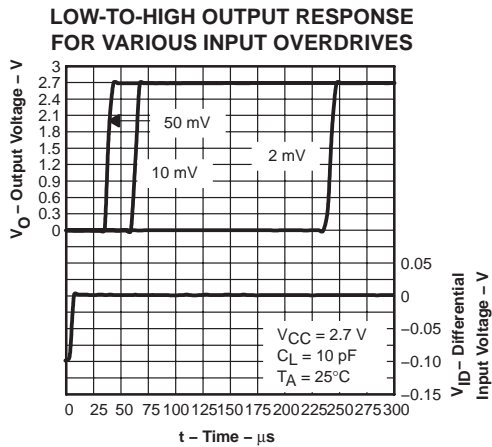

Figure 11

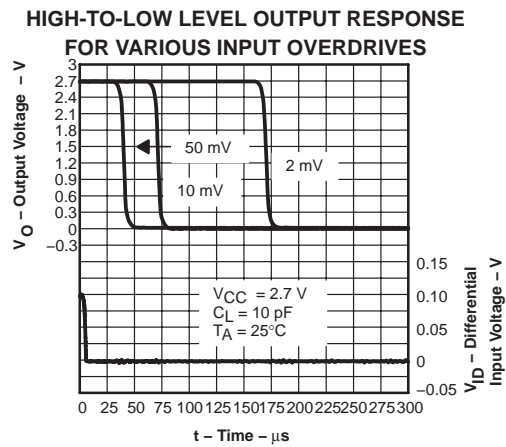

Figure 12

TYPICAL CHARACTERISTICS

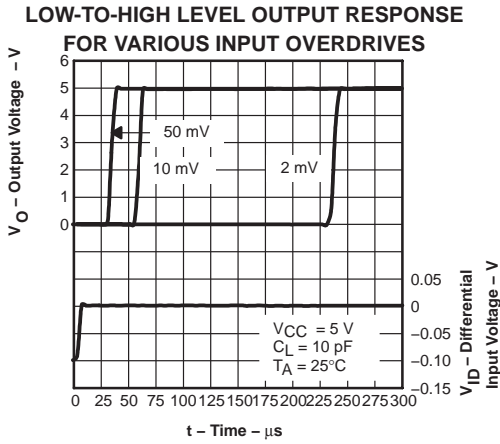

Figure 13

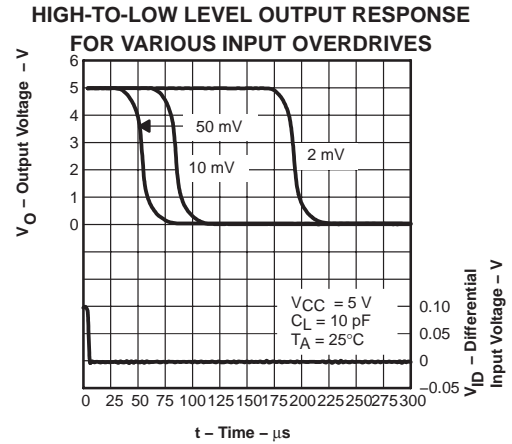

Figure 14

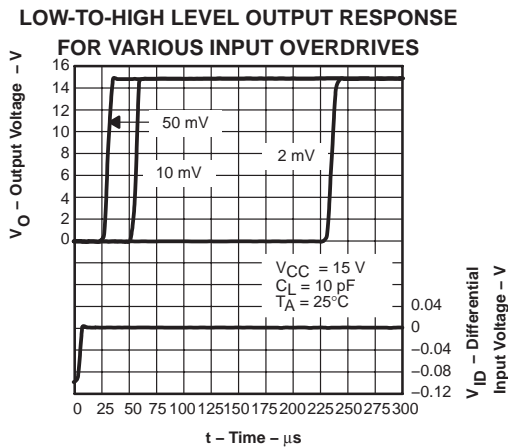

Figure 15

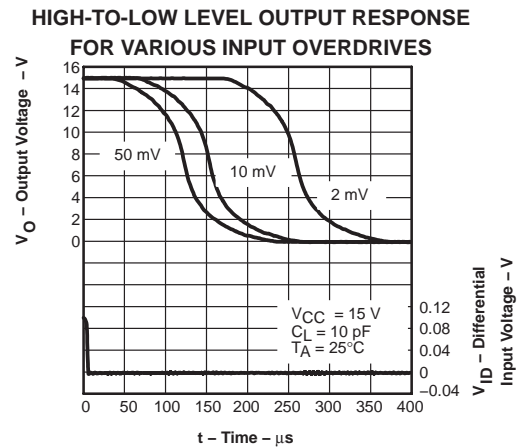

Figure 16

**PACKAGING INFORMATION**

Orderable Device	Status (1)	Package Type	Package Drawing	Pins	Package Qty	Eco Plan (2)	Lead finish/ Ball material (6)	MSL Peak Temp (3)	Op Temp (°C)	Device Marking (4/5)	Samples
TLV3701QDBVREP	ACTIVE	SOT-23	DBV	5	3000	RoHS & Green	NIPDAU	Level-1-260C-UNLIM	-40 to 125	VBCQ	<b>Samples</b>
V62/04726-01XE	ACTIVE	SOT-23	DBV	5	3000	RoHS & Green	NIPDAU	Level-1-260C-UNLIM	-40 to 125	VBCQ	<b>Samples</b>

(1) The marketing status values are defined as follows:

**ACTIVE:** Product device recommended for new designs.

**LIFEBUY:** TI has announced that the device will be discontinued, and a lifetime-buy period is in effect.

**NRND:** Not recommended for new designs. Device is in production to support existing customers, but TI does not recommend using this part in a new design.

**PREVIEW:** Device has been announced but is not in production. Samples may or may not be available.

**OBSOLETE:** TI has discontinued the production of the device.

(2) **RoHS:** TI defines "RoHS" to mean semiconductor products that are compliant with the current EU RoHS requirements for all 10 RoHS substances, including the requirement that RoHS substance do not exceed 0.1% by weight in homogeneous materials. Where designed to be soldered at high temperatures, "RoHS" products are suitable for use in specified lead-free processes. TI may reference these types of products as "Pb-Free".

**RoHS Exempt:** TI defines "RoHS Exempt" to mean products that contain lead but are compliant with EU RoHS pursuant to a specific EU RoHS exemption.

**Green:** TI defines "Green" to mean the content of Chlorine (Cl) and Bromine (Br) based flame retardants meet JS709B low halogen requirements of <=1000ppm threshold. Antimony trioxide based flame retardants must also meet the <=1000ppm threshold requirement.

(3) MSL, Peak Temp. - The Moisture Sensitivity Level rating according to the JEDEC industry standard classifications, and peak solder temperature.

(4) There may be additional marking, which relates to the logo, the lot trace code information, or the environmental category on the device.

(5) Multiple Device Markings will be inside parentheses. Only one Device Marking contained in parentheses and separated by a "~" will appear on a device. If a line is indented then it is a continuation of the previous line and the two combined represent the entire Device Marking for that device.

(6) Lead finish/Ball material - Orderable Devices may have multiple material finish options. Finish options are separated by a vertical ruled line. Lead finish/Ball material values may wrap to two lines if the finish value exceeds the maximum column width.

**Important Information and Disclaimer:**The information provided on this page represents TI's knowledge and belief as of the date that it is provided. TI bases its knowledge and belief on information provided by third parties, and makes no representation or warranty as to the accuracy of such information. Efforts are underway to better integrate information from third parties. TI has taken and continues to take reasonable steps to provide representative and accurate information but may not have conducted destructive testing or chemical analysis on incoming materials and chemicals. TI and TI suppliers consider certain information to be proprietary, and thus CAS numbers and other limited information may not be available for release.

In no event shall TI's liability arising out of such information exceed the total purchase price of the TI part(s) at issue in this document sold by TI to Customer on an annual basis.



**OTHER QUALIFIED VERSIONS OF TLV3701-EP :**

- Catalog: [TLV3701](#)
- Automotive: [TLV3701-Q1](#)

## NOTE: Qualified Version Definitions:

- Catalog - TI's standard catalog product
- Automotive - Q100 devices qualified for high-reliability automotive applications targeting zero defects

## TAPE AND REEL INFORMATION



### QUADRANT ASSIGNMENTS FOR PIN 1 ORIENTATION IN TAPE



\*All dimensions are nominal

Device	Package Type	Package Drawing	Pins	SPQ	Reel Diameter (mm)	Reel Width W1 (mm)	A0 (mm)	B0 (mm)	K0 (mm)	P1 (mm)	W (mm)	Pin1 Quadrant
TLV3701QDBVREP	SOT-23	DBV	5	3000	180.0	9.0	3.15	3.2	1.4	4.0	8.0	Q3

**TAPE AND REEL BOX DIMENSIONS**

\*All dimensions are nominal

Device	Package Type	Package Drawing	Pins	SPQ	Length (mm)	Width (mm)	Height (mm)
TLV3701QDBVREP	SOT-23	DBV	5	3000	182.0	182.0	20.0

## IMPORTANT NOTICE AND DISCLAIMER

TI PROVIDES TECHNICAL AND RELIABILITY DATA (INCLUDING DATASHEETS), DESIGN RESOURCES (INCLUDING REFERENCE DESIGNS), APPLICATION OR OTHER DESIGN ADVICE, WEB TOOLS, SAFETY INFORMATION, AND OTHER RESOURCES "AS IS" AND WITH ALL FAULTS, AND DISCLAIMS ALL WARRANTIES, EXPRESS AND IMPLIED, INCLUDING WITHOUT LIMITATION ANY IMPLIED WARRANTIES OF MERCHANTABILITY, FITNESS FOR A PARTICULAR PURPOSE OR NON-INFRINGEMENT OF THIRD PARTY INTELLECTUAL PROPERTY RIGHTS.

These resources are intended for skilled developers designing with TI products. You are solely responsible for (1) selecting the appropriate TI products for your application, (2) designing, validating and testing your application, and (3) ensuring your application meets applicable standards, and any other safety, security, or other requirements. These resources are subject to change without notice. TI grants you permission to use these resources only for development of an application that uses the TI products described in the resource. Other reproduction and display of these resources is prohibited. No license is granted to any other TI intellectual property right or to any third party intellectual property right. TI disclaims responsibility for, and you will fully indemnify TI and its representatives against, any claims, damages, costs, losses, and liabilities arising out of your use of these resources.

TI's products are provided subject to TI's Terms of Sale (<https://www.ti.com/legal/termsofsale.html>) or other applicable terms available either on [ti.com](https://www.ti.com) or provided in conjunction with such TI products. TI's provision of these resources does not expand or otherwise alter TI's applicable warranties or warranty disclaimers for TI products.

Mailing Address: Texas Instruments, Post Office Box 655303, Dallas, Texas 75265  
Copyright © 2021, Texas Instruments Incorporated