

TLV759P 1-A High Accuracy Adjustable LDO in a Small Size Package

1 Features

- Input Voltage Range: 1.5 V to 6.0 V
- Adjustable Output Voltage:
 - 0.55 V to 5.5 V
- Very Low Dropout:
 - 225 mV (max) at 1 A (3.3 V_{OUT})
- High Output Accuracy:
 - 0.7%, Typical
 - 1%, Maximum Over Temperature (85°C)
- I_Q: 25 µA (Typical)
- Built-In Soft-Start With Monotonic V_{OUT} Rise
- Package:
 - 2-mm × 2-mm 6-Pin WSON (DRV)
- Active Output Discharge

2 Applications

- Set-Top Boxes, Gaming Consoles
- Home Theater and Entertainment
- Desktops, Notebooks, Ultrabooks
- Printers
- Servers
- Thermostat and Lighting Controls
- Electronic Point of Sale (EPOS)

3 Description

The TLV759P is an adjustable 1-A low-dropout (LDO) regulator. This device is available in a small, 6-pin, 2-mm × 2-mm WSON package and consumes very low quiescent current and provides fast line and load transient performance. The TLV759P features an ultra-low dropout of 225 mV at 1 A that can help improve the power efficiency of the system.

The TLV759P is optimized for a wide variety of applications by supporting an input voltage range from 1.5 V to 6.0 V and an externally adjustable output range of 0.55 V to 5.5 V. The low output voltage enables this LDO to power the modern microcontrollers with lower core voltages. Additionally, the TLV759P has a low I_Q with enable functionality to minimize standby power. This device features an internal soft-start to lower the inrush current, which provides a controlled voltage to the load and minimizes the input voltage drop during start up.

The TLV759P is stable with small ceramic output capacitors, allowing for a small overall solution size. A precision band-gap and error amplifier provides a high accuracy of 0.7% max at 25°C and 1% max over temperature (85°C). This device includes integrated thermal shutdown, current limit, and undervoltage lockout (UVLO) features. The TLV759P has an internal foldback current limit that helps reduce the thermal dissipation during short-circuit events.

Device Information⁽¹⁾

PART NUMBER	PACKAGE	BODY SIZE (NOM)
TLV759P	WSON (6)	2.00 mm × 2.00 mm

(1) For all available packages, see the orderable addendum at the end of the data sheet.

Typical Application

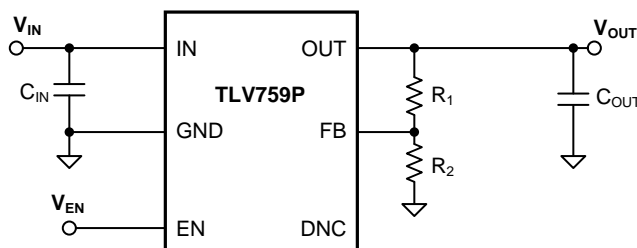

Table of Contents

1 Features	1	8 Application and Implementation	16
2 Applications	1	8.1 Application Information.....	16
3 Description	1	8.2 Feed-Forward Capacitor (C _{FF}).....	19
4 Revision History	2	8.3 Typical Application	20
5 Pin Configuration and Functions	3	9 Power Supply Recommendations	22
6 Specifications	3	10 Layout	22
6.1 Absolute Maximum Ratings	3	10.1 Layout Guidelines	22
6.2 ESD Ratings.....	4	10.2 Layout Example	22
6.3 Recommended Operating Conditions.....	4	11 Device and Documentation Support	23
6.4 Thermal Information	4	11.1 Documentation Support	23
6.5 Electrical Characteristics.....	4	11.2 Receiving Notification of Documentation Updates	23
6.6 Typical Characteristics.....	6	11.3 Community Resources.....	23
7 Detailed Description	13	11.4 Trademarks	23
7.1 Overview	13	11.5 Electrostatic Discharge Caution.....	23
7.2 Functional Block Diagram	13	11.6 Glossary	23
7.3 Feature Description.....	13	12 Mechanical, Packaging, and Orderable	23
7.4 Device Functional Modes.....	15	Information	23

4 Revision History

Changes from Original (April 2018) to Revision A	Page
• Changed document status from Advanced information to Production Data	1

5 Pin Configuration and Functions

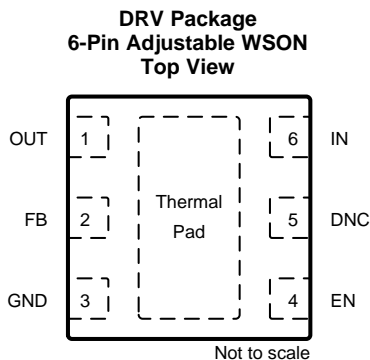

Pin Functions

PIN		I/O	DESCRIPTION
NAME	NO.		
DNC	5	—	Do not connect
EN	4	Input	Enable pin. Drive EN greater than $V_{EN(HI)}$ to turn on the regulator. Drive EN less than $V_{EN(LO)}$ to put the LDO into shutdown mode.
FB	2	—	This pin is used as an input to the control loop error amplifier and is used to set the output voltage of the LDO.
GND	3	—	Ground pin
IN	6	Input	Input pin. For best transient response and to minimize input impedance, use the recommended value or larger ceramic capacitor from IN to ground as listed in the Recommended Operating Conditions table and the Input and Output Capacitor Selection section. Place the input capacitor as close to the output of the device as possible.
OUT	1	Output	Regulated output voltage pin. A capacitor is required from OUT to ground for stability. For best transient response, use the nominal recommended value or larger ceramic capacitor from OUT to ground; see the Recommended Operating Conditions table and the Input and Output Capacitor Selection section. Place the output capacitor as close to output of the device as possible.
Thermal pad	Pad	—	Connect the thermal pad to a large area GND plane for improved thermal performance.

6 Specifications

6.1 Absolute Maximum Ratings

over operating free-air temperature range (unless otherwise noted)⁽¹⁾

	MIN	MAX	UNIT
Supply voltage, V_{IN}	-0.3	6.5	V
Enable voltage, V_{EN}	-0.3	6.5	V
Output voltage, V_{OUT}	-0.3	$V_{IN} + 0.3^{(2)}$	V
Operating junction temperature, T_J	-40	150	°C
Storage temperature, T_{stg}	-65	150	°C

- (1) Stresses beyond those listed under *Absolute Maximum Ratings* may cause permanent damage to the device. These are stress ratings only, which do not imply functional operation of the device at these or any other conditions beyond those indicated under *Recommended Operating Conditions*. Exposure to absolute-maximum-rated conditions for extended periods may affect device reliability.
- (2) The absolute maximum rating is $V_{IN} + 0.3$ V or 6.0 V, whichever is smaller

6.2 ESD Ratings

			VALUE	UNIT
V _(ESD)	Electrostatic discharge	Human-body model (HBM), per ANSI/ESDA/JEDEC JS-001 ⁽¹⁾	±2000	V
		Charged-device model (CDM), per JEDEC specification JESD22-C101 ⁽²⁾	±500	

- (1) JEDEC document JEP155 states that 500-V HBM allows safe manufacturing with a standard ESD control process. Manufacturing with less than 500-V HBM is possible with the necessary precautions.
- (2) JEDEC document JEP157 states that 250-V CDM allows safe manufacturing with a standard ESD control process. Manufacturing with less than 250-V CDM is possible with the necessary precautions.

6.3 Recommended Operating Conditions

over operating free-air temperature range (unless otherwise noted)

		MIN	NOM	MAX	UNIT
V _{IN}	Input voltage	1.5		6.0	V
V _{OUT}	Output voltage	0.55		5.5	V
I _{OUT}	Output current	0		1	A
C _{IN}	Input capacitor	1			μF
C _{OUT}	Output capacitor ⁽¹⁾	1		220	μF
V _{EN}	Enable voltage	0		6.0	V
f _{EN}	Enable toggle frequency			10	kHz
T _J	Junction temperature	–40		125	°C

- (1) Minimum derated capacitance of 0.47 μF is required for stability

6.4 Thermal Information

THERMAL METRIC ⁽¹⁾		TLV759	UNIT
		DRV (WSON)	
		6 PINS	
R _{θJA}	Junction-to-ambient thermal resistance	80.3	°C/W
R _{θJC(top)}	Junction-to-case (top) thermal resistance	98.7	°C/W
R _{θJB}	Junction-to-board thermal resistance	44.8	°C/W
ψ _{JT}	Junction-to-top characterization parameter	6.1	°C/W
ψ _{JB}	Junction-to-board characterization parameter	45.0	°C/W
R _{θJC(bot)}	Junction-to-case (bottom) thermal resistance	20.8	°C/W

- (1) For more information about traditional and new thermal metrics, see the [Semiconductor and IC Package Thermal Metrics](#) application report.

6.5 Electrical Characteristics

at operating temperature range (T_J = –40°C to 125°C), V_{IN} = V_{OUT(NOM)} + 0.5 V or 1.5 V (whichever is greater), I_{OUT} = 1 mA, V_{EN} = V_{IN}, and C_{IN} = C_{OUT} = 1 μF, unless otherwise noted. All typical values at T_J = 25°C.

PARAMETER	TEST CONDITIONS	MIN	TYP	MAX	UNIT		
V _{FB}	Feedback voltage		0.55		V		
	Output accuracy ⁽¹⁾	T _J = 25°C	–0.7%	0.7%			
		–40°C ≤ T _J ≤ +85°C	–1%	1%			
		–40°C ≤ T _J ≤ +125°C	–1.5%	1.5%			
	Line regulation	V _{OUT(NOM)} + 0.5 V ⁽²⁾ ≤ V _{IN} ≤ 6.0 V		2	7.5	mV	
	Load regulation	0.1 mA ≤ I _{OUT} ≤ 1 A, V _{IN} ≥ 2.0 V		0.03		V/A	
I _{GND}	Ground current	I _{OUT} = 0 mA	T _J = 25°C	10	25	31	μA
			–40°C ≤ T _J ≤ +125°C			35	
I _{SHDN}	Shutdown current	V _{EN} ≤ 0.3 V, 1.5 V ≤ V _{IN} ≤ 6.0 V		0.1	1	μA	

- (1) When the device is connected to external feedback resistors at the FB pin, external resistor tolerances are not included

- (2) V_{IN} = 1.5V for V_{OUT} < 1.0 V

Electrical Characteristics (continued)

at operating temperature range ($T_J = -40^{\circ}\text{C}$ to 125°C), $V_{IN} = V_{OUT(NOM)} + 0.5\text{ V}$ or 1.5 V (whichever is greater), $I_{OUT} = 1\text{ mA}$, $V_{EN} = V_{IN}$, and $C_{IN} = C_{OUT} = 1\text{ }\mu\text{F}$, unless otherwise noted. All typical values at $T_J = 25^{\circ}\text{C}$.

PARAMETER		TEST CONDITIONS		MIN	TYP	MAX	UNIT
I_{FB}	Feedback pin current				0.01	0.1	μA
I_{CL}	Output current limit	$V_{IN} = V_{OUT(NOM)} + 1.0\text{ V}$	$V_{OUT} = V_{OUT(NOM)} - 0.2\text{ V}$, $V_{OUT} < 1.5\text{ V}$	1.22	1.44	1.83	A
			$V_{OUT} = 0.9 \times V_{OUT(NOM)}$, $V_{OUT} \geq 1.5\text{ V}$	1.22	1.44	1.83	
I_{SC}	Short-circuit current limit	$V_{IN} = V_{OUT(NOM)} + 1.0\text{ V}$	$V_{OUT} = 0\text{ V}$		770		mA
V_{DO}	Dropout voltage	$I_{OUT} = 1\text{ A}$, $-40^{\circ}\text{C} \leq T_J \leq +125^{\circ}\text{C}$, $V_{OUT} = 0.95 \times V_{OUT(NOM)}$	$0.65\text{ V} \leq V_{OUT} < 0.8\text{ V}$		896	1050	mV
			$0.8\text{ V} \leq V_{OUT} < 0.9\text{ V}$		765	920	
			$0.9\text{ V} \leq V_{OUT} < 1.0\text{ V}$		700	850	
			$1.0\text{ V} \leq V_{OUT} < 1.2\text{ V}$		600	750	
			$1.2\text{ V} \leq V_{OUT} < 1.5\text{ V}$		464	585	
			$1.5\text{ V} \leq V_{OUT} < 1.8\text{ V}$		332	440	
			$1.8\text{ V} \leq V_{OUT} < 2.5\text{ V}$		264	360	
			$2.5\text{ V} \leq V_{OUT} < 3.3\text{ V}$		193	270	
PSRR	Power-supply rejection ratio	$V_{IN} = V_{OUT(NOM)} + 1\text{ V}$, $I_{OUT} = 50\text{ mA}$	$f = 1\text{ kHz}$		50		dB
			$f = 100\text{ kHz}$		45		
			$f = 1\text{ MHz}$		30		
V_n	Output noise voltage	BW = 10 Hz to 100 kHz, $V_{OUT} = 0.9\text{ V}$			53		μV_{RMS}
V_{UVLO}	Undervoltage lockout	V_{IN} rising		1.21	1.33	1.47	V
		V_{IN} falling		1.17	1.29	1.42	
$V_{UVLO, HYST}$	Undervoltage lockout hysteresis	V_{IN} hysteresis			40		mV
t_{STR}	Startup time	From EN low-to-high transition to $V_{OUT} = V_{OUT(NOM)} \times 95\%$			500		μs
$V_{EN(HI)}$	EN pin high voltage			1.0			V
$V_{EN(LO)}$	EN pin low voltage					0.3	V
I_{EN}	Enable pin current	$V_{IN} = V_{EN} = 6.0\text{ V}$			10		nA
$R_{PULLDOWN}$	Pulldown resistance	$V_{IN} = 6.0\text{ V}$			95		Ω
T_{SD}	Thermal shutdown	Shutdown, temperature increasing			170		$^{\circ}\text{C}$
		Reset, temperature decreasing			155		

6.6 Typical Characteristics

at operating temperature range $T_J = 25^\circ\text{C}$, $V_{IN} = V_{OUT(NOM)} + 0.5\text{ V}$ or 1.5 V (whichever is greater), $I_{OUT} = 1\text{ mA}$, $V_{EN} = V_{IN}$, and $C_{IN} = C_{OUT} = 1\ \mu\text{F}$ (unless otherwise noted)

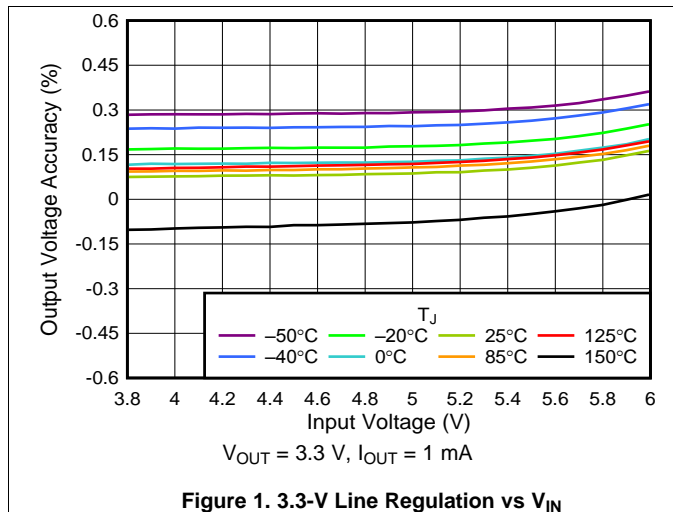

Figure 1. 3.3-V Line Regulation vs V_{IN}

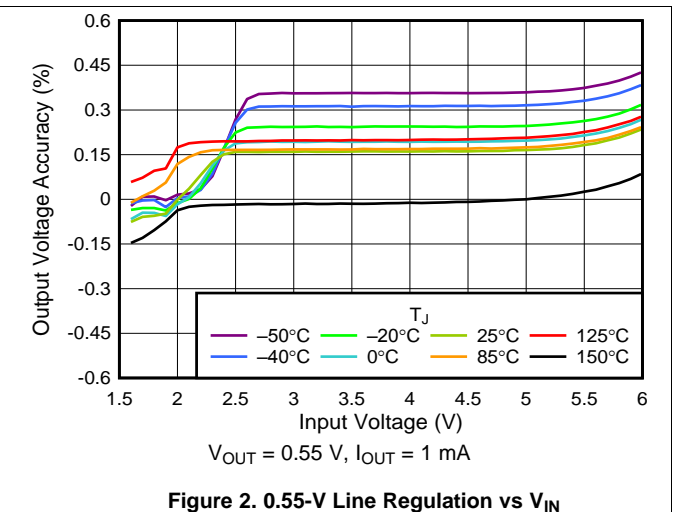

Figure 2. 0.55-V Line Regulation vs V_{IN}

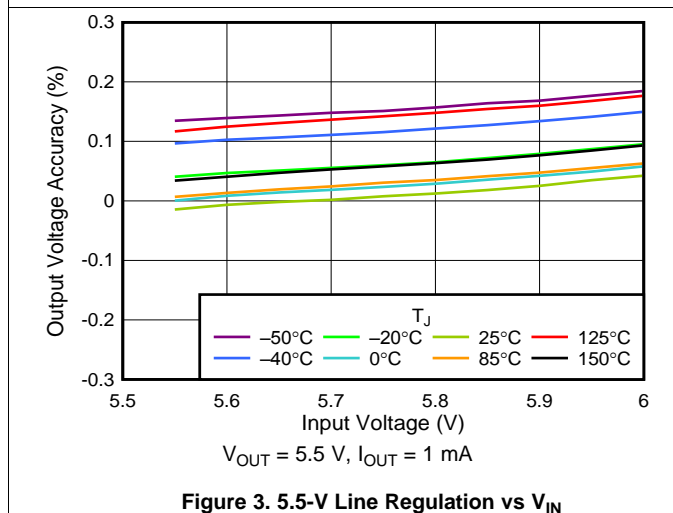

Figure 3. 5.5-V Line Regulation vs V_{IN}

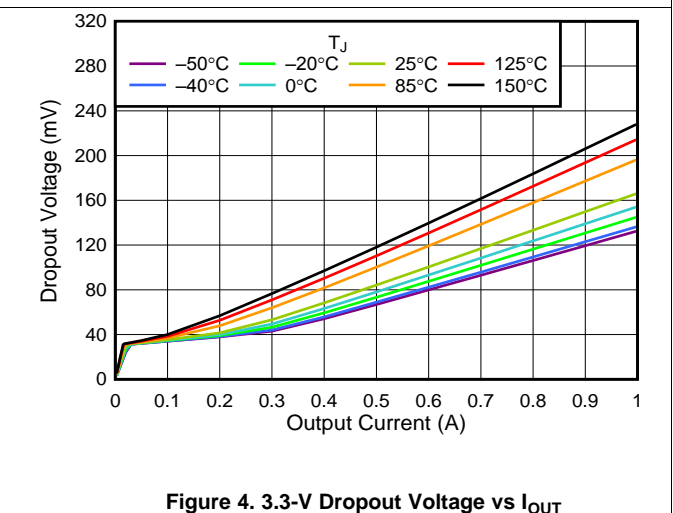

Figure 4. 3.3-V Dropout Voltage vs I_{OUT}

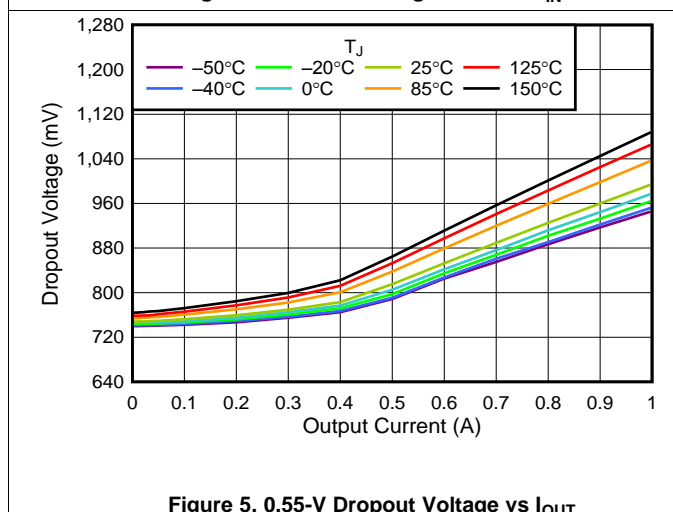

Figure 5. 0.55-V Dropout Voltage vs I_{OUT}

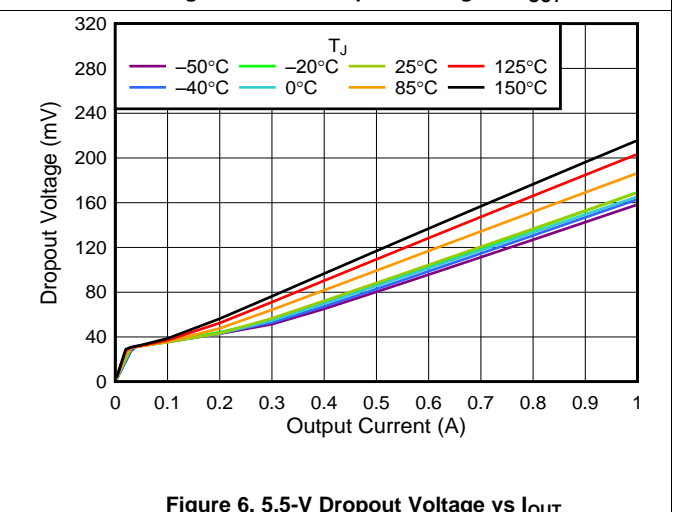

Figure 6. 5.5-V Dropout Voltage vs I_{OUT}

Typical Characteristics (continued)

at operating temperature range $T_J = 25^\circ\text{C}$, $V_{IN} = V_{OUT(NOM)} + 0.5\text{ V}$ or 1.5 V (whichever is greater), $I_{OUT} = 1\text{ mA}$, $V_{EN} = V_{IN}$, and $C_{IN} = C_{OUT} = 1\text{ }\mu\text{F}$ (unless otherwise noted)

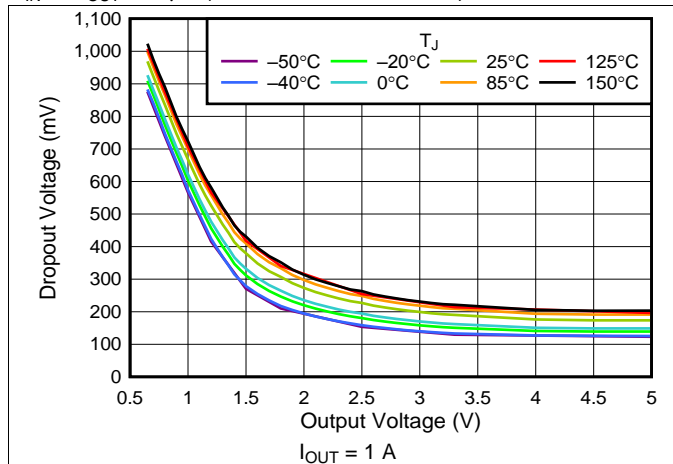

Figure 7. V_{DO} vs V_{OUT}

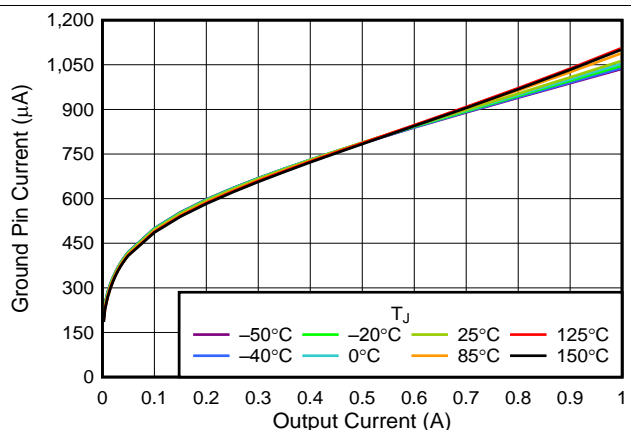

Figure 8. I_{GND} vs I_{OUT}

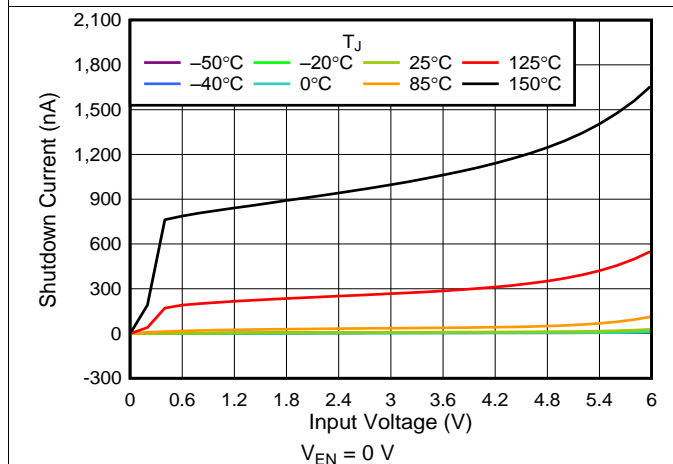

Figure 9. I_{SHDN} vs V_{IN}

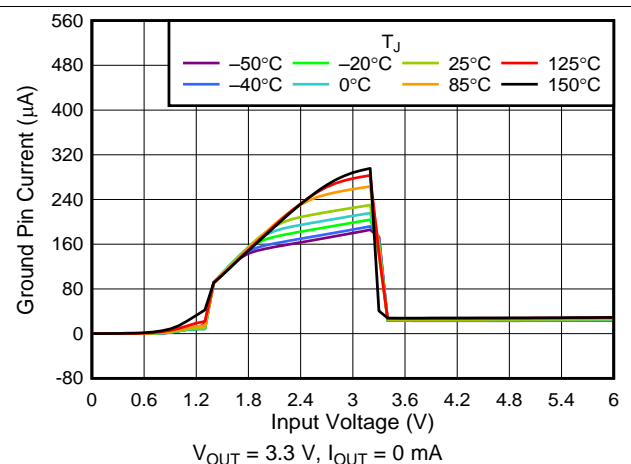

Figure 10. I_Q vs V_{IN}

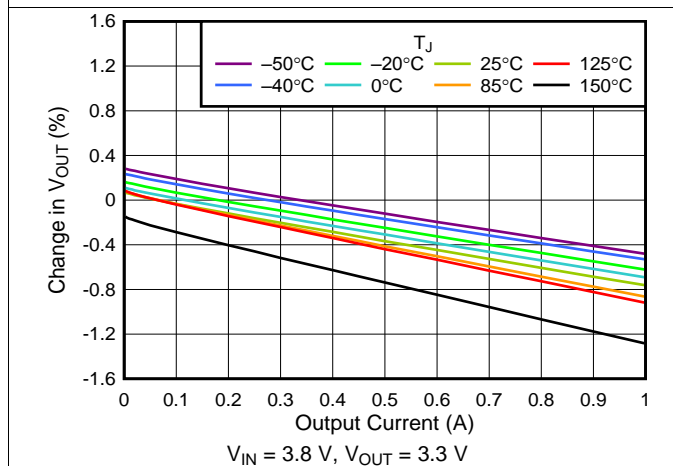

Figure 11. 3.3-V Load Regulation vs I_{OUT}

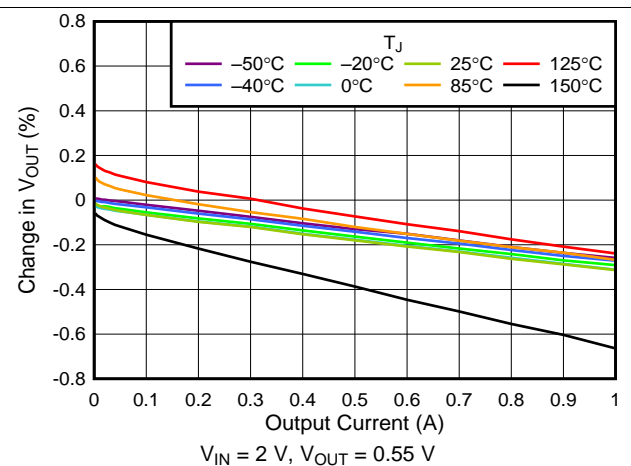

Figure 12. 0.55-V Load Regulation vs I_{OUT}

Typical Characteristics (continued)

at operating temperature range $T_J = 25^\circ\text{C}$, $V_{IN} = V_{OUT(NOM)} + 0.5\text{ V}$ or 1.5 V (whichever is greater), $I_{OUT} = 1\text{ mA}$, $V_{EN} = V_{IN}$, and $C_{IN} = C_{OUT} = 1\ \mu\text{F}$ (unless otherwise noted)

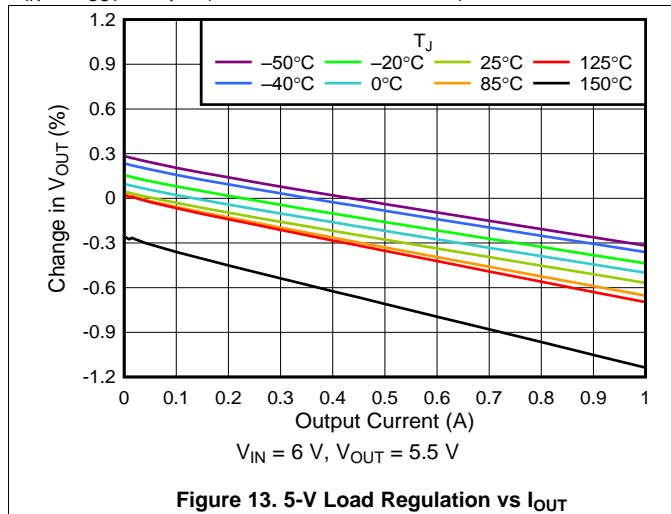

Figure 13. 5-V Load Regulation vs I_{OUT}

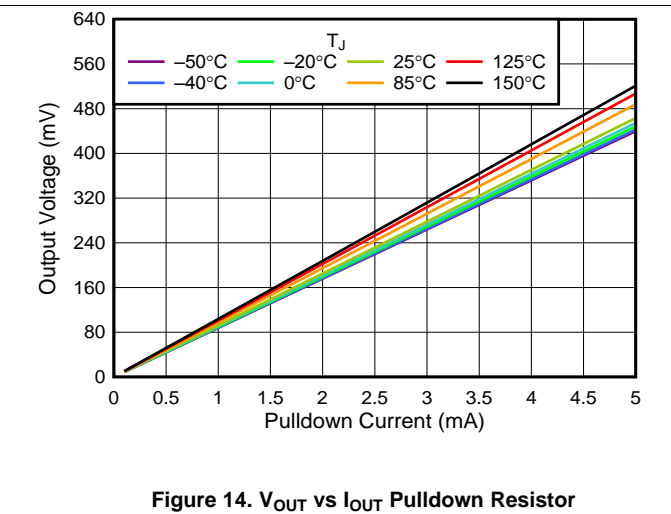

Figure 14. V_{OUT} vs I_{OUT} Pulldown Resistor

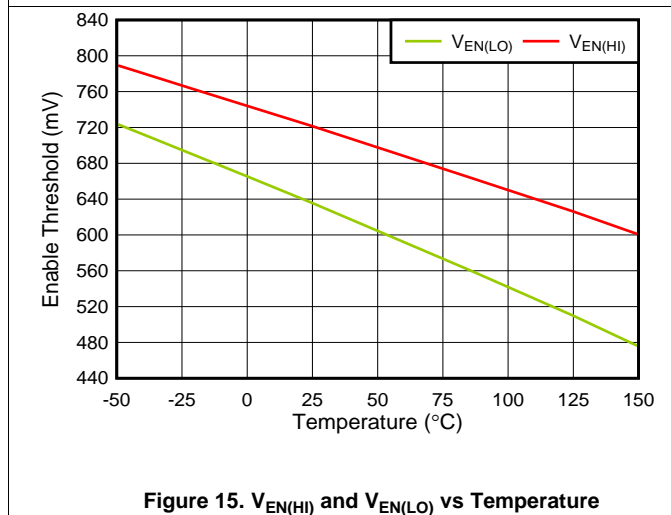

Figure 15. $V_{EN(HI)}$ and $V_{EN(LO)}$ vs Temperature

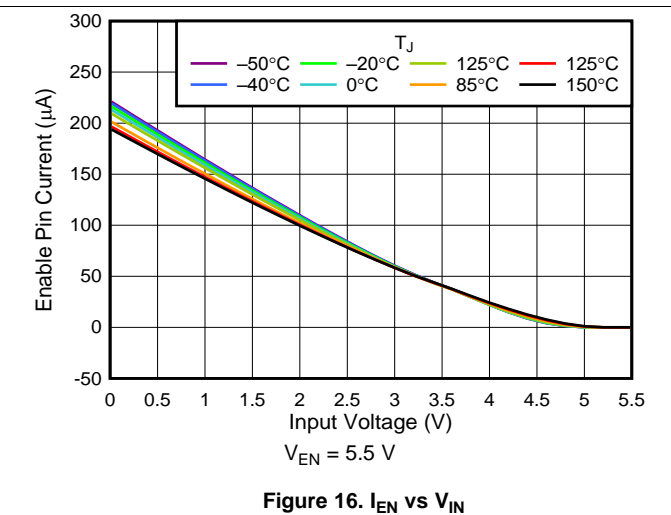

Figure 16. I_{EN} vs V_{IN}

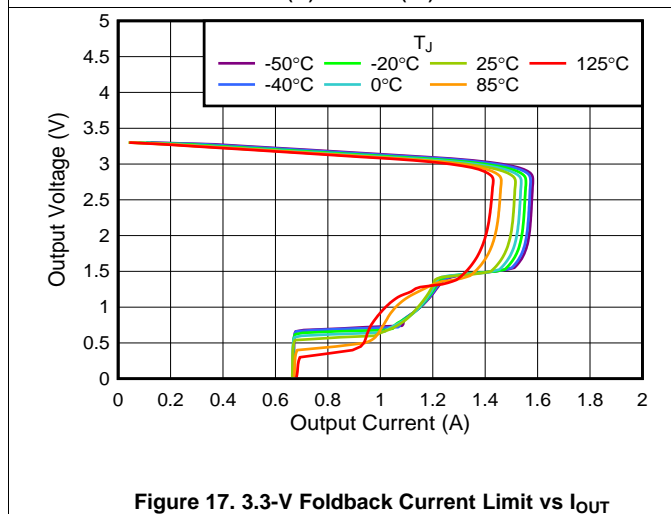

Figure 17. 3.3-V Foldback Current Limit vs I_{OUT}

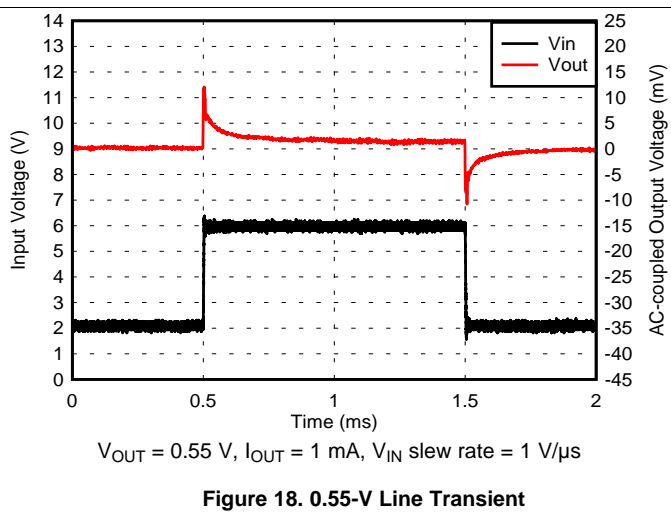

Figure 18. 0.55-V Line Transient

Typical Characteristics (continued)

at operating temperature range $T_J = 25^\circ\text{C}$, $V_{IN} = V_{OUT(NOM)} + 0.5\text{ V}$ or 1.5 V (whichever is greater), $I_{OUT} = 1\text{ mA}$, $V_{EN} = V_{IN}$, and $C_{IN} = C_{OUT} = 1\ \mu\text{F}$ (unless otherwise noted)

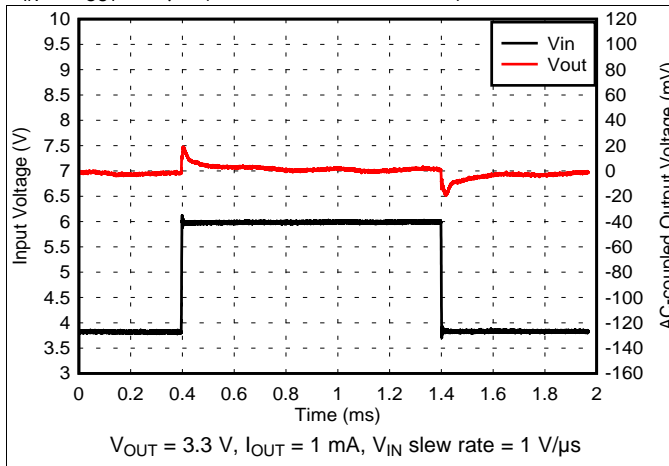

Figure 19. 3.3-V Line Transient

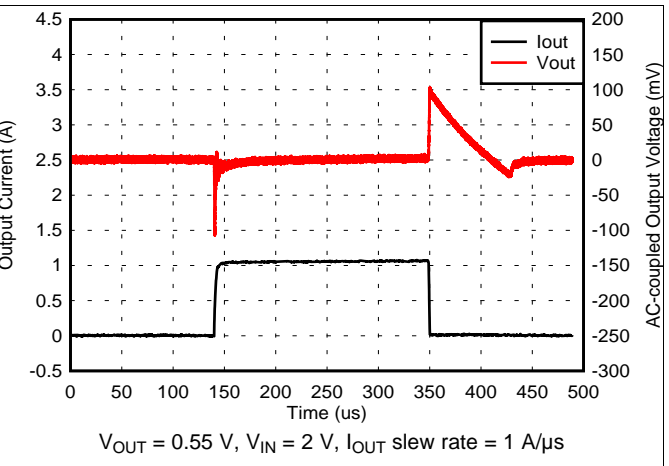

Figure 20. 1-mA to 1-A Load Transient (0.55 V)

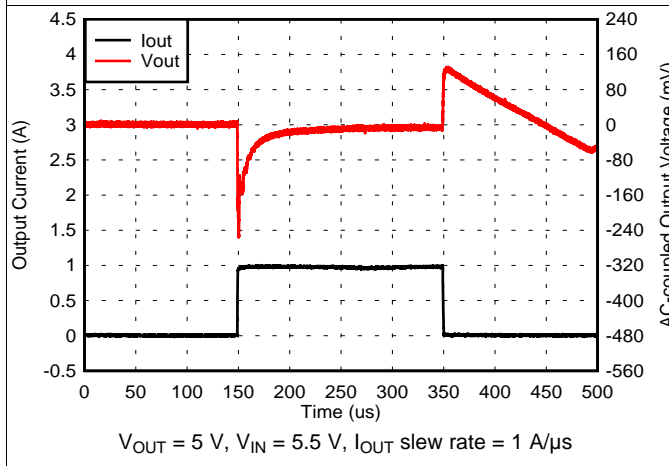

Figure 21. 1-mA to 1-A Load Transient (5 V)

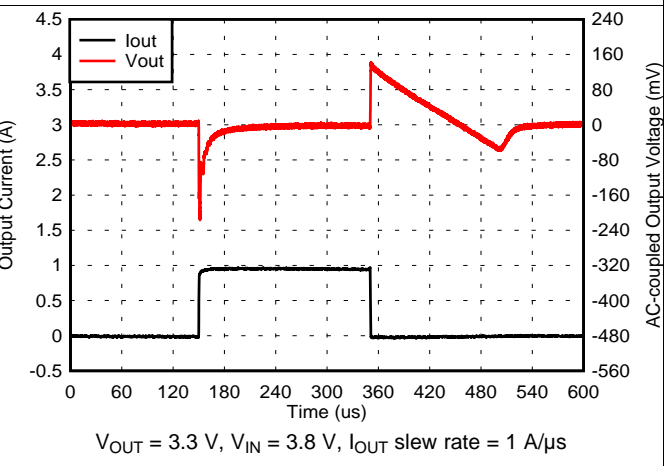

Figure 22. 1-mA to 1-A Load Transient (3.3 V)

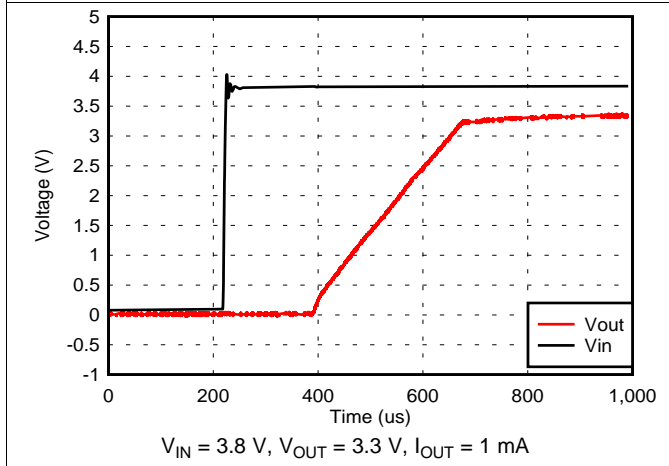

Figure 23. V_{IN} Power-Up

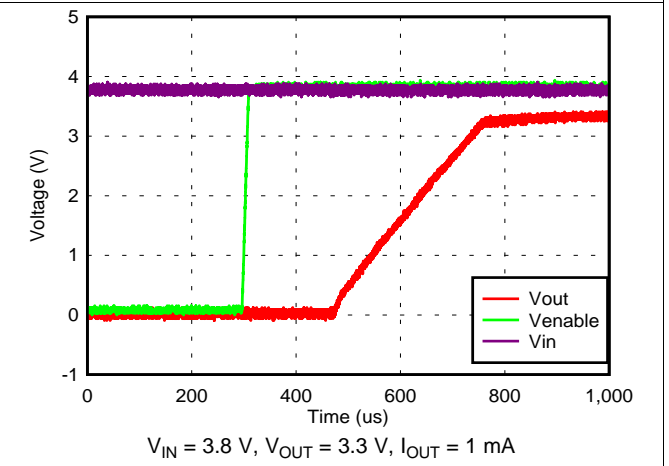

Figure 24. Startup With EN

Typical Characteristics (continued)

at operating temperature range $T_J = 25^\circ\text{C}$, $V_{IN} = V_{OUT(NOM)} + 0.5\text{ V}$ or 1.5 V (whichever is greater), $I_{OUT} = 1\text{ mA}$, $V_{EN} = V_{IN}$, and $C_{IN} = C_{OUT} = 1\ \mu\text{F}$ (unless otherwise noted)

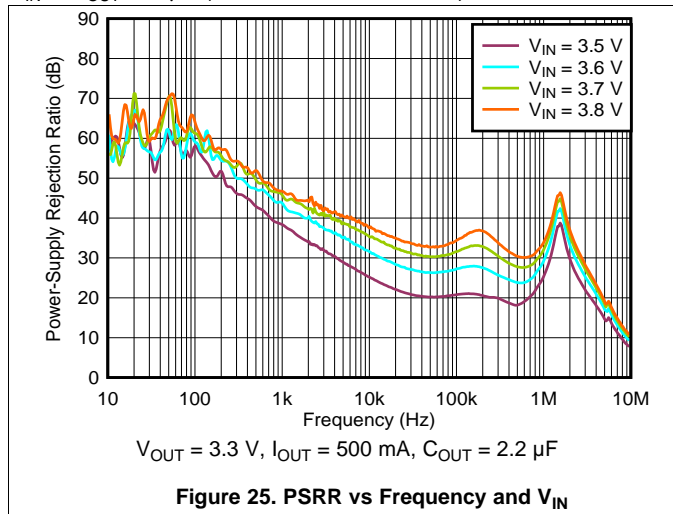

Figure 25. PSRR vs Frequency and V_{IN}

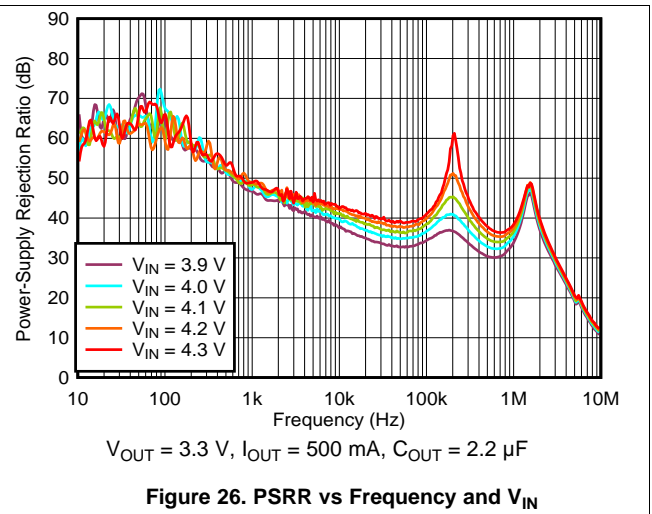

Figure 26. PSRR vs Frequency and V_{IN}

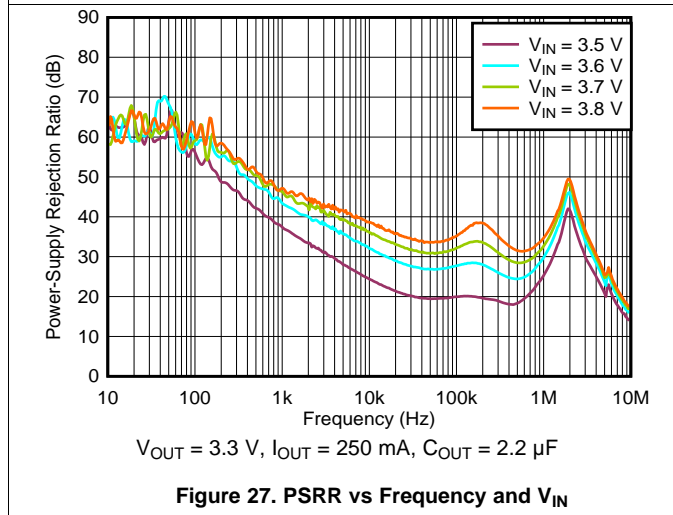

Figure 27. PSRR vs Frequency and V_{IN}

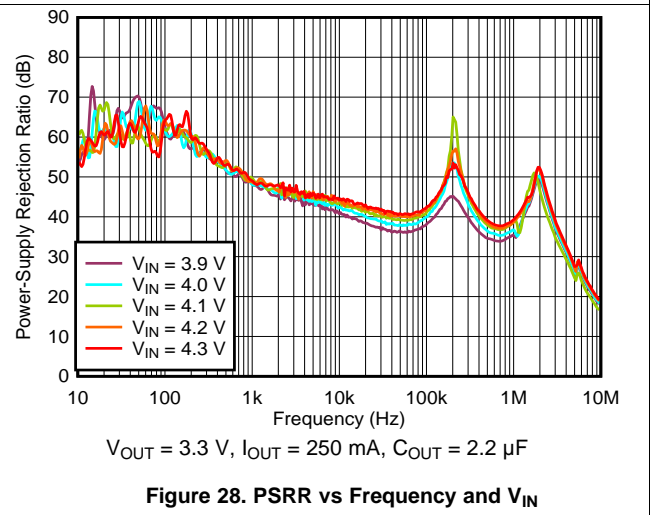

Figure 28. PSRR vs Frequency and V_{IN}

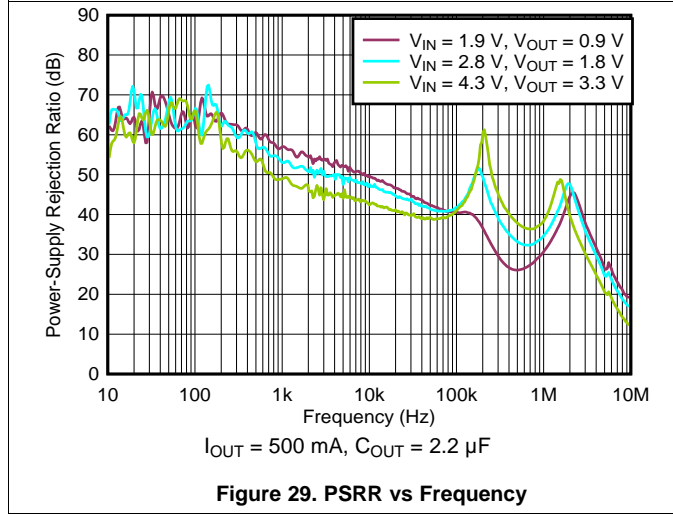

Figure 29. PSRR vs Frequency

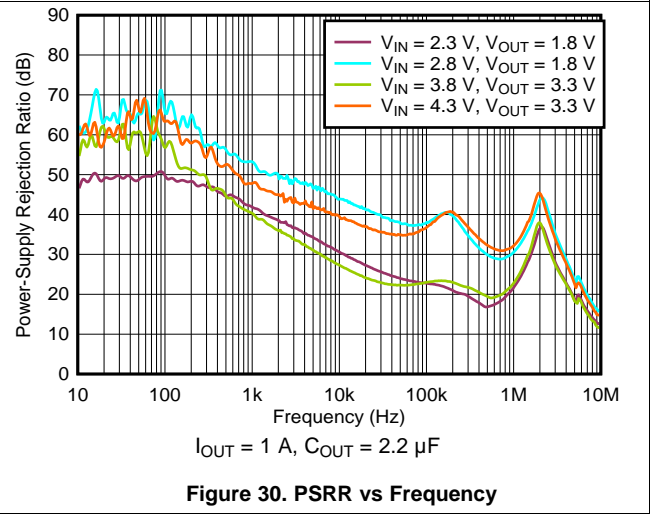

Figure 30. PSRR vs Frequency

Typical Characteristics (continued)

at operating temperature range $T_J = 25^\circ\text{C}$, $V_{IN} = V_{OUT(NOM)} + 0.5\text{ V}$ or 1.5 V (whichever is greater), $I_{OUT} = 1\text{ mA}$, $V_{EN} = V_{IN}$, and $C_{IN} = C_{OUT} = 1\ \mu\text{F}$ (unless otherwise noted)

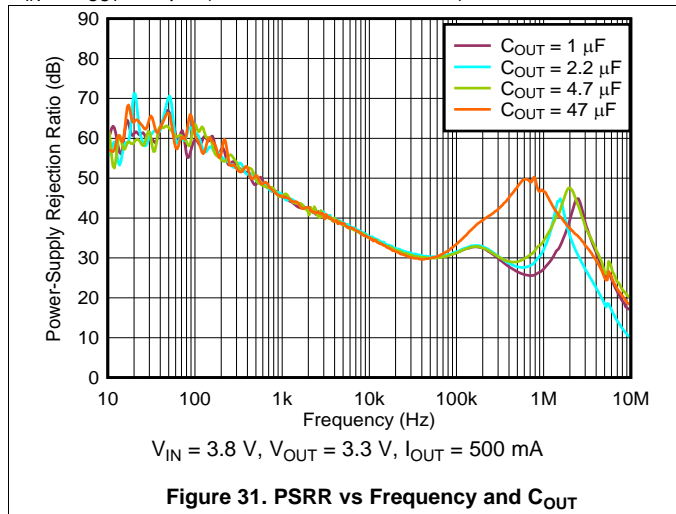

Figure 31. PSRR vs Frequency and C_{OUT}

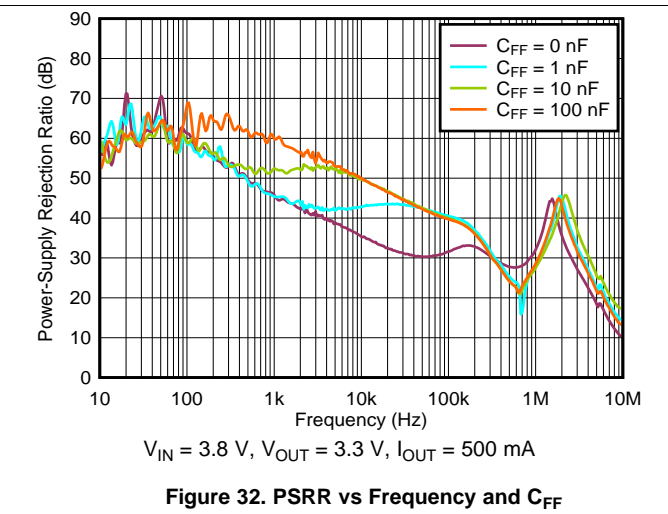

Figure 32. PSRR vs Frequency and C_{FF}

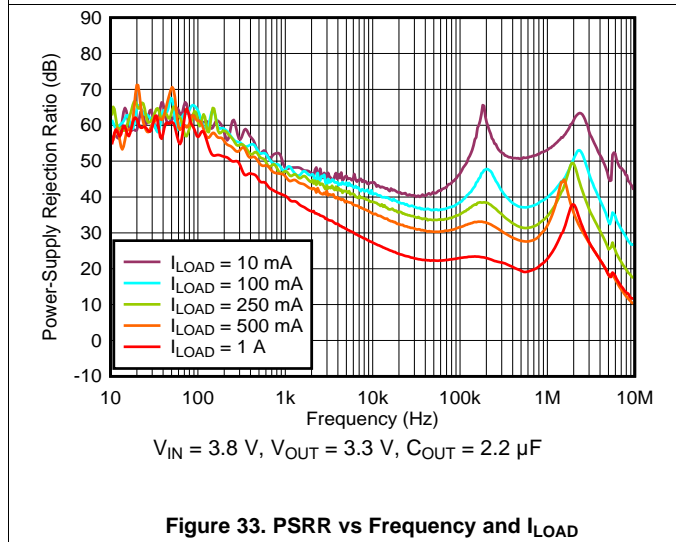

Figure 33. PSRR vs Frequency and I_{LOAD}

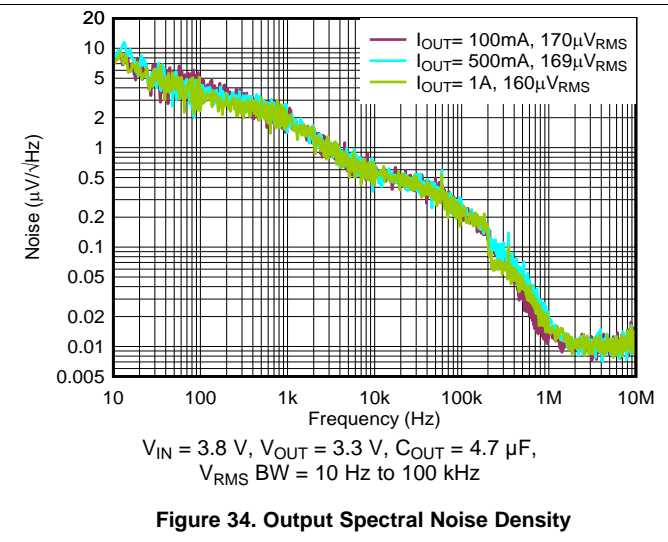

Figure 34. Output Spectral Noise Density

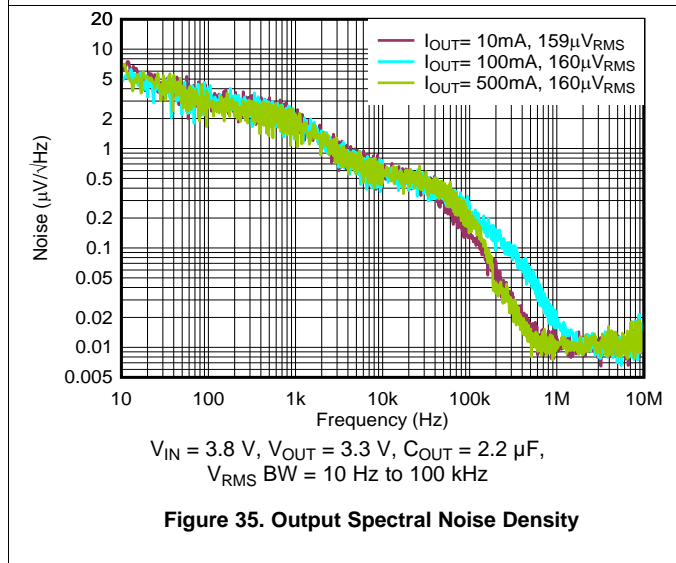

Figure 35. Output Spectral Noise Density

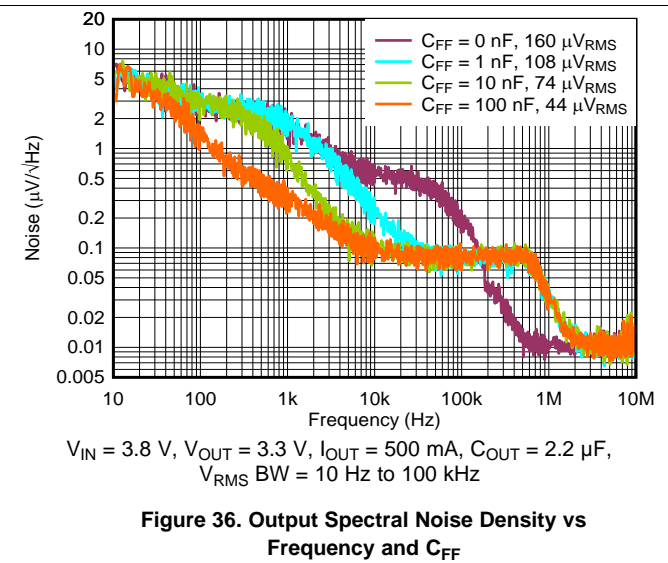
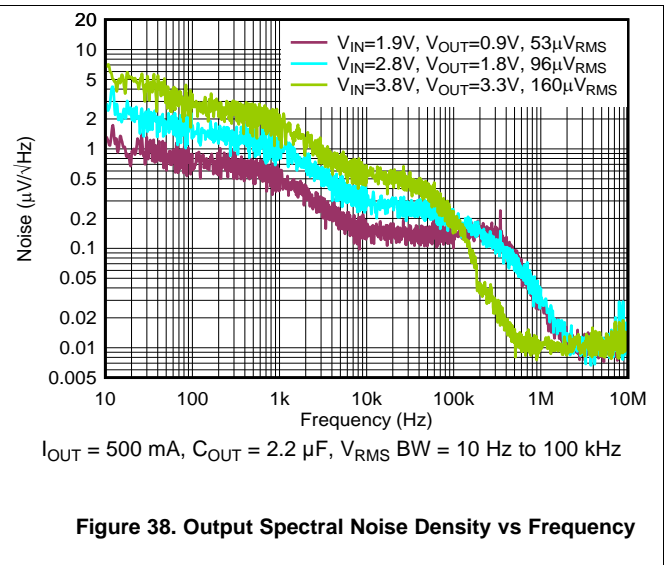
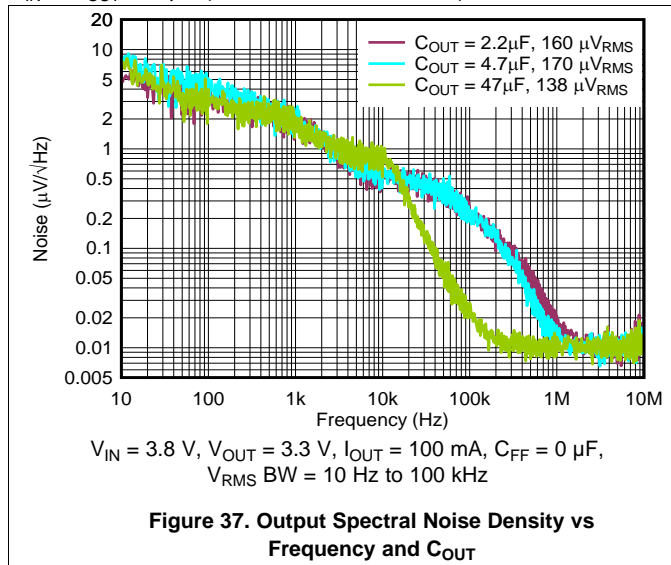

Figure 36. Output Spectral Noise Density vs Frequency and C_{FF}

Typical Characteristics (continued)

at operating temperature range $T_J = 25^\circ\text{C}$, $V_{IN} = V_{OUT(NOM)} + 0.5\text{ V}$ or 1.5 V (whichever is greater), $I_{OUT} = 1\text{ mA}$, $V_{EN} = V_{IN}$, and $C_{IN} = C_{OUT} = 1\text{ }\mu\text{F}$ (unless otherwise noted)



7 Detailed Description

7.1 Overview

The TLV759P is a next-generation, low-dropout regulator (LDO). This device consumes low quiescent current and delivers excellent line and load transient performance. These characteristics, combined with low noise and good PSRR with low dropout voltage, make this device ideal for portable consumer applications.

This regulator offers foldback current limit, shutdown, and thermal protection. The operating junction temperature for this device is -40°C to $+125^{\circ}\text{C}$.

7.2 Functional Block Diagram

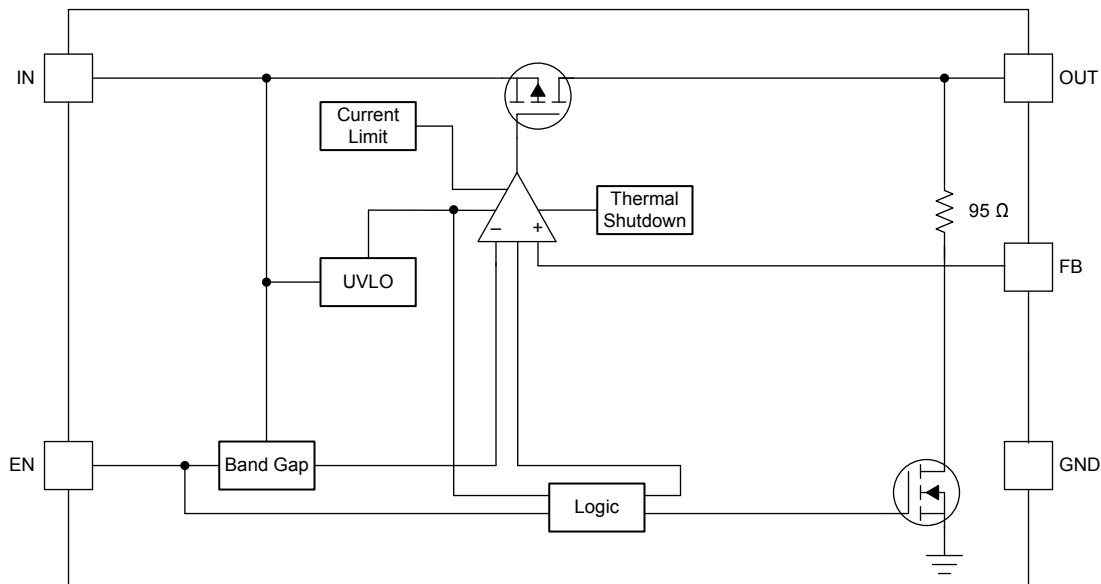

7.3 Feature Description

7.3.1 Undervoltage Lockout (UVLO)

The TLV759P uses an undervoltage lockout (UVLO) circuit that disables the output until the input voltage is greater than the rising UVLO voltage (V_{UVLO}). This circuit ensures that the device does not exhibit any unpredictable behavior when the supply voltage is lower than the operational range of the internal circuitry. When V_{IN} is less than V_{UVLO} , the output is connected to ground with a pulldown resistor ($R_{PULLDOWN}$).

7.3.2 Shutdown

The enable pin (EN) is active high. Enable the device by forcing the EN pin to exceed $V_{EN(HI)}$. Turn off the device by forcing the EN pin to drop below $V_{EN(LO)}$. If shutdown capability is not required, connect EN to IN.

The TLV759P has an internal pulldown MOSFET that connects an $R_{PULLDOWN}$ resistor to ground when the device is disabled. The discharge time after disabling depends on the output capacitance (C_{OUT}) and the load resistance (R_L) in parallel with the pulldown resistor ($R_{PULLDOWN}$). Equation 1 calculates the time constant:

$$\tau = (R_{PULLDOWN} \times R_L) / (R_{PULLDOWN} + R_L) \quad (1)$$

Feature Description (continued)

7.3.3 Foldback Current Limit

The device has an internal current limit circuit that protects the regulator during transient high-load current faults or shorting events. The current limit is a hybrid brickwall-foldback scheme. The current limit transitions from a brickwall scheme to a foldback scheme at the foldback voltage ($V_{FOLDBACK}$). In a high-load current fault with the output voltage above $V_{FOLDBACK}$, the brickwall scheme limits the output current to the current limit (I_{CL}). When the voltage drops below $V_{FOLDBACK}$, a foldback current limit activates that scales back the current as the output voltage approaches GND. When the output is shorted, the device supplies a typical current called the short-circuit current limit (I_{SC}). I_{CL} and I_{SC} are listed in the *Electrical Characteristics* table.

For this device, $V_{FOLDBACK} = 0.4 \text{ V} \times V_{OUT(NOM)}$.

The output voltage is not regulated when the device is in current limit. When a current limit event occurs, the device begins to heat up because of the increase in power dissipation. When the device is in brickwall current limit, the pass transistor dissipates power $[(V_{IN} - V_{OUT}) \times I_{CL}]$. When the device output is shorted and the output is below $V_{FOLDBACK}$, the pass transistor dissipates power $[(V_{IN} - V_{OUT}) \times I_{SC}]$. If thermal shutdown is triggered, the device turns off. After the device cools down, the internal thermal shutdown circuit turns the device back on. If the output current fault condition continues, the device cycles between current limit and thermal shutdown. For more information on current limits, see the [Know Your Limits application report](#).

Figure 39 shows a diagram of the foldback current limit.

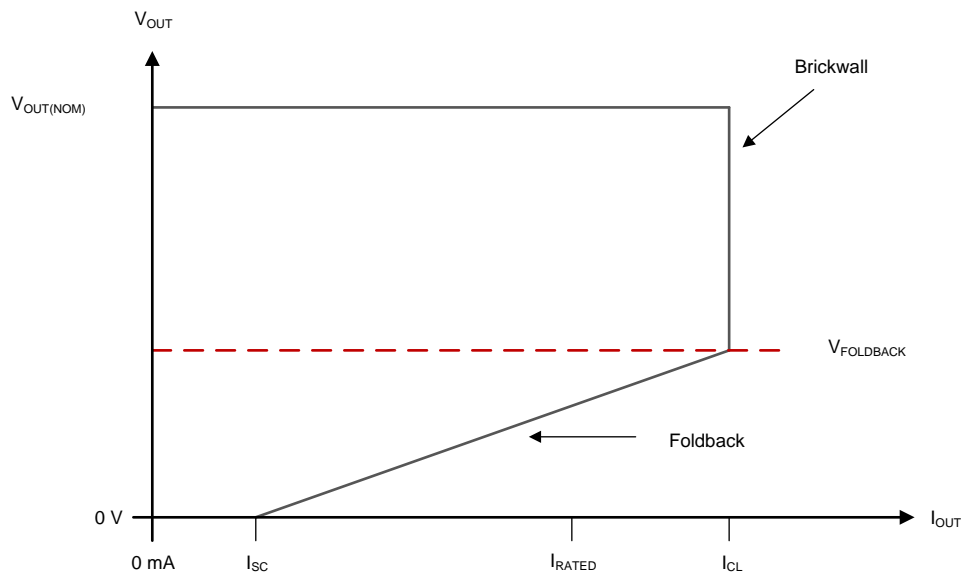

Figure 39. Foldback Current Limit

7.3.4 Thermal Shutdown

Thermal shutdown protection disables the output when the junction temperature rises to approximately 170°C. Disabling the device eliminates the power dissipated by the device, allowing the device to cool. When the junction temperature cools to approximately 155°C, the output circuitry is again enabled. Depending on power dissipation, thermal resistance, and ambient temperature, the thermal protection circuit may cycle on and off. This cycling limits regulator dissipation, protecting the LDO from damage as a result of overheating.

Activating the thermal shutdown feature usually indicates excessive power dissipation as a result of the product of the $(V_{IN} - V_{OUT})$ voltage and the load current. For reliable operation, limit junction temperature to 125°C maximum. To estimate the margin of safety in a complete design, increase the ambient temperature until the thermal protection is triggered; use worst-case loads and signal conditions.

Feature Description (continued)

The TLV759P internal protection circuitry protects against overload conditions but is not intended to be activated in normal operation. Continuously running the TLV759P into thermal shutdown degrades device reliability.

7.4 Device Functional Modes

7.4.1 Device Functional Mode Comparison

The *Device Functional Mode Comparison* table shows the conditions that lead to the different modes of operation. See the *Electrical Characteristics* table for parameter values.

Table 1. Device Functional Mode Comparison

OPERATING MODE	PARAMETER			
	V_{IN}	V_{EN}	I_{OUT}	T_J
Normal operation	$V_{IN} > V_{OUT(nom)} + V_{DO}$ and $V_{IN} > V_{IN(min)}$	$V_{EN} > V_{EN(HI)}$	$I_{OUT} < I_{OUT(max)}$	$T_J < T_{SD(shutdown)}$
Dropout operation	$V_{IN(min)} < V_{IN} < V_{OUT(nom)} + V_{DO}$	$V_{EN} > V_{EN(HI)}$	$I_{OUT} < I_{OUT(max)}$	$T_J < T_{SD(shutdown)}$
Disabled (any true condition disables the device)	$V_{IN} < V_{UVLO}$	$V_{EN} < V_{EN(LOW)}$	Not applicable	$T_J > T_{SD(shutdown)}$

7.4.2 Normal Operation

The device regulates to the nominal output voltage when the following conditions are met:

- The input voltage is greater than the nominal output voltage plus the dropout voltage ($V_{OUT(nom)} + V_{DO}$)
- The output current is less than the current limit ($I_{OUT} < I_{CL}$)
- The device junction temperature is less than the thermal shutdown temperature ($T_J < T_{SD}$)
- The enable voltage has previously exceeded the enable rising threshold voltage and has not yet decreased to less than the enable falling threshold

7.4.3 Dropout Operation

If the input voltage is lower than the nominal output voltage plus the specified dropout voltage, but all other conditions are met for normal operation, the device operates in dropout mode. In this mode, the output voltage tracks the input voltage. During this mode, the transient performance of the device becomes significantly degraded because the pass transistor is in the ohmic or triode region, and acts as a switch. Line or load transients in dropout can result in large output-voltage deviations.

When the device is in a steady dropout state (defined as when the device is in dropout, $V_{IN} < V_{OUT(NOM)} + V_{DO}$, directly after being in a normal regulation state, but *not* during startup), the pass transistor is driven into the ohmic or triode region. When the input voltage returns to a value greater than or equal to the nominal output voltage plus the dropout voltage ($V_{OUT(NOM)} + V_{DO}$), the output voltage can overshoot for a short period of time while the device pulls the pass transistor back into the linear region.

7.4.4 Disabled

The output of the device can be shutdown by forcing the voltage of the enable pin to less than the maximum EN pin low-level input voltage (see the *Electrical Characteristics* table). When disabled, the pass transistor is turned off, internal circuits are shutdown, and the output voltage is actively discharged to ground by an internal discharge circuit from the output to ground.

8 Application and Implementation

NOTE

Information in the following applications sections is not part of the TI component specification, and TI does not warrant its accuracy or completeness. TI's customers are responsible for determining suitability of components for their purposes. Customers should validate and test their design implementation to confirm system functionality.

8.1 Application Information

8.1.1 Adjustable Device Feedback Resistors

Figure 40 shows that the output voltage of the TLV759P can be adjusted from 0.55 V to 5.5 V by using a resistor divider network.

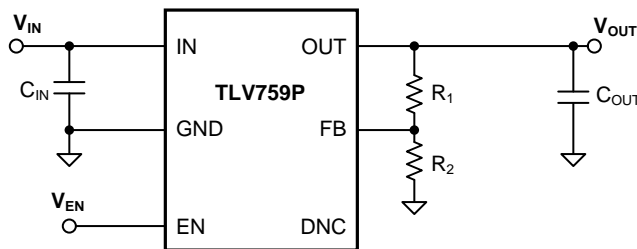

Figure 40. Adjustable Operation

The adjustable-version device requires external feedback divider resistors to set the output voltage. V_{OUT} is set using the feedback divider resistors, R_1 and R_2 , according to the following equation:

$$V_{OUT} = V_{FB} \times (1 + R_1 / R_2) \quad (2)$$

For this device, $V_{FB} = 0.55$ V.

To ignore the FB pin current error term in the V_{OUT} equation, set the feedback divider current to 100x the FB pin current listed in the *Electrical Characteristics* table. This setting provides the maximum feedback divider series resistance, as shown in the following equation:

$$R_1 + R_2 \leq V_{OUT} / (I_{FB} \times 100) \quad (3)$$

For this device, $I_{FB} = 10$ nA.

8.1.2 Input and Output Capacitor Selection

The TLV759P requires an output capacitance of 0.47 μ F or larger for stability. Use X5R- and X7R-type ceramic capacitors because these capacitors have minimal variation in value and equivalent series resistance (ESR) over temperature. When choosing a capacitor for a specific application, pay attention to the dc bias characteristics for the capacitor. Higher output voltages cause a significant derating of the capacitor. For best performance, the maximum recommended output capacitance is 220 μ F.

Although an input capacitor is not required for stability, good analog design practice is to connect a capacitor from IN to GND. Some input supplies have a high impedance, thus placing the input capacitor on the input supply helps reduce the input impedance. This capacitor counteracts reactive input sources and improves transient response, input ripple, and PSRR. If the input supply has a high impedance over a large range of frequencies, several input capacitors can be used in parallel to lower the impedance over frequency. Use a higher-value capacitor if large, fast, rise-time load transients are anticipated, or if the device is located several inches from the input power source.

Application Information (continued)

8.1.3 Dropout Voltage

The TLV759P uses a PMOS pass transistor to achieve low dropout. When $(V_{IN} - V_{OUT})$ is less than the dropout voltage (V_{DO}), the PMOS pass device is in the linear region of operation and the input-to-output resistance is the $R_{DS(ON)}$ of the PMOS pass element. V_{DO} scales approximately with output current because the PMOS device behaves like a resistor in dropout mode. As with any linear regulator, PSRR and transient response degrade as $(V_{IN} - V_{OUT})$ approaches dropout operation.

8.1.4 Exiting Dropout

Some applications have transients that place the LDO into dropout, such as slower ramps on V_{IN} during start-up. As with other LDOs, the output may overshoot on recovery from these conditions. A ramping input supply causes an LDO to overshoot on start-up, as shown in Figure 41, when the slew rate and voltage levels are in the correct range. Use an enable signal to avoid this condition.

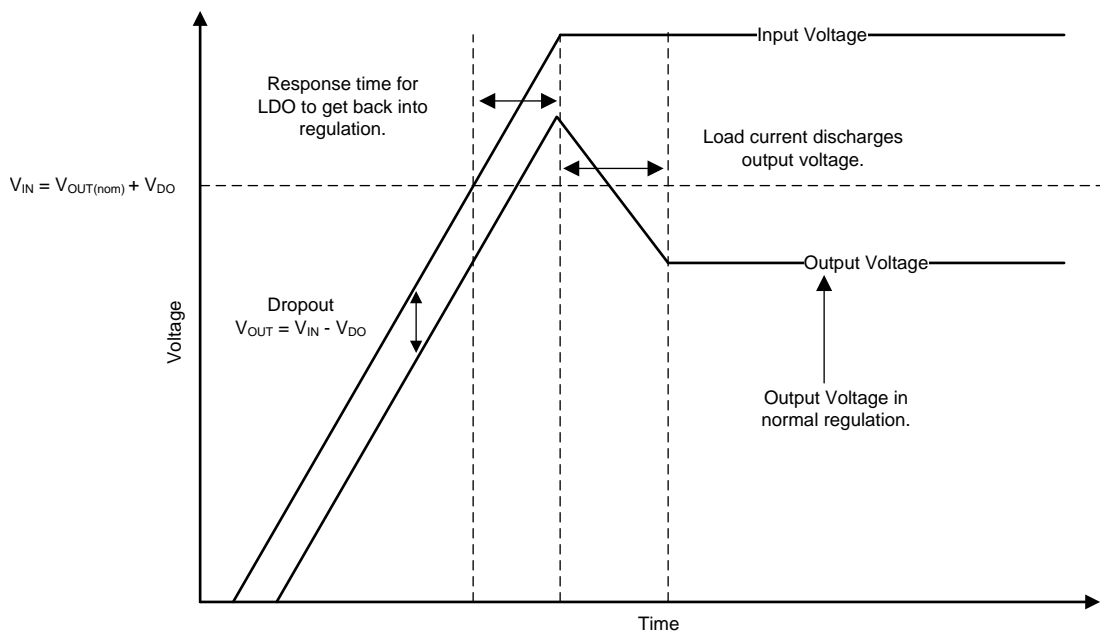
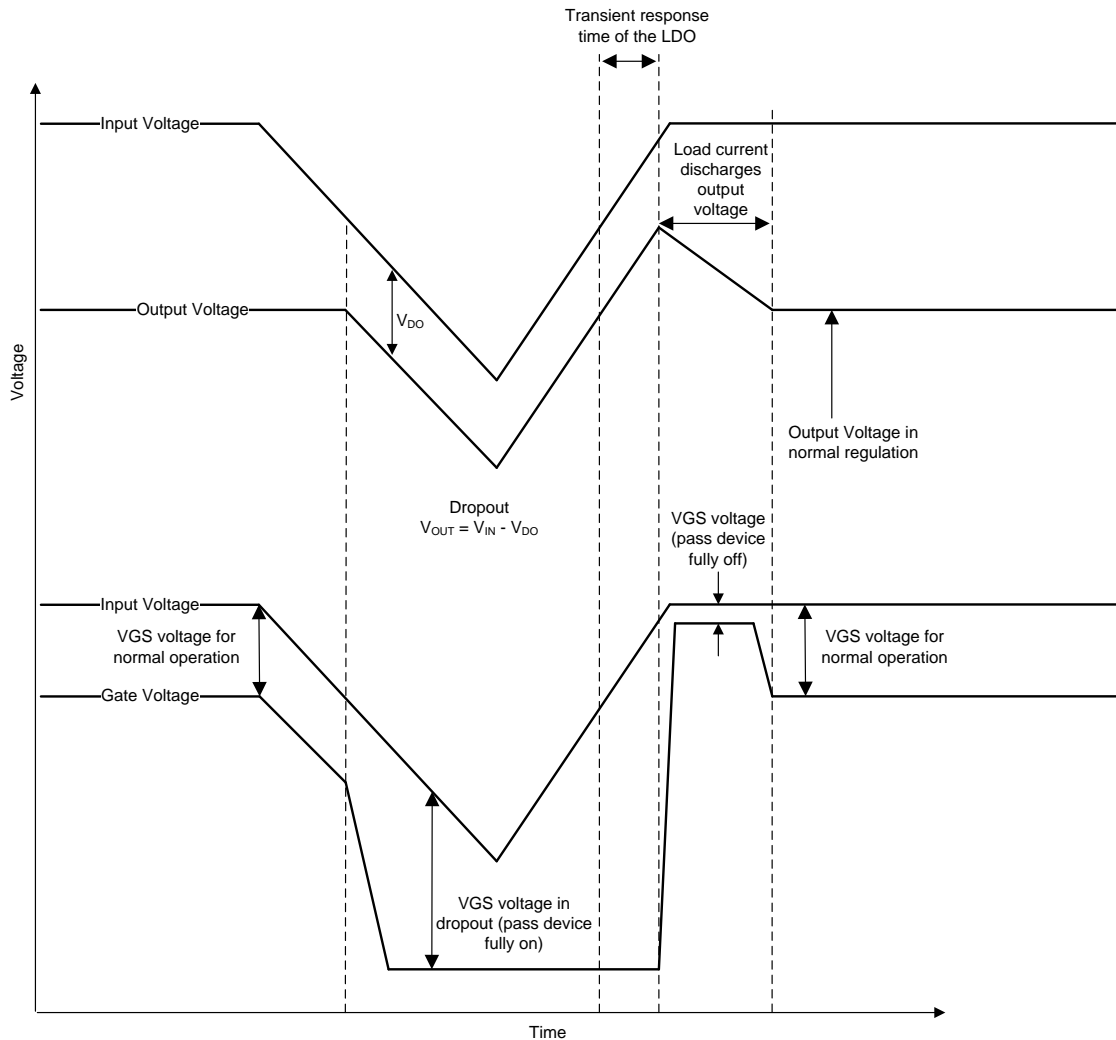

Figure 41. Startup Into Dropout

Line transients out of dropout can also cause overshoot on the output of the regulator. These overshoots are caused by the error amplifier having to drive the gate capacitance of the pass element and bring the gate back to the correct voltage for proper regulation. Figure 42 illustrates what is happening internally with the gate voltage and how overshoot can be caused during operation. When the LDO is placed in dropout, the gate voltage (V_{GS}) is pulled all the way down to ground to give the pass device the lowest on-resistance as possible. However, if a line transient occurs when the device is in dropout, the loop is not in regulation and can cause the output to overshoot until the loop responds and the output current pulls the output voltage back down into regulation. If these transients are not acceptable, then continue to add input capacitance in the system until the transient is slow enough to reduce the overshoot.

Application Information (continued)

Figure 42. Line Transients From Dropout
8.1.5 Reverse Current

As with most LDOs, excessive reverse current can damage this device.

Reverse current flows through the body diode on the pass element instead of the normal conducting channel. At high magnitudes, this current flow degrades the long-term reliability of the device, as a result of one of the following conditions:

- Degradation caused by electromigration
- Excessive heat dissipation
- Potential for a latch-up condition

Conditions where reverse current can occur are outlined in this section, all of which can exceed the absolute maximum rating of $V_{OUT} > V_{IN} + 0.3 \text{ V}$:

- If the device has a large C_{OUT} and the input supply collapses with little or no load current
- The output is biased when the input supply is not established
- The output is biased above the input supply

Application Information (continued)

If reverse current flow is expected in the application, external protection must be used to protect the device. Figure 43 shows one approach of protecting the device.

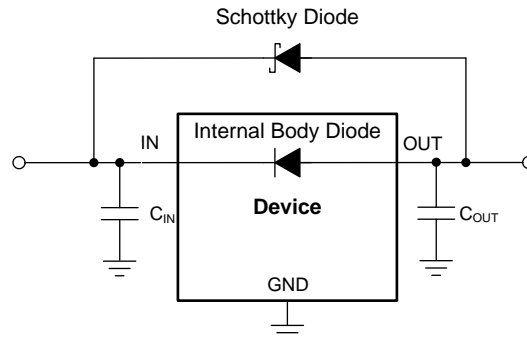

Figure 43. Example Circuit for Reverse Current Protection Using a Schottky Diode

8.1.6 Power Dissipation (P_D)

Circuit reliability requires consideration of the device power dissipation, location of the circuit on the printed circuit board (PCB), and correct sizing of the thermal plane. The PCB area around the regulator must have few or no other heat-generating devices that cause added thermal stress.

To first-order approximation, power dissipation in the regulator depends on the input-to-output voltage difference and load conditions. Equation 4 calculates power dissipation (P_D).

$$P_D = (V_{IN} - V_{OUT}) \times I_{OUT} \quad (4)$$

NOTE

Power dissipation can be minimized, and therefore greater efficiency can be achieved, by correct selection of the system voltage rails. For the lowest power dissipation use the minimum input voltage required for correct output regulation.

For devices with a thermal pad, the primary heat conduction path for the device package is through the thermal pad to the PCB. Solder the thermal pad to a copper pad area under the device. This pad area must contain an array of plated vias that conduct heat to additional copper planes for increased heat dissipation.

The maximum power dissipation determines the maximum allowable ambient temperature (T_A) for the device. According to Equation 5, power dissipation and junction temperature are most often related by the junction-to-ambient thermal resistance ($R_{\theta JA}$) of the combined PCB and device package and the temperature of the ambient air (T_A).

$$T_J = T_A + (R_{\theta JA} \times P_D) \quad (5)$$

Thermal resistance ($R_{\theta JA}$) is highly dependent on the heat-spreading capability built into the particular PCB design, and therefore varies according to the total copper area, copper weight, and location of the planes. The junction-to-ambient thermal resistance listed in the *Thermal Information* table is determined by the JEDEC standard PCB and copper-spreading area, and is used as a relative measure of package thermal performance.

8.2 Feed-Forward Capacitor (C_{FF})

For the adjustable-voltage version device, a feed-forward capacitor (C_{FF}) can be connected from the OUT pin to the FB pin. C_{FF} improves transient, noise, and PSRR performance, but is not required for regulator stability. Recommended C_{FF} values are listed in the *Recommended Operating Conditions* table. A higher capacitance C_{FF} can be used; however, the startup time increases. For a detailed description of C_{FF} tradeoffs, see the *Pros and Cons of Using a Feedforward Capacitor with a Low-Dropout Regulator* application report.

8.3 Typical Application

Figure 44 shows the typical application circuit for the TLV759P. Input and output capacitances must be at least 1 μF .

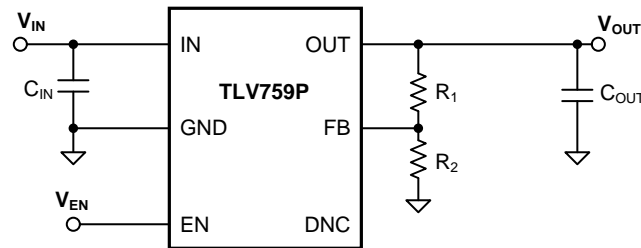

Figure 44. TLV759P Typical Application

8.3.1 Design Requirements

Use the parameters listed in Table 2 for typical linear regulator applications.

Table 2. Design Parameters

PARAMETER	DESIGN REQUIREMENT
Input voltage	3.8 V
Output voltage	3.3 V, $\pm 1\%$
Input current	1 A (maximum)
Output load	1-A DC
Maximum ambient temperature	70°C

8.3.2 Detailed Design Procedure

Input and output capacitors are required to achieve the output voltage transient requirements. Capacitance values of 2.2 μF are selected to give the maximum output capacitance in a small, low-cost package; see the [Input and Output Capacitor Selection](#) section for details.

Figure 40 illustrates the output voltage of the TLV759P. Set the output voltage using the resistor divider; see the section for details.

8.3.2.1 Input Current

During normal operation, the input current to the LDO is approximately equal to the output current of the LDO. During startup, the input current is higher as a result of the inrush current charging the output capacitor. Use Equation 6 to calculate the current through the input.

$$I_{\text{OUT}(t)} = \left[\frac{C_{\text{OUT}} \times dV_{\text{OUT}}(t)}{dt} \right] + \left[\frac{V_{\text{OUT}}(t)}{R_{\text{LOAD}}} \right]$$

where:

- $V_{\text{OUT}}(t)$ is the instantaneous output voltage of the turn-on ramp
 - $dV_{\text{OUT}}(t) / dt$ is the slope of the V_{OUT} ramp
 - R_{LOAD} is the resistive load impedance
- (6)

8.3.2.2 Thermal Dissipation

The junction temperature can be determined using the junction-to-ambient thermal resistance ($R_{\theta\text{JA}}$) and the total power dissipation (P_{D}). Use Equation 7 to calculate the power dissipation. Multiply P_{D} by $R_{\theta\text{JA}}$ as Equation 8 shows and add the ambient temperature (T_{A}) to calculate the junction temperature (T_{J}).

$$P_{\text{D}} = (I_{\text{GND}} + I_{\text{OUT}}) \times (V_{\text{IN}} - V_{\text{OUT}}) \tag{7}$$

$$T_{\text{J}} = R_{\theta\text{JA}} \times P_{\text{D}} + T_{\text{A}} \tag{8}$$

Calculate the maximum ambient temperature as Equation 9 shows if the ($T_{J(MAX)}$) value does not exceed 125°C. Equation 10 calculates the maximum ambient temperature with a value of 84.85°C.

$$T_{A(MAX)} = T_{J(MAX)} - R_{\theta JA} \times P_D \tag{9}$$

$$T_{A(MAX)} = 125^\circ\text{C} - 80.3^\circ\text{C/W} \times (3.8\text{ V} - 3.3\text{ V}) \times (1\text{ A}) = 84.85^\circ\text{C} \tag{10}$$

8.3.3 Application Curve

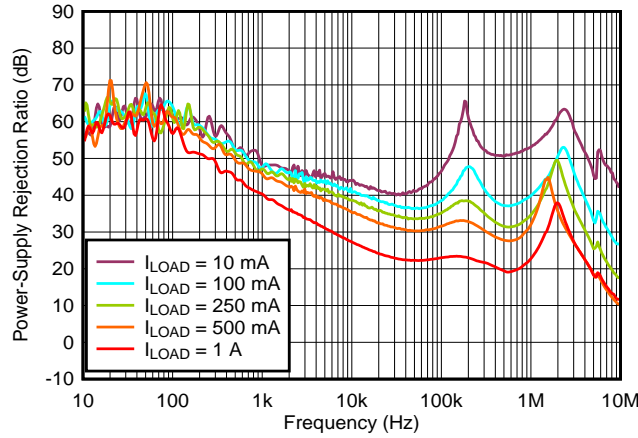

$V_{IN} = 3.8\text{ V}$, $V_{OUT} = 3.3\text{ V}$, $C_{OUT} = 2.2\text{ }\mu\text{F}$

Figure 45. PSRR vs Frequency and I_{LOAD}

9 Power Supply Recommendations

Connect a low output impedance power supply directly to the IN pin of the TLV759P.

10 Layout

10.1 Layout Guidelines

- Place input and output capacitors as close to the device as possible.
- Use copper planes for device connections in order to optimize thermal performance.
- Place thermal vias around the device to distribute heat.
- Do not place a thermal via directly beneath the thermal pad of the DRV package. A via can wick solder or solder paste away from the thermal pad joint during the soldering process, leading to a compromised solder joint on the thermal pad.

10.2 Layout Example

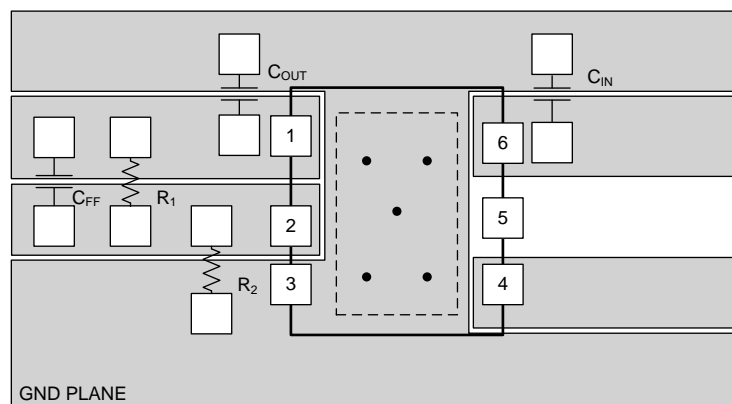

Figure 46. Layout Example for the DRV Package

11 Device and Documentation Support

11.1 Documentation Support

11.1.1 Related Documentation

For related documentation see the following:

[Pros and Cons of Using a Feedforward Capacitor with a Low-Dropout Regulator](#) application report

11.2 Receiving Notification of Documentation Updates

To receive notification of documentation updates, navigate to the device product folder on ti.com. In the upper right corner, click on *Alert me* to register and receive a weekly digest of any product information that has changed. For change details, review the revision history included in any revised document.

11.3 Community Resources

The following links connect to TI community resources. Linked contents are provided "AS IS" by the respective contributors. They do not constitute TI specifications and do not necessarily reflect TI's views; see TI's [Terms of Use](#).

TI E2E™ Online Community *TI's Engineer-to-Engineer (E2E) Community*. Created to foster collaboration among engineers. At e2e.ti.com, you can ask questions, share knowledge, explore ideas and help solve problems with fellow engineers.

Design Support *TI's Design Support* Quickly find helpful E2E forums along with design support tools and contact information for technical support.

11.4 Trademarks

E2E is a trademark of Texas Instruments.
All other trademarks are the property of their respective owners.

11.5 Electrostatic Discharge Caution



This integrated circuit can be damaged by ESD. Texas Instruments recommends that all integrated circuits be handled with appropriate precautions. Failure to observe proper handling and installation procedures can cause damage.

ESD damage can range from subtle performance degradation to complete device failure. Precision integrated circuits may be more susceptible to damage because very small parametric changes could cause the device not to meet its published specifications.

11.6 Glossary

[SLYZ022](#) — *TI Glossary*.

This glossary lists and explains terms, acronyms, and definitions.

12 Mechanical, Packaging, and Orderable Information

The following pages include mechanical, packaging, and orderable information. This information is the most current data available for the designated devices. This data is subject to change without notice and revision of this document. For browser-based versions of this data sheet, refer to the left-hand navigation.

PACKAGING INFORMATION

Orderable part number	Status (1)	Material type (2)	Package Pins	Package qty Carrier	RoHS (3)	Lead finish/ Ball material (4)	MSL rating/ Peak reflow (5)	Op temp (°C)	Part marking (6)
TLV75901PDRVR	Active	Production	WSON (DRV) 6	3000 LARGE T&R	Yes	NIPDAU	Level-1-260C-UNLIM	-40 to 125	1MGH
TLV75901PDRVT	Active	Production	WSON (DRV) 6	250 SMALL T&R	Yes	NIPDAU	Level-1-260C-UNLIM	-40 to 125	1MGH

(1) **Status:** For more details on status, see our [product life cycle](#).

(2) **Material type:** When designated, preproduction parts are prototypes/experimental devices, and are not yet approved or released for full production. Testing and final process, including without limitation quality assurance, reliability performance testing, and/or process qualification, may not yet be complete, and this item is subject to further changes or possible discontinuation. If available for ordering, purchases will be subject to an additional waiver at checkout, and are intended for early internal evaluation purposes only. These items are sold without warranties of any kind.

(3) **RoHS values:** Yes, No, RoHS Exempt. See the [TI RoHS Statement](#) for additional information and value definition.

(4) **Lead finish/Ball material:** Parts may have multiple material finish options. Finish options are separated by a vertical ruled line. Lead finish/Ball material values may wrap to two lines if the finish value exceeds the maximum column width.

(5) **MSL rating/Peak reflow:** The moisture sensitivity level ratings and peak solder (reflow) temperatures. In the event that a part has multiple moisture sensitivity ratings, only the lowest level per JEDEC standards is shown. Refer to the shipping label for the actual reflow temperature that will be used to mount the part to the printed circuit board.

(6) **Part marking:** There may be an additional marking, which relates to the logo, the lot trace code information, or the environmental category of the part.

Multiple part markings will be inside parentheses. Only one part marking contained in parentheses and separated by a "~" will appear on a part. If a line is indented then it is a continuation of the previous line and the two combined represent the entire part marking for that device.

Important Information and Disclaimer:The information provided on this page represents TI's knowledge and belief as of the date that it is provided. TI bases its knowledge and belief on information provided by third parties, and makes no representation or warranty as to the accuracy of such information. Efforts are underway to better integrate information from third parties. TI has taken and continues to take reasonable steps to provide representative and accurate information but may not have conducted destructive testing or chemical analysis on incoming materials and chemicals. TI and TI suppliers consider certain information to be proprietary, and thus CAS numbers and other limited information may not be available for release.

In no event shall TI's liability arising out of such information exceed the total purchase price of the TI part(s) at issue in this document sold by TI to Customer on an annual basis.

TAPE AND REEL INFORMATION

QUADRANT ASSIGNMENTS FOR PIN 1 ORIENTATION IN TAPE

*All dimensions are nominal

Device	Package Type	Package Drawing	Pins	SPQ	Reel Diameter (mm)	Reel Width W1 (mm)	A0 (mm)	B0 (mm)	K0 (mm)	P1 (mm)	W (mm)	Pin1 Quadrant
TLV75901PDRVR	WSON	DRV	6	3000	180.0	8.4	2.3	2.3	1.15	4.0	8.0	Q2
TLV75901PDRVT	WSON	DRV	6	250	180.0	8.4	2.3	2.3	1.15	4.0	8.0	Q2

TAPE AND REEL BOX DIMENSIONS

*All dimensions are nominal

Device	Package Type	Package Drawing	Pins	SPQ	Length (mm)	Width (mm)	Height (mm)
TLV75901PDRVR	WSON	DRV	6	3000	210.0	185.0	35.0
TLV75901PDRVT	WSON	DRV	6	250	210.0	185.0	35.0

GENERIC PACKAGE VIEW

DRV 6

WSON - 0.8 mm max height

PLASTIC SMALL OUTLINE - NO LEAD



Images above are just a representation of the package family, actual package may vary.
Refer to the product data sheet for package details.

4206925/F

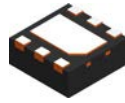

4222173/B 04/2018

NOTES:

1. All linear dimensions are in millimeters. Any dimensions in parenthesis are for reference only. Dimensioning and tolerancing per ASME Y14.5M.
2. This drawing is subject to change without notice.
3. The package thermal pad must be soldered to the printed circuit board for thermal and mechanical performance.

EXAMPLE STENCIL DESIGN

DRV0006A

WSON - 0.8 mm max height

PLASTIC SMALL OUTLINE - NO LEAD



SOLDER PASTE EXAMPLE
BASED ON 0.125 mm THICK STENCIL

EXPOSED PAD #7
88% PRINTED SOLDER COVERAGE BY AREA UNDER PACKAGE
SCALE:30X

4222173/B 04/2018

NOTES: (continued)

6. Laser cutting apertures with trapezoidal walls and rounded corners may offer better paste release. IPC-7525 may have alternate design recommendations.

IMPORTANT NOTICE AND DISCLAIMER

TI PROVIDES TECHNICAL AND RELIABILITY DATA (INCLUDING DATA SHEETS), DESIGN RESOURCES (INCLUDING REFERENCE DESIGNS), APPLICATION OR OTHER DESIGN ADVICE, WEB TOOLS, SAFETY INFORMATION, AND OTHER RESOURCES "AS IS" AND WITH ALL FAULTS, AND DISCLAIMS ALL WARRANTIES, EXPRESS AND IMPLIED, INCLUDING WITHOUT LIMITATION ANY IMPLIED WARRANTIES OF MERCHANTABILITY, FITNESS FOR A PARTICULAR PURPOSE OR NON-INFRINGEMENT OF THIRD PARTY INTELLECTUAL PROPERTY RIGHTS.

These resources are intended for skilled developers designing with TI products. You are solely responsible for (1) selecting the appropriate TI products for your application, (2) designing, validating and testing your application, and (3) ensuring your application meets applicable standards, and any other safety, security, regulatory or other requirements.

These resources are subject to change without notice. TI grants you permission to use these resources only for development of an application that uses the TI products described in the resource. Other reproduction and display of these resources is prohibited. No license is granted to any other TI intellectual property right or to any third party intellectual property right. TI disclaims responsibility for, and you will fully indemnify TI and its representatives against, any claims, damages, costs, losses, and liabilities arising out of your use of these resources.

TI's products are provided subject to [TI's Terms of Sale](#) or other applicable terms available either on [ti.com](https://www.ti.com) or provided in conjunction with such TI products. TI's provision of these resources does not expand or otherwise alter TI's applicable warranties or warranty disclaimers for TI products.

TI objects to and rejects any additional or different terms you may have proposed.

Mailing Address: Texas Instruments, Post Office Box 655303, Dallas, Texas 75265

Copyright © 2025, Texas Instruments Incorporated