

TPD1E10B06-Q1 1-Channel ESD in 0402 Package with 12-pF Capacitance and 6-V Breakdown

1 Features

- AEC-Q101 Qualified
- IEC 61000-4-2 Level 4 ESD Protection
 - ± 30 -kV Contact Discharge
 - ± 30 -kV Air-Gap Discharge
- ISO 10605 (330 pF, 330 Ω) ESD Protection
 - ± 8 -kV Contact Discharge
 - ± 15 -kV Air-Gap Discharge
- IEC 61000-4-5 Surge Protection
 - 6 A (8/20 μ s)
- I/O Capacitance 12 pF (Typical)
- R_{DYN} : 0.38 Ω (Typical)
- DC Breakdown Voltage: ± 6 V (Minimum)
- Ultra low Leakage Current 100 nA (Maximum)
- 10-V Clamping Voltage (Typical at $I_{PP} = 1$ A)
- Industrial Temperature Range: -40°C to $+125^{\circ}\text{C}$
- Space-Saving 0402 Footprint

2 Applications

- End Equipment:
 - Head Unit
 - Premium Audio
 - External Amplifier
 - Body Control Module
 - Gateway
 - Telematics
 - Camera Module
- Interfaces:
 - Audio Lines
 - Pushbuttons
 - Memory Interface
 - GPIO

3 Description

The TPD1E10B06-Q1 device is a bidirectional TVS ESD protection diode in a small 0402 industry standard package which is convenient for component placement in space-saving applications featuring low R_{DYN} and high IEC rating. The TPD1E10B06-Q1 is rated to dissipate ESD strikes above the maximum level specified in the IEC 61000-4-2 international standard (Level 4) since ESD voltages can easily reach 5000 V, which is more than enough to damage many integrated circuits, but during extreme conditions the voltages can be significantly higher. For example, in a low humidity environment voltages can exceed 20,000 V.

The low dynamic resistance (0.38 Ω) and low clamping voltage (10 V at 1-A I_{PP}) ensures system level protection against transient events, providing sufficient protection on designs that are exposed to ESD events. This device also features a 12-pF IO capacitance making it ideal for audio lines, push buttons, memory interfaces, or GPIOs.

This device is also available without automotive qualification: [TPD1E10B06](#).

Device Information⁽¹⁾

PART NUMBER	PACKAGE	BODY SIZE (NOM)
TPD1E10B06-Q1	X1SON (2)	0.60 mm x 1.00 mm
TPD1E10B06 ⁽²⁾	X1SON (2)	0.60 mm x 1.00 mm

(1) For all available packages, see the orderable addendum at the end of the data sheet.

(2) This device is not part of the TPD1E10B06-Q1 datasheet, please see [TPD1E10B06](#) for all electrical parameters and device characteristics

Typical Application Schematic

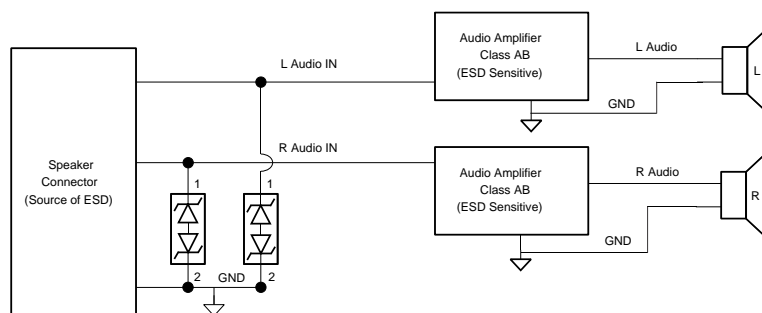

Copyright © 2016, Texas Instruments Incorporated



Table of Contents

1 Features	1	7.3 Feature Description	8
2 Applications	1	7.4 Device Functional Modes	9
3 Description	1	8 Application and Implementation	10
4 Revision History	2	8.1 Application Information	10
5 Pin Configuration and Functions	3	8.2 Typical Application	10
6 Specifications	4	9 Power Supply Recommendations	12
6.1 Absolute Maximum Ratings	4	10 Layout	12
6.2 ESD—AEC Specification Ratings	4	10.1 Layout Guidelines	12
6.3 ESD Ratings—IEC Specification	4	10.2 Layout Example	12
6.4 ESD Ratings—ISO Specification	4	11 Device and Documentation Support	13
6.5 Recommended Operating Conditions	4	11.1 Documentation Support	13
6.6 Thermal Information	4	11.2 Receiving Notification of Documentation Updates	13
6.7 Electrical Characteristics	5	11.3 Community Resources	13
6.8 Typical Characteristics	6	11.4 Trademarks	13
7 Detailed Description	8	11.5 Electrostatic Discharge Caution	13
7.1 Overview	8	11.6 Glossary	13
7.2 Functional Block Diagram	8	12 Mechanical, Packaging, and Orderable Information	14

4 Revision History

Changes from Original (August 2016) to Revision A

Page

• Changed device status from <i>Product Preview</i> to <i>Production Data</i>	1
---	---

5 Pin Configuration and Functions

DPY Package
2-Pin X1SON
Top View

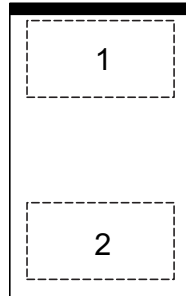

Pin Functions

PIN		I/O	DESCRIPTION
NO.	NAME		
1	IO	I/O	ESD Protected I/O. Connect other pin to ground
2	IO		

6 Specifications

6.1 Absolute Maximum Ratings

over operating free-air temperature range (unless otherwise noted)⁽¹⁾

		MIN	MAX	UNIT
I_{PP}	Peak pulse current (tp = 8/20 μ s)		6	A
P_{PP}	Peak pulse power (tp = 8/20 μ s)		90	W
T_A	Operating temperature	–40	125	°C
T_{stg}	Storage temperature	–65	155	°C

(1) Stresses beyond those listed under *Absolute Maximum Ratings* may cause permanent damage to the device. These are stress ratings only, which do not imply functional operation of the device at these or any other conditions beyond those indicated under *Recommended Operating Conditions*. Exposure to absolute-maximum-rated conditions for extended periods may affect device reliability.

6.2 ESD—AEC Specification Ratings

		VALUE	UNIT
$V_{(ESD)}$	Electrostatic discharge	Human-body model (HBM), per AEC Q100-002 ⁽¹⁾	± 2500
		Charged-device model (CDM), per AEC Q100-011	± 1000

(1) AEC Q100-002 indicates that HBM stressing shall be in accordance with the ANSI/ESDA/JEDEC JS-001 specification.

6.3 ESD Ratings—IEC Specification

		VALUE	UNIT
$V_{(ESD)}$	Electrostatic discharge	IEC 61000-4-2 contact discharge	± 30000
		IEC 61000-4-2 air-gap discharge	± 30000

6.4 ESD Ratings—ISO Specification

		VALUE	UNIT
$V_{(ESD)}$	Electrostatic discharge	ISO 10605 (330 pF, 330 Ω) contact discharge	± 8000
		ISO 10605 (330 pF, 330 Ω) air-gap discharge	± 15000

6.5 Recommended Operating Conditions

over operating free-air temperature range (unless otherwise noted)

		MIN	MAX	UNIT
T_A	Operating free-air temperature	–40	125	°C
Pin 1 to 2 or Pin 2 to 1	Operating voltage	–5.5	5.5	V

6.6 Thermal Information

THERMAL METRIC ⁽¹⁾	TPD1E10B06-Q1	UNIT	
	DPY (X1SON)		
	2 PINS		
$R_{\theta JA}$	Junction-to-ambient thermal resistance	615.5	°C/W
$R_{\theta JC(top)}$	Junction-to-case (top) thermal resistance	404.8	°C/W
$R_{\theta JB}$	Junction-to-board thermal resistance	493.3	°C/W
Ψ_{JT}	Junction-to-top characterization parameter	127.7	°C/W
Ψ_{JB}	Junction-to-board characterization parameter	493.3	°C/W
$R_{\theta JC(bot)}$	Junction-to-case (bottom) thermal resistance	162	°C/W

(1) For more information about traditional and new thermal metrics, see the [Semiconductor and IC Package Thermal Metrics](#) application report.

6.7 Electrical Characteristics

over operating free-air temperature range (unless otherwise noted)

PARAMETER		TEST CONDITION	MIN	TYP	MAX	UNIT
V_{RWM}	Reverse stand-off voltage	Pin 1 to 2 or Pin 2 to 1			5.5	V
I_{LEAK}	Leakage current	Pin 1 = 5 V, Pin 2 = 0 V			100	nA
$V_{Clamp1,2}$	Clamp voltage with ESD strike on pin 1, pin 2 grounded	$I_{PP} = 1\text{ A}$, $t_p = 8\text{ to }20\ \mu\text{s}^{(1)}$		10		V
		$I_{PP} = 5\text{ A}$, $t_p = 8\text{ to }20\ \mu\text{s}^{(1)}$		14		
$V_{Clamp2,1}$	Clamp voltage with ESD strike on pin 2, pin 1 grounded	$I_{PP} = 1\text{ A}$, $t_p = 8\text{ to }20\ \mu\text{s}^{(1)}$		8.5		V
		$I_{PP} = 5\text{ A}$, $t_p = 8\text{ to }20\ \mu\text{s}^{(1)}$		14		
R_{DYN}	Dynamic resistance	Pin 1 to Pin 2 ⁽²⁾		0.32		Ω
		Pin 2 to Pin 1 ⁽²⁾		0.38		
C_{IO}	I/O capacitance	$V_{IO} = 2.5\text{ V}$; $f = 1\text{ MHz}$		12		pF
$V_{BR1,2}$	Break-down voltage, pin 1 to pin 2	$I_{IO} = 1\text{ mA}$	6			V
$V_{BR2,1}$	Break-down voltage, pin 2 to pin 1	$I_{IO} = 1\text{ mA}$	6			V

(1) Nonrepetitive current pulse 8 to 20 μs exponentially decaying waveform according to IEC 61000-4-5

(2) Extraction of $R_{DYNAMIC}$ using least squares fit of TLP characteristics between $I_{PP} = 10\text{ A}$ and $I_{PP} = 20\text{ A}$.

6.8 Typical Characteristics

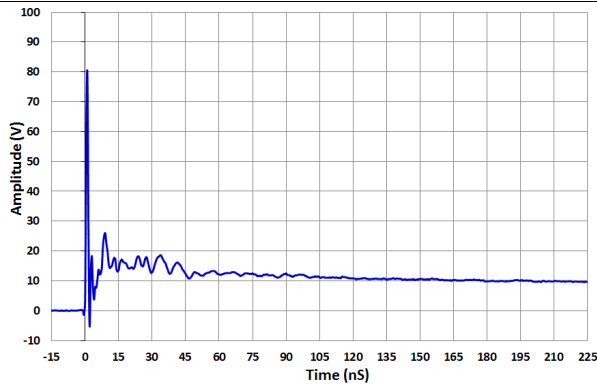

Figure 1. IEC 61000-4-2 Clamp Voltage +8-kV Contact ESD

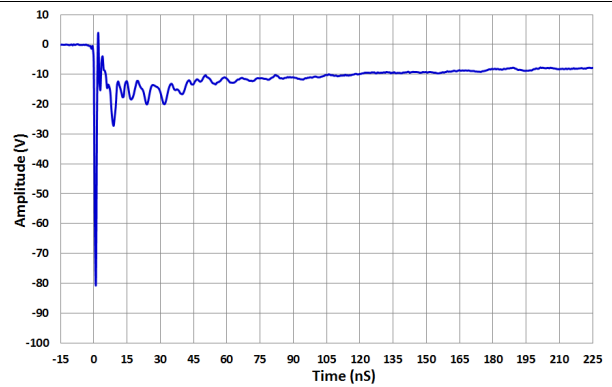

Figure 2. IEC 61000-4-2 Clamp Voltage -8-kV Contact ESD

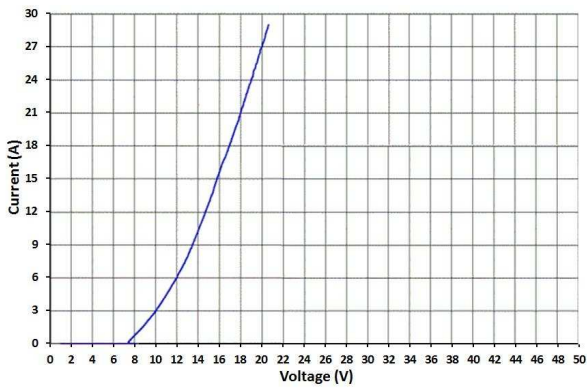

Figure 3. Transmission Line Pulse (TLP) Waveform Pin 1 to Pin 2

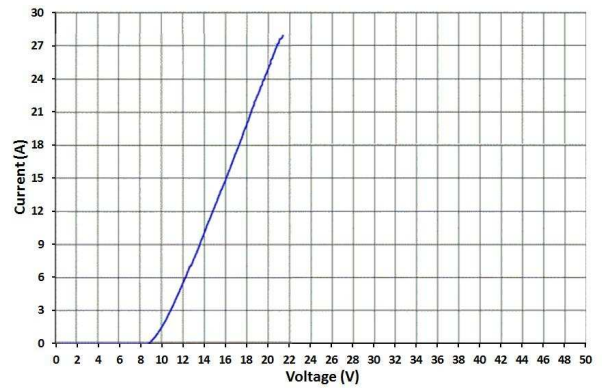

Figure 4. Transmission Line Pulse (TLP) Waveform Pin 2 to Pin 1

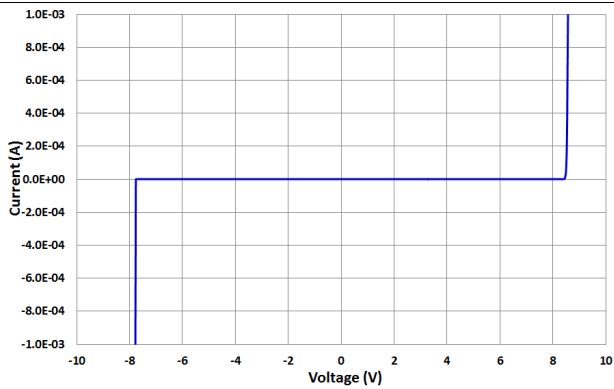

Figure 5. IV Curve

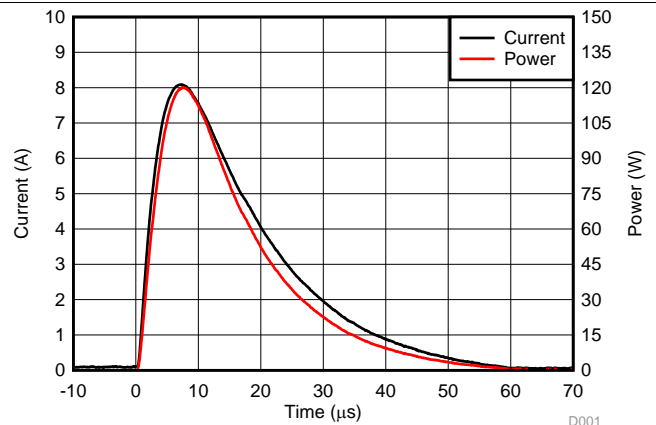
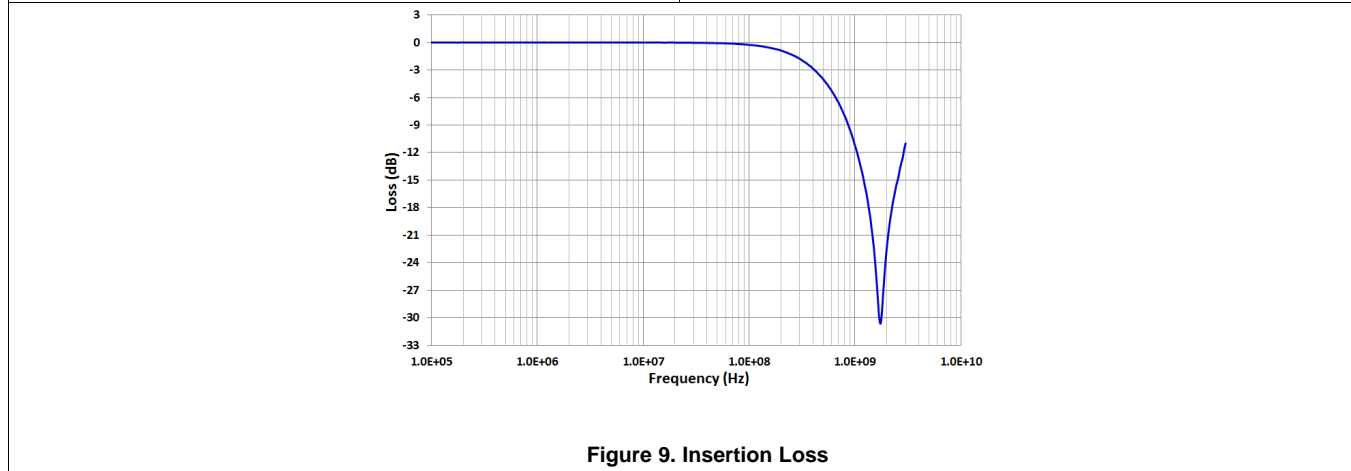
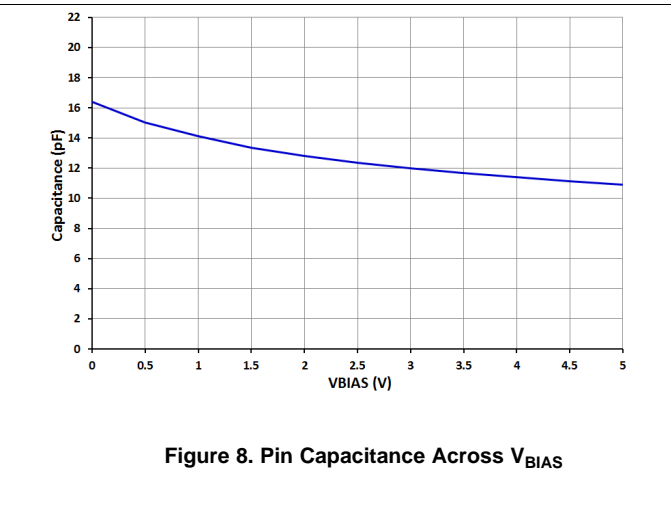
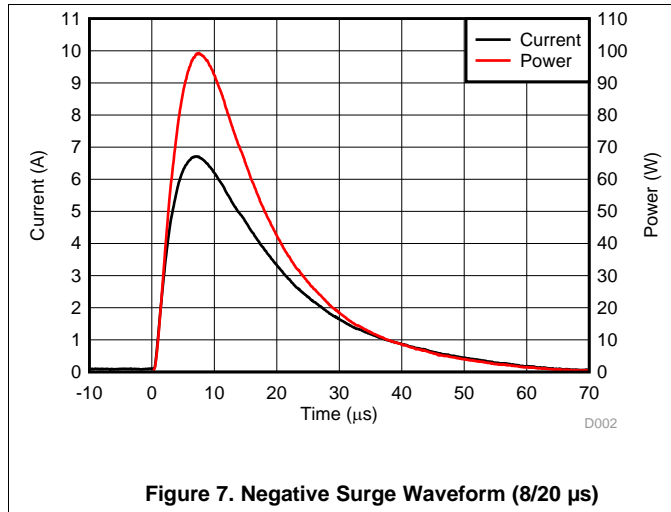

Figure 6. Positive Surge Waveform (8/20 μs)

Typical Characteristics (continued)



7 Detailed Description

7.1 Overview

The TPD1E10B06-Q1 is a single-channel ESD TVS diode in a small 0402 package. This TVS protection product offers ± 30 -kV IEC air-gap, ± 30 -kV contact ESD protection, and has an ESD clamp circuit with a back-to-back TVS diode for bipolar or bidirectional signal support. The 12-pF line capacitance of this ESD protection diode is suitable for a wide range of applications supporting data rates up to 400 Mbps. The 0402 package is an industry standard and is convenient for component placement in space-saving applications.

Typical application of this ESD protection product is the circuit protection for audio lines, push buttons, memory interfaces, and general-purpose I/O ports. This ESD clamp is a good fit for the protection of the end equipments such as head units, premium audio, external amplifiers, and many other automotive applications.

7.2 Functional Block Diagram

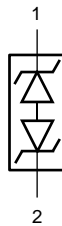

Copyright © 2016, Texas Instruments Incorporated

7.3 Feature Description

The TPD1E10B06-Q1 is a bidirectional TVS with high ESD protection level. This device protects circuit from ESD strikes up to ± 30 -kV contact and ± 30 -kV air-gap specified in the IEC 61000-4-2 level 4 international standard. The device can also handle up to 6-A surge current (IEC 61000-4-5 8/20 μ s). The I/O capacitance of 12 pF supports a data rate up to 400 Mbps. This clamping device has a small dynamic resistance, which makes the clamping voltage low when the device is actively protecting other circuits. For example, the clamping voltage is only 10 V when the device is taking 1-A transient current. The breakdown is bidirectional so that this protection device is a good fit for GPIO and especially audio lines which carry bidirectional signals. Low leakage allows the diode to conserve power when working below the V_{RWM} . The industrial temperature range of -40°C to $+125^{\circ}\text{C}$ makes this ESD device work at extensive temperatures in most environments. The space-saving 0402 package can fit into many flexible spaces.

7.3.1 AEC-Q101 Qualified

This device is qualified to AEC-Q101 standards and is qualified to operate from -40°C to $+125^{\circ}\text{C}$.

7.3.2 IEC 61000-4-2 ESD Protection

The I/O pins can withstand ESD events up to ± 30 -kV contact and ± 30 -kV air according to the IEC 61000-4-2 standard. An ESD-surge clamp diverts the current to ground.

7.3.3 ISO 10605 ESD Protection

The I/O pins can withstand ESD events at least ± 8 -kV contact and ± 15 -kV air according to the ISO 10605 (330 pF, 330 Ω) standard. An ESD-surge clamp diverts the current to ground.

7.3.4 IEC 61000-4-5 Surge Protection

The IO pins can withstand surge events up to 6 A (8/20 μ s waveform). An ESD-surge clamp diverts this current to ground.

7.3.5 IO Capacitance

The capacitance between the I/O pins 12 pF. This capacitance support data rates up to 400 Mbps.

Feature Description (continued)

7.3.6 Dynamic Resistance

The IO pins feature an ESD clamp that has a low R_{DYN} of 0.32 Ω (Pin 1 to Pin 2) and 0.38 Ω (Pin 2 to Pin 1) which prevents system damage during ESD events.

7.3.7 DC Breakdown Voltage

The DC breakdown voltage between the IO pins is a minimum of 6 V. This ensures that sensitive equipment is protected from surges above the reverse standoff voltage of 5.5 V.

7.3.8 Ultra Low Leakage Current

The IO pins feature an ultra-low leakage current of 100 nA (maximum) with a bias of 5 V.

7.3.9 Clamping Voltage

The IO pins feature an ESD clamp that is capable of clamping the voltage to 10 V ($I_{PP} = 1$ A) and 14V ($I_{PP} = 5$ A).

7.3.10 Industrial Temperature Range

This device features an industrial operating range of -40°C to $+125^{\circ}\text{C}$

7.3.11 Space-Saving Footprint

This device features a space-saving, industry standard 0402 footprint.

7.4 Device Functional Modes

The TPD1E10B06-Q1 is a passive clamp that has low leakage during normal operation when the voltage between pin 1 and pin 2 is below V_{RWM} and activates when the voltage between pin 1 and pin 2 goes above V_{BR} . During IEC ESD events, transient voltages as high as ± 30 kV can be clamped between the two pins. When the voltages on the protected lines fall below the trigger voltage, the device reverts back to the low leakage passive state.

8 Application and Implementation

NOTE

Information in the following applications sections is not part of the TI component specification, and TI does not warrant its accuracy or completeness. TI's customers are responsible for determining suitability of components for their purposes. Customers should validate and test their design implementation to confirm system functionality.

8.1 Application Information

When a system contains a human interface connector, the system becomes vulnerable to large system-level ESD strikes that standard ICs cannot survive. TVS ESD protection diodes are typically used to suppress ESD at these connectors. The TPD1E10B06-Q1 is a single-channel ESD protection device containing back-to-back TVS diodes, which is typically used to provide a path to ground for dissipating ESD events on bidirectional signal lines between a human interface connector and a system. As the current from ESD passes through the device, only a small voltage drop is present across the diode structure. This is the voltage presented to the protected IC. The low R_{DYN} of the triggered TVS holds this voltage, V_{CLAMP} , to a tolerable level to the protected IC.

8.2 Typical Application

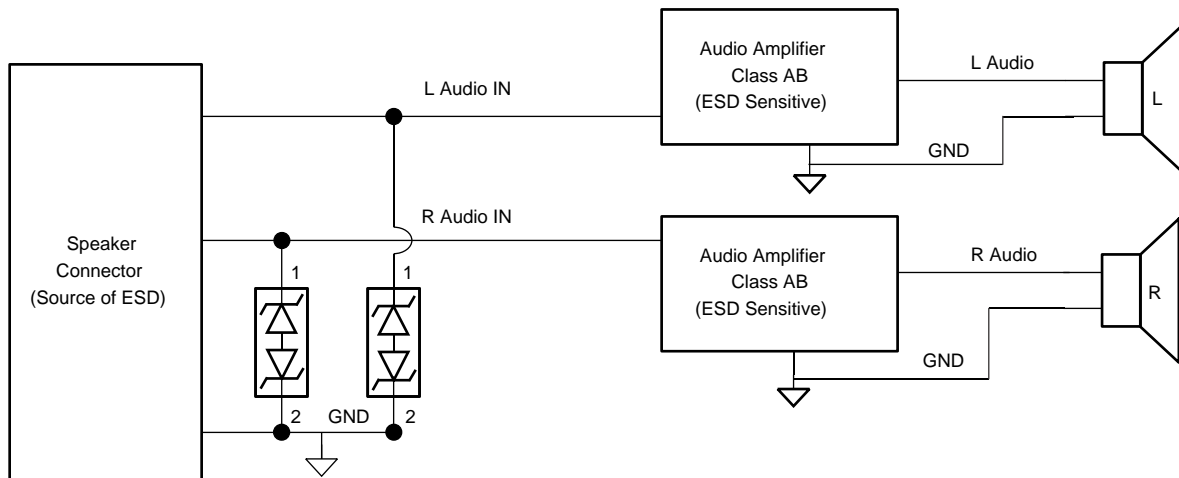

Copyright © 2016, Texas Instruments Incorporated

Figure 10. Typical Application Schematic

8.2.1 Design Requirements

For this design example, the two TPD1E10B06-Q1s are used to protect left and right audio channels. For this audio application, the system parameters shown in Table 1 are known.

Table 1. Design Parameters

DESIGN PARAMETER	VALUE
Audio amplifier class	AB
Audio signal voltage range	–3 V to 3 V
Audio frequency content	20 Hz to 20 kHz
Required IEC 61000-4-2 ESD protection	±20-kV contact, ±25-kV air-gap

8.2.2 Detailed Design Procedure

To begin the design process, some parameters must be decided upon; the designer must make sure:

- Voltage range on the protected line must not exceed the reverse standoff voltage of the TVS diode(s) (V_{RWM})
- Operating frequency is supported by the I/O capacitance C_{IO} of the TVS diode

- IEC 61000-4-2 protection requirement is covered by the IEC performance of the TVS diode

For this application, the audio signal voltage range is -3 V to 3 V . The V_{RWM} for the TVS is -5.5 V to 5.5 V ; therefore, the bidirectional TVS does not break down during normal operation, and therefore normal operation of the audio signal is not effected because of the signal voltage range. In this application, a bidirectional TVS like TPD1E10B06-Q1 is required.

Next, consider the frequency content of this audio signal. In this application with the class AB amplifier, the frequency content is from 20 Hz to 20 kHz ; ensure that the TVS I/O capacitance does not distort this signal by filtering it. With the TPD1E10B06-Q1 typical capacitance of 12 pF , which leads to a typical 3-dB bandwidth of 400 MHz , this diode has sufficient bandwidth to pass the audio signal without distorting it.

Finally, the human interface in this application requires above standard Level 4 IEC 61000-4-2 system-level ESD protection ($\pm 20\text{-kV}$ Contact, $\pm 25\text{-kV}$ Air-Gap). A standard TVS cannot survive this level of IEC ESD stress. However, the TPD1E10B06-Q1 can survive at least $\pm 30\text{-kV}$ Contact/ $\pm 30\text{-kV}$ Air-Gap. Therefore, the device can provide sufficient ESD protection for the interface, even though the requirements are stringent. For any TVS diode to provide the full range of ESD protection capabilities, as well as to minimize the noise and EMI disturbances the board will see during ESD events, a system designer must use proper board layout of their TVS ESD protection diodes. See the [Layout](#) section for instructions on properly laying out TPD1E10B06-Q1.

8.2.3 Application Curves

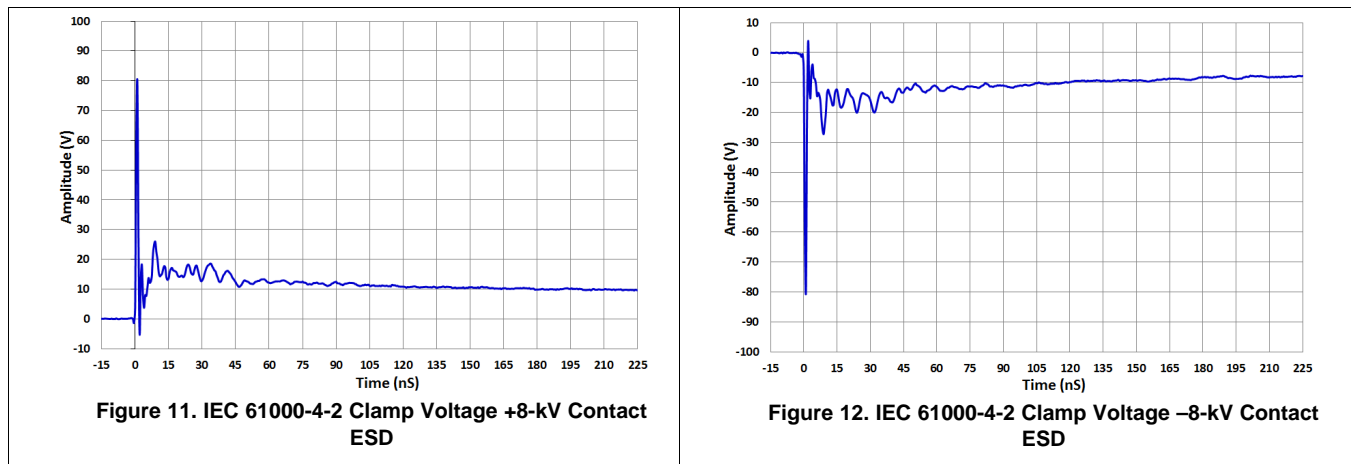

9 Power Supply Recommendations

This device is a passive TVS diode-based ESD protection device, therefore there is no requirement to power it. Take care to make sure that the maximum voltage specifications for each pin are not violated.

10 Layout

10.1 Layout Guidelines

- The optimum placement is as close to the connector as possible.
 - EMI during an ESD event can couple from the trace being struck to other nearby unprotected traces, resulting in early system failures.
 - The PCB designer must minimize the possibility of EMI coupling by keeping any unprotected traces away from the protected traces which are between the TVS and the connector.
- Route the protected traces as straight as possible.
- Eliminate any sharp corners on the protected traces between the TVS and the connector by using rounded corners with the largest radii possible.
 - Electric fields tend to build up on corners, increasing EMI coupling.
- If pin 1 or pin 2 is connected to ground, use a thick and short trace for this return path.

10.2 Layout Example

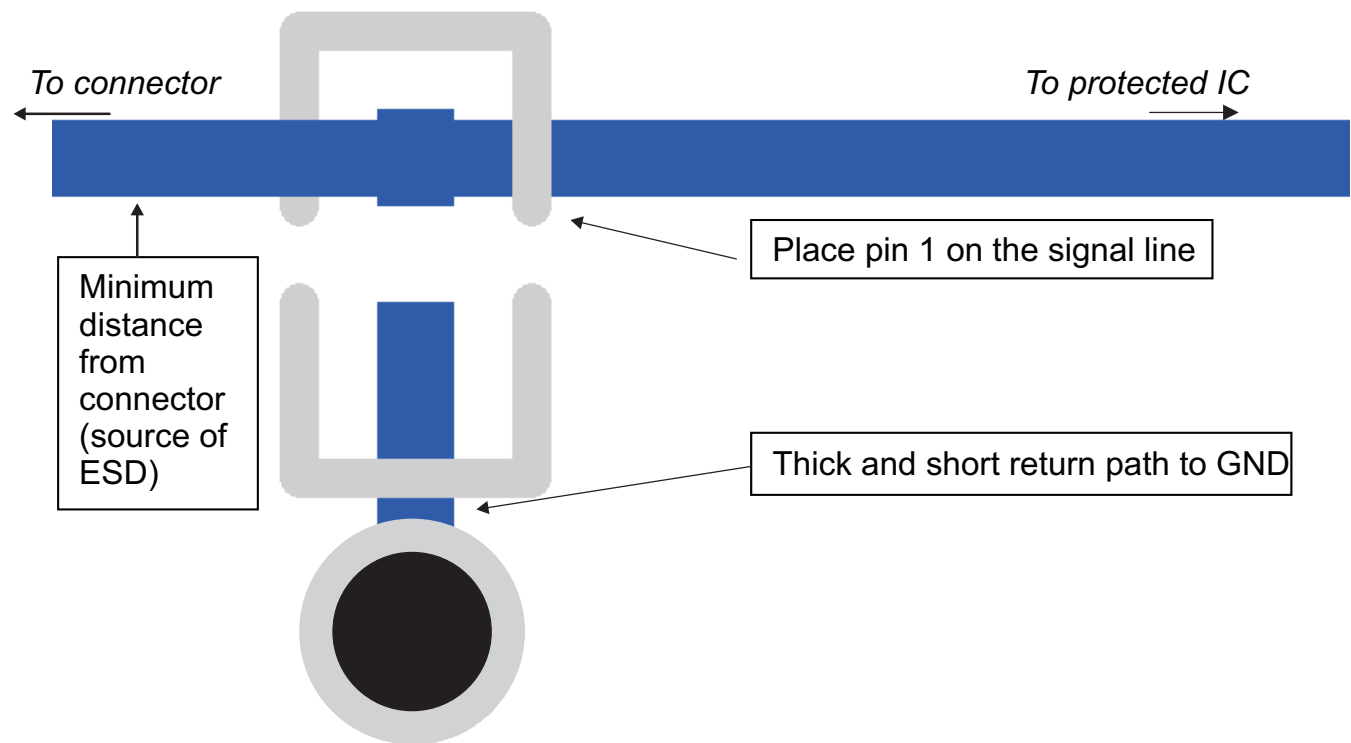

Figure 13. Layout Recommendation

11 Device and Documentation Support

11.1 Documentation Support

11.1.1 Related Documentation

For related documentation see the following:

- [TPD1E10B06-Q1 Evaluation Module User's Guide](#)
- [Reading and Understanding an ESD Protection Datasheet](#)
- [ESD Layout Guide](#)
- [ESD PROTECTION DIODES EVM](#)

11.2 Receiving Notification of Documentation Updates

To receive notification of documentation updates, navigate to the device product folder on [ti.com](#). In the upper right corner, click on *Alert me* to register and receive a weekly digest of any product information that has changed. For change details, review the revision history included in any revised document.

11.3 Community Resources

The following links connect to TI community resources. Linked contents are provided "AS IS" by the respective contributors. They do not constitute TI specifications and do not necessarily reflect TI's views; see TI's [Terms of Use](#).

TI E2E™ Online Community *TI's Engineer-to-Engineer (E2E) Community*. Created to foster collaboration among engineers. At [e2e.ti.com](#), you can ask questions, share knowledge, explore ideas and help solve problems with fellow engineers.

Design Support *TI's Design Support* Quickly find helpful E2E forums along with design support tools and contact information for technical support.

11.4 Trademarks

E2E is a trademark of Texas Instruments.
All other trademarks are the property of their respective owners.

11.5 Electrostatic Discharge Caution



This integrated circuit can be damaged by ESD. Texas Instruments recommends that all integrated circuits be handled with appropriate precautions. Failure to observe proper handling and installation procedures can cause damage.

ESD damage can range from subtle performance degradation to complete device failure. Precision integrated circuits may be more susceptible to damage because very small parametric changes could cause the device not to meet its published specifications.

11.6 Glossary

[SLYZ022](#) — *TI Glossary*.

This glossary lists and explains terms, acronyms, and definitions.

12 Mechanical, Packaging, and Orderable Information

The following pages include mechanical, packaging, and orderable information. This information is the most current data available for the designated devices. This data is subject to change without notice and revision of this document. For browser-based versions of this data sheet, refer to the left-hand navigation.

PACKAGING INFORMATION

Orderable Device	Status (1)	Package Type	Package Drawing	Pins	Package Qty	Eco Plan (2)	Lead/Ball Finish (6)	MSL Peak Temp (3)	Op Temp (°C)	Device Marking (4/5)	Samples
TPD1E10B06QDPYRQ1	ACTIVE	X1SON	DPY	2	10000	Green (RoHS & no Sb/Br)	CU NIPDAU	Level-1-260C-UNLIM	-40 to 125	4M	Samples

(1) The marketing status values are defined as follows:

ACTIVE: Product device recommended for new designs.

LIFEBUY: TI has announced that the device will be discontinued, and a lifetime-buy period is in effect.

NRND: Not recommended for new designs. Device is in production to support existing customers, but TI does not recommend using this part in a new design.

PREVIEW: Device has been announced but is not in production. Samples may or may not be available.

OBSELETE: TI has discontinued the production of the device.

(2) Eco Plan - The planned eco-friendly classification: Pb-Free (RoHS), Pb-Free (RoHS Exempt), or Green (RoHS & no Sb/Br) - please check <http://www.ti.com/productcontent> for the latest availability information and additional product content details.

TBD: The Pb-Free/Green conversion plan has not been defined.

Pb-Free (RoHS): TI's terms "Lead-Free" or "Pb-Free" mean semiconductor products that are compatible with the current RoHS requirements for all 6 substances, including the requirement that lead not exceed 0.1% by weight in homogeneous materials. Where designed to be soldered at high temperatures, TI Pb-Free products are suitable for use in specified lead-free processes.

Pb-Free (RoHS Exempt): This component has a RoHS exemption for either 1) lead-based flip-chip solder bumps used between the die and package, or 2) lead-based die adhesive used between the die and leadframe. The component is otherwise considered Pb-Free (RoHS compatible) as defined above.

Green (RoHS & no Sb/Br): TI defines "Green" to mean Pb-Free (RoHS compatible), and free of Bromine (Br) and Antimony (Sb) based flame retardants (Br or Sb do not exceed 0.1% by weight in homogeneous material)

(3) MSL, Peak Temp. - The Moisture Sensitivity Level rating according to the JEDEC industry standard classifications, and peak solder temperature.

(4) There may be additional marking, which relates to the logo, the lot trace code information, or the environmental category on the device.

(5) Multiple Device Markings will be inside parentheses. Only one Device Marking contained in parentheses and separated by a "~" will appear on a device. If a line is indented then it is a continuation of the previous line and the two combined represent the entire Device Marking for that device.

(6) Lead/Ball Finish - Orderable Devices may have multiple material finish options. Finish options are separated by a vertical ruled line. Lead/Ball Finish values may wrap to two lines if the finish value exceeds the maximum column width.

Important Information and Disclaimer:The information provided on this page represents TI's knowledge and belief as of the date that it is provided. TI bases its knowledge and belief on information provided by third parties, and makes no representation or warranty as to the accuracy of such information. Efforts are underway to better integrate information from third parties. TI has taken and continues to take reasonable steps to provide representative and accurate information but may not have conducted destructive testing or chemical analysis on incoming materials and chemicals. TI and TI suppliers consider certain information to be proprietary, and thus CAS numbers and other limited information may not be available for release.

In no event shall TI's liability arising out of such information exceed the total purchase price of the TI part(s) at issue in this document sold by TI to Customer on an annual basis.

OTHER QUALIFIED VERSIONS OF TPD1E10B06-Q1 :

- Catalog: [TPD1E10B06](#)

NOTE: Qualified Version Definitions:

- Catalog - TI's standard catalog product

TAPE AND REEL INFORMATION



QUADRANT ASSIGNMENTS FOR PIN 1 ORIENTATION IN TAPE



*All dimensions are nominal

Device	Package Type	Package Drawing	Pins	SPQ	Reel Diameter (mm)	Reel Width W1 (mm)	A0 (mm)	B0 (mm)	K0 (mm)	P1 (mm)	W (mm)	Pin1 Quadrant
TPD1E10B06QDPYRQ1	X1SON	DPY	2	10000	180.0	9.5	0.72	1.12	0.43	2.0	8.0	Q1

TAPE AND REEL BOX DIMENSIONS



*All dimensions are nominal

Device	Package Type	Package Drawing	Pins	SPQ	Length (mm)	Width (mm)	Height (mm)
TPD1E10B06QDPYRQ1	X1SON	DPY	2	10000	189.0	185.0	36.0

DPY (R-PX1SON-N2)

PLASTIC SMALL OUTLINE NO-LEAD

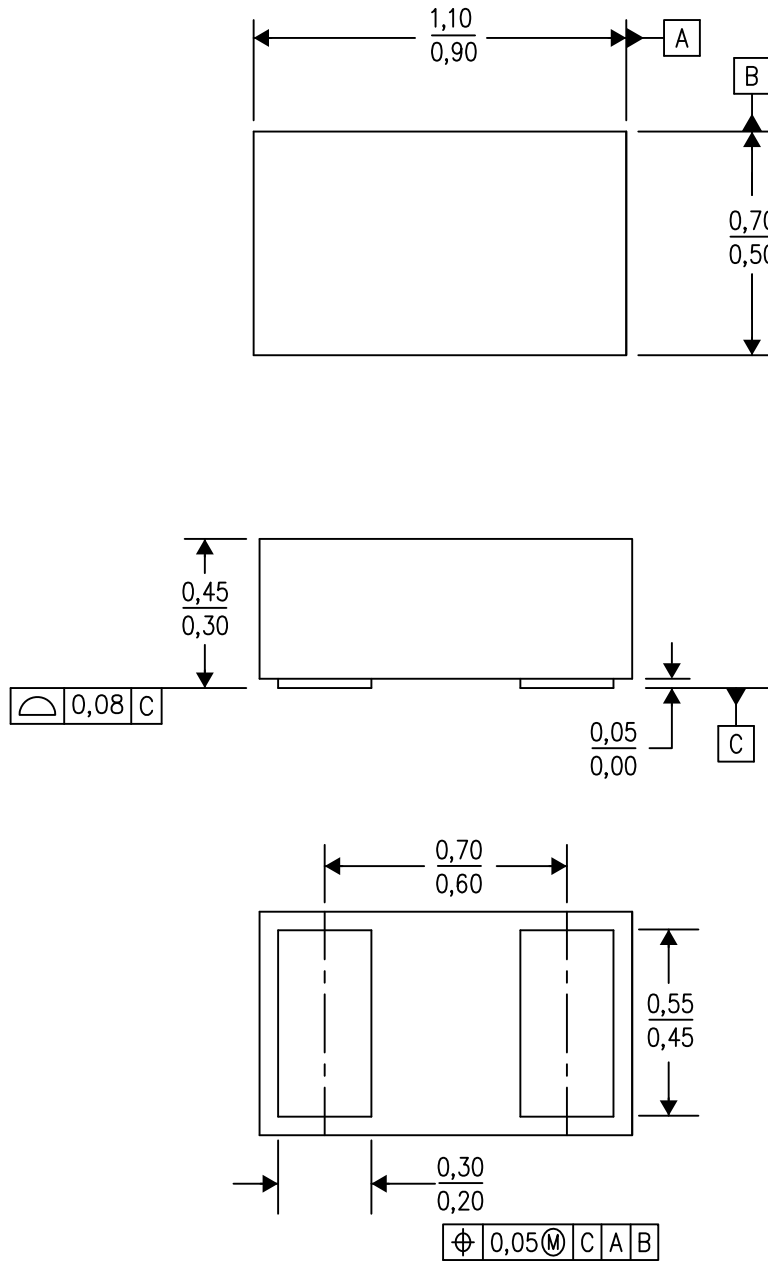

4211012/D 08/14

- NOTES:
- A. All linear dimensions are in millimeters. Dimensioning and tolerancing per ASME Y14.5-1994.
 - B. This drawing is subject to change without notice.
 - C. SON (Small Outline No-Lead) package configuration.

IMPORTANT NOTICE AND DISCLAIMER

TI PROVIDES TECHNICAL AND RELIABILITY DATA (INCLUDING DATASHEETS), DESIGN RESOURCES (INCLUDING REFERENCE DESIGNS), APPLICATION OR OTHER DESIGN ADVICE, WEB TOOLS, SAFETY INFORMATION, AND OTHER RESOURCES "AS IS" AND WITH ALL FAULTS, AND DISCLAIMS ALL WARRANTIES, EXPRESS AND IMPLIED, INCLUDING WITHOUT LIMITATION ANY IMPLIED WARRANTIES OF MERCHANTABILITY, FITNESS FOR A PARTICULAR PURPOSE OR NON-INFRINGEMENT OF THIRD PARTY INTELLECTUAL PROPERTY RIGHTS.

These resources are intended for skilled developers designing with TI products. You are solely responsible for (1) selecting the appropriate TI products for your application, (2) designing, validating and testing your application, and (3) ensuring your application meets applicable standards, and any other safety, security, or other requirements. These resources are subject to change without notice. TI grants you permission to use these resources only for development of an application that uses the TI products described in the resource. Other reproduction and display of these resources is prohibited. No license is granted to any other TI intellectual property right or to any third party intellectual property right. TI disclaims responsibility for, and you will fully indemnify TI and its representatives against, any claims, damages, costs, losses, and liabilities arising out of your use of these resources.

TI's products are provided subject to TI's Terms of Sale (www.ti.com/legal/termsofsale.html) or other applicable terms available either on ti.com or provided in conjunction with such TI products. TI's provision of these resources does not expand or otherwise alter TI's applicable warranties or warranty disclaimers for TI products.

Mailing Address: Texas Instruments, Post Office Box 655303, Dallas, Texas 75265
Copyright © 2019, Texas Instruments Incorporated