

## TPD1E1B04 1-Channel ESD Protection Diode with Low $R_{DYN}$ and Low Clamping Voltage

### 1 Features

- IEC 61000-4-2 Level 4 ESD Protection
  - $\pm 30$ -kV Contact Discharge
  - $\pm 30$ -kV Air Gap Discharge
- IEC 61000-4-4 EFT Protection
  - 80 A (5/50 ns)
- IEC 61000-4-5 Surge Protection
  - 6.3 A (8/20  $\mu$ s)
- IO Capacitance: 1 pF (Typical)
- DC Breakdown Voltage: 6.4 V (Typical)
- Low Leakage Current: 100 nA (Maximum)
- Extremely Low ESD Clamping Voltage
  - 8.5 V at  $\pm 16$ -A TLP
  - $R_{DYN}$ : 0.15  $\Omega$
- Industrial Temperature Range:  $-40^{\circ}\text{C}$  to  $+125^{\circ}\text{C}$
- Industry Standard 0402 Package

### 2 Applications

- End Equipment
  - Wearables
  - Laptops and Desktops
  - Mobile and Tablets
  - Set-Top Boxes
  - DVR and NVR
  - TV and Monitors
  - EPOS (Electronic Point of Sale)
- Interfaces
  - USB 2.0/1.1
  - GPIO
  - Pushbuttons
  - Audio

### 3 Description

The TPD1E1B04 is a bidirectional TVS ESD protection diode featuring low  $R_{DYN}$  and low clamping voltage. The TPD1E1B04 is rated to dissipate ESD strikes at the maximum level specified in the IEC 61000-4-2 international standard (Level 4).

The ultra-low dynamic resistance (0.15  $\Omega$ ) and extremely low clamping voltage (8.5 V at 16-A TLP) ensure system level protection against transient events. This device features a 1-pF IO capacitance making it ideal for protecting interfaces such as USB 2.0.

The TPD1E1B04 is offered in the industry standard 0402 (DPY) package.

#### Device Information<sup>(1)</sup>

PART NUMBER	PACKAGE	BODY SIZE (NOM)
TPD1E1B04	X1SON (2)	0.60 mm x 1.00 mm

(1) For all available packages, see the orderable addendum at the end of the data sheet.

#### Typical USB 2.0 Application Schematic

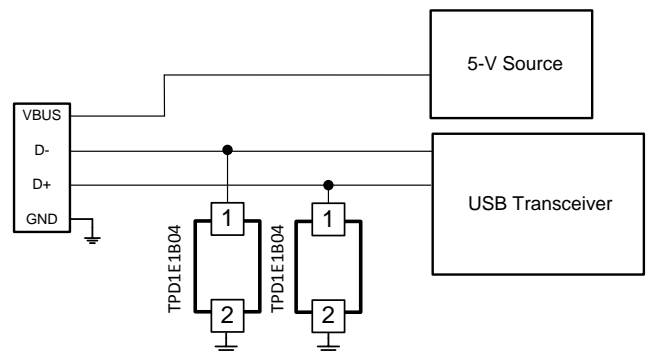

Copyright © 2016, Texas Instruments Incorporated



## Table of Contents

<b>1 Features</b> ..... 1 <b>2 Applications</b> ..... 1 <b>3 Description</b> ..... 1 <b>4 Revision History</b> ..... 2 <b>5 Pin Configuration and Functions</b> ..... 3 <b>6 Specifications</b> ..... 4 6.1 Absolute Maximum Ratings ..... 4 6.2 ESD Ratings..... 4 6.3 ESD Ratings—IEC Specification ..... 4 6.4 Recommended Operating Conditions ..... 4 6.5 Thermal Information ..... 4 6.6 Electrical Characteristics..... 5 6.7 Typical Characteristics ..... 6 <b>7 Detailed Description</b> ..... 8 7.1 Overview ..... 8 7.2 Functional Block Diagram ..... 8 7.3 Feature Description..... 8	7.4 Device Functional Modes..... 9 <b>8 Application and Implementation</b> ..... 10 8.1 Application Information..... 10 8.2 Typical Application ..... 10 <b>9 Power Supply Recommendations</b> ..... 12 <b>10 Layout</b> ..... 12 10.1 Layout Guidelines ..... 12 10.2 Layout Example ..... 12 <b>11 Device and Documentation Support</b> ..... 13 11.1 Documentation Support ..... 13 11.2 Receiving Notification of Documentation Updates 13 11.3 Community Resources..... 13 11.4 Trademarks ..... 13 11.5 Electrostatic Discharge Caution..... 13 11.6 Glossary ..... 13 <b>12 Mechanical, Packaging, and Orderable Information</b> ..... 13
---	---

## 4 Revision History

NOTE: Page numbers for previous revisions may differ from page numbers in the current version.

Changes from Original (May 2016) to Revision A	Page
<ul style="list-style-type: none"> <li>• Changed device status from <i>Product Preview</i> to <i>Production Data</i> ..... 1</li> </ul>	1

## 5 Pin Configuration and Functions

DPY Package  
2-Pin X1SON  
Top View

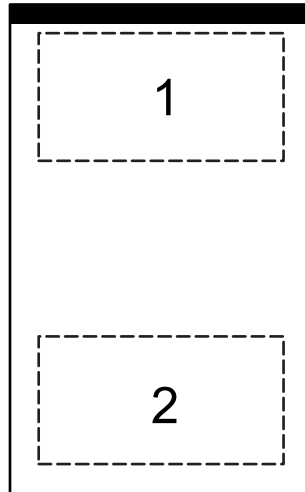

**Pin Functions**

PIN		I/O	DESCRIPTION
NO.	NAME		
1	IO	I/O	ESD Protected Channel. If used as ESD IO, connect pin 2 to ground
2	IO	I/O	ESD Protected Channel. If used as ESD IO, connect pin 1 to ground

## 6 Specifications

### 6.1 Absolute Maximum Ratings

over operating free-air temperature range (unless otherwise noted)<sup>(1)</sup>

		MIN	MAX	UNIT
Electrical fast transient	IEC 61000-4-4 (5/50 ns)		80	A
Peak pulse	IEC 61000-4-5 Power ( $t_p$ - 8/20 $\mu$ s)		50	W
	IEC 61000-4-5 Current ( $t_p$ - 8/20 $\mu$ s)		6.3	A
$T_A$	Operating free-air temperature	-40	125	°C
$T_{stg}$	Storage temperature	-65	155	°C

(1) Stresses beyond those listed under *Absolute Maximum Ratings* may cause permanent damage to the device. These are stress ratings only, which do not imply functional operation of the device at these or any other conditions beyond those indicated under *Recommended Operating Conditions*. Exposure to absolute-maximum-rated conditions for extended periods may affect device reliability.

### 6.2 ESD Ratings

		VALUE	UNIT
$V_{(ESD)}$ Electrostatic discharge	Human-body model (HBM), per ANSI/ESDA/JEDEC JS-001 <sup>(1)</sup>	±4000	V
	Charged-device model (CDM), per JEDEC specification JESD22-C101 <sup>(2)</sup>	±1500	

(1) JEDEC document JEP155 states that 500-V HBM allows safe manufacturing with a standard ESD control process.

(2) JEDEC document JEP157 states that 250-V CDM allows safe manufacturing with a standard ESD control process.

### 6.3 ESD Ratings—IEC Specification

		VALUE	UNIT
$V_{(ESD)}$ Electrostatic discharge	IEC 61000-4-2 contact discharge	±30000	V
	IEC 61000-4-2 air-gap discharge	±30000	

### 6.4 Recommended Operating Conditions

over operating free-air temperature range (unless otherwise noted)

		MIN	MAX	UNIT
$V_{IO}$	Input pin voltage	-3.6	3.6	V
$T_A$	Operating free-air temperature	-40	125	°C

### 6.5 Thermal Information

THERMAL METRIC <sup>(1)</sup>	TPD1E1B04	UNIT	
	DPY (X1SON)		
	2 PINS		
$R_{\theta JA}$	Junction-to-ambient thermal resistance	420	°C/W
$R_{\theta JC(top)}$	Junction-to-case (top) thermal resistance	169.3	°C/W
$R_{\theta JB}$	Junction-to-board thermal resistance	276.1	°C/W
$\Psi_{JT}$	Junction-to-top characterization parameter	122.1	°C/W
$\Psi_{JB}$	Junction-to-board characterization parameter	157.3	°C/W
$R_{\theta JC(bot)}$	Junction-to-case (bottom) thermal resistance	N/A	°C/W

(1) For more information about traditional and new thermal metrics, see the [Semiconductor and IC Package Thermal Metrics](#) application report.

## 6.6 Electrical Characteristics

over operating free-air temperature range (unless otherwise noted)

PARAMETER		TEST CONDITIONS	MIN	TYP	MAX	UNIT
$V_{RWM}$	Reverse stand-off voltage	$I_{IO} < 100 \text{ nA}$	-3.6		3.6	V
$V_{BRF}$	Breakdown voltage, any IO pin to GND	Measured as the maximum voltage before device snaps back into $V_{HOLD}$ voltage		6.4		V
$V_{BRR}$	Breakdown voltage, GND to any IO pin	Measured as the maximum voltage before device snaps back into $V_{HOLD}$ voltage		-6.4		V
$V_{HOLD}$	Holding voltage	$I_{IO} = 1 \text{ mA}$ , $T_A = 25^\circ\text{C}$	5	6	6.6	V
$V_{CLAMP}$	Clamping voltage	$I_{PP} = 1 \text{ A}$ , TLP, from IO to GND		6.3		V
		$I_{PP} = 5 \text{ A}$ , TLP, from IO to GND		6.8		
		$I_{PP} = 16 \text{ A}$ , TLP, from IO to GND		8.5		
		$I_{PP} = 1 \text{ A}$ , TLP, from GND to IO		6.3		
		$I_{PP} = 5 \text{ A}$ , TLP, from GND to IO		6.8		
		$I_{PP} = 16 \text{ A}$ , TLP, from GND to IO		8.5		
$I_{LEAK}$	Leakage current, IO to GND	$V_{IO} = \pm 2.5 \text{ V}$		0.2	100	nA
$R_{DYN}$	Dynamic resistance	IO to GND		0.15		$\Omega$
		GND to IO		0.15		
$C_L$	Line capacitance	$V_{IO} = 0 \text{ V}$ , $f = 1 \text{ MHz}$ , IO to GND, $T_A = 25^\circ\text{C}$		1	1.3	pF

### 6.7 Typical Characteristics

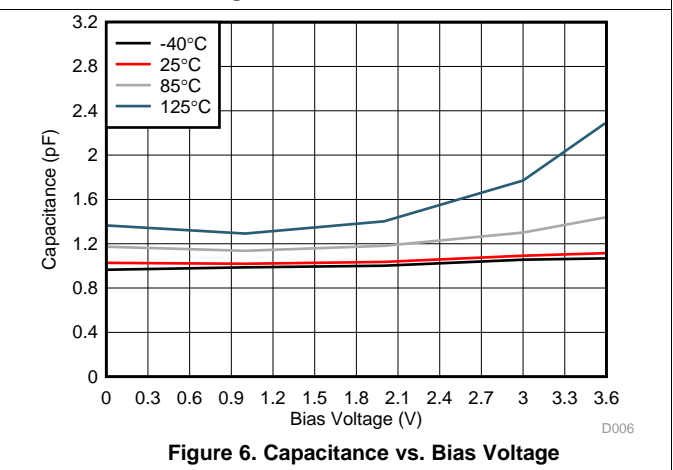
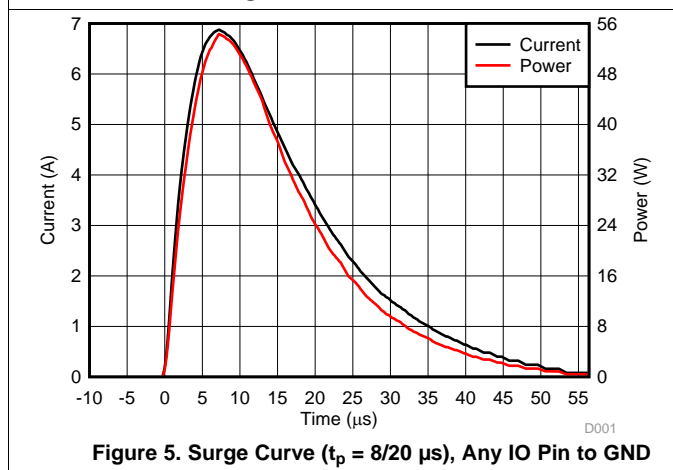
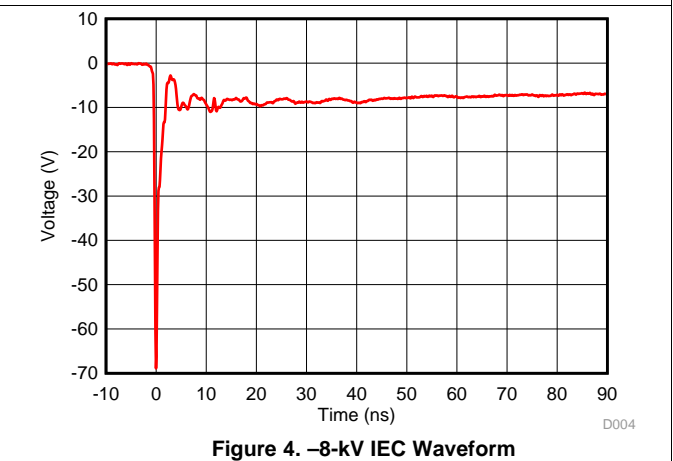
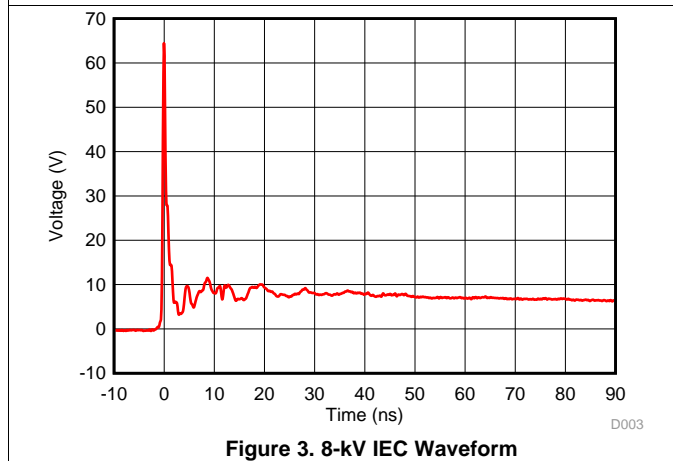
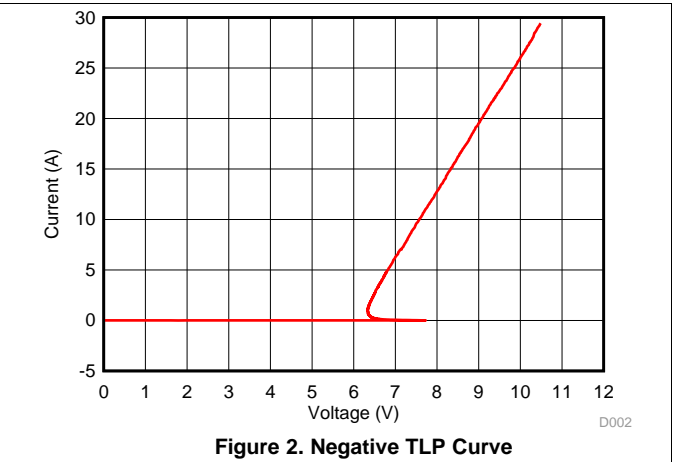
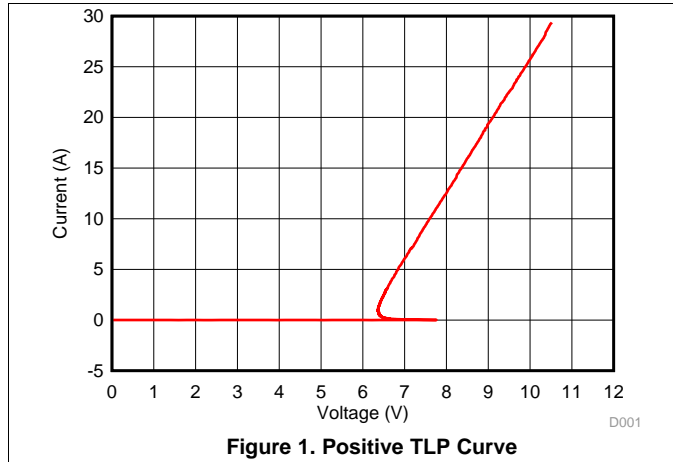

**Typical Characteristics (continued)**

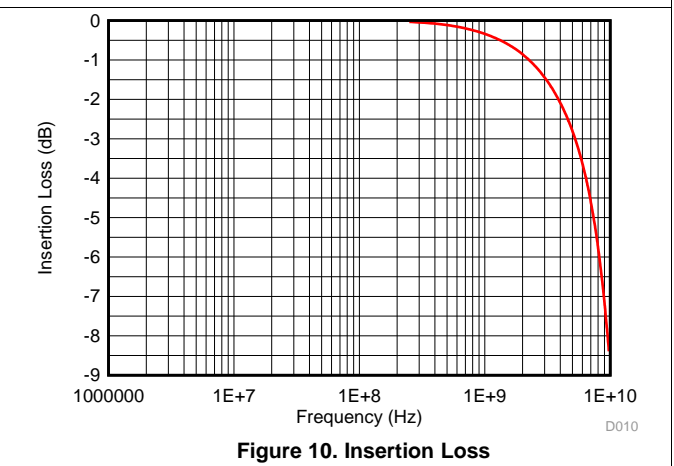
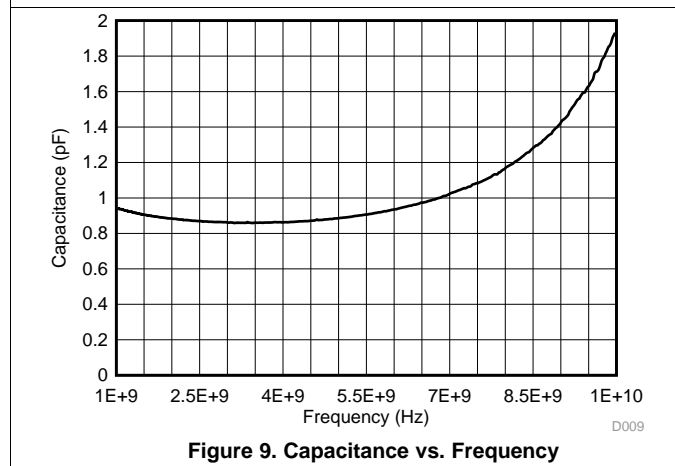
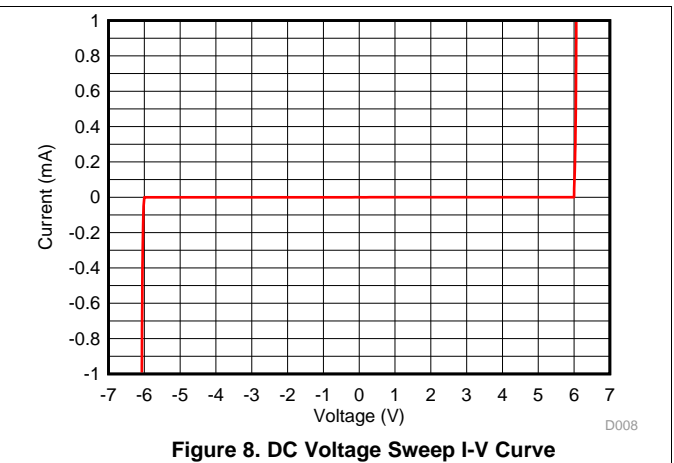
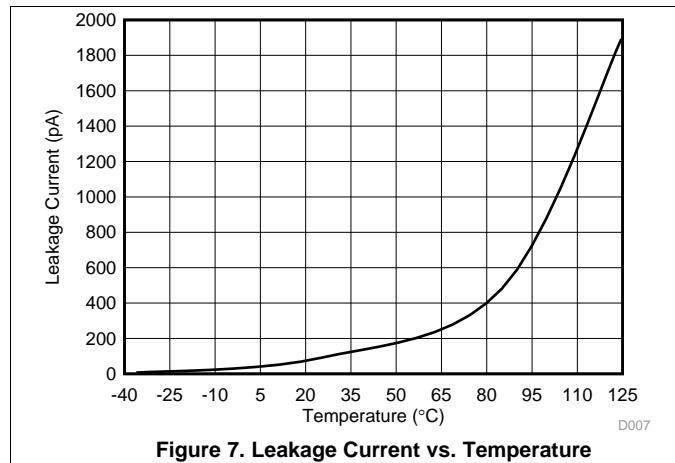

## 7 Detailed Description

### 7.1 Overview

The TPD1E1B04 is a bidirectional ESD Protection Diode with ultra-low clamping voltage. This device can dissipate ESD strikes above the maximum level specified by the IEC 61000-4-2 International Standard. The ultra-low clamping makes this device ideal for protecting any sensitive signal pins.

### 7.2 Functional Block Diagram

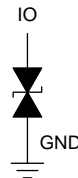

Copyright © 2016, Texas Instruments Incorporated

### 7.3 Feature Description

#### 7.3.1 IEC 61000-4-2 ESD Protection

The I/O pins can withstand ESD events up to  $\pm 30$ -kV contact and  $\pm 30$ -kV air gap. An ESD-surge clamp diverts the current to ground.

#### 7.3.2 IEC 61000-4-4 EFT Protection

The I/O pins can withstand an electrical fast transient burst of up to 80 A (5/50 ns waveform, 4 kV with 50- $\Omega$  impedance). An ESD-surge clamp diverts the current to ground.

#### 7.3.3 IEC 61000-4-5 Surge Protection

The I/O pins can withstand surge events up to 6.3 A and 50 W (8/20  $\mu$ s waveform). An ESD-surge clamp diverts this current to ground.

#### 7.3.4 IO Capacitance

The capacitance between each I/O pin to ground is 1 pF (typical) and 1.3 pF (maximum).

#### 7.3.5 DC Breakdown Voltage

The DC breakdown voltage of each I/O pin is  $\pm 6.4$  V typical. This ensures that sensitive equipment is protected from surges above the reverse standoff voltage of  $\pm 3.6$  V.

#### 7.3.6 Low Leakage Current

The I/O pins feature a low leakage current of 100 nA (maximum) with a bias of  $\pm 2.5$  V.

#### 7.3.7 Extremely Low ESD Clamping Voltage

The I/O pins feature an ESD clamp that is capable of clamping the voltage to 8.5 V ( $I_{PP} = 16$  A).

#### 7.3.8 Industrial Temperature Range

This device features an industrial operating range of  $-40^{\circ}\text{C}$  to  $+125^{\circ}\text{C}$ .

#### 7.3.9 Industry Standard Footprint

The layout of this device makes it simple and easy to add protection to an existing layout. The packages offers flow-through routing, requiring minimal modification to an existing layout.



## 7.4 Device Functional Modes

The TPD1E1B04 is a passive integrated circuit that triggers when voltages are above  $V_{BRF}$  or below  $V_{BRR}$ . During ESD events, voltages as high as  $\pm 30$  kV (contact or air) can be directed to ground via the internal diode network. When the voltages on the protected line fall below the trigger levels of TPD1E1B04 (usually within 10s of nanoseconds) the device reverts to passive.

## 8 Application and Implementation

### NOTE

Information in the following applications sections is not part of the TI component specification, and TI does not warrant its accuracy or completeness. TI's customers are responsible for determining suitability of components for their purposes. Customers should validate and test their design implementation to confirm system functionality.

### 8.1 Application Information

The TPD1E1B04 is a diode type TVS which is used to provide a path to ground for dissipating ESD events on high-speed signal lines between a human interface connector and a system. As the current from ESD passes through the TVS, only a small voltage drop is present across the diode. This is the voltage presented to the protected IC. The low  $R_{DYN}$  of the triggered TVS holds this voltage,  $V_{CLAMP}$ , to a safe level for the protected IC.

### 8.2 Typical Application

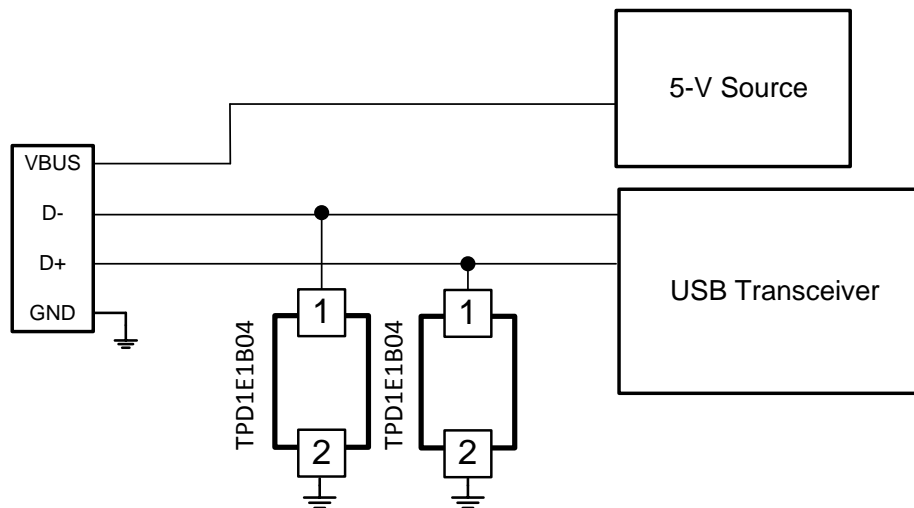

Copyright © 2016, Texas Instruments Incorporated

Figure 11. USB 2.0 ESD Schematic

#### 8.2.1 Design Requirements

For this design example, two TPD1E1B04 devices are being used in a USB 2.0 application. This provides a complete ESD protection scheme.

Given the USB 2.0 application, the parameters listed in [Table 1](#) are known.

Table 1. Design Parameters

DESIGN PARAMETER	VALUE
Signal range on DP-DM lines	0 V to 3.6 V
Operating frequency on DP-DM lines	up to 240 MHz

#### 8.2.2 Detailed Design Procedure

##### 8.2.2.1 Signal Range

The TPD1E1B04 supports signal ranges between  $-3.6$  V and  $3.6$  V, which supports the USB 2.0 signal pair on the USB 2.0 application.

**8.2.2.2 Operating Frequency**

The TPD1E1B04 has a 1-pF (typical) capacitance, which supports the USB 2.0 data rates of 480 Mbps.

**8.2.3 Application Curve**

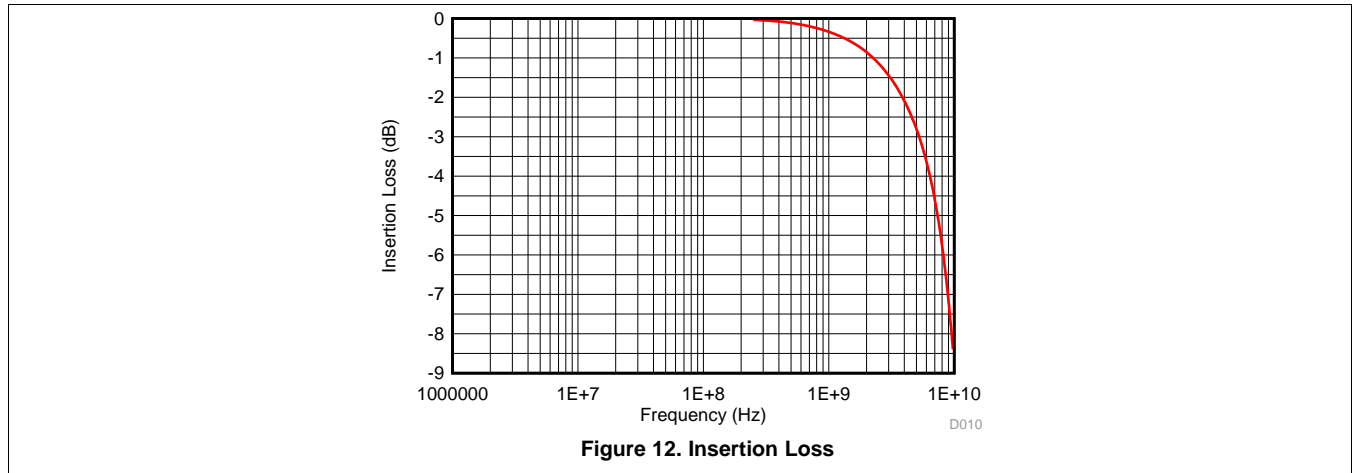

## 9 Power Supply Recommendations

The TPD1E1B04 is a passive ESD device so there is no need to power it. Take care not to violate the recommended I/O specification (–3.6 V to 3.6 V) to ensure the device functions properly.

## 10 Layout

### 10.1 Layout Guidelines

- The optimum placement is as close to the connector as possible.
  - EMI during an ESD event can couple from the trace being struck to other nearby unprotected traces, resulting in early system failures.
  - The PCB designer must minimize the possibility of EMI coupling by keeping any unprotected traces away from the protected traces which are between the TVS and the connector.
- Route the protected traces as straight as possible.
- Eliminate any sharp corners on the protected traces between the TVS and the connector by using rounded corners with the largest radii possible.
  - Electric fields tend to build up on corners, increasing EMI coupling.

### 10.2 Layout Example

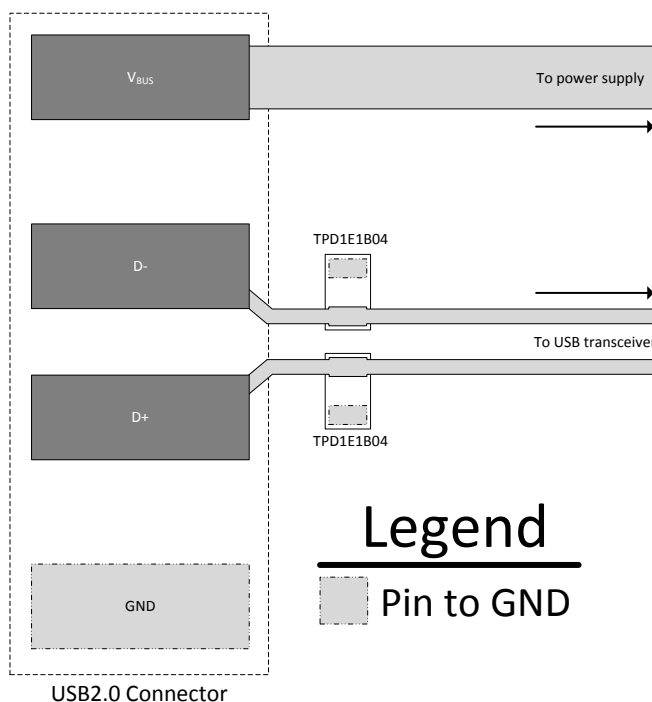

**Figure 13. USB 2.0 ESD Layout**

## 11 Device and Documentation Support

### 11.1 Documentation Support

#### 11.1.1 Related Documentation

For related documentation see the following:

*TPD1E1B04 Evaluation Module*, [SLVUAN7](#)

### 11.2 Receiving Notification of Documentation Updates

To receive notification of documentation updates, navigate to the device product folder on [ti.com](#). In the upper right corner, click on *Alert me* to register and receive a weekly digest of any product information that has changed. For change details, review the revision history included in any revised document.

### 11.3 Community Resources

The following links connect to TI community resources. Linked contents are provided "AS IS" by the respective contributors. They do not constitute TI specifications and do not necessarily reflect TI's views; see TI's [Terms of Use](#).

**TI E2E™ Online Community** *TI's Engineer-to-Engineer (E2E) Community*. Created to foster collaboration among engineers. At [e2e.ti.com](#), you can ask questions, share knowledge, explore ideas and help solve problems with fellow engineers.

**Design Support** *TI's Design Support* Quickly find helpful E2E forums along with design support tools and contact information for technical support.

### 11.4 Trademarks

E2E is a trademark of Texas Instruments.

All other trademarks are the property of their respective owners.

### 11.5 Electrostatic Discharge Caution



This integrated circuit can be damaged by ESD. Texas Instruments recommends that all integrated circuits be handled with appropriate precautions. Failure to observe proper handling and installation procedures can cause damage.

ESD damage can range from subtle performance degradation to complete device failure. Precision integrated circuits may be more susceptible to damage because very small parametric changes could cause the device not to meet its published specifications.

### 11.6 Glossary

[SLYZ022](#) — *TI Glossary*.

This glossary lists and explains terms, acronyms, and definitions.

## 12 Mechanical, Packaging, and Orderable Information

The following pages include mechanical, packaging, and orderable information. This information is the most current data available for the designated devices. This data is subject to change without notice and revision of this document. For browser-based versions of this data sheet, refer to the left-hand navigation.

**PACKAGING INFORMATION**

Orderable Device	Status (1)	Package Type	Package Drawing	Pins	Package Qty	Eco Plan (2)	Lead finish/ Ball material (6)	MSL Peak Temp (3)	Op Temp (°C)	Device Marking (4/5)	Samples
TPD1E1B04DPYR	ACTIVE	X1SON	DPY	2	10000	RoHS & Green	NIPDAU   NIPDAUAG	Level-1-260C-UNLIM	-40 to 125	(4X, A5)	<a href="#">Samples</a>
TPD1E1B04DPYT	ACTIVE	X1SON	DPY	2	250	RoHS & Green	NIPDAU   NIPDAUAG	Level-1-260C-UNLIM	-40 to 125	4X	<a href="#">Samples</a>

(1) The marketing status values are defined as follows:

**ACTIVE:** Product device recommended for new designs.

**LIFEBUY:** TI has announced that the device will be discontinued, and a lifetime-buy period is in effect.

**NRND:** Not recommended for new designs. Device is in production to support existing customers, but TI does not recommend using this part in a new design.

**PREVIEW:** Device has been announced but is not in production. Samples may or may not be available.

**OBSOLETE:** TI has discontinued the production of the device.

(2) **RoHS:** TI defines "RoHS" to mean semiconductor products that are compliant with the current EU RoHS requirements for all 10 RoHS substances, including the requirement that RoHS substance do not exceed 0.1% by weight in homogeneous materials. Where designed to be soldered at high temperatures, "RoHS" products are suitable for use in specified lead-free processes. TI may reference these types of products as "Pb-Free".

**RoHS Exempt:** TI defines "RoHS Exempt" to mean products that contain lead but are compliant with EU RoHS pursuant to a specific EU RoHS exemption.

**Green:** TI defines "Green" to mean the content of Chlorine (Cl) and Bromine (Br) based flame retardants meet JS709B low halogen requirements of <=1000ppm threshold. Antimony trioxide based flame retardants must also meet the <=1000ppm threshold requirement.

(3) MSL, Peak Temp. - The Moisture Sensitivity Level rating according to the JEDEC industry standard classifications, and peak solder temperature.

(4) There may be additional marking, which relates to the logo, the lot trace code information, or the environmental category on the device.

(5) Multiple Device Markings will be inside parentheses. Only one Device Marking contained in parentheses and separated by a "~" will appear on a device. If a line is indented then it is a continuation of the previous line and the two combined represent the entire Device Marking for that device.

(6) Lead finish/Ball material - Orderable Devices may have multiple material finish options. Finish options are separated by a vertical ruled line. Lead finish/Ball material values may wrap to two lines if the finish value exceeds the maximum column width.

**Important Information and Disclaimer:**The information provided on this page represents TI's knowledge and belief as of the date that it is provided. TI bases its knowledge and belief on information provided by third parties, and makes no representation or warranty as to the accuracy of such information. Efforts are underway to better integrate information from third parties. TI has taken and continues to take reasonable steps to provide representative and accurate information but may not have conducted destructive testing or chemical analysis on incoming materials and chemicals. TI and TI suppliers consider certain information to be proprietary, and thus CAS numbers and other limited information may not be available for release.

In no event shall TI's liability arising out of such information exceed the total purchase price of the TI part(s) at issue in this document sold by TI to Customer on an annual basis.



**TAPE AND REEL INFORMATION**

**QUADRANT ASSIGNMENTS FOR PIN 1 ORIENTATION IN TAPE**

\*All dimensions are nominal

Device	Package Type	Package Drawing	Pins	SPQ	Reel Diameter (mm)	Reel Width W1 (mm)	A0 (mm)	B0 (mm)	K0 (mm)	P1 (mm)	W (mm)	Pin1 Quadrant
TPD1E1B04DPYT	X1SON	DPY	2	250	180.0	9.5	0.66	1.15	0.66	2.0	8.0	Q1



**TAPE AND REEL BOX DIMENSIONS**

\*All dimensions are nominal

Device	Package Type	Package Drawing	Pins	SPQ	Length (mm)	Width (mm)	Height (mm)
TPD1E1B04DPYT	X1SON	DPY	2	250	184.0	184.0	19.0

DPY (R-PX1SON-N2)

PLASTIC SMALL OUTLINE NO-LEAD

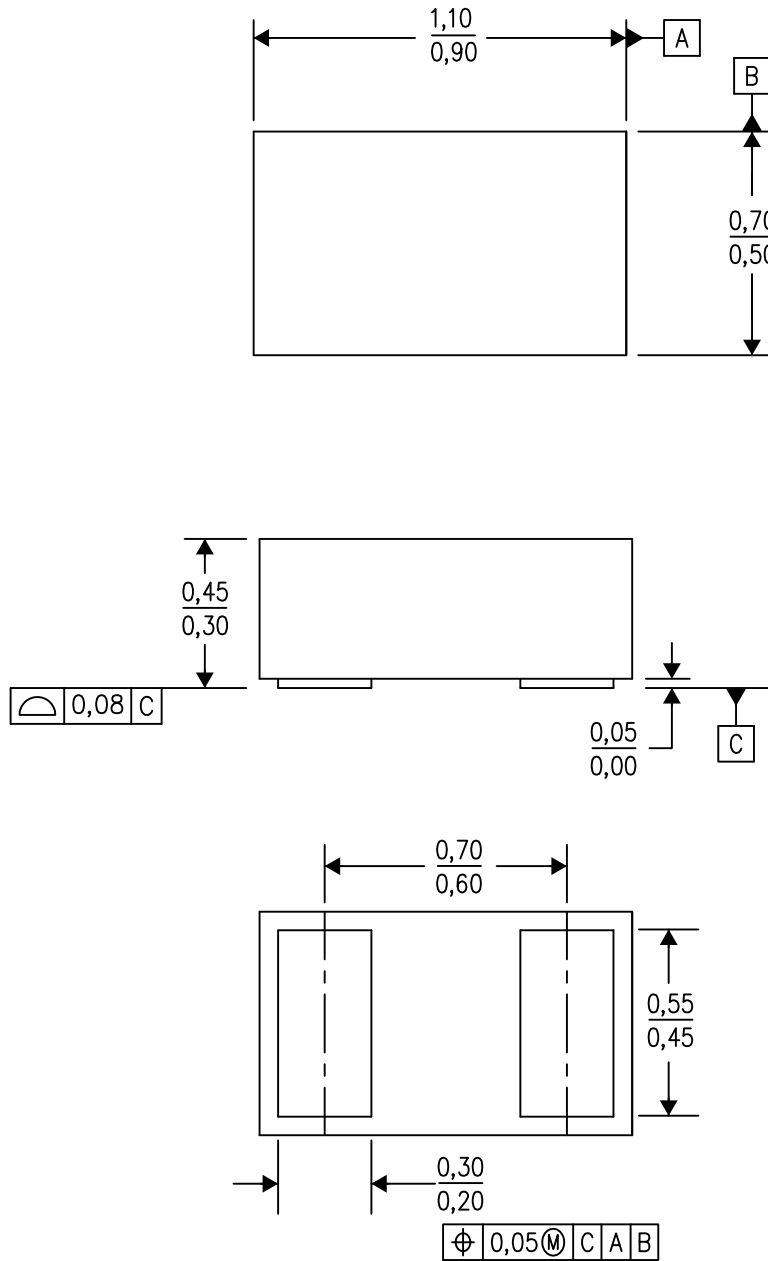

4211012/D 08/14

- NOTES:
- A. All linear dimensions are in millimeters. Dimensioning and tolerancing per ASME Y14.5-1994.
  - B. This drawing is subject to change without notice.
  - C. SON (Small Outline No-Lead) package configuration.

DPY0002A

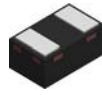

**PACKAGE OUTLINE**  
**X1SON - 0.45 mm max height**

PLASTIC SMALL OUTLINE - NO LEAD

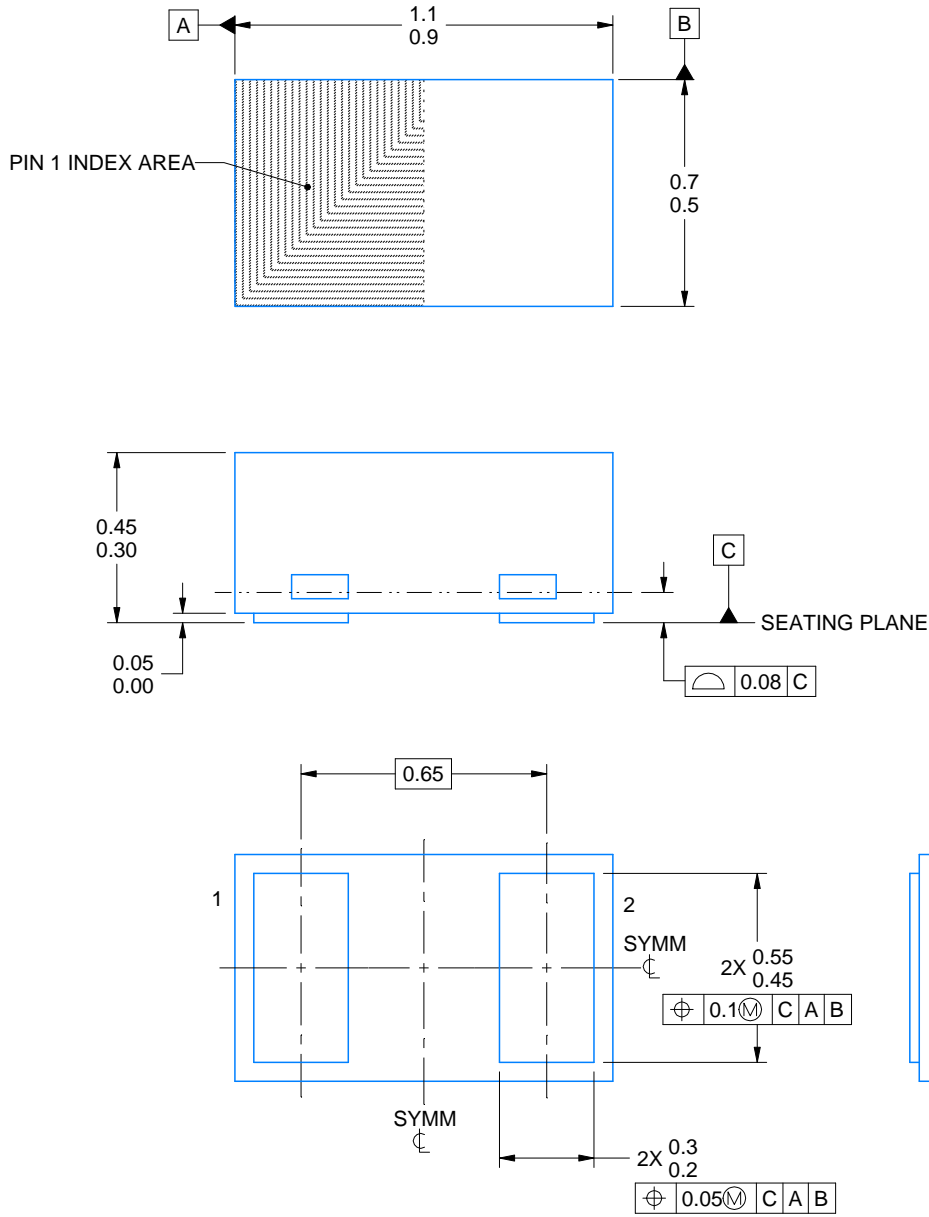

4224561/B 03/2021

NOTES:

1. All linear dimensions are in millimeters. Any dimensions in parenthesis are for reference only. Dimensioning and tolerancing per ASME Y14.5M
2. This drawing is subject to change without notice.

# EXAMPLE BOARD LAYOUT

DPY0002A

X1SON - 0.45 mm max height

PLASTIC SMALL OUTLINE - NO LEAD

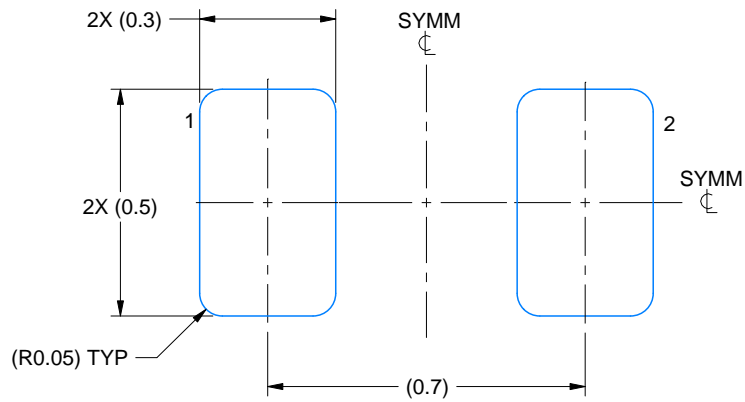

LAND PATTERN EXAMPLE  
EXPOSED METAL SHOWN  
SCALE:60X

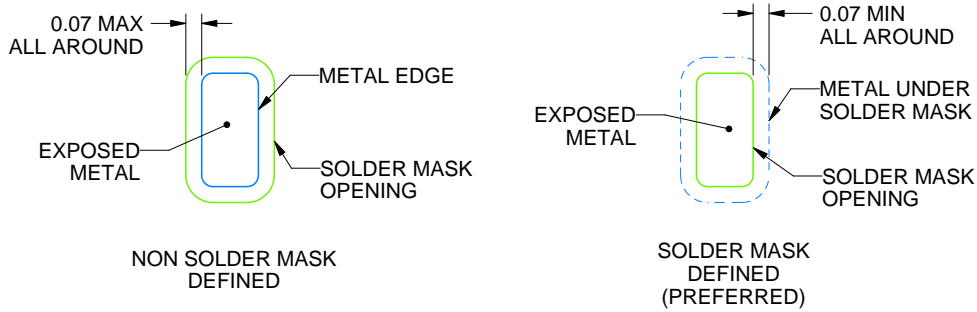

SOLDER MASK DETAILS

4224561/B 03/2021

NOTES: (continued)

3. For more information, see Texas Instruments literature number SLUA271 ([www.ti.com/lit/slue271](http://www.ti.com/lit/slue271)).
4. Vias are optional depending on application, refer to device data sheet. If any vias are implemented, refer to their locations shown on this view. It is recommended that vias under paste be filled, plugged or tented.

# EXAMPLE STENCIL DESIGN

DPY0002A

X1SON - 0.45 mm max height

PLASTIC SMALL OUTLINE - NO LEAD

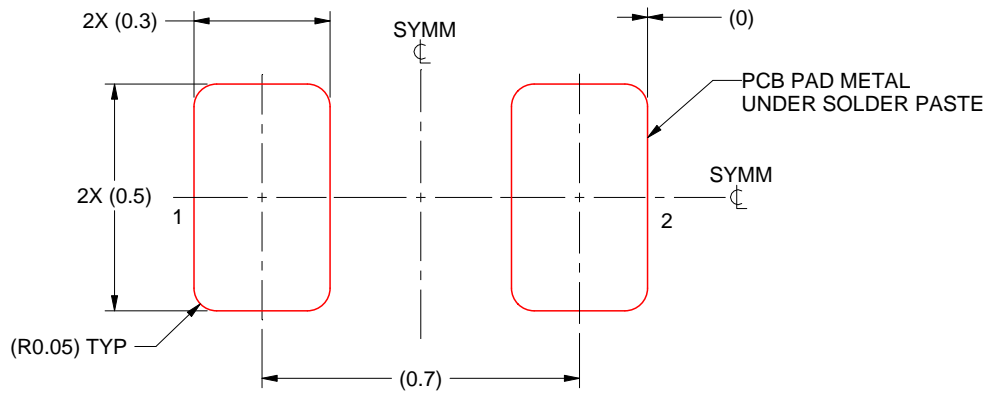

SOLDER PASTE EXAMPLE  
BASED ON 0.1 mm THICK STENCIL  
SCALE:60X

4224561/B 03/2021

NOTES: (continued)

5. Laser cutting apertures with trapezoidal walls and rounded corners may offer better paste release. IPC-7525 may have alternate design recommendations.

## IMPORTANT NOTICE AND DISCLAIMER

TI PROVIDES TECHNICAL AND RELIABILITY DATA (INCLUDING DATA SHEETS), DESIGN RESOURCES (INCLUDING REFERENCE DESIGNS), APPLICATION OR OTHER DESIGN ADVICE, WEB TOOLS, SAFETY INFORMATION, AND OTHER RESOURCES "AS IS" AND WITH ALL FAULTS, AND DISCLAIMS ALL WARRANTIES, EXPRESS AND IMPLIED, INCLUDING WITHOUT LIMITATION ANY IMPLIED WARRANTIES OF MERCHANTABILITY, FITNESS FOR A PARTICULAR PURPOSE OR NON-INFRINGEMENT OF THIRD PARTY INTELLECTUAL PROPERTY RIGHTS.

These resources are intended for skilled developers designing with TI products. You are solely responsible for (1) selecting the appropriate TI products for your application, (2) designing, validating and testing your application, and (3) ensuring your application meets applicable standards, and any other safety, security, regulatory or other requirements.

These resources are subject to change without notice. TI grants you permission to use these resources only for development of an application that uses the TI products described in the resource. Other reproduction and display of these resources is prohibited. No license is granted to any other TI intellectual property right or to any third party intellectual property right. TI disclaims responsibility for, and you will fully indemnify TI and its representatives against, any claims, damages, costs, losses, and liabilities arising out of your use of these resources.

TI's products are provided subject to [TI's Terms of Sale](#) or other applicable terms available either on [ti.com](https://www.ti.com) or provided in conjunction with such TI products. TI's provision of these resources does not expand or otherwise alter TI's applicable warranties or warranty disclaimers for TI products.

TI objects to and rejects any additional or different terms you may have proposed.

Mailing Address: Texas Instruments, Post Office Box 655303, Dallas, Texas 75265  
Copyright © 2023, Texas Instruments Incorporated