

TPS51396A 4.5-V to 24-V, 8-A Synchronous Step-Down Voltage Regulator with ULQ™ Mode for Extended Battery Life

1 Features

- Input voltage range: 4.5 V to 24 V
- D-CAP3™ architecture control for fast transient response
- Output voltage range: 0.6 V to 7 V
- 1% feedback voltage accuracy (25°C)
- Continual output current: 8 A
- Integrated 19.5-mΩ and 9.5-mΩ $R_{DS(on)}$ internal power switch
- ULQ™ operation to enable long battery life during system standby
- Eco-Mode™ and OOA mode selectable for light load running by MODE pin
- 600-kHz, 800-kHz and 1-MHz selectable switching frequency by MODE pin
- Out-of-Audio (OOA) light-load operation with switching frequency over 25 kHz
- Large duty operation support
- Adjustable soft-start time by SS pin
- Power good indicator
- Built-in output discharge function
- Cycle-by-cycle over current protection
- Latched output for OV and UV protections
- Non-latched for OT and UVLO protections
- 20-pin 3.0-mm × 3.0-mm HotRod™ VQFN package

2 Applications

- [Notebook, DTV and STB](#)
- [Telecom and networking](#), point-of-load (POL)
- IPCs, [factory automation](#)
- Distributed power systems

3 Description

The TPS51396A is a cost-effective, high-voltage input, high-efficiency synchronous buck converter with integrated FETs.

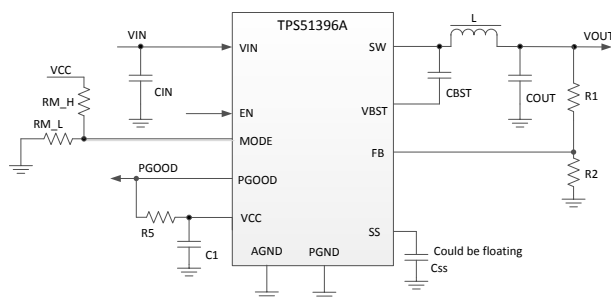

Typical Application

The key feature of the TPS51396A is its ULQ (Ultra Low Quiescent) feature to enable low-bias current and large duty operation. The ULQ feature is extremely beneficial for long battery life in low power operation. The TPS51396A operates with a supply input voltage ranging from 4.5 V to 24 V. It uses DCAP3 control mode to provide a fast transient response, good line, load regulation, no requirement for external compensation, and supports low equivalent series resistance (ESR) output capacitors such as specialty polymer and ultra-low ESR ceramic capacitors.

The TPS51396A provides complete protection OVP, UVP, OCP, OTP, and UVLO. It is combined power good signal and output discharge function.

The MODE pin in the TPS51396A can be used to set Eco-Mode or OOA mode for light load operation. The Eco-Mode maintains high efficiency during light load operation, and OOA mode operations with switching frequency larger than 25 kHz even no loading.

The TPS51396A supports both an internal and external soft-start time option. It has the internal fixed soft-start time of 1.3 ms. If the application needs longer soft-start time, the external SS pin can be used to achieve it by connecting the external capacitor.

The TPS51396A is available in a 20-pin 3.0-mm × 3.0-mm HotRod package and the junction temperature is specified from –40°C to 125°C.

Device Information

| PART NUMBER | PACKAGE ⁽¹⁾ | BODY SIZE (NOM) |
|-------------|------------------------|-------------------|
| TPS51396A | VQFN (20) | 3.00 mm × 3.00 mm |

- (1) For all available packages, see the orderable addendum at the end of the data sheet.

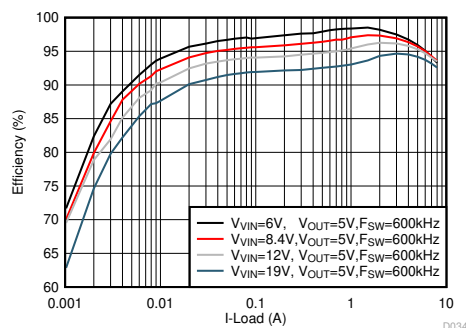

Efficiency vs Output Current ECO-mode



Table of Contents

| | | | |
|--|----|--|----|
| 1 Features | 1 | 8 Application and Implementation | 17 |
| 2 Applications | 1 | 8.1 Application Information..... | 17 |
| 3 Description | 1 | 8.2 1V Output Typical Application..... | 17 |
| 4 Revision History | 2 | 9 Power Supply Recommendations | 22 |
| 5 Pin Configuration and Functions | 3 | 10 Layout | 23 |
| 6 Specifications | 4 | 10.1 Layout Guidelines..... | 23 |
| 6.1 Absolute Maximum Ratings..... | 4 | 10.2 Layout Example..... | 23 |
| 6.2 ESD Ratings..... | 4 | 11 Device and Documentation Support | 24 |
| 6.3 Recommended Operating Conditions..... | 4 | 11.1 Device Support..... | 24 |
| 6.4 Thermal Information..... | 5 | 11.2 Receiving Notification of Documentation Updates.. | 24 |
| 6.5 Electrical Characteristics..... | 5 | 11.3 Support Resources..... | 24 |
| 6.6 Typical Characteristics..... | 7 | 11.4 Trademarks..... | 24 |
| 7 Detailed Description | 11 | 11.5 Electrostatic Discharge Caution..... | 24 |
| 7.1 Overview..... | 11 | 11.6 Glossary..... | 24 |
| 7.2 Functional Block Diagram..... | 12 | 12 Mechanical, Packaging, and Orderable Information | 25 |
| 7.3 Feature Description..... | 13 | | |
| 7.4 Device Functional Modes..... | 14 | | |

4 Revision History

NOTE: Page numbers for previous revisions may differ from page numbers in the current version.

| Changes from Revision B (April 2020) to Revision C (April 2021) | Page |
|--|-------------|
| • First public release..... | 1 |
| • Updated the numbering format for tables, figures, and cross-references throughout the document. | 1 |
| • Updated title..... | 1 |
| • Added table note to the <i>Recommended Operating Conditions</i> | 4 |

| Changes from Revision A (April 2020) to Revision B (April 2020) | Page |
|---|-------------|
| • Changed marketing status from NDA Restrictions to Select Disclosure. | 1 |

| Changes from Revision * (February 2019) to Revision A (April 2020) | Page |
|---|-------------|
| • Changed marketing status from Advance Information to Production release. | 1 |

5 Pin Configuration and Functions

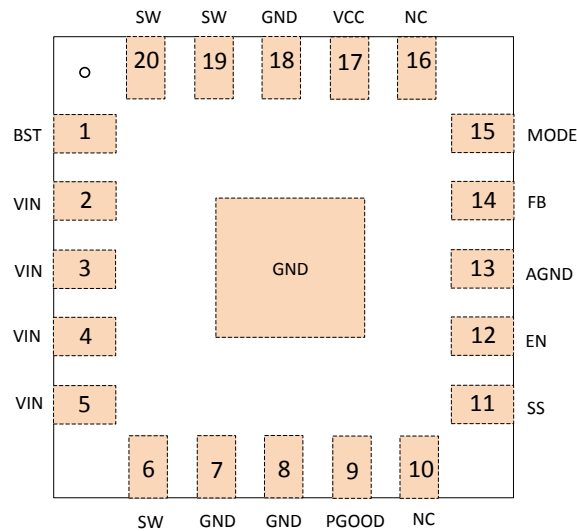

Figure 5-1. RJE Package 20-Pin VQFN (Top View)

Table 5-1. Pin Functions

| PIN | | I/O | DESCRIPTION |
|-------|------------|-----|---|
| NAME | NO. | | |
| BST | 1 | I | Supply input for the gate drive voltage of the high-side MOSFET. Connect the bootstrap capacitor between BST and SW, 0.1 μ F is recommended. |
| VIN | 2,3,4,5 | P | Input voltage supply pin for the control circuitry. Connect the input decoupling capacitors between VIN and GND. |
| SW | 6,19,20 | O | Switch node terminal. Connect the output inductor to this pin. |
| GND | 7,8,18,Pad | G | Power GND terminal for the controller circuit and the internal circuitry. |
| PGOOD | 9 | O | Open drain power good indicator. It is asserted low if output voltage is out of PGOOD threshold, over voltage or if the device is under thermal shutdown, EN shutdown or during soft start. |
| SS | 11 | I | Soft-start time selection pin. Connecting an external capacitor sets the soft-start time and if no external capacitor is connected, the soft-start time is about 1.3 ms. |
| NC | 10,16 | | Not connect. Can be connected to GND plane for better thermal achieved. |
| EN | 12 | I | Enable pin of buck converter. EN pin is a digital input pin, decides turn on or off buck converter. Internal pull down current to disable converter if leave this pin open. |
| AGND | 13 | G | Ground of internal analog circuitry. Connect AGND to GND plane with a short trace. |
| FB | 14 | I | Converter feedback input. Connect to the center tap of the resistor divider between output voltage and AGND. |
| MODE | 15 | I | Light load operation mode selection pin. Connect this pin to a resistor divider from VCC and AGND, the different MODE options are shown in Table 7-1 |
| VCC | 17 | O | 5.0-V internal VCC LDO output. This pin supplies voltage to the internal circuitry and gate driver. Bypass this pin with a 1- μ F capacitor. |

6 Specifications

6.1 Absolute Maximum Ratings

over operating free-air temperature range (unless otherwise noted) ⁽¹⁾

| | | MIN | MAX | UNIT |
|------------------|--------------------------------|------|-----|------|
| Input voltage | VIN | -0.3 | 26 | V |
| | VBST | -0.3 | 31 | V |
| | VBST-SW | -0.3 | 6 | V |
| | EN, MODE, FB, SS | -0.3 | 6 | V |
| | PGND, AGND | -0.3 | 0.3 | V |
| Output voltage | SW | -2 | 26 | V |
| | SW (10-ns transient) | -3 | 28 | V |
| | PGOOD | -0.3 | 6 | V |
| T _J | Operating junction temperature | -40 | 150 | °C |
| T _{stg} | Storage temperature | -55 | 150 | °C |

- (1) Stresses beyond those listed under *Absolute Maximum Ratings* may cause permanent damage to the device. These are stress ratings only, which do not imply functional operation of the device at these or any other conditions beyond those indicated under *Recommended Operating Conditions*. Exposure to absolute-maximum-rated conditions for extended periods may affect device reliability.

6.2 ESD Ratings

| | | VALUE | UNIT |
|--------------------|-------------------------|---|------------|
| V _(ESD) | Electrostatic discharge | Human-body model (HBM), per ANSI/ESDA/JEDEC JS-001 ⁽¹⁾ | ±2000 V |
| | | Charged-device model (CDM), per JEDEC specification JESD22- V C101 ⁽²⁾ | ±500 V |

- (1) JEDEC document JEP155 states that 500-V HBM allows safe manufacturing with a standard ESD control process.
 (2) JEDEC document JEP157 states that 250-V CDM allows safe manufacturing with a standard ESD control process.

6.3 Recommended Operating Conditions

over operating free-air temperature range (unless otherwise noted)

| | | MIN | MAX | UNIT |
|------------------|--------------------------------|------|-----|------|
| Input voltage | VIN ⁽¹⁾ | 4.5 | 24 | V |
| | VBST | -0.3 | 29 | V |
| | VBST-SW | -0.3 | 5.5 | V |
| | EN, MODE, FB, SS | -0.3 | 5.5 | V |
| | PGND, AGND | -0.3 | 0.3 | V |
| Output voltage | SW | -2 | 24 | V |
| | SW (10-ns transient) | -3 | 26 | V |
| | PGOOD | -0.3 | 5.5 | V |
| I _{OUT} | Output current | | 8 | A |
| T _J | Operating junction temperature | -40 | 125 | °C |

- (1) Max DC input (include tolerance) should be not over 24 V.

6.4 Thermal Information

| THERMAL METRIC ⁽¹⁾ | | TPS51396A | UNIT |
|-------------------------------|--|------------|------|
| | | RJE (VQFN) | |
| | | 20 PINS | |
| R _{θJA} | Junction-to-ambient thermal resistance | 44.9 | °C/W |
| R _{θJC(top)} | Junction-to-case (top) thermal resistance | 32.3 | °C/W |
| R _{θJB} | Junction-to-board thermal resistance | 13.3 | °C/W |
| ψ _{JT} | Junction-to-top characterization parameter | 1.3 | °C/W |
| ψ _{JB} | Junction-to-board characterization parameter | 13.5 | °C/W |
| R _{θJC(bot)} | Junction-to-case (bottom) thermal resistance | 16.1 | °C/W |

(1) For more information about traditional and new thermal metrics, see the [IC Package Thermal Metrics](#) application report.

6.5 Electrical Characteristics

T_J = -40°C to 125°C, V_{VIN} = 12 V, unless otherwise noted

| PARAMETER | | TEST CONDITION | MIN | TYP | MAX | UNIT |
|---|--------------------------------|--|------|------|------|------|
| SUPPLY CURRENT | | | | | | |
| V _{IN} | Input voltage range | V _{IN} | 4.5 | | 24 | V |
| I _{VIN} | V _{IN} supply current | No load, V _{EN} = 3.3 V, Switching | | 90 | | µA |
| I _{VINSDN} | Shutdown supply current | No load, V _{EN} = 0 V | | 2 | | µA |
| VCC OUTPUT | | | | | | |
| V _{CC} | VCC output voltage | V _{VIN} > 5.0 V | 4.85 | 5 | 5.15 | V |
| | | V _{VIN} = 4.5 V | | 4.5 | | V |
| I _{CC} | VCC current limit | | 20 | | | mA |
| FEEDBACK VOLTAGE | | | | | | |
| V _{FB} | FB voltage | T _J = 25°C | 594 | 600 | 606 | mV |
| | | T _J = -40°C to 125°C | 592 | 600 | 611 | mV |
| DUTY CYCLE and FREQUENCY CONTROL | | | | | | |
| F _{SW} | Switching frequency | T _J = 25°C, F _{SW} = 600 kHz, V _o = 1 V | | 600 | | kHz |
| T _{ON(MIN)} | SW minimum on time | T _J = 25°C | | 60 | | ns |
| T _{OFF(MIN)} | SW minimum off time | T _J = 25°C, V _{FB} = 0.5 V | | | 190 | ns |
| MOSFET and DRIVERS | | | | | | |
| R _{DS(ON)H} | High side switch resistance | T _J = 25°C | | 19.5 | | mΩ |
| R _{DS(ON)L} | Low side switch resistance | T _J = 25°C | | 9.5 | | mΩ |
| OOA FUNCTION | | | | | | |
| T _{OOA} | OOA mode operation period | | | 28 | | µs |
| OUTPUT DISCHARGE and SOFT START | | | | | | |
| R _{DIS} | Discharge resistance | T _J = 25°C, V _{EN} = 0 V | | 420 | | Ω |
| T _{SS} | Soft start time | Internal soft-start time, SS floating | | 1.3 | | ms |
| I _{SS} | Soft start charge current | | | 5 | | µA |
| POWER GOOD | | | | | | |
| T _{PGDLY} | PG start-up delay | PG from low to high | | 1 | | ms |
| V _{PGTH} | PG threshold | VFB falling (fault) | | 85 | | % |
| | | VFB rising (good) | | 90 | | % |
| | | VFB rising (fault) | | 115 | | % |
| | | VFB falling (good) | | 110 | | % |
| V _{PG_L} | PG sink current capability | I _{OL} = 4 mA | | | 0.4 | V |
| I _{PGLK} | PG leak current | V _{PGGOOD} = 5.5 V | | | 1 | µA |

TPS51396A

SLVSEY3C – FEBRUARY 2019 – REVISED APRIL 2021

 $T_J = -40^{\circ}\text{C}$ to 125°C , $V_{VIN} = 12\text{ V}$, unless otherwise noted

| PARAMETER | | TEST CONDITION | MIN | TYP | MAX | UNIT |
|---|-----------------------------------|----------------------------|-----|------|-----|--------------------|
| CURRENT LIMIT | | | | | | |
| I_{OCL} | Over current threshold | Valley current set point | 8.1 | 9.8 | 12 | A |
| I_{NOCL} | Negative over current threshold | | | 3.9 | | A |
| LOGIC THRESHOLD | | | | | | |
| V_{ENH} | EN high-level input voltage | | | 1.2 | 1.4 | V |
| V_{ENL} | EN low-level input voltage | | 0.8 | 1.05 | | V |
| I_{EN} | Enable internal pull down current | $V_{EN} = 0.8\text{ V}$ | | 2 | | μA |
| OUTPUT UNDERVOLTAGE AND OVERVOLTAGE PROTECTION | | | | | | |
| V_{OVP} | OVP trip threshold | | | 125 | | % |
| t_{OVPDLY} | OVP prop deglitch | $T_J = 25^{\circ}\text{C}$ | | 20 | | us |
| V_{UVP} | UVP trip threshold | | | 60 | | % |
| t_{UVPDLY} | UVP prop deglitch | | | 256 | | us |
| UVLO | | | | | | |
| $V_{UVLOVIN}$ | VIN UVLO threshold | Wake up | | 4.2 | 4.4 | V |
| | | Shutdown | 3.6 | 3.8 | | V |
| | | Hysteresis | | 0.4 | | V |
| OVER TEMPERATURE PROTECTION | | | | | | |
| T_{OTP} | OTP trip threshold ⁽¹⁾ | Shutdown temperature | | 150 | | $^{\circ}\text{C}$ |
| T_{OTPHSY} | OTP hysteresis ⁽¹⁾ | Hysteresis | | 20 | | $^{\circ}\text{C}$ |

(1) Not production tested

6.6 Typical Characteristics

$T_J = -40^\circ\text{C}$ to 125°C , $V_{VIN} = 12\text{V}$ (unless otherwise noted)

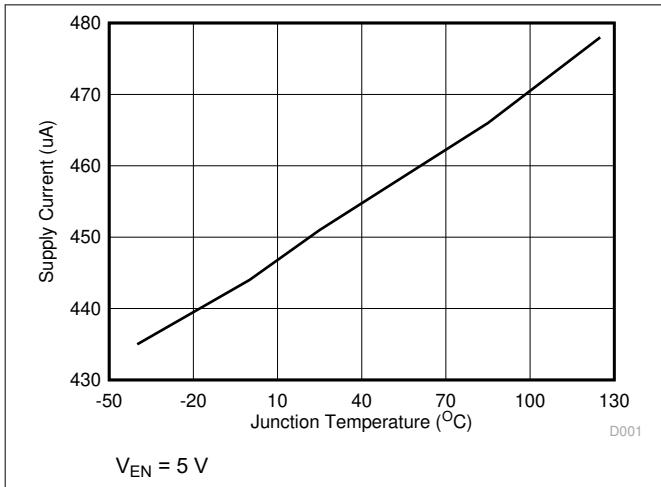

Figure 6-1. Supply Current vs Junction Temperature

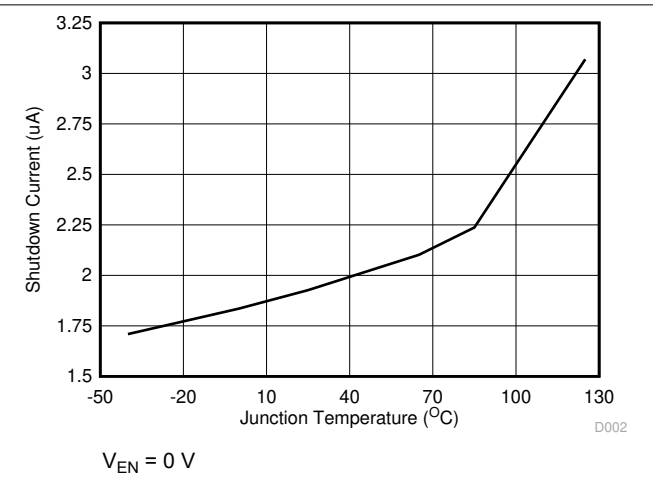

Figure 6-2. Shutdown Current vs Temperature

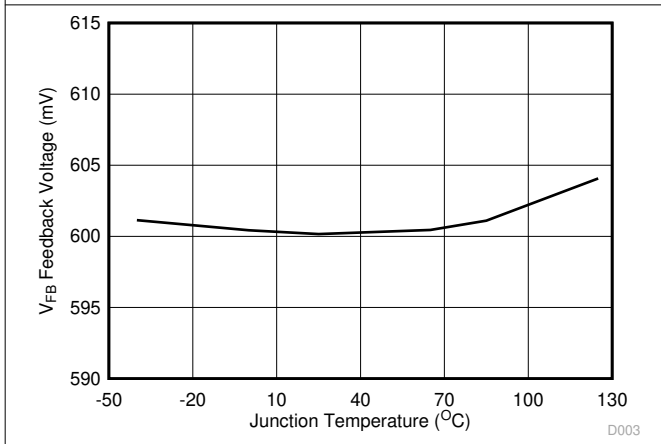

Figure 6-3. Feedback Voltage vs Junction Temperature

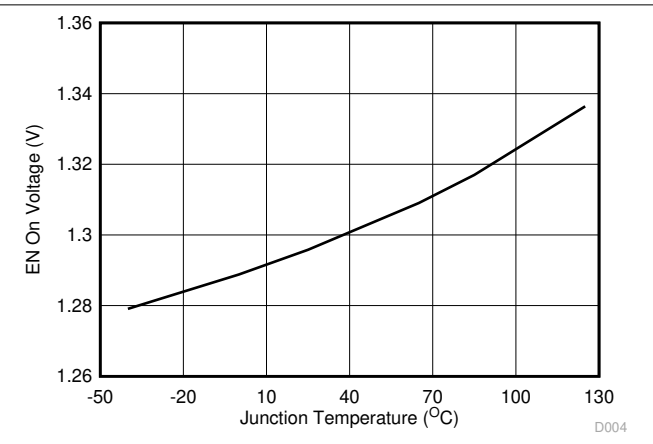

Figure 6-4. Enable On Voltage vs Junction Temperature

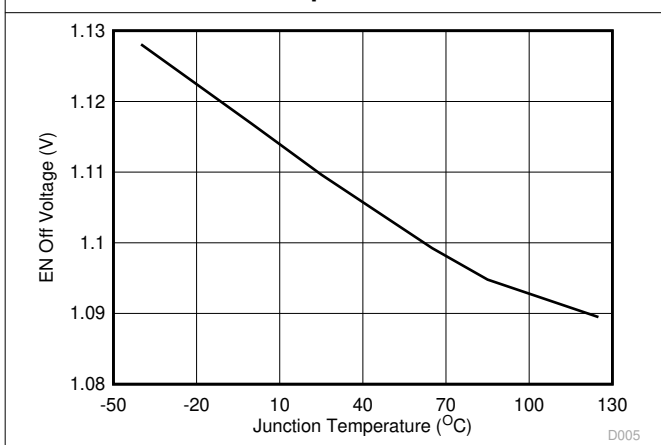

Figure 6-5. Enable Off Voltage vs Junction Temperature

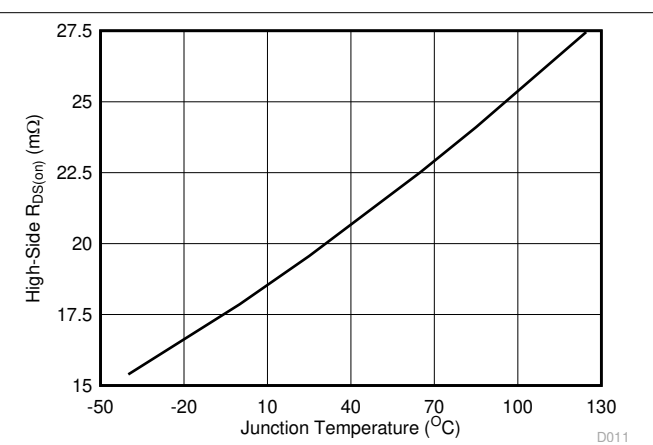

Figure 6-6. High-Side $R_{DS(on)}$ vs Junction Temperature

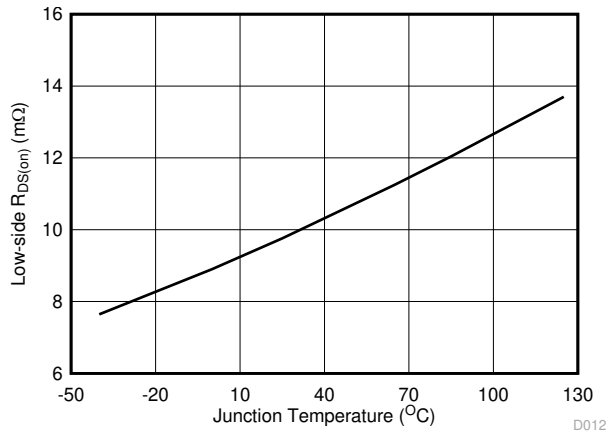

Figure 6-7. Low-Side $R_{DS(on)}$ vs Junction Temperature

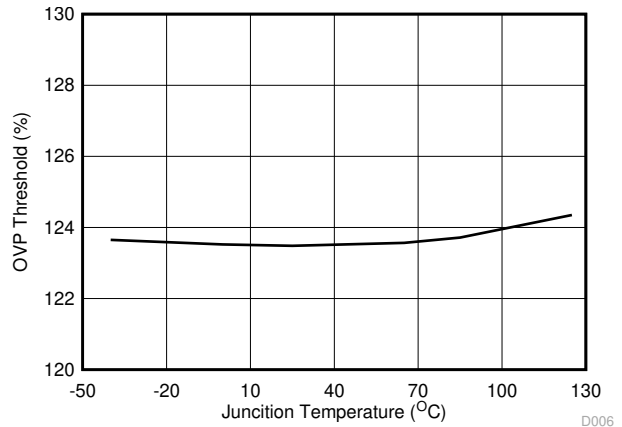

Figure 6-8. OVP Threshold vs Junction Temperature

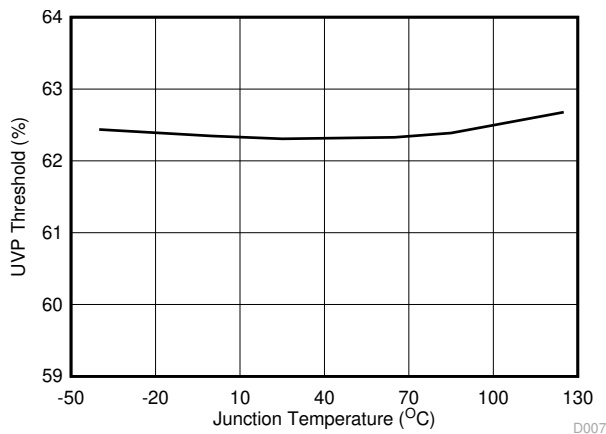

Figure 6-9. UVP Threshold vs Junction Temperature

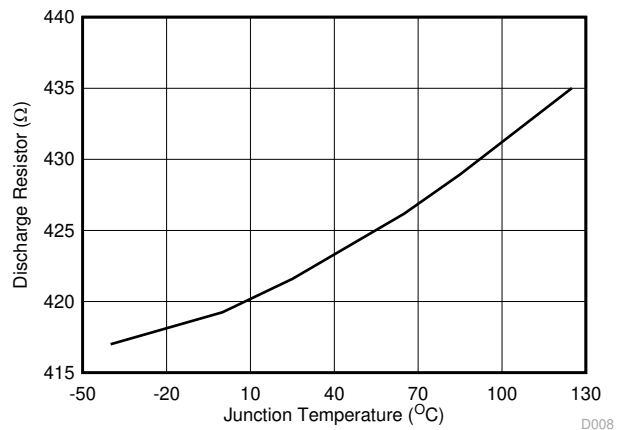

Figure 6-10. Discharge Resistor vs Junction Temperature

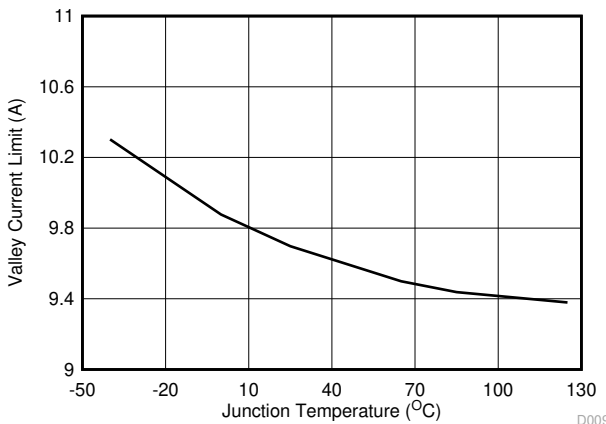

Figure 6-11. Valley Current Limit vs Junction Temperature

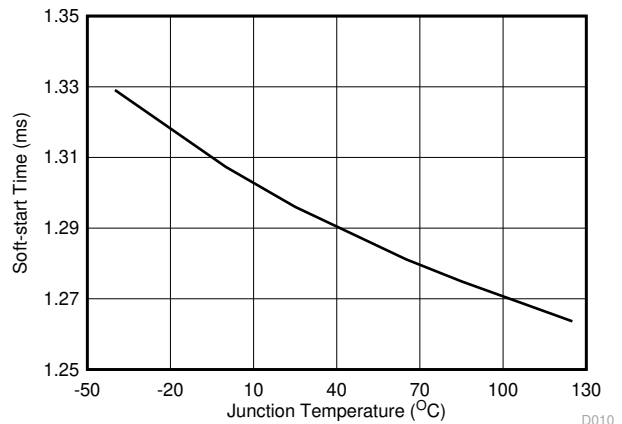

Figure 6-12. Soft-Start Time vs Junction Temperature

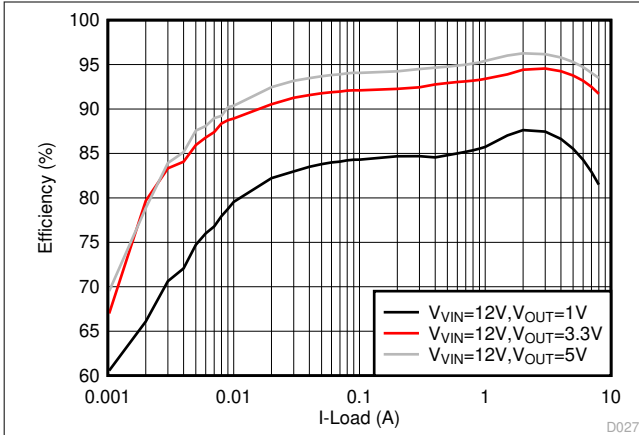

Figure 6-13. Efficiency, Eco-mode, $F_{SW} = 600$ kHz

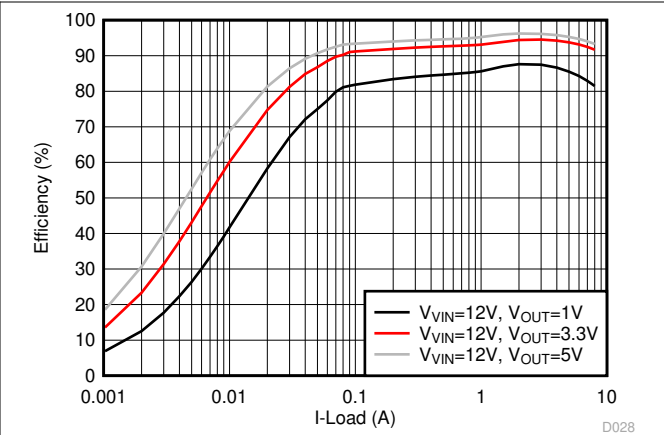

Figure 6-14. Efficiency, OOA-mode, $F_{SW} = 600$ kHz

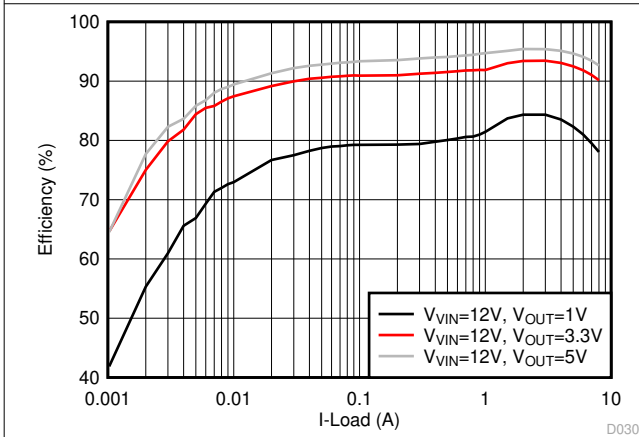

Figure 6-15. Efficiency, Eco-mode, $F_{SW} = 1$ MHz

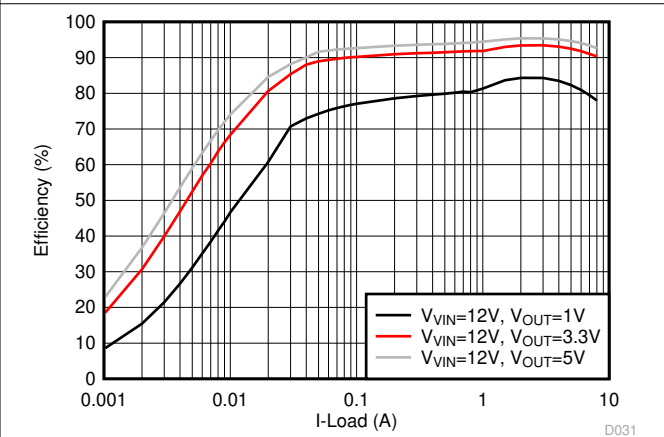

Figure 6-16. Efficiency, OOA-mode, $F_{SW} = 1$ MHz

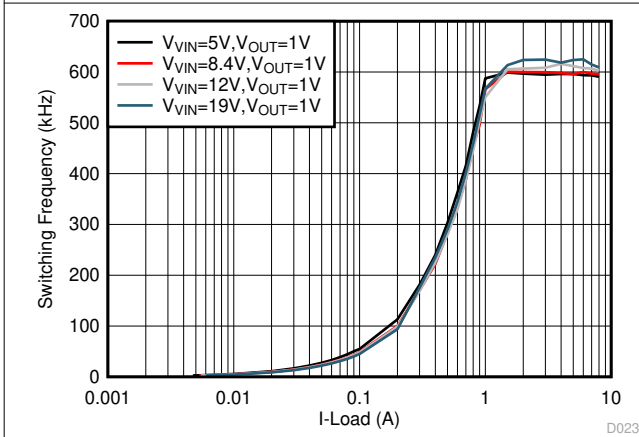

Figure 6-17. F_{SW} Load Regulation, Eco-mode, $F_{SW} = 600$ kHz

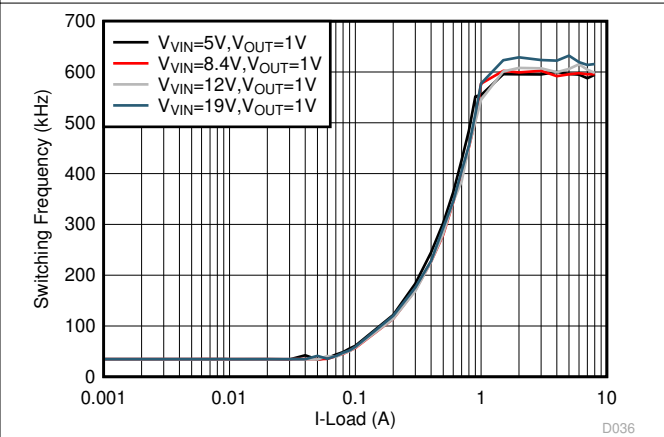

Figure 6-18. F_{SW} Load Regulation, OOA-mode, $F_{SW} = 600$ kHz

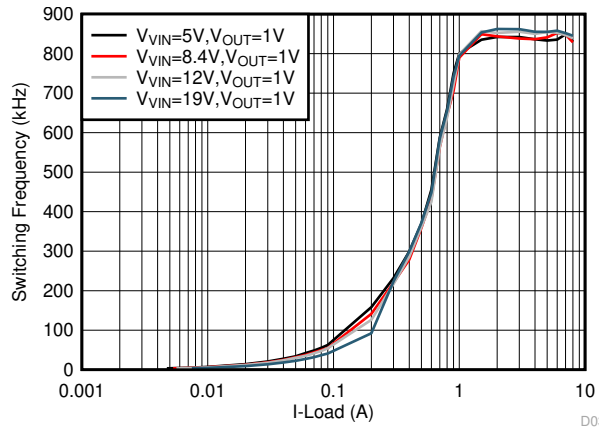

Figure 6-19. F_{sw} Load Regulation, Eco-mode, F_{sw} = 800 kHz

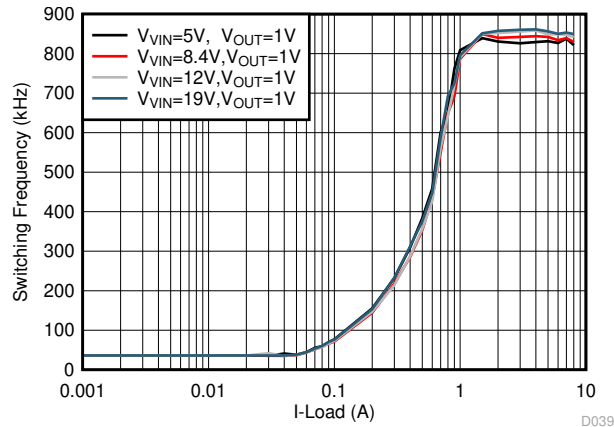

Figure 6-20. F_{sw} Load Regulation, OOA-mode, F_{sw} = 800 kHz

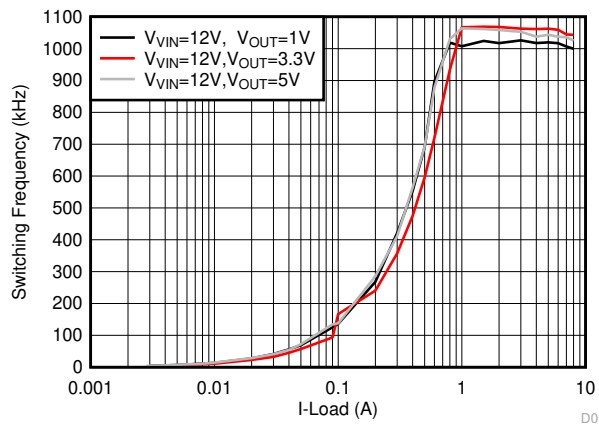

Figure 6-21. F_{sw} Load Regulation, Eco-mode, F_{sw} = 1 MHz

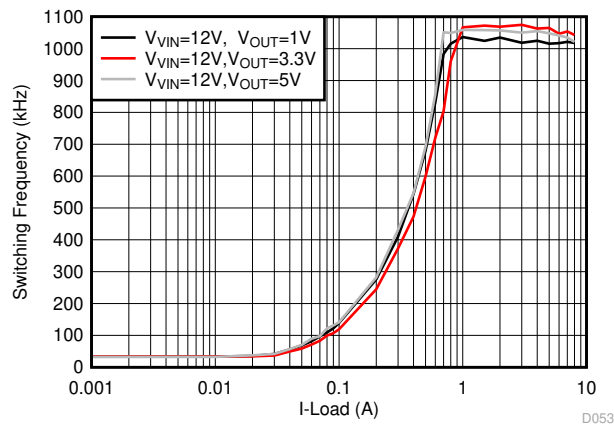

Figure 6-22. F_{sw} Load Regulation, OOA-mode, F_{sw} = 1 MHz

7 Detailed Description

7.1 Overview

The TPS51396A is 8-A integrated FET synchronous buck converter which operates from 4.5-V to 24-V input voltage (V_{IN}), and the output is from 0.6 V to 7 V. The proprietary D-CAP3 mode enables low external component count, ease of design, optimization of the power design for cost, size, and efficiency. The key feature of the TPS51396A is ultra-low quiescent current (ULQ) mode. This feature is beneficial for long battery life in system standby mode. The device employs D-CAP3 mode control that provides fast transient response with no external compensation components and an accurate feedback voltage. The control topology provides seamless transition between CCM operating mode at higher load condition and DCM operation at lighter load condition. Eco-mode allows the TPS51396A to maintain high efficiency at light load. OOA (out of audio) mode makes switching frequency above audible frequency larger than 25 kHz, even there is no loading at output side. The TPS51396A is able to adapt to both low equivalent series resistance (ESR) output capacitors such as POSCAP or SP-CAP, and ultra-low ESR ceramic capacitors.

7.2 Functional Block Diagram

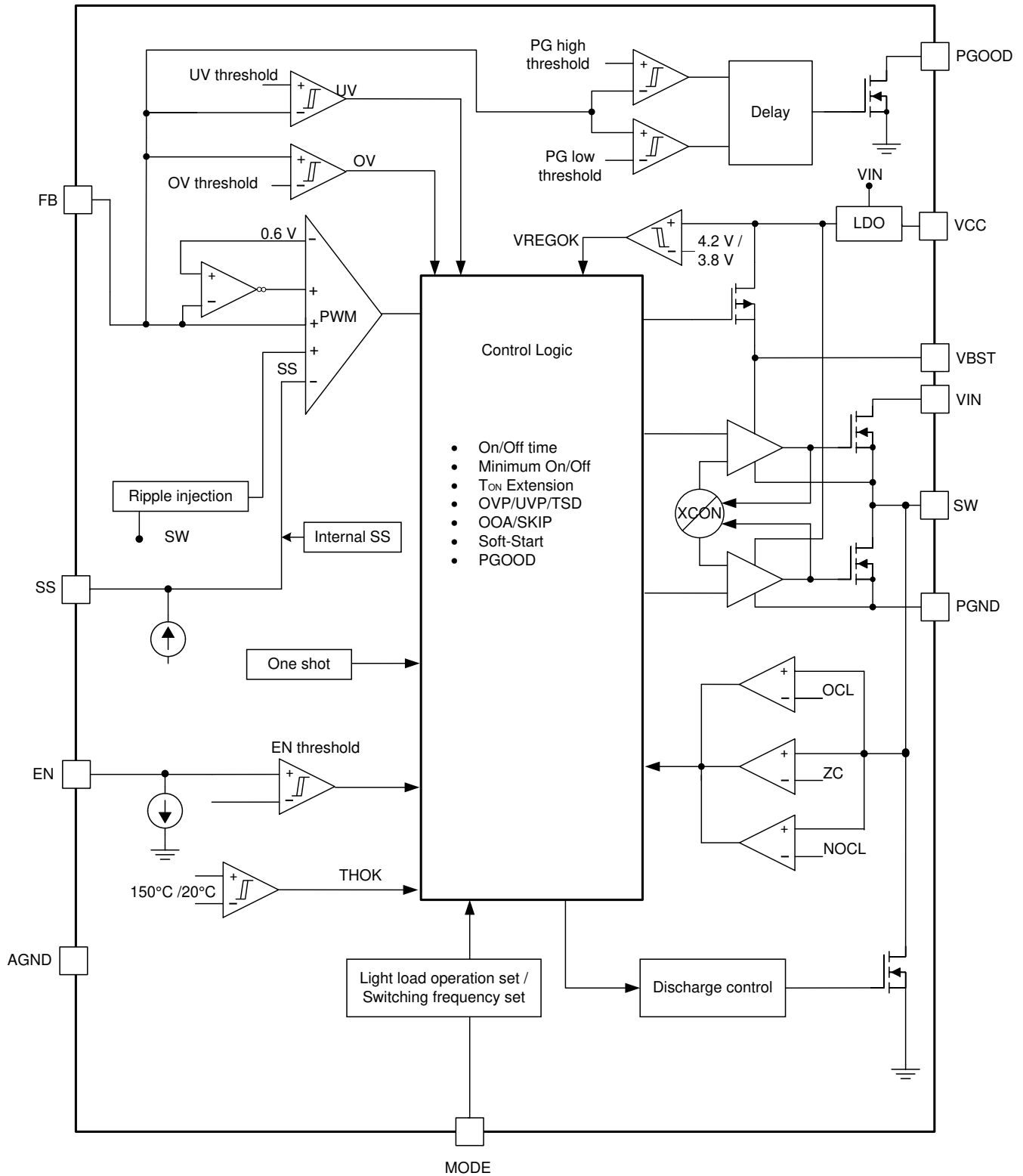

7.3 Feature Description

7.3.1 PWM Operation and D-CAP3 Control

The main control loop of the buck is adaptive on-time pulse width modulation (PWM) controller that supports a proprietary DCAP3 mode control. The DCAP3 mode control combines adaptive on-time control with an internal compensation circuit for pseudo-fixed frequency and low external component count configuration with both low-ESR and ceramic output capacitors. It is stable even with virtually no ripple at the output. The TPS51396A also includes an error amplifier that makes the output voltage very accurate.

At the beginning of each cycle, the high-side MOSFET is turned on. This MOSFET is turned off after internal one-shot timer expires. This one-shot duration is set proportional to the output voltage, V_{OUT} , and is inversely proportional to the converter input voltage, V_{IN} , to maintain a pseudo-fixed frequency over the input voltage range, hence it is called adaptive on-time control. The one-shot timer is reset and the high-side MOSFET is turned on again when the feedback voltage falls below the reference voltage. An internal ripple generation circuit is added to reference voltage for emulating the output ripple, this enables the use of very low-ESR output capacitors such as multi-layered ceramic caps (MLCC). No external current sense network or loop compensation is required for DCAP3 control topology.

For any control topology that is compensated internally, there is a range of the output filter it can support. The output filter used with the TPS51396A is a low-pass L-C circuit. This L-C filter has a double-pole frequency described in [Equation 1](#).

$$f_p = \frac{1}{2 \times \pi \times \sqrt{L_{OUT} \times C_{OUT}}} \quad (1)$$

At low frequency, the overall loop gain is set by the output set-point resistor divider network and the internal gain of the TPS51396A. The low-frequency L-C double pole has a 180 degree drop in phase. At the output filter frequency, the gain rolls off at a –40 dB per decade rate and the phase drops rapidly. The internal ripple generation network introduces a high-frequency zero that reduces the gain roll off from –40 dB to –20 dB per decade and leads the 90 degree phase boost. The internal ripple injection high-frequency zero is related to the switching frequency. The crossover frequency of the overall system should usually be targeted to be less than one-third of the switching frequency (F_{SW}).

7.3.2 Soft Start

The TPS51396A has an internal 1.3-ms soft start, and also an external SS pin is provided for setting higher soft-start time if needed. When the EN pin becomes high, the soft-start function begins ramping up the reference voltage to the PWM comparator.

If the application needs a larger soft start time, it can be set by connecting a capacitor on SS pin. When the EN pin becomes high, the soft-start charge current (I_{SS}) begins charging the external capacitor (C_{SS}) connected between SS and AGND. The device tracks the lower of the internal soft-start voltage or the external soft-start voltage as the reference. The equation for the soft-start time (T_{SS}) is shown in [Equation 2](#):

$$T_{SS} = \frac{C_{SS}(\text{nF}) \times V_{REF}(\text{V})}{I_{SS}(\mu\text{A})} \quad (2)$$

where

- V_{REF} is 0.6 V and I_{SS} is 5 μA

7.3.3 Large Duty Operation

The TPS51396A can support large duty operations by its internal T_{ON} extension function. When the $V_{IN}/V_{OUT} < 1.6$, and the V_{FB} is lower than internal V_{REF} , the T_{ON} will be extended to implement the large duty operation and also improve the performance of the load transient performance.

7.3.4 Power Good

The Power Good (PGOOD) pin is an open-drain output. Once the V_{FB} is between 90% and 110% of the target output voltage, the PGOOD is de-asserted and floats after a 1-ms de-glitch time. A 100 k Ω pullup resistor is recommended to pull the voltage up to VCC. The PGOOD pin is pulled low when:

- the FB pin voltage is lower than 85% or greater than 115% of the target output voltage
- in an OVP, UVP, or thermal shutdown event
- during the soft-start period.

7.3.5 Over Current Protection and Undervoltage Protection

The TPS51396A has the over current protection and undervoltage protection. The output over current limit (OCL) is implemented using a cycle-by-cycle valley detect circuit. The switch current is monitored during the OFF state by measuring the low-side FET drain to source voltage. This voltage is proportional to the switch current. To improve accuracy, the voltage sensing is temperature compensated.

During the on-time of the high-side FET switch, the switch current increases at a linear rate determined by V_{IN} , V_{OUT} , the on-time and the output inductor value. During the on-time of the low-side FET switch, this current decreases linearly. The average value of the switch current is the load current I_{OUT} . If the monitored current is above the OCL level, the converter maintains low-side FET on and delays the creation of a new set pulse, even the voltage feedback loop requires one, until the current level becomes OCL level or lower. In subsequent switching cycles, the on-time is set to a fixed value and the current is monitored in the same manner.

There are some important considerations for this type of over current protection. When the load current is higher than the over current threshold by one half of the peak-to-peak inductor ripple current, the OCL is triggered and the current is being limited, the output voltage tends to drop because the load demand is higher than what the converter can support. When the output voltage falls below 60% of the target voltage, the UVP comparator detects it, the output will be latched after a wait time of 256 μ s. When the over current condition is removed, the output voltage is latched till the EN is toggled or re-power the power input.

7.3.6 Over Voltage Protection

The TPS51396A has the over voltage protection feature. When the output voltage becomes higher than 125% of the target voltage, the OVP comparator output goes high, the output will be discharged after a wait time of 20 μ s. When the over voltage condition is removed, the output voltage is latched till the EN is toggled or re-power the power input.

7.3.7 UVLO Protection

Undervoltage Lockout protection (UVLO) monitors the V_{IN} power input. When the voltage is lower than UVLO threshold voltage, the device is shut off and output is discharged. This is a non-latch protection.

7.3.8 Output Voltage Discharge

The TPS51396A has the discharge function by using internal MOSFET about 420 Ω $R_{DS(on)}$, which is connected to the output terminal SW. The discharge is slow due to the lower current capability of the MOSFET.

7.3.9 Thermal Shutdown

The TPS51396A monitors the internal die temperature. If the temperature exceeds the threshold value (typically 150 $^{\circ}$ C), the device is shut off and the output will be discharged. This is a non-latched protection, the device restarts switching when the temperature goes below the thermal shutdown threshold.

7.4 Device Functional Modes

7.4.1 Light Load Operation

TPS51396A has a MODE pin which can setup three different modes of operation for light load running and 600 kHz/800 kHz/1 MHz switching frequency at heavy load .The light load running includes out-of-audio mode ,advanced Eco-mode and force CCM mode.

7.4.2 Advanced Eco-mode™ Control

The advanced Eco-mode™ control scheme to maintain high light load efficiency. As the output current decreases from heavy load conditions, the inductor current is also reduced and eventually comes to a point where the rippled valley touches zero level, which is the boundary between continuous conduction and discontinuous conduction modes. The rectifying MOSFET is turned off when the zero inductor current is detected. As the load current further decreases, the converter runs into discontinuous conduction mode. The on-time is kept almost the same as it was in the continuous conduction mode so that it takes longer time to discharge the output capacitor with smaller load current to the level of the reference voltage. This makes the switching frequency lower, proportional to the load current, and keeps the light load efficiency high. The light load current where the transition to Eco-mode™ operation happens ($I_{OUT(LL)}$) can be calculated from Equation 3.

$$I_{OUT(LL)} = \frac{1}{2 \times L_{OUT} \times F_{SW}} \times \frac{(V_{IN} - V_{OUT}) \times V_{OUT}}{V_{IN}} \quad (3)$$

After identifying the application requirements, design the output inductance (L_{OUT}) so that the inductor peak-to-peak ripple current is approximately between 20% and 30% of the $I_{OUT(max)}$ (peak current in the application). It is also important to size the inductor properly so that the valley current does not hit the negative low-side current limit.

7.4.3 Out of Audio Mode

Out-of-Audio (OOA) light-load mode is a unique control feature that keeps the switching frequency above audible frequency towards a virtual no-load condition. During Out-of-Audio operation, the OOA control circuit monitors the states of both high-side and low-side MOSFETs and forces them switching if both MOSFETs are off for more than 28 μ s. When both high-side and low-side MOSFETs are off for more than 28 μ s during a light-load condition, the lowside FET will be on for discharge till reverse OC happens or output voltage drops to trigger the high-side FET on. This mode initiates one cycle of the low-side MOSFET and the high-side MOSFET turning on. Then, both MOSFETs stay turned off waiting for another 28 μ s.

If the MODE pin is selected to operate in OOA mode, when the device works at light load, the minimum switching frequency is above 25 kHz which avoids the audible noise in the system.

7.4.4 Mode Selection

The device reads the voltage on the MODE pin during start-up and latches onto one of the MODE options listed below in Table 7-1. The voltage on the MODE pin can be set by connecting this pin to the center tap of a resistor divider connected between VCC and AGND. A guideline for the top resistor (R_{M_H}) and the bottom resistor (R_{M_L}) is shown in Table 7-1, and 1% resistors are recommended. It is important that the voltage for the MODE pin is derived from the VCC rail only since internally this voltage is referenced to detect the MODE option. The MODE pin setting can be reset only by a VIN power cycling or EN toggle.

Table 7-1. MODE Pin Resistor Settings

| $R_{M_H}(k\Omega)$ | $R_{M_L}(k\Omega)$ | Light Load Operation | Switching Frequency (kHz) |
|---------------------|---------------------|----------------------|---------------------------|
| 330 | 5.1 | Eco-mode | 600 |
| 330 | 15 | Eco-mode | 800 |
| 330 | 27 | Eco-mode | 1000 |
| 300 | 43 | OOA mode | 600 |
| 150 | 33 | OOA mode | 800 |
| 160 | 51 | OOA mode | 1000 |

Figure 7-1 below shows the typical start-up sequence of the device once the enable signal crosses the EN turn on threshold. After the voltage on VCC crosses the rising UVLO threshold it takes about 500us to read the first mode setting and approximately 100us from there to finish the last mode setting. The output voltage starts ramping after the mode reading is done.

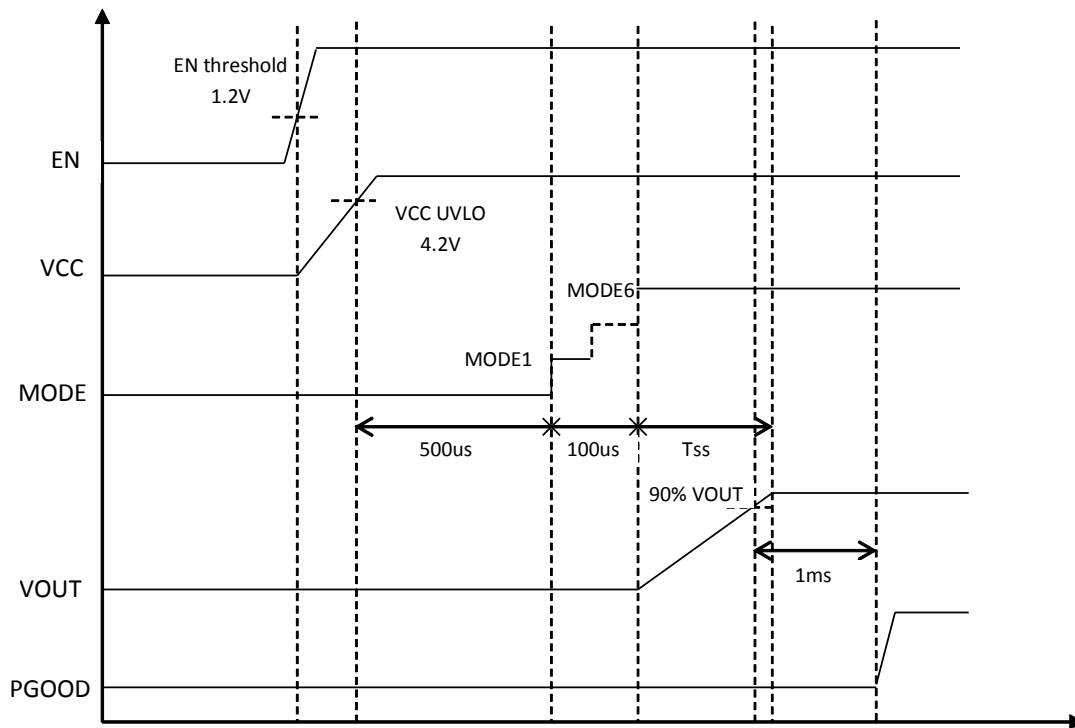

Figure 7-1. Power-Up Sequence

7.4.5 Standby Operation

The TPS51396A can be placed in standby mode by pulling the EN pin low. The device operates with a shutdown current of 2 μA when in standby condition. EN pin is pulled low internally, when float, the part is disabled by default.

8 Application and Implementation

Note

Information in the following applications sections is not part of the TI component specification, and TI does not warrant its accuracy or completeness. TI's customers are responsible for determining suitability of components for their purposes, as well as validating and testing their design implementation to confirm system functionality.

8.1 Application Information

The schematic of [Figure 8-1](#) shows a typical application for TPS51396A with 1-V output. This design converts an input voltage range of 4.5 V to 24 V down to 1 V with a maximum output current of 8 A.

8.2 1V Output Typical Application

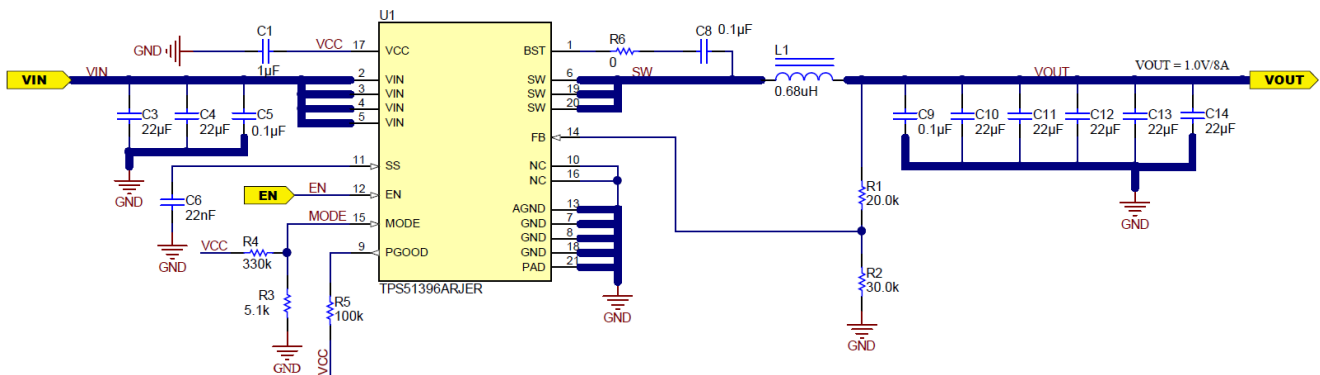

Figure 8-1. 1V/8A Reference Design with Eco-mode, Fsw = 600 kHz

8.2.1 Design Requirements

[Table 8-1](#) lists the design parameters for this example.

Table 8-1. Design Parameters

| PARAMETER | CONDITIONS | MIN | TYP | MAX | UNIT |
|--------------------------|-----------------------------|------------------------------|----------|-----|---------------------|
| OUTPUT | | | | | |
| V _{OUT} | Output voltage | | 1 | | V |
| I _{OUT} | Output current | | 8 | | A |
| ΔV _{OUT} | Transient response | 0 A - 8 A load step, 2.5A/us | | ±40 | mV |
| V _{IN} | Input voltage | 4.5 | 12 | 24 | V |
| V _{OUT(ripple)} | Output voltage ripple (CCM) | | 18 | | mV _(P-P) |
| F _{SW} | Switching frequency | | 600 | | kHz |
| | Light load operating mode | | Eco-mode | | |
| T _A | Ambient temperature | | 25 | | °C |

8.2.2 Detailed Design Procedure

8.2.2.1 External Component Selection

8.2.2.1.1 Output Voltage Set Point

To change the output voltage of the application, it is necessary to change the value of the upper feedback resistor. By changing this resistor the user can change the output voltage above 0.6 V. See [Equation 4](#)

$$V_{OUT} = 0.6 \times \left(1 + \frac{R_{UPPER}}{R_{LOWER}}\right) \quad (4)$$

8.2.2.1.2 Inductor Selection

The inductor ripple current is filtered by the output capacitor. A higher inductor ripple current means the output capacitor should have a ripple current rating higher than the inductor ripple current. See [Table 8-2](#) for recommended inductor values.

The RMS and peak currents through the inductor can be calculated using [Equation 5](#) and [Equation 6](#). It is important that the inductor is rated to handle these currents.

$$I_{L(RMS)} = \sqrt{\left[I_{OUT}^2 + \frac{1}{12} \times \left(\frac{V_{OUT} \times (V_{IN(max)} - V_{OUT})}{V_{IN(max)} \times L_{OUT} \times F_{SW}} \right)^2 \right]} \quad (5)$$

$$I_{L(peak)} = I_{OUT} + \frac{I_{L(ripple)}}{2} \quad (6)$$

During transient and short-circuit conditions, the inductor current can increase up to the current limit of the device so it is safe to choose an inductor with a saturation current higher than the peak current under current limit condition.

8.2.2.1.3 Output Capacitor Selection

After selecting the inductor the output capacitor needs to be optimized. In DCAP3™, the regulator reacts within one cycle to the change in the duty cycle so the good transient performance can be achieved without needing large amounts of output capacitance. The recommended output capacitance range is given in [Table 8-2](#).

Ceramic capacitors have very low ESR, otherwise the maximum ESR of the capacitor should be less than $V_{OUT(ripple)}/I_{OUT(ripple)}$.

Table 8-2. Recommended Component Values

| V _{OUT} (V) | R _{LOWER} (kΩ) | R _{UPPER} (kΩ) | F _{sw} (kHz) | L _{OUT} (μH) | C _{OUT(min)} (μF) | C _{OUT(max)} (μF) | C _{FF} (PF) |
|----------------------|-------------------------|-------------------------|-----------------------|-----------------------|----------------------------|----------------------------|----------------------|
| 0.6 | 10 | 0 | 600 | 0.47 | 66 | 500 | - |
| | | | 800 | 0.33 | 66 | 500 | - |
| | | | 1000 | 0.27 | 66 | 500 | - |
| 1 | 30 | 20 | 600 | 0.68 | 66 | 500 | - |
| | | | 800 | 0.47 | 66 | 500 | - |
| | | | 1000 | 0.33 | 66 | 500 | - |
| 3.3 | 20 | 90 | 600 | 1.5 | 66 | 500 | 47-330 |
| | | | 800 | 1.2 | 66 | 500 | 47-330 |
| | | | 1000 | 1 | 66 | 500 | 47-330 |
| 5.0 | 30 | 220 | 600 | 2.2 | 66 | 500 | 47-330 |
| | | | 800 | 1.5 | 66 | 500 | 47-330 |
| | | | 1000 | 1.2 | 66 | 500 | 47-330 |

8.2.2.1.4 Input Capacitor Selection

The TPS51396A requires input decoupling capacitors on power supply input VIN, and the bulk capacitors are needed depending on the application. The minimum input capacitance required is given in [Equation 7](#).

$$C_{IN(min)} = \frac{I_{OUT} \times V_{OUT}}{V_{IN(ripple)} \times V_{IN} \times F_{SW}} \quad (7)$$

TI recommends using a high-quality X5R or X7R input decoupling capacitors of 40 µF on the input voltage pin VIN. The voltage rating on the input capacitor must be greater than the maximum input voltage. The capacitor must also have a ripple current rating greater than the maximum input current ripple of the application. The input ripple current is calculated by [Equation 8](#):

$$I_{CIN(rms)} = I_{OUT} \times \sqrt{\frac{V_{OUT}}{V_{IN(min)}} \times \frac{(V_{IN(min)} - V_{OUT})}{V_{IN(min)}}} \quad (8)$$

A 1-µF ceramic capacitor is needed for the decoupling capacitor on VCC pin.

TPS51396A

SLVSEY3C – FEBRUARY 2019 – REVISED APRIL 2021

8.2.3 Application Curves

Figure 8-2 through Figure 8-15 apply to the circuit of Figure 8-1. $V_{IN} = 12\text{ V}$. $T_J = 25^\circ\text{C}$ unless otherwise specified.

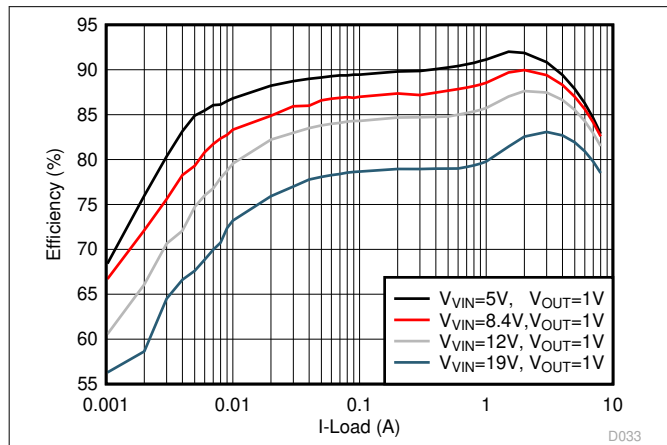

Figure 8-2. Efficiency Curve, Fsw = 600 kHz

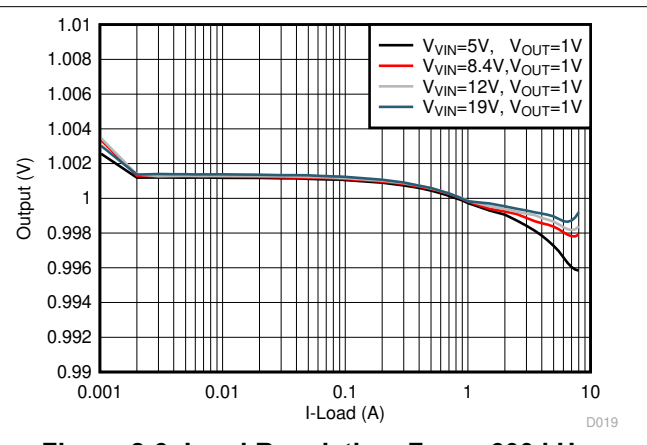

Figure 8-3. Load Regulation, Fsw = 600 kHz

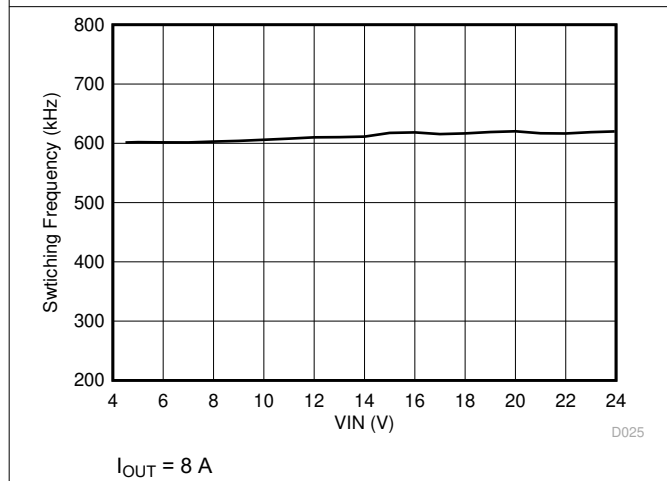

Figure 8-4. Switching Frequency vs Input Voltage

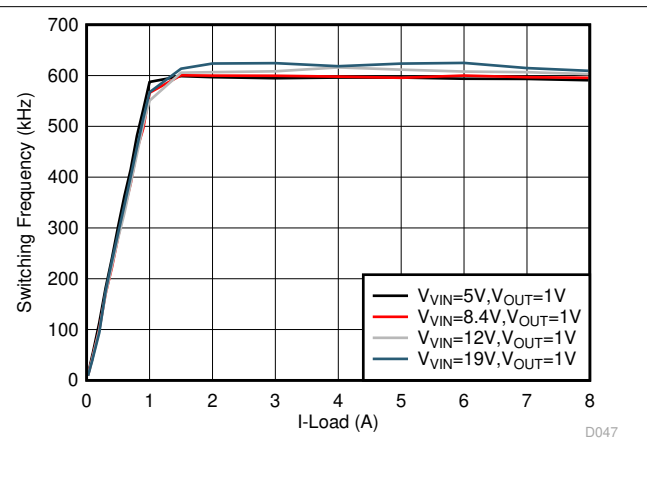

Figure 8-5. Switching Frequency vs Output Load

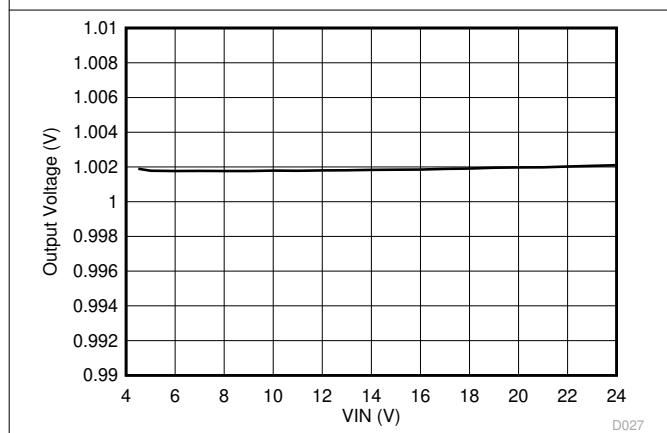

Figure 8-6. Line Regulation, IOUT = 0.01 A

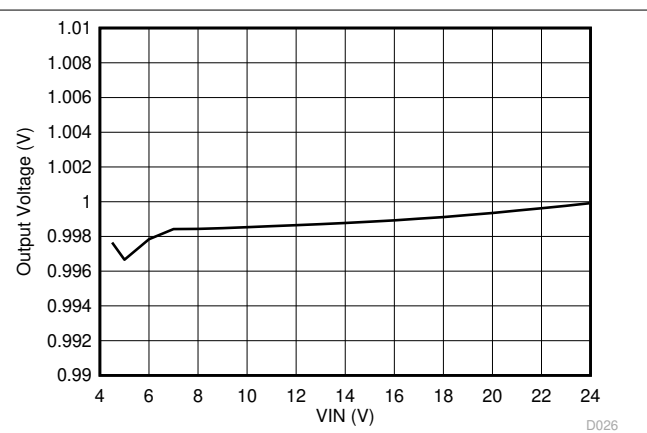

Figure 8-7. Line Regulation, IOUT = 8 A

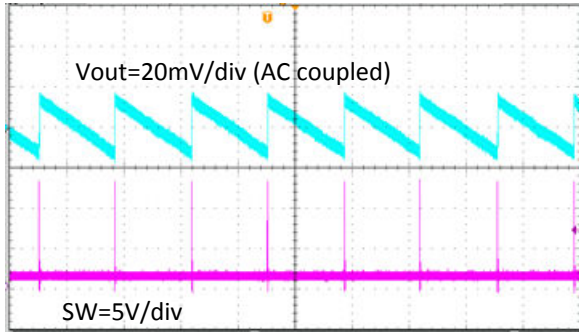

Figure 8-8. Output Voltage Ripple, $I_{OUT} = 0.01$ A

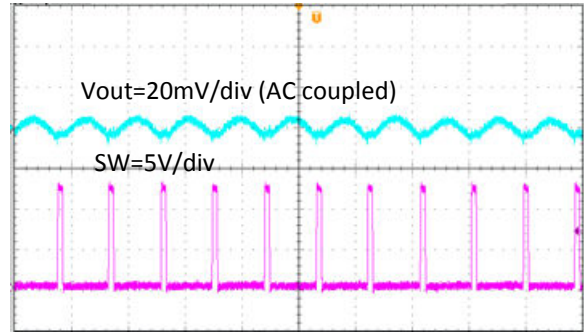

Figure 8-9. Output Voltage Ripple, $I_{OUT} = 8$ A

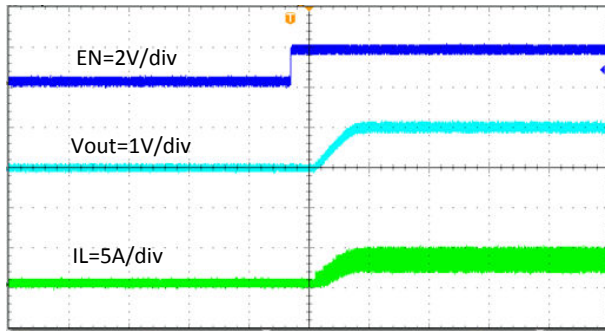

Figure 8-10. Start-Up Through EN, $I_{OUT} = 4$ A

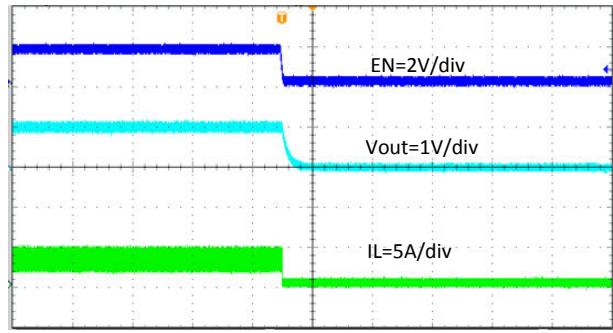

Figure 8-11. Shut-down Through EN, $I_{OUT} = 4$ A

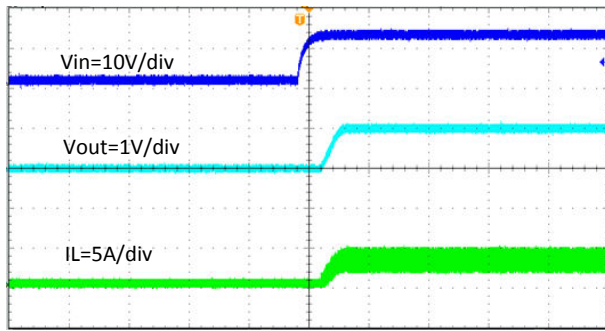

Figure 8-12. Start Up Relative to V_{IN} Rising, $I_{OUT} = 4$ A

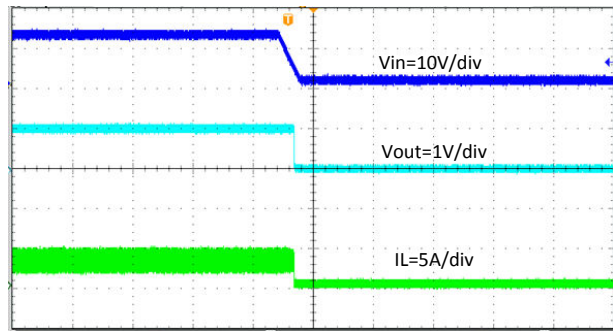

Figure 8-13. Start Up Relative to V_{IN} Falling, $I_{OUT} = 4$ A



 Δ Slew Rate=2.5A/us

Figure 8-14. Transient Response, 0.8 A to 7.2 A

 Δ Slew Rate=2.5A/us

Figure 8-15. Transient Response, 0 A to 8 A

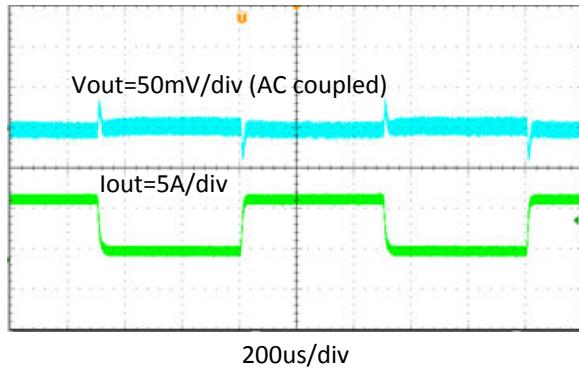
9 Power Supply Recommendations

The TPS51396A is intended to be powered by a well regulated dc voltage. The input voltage range is 4.5 to 24 V. TPS51396A is a buck converter. The input supply voltage must be greater than the desired output voltage for proper operation. Input supply current must be appropriate for the desired output current. If the input voltage supply is located far from the TPS51396A circuit, additional input bulk capacitance is recommended, typical values are 100 μ F to 470 μ F.

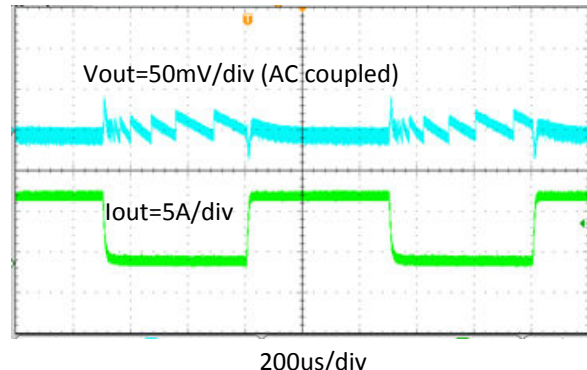
10 Layout

10.1 Layout Guidelines

- TI recommends a four-layer PCB for good thermal performance and with maximum ground plane. 3-inch × 3-inch, four-layer PCB with 2-oz copper is used as example.
- Place the decoupling capacitors right across VIN and VCC as close as possible.
- Place output inductor and capacitors with IC at the same layer, SW routing should be as short as possible to minimize EMI, and should be a width plane to carry big current, enough vias should be added to the GND connection of output capacitor and also as close to the output pin as possible.
- Place BST resistor and capacitor with IC at the same layer, close to BST and SW plane, >15 mil width trace is recommended to reduce line parasitic inductance.
- Feedback could be 20 mil and must be routed away from the switching node, BST node or other high efficiency signal.
- VIN trace must be wide to reduce the trace impedance and provide enough current capability.
- Place multiple vias under the device near VIN and GND and near input capacitors to reduce parasitic inductance and improve thermal performance

10.2 Layout Example

Figure 10-1 shows the recommended top-side layout. Component reference designators are the same as the circuit shown in Figure 8-1. Resistor divider for EN is not used in the circuit of Figure 8-1, but are shown in the layout for reference.

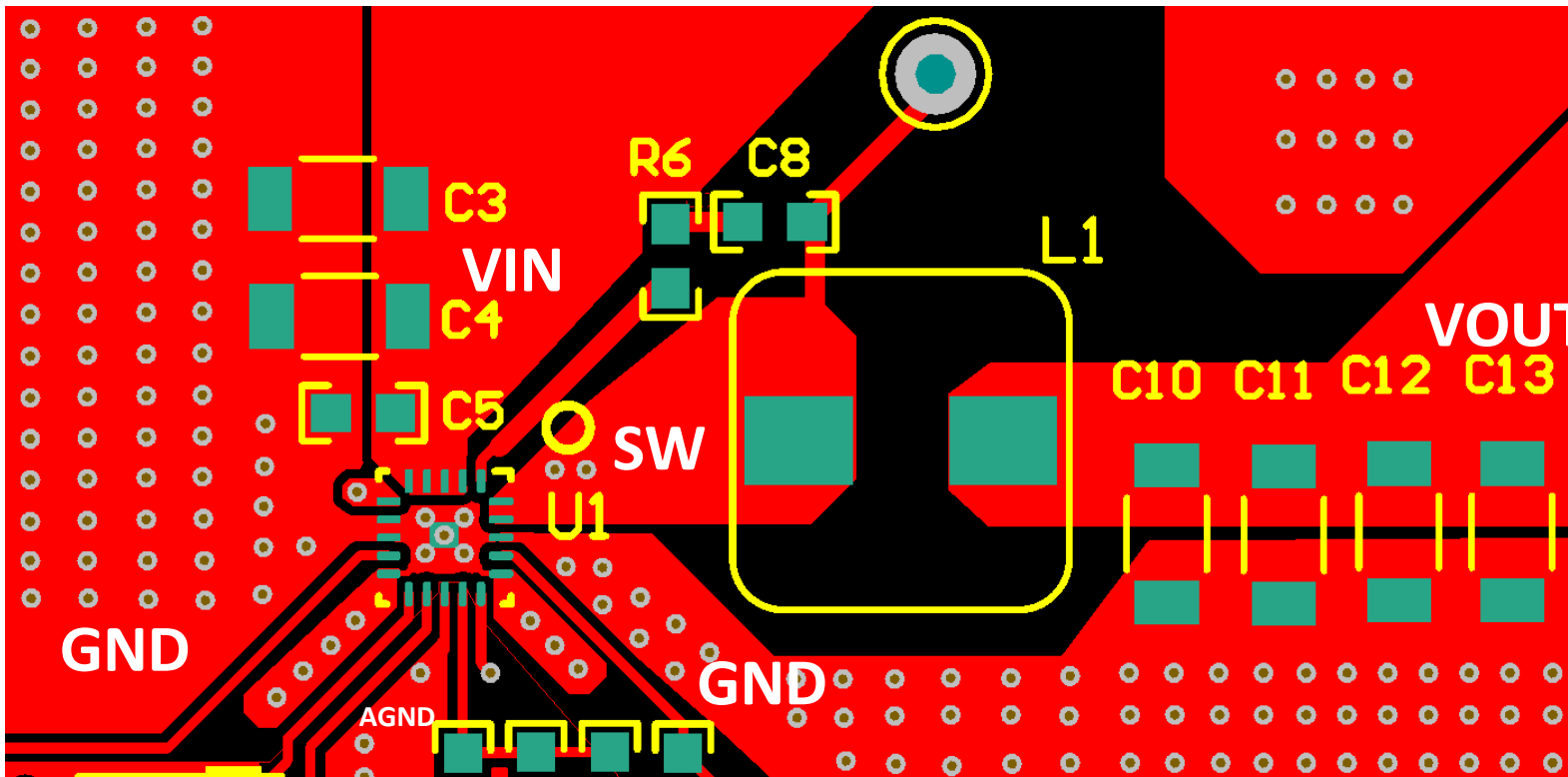

Figure 10-1. Top-Layer Layout

11 Device and Documentation Support

11.1 Device Support

11.1.1 Third-Party Products Disclaimer

TI'S PUBLICATION OF INFORMATION REGARDING THIRD-PARTY PRODUCTS OR SERVICES DOES NOT CONSTITUTE AN ENDORSEMENT REGARDING THE SUITABILITY OF SUCH PRODUCTS OR SERVICES OR A WARRANTY, REPRESENTATION OR ENDORSEMENT OF SUCH PRODUCTS OR SERVICES, EITHER ALONE OR IN COMBINATION WITH ANY TI PRODUCT OR SERVICE.

11.2 Receiving Notification of Documentation Updates

To receive notification of documentation updates, navigate to the device product folder on ti.com. Click on *Subscribe to updates* to register and receive a weekly digest of any product information that has changed. For change details, review the revision history included in any revised document.

11.3 Support Resources

[TI E2E™ support forums](#) are an engineer's go-to source for fast, verified answers and design help — straight from the experts. Search existing answers or ask your own question to get the quick design help you need.

Linked content is provided "AS IS" by the respective contributors. They do not constitute TI specifications and do not necessarily reflect TI's views; see TI's [Terms of Use](#).

11.4 Trademarks

Eco-mode™, D-CAP3™, ULQ™, Eco-Mode™, HotRod™, DCAP3™, and TI E2E™ are trademarks of Texas Instruments.

All trademarks are the property of their respective owners.

11.5 Electrostatic Discharge Caution



This integrated circuit can be damaged by ESD. Texas Instruments recommends that all integrated circuits be handled with appropriate precautions. Failure to observe proper handling and installation procedures can cause damage.

ESD damage can range from subtle performance degradation to complete device failure. Precision integrated circuits may be more susceptible to damage because very small parametric changes could cause the device not to meet its published specifications.

11.6 Glossary

[TI Glossary](#) This glossary lists and explains terms, acronyms, and definitions.

12 Mechanical, Packaging, and Orderable Information

The following pages include mechanical, packaging, and orderable information. This information is the most current data available for the designated devices. This data is subject to change without notice and revision of this document. For browser-based versions of this data sheet, refer to the left-hand navigation.

PACKAGING INFORMATION

| Orderable part number | Status (1) | Material type (2) | Package Pins | Package qty Carrier | RoHS (3) | Lead finish/ Ball material (4) | MSL rating/ Peak reflow (5) | Op temp (°C) | Part marking (6) |
|-------------------------------|---------------|----------------------|--------------------|-----------------------|-------------|--------------------------------------|-----------------------------------|--------------|---------------------|
| TPS51396ARJER | Active | Production | VQFN-HR (RJE) 20 | 3000 LARGE T&R | Yes | SN | Level-2-260C-1 YEAR | -40 to 125 | 51396A |
| TPS51396ARJER.Z | Active | Production | VQFN-HR (RJE) 20 | 3000 LARGE T&R | Yes | SN | Level-2-260C-1 YEAR | -40 to 125 | 51396A |
| TPS51396ARJET | Active | Production | VQFN-HR (RJE) 20 | 250 SMALL T&R | Yes | SN | Level-2-260C-1 YEAR | -40 to 125 | 51396A |
| TPS51396ARJET.Z | Active | Production | VQFN-HR (RJE) 20 | 250 SMALL T&R | Yes | SN | Level-2-260C-1 YEAR | -40 to 125 | 51396A |

(1) **Status:** For more details on status, see our [product life cycle](#).

(2) **Material type:** When designated, preproduction parts are prototypes/experimental devices, and are not yet approved or released for full production. Testing and final process, including without limitation quality assurance, reliability performance testing, and/or process qualification, may not yet be complete, and this item is subject to further changes or possible discontinuation. If available for ordering, purchases will be subject to an additional waiver at checkout, and are intended for early internal evaluation purposes only. These items are sold without warranties of any kind.

(3) **RoHS values:** Yes, No, RoHS Exempt. See the [TI RoHS Statement](#) for additional information and value definition.

(4) **Lead finish/Ball material:** Parts may have multiple material finish options. Finish options are separated by a vertical ruled line. Lead finish/Ball material values may wrap to two lines if the finish value exceeds the maximum column width.

(5) **MSL rating/Peak reflow:** The moisture sensitivity level ratings and peak solder (reflow) temperatures. In the event that a part has multiple moisture sensitivity ratings, only the lowest level per JEDEC standards is shown. Refer to the shipping label for the actual reflow temperature that will be used to mount the part to the printed circuit board.

(6) **Part marking:** There may be an additional marking, which relates to the logo, the lot trace code information, or the environmental category of the part.

Multiple part markings will be inside parentheses. Only one part marking contained in parentheses and separated by a "~" will appear on a part. If a line is indented then it is a continuation of the previous line and the two combined represent the entire part marking for that device.

Important Information and Disclaimer: The information provided on this page represents TI's knowledge and belief as of the date that it is provided. TI bases its knowledge and belief on information provided by third parties, and makes no representation or warranty as to the accuracy of such information. Efforts are underway to better integrate information from third parties. TI has taken and continues to take reasonable steps to provide representative and accurate information but may not have conducted destructive testing or chemical analysis on incoming materials and chemicals. TI and TI suppliers consider certain information to be proprietary, and thus CAS numbers and other limited information may not be available for release.

In no event shall TI's liability arising out of such information exceed the total purchase price of the TI part(s) at issue in this document sold by TI to Customer on an annual basis.

TAPE AND REEL INFORMATION

QUADRANT ASSIGNMENTS FOR PIN 1 ORIENTATION IN TAPE

*All dimensions are nominal

| Device | Package Type | Package Drawing | Pins | SPQ | Reel Diameter (mm) | Reel Width W1 (mm) | A0 (mm) | B0 (mm) | K0 (mm) | P1 (mm) | W (mm) | Pin1 Quadrant |
|---------------|--------------|-----------------|------|------|--------------------|--------------------|---------|---------|---------|---------|--------|---------------|
| TPS51396ARJER | VQFN-HR | RJE | 20 | 3000 | 330.0 | 12.4 | 3.3 | 3.3 | 1.1 | 8.0 | 12.0 | Q2 |
| TPS51396ARJET | VQFN-HR | RJE | 20 | 250 | 180.0 | 12.4 | 3.3 | 3.3 | 1.1 | 8.0 | 12.0 | Q2 |

TAPE AND REEL BOX DIMENSIONS



*All dimensions are nominal

| Device | Package Type | Package Drawing | Pins | SPQ | Length (mm) | Width (mm) | Height (mm) |
|---------------|--------------|-----------------|------|------|-------------|------------|-------------|
| TPS51396ARJER | VQFN-HR | RJE | 20 | 3000 | 367.0 | 367.0 | 35.0 |
| TPS51396ARJET | VQFN-HR | RJE | 20 | 250 | 210.0 | 185.0 | 35.0 |

GENERIC PACKAGE VIEW

RJE 20

VQFN-HR - 1 mm max height

3 x 3, 0.45 mm pitch

QUAD FLATPACK- NO LEAD

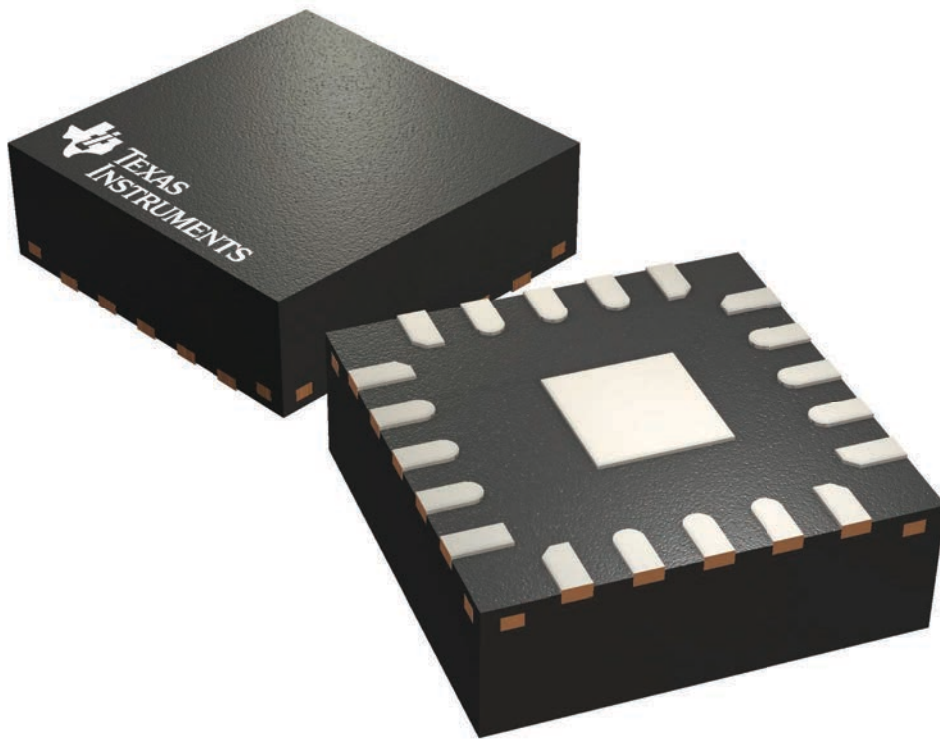

Images above are just a representation of the package family, actual package may vary.
Refer to the product data sheet for package details.

4224683/A

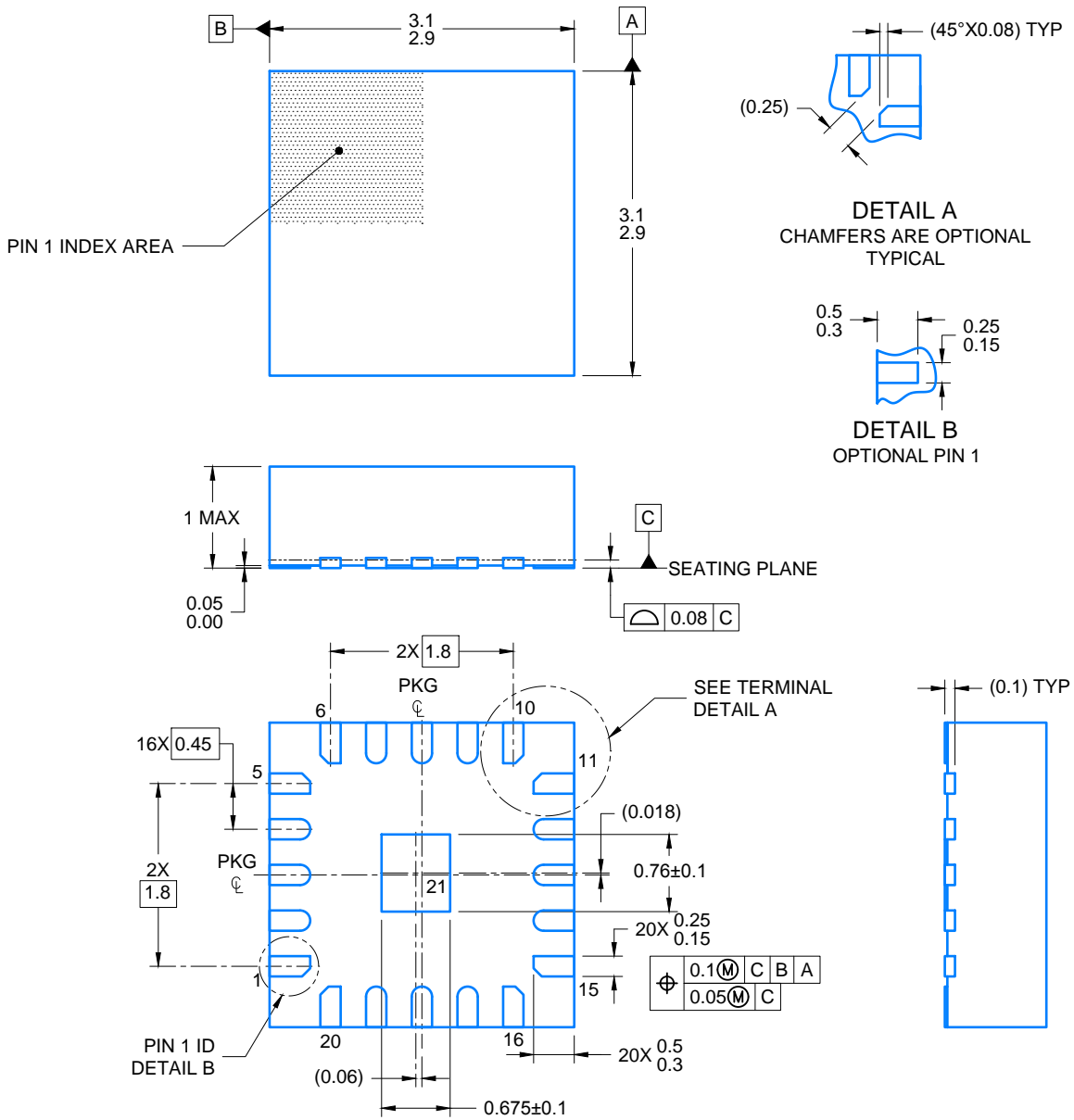

4223546 / B 08/2017

NOTES:

1. All linear dimensions are in millimeters. Any dimensions in parenthesis are for reference only. Dimensioning and tolerancing per ASME Y14.5M.
2. This drawing is subject to change without notice.
3. The package thermal pad must be soldered to the printed circuit board for optimal thermal and mechanical performance.

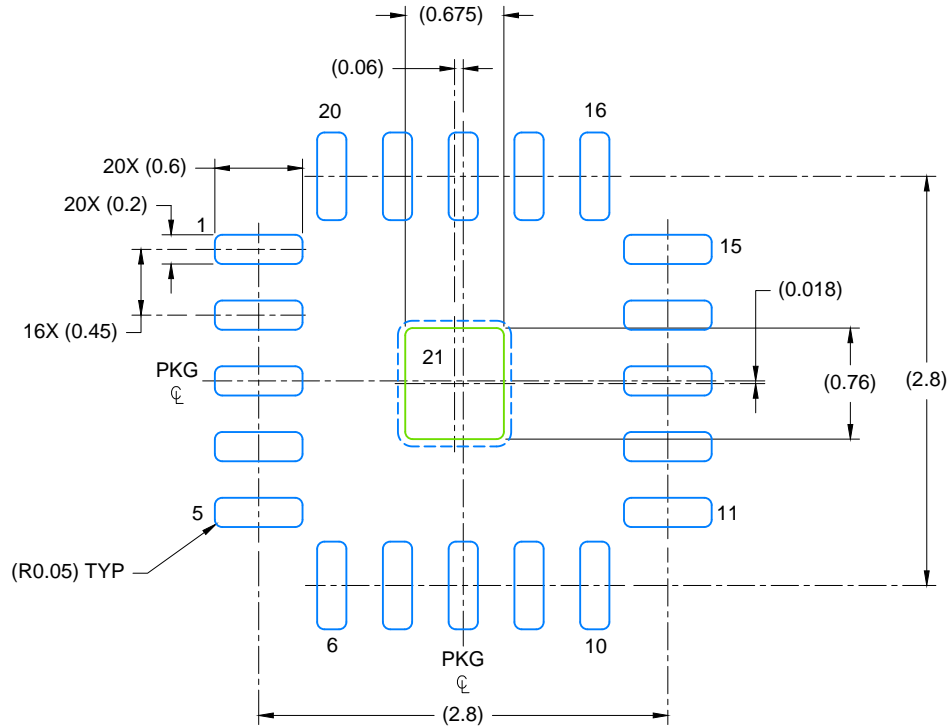

LAND PATTERN EXAMPLE
EXPOSED METAL SHOWN
SCALE: 20X

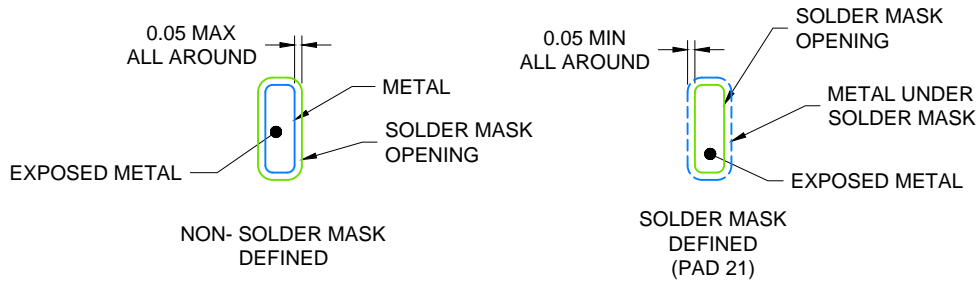

SOLDER MASK DETAILS

4223546 / B 08/2017

NOTES: (continued)

4. This package is designed to be soldered to a thermal pad on the board. For more information, see Texas Instruments literature number SLUA271 (www.ti.com/lit/sluea271).
5. Solder mask tolerances between and around signal pads can vary based on board fabrication site.

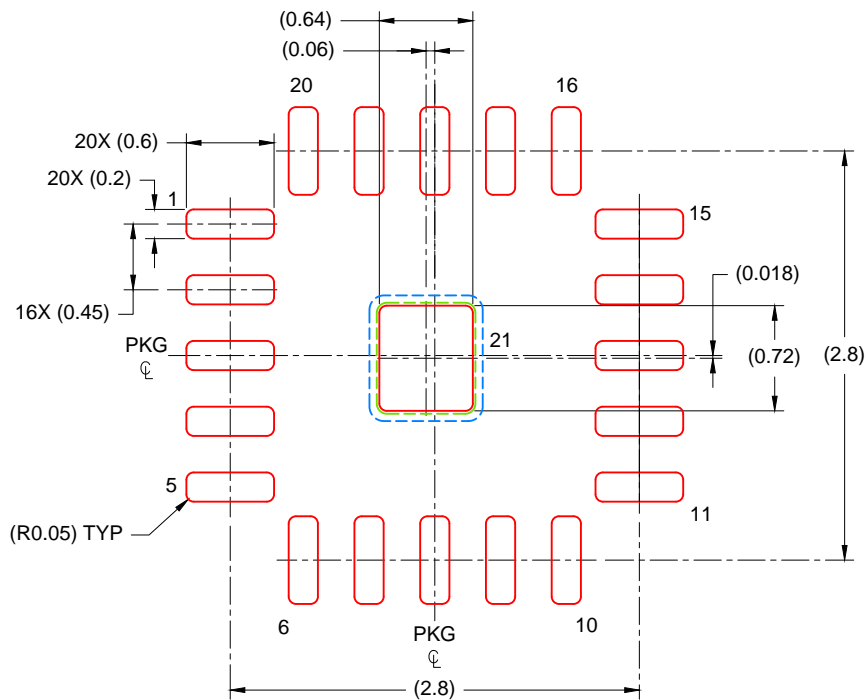

SOLDER PASTE EXAMPLE
 BASED ON 0.1 mm THICK STENCIL

PRINTED SOLDER COVERAGE BY AREA UNDER PACKAGE
 PAD 21: 90%
 SCALE: 20X

4223546 / B 08/2017

NOTES: (continued)

- 6. Laser cutting apertures with trapezoidal walls and rounded corners may offer better paste release. IPC-7525 may have alternate design recommendations..

IMPORTANT NOTICE AND DISCLAIMER

TI PROVIDES TECHNICAL AND RELIABILITY DATA (INCLUDING DATA SHEETS), DESIGN RESOURCES (INCLUDING REFERENCE DESIGNS), APPLICATION OR OTHER DESIGN ADVICE, WEB TOOLS, SAFETY INFORMATION, AND OTHER RESOURCES "AS IS" AND WITH ALL FAULTS, AND DISCLAIMS ALL WARRANTIES, EXPRESS AND IMPLIED, INCLUDING WITHOUT LIMITATION ANY IMPLIED WARRANTIES OF MERCHANTABILITY, FITNESS FOR A PARTICULAR PURPOSE OR NON-INFRINGEMENT OF THIRD PARTY INTELLECTUAL PROPERTY RIGHTS.

These resources are intended for skilled developers designing with TI products. You are solely responsible for (1) selecting the appropriate TI products for your application, (2) designing, validating and testing your application, and (3) ensuring your application meets applicable standards, and any other safety, security, regulatory or other requirements.

These resources are subject to change without notice. TI grants you permission to use these resources only for development of an application that uses the TI products described in the resource. Other reproduction and display of these resources is prohibited. No license is granted to any other TI intellectual property right or to any third party intellectual property right. TI disclaims responsibility for, and you will fully indemnify TI and its representatives against, any claims, damages, costs, losses, and liabilities arising out of your use of these resources.

TI's products are provided subject to [TI's Terms of Sale](#) or other applicable terms available either on [ti.com](https://www.ti.com) or provided in conjunction with such TI products. TI's provision of these resources does not expand or otherwise alter TI's applicable warranties or warranty disclaimers for TI products.

TI objects to and rejects any additional or different terms you may have proposed.

Mailing Address: Texas Instruments, Post Office Box 655303, Dallas, Texas 75265

Copyright © 2025, Texas Instruments Incorporated