

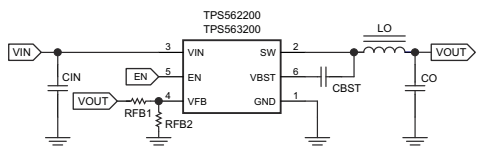
# TPS56x200 4.5-V to 17-V Input, 2-A, 3-A Synchronous Step-down Voltage Regulator in 6-Pin SOT-23

## 1 Features

- TPS562200 - 2-A converter with integrated 122-mΩ and 72-mΩ FETs
- TPS563200 - 3-A converter with integrated 68-mΩ and 39-mΩ FETs
- D-CAP2™ control topology for fast transient response
- Input voltage range: 4.5 V to 17 V
- Output voltage range: 0.76 V to 7 V
- Switching frequency: 650 kHz
- Advanced Eco-mode pulse-skip
- Low shutdown current less than 10 μA
- 1% feedback voltage accuracy (25°C)
- Start-up from pre-biased output voltage
- Cycle-by-cycle overcurrent limit
- Hiccup-mode undervoltage protection
- Non-latch OVP, UVLO and TSD protections
- Fixed soft start: 1 ms
- Use [TPS563252](#) for improved efficiency and higher frequency in a smaller package
- Create a [Custom Design with WEBENCH® Tools](#)

## 2 Applications

- Digital TV power supply
- High definition Blu-ray Disc™ players
- Networking home terminal
- Digital Set Top Box (STB)



Copyright © 2016, Texas Instruments Incorporated

**Simplified Schematic**

## 3 Description

The TPS562200 and TPS563200 are simple, easy-to-use, 2-A and 3-A synchronous step-down (buck) converters in 6-pin SOT-23 package.

The devices are optimized to operate with minimum external component counts and also optimized to achieve low standby current.

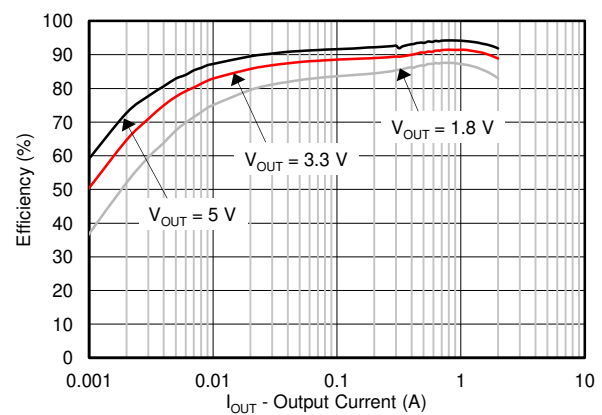
These switch mode power supply (SMPS) devices employ D-CAP2 control topology providing a fast transient response and supporting both low equivalent series resistance (ESR) output capacitors such as specialty polymer and ultra-low ESR ceramic capacitors with no external compensation components.

TPS562200 and TPS563200 operate in Advanced Eco-mode, which maintains high efficiency during light load operation. The devices are available in a 6-pin 1.6-mm × 2.9-mm SOT (DDC) package, and specified from –40°C to 85°C of ambient temperature.

### Device Information<sup>(1)</sup>

PART NUMBER	Output Current (Max)	Package
TPS562200	2 A	DRL (SOT-236, 6)
TPS563200	3 A	

- (1) For all available packages, see the orderable addendum at the end of the data sheet.


**Tps562200 Efficiency**


## Table of Contents

<b>1 Features</b> .....	1	7.3 Feature Description.....	13
<b>2 Applications</b> .....	1	7.4 Device Functional Modes.....	14
<b>3 Description</b> .....	1	<b>8 Application and Implementation</b> .....	15
<b>4 Revision History</b> .....	2	8.1 Application Information.....	15
<b>5 Pin Configuration and Functions</b> .....	4	8.2 Typical Applications.....	15
<b>6 Specifications</b> .....	5	8.3 Power Supply Recommendations.....	26
6.1 Absolute Maximum Ratings <sup>(1)</sup> .....	5	8.4 Layout.....	26
6.2 ESD Ratings.....	5	<b>9 Device and Documentation Support</b> .....	28
6.3 Recommended Operating Conditions.....	5	9.1 Device Support.....	28
6.4 Thermal Information.....	6	9.2 Receiving Notification of Documentation Updates.....	28
6.5 Electrical Characteristics.....	7	9.3 Support Resources.....	28
6.6 Timing Requirements.....	7	9.4 Trademarks.....	28
6.7 Typical Characteristics TPS562200.....	8	9.5 Electrostatic Discharge Caution.....	28
6.8 Typical Characteristics TPS563200.....	10	9.6 Glossary.....	28
<b>7 Detailed Description</b> .....	12	<b>10 Mechanical, Packaging, And Orderable Information</b> .....	28
7.1 Overview.....	12		
7.2 Functional Block Diagram.....	12		

## 4 Revision History

NOTE: Page numbers for previous revisions may differ from page numbers in the current version.

Changes from Revision D (June 2016) to Revision E (May 2023)	Page
• Updated the numbering format for tables, figures, and cross-references throughout the document .....	1
• Add the TPS563252 information .....	1
• Updated trademark information.....	1
• Removed color from images throughout the document.....	1
Changes from Revision C (August 2015) to Revision D (June 2016)	Page
• Updated the Pinout image in <i>Pin Configuration And Functions</i> .....	4
• Changed $R_{\theta JB}$ for TPS562200 From: 3.4 To: 13.4 in <i>Thermal Information</i> .....	6
• <b>Section 7.3.1</b> , changed text From: "proportional to the converter input voltage, $V_{IN}$ , and inversely proportional to the output voltage, $V_O$ " To: "inversely proportional to the converter input voltage, $V_{IN}$ , and proportional to the output voltage, $V_O$ ".....	13
Changes from Revision B (July 2014) to Revision C (August 2015)	Page
• Changed <i>Features</i> From: Integrated 122 m $\Omega$ and 72 m $\Omega$ FETs ('562200) To: TPS562200 - 2A converter with Integrated 122 m $\Omega$ and 72 m $\Omega$ FETs.....	1
• Changed <i>Features</i> From: Integrated 68-m $\Omega$ and 39-m $\Omega$ FETs ('563200) To: TPS563200 - 3A converter with Integrated 68-m $\Omega$ and 39-m $\Omega$ FETs.....	1
• Added <b>Section 1</b> : 650 kHz Switching Frequency.....	1
• Changed <i>Features</i> From: Cycle-By-Cycle Hiccup Over-current Limit To: Cycle-By-Cycle Overcurrent Limit....	1
• Added <i>Features</i> : Hiccup-Mode Undervoltage Protection.....	1
• Changed text in the first paragraph of the Description From: ".in SOT-23 package." To: "in 6 pin SOT-23 package.".....	1
• Moved Storage temperature range, $T_{stg}$ From: <i>Handling Ratings</i> To: <i>Absolute Maximum Ratings</i> .....	5
• Changed the <i>Handling Ratings</i> table to the <i>ESD Ratings</i> table.....	5
• Changed the TPS562200 <i>Thermal Information</i> values.....	6
• Changed $V_{OVP}$ Description in the <i>Electrical Characteristics</i> From: OVP Detect ( $L > H$ ) To: OVP Detect, and the TYP value From: 125% To: 125% x $V_{fbth}$ .....	7
• Changed $V_{UVP}$ Description in the <i>Electrical Characteristics</i> From: Hiccup detect ( $H < L$ ) To: Hiccup detect , and the TYP value From: 65% To: 65% x $V_{fbth}$ .....	7
• Changed the Output Current (A) scale of <b>Figure 6-7</b> .....	8

• Changed $V_{OUT} = 5\text{ V}$ To $V_{OUT} = 3.3\text{ V}$ in <a href="#">Figure 6-15</a> .....	10
• Changed the X axis From: Junction Temperature To: Ambient Temperature in <a href="#">Figure 6-16</a> .....	10
• Added a NOTE to the Application and Implementation section.....	15
• Changed column heading C8 + C9 ( $\mu\text{F}$ ) To: C5 + C6 ( $\mu\text{F}$ ) in <a href="#">Table 8-2</a> .....	17
• Changed column heading C8 + C9 ( $\mu\text{F}$ ) To: C5 + C6 + C7 ( $\mu\text{F}$ ) in <a href="#">Table 8-2</a> .....	22

---

**Changes from Revision A (January 2014) to Revision B (July 2014) Page**

• Added <i>Feature Description</i> section, <i>Device Functional Modes</i> , <i>Application and Implementation</i> section, <i>Power Supply Recommendations</i> section, <i>Device and Documentation Support</i> section, and <i>Mechanical, Packaging, and Orderable Information</i> section .....	1
• Changed the data sheet title From: 4.5 V to 17 V Input, 2A Synchronous Step-Down.. To: 4.5 V to 17 V Input, 2A/3A Synchronous Step-Down.....	1
• Changed device number From: TPS563209 To TPS563200 .....	1
• Changed <a href="#">Features</a> From: 2% Feedback Voltage Accuracy (25°C) To: 1% Feedback Voltage Accuracy (25°C).....	1
• Added the Timing Requirements table .....	7
• Added <a href="#">Table 8-1</a> .....	15
• Changed <a href="#">Table 8-2</a> .....	17
• Deleted sentence following <a href="#">Table 8-2</a> "For higher output voltages, additional phase boost can be achieved by adding a feed forward capacitor (C7) in parallel with R2.".....	17
• Added Application Information for the TPS563200 device .....	22
• Added <a href="#">Table 8-3</a> .....	22

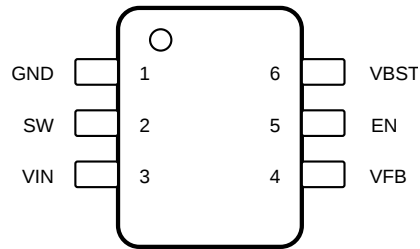
---

**Changes from Revision \* (January 2014) to Revision A (January 2014) Page**

• Changed the device status From: Product Preview To: Production.....	1
---	---

---

## 5 Pin Configuration and Functions



**Figure 5-1. DDC Package 6 Pin (SOT) Top View**

**Table 5-1. Pin Functions**

PIN		DESCRIPTION
NAME	NUMBER	
GND	1	Ground pin Source terminal of low-side power NFET as well as the ground terminal for controller circuit. Connect sensitive VFB to this GND at a single point.
SW	2	Switch node connection between high-side NFET and low-side NFET.
VIN	3	Input voltage supply pin. The drain terminal of high-side power NFET.
VFB	4	Converter feedback input. Connect to output voltage with feedback resistor divider.
EN	5	Enable input control. Active high and must be pulled up to enable the device.
VBST	6	Supply input for the high-side NFET gate drive circuit. Connect a 0.1µF capacitor between VBST and SW pins.

## 6 Specifications

### 6.1 Absolute Maximum Ratings<sup>(1)</sup>

T<sub>J</sub> = -40°C to 150°C(unless otherwise noted)

		MIN	MAX	UNIT
Input voltage range	VIN, EN	-0.3	19	V
	VBST	-0.3	25	V
	VBST (10-ns transient)	-0.3	27.5	V
	VBST (vs SW)	-0.3	6.5	V
	VFB	-0.3	6.5	V
	SW	-2	19	V
	SW (10-ns transient)	-3.5	21	V
Operating junction temperature, T <sub>J</sub>		-40	150	°C
Storage temperature range, T <sub>stg</sub>		-55	150	°C

- (1) Stresses beyond those listed under absolute maximum ratings may cause permanent damage to the device. These are stress ratings only, and functional operation of the device at these or any other conditions beyond those indicated under recommended operating conditions is not implied. Exposure to absolute-maximum-rated conditions for extended periods may affect device reliability.

### 6.2 ESD Ratings

			VALUE	UNIT
V <sub>(ESD)</sub>	Electrostatic discharge	Human body model (HBM), per ANSI/ESDA/JEDEC JS-001, all pins <sup>(1)</sup>	±2000	V
		Charged device model (CDM), per JEDEC specification JESD22-C101, all pins <sup>(2)</sup>	±500	

- (1) JEDEC document JEP155 states that 500-V HBM allows safe manufacturing with a standard ESD control process.  
(2) JEDEC document JEP157 states that 250-V CDM allows safe manufacturing with a standard ESD control process.

### 6.3 Recommended Operating Conditions

T<sub>J</sub> = -40°C to 150°C(unless otherwise noted)

		MIN	MAX	UNIT	
V <sub>IN</sub>	Supply input voltage range	4.5	17	V	
V <sub>I</sub>	Input voltage range	VBST	-0.1	23	V
		VBST (10-ns transient)	-0.1	26	
		VBST(vs SW)	-0.1	6	
		EN	-0.1	17	
		VFB	-0.1	5.5	
		SW	-1.8	17	
		SW (10-ns transient)	-3.5	20	
T <sub>A</sub>	Operating free-air temperature	-40	85	°C	

## 6.4 Thermal Information

THERMAL METRIC <sup>(1)</sup>		TPS562200	TPS563200	UNITS
		DDC (SOT)	DDC (SOT)	
		(6 PINS)	(6 PINS)	
$R_{\theta JA}$	Junction-to-ambient thermal resistance	89.0	87.9	°C/W
$R_{\theta JCTop}$	Junction-to-case (top) thermal resistance	44.5	42.2	
$R_{\theta JB}$	Junction-to-board thermal resistance	13.4	13.6	
$\psi_{JT}$	Junction-to-top characterization parameter	2.2	1.9	
$\psi_{JB}$	Junction-to-board characterization parameter	13.2	13.3	

(1) For more information about traditional and new thermal metrics, see the *IC Package Thermal Metrics* application report, [SPRA953](#).

## 6.5 Electrical Characteristics

$T_J = -40^{\circ}\text{C}$  to  $150^{\circ}\text{C}$ ,  $V_{IN} = 12\text{V}$  (unless otherwise noted)

PARAMETER		TEST CONDITIONS	MIN	TYP	MAX	UNIT	
<b>SUPPLY CURRENT</b>							
$I_{(VIN)}$	Operating – non-switching supply current	$V_{IN}$ current, $T_A = 25^{\circ}\text{C}$ , $EN = 5\text{V}$ , $V_{FB} = 0.8\text{V}$	TPS562200	230	330	$\mu\text{A}$	
			TPS563200	190	290		
$I_{(VINSDN)}$	Shutdown supply current	$V_{IN}$ current, $T_A = 25^{\circ}\text{C}$ , $EN = 0\text{V}$		3	10	$\mu\text{A}$	
<b>LOGIC THRESHOLD</b>							
$V_{EN(H)}$	EN high-level input voltage	EN	1.6			V	
$V_{EN(L)}$	EN low-level input voltage	EN			0.6	V	
$R_{EN}$	EN pin resistance to GND	$V_{EN} = 12\text{V}$	225	450	900	k $\Omega$	
<b><math>V_{FB}</math> VOLTAGE AND DISCHARGE RESISTANCE</b>							
$V_{FB(TH)}$	$V_{FB}$ threshold voltage	$T_A = 25^{\circ}\text{C}$ , $V_O = 1.05\text{V}$ , $I_O = 10\text{mA}$ , Eco-mode operation		772		mV	
		$T_A = 25^{\circ}\text{C}$ , $V_O = 1.05\text{V}$ , continuous mode operation	758	765	772	mV	
$I_{(VFB)}$	$V_{FB}$ input current	$V_{FB} = 0.8\text{V}$ , $T_A = 25^{\circ}\text{C}$		0	$\pm 0.1$	$\mu\text{A}$	
<b>MOSFET</b>							
$R_{DS(on)h}$	High side switch resistance	$T_A = 25^{\circ}\text{C}$ , $V_{BST} - SW = 5.5\text{V}$	TPS562200	122		m $\Omega$	
			TPS563200	68		m $\Omega$	
$R_{DS(on)l}$	Low side switch resistance	$T_A = 25^{\circ}\text{C}$	TPS562200	72		m $\Omega$	
			TPS563200	39		m $\Omega$	
<b>CURRENT LIMIT</b>							
$I_{ocL}$	Current limit (1)	DC current, $V_{OUT} = 1.05\text{V}$ , $L_{OUT} = 2.2\mu\text{F}$	TPS562200	2.5	3.2	4.3	A
		DC current, $V_{OUT} = 1.05\text{V}$ , $L_{OUT} = 1.5\mu\text{F}$	TPS563200	3.5	4.2	5.3	A
<b>THERMAL SHUTDOWN</b>							
$T_{SDN}$	Thermal shutdown threshold(1)	Shutdown temperature		155		$^{\circ}\text{C}$	
		Hysteresis		35			
<b>OUTPUT UNDERVOLTAGE AND OVERVOLTAGE PROTECTION</b>							
$V_{OVP}$	Output OVP threshold	OVP Detect		125% x $V_{fbth}$			
$V_{UVP}$	Output Hiccup threshold	Hiccup detect		65% x $V_{fbth}$			
$t_{HiccupOn}$	Hiccup On Time	Relative to soft-start time		1		ms	
$t_{HiccupOff}$	Hiccup Off Time	Relative to soft-start time		7		ms	
<b>UVLO</b>							
UVLO	UVLO threshold	Wake up $V_{IN}$ voltage	3.45	3.75	4.05	V	
		Hysteresis $V_{IN}$ voltage	0.13	0.32	0.55		

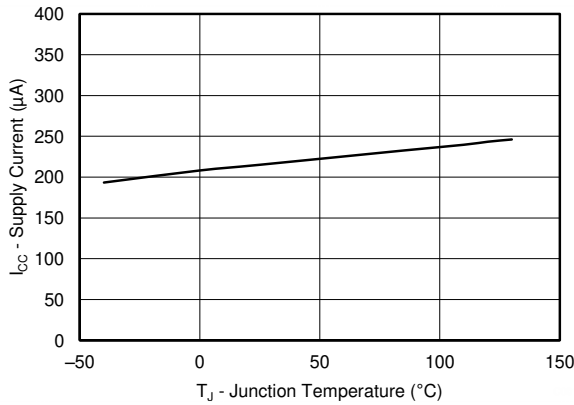
(1) Not production tested

## 6.6 Timing Requirements

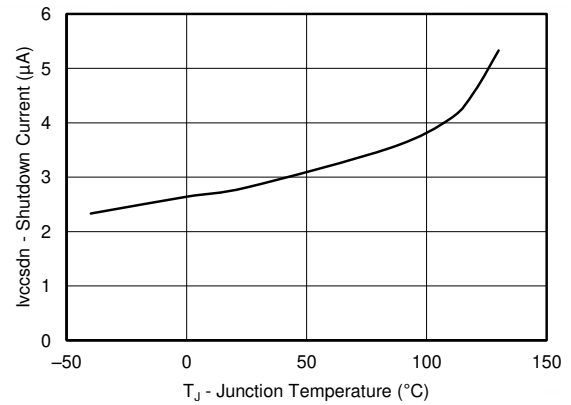
		MIN	TYP	MAX	UNIT	
<b>ON-TIME TIMER CONTROL</b>						
$t_{ON}$	On time	$V_{IN} = 12\text{V}$ , $V_O = 1.05\text{V}$	150		ns	
$t_{OFF(MIN)}$	Minimum off time	$T_A = 25^{\circ}\text{C}$ , $V_{FB} = 0.5\text{V}$	260	310	ns	
<b>SOFT START</b>						
$t_{ss}$	Soft-start time	Internal soft-start time, $T_A = 25^{\circ}\text{C}$	0.7	1	1.3	ms

## 6.7 Typical Characteristics TPS562200

$V_{IN} = 12\text{ V}$  (unless otherwise noted).

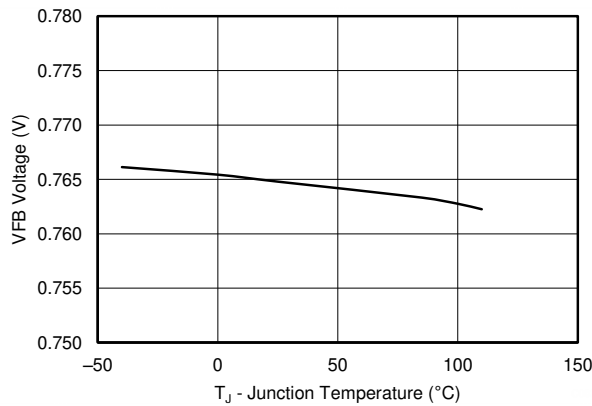


**Figure 6-1. Supply Current vs Junction Temperature**



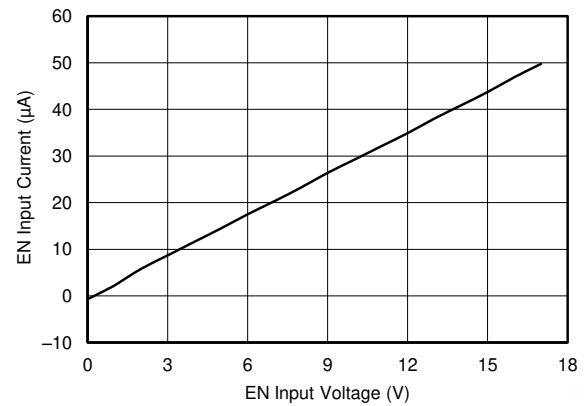
EN = 0 V

**Figure 6-2. VIN Shutdown Current vs Junction Temperature**

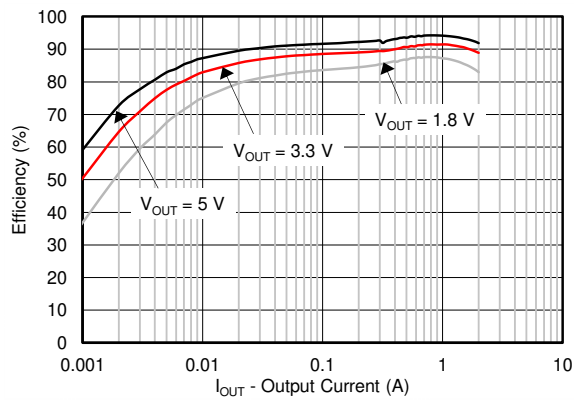


$I_O = 1\text{ A}$

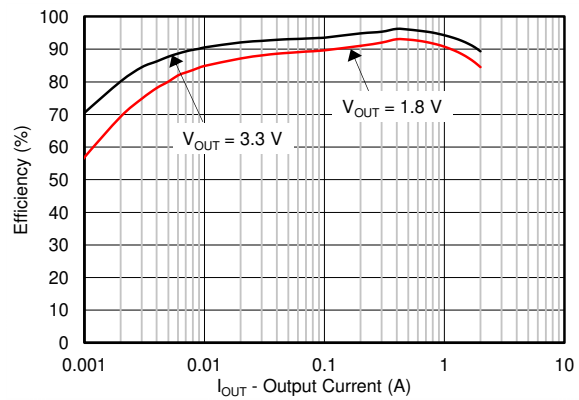
**Figure 6-3. Vfb Voltage vs Junction Temperature**



**Figure 6-4. En Current vs En Voltage**



**Figure 6-5. Efficiency vs Output Current**



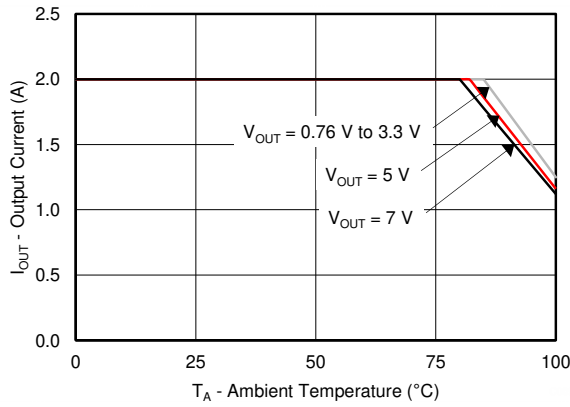
$V_{IN} = 5\text{ V}$

**Figure 6-6. Efficiency vs Output Current**

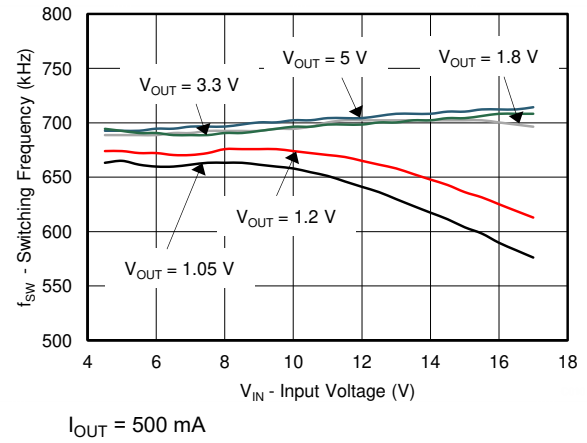


### 6.7 Typical Characteristics TPS562200 (continued)

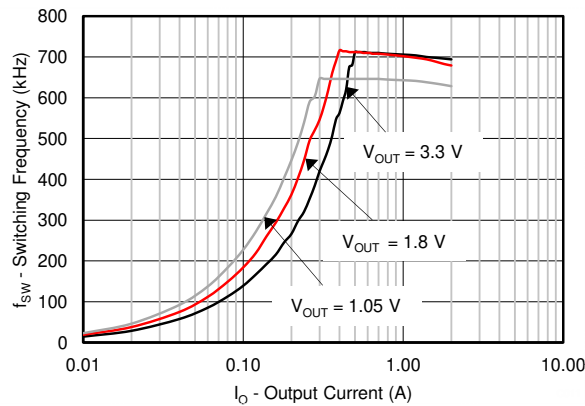
$V_{IN} = 12\text{ V}$  (unless otherwise noted).



**Figure 6-7. Output Current vs Ambient Temperature**



**Figure 6-8. Switching Frequency vs Input Voltage**



**Figure 6-9. Switching Frequency vs Output Current**

## 6.8 Typical Characteristics TPS563200

$V_{IN} = 12\text{ V}$  (unless otherwise noted).

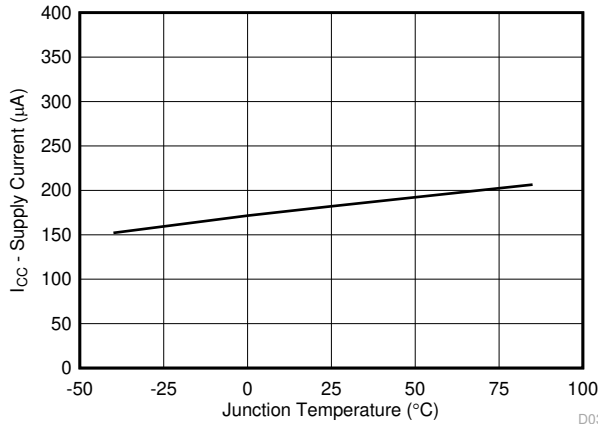
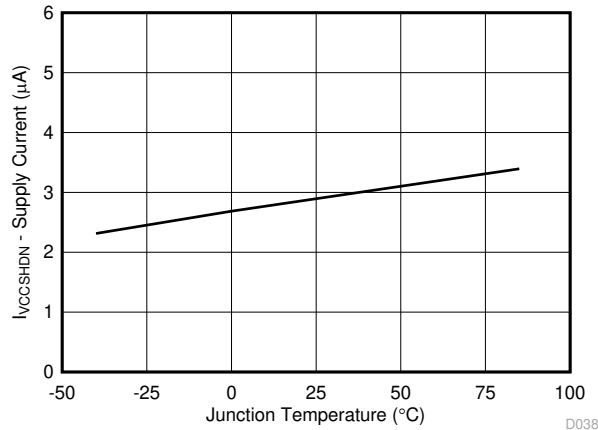
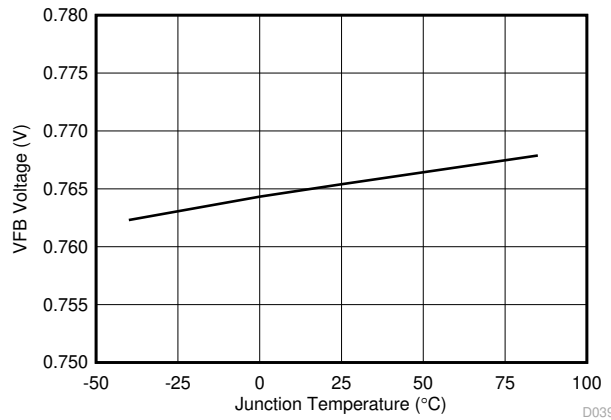


Figure 6-10. Supply Current vs Junction Temperature



EN = 0 V

Figure 6-11. VIN Shutdown Current vs Junction Temperature



I<sub>O</sub> = 1 A

Figure 6-12. Vfb Voltage vs Junction Temperature

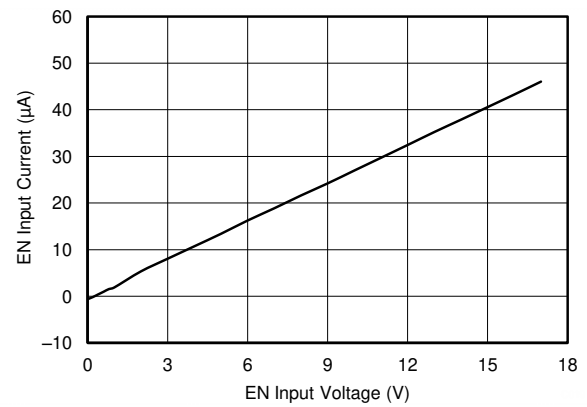


Figure 6-13. En Current vs En Voltage

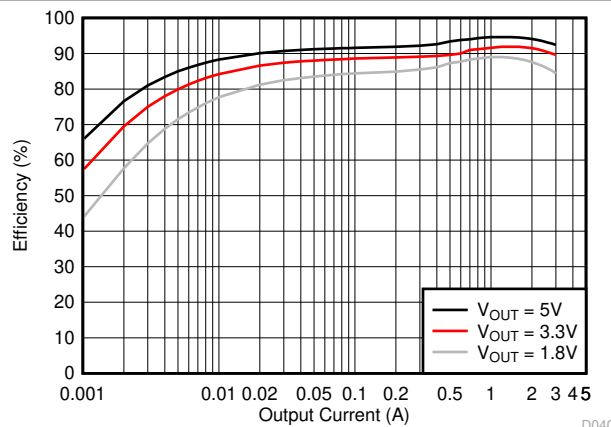
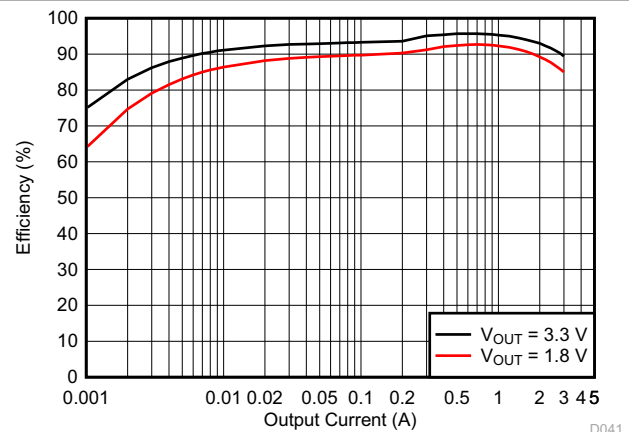


Figure 6-14. Efficiency vs Output Current

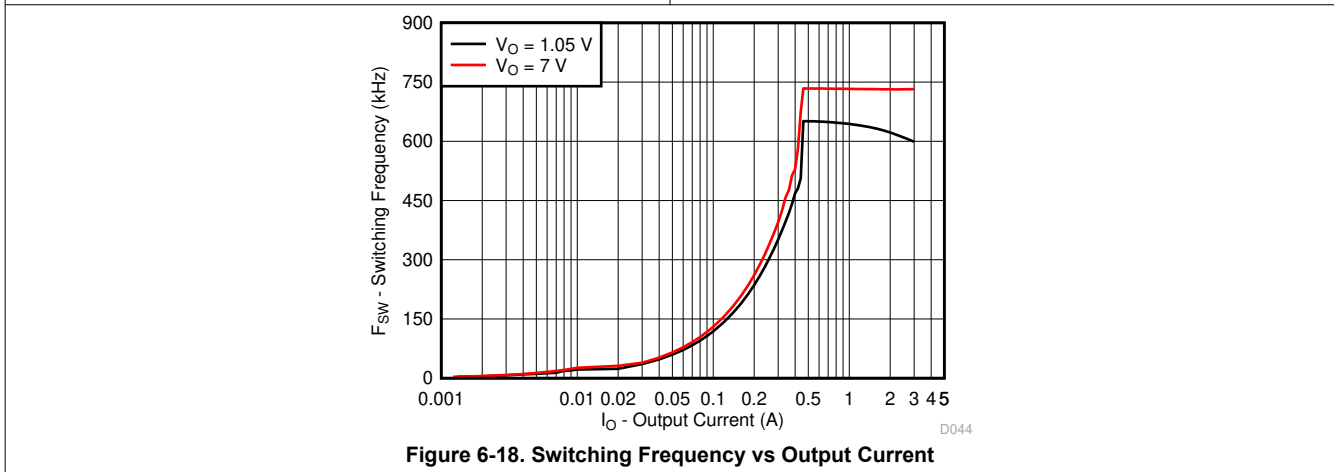
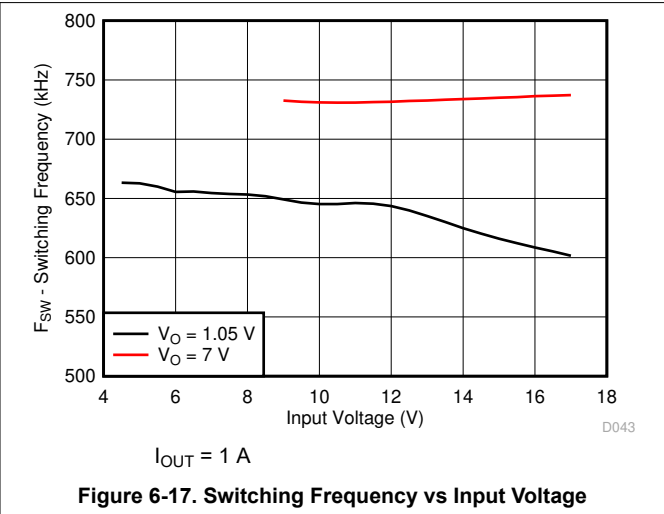
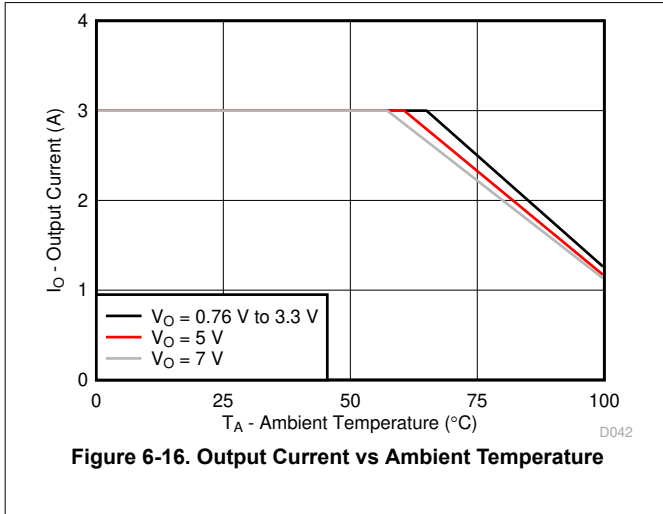


$V_{IN} = 5\text{ V}$

Figure 6-15. Efficiency vs Output Current

## 6.8 Typical Characteristics TPS563200 (continued)

$V_{IN} = 12\text{ V}$  (unless otherwise noted).

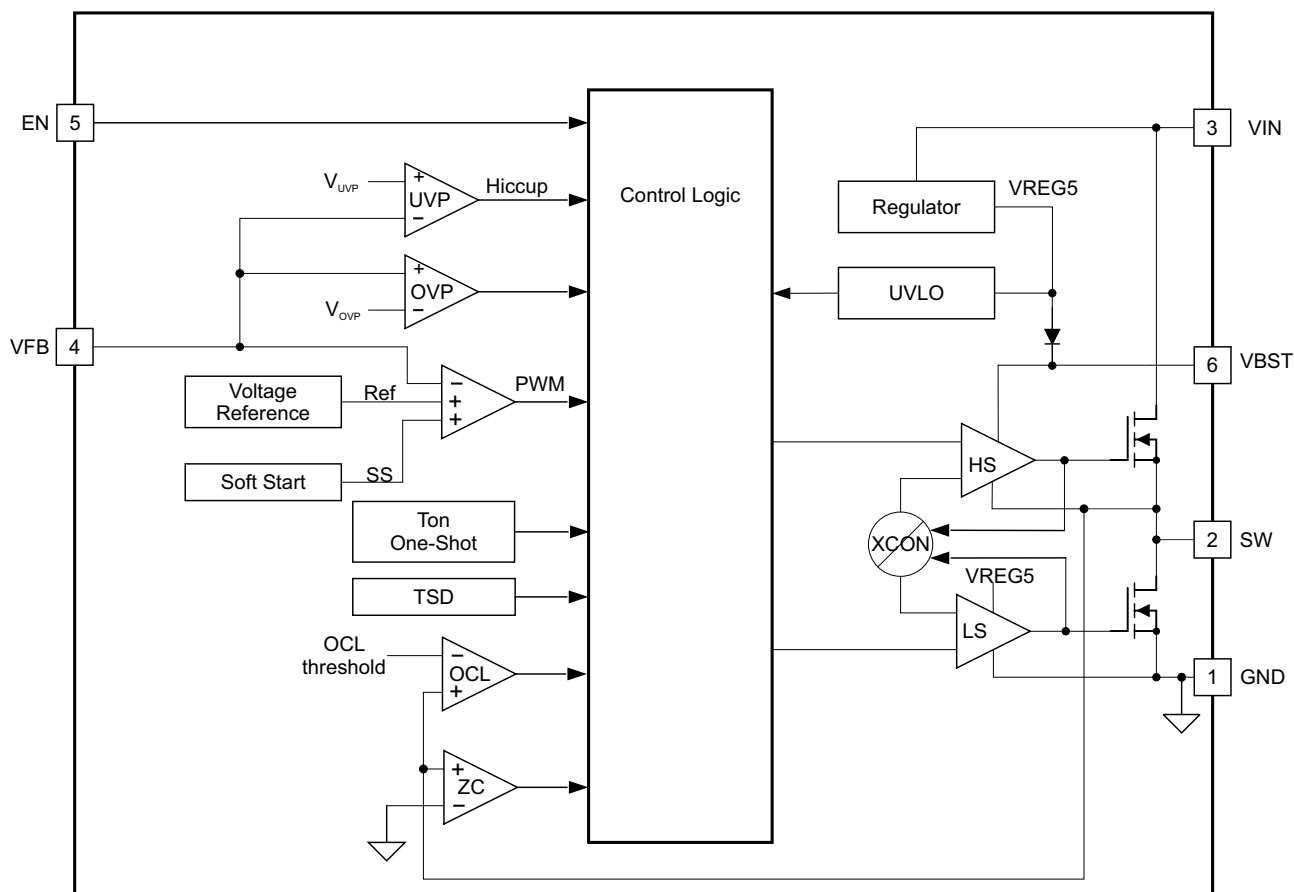


## 7 Detailed Description

### 7.1 Overview

The TPS562200 and TPS563200 are 2-A and 3-A synchronous step-down converters. The proprietary D-CAP2 control scheme supports low ESR output capacitors such as specialty polymer capacitors and multi-layer ceramic capacitors without complex external compensation circuits. The fast transient response of D-CAP2 control scheme can reduce the output capacitance required to meet a specific level of performance.

### 7.2 Functional Block Diagram



## 7.3 Feature Description

### 7.3.1 The Adaptive On-Time Control And PWM Operation

The main control loop of the TPS562200 and TPS563200 are adaptive on-time pulse width modulation (PWM) controller that supports a proprietary D-CAP2 control scheme. The D-CAP2 control scheme combines adaptive on-time control with an internal compensation circuit for pseudo-fixed frequency and low external component count configuration with both low ESR and ceramic output capacitors. It is stable even with virtually no ripple at the output.

At the beginning of each cycle, the high-side MOSFET is turned on. This MOSFET is turned off after internal one shot timer expires. This one shot duration is set inversely proportional to the converter input voltage,  $V_{IN}$ , and proportional to the output voltage,  $V_O$ , to maintain a pseudo-fixed frequency over the input voltage range, hence it is called adaptive on-time control. The one-shot timer is reset and the high-side MOSFET is turned on again when the feedback voltage falls below the reference voltage. An internal ramp is added to reference voltage to simulate output ripple, eliminating the need for ESR induced output ripple from D-CAP2 control scheme.

### 7.3.2 Advanced Eco-mode Control

The TPS562200 and TPS563200 are designed with Advanced Eco-mode to maintain high light load efficiency. As the output current decreases from heavy load condition, the inductor current is also reduced and eventually comes to point that its rippled valley touches zero level, which is the boundary between continuous conduction and discontinuous conduction modes. The rectifying MOSFET is turned off when the zero inductor current is detected. As the load current further decreases, the converter runs into discontinuous conduction mode. The on-time is kept almost the same as it was in the continuous conduction mode so that it takes longer time to discharge the output capacitor with smaller load current to the level of the reference voltage. This makes the switching frequency lower, proportional to the load current, and keeps the light load efficiency high. The transition point to the light load operation  $I_{OUT(LL)}$  current can be calculated in [Equation 1](#).

$$I_{OUT(LL)} = \frac{1}{2 \times L \times f_{SW}} \times \frac{(V_{IN} - V_{OUT}) \times V_{OUT}}{V_{IN}} \quad (1)$$

### 7.3.3 Soft Start And Pre-Biased Soft Start

The TPS562200 and TPS563200 have an internal 1 ms soft-start. When the EN pin becomes high, the internal soft-start function begins ramping up the reference voltage to the PWM comparator. If the output capacitor is pre-biased at startup, the devices initiate switching and start ramping up only after the internal reference voltage becomes greater than the feedback voltage VFB. This scheme ensures that the converters ramp up smoothly into regulation point.

### 7.3.4 Current Protection

The output overcurrent limit (OCL) is implemented using a cycle-by-cycle valley detect control circuit. The switch current is monitored during the OFF state by measuring the low-side FET drain to source voltage. This voltage is proportional to the switch current. To improve accuracy, the voltage sensing is temperature compensated.

During the on time of the high-side FET switch, the switch current increases at a linear rate determined by  $V_{IN}$ ,  $V_{OUT}$ , the on-time and the output inductor value. During the on time of the low-side FET switch, this current decreases linearly. The average value of the switch current is the load current  $I_{OUT}$ . If the monitored current is above the OCL level, the converter maintains low-side FET on and delays the creation of a new set pulse, even the voltage feedback loop requires one, until the current level becomes OCL level or lower. In subsequent switching cycles, the on-time is set to a fixed value and the current is monitored in the same manner. If the over current condition exists consecutive switching cycles, the internal OCL threshold is set to a lower level, reducing the available output current. When a switching cycle occurs where the switch current is not above the lower OCL threshold, the counter is reset and the OCL threshold is returned to the higher value.

There are some important considerations for this type of over-current protection. The load current is higher than the over-current threshold by one half of the peak-to-peak inductor ripple current. Also, when the current is being limited, the output voltage tends to fall as the demanded load current can be higher than the current available from the converter. This can cause the output voltage to fall. When the VFB voltage falls below the

UVP threshold voltage, the UVP comparator detects it. Then, the device shuts down after the UVP delay time (typically 14  $\mu$ s) and re-start after the hiccup time (typically 12 ms).

When the overcurrent condition is removed, the output voltage returns to the regulated value.

### 7.3.5 Over Voltage Protection

TPS562200 and TPS563200 detect overvoltage condition by monitoring the feedback voltage (VFB). When the feedback voltage becomes higher than 125% of the target voltage, the OVP comparator output goes high and both the high-side MOSFET driver and the low-side MOSFET driver turn off. This function is non-latch operation.

### 7.3.6 UVLO Protection

Undervoltage lock out protection (UVLO) monitors the internal regulator voltage. When the voltage is lower than UVLO threshold voltage, the device is shut off. This protection is non-latching.

### 7.3.7 Thermal Shutdown

The device monitors the temperature of itself. If the temperature exceeds the threshold value (typically 155°C), the device is shut off. This is a non-latch protection

## 7.4 Device Functional Modes

### 7.4.1 Normal Operation

When the input voltage is above the UVLO threshold and the EN voltage is above the enable threshold, the TPS562200 and TPS563200 can operate in their normal switching modes. Normal continuous conduction mode (CCM) occurs when the minimum switch current is above 0 A. In CCM, the TPS562200 and TPS563200 operate at a quasi-fixed frequency of 650 kHz.

### 7.4.2 Eco-mode Operation

When the TPS562200 and TPS563200 are in the normal CCM operating mode and the switch current falls to 0 A, the TPS562200 and TPS563200 begin operating in pulse skipping Eco-mode. Each switching cycle is followed by a period of energy saving sleep time. The sleep time ends when the VFB voltage falls below the Eco-mode threshold voltage. As the output current decreases the perceived time between switching pulses increases.

### 7.4.3 Standby Operation

When the TPS562200 and TPS563200 are operating in either normal CCM or Eco-mode, they can be placed in standby by asserting the EN pin low.

## 8 Application and Implementation

### Note

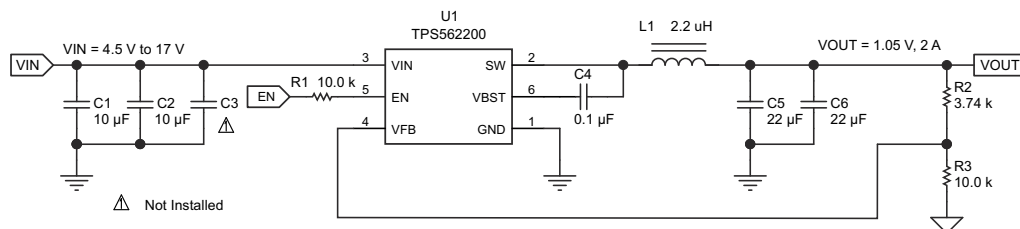
Information in the following applications sections is not part of the TI component specification, and TI does not warrant its accuracy or completeness. TI's customers are responsible for determining suitability of components for their purposes, as well as validating and testing their design implementation to confirm system functionality.

### 8.1 Application Information

The TPS562200 and TPS563200 are typically used as step down converters, which convert a voltage from 4.5 V – 17 V to a lower voltage. WEBENCH software is available to aid in the design and analysis of circuits

### 8.2 Typical Applications

#### 8.2.1 TPS562200 4.5-V To 17-V Input, 1.05-V Output Converter



**Figure 8-1. Tps562200 1.05v/2a Reference Design**

#### 8.2.1.1 Design Requirements

To begin the design process, the user must know a few application parameters:

**Table 8-1. Design Parameters**

PARAMETER	VALUE
Input voltage range	4.5 V to 17 V
Output voltage	1.05 V
Output current	2 A
Output voltage ripple	20 mVpp

#### 8.2.1.2 Detailed Design Procedures

##### 8.2.1.2.1 Custom Design with WEBENCH® Tools

[Click here](#) to create a custom design using the WEBENCH Power Designer.

1. Start by entering your  $V_{IN}$ ,  $V_{OUT}$  and  $I_{OUT}$  requirements.
2. Optimize your design for key parameters like efficiency, footprint and cost using the optimizer dial and compare this design with other possible solutions from Texas Instruments.
3. WEBENCH Power Designer provides you with a customized schematic along with a list of materials with real time pricing and component availability.
4. In most cases, you will also be able to:
  - Run electrical simulations to see important waveforms and circuit performance,
  - Run thermal simulations to understand the thermal performance of your board,
  - Export your customized schematic and layout into popular CAD formats,
  - Print PDF reports for the design, and share your design with colleagues.

##### 8.2.1.2.2 Output Voltage Resistors Selection

The output voltage is set with a resistor divider from the output node to the VFB pin. TI recommends to use 1% tolerance or better divider resistors. Start by using [Equation 2](#) to calculate  $V_{OUT}$ .

To improve efficiency at light loads consider using larger value resistors, too high of resistance is more susceptible to noise and voltage errors from the VFB input current are more noticeable.

$$V_{\text{OUT}} = 0.765 \times \left( 1 + \frac{R2}{R3} \right) \quad (2)$$



### 8.2.1.2.3 Output Filter Selection

The LC filter used as the output filter has double pole at:

$$F_P = \frac{1}{2\pi\sqrt{L_{OUT} \times C_{OUT}}} \quad (3)$$

At low frequencies, the overall loop gain is set by the output set-point resistor divider network and the internal gain of the device. The low frequency phase is 180 degrees. At the output filter pole frequency, the gain rolls off at a –40 dB per decade rate and the phase drops rapidly. D-CAP2 control scheme introduces a high frequency zero that reduces the gain roll off to –20 dB per decade and increases the phase to 90 degrees one decade above the zero frequency. The inductor and capacitor selected for the output filter must be selected so that the double pole of Equation 3 is located below the high frequency zero but close enough that the phase boost provided by the high frequency zero provides adequate phase margin for a stable circuit. To meet this requirement use the values recommended in Table 1.

**Table 8-2. TPS562200 Recommended Component Values**

Output Voltage (V)	R2 (kΩ)	R3 (kΩ)	L1(μH)			C5 + C6 (μF)
			MIN	TYP	MAX	
1	3.09	10.0	1.5	2.2	4.7	20 - 68
1.05	3.74	10.0	1.5	2.2	4.7	20 - 68
1.2	5.76	10.0	1.5	2.2	4.7	20 - 68
1.5	9.53	10.0	1.5	2.2	4.7	20 - 68
1.8	13.7	10.0	1.5	2.2	4.7	20 - 68
2.5	22.6	10.0	2.2	3.3	4.7	20 - 68
3.3	33.2	10.0	2.2	3.3	4.7	20 - 68
5	54.9	10.0	3.3	4.7	4.7	20 - 68
6.5	75	10.0	3.3	4.7	4.7	20 - 68

The inductor peak-to-peak ripple current, peak current and RMS current are calculated using Equation 4, Equation 5 and Equation 6. The inductor saturation current rating must be greater than the calculated peak current and the RMS or heating current rating must be greater than the calculated RMS current. Use 650 kHz for  $f_{SW}$ .

Use 650 kHz for  $f_{SW}$ . Make sure the chosen inductor is rated for the peak current of Equation 5 and the RMS current of Equation 6.

$$I_{P-P} = \frac{V_{OUT}}{V_{IN(MAX)}} \times \frac{V_{IN(MAX)} - V_{OUT}}{L_O \times f_{SW}} \quad (4)$$

$$I_{PEAK} = I_O + \frac{I_{P-P}}{2} \quad (5)$$

$$I_{LO(RMS)} = \sqrt{I_O^2 + \frac{1}{12} I_{P-P}^2} \quad (6)$$

For this design example, the calculated peak current is 2.34 A and the calculated RMS current is 2.01 A. The inductor used is a TDK CLF7045T-2R2N with a peak current rating of 5.5 A and an RMS current rating of 4.3 A

The capacitor value and ESR determines the amount of output voltage ripple. The device is intended for use with ceramic or other low ESR capacitors. Recommended values range from 20 μF to 68 μF. Use Equation 7 to determine the required RMS current rating for the output capacitor.

$$I_{CO(RMS)} = \frac{V_{OUT} \times (V_{IN} - V_{OUT})}{\sqrt{12} \times V_{IN} \times L_O \times f_{SW}} \quad (7)$$

For this design, two TDK C3216X5R0J226M 22- $\mu$ F output capacitors are used. The typical ESR is 2 m $\Omega$  each. The calculated RMS current is 0.286 A and each output capacitor is rated for 4 A.

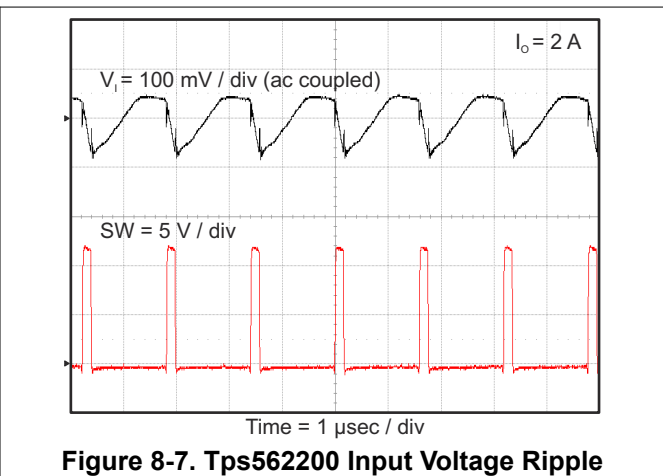
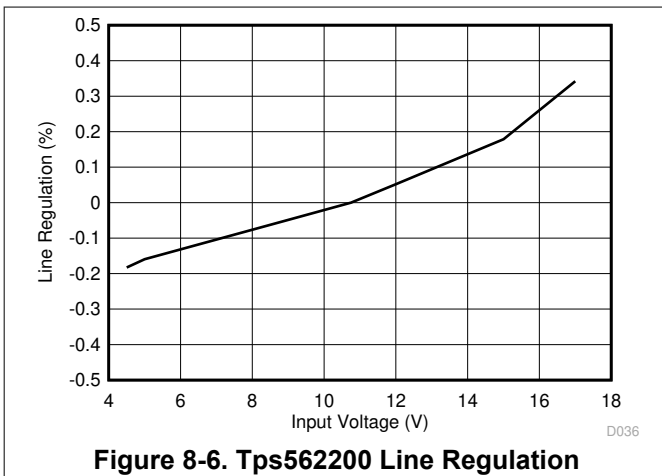
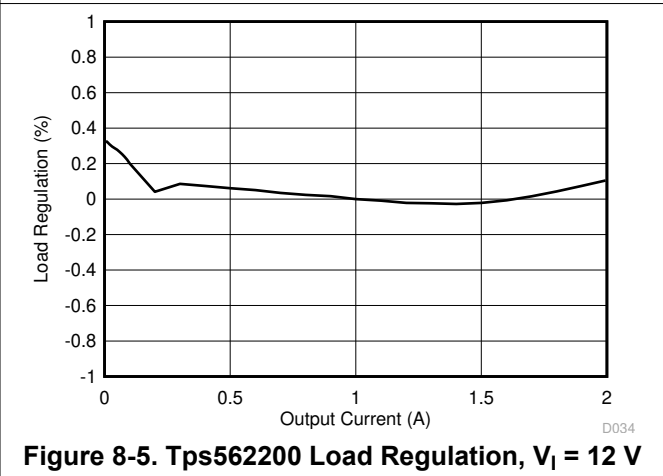
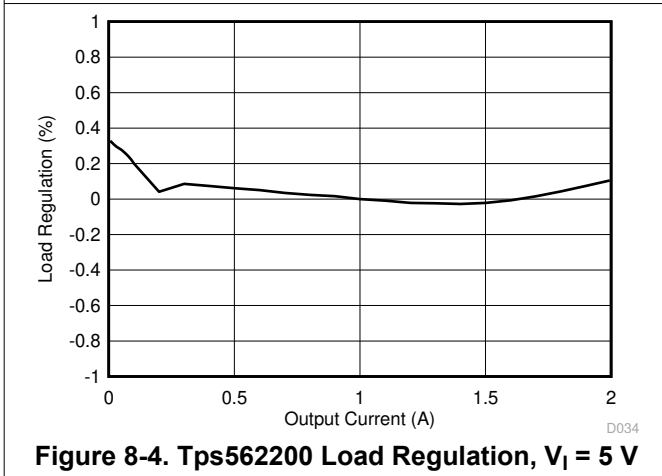
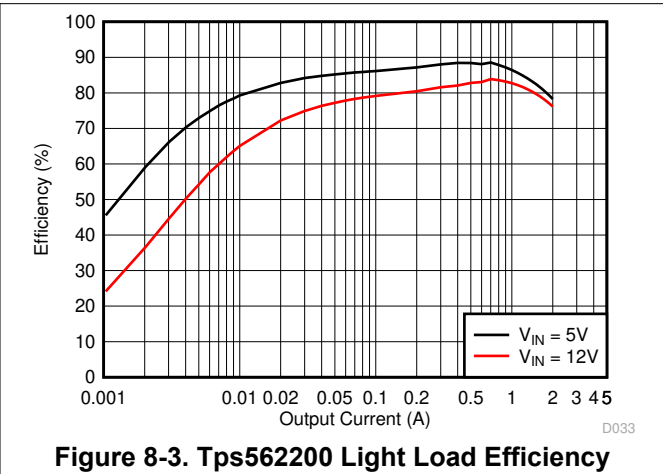
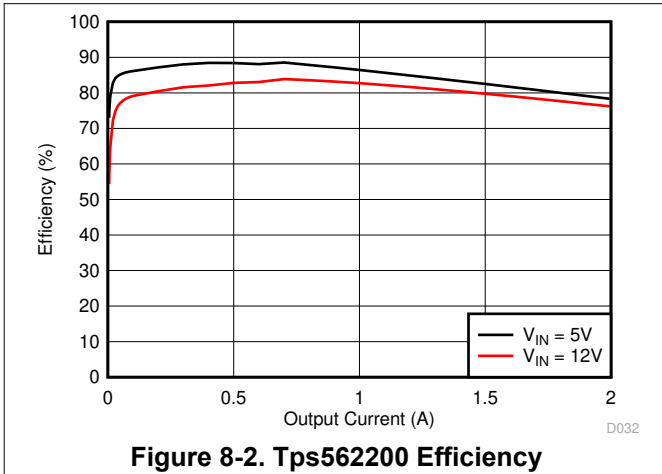
#### 8.2.1.2.4 Input Capacitor Selection

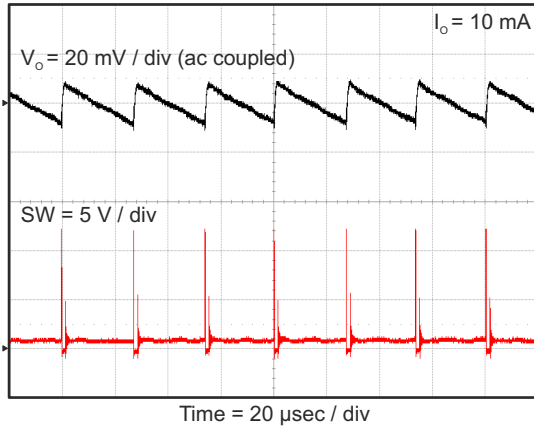
The device requires an input decoupling capacitor and a bulk capacitor is needed depending on the application. TI recommends a ceramic capacitor over 10  $\mu$ F for the decoupling capacitor. An additional 0.1- $\mu$ F capacitor(C3) from pin 3 to ground is optional to provide additional high frequency filtering. The capacitor voltage rating must be greater than the maximum input voltage.

#### 8.2.1.2.5 Bootstrap Capacitor Selection

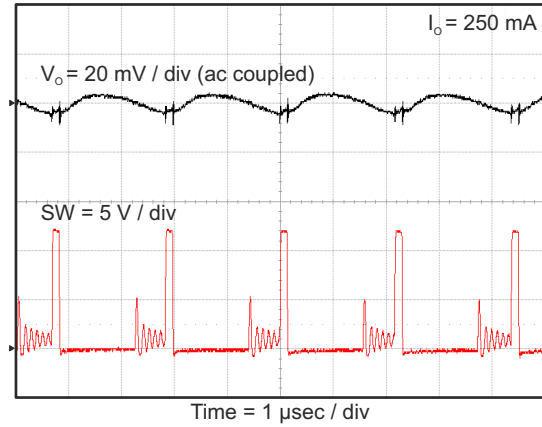
A 0.1- $\mu$ F ceramic capacitor must be connected between the VBST to SW pin for proper operation. TI recommends to use a ceramic capacitor.

### 8.2.1.3 Application Curves

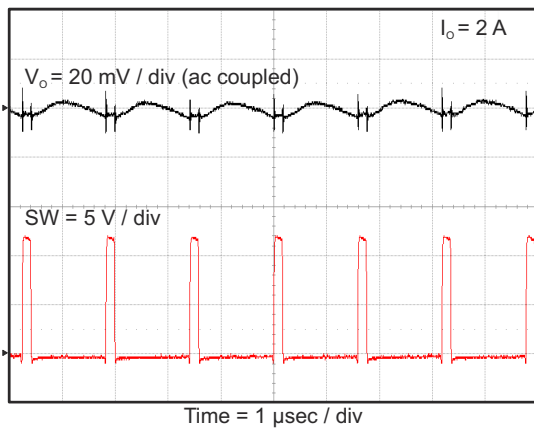




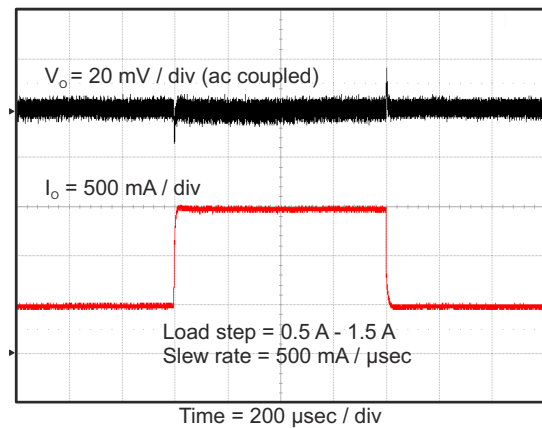
**Figure 8-8. TPS562200 Output Voltage Ripple**



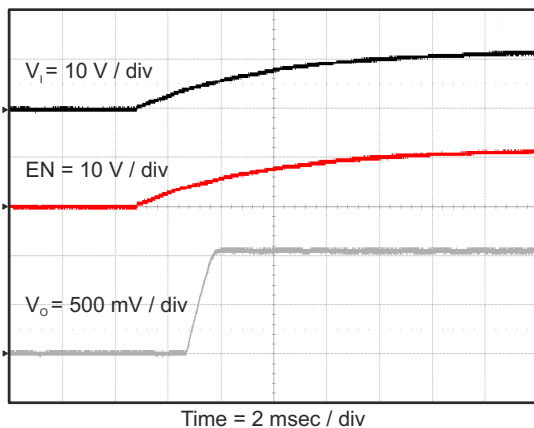
**Figure 8-9. TPS562200 Output Voltage Ripple**



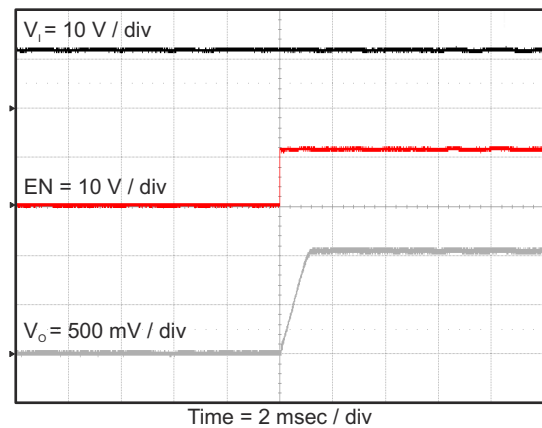
**Figure 8-10. TPS562200 Output Voltage Ripple**



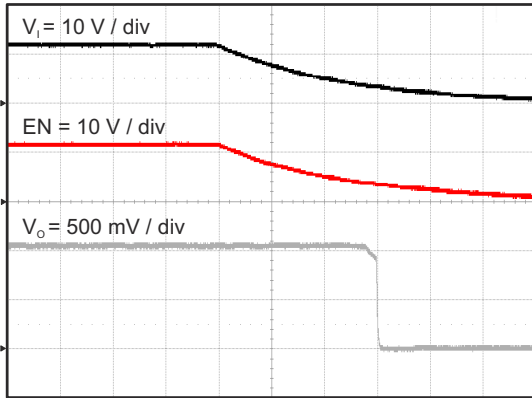
**Figure 8-11. TPS562200 Transient Response**



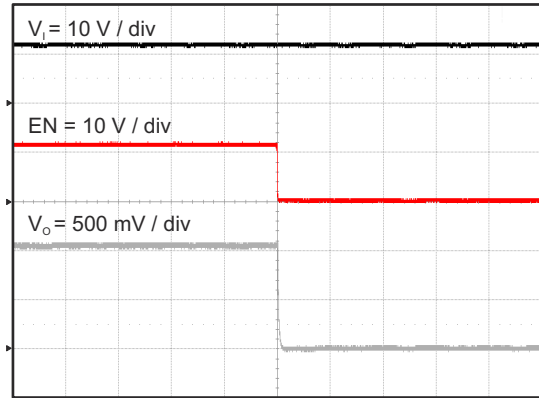
**Figure 8-12. TPS562200 Start Up Relative to  $V_I$**



**Figure 8-13. TPS562200 Start Up Relative to EN**

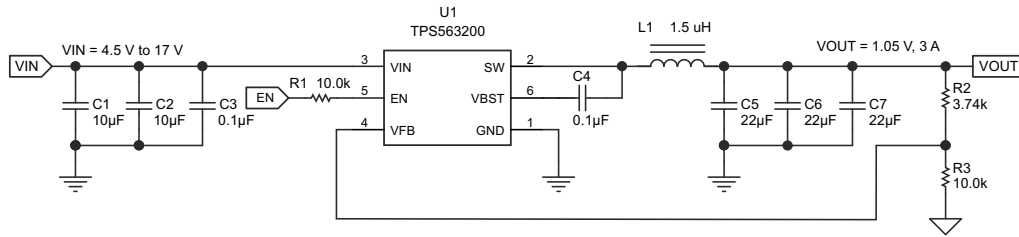


Time = 2 msec / div  
**Figure 8-14. Tps562200 Shut Down Relative to  $V_i$**



Time = 2 msec / div  
**Figure 8-15. Tps562200 Shut Down Relative to En**

## 8.2.2 Tps563200 4.5-V To 17-V Input, 1.05-V Output Converter



Copyright © 2016, Texas Instruments Incorporated

Figure 8-16. Tps563200 1.05v/3a Reference Design

### 8.2.2.1 Design Requirements

To begin the design process, the user must know a few application parameters:

Table 8-3. Design Parameters

PARAMETER	VALUE
Input voltage range	4.5 V to 17 V
Output voltage	1.05 V
Output current	3 A
Output voltage ripple	20 mVpp

### 8.2.2.2 Detailed Design Procedures

The detailed design procedure for TPS563200 is the same as for TPS562200 except for inductor selection.

#### 8.2.2.2.1 Output Filter Selection

Table 8-4. Tps563200 Recommended Component Values

Output Voltage (V)	R2 (kΩ)	R3 (kΩ)	L1 (µH)			C5 + C6 + C7 (µF)
			MIN	TYP	MAX	
1	3.09	10.0	1.0	1.5	4.7	20 - 68
1.05	3.74	10.0	1.0	1.5	4.7	20 - 68
1.2	5.76	10.0	1.0	1.5	4.7	20 - 68
1.5	9.53	10.0	1.0	1.5	4.7	20 - 68
1.8	13.7	10.0	1.5	2.2	4.7	20 - 68
2.5	22.6	10.0	1.5	2.2	4.7	20 - 68
3.3	33.2	10.0	1.5	2.2	4.7	20 - 68
5	54.9	10.0	2.2	3.3	4.7	20 - 68
6.5	75	10.0	2.2	3.3	4.7	20 - 68

The inductor peak-to-peak ripple current, peak current and RMS current are calculated using Equation 8, Equation 9 and Equation 10. The inductor saturation current rating must be greater than the calculated peak current and the RMS or heating current rating must be greater than the calculated RMS current. Use 650 kHz for  $f_{SW}$ .

Use 650 kHz for  $f_{SW}$ . Make sure the chosen inductor is rated for the peak current of Equation 9 and the RMS current of Equation 10.

$$I_{P-P} = \frac{V_{OUT}}{V_{IN(MAX)}} \times \frac{V_{IN(MAX)} - V_{OUT}}{L_O \times f_{SW}} \quad (8)$$

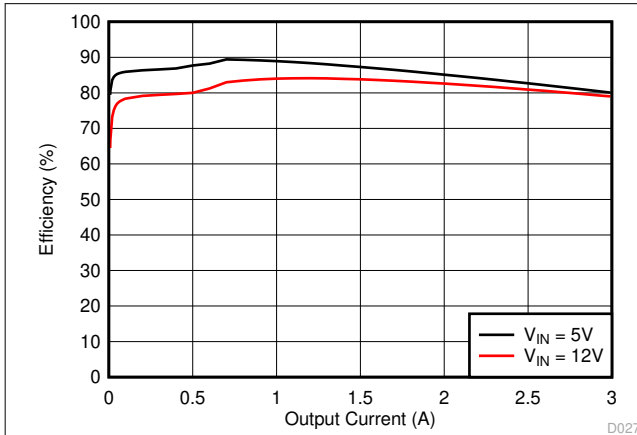
$$I_{\text{PEAK}} = I_{\text{O}} + \frac{I_{\text{P-P}}}{2} \quad (9)$$

$$I_{\text{LO(RMS)}} = \sqrt{I_{\text{O}}^2 + \frac{1}{12} I_{\text{P-P}}^2} \quad (10)$$

For this design example, the calculated peak current is 3.505 A and the calculated RMS current is 3.014 A. The inductor used is a TDK CLF7045T-1R5N with a peak current rating of 7.3 A and an RMS current rating of 4.9 A.

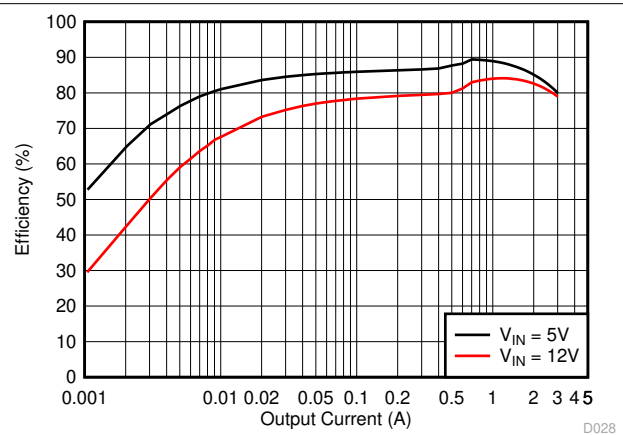
The capacitor value and ESR determines the amount of output voltage ripple. The TPS563209 is intended for use with ceramic or other low ESR capacitors. Recommended values range from 20  $\mu\text{F}$  to 68  $\mu\text{F}$ . Use Equation 6 to determine the required RMS current rating for the output capacitor. For this design three TDK C3216X5R0J226M 22 $\mu\text{F}$  output capacitors are used. The typical ESR is 2 m $\Omega$  each. The calculated RMS current is 0.292 A and each output capacitor is rated for 4 A.

### 8.2.2.3 Application Curves



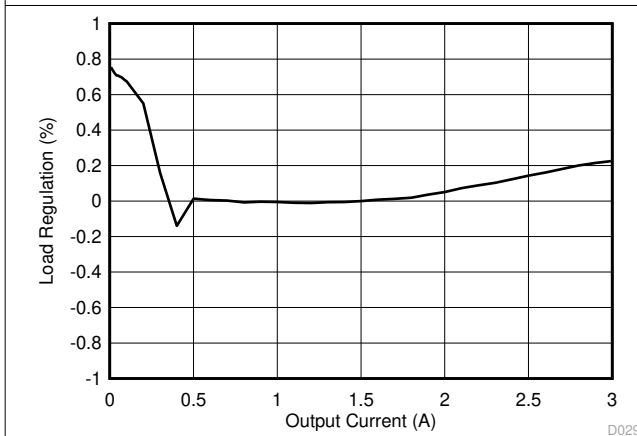
**Figure 8-17. Tps563200 Efficiency**

D027



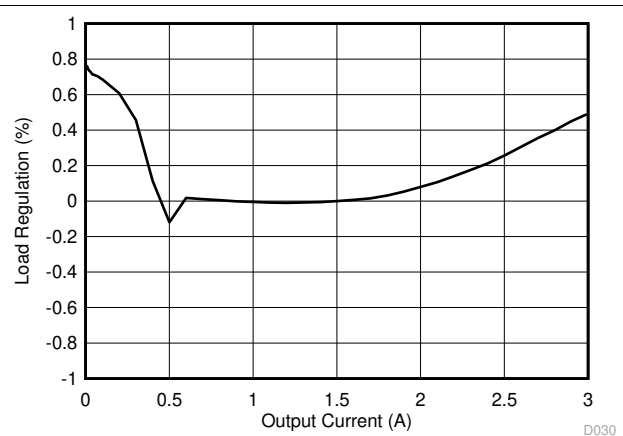
**Figure 8-18. Tps563200 Light Load Efficiency**

D028



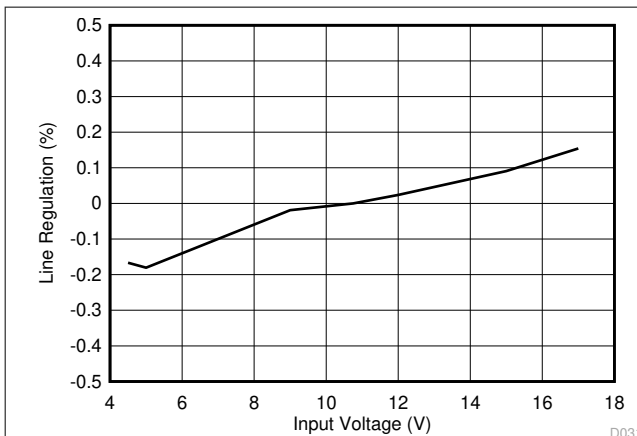
**Figure 8-19. Tps563200 Load Regulation,  $V_I = 5\text{ V}$**

D029



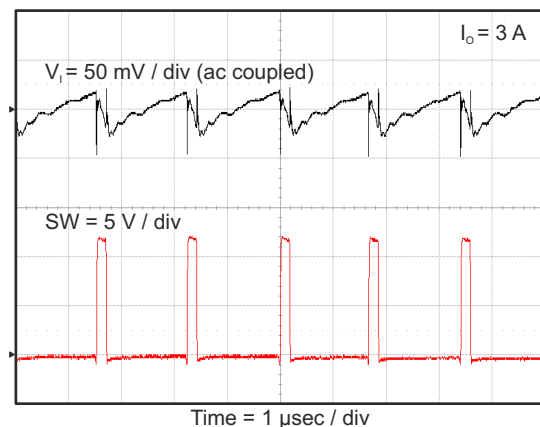
**Figure 8-20. Tps563200 Load Regulation,  $V_I = 12\text{ V}$**

D030



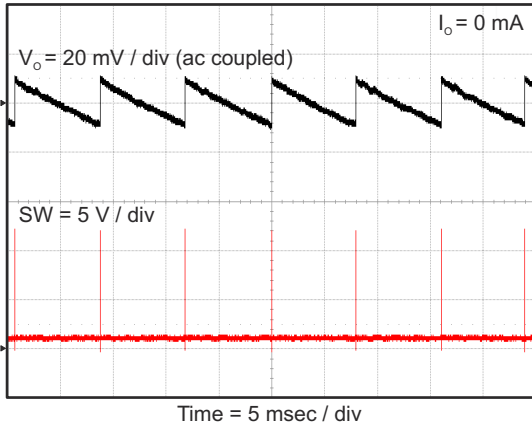
**Figure 8-21. Tps563200 Line Regulation**

D031

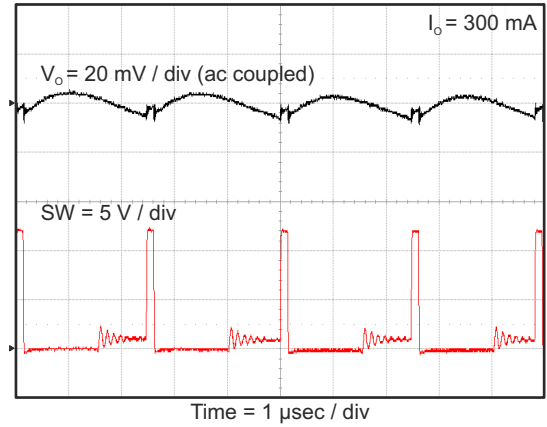


**Figure 8-22. Tps563200 Input Voltage Ripple**

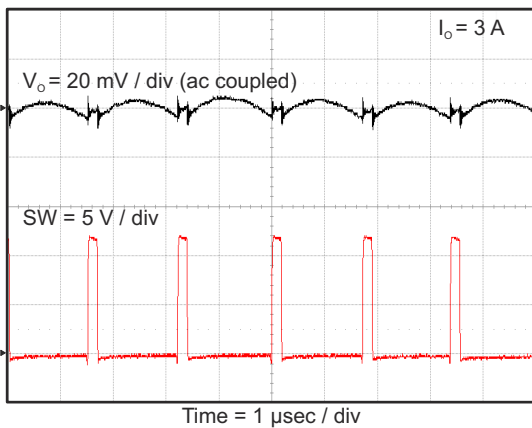




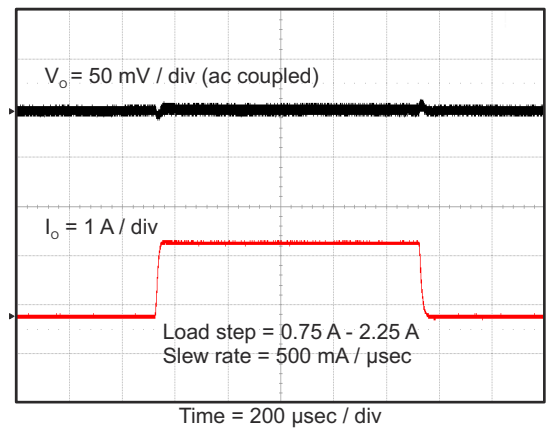
**Figure 8-23. Tps563200 Output Voltage Ripple**



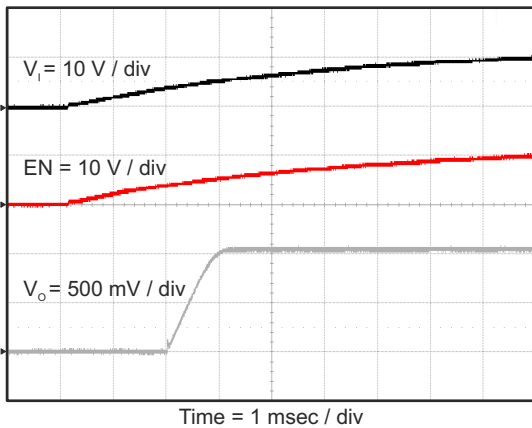
**Figure 8-24. Tps563200 Output Voltage Ripple**



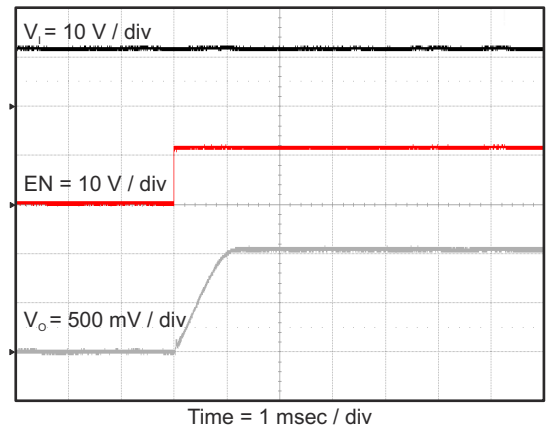
**Figure 8-25. Tps563200 Output Voltage Ripple**



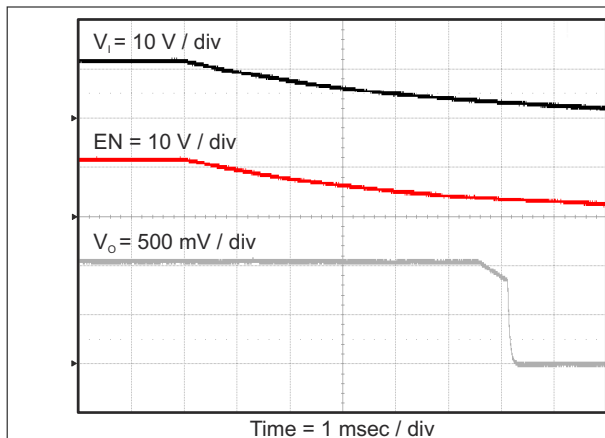
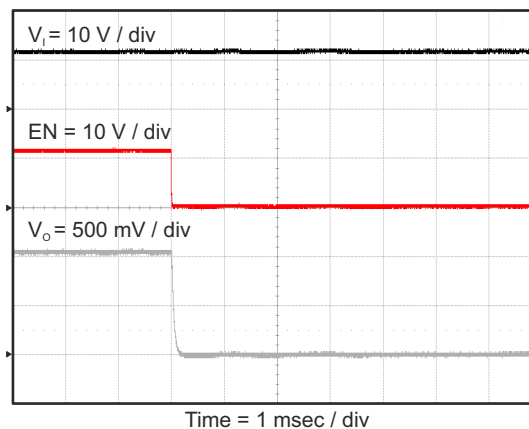
**Figure 8-26. Tps563200 Transient Response**



**Figure 8-27. Tps563200 Start-up Relative to  $V_I$**



**Figure 8-28. Tps563200 Start-up Relative to  $En$**


**Figure 8-29. Tps563200 Shutdown Relative to  $V_i$** 

**Figure 8-30. Tps563200 Shutdown Relative to  $En$** 

### 8.3 Power Supply Recommendations

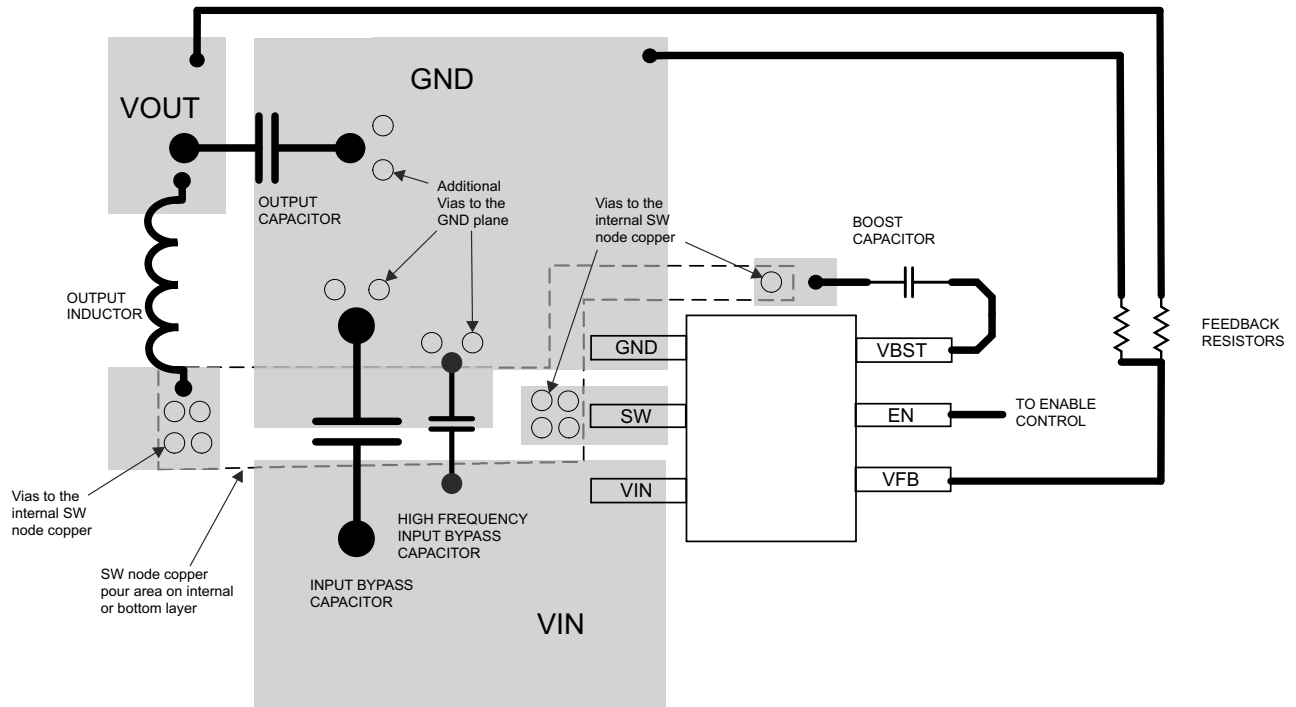
The TPS562200 and TPS563200 are designed to operate from input supply voltage in the range of 4.5 V to 17 V. Buck converters require the input voltage to be higher than the output voltage for proper operation. The maximum recommended operating duty cycle is 65%. Using that criteria, the minimum recommended input voltage is  $V_O / 0.65$ .

### 8.4 Layout

#### 8.4.1 Layout Guidelines

1. VIN and GND traces must be as wide as possible to reduce trace impedance. The wide areas are also of advantage from the view point of heat dissipation.
2. The input capacitor and output capacitor must be placed as close to the device as possible to minimize trace impedance.
3. Provide sufficient vias for the input capacitor and output capacitor.
4. Keep the SW trace as physically short and wide as practical to minimize radiated emissions.
5. Do not allow switching current to flow under the device.
6. A separate VOUT path must be connected to the upper feedback resistor
7. Make a Kelvin connection to the GND pin for the feedback path.
8. Voltage feedback loop must be placed away from the high-voltage switching trace, and preferably has ground shield.
9. The trace of the VFB node must be as small as possible to avoid noise coupling.
10. The GND trace between the output capacitor and the GND pin must be as wide as possible to minimize its trace impedance.

### 8.4.2 Layout Example



**Figure 8-31. Typical Layout**

## 9 Device and Documentation Support

### 9.1 Device Support

#### 9.1.1 Development Support

##### 9.1.1.1 Custom Design with WEBENCH® Tools

[Click here](#) to create a custom design using the WEBENCH Power Designer.

1. Start by entering your  $V_{IN}$ ,  $V_{OUT}$  and  $I_{OUT}$  requirements.
2. Optimize your design for key parameters like efficiency, footprint and cost using the optimizer dial and compare this design with other possible solutions from Texas Instruments.
3. WEBENCH Power Designer provides you with a customized schematic along with a list of materials with real time pricing and component availability.
4. In most cases, you will also be able to:
  - Run electrical simulations to see important waveforms and circuit performance,
  - Run thermal simulations to understand the thermal performance of your board,
  - Export your customized schematic and layout into popular CAD formats,
  - Print PDF reports for the design, and share your design with colleagues.

### 9.2 Receiving Notification of Documentation Updates

To receive notification of documentation updates, navigate to the device product folder on [ti.com](http://ti.com). Click on *Subscribe to updates* to register and receive a weekly digest of any product information that has changed. For change details, review the revision history included in any revised document.

### 9.3 Support Resources

[TI E2E™ support forums](#) are an engineer's go-to source for fast, verified answers and design help — straight from the experts. Search existing answers or ask your own question to get the quick design help you need.

Linked content is provided "AS IS" by the respective contributors. They do not constitute TI specifications and do not necessarily reflect TI's views; see TI's [Terms of Use](#).

### 9.4 Trademarks

D-CAP2™ and TI E2E™ are trademarks of Texas Instruments.

Blu-ray Disc™ is a trademark of Blu-ray Disc Association.

WEBENCH® is a registered trademark of Texas Instruments.

All trademarks are the property of their respective owners.

### 9.5 Electrostatic Discharge Caution



This integrated circuit can be damaged by ESD. Texas Instruments recommends that all integrated circuits be handled with appropriate precautions. Failure to observe proper handling and installation procedures can cause damage.

ESD damage can range from subtle performance degradation to complete device failure. Precision integrated circuits may be more susceptible to damage because very small parametric changes could cause the device not to meet its published specifications.

### 9.6 Glossary

[TI Glossary](#) This glossary lists and explains terms, acronyms, and definitions.

## 10 Mechanical, Packaging, And Orderable Information

The following pages include mechanical, packaging, and orderable information. This information is the most current data available for the designated devices. This data is subject to change without notice and revision of this document. For browser-based versions of this data sheet, refer to the left-hand navigation.

## PACKAGING INFORMATION

Orderable part number	Status (1)	Material type (2)	Package   Pins	Package qty   Carrier	RoHS (3)	Lead finish/ Ball material (4)	MSL rating/ Peak reflow (5)	Op temp (°C)	Part marking (6)
<a href="#">TPS562200DDCR</a>	Active	Production	SOT-23-THIN (DDC)   6	3000   LARGE T&R	Yes	Call TI   Sn	Level-1-260C-UNLIM	-40 to 125	200
TPS562200DDCR.A	Active	Production	null (null)	3000   LARGE T&R	-	SN	Level-1-260C-UNLIM	See TPS562200DDCR	200
TPS562200DDCR.B	Active	Production	null (null)	3000   LARGE T&R	-	SN	Level-1-260C-UNLIM	See TPS562200DDCR	200
<a href="#">TPS562200DDCT</a>	Active	Production	SOT-23-THIN (DDC)   6	250   SMALL T&R	Yes	Call TI   Sn	Level-1-260C-UNLIM	-40 to 125	200
TPS562200DDCT.A	Active	Production	null (null)	250   SMALL T&R	-	SN	Level-1-260C-UNLIM	See TPS562200DDCT	200
TPS562200DDCT.B	Active	Production	null (null)	250   SMALL T&R	-	SN	Level-1-260C-UNLIM	See TPS562200DDCT	200
<a href="#">TPS563200DDCR</a>	Active	Production	SOT-23-THIN (DDC)   6	3000   LARGE T&R	Yes	SN	Level-1-260C-UNLIM	-40 to 125	320
TPS563200DDCR.A	Active	Production	null (null)	3000   LARGE T&R	-	SN	Level-1-260C-UNLIM	See TPS563200DDCR	320
TPS563200DDCR.B	Active	Production	null (null)	3000   LARGE T&R	-	SN	Level-1-260C-UNLIM	See TPS563200DDCR	320
<a href="#">TPS563200DDCT</a>	Active	Production	SOT-23-THIN (DDC)   6	250   SMALL T&R	Yes	SN	Level-1-260C-UNLIM	-40 to 125	320
TPS563200DDCT.A	Active	Production	null (null)	250   SMALL T&R	-	SN	Level-1-260C-UNLIM	See TPS563200DDCT	320
TPS563200DDCT.B	Active	Production	null (null)	250   SMALL T&R	-	SN	Level-1-260C-UNLIM	See TPS563200DDCT	320

(1) **Status:** For more details on status, see our [product life cycle](#).

(2) **Material type:** When designated, preproduction parts are prototypes/experimental devices, and are not yet approved or released for full production. Testing and final process, including without limitation quality assurance, reliability performance testing, and/or process qualification, may not yet be complete, and this item is subject to further changes or possible discontinuation. If available for ordering, purchases will be subject to an additional waiver at checkout, and are intended for early internal evaluation purposes only. These items are sold without warranties of any kind.

(3) **RoHS values:** Yes, No, RoHS Exempt. See the [TI RoHS Statement](#) for additional information and value definition.

(4) **Lead finish/Ball material:** Parts may have multiple material finish options. Finish options are separated by a vertical ruled line. Lead finish/Ball material values may wrap to two lines if the finish value exceeds the maximum column width.

(5) **MSL rating/Peak reflow:** The moisture sensitivity level ratings and peak solder (reflow) temperatures. In the event that a part has multiple moisture sensitivity ratings, only the lowest level per JEDEC standards is shown. Refer to the shipping label for the actual reflow temperature that will be used to mount the part to the printed circuit board.

(6) **Part marking:** There may be an additional marking, which relates to the logo, the lot trace code information, or the environmental category of the part.

Multiple part markings will be inside parentheses. Only one part marking contained in parentheses and separated by a "-" will appear on a part. If a line is indented then it is a continuation of the previous line and the two combined represent the entire part marking for that device.

**Important Information and Disclaimer:** The information provided on this page represents TI's knowledge and belief as of the date that it is provided. TI bases its knowledge and belief on information provided by third parties, and makes no representation or warranty as to the accuracy of such information. Efforts are underway to better integrate information from third parties. TI has taken and continues to take reasonable steps to provide representative and accurate information but may not have conducted destructive testing or chemical analysis on incoming materials and chemicals. TI and TI suppliers consider certain information to be proprietary, and thus CAS numbers and other limited information may not be available for release.

In no event shall TI's liability arising out of such information exceed the total purchase price of the TI part(s) at issue in this document sold by TI to Customer on an annual basis.

**TAPE AND REEL INFORMATION**

**QUADRANT ASSIGNMENTS FOR PIN 1 ORIENTATION IN TAPE**


\*All dimensions are nominal

Device	Package Type	Package Drawing	Pins	SPQ	Reel Diameter (mm)	Reel Width W1 (mm)	A0 (mm)	B0 (mm)	K0 (mm)	P1 (mm)	W (mm)	Pin1 Quadrant
TPS562200DDCR	SOT-23-THIN	DDC	6	3000	180.0	8.4	3.2	3.2	1.4	4.0	8.0	Q3
TPS562200DDCT	SOT-23-THIN	DDC	6	250	180.0	8.4	3.2	3.2	1.4	4.0	8.0	Q3
TPS563200DDCR	SOT-23-THIN	DDC	6	3000	180.0	8.4	3.2	3.2	1.4	4.0	8.0	Q3
TPS563200DDCT	SOT-23-THIN	DDC	6	250	180.0	8.4	3.2	3.2	1.4	4.0	8.0	Q3

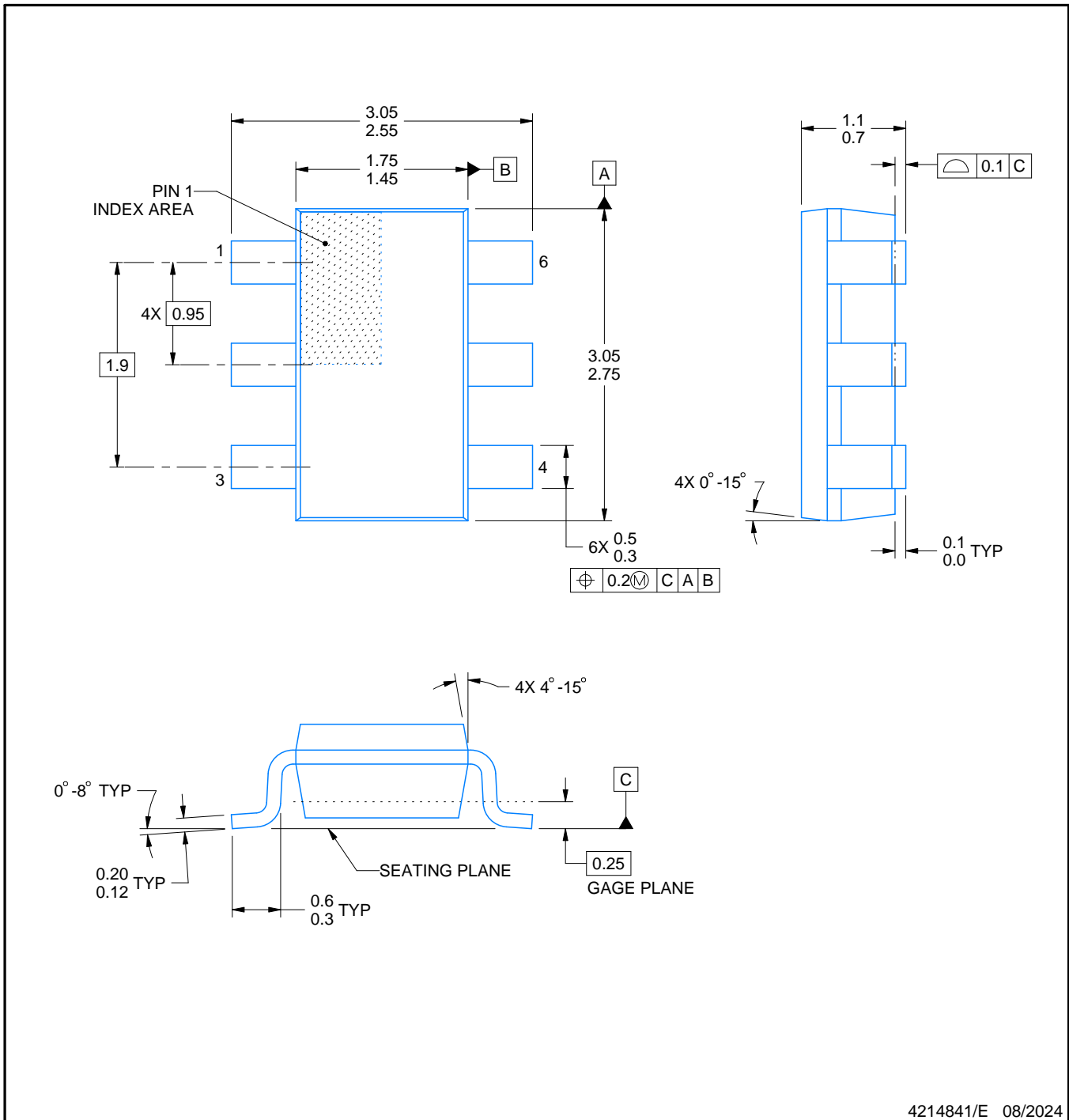
## TAPE AND REEL BOX DIMENSIONS



\*All dimensions are nominal

Device	Package Type	Package Drawing	Pins	SPQ	Length (mm)	Width (mm)	Height (mm)
TPS562200DDCR	SOT-23-THIN	DDC	6	3000	210.0	185.0	35.0
TPS562200DDCT	SOT-23-THIN	DDC	6	250	210.0	185.0	35.0
TPS563200DDCR	SOT-23-THIN	DDC	6	3000	210.0	185.0	35.0
TPS563200DDCT	SOT-23-THIN	DDC	6	250	210.0	185.0	35.0





4214841/E 08/2024

NOTES:

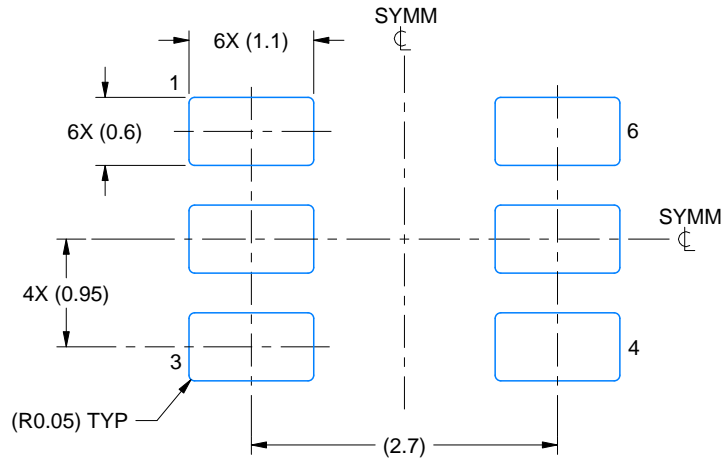
1. All linear dimensions are in millimeters. Any dimensions in parenthesis are for reference only. Dimensioning and tolerancing per ASME Y14.5M.
2. This drawing is subject to change without notice.
3. Reference JEDEC MO-193.

# EXAMPLE BOARD LAYOUT

DDC0006A

SOT-23 - 1.1 max height

SMALL OUTLINE TRANSISTOR



LAND PATTERN EXAMPLE  
EXPLODED METAL SHOWN  
SCALE:15X



SOLDEMASK DETAILS

4214841/E 08/2024

NOTES: (continued)

- 4. Publication IPC-7351 may have alternate designs.
- 5. Solder mask tolerances between and around signal pads can vary based on board fabrication site.

# EXAMPLE STENCIL DESIGN

DDC0006A

SOT-23 - 1.1 max height

SMALL OUTLINE TRANSISTOR



SOLDER PASTE EXAMPLE  
BASED ON 0.125 THICK STENCIL  
SCALE:15X

4214841/E 08/2024

NOTES: (continued)

6. Laser cutting apertures with trapezoidal walls and rounded corners may offer better paste release. IPC-7525 may have alternate design recommendations.
7. Board assembly site may have different recommendations for stencil design.

## IMPORTANT NOTICE AND DISCLAIMER

TI PROVIDES TECHNICAL AND RELIABILITY DATA (INCLUDING DATA SHEETS), DESIGN RESOURCES (INCLUDING REFERENCE DESIGNS), APPLICATION OR OTHER DESIGN ADVICE, WEB TOOLS, SAFETY INFORMATION, AND OTHER RESOURCES "AS IS" AND WITH ALL FAULTS, AND DISCLAIMS ALL WARRANTIES, EXPRESS AND IMPLIED, INCLUDING WITHOUT LIMITATION ANY IMPLIED WARRANTIES OF MERCHANTABILITY, FITNESS FOR A PARTICULAR PURPOSE OR NON-INFRINGEMENT OF THIRD PARTY INTELLECTUAL PROPERTY RIGHTS.

These resources are intended for skilled developers designing with TI products. You are solely responsible for (1) selecting the appropriate TI products for your application, (2) designing, validating and testing your application, and (3) ensuring your application meets applicable standards, and any other safety, security, regulatory or other requirements.

These resources are subject to change without notice. TI grants you permission to use these resources only for development of an application that uses the TI products described in the resource. Other reproduction and display of these resources is prohibited. No license is granted to any other TI intellectual property right or to any third party intellectual property right. TI disclaims responsibility for, and you will fully indemnify TI and its representatives against, any claims, damages, costs, losses, and liabilities arising out of your use of these resources.

TI's products are provided subject to [TI's Terms of Sale](#) or other applicable terms available either on [ti.com](https://www.ti.com) or provided in conjunction with such TI products. TI's provision of these resources does not expand or otherwise alter TI's applicable warranties or warranty disclaimers for TI products.

TI objects to and rejects any additional or different terms you may have proposed.

Mailing Address: Texas Instruments, Post Office Box 655303, Dallas, Texas 75265

Copyright © 2025, Texas Instruments Incorporated