

# TPS6209x 3-A High Efficiency Synchronous Step Down Converter with DCS-Control™

## 1 Features

- 2.5 V to 6 V Input Voltage Range
- DCS-Control™
- 95% Converter Efficiency
- Power Save Mode
- 20 µA Operating Quiescent Current
- 100% Duty Cycle for Lowest Dropout
- 2.8 MHz/1.4 MHz Typical Switching Frequency
- 0.8 V to  $V_{IN}$  Adjustable Output Voltage
- Fixed Output Voltage Versions
- Output Discharge Function
- Adjustable Softstart
- Hiccup Short Circuit Protection
- Output Voltage Tracking
- Pin-to-pin compatible with [TPS62095](#)

## 2 Applications

- Distributed Power Supplies
- Notebook, Netbook Computers
- Hard Disk Drivers (HDD)
- Solid State Drives (SSD)
- Processor Supply
- Battery Powered Applications

## 3 Description

The TPS6209x devices are a family of high frequency synchronous step down converters optimized for small solution size, high efficiency and suitable for battery powered applications. To maximize efficiency, the converters operate in pulse width modulation (PWM) mode with a nominal switching frequency of 2.8 MHz/1.4 MHz and automatically enter power save mode operation at light load currents. When used in distributed power supplies and point of load regulation, the devices allow voltage tracking to other voltage rails and tolerate output capacitors ranging from 10 µF up to 150 µF and beyond. Using the DCS-Control™ topology the devices achieve excellent load transient performance and accurate output voltage regulation.

The output voltage start-up ramp is controlled by the softstart pin, which allows operation as either a stand-alone power supply or in tracking configurations. Power sequencing is also possible by configuring the enable and power good pins. In power save mode, the devices operate at typically 20 µA quiescent current. Power save mode is entered automatically and seamlessly maintaining high efficiency over the entire load current range.

### Device Information<sup>(1)</sup>

DEVICE NAME	PACKAGE	BODY SIZE (NOM)
TPS62090	QFN (16)	3.00 mm x 3.00 mm
TPS62091		
TPS62092		
TPS62093		

(1) For all available packages, see the orderable addendum at the end of the data sheet.

Typical Application Schematic

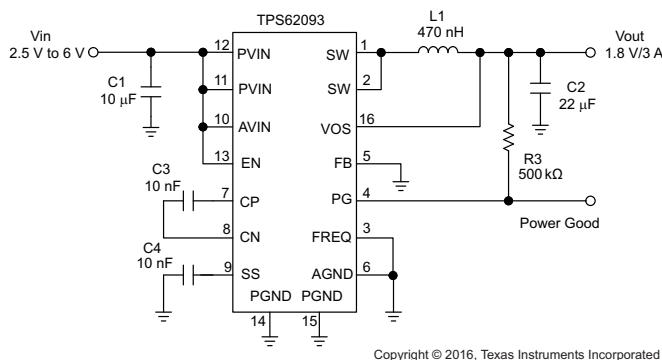

Copyright © 2016, Texas Instruments Incorporated

Efficiency vs Output Current

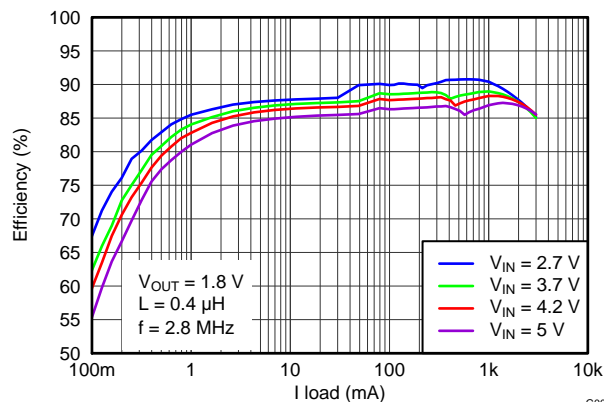

G004



## Table of Contents

<b>1 Features</b> .....	<b>1</b>	8.4 Device Functional Modes.....	<b>11</b>
<b>2 Applications</b> .....	<b>1</b>	<b>9 Application and Implementation</b> .....	<b>13</b>
<b>3 Description</b> .....	<b>1</b>	9.1 Application Information.....	<b>13</b>
<b>4 Revision History</b> .....	<b>2</b>	9.2 Typical Applications .....	<b>13</b>
<b>5 Device Comparison Table</b> .....	<b>3</b>	<b>10 Power Supply Recommendations</b> .....	<b>19</b>
<b>6 Pin Configuration and Functions</b> .....	<b>3</b>	<b>11 Layout</b> .....	<b>19</b>
<b>7 Specifications</b> .....	<b>4</b>	11.1 Layout Guideline .....	<b>19</b>
7.1 Absolute Maximum Ratings .....	<b>4</b>	11.2 Layout Example .....	<b>19</b>
7.2 ESD Ratings.....	<b>4</b>	<b>12 Device and Documentation Support</b> .....	<b>20</b>
7.3 Recommended Operating Conditions.....	<b>4</b>	12.1 Device Support .....	<b>20</b>
7.4 Thermal Information .....	<b>4</b>	12.2 Related Links .....	<b>20</b>
7.5 Electrical Characteristics.....	<b>5</b>	12.3 Receiving Notification of Documentation Updates	<b>20</b>
7.6 Typical Characteristics .....	<b>6</b>	12.4 Community Resources.....	<b>20</b>
<b>8 Detailed Description</b> .....	<b>7</b>	12.5 Trademarks .....	<b>20</b>
8.1 Overview .....	<b>7</b>	12.6 Electrostatic Discharge Caution.....	<b>20</b>
8.2 Functional Block Diagram .....	<b>8</b>	12.7 Glossary .....	<b>20</b>
8.3 Feature Description.....	<b>8</b>	<b>13 Mechanical, Packaging, and Orderable Information</b> .....	<b>21</b>

## 4 Revision History

NOTE: Page numbers for previous revisions may differ from page numbers in the current version.

### Changes from Revision B (April 2014) to Revision C

Page

• Changed Feature bullet text From "Two Level...." To "Hiccup..."; and, deleted "Wide Output Capacitance Selection" bullet .....	<b>1</b>
• Added CN and CP pin absolute maximum ratings .....	<b>4</b>
• Moved Storage Temp spec to the "Absolute Maximum Ratings" table .....	<b>4</b>
• Added Feedback voltage accuracy at $T_j = 25^\circ\text{C}$ .....	<b>5</b>
• Changed Legend in <a href="#">Figure 2</a> and <a href="#">Figure 4</a> to show correct voltages .....	<b>6</b>
• Updated <a href="#">Voltage Tracking (SS)</a> section .....	<b>9</b>
• Added <a href="#">Charge Pump (CP, CN)</a> section .....	<b>11</b>
• Updated PCB layout example .....	<b>19</b>
• Added <a href="#">Community Resources</a> section .....	<b>20</b>

### Changes from Revision A (March 2012) to Revision B

Page

• Changed the data sheet to meet the new TI standard Format .....	<b>1</b>
• Changed the Typical Characteristics. Moved graphs to the Application and Implementation section.....	<b>6</b>
• Added the Layout section .....	<b>19</b>

### Changes from Original (March 2012) to Revision A

Page

• Changed the FUNCTIONAL BLOCK DIAGRAM .....	<b>8</b>
• Changed R1 and R2 values in <a href="#">Figure 9</a> .....	<b>13</b>

## 5 Device Comparison Table

DEVICE NUMBER	OUTPUT VOLTAGE
TPS62090RGT	Adjustable
TPS62091RGT	3.3 V
TPS62092RGT	2.5 V
TPS62093RGT	1.8 V

## 6 Pin Configuration and Functions

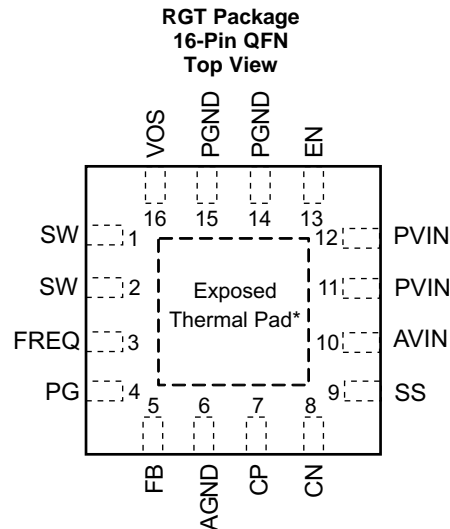

NOTE: \*The exposed thermal pad is connected to AGND.

### Pin Functions

PIN		I/O	DESCRIPTION
NO.	NAME		
1, 2	SW	I/O	Switch pin of the power stage.
3	FREQ	I	This pin selects the switching frequency of the device. FREQ = Low sets the typical switching frequency to 2.8 MHz. FREQ = High sets the typical switching frequency to 1.4 MHz. This pin has an active pull down resistor of typically 400 kΩ and can be left floating for 2.8 MHz operation.
4	PG	O	Power good open drain output. This pin is high impedance if the output voltage is within regulation. This pin is pulled low if the output is below its nominal value. The pull up resistor can not be connected to any voltage higher than the input voltage of the device.
5	FB	I	Feedback pin of the device. For the adjustable version, connect a resistor divider to set the output voltage. For the fixed output voltage versions this pin may be connected to GND for improved thermal performance and has a pull down resistor of typically 400 kΩ, which is active when EN is low.
6	AGND		Analog ground.
7	CP	I/O	Internal charge pump flying capacitor. Connect a 10 nF capacitor between CP and CN.
8	CN	I/O	Internal charge pump flying capacitor. Connect a 10 nF capacitor between CP and CN.
9	SS	I	Softstart control pin. A capacitor is connected to this pin and sets the softstart time. Leaving this pin floating sets the minimum start-up time.
10	AVIN	I	Bias supply input voltage pin.
11,12	PVIN	I	Power supply input voltage pin.
13	EN	I	Device enable. To enable the device this pin needs to be pulled high. Pulling this pin low disables the device. This pin has a pull down resistor of typically 400 kΩ, which is active when EN is low.
14,15	PGND		Power ground connection.
16	VOS	I	Output voltage sense pin. This pin needs to be connected to the output voltage.
Exposed Thermal Pad		–	The exposed thermal pad is connected to AGND. It must be soldered for mechanical reliability.

## 7 Specifications

### 7.1 Absolute Maximum Ratings<sup>(1)</sup>

Over operating free-air temperature range (unless otherwise noted)

		VALUE		UNIT
		MIN	MAX	
Voltage range <sup>(2)</sup>	PVIN, AVIN, FB, SS, EN, FREQ, VOS	-0.3	7	V
	SW, PG	-0.3	$V_{IN} + 0.3$	
	CN, CP	-0.3	$V_{IN} + 7.0$	
Power Good sink current	PG		1	mA
Operating junction temperature, $T_J$		-40	150	°C
Storage temperature, $T_{stg}$		-65	150	°C

- (1) Stresses beyond those listed under “absolute maximum ratings” may cause permanent damage to the device. These are stress ratings only and functional operation of the device at these or any other conditions beyond those indicated under “recommended operating conditions” is not implied. Exposure to absolute–maximum–rated conditions for extended periods may affect device reliability.
- (2) All voltage values are with respect to network ground pin.

### 7.2 ESD Ratings

			VALUE	UNIT
$V_{(ESD)}$	Electrostatic discharge	Human body model (HBM) per ANSI/ESDA/JEDEC JS-001, all pins <sup>(1)</sup>	±2000	V
		Charged device model (CDM), per JEDEC specification JESD22-C101, all pins <sup>(2)</sup>	±500	V

- (1) JEDEC document JEP155 states that 500-V HBM allows safe manufacturing with a standard ESD control process.
- (2) JEDEC document JEP157 states that 250-V CDM allows safe manufacturing with a standard ESD control process.

### 7.3 Recommended Operating Conditions<sup>(1)</sup>

		MIN	TYP	MAX	UNIT
$V_{IN}$	Input voltage range $V_{IN}$	2.5		6	V
$T_A$	Operating ambient temperature	-40		85	°C
$T_J$	Operating junction temperature	-40		125	°C

- (1) See the application section for further information

### 7.4 Thermal Information

THERMAL METRIC <sup>(1)</sup>		TPS6209x	UNIT
		QFN (16 PINS)	
$R_{\theta JA}$	Junction-to-ambient thermal resistance	47	°C/W
$R_{\theta Jctop}$	Junction-to-case (top) thermal resistance	60	°C/W
$R_{\theta JB}$	Junction-to-board thermal resistance	20	°C/W
$\Psi_{JT}$	Junction-to-top characterization parameter	1.5	°C/W
$\Psi_{JB}$	Junction-to-board characterization parameter	20	°C/W
$R_{\theta Jcbot}$	Junction-to-case (bottom) thermal resistance	5.3	°C/W

- (1) For more information about traditional and new thermal metrics, see the *Semiconductor and IC Package Thermal Metrics* application report ([SPRA953](#)).

## 7.5 Electrical Characteristics

 $V_{IN} = 3.6\text{ V}$ ,  $T_A = -40^\circ\text{C}$  to  $85^\circ\text{C}$ , typical values are at  $T_A = 25^\circ\text{C}$  (unless otherwise noted)

PARAMETER		TEST CONDITIONS	MIN	TYP	MAX	UNIT
<b>SUPPLY</b>						
$V_{IN}$	Input voltage range		2.5		6	V
$I_{QIN}$	Quiescent current	Not switching, FB = FB +5%, into PVIN and AVIN		20		$\mu\text{A}$
$I_{sd}$	Shutdown current	Into PVIN and AVIN		0.6	5	$\mu\text{A}$
UVLO	Undervoltage lockout threshold	$V_{IN}$ falling	2.1	2.2	2.3	V
	Undervoltage lockout hysteresis			200		mV
	Thermal shutdown	Temperature rising		150		$^\circ\text{C}$
	Thermal shutdown hysteresis			20		$^\circ\text{C}$
<b>Control SIGNALS EN, FREQ</b>						
$V_H$	High level input voltage	$V_{IN} = 2.5\text{ V}$ to $6\text{ V}$	1	0.65		V
$V_L$	Low level input voltage	$V_{IN} = 2.5\text{ V}$ to $6\text{ V}$		0.6	0.4	V
$I_{lkg}$	Input leakage current	EN, FREQ = GND or $V_{IN}$		10	100	nA
$R_{PD}$	Pull down resistance			400		k $\Omega$
<b>Softstart</b>						
$I_{SS}$	Softstart current		6.3	7.5	8.7	$\mu\text{A}$
<b>POWER GOOD</b>						
$V_{th}$	Power good threshold	Output voltage rising	93%	95%	97%	
		Output voltage falling	88%	90%	92%	
$V_L$	Low level voltage	$I_{(sink)} = 1\text{ mA}$			0.4	V
$I_{PG}$	PG sinking current				1	mA
$I_{lkg}$	Leakage current	$V_{PG} = 3.6\text{ V}$		10	100	nA
<b>POWER SWITCH</b>						
$R_{DS(on)}$	High side FET on-resistance	$I_{SW} = 500\text{ mA}$		50		m $\Omega$
	Low side FET on-resistance	$I_{SW} = 500\text{ mA}$		40		m $\Omega$
$I_{LIM}$	High side FET switch current limit		3.7	4.6	5.5	A
$f_s$	Switching frequency	FREQ = GND, $I_{OUT} = 3\text{ A}$		2.8		MHz
		FREQ = VIN, $I_{OUT} = 3\text{ A}$		1.4		MHz
<b>OUTPUT</b>						
$V_s$	Output voltage range		0.8		$V_{IN}$	V
$R_{od}$	Output discharge resistor	EN = GND, $V_{OUT} = 1.8\text{ V}$		200		$\Omega$
$V_{FB}$	Feedback regulation voltage			0.8		V
$V_{FB}$	Feedback voltage accuracy <sup>(1) (2)(3)</sup>	$V_{IN} \geq V_{OUT} + 1\text{ V}$ , TPS62090 adjustable output version $I_{OUT} = 1\text{ A}$ , PWM mode, $T_J = 25^\circ\text{C}$	-1%		+1%	
		$I_{OUT} = 1\text{ A}$ , PWM mode	-1.4%		+1.4%	
		$I_{OUT} = 0\text{ mA}$ , FREQ = 2.8 MHz, $V_{OUT} \geq 0.8\text{ V}$ , PFM mode	-1.4%		+3%	
		$I_{OUT} = 0\text{ mA}$ , FREQ = 1.4 MHz, $V_{OUT} \geq 1.2\text{ V}$ , PFM mode	-1.4%		+3%	
		$I_{OUT} = 0\text{ mA}$ , FREQ = 1.4 MHz, $V_{OUT} < 1.2\text{ V}$ , PFM mode	-1.4%		+3.7%	
$I_{FB}$	Feedback input bias current	$V_{FB} = 0.8\text{ V}$ , TPS62090 adjustable output version		10	100	nA
$V_{OUT}$	Output voltage accuracy <sup>(2)(3)</sup>	$V_{IN} \geq V_{OUT} + 1\text{ V}$ , fixed output voltage $I_{OUT} = 1\text{ A}$ , PWM mode	-1.4%		+1.4%	
		$I_{OUT} = 0\text{ mA}$ , FREQ = High and Low, PFM mode	-1.4%		+2.5%	
	Line regulation	$V_{OUT} = 1.8\text{ V}$ , PWM operation		0.016		%/V
	Load regulation	$V_{OUT} = 1.8\text{ V}$ , PWM operation		0.04		%/A

(1) For output voltages < 1.2 V, use a 2 x 22  $\mu\text{F}$  output capacitance to achieve +3% output voltage accuracy.

(2) Conditions:  $f = 2.8\text{ MHz}$ ,  $L = 0.47\text{ }\mu\text{H}$ ,  $C_{OUT} = 22\text{ }\mu\text{F}$  or  $f = 1.4\text{ MHz}$ ,  $L = 1\text{ }\mu\text{H}$ ,  $C_{OUT} = 22\text{ }\mu\text{F}$ .

(3) For more information, see the [Power Save Mode Operation](#) section of this data sheet.

## 7.6 Typical Characteristics

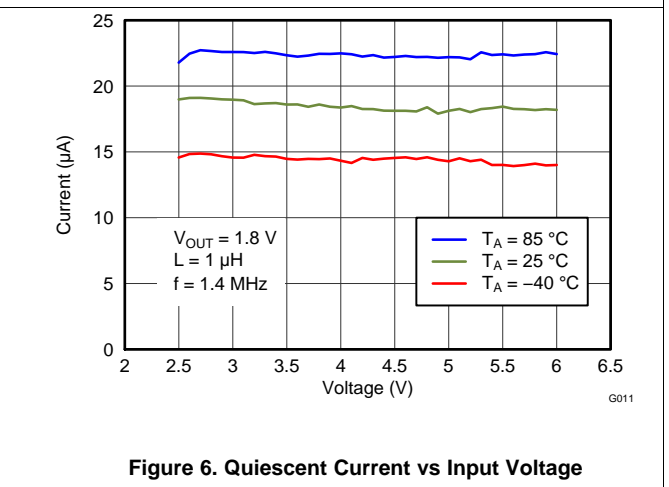
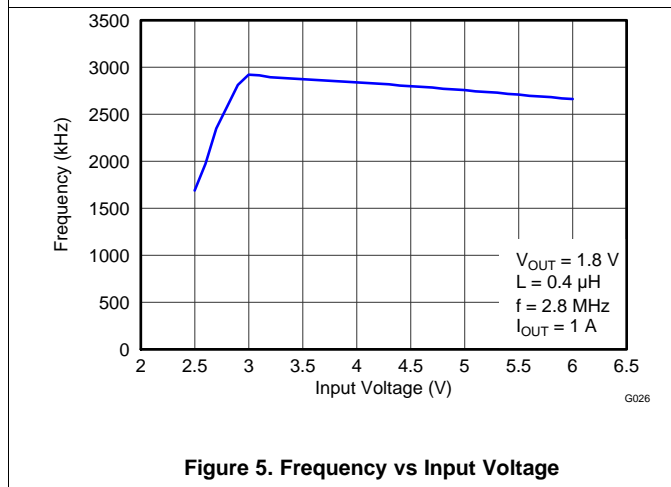
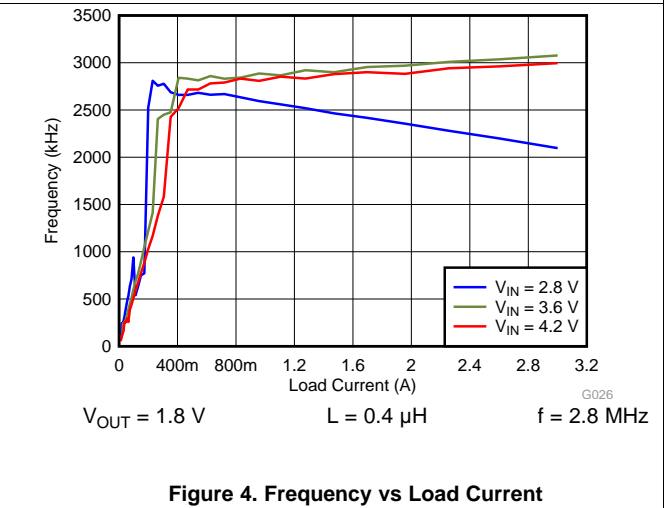
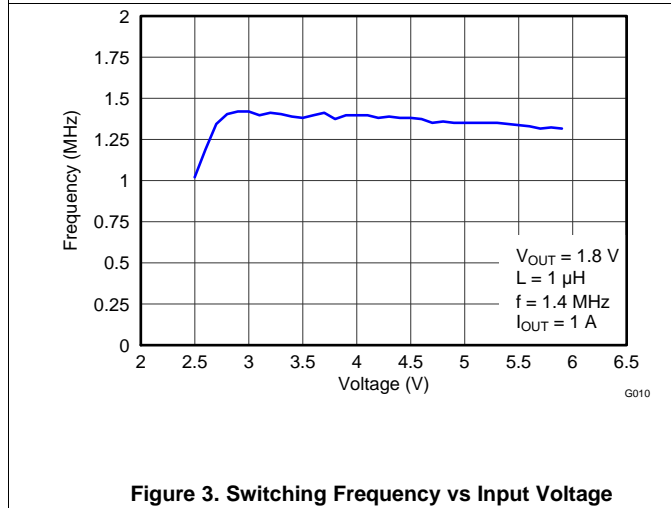
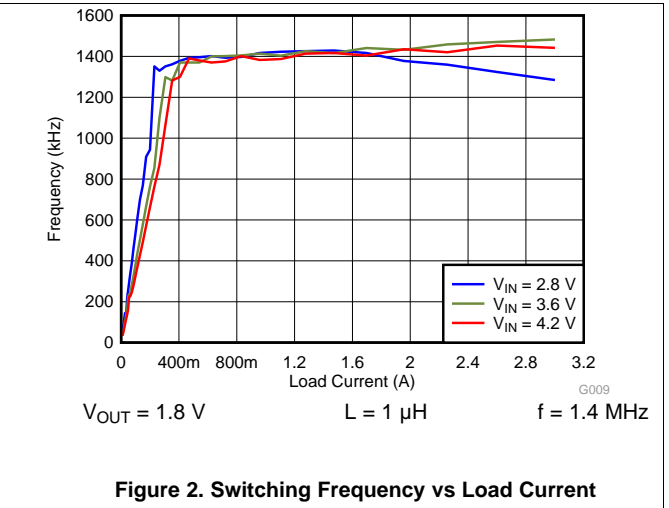
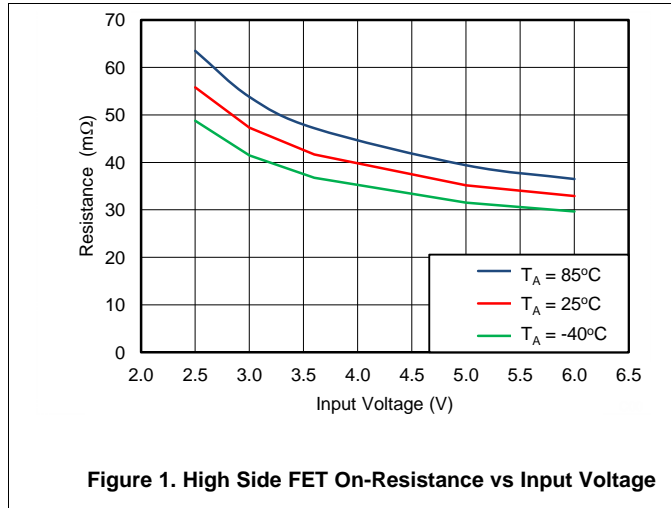

## 8 Detailed Description

### 8.1 Overview

The TPS6209x synchronous switched mode converters are based on DCS-Control™ (direct control with seamless transition into power save mode). This is an advanced regulation topology that combines the advantages of hysteretic and voltage mode control.

The DCS-Control™ topology operates in pulse width modulation (PWM) mode for medium to heavy load conditions and in power save mode at light load currents. In PWM, the converter operates with its nominal switching frequency of 2.8 MHz/1.4 MHz having a controlled frequency variation over the input voltage range. As the load current decreases, the converter enters power save mode, reducing the switching frequency and minimizing the IC quiescent current to achieve high efficiency over the entire load current range. DCS-Control™ supports both operation modes (PWM and PFM) using a single building block having a seamless transition from PWM to power save mode without effects on the output voltage. Fixed output voltage versions provide smallest solution size combined with lowest quiescent current. The TPS6209x family offers excellent DC voltage regulation and load transient regulation, combined with low output voltage ripple, minimizing interference with RF circuits.





## Feature Description (continued)

### 8.3.2 Softstart (SS) and Hiccup Current Limit During Startup

To minimize inrush current during start up, the device has an adjustable softstart depending on the capacitor value connected to the SS pin. The device charges the softstart capacitor with a constant current of typically 7.5  $\mu$ A. The feedback voltage follows this voltage with a fraction of 1.56 until the internal reference voltage of 0.8 V is reached. The softstart operation is completed once the voltage at the softstart capacitor has reached typically 1.25 V. The soft-start time can be calculated using [Equation 1](#). The larger the softstart capacitor the longer the softstart time. The relation between softstart voltage and feedback voltage can be estimated using [Equation 2](#).

$$t_{SS} = C_{SS} \times \frac{1.25V}{7.5\mu A} \quad (1)$$

$$V_{FB} = \frac{V_{SS}}{1.56} \quad (2)$$

During startup, the switch current limit is reduced to 1/3 (~1.5 A) of its typical current limit of 4.6 A. Once the output voltage exceeds typically 0.6 V, the current limit is released to its nominal value. The device provides a reduced load current of ~1.5 A when the output voltage is below typically 0.6 V. Due to this, a small or no softstart time may trigger the short circuit protection during startup especially for larger output capacitors. This is avoided by using a larger softstart capacitance to extend the softstart time. See [Short Circuit Protection \(Hiccup-Mode\)](#) for details of the reduced current limit during startup. Leaving the softstart pin floating sets the minimum start-up time (around 50 $\mu$ s).

### 8.3.3 Voltage Tracking (SS)

The SS pin is externally driven by another voltage source to achieve output voltage tracking. The application circuit is shown in [Figure 7](#). The internal reference voltage follows the voltage at the SS pin with a fraction of 1.56 until the internal reference voltage of 0.8 V is reached. The device achieves ratiometric or coincidental (simultaneous) output tracking, as shown in [Figure 8](#).

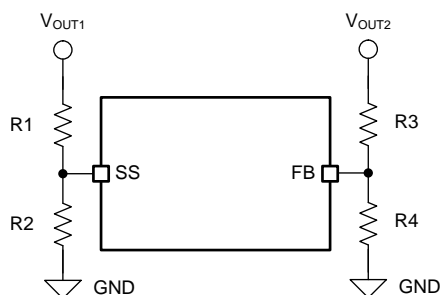

Copyright © 2017, Texas Instruments Incorporated

**Figure 7. Output Voltage Tracking**

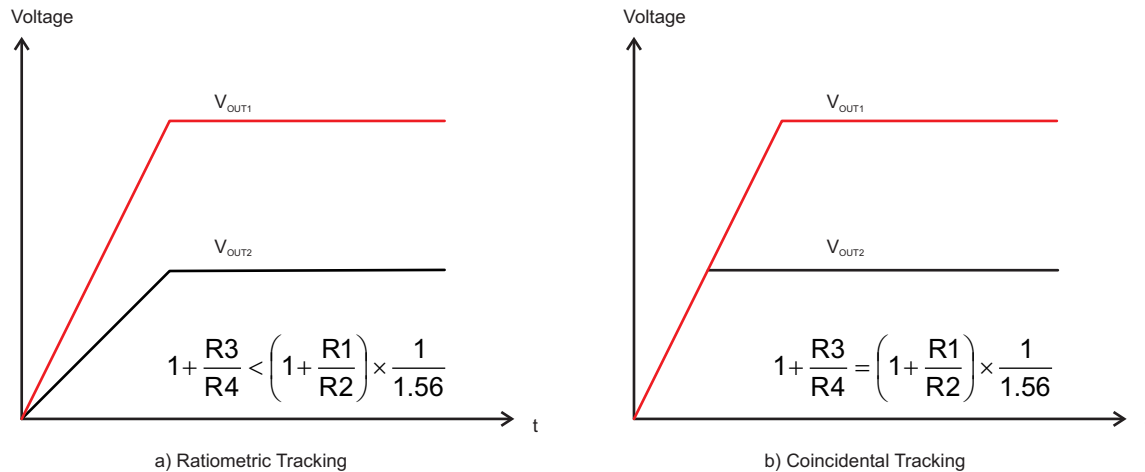
**Feature Description (continued)**

**Figure 8. Voltage Tracking Options**

The R2 value should be set properly to achieve accurate voltage tracking by taking 7.5  $\mu$ A soft startup current into account. 1 k $\Omega$  or smaller is a sufficient value for R2.

For decreasing the SS pin voltage, the device doesn't sink current from the output when the device is in power save mode. So the resulting decreases of the output voltage may be slower than the SS pin voltage if the load is light. When driving the SS pin with an external voltage, do not exceed the voltage rating of the SS pin which is 7 V.

**8.3.4 Short Circuit Protection (Hiccup-Mode)**

The device is protected against hard short circuits to GND and over-current events. This is implemented by a two level short circuit protection. During start-up and when the output is shorted to GND the switch current limit is reduced to 1/3 of its typical current limit of 4.6 A. Once the output voltage exceeds typically 0.6 V the current limit is released to its nominal value. The full current limit is implemented as a hiccup current limit. Once the internal current limit is triggered 32 times the device stops switching and starts a new start-up sequence after a typical delay time of 66  $\mu$ s passed by. The device will go through these cycles until the high current condition is released.

**8.3.5 Output Discharge Function**

To make sure the device starts up under defined conditions, the output gets discharged via the VOS pin with a typical discharge resistor of 200  $\Omega$  whenever the device shuts down. This happens when the device is disabled or if thermal shutdown, undervoltage lockout or short circuit hiccup-mode is triggered.

**8.3.6 Power Good Output (PG)**

The power good output is low when the output voltage is below its nominal value. The power good becomes high impedance once the output is within 5% of regulation. The PG pin is an open drain output and is specified to typically sink up to 1 mA. This output requires a pull-up resistor to be monitored properly. The pull-up resistor cannot be connected to any voltage higher than the input voltage of the device. The PG output is low when the device is disabled, in thermal shutdown or UVLO. The PG output can be left floating if unused.

## Feature Description (continued)

### 8.3.7 Frequency Set Pin (FREQ)

The FREQ pin is a digital logic input which sets the nominal switching frequency. Pulling this pin to GND sets the nominal switching frequency to 2.8 MHz and pulling this pin high sets the nominal switching frequency to 1.4 MHz. Since this pin changes the switching frequency it also changes the on-time during pulse frequency modulation (PFM) mode. At 1.4 MHz the on-time is twice the on-time as operating at 2.8 MHz. This pin has an active pull-down resistor of typically 400 kΩ. For applications where efficiency is of highest importance, a lower switching frequency should be selected. A higher switching frequency allows the use of smaller external components, faster load transient response and lower output voltage ripple when using same L-C values.

### 8.3.8 Undervoltage Lockout (UVLO)

To avoid mis-operation of the device at low input voltages, an undervoltage lockout is included. UVLO shuts down the device at input voltages lower than typically 2.2 V with a 200 mV hysteresis.

### 8.3.9 Thermal Shutdown

The device goes into thermal shutdown once the junction temperature exceeds typically 150°C with a 20°C hysteresis.

### 8.3.10 Charge Pump (CP, CN)

The CP and CN pins must attach to an external 10 nF capacitor to complete a charge pump for the gate driver. This capacitor must be rated for the input voltage. It is not recommended to connect any other circuits to the CP or CN pins.

## 8.4 Device Functional Modes

### 8.4.1 Pulse Width Modulation Operation

At medium to heavy load currents, the device operates with pulse width modulation (PWM) at a nominal switching frequency of 2.8 MHz or 1.4 MHz depending on the setting of the FREQ pin. As the load current decreases, the converter enters the power save mode operation reducing its switching frequency. The device enters power save mode at the boundary to discontinuous conduction mode (DCM).

### 8.4.2 Power Save Mode Operation

As the load current decreases, the converter enters power save mode operation. During power save mode, the converter operates with reduced switching frequency maintaining high efficiency. The power save mode is based on a fixed on-time architecture following Equation 3. When operating at 1.4 MHz the on-time is twice as long as the on-time for 2.8 MHz operation. This results in larger output voltage ripple, as shown in Figure 19 and Figure 20, and slightly higher output voltage at no load, as shown in Figure 16 and Figure 17. To have the same output voltage ripple at 1.4 MHz during PFM mode, either the output capacitor or the inductor value needs to be increased. As an example, operating at 2.8 MHz using 0.47 μH inductor gives the same output voltage ripple as operating with 1.4 MHz using 1 μH inductor.

$$\begin{aligned}
 t_{on_{2.8\text{MHz}}} &= \frac{V_{\text{OUT}}}{V_{\text{IN}}} \times 360\text{ns} \\
 t_{on_{1.4\text{MHz}}} &= \frac{V_{\text{OUT}}}{V_{\text{IN}}} \times 360\text{ns} \times 2 \\
 f &= \frac{2 \times I_{\text{OUT}}}{t_{on}^2 \left( 1 + \frac{V_{\text{IN}} - V_{\text{OUT}}}{V_{\text{OUT}}} \right) \times \frac{V_{\text{IN}} - V_{\text{OUT}}}{L}}
 \end{aligned} \tag{3}$$

In power save mode the output voltage rises slightly above the nominal output voltage in PWM mode, as shown in Figure 16 and Figure 17. This effect can be reduced by increasing the output capacitance or the inductor value. This effect can also be reduced by programming the output voltage of the TPS62090 lower than the target value. As an example, if the target output voltage is 3.3 V, then the TPS62090 can be programmed to 3.3 V – 0.8%. As a result the output voltage accuracy is now -2.2% to +2.2% instead of -1.4% to 3%. The output voltage accuracy in PFM operation is reflected in the electrical specification table and given for a 22 μF output capacitor.

## Device Functional Modes (continued)

### 8.4.3 Low Dropout Operation (100% Duty Cycle)

The device offers low input to output voltage difference by entering 100% duty cycle mode. In this mode the high side MOSFET switch is constantly turned on. This is particularly useful in battery powered applications to achieve longest operation time by taking full advantage of the whole battery voltage range. The minimum input voltage where the output voltage falls below its nominal regulation value is given by:

$$V_{IN(min)} = V_{OUT} + I_{OUT} \times (R_{DS(on)} + R_L) \quad (4)$$

Where:

$R_{DS(on)}$  = High side FET on-resistance

$R_L$  = DC resistance of the inductor

## 9 Application and Implementation

### NOTE

Information in the following applications sections is not part of the TI component specification, and TI does not warrant its accuracy or completeness. TI's customers are responsible for determining suitability of components for their purposes. Customers should validate and test their design implementation to confirm system functionality.

### 9.1 Application Information

The TPS6209x 3 A family of devices, are high frequency synchronous step down converters optimized for small solution size, high efficiency and suitable for battery powered applications.

### 9.2 Typical Applications

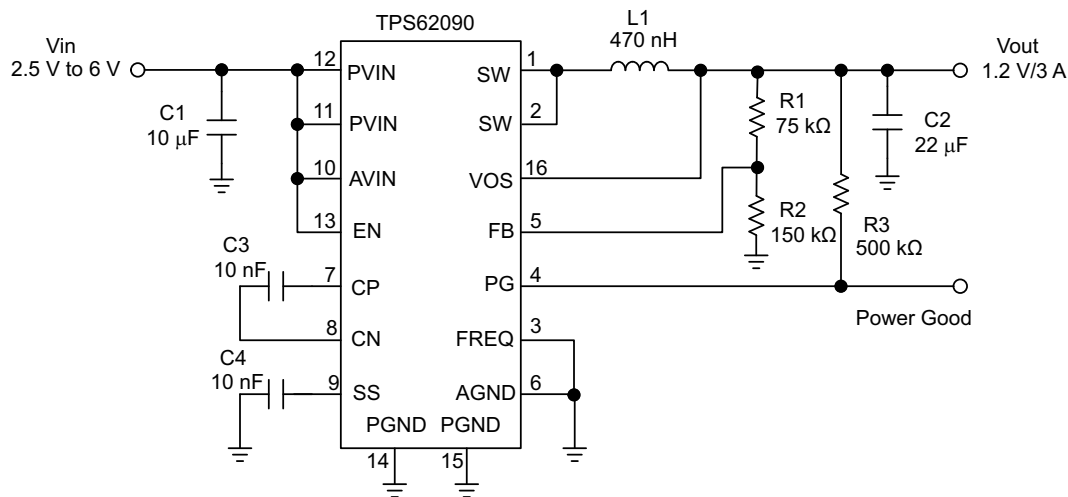

Copyright © 2016, Texas Instruments Incorporated

Figure 9. 1.2 V Adjustable Version Operating at 2.8 MHz

#### 9.2.1 Design Requirements

The design guideline provides a component selection to operate the device within the recommended operating conditions.

The design can be optimized for highest efficiency or smallest solution size and lowest output voltage ripple. For highest efficiency set the device switching frequency to 1.4 MHz (FREQ = High) and select the output filter components according to Table 3. For smallest solution size and lowest output voltage ripple set the device switching frequency to 2.8 MHz (FREQ = Low) and select the output filter components according to Table 2. For the fixed output voltage option the feedback pin needs to be connected to GND.

Table 1 shows the list of components for the *Application Curves*.

Table 1. List of Components

REFERENCE	DESCRIPTION	MANUFACTURER
TPS62090	High efficiency step down converter	Texas Instruments
L1	Inductor: 1µH, 0.47µH, 0.4µH	Coilcraft XFL4020-102, TOKO DEF252012C-R47, Coilcraft XAL4020-401
C1	Ceramic capacitor: 10µF, 22µF	(6.3V, X5R, 0603), (6.3V, X5R, 0805)
C2	Ceramic capacitor: 22µF	(6.3V, X5R, 0805)
C3, C4	Ceramic capacitor	Standard
R1, R2, R3	Resistor	Standard

## 9.2.2 Detailed Design Procedure

The first step is the selection of the output filter components. To simplify this process, [Table 2](#) and [Table 3](#) outline possible inductor and capacitor value combinations. Checked cells represent combinations that are proven for stability by simulation and lab. Further combinations should be checked for each individual application.

**Table 2. Output Filter Selection (2.8 MHz Operation, FREQ = GND)**

INDUCTOR VALUE [ $\mu\text{H}$ ] <sup>(1)</sup>	OUTPUT CAPACITOR VALUE [ $\mu\text{F}$ ] <sup>(2)</sup>				
	10	22	47	100	150
0.47		√ <sup>(3)</sup>	√	√	√
1.0	√	√	√	√	√
2.2					
3.3					

- (1) Inductor tolerance and current de-rating is anticipated. The effective inductance can vary by +20% and -30%.
- (2) Capacitance tolerance and bias voltage de-rating is anticipated. The effective capacitance can vary by +20% and -50%.
- (3) Typical application configuration. Other check mark indicates alternative filter combinations

**Table 3. Output Filter Selection (1.4 MHz Operation, FREQ =  $V_{\text{IN}}$ )**

INDUCTOR VALUE [ $\mu\text{H}$ ] <sup>(1)</sup>	OUTPUT CAPACITOR VALUE [ $\mu\text{F}$ ] <sup>(2)</sup>				
	10	22	47	100	150
0.47		√	√	√	√
1.0	√	√ <sup>(3)</sup>	√	√	√
2.2	√	√	√	√	√
3.3					

- (1) Inductor tolerance and current de-rating is anticipated. The effective inductance can vary by +20% and -30%.
- (2) Capacitance tolerance and bias voltage de-rating is anticipated. The effective capacitance can vary by +20% and -50%.
- (3) Typical application configuration. Other check mark indicates alternative filter combinations

### 9.2.2.1 Inductor Selection

The inductor selection is affected by several parameter like inductor ripple current, output voltage ripple, transition point into power save mode, and efficiency. See [Table 4](#) for typical inductors.

**Table 4. Inductor Selection**

INDUCTOR VALUE	COMPONENT SUPPLIER <sup>(1)</sup>	SIZE (LxWxH mm)	I <sub>sat</sub> /DCR
0.6 $\mu\text{H}$	Coilcraft XAL4012-601	4 x 4 x 2.1	7.1 A/9.5 m $\Omega$
1 $\mu\text{H}$	Coilcraft XAL4020-102	4 x 4 x 2.1	5.9 A/13.2 m $\Omega$
1 $\mu\text{H}$	Coilcraft XFL4020-102	4 x 4 x 2.1	5.1 A/10.8 m $\Omega$
0.47 $\mu\text{H}$	TOKO DFE252012 R47	2.5 x 2 x 1.2	3.7 A/39 m $\Omega$
1 $\mu\text{H}$	TOKO DFE252012 1R0	2.5 x 2 x 1.2	3.0 A/59 m $\Omega$
0.68 $\mu\text{H}$	TOKO DFE322512 R68	3.2 x 2.5 x 1.2	3.5 A/37 m $\Omega$
1 $\mu\text{H}$	TOKO DFE322512 1R0	3.2 x 2.5 x 1.2	3.1 A/45 m $\Omega$

(1) See [Third-Party Products Disclaimer](#)

In addition, the inductor has to be rated for the appropriate saturation current and DC resistance (DCR). [Equation 6](#) calculates the maximum inductor current under static load conditions. The formula takes the converter efficiency into account. The converter efficiency can be taken from the data sheet graph's or 80% can be used as a conservative approach. The calculation must be done for the maximum input voltage where the peak switch current is highest.

$$\Delta I_L = \frac{V_{OUT}}{\eta} \times \frac{\left(1 - \frac{V_{OUT}}{V_{IN} \times \eta}\right)}{f \times L} \quad (5)$$

$$I_{PEAK} = I_{OUT} + \frac{\Delta I_L}{2}$$

where:

- $f$  = Converter switching frequency (typical 2.8 MHz or 1.4 MHz)
  - $L$  = Selected inductor value
  - $\eta$  = Estimated converter efficiency (use the number from the efficiency curves or 0.80 as a conservative assumption)
- (6)

**Note:** The calculation must be done for the maximum input voltage of the application

Calculating the maximum inductor current using the actual operating conditions gives the minimum saturation current. A margin of 20% needs to be added to cover for load transients during operation.

### 9.2.2.2 Input and Output Capacitor Selection

For best output and input voltage filtering, low ESR (X5R or X7R) ceramic capacitors are recommended. The input capacitor minimizes input voltage ripple, suppresses input voltage spikes and provides a stable system rail for the device. A 10- $\mu$ F or larger input capacitor is recommended when FREQ = Low and a 22- $\mu$ F or larger when FREQ = High.

The output capacitor value can range from 10  $\mu$ F up to 150  $\mu$ F and beyond. Load transient testing and measuring the bode plot are good ways to verify stability with larger capacitor values. The recommended typical output capacitor value is 22  $\mu$ F (nominal) and can vary over a wide range as outline in the output filter selection table. For output voltages above 1.8 V, noise can cause duty cycle jitter. This does not degrade device performance. Using an output capacitor of 2 x 22  $\mu$ F (nominal) for output voltages >1.8 V avoids duty cycle jitter.

Ceramic capacitor have a DC-Bias effect, which has a strong influence on the final effective capacitance. Choose the right capacitor carefully in combination with considering its package size and voltage rating.

### 9.2.2.3 Setting the Output Voltage

The output voltage is set by an external resistor divider according to the following equations:

$$V_{OUT} = V_{FB} \times \left(1 + \frac{R1}{R2}\right) = 0.8 \text{ V} \times \left(1 + \frac{R1}{R2}\right) \quad (7)$$

$$R2 = \frac{V_{FB}}{I_{FB}} = \frac{0.8 \text{ V}}{5 \mu\text{A}} \approx 160 \text{ k}\Omega \quad (8)$$

$$R1 = R2 \times \left(\frac{V_{OUT}}{V_{FB}} - 1\right) = R2 \times \left(\frac{V_{OUT}}{0.8\text{V}} - 1\right) \quad (9)$$

When sizing R2, in order to achieve low quiescent current and acceptable noise sensitivity, use a minimum of 5  $\mu$ A for the feedback current  $I_{FB}$ . Larger currents through R2 improve noise sensitivity and output voltage accuracy. Lowest current consumption and best output voltage accuracy can be achieved with the fixed output voltage versions. For the fixed output voltage versions, the FB pin can be left floating or connected to GND to improve the thermal performance. A feed forward capacitor is not required for proper operation.

9.2.2.4 Application Curves

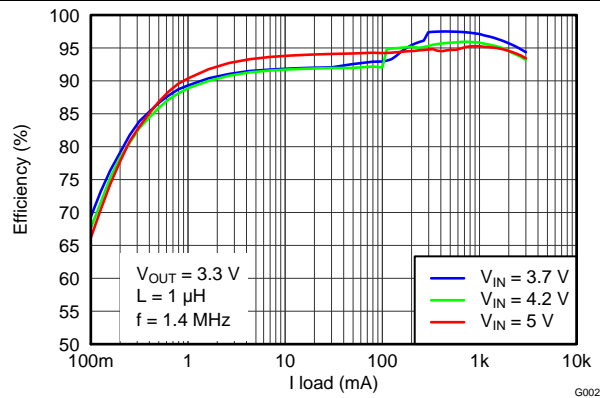

Figure 10. Efficiency vs Load Current

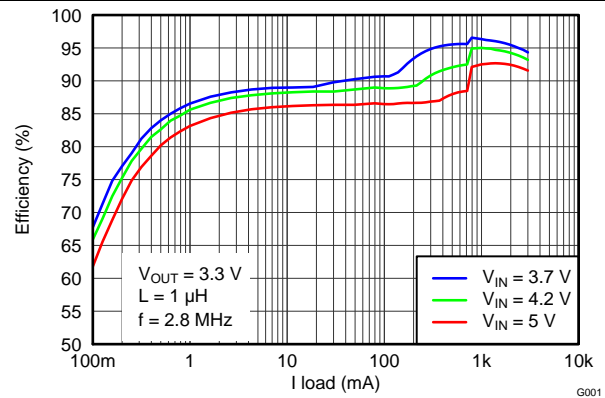

Figure 11. Efficiency vs Load Current

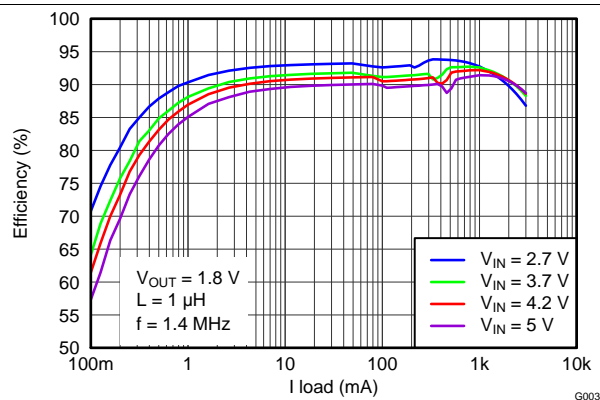

Figure 12. Efficiency vs Load Current

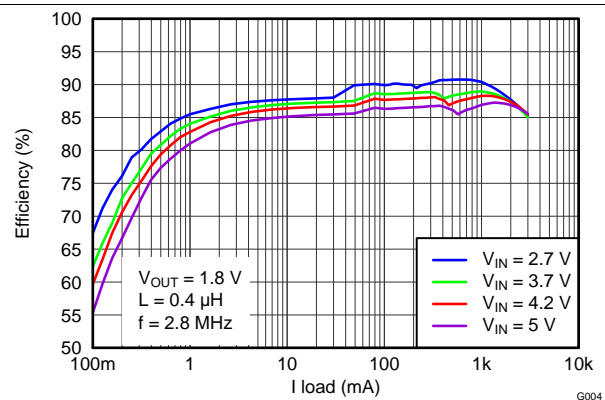

Figure 13. Efficiency vs Load Current

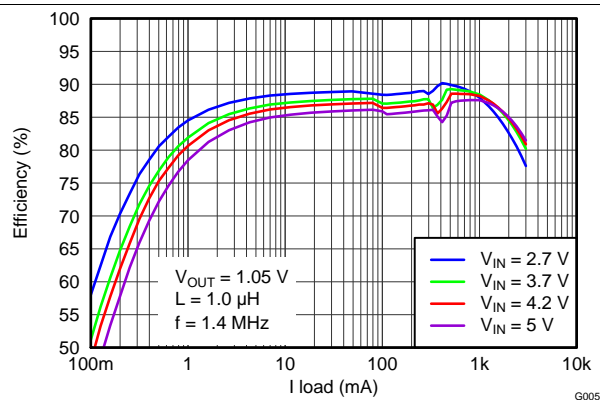

Figure 14. Efficiency vs Load Current

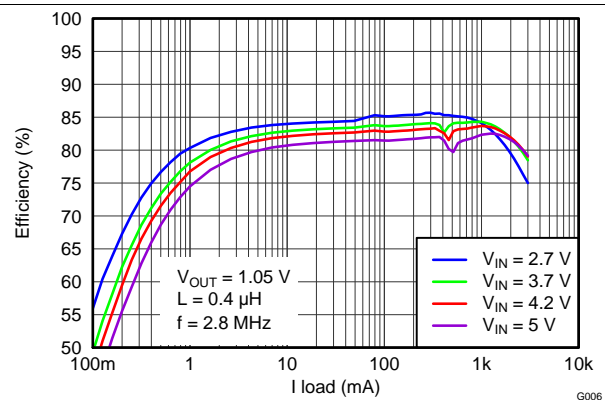

Figure 15. Efficiency vs Load Current



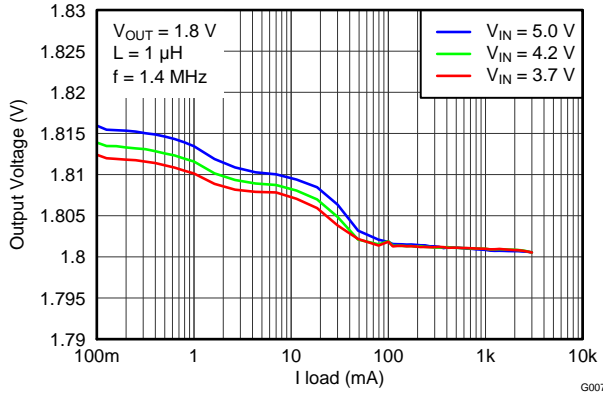

Figure 16. Output Voltage vs Load Current

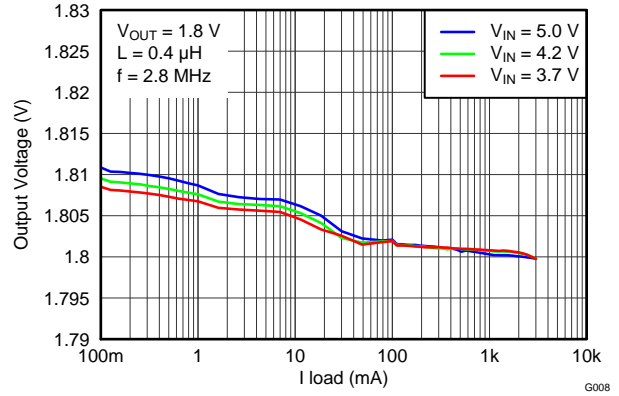

Figure 17. Output Voltage vs Load Current

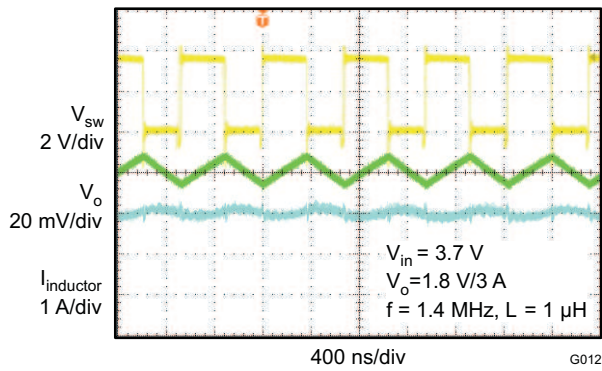

Figure 18. PWM Operation

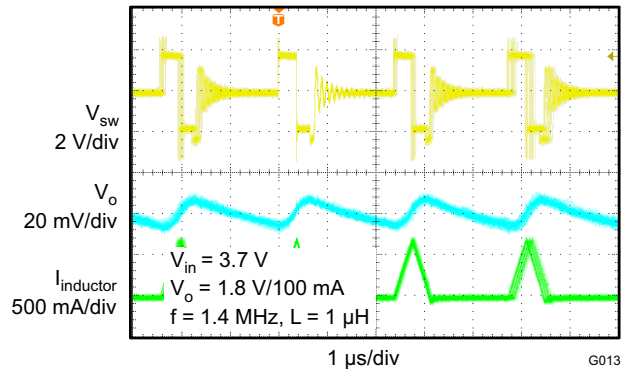

Figure 19. PFM Operation

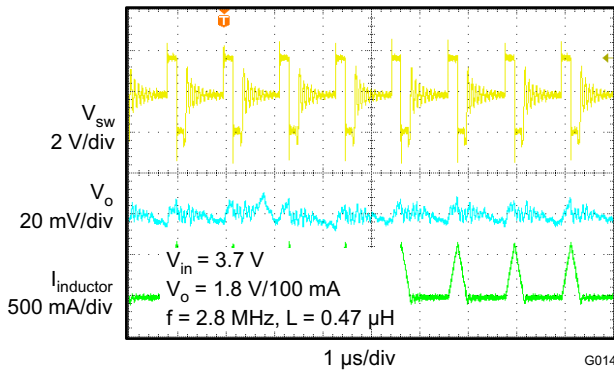

Figure 20. PFM Operation

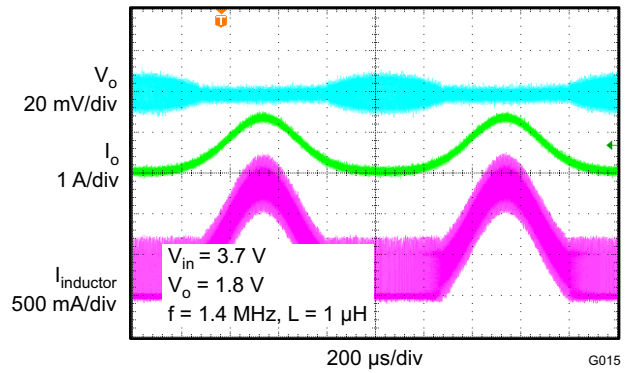

Figure 21. Load Sweep

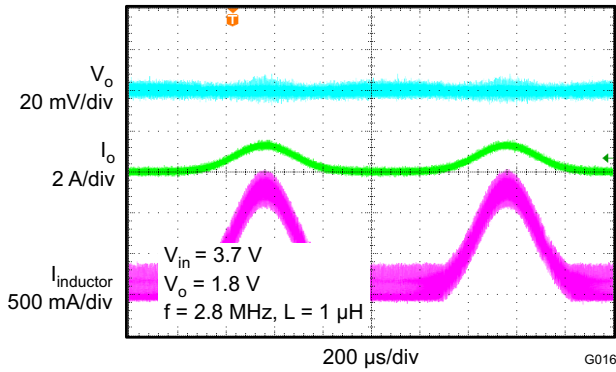

Figure 22. Load Sweep

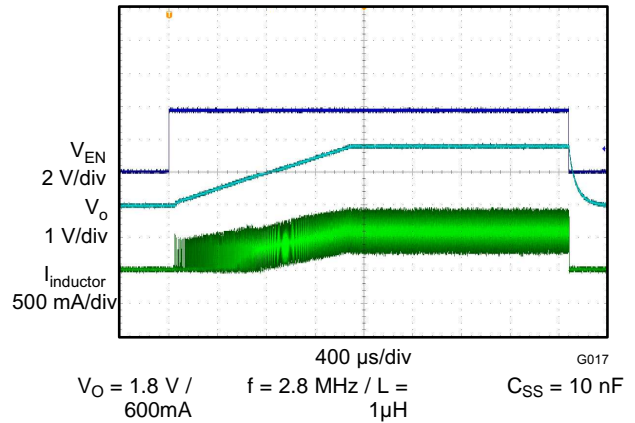

Figure 23. Start-Up

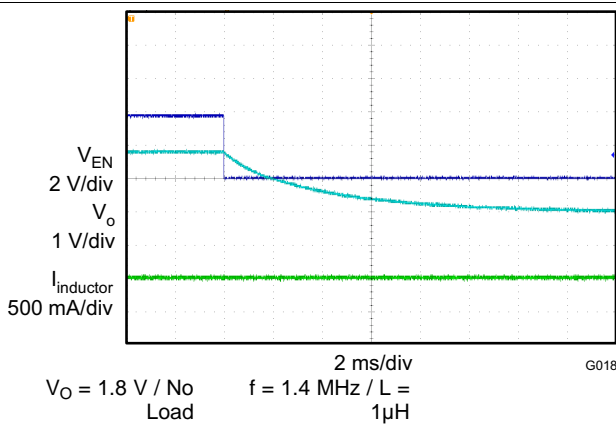

Figure 24. Shutdown

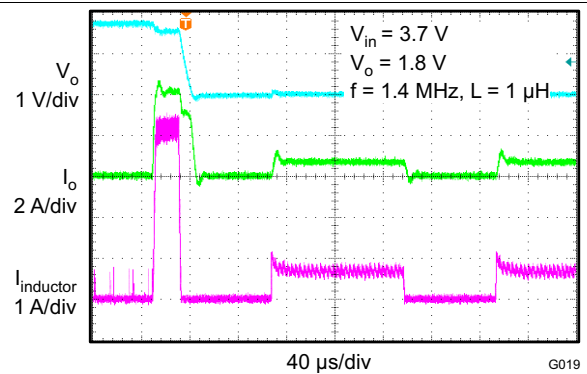

Figure 25. Hiccup Short Circuit Protection

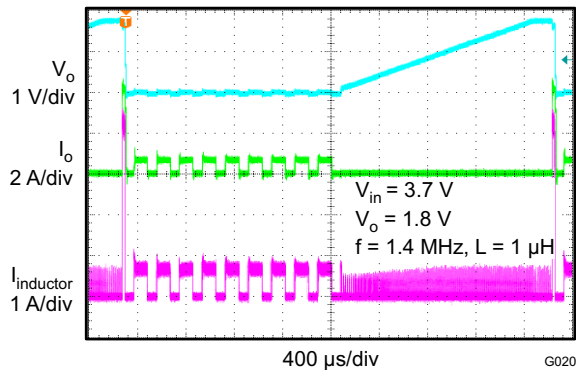

Figure 26. Hiccup Short Circuit Protection

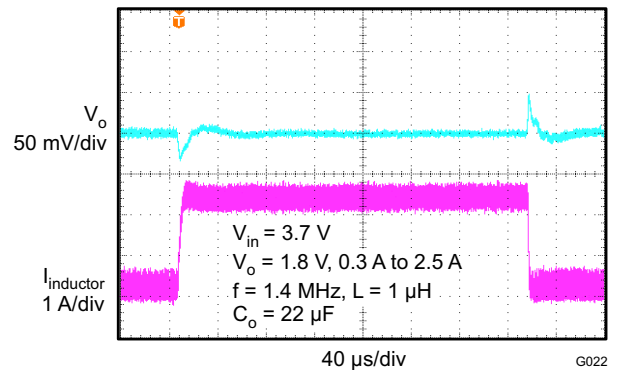

Figure 27. Load Transient Response

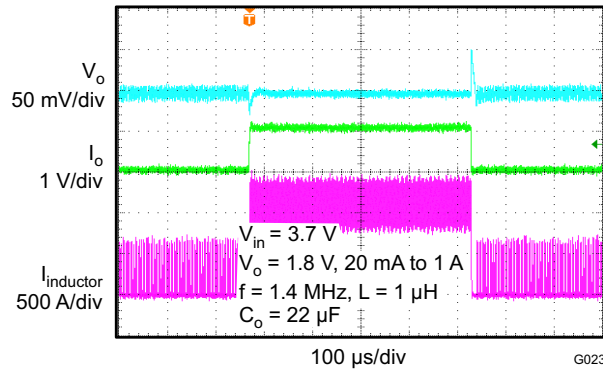

Figure 28. Load Transient Response

## 10 Power Supply Recommendations

The power supply to the TPS62090 needs to have a current rating according to the supply voltage, output voltage and output current of the TPS62090.

## 11 Layout

### 11.1 Layout Guideline

- It is recommended to place the input capacitor as close as possible to the IC pins PVIN and PGND.
- The VOS connection is noise sensitive and needs to be routed as short and directly to the output pin of the inductor.
- The exposed thermal pad of the package, analog ground (pin 6) and power ground (pin 14, 15) should have a single joint connection at the exposed thermal pad of the package. This minimizes switch node jitter.
- The charge pump capacitor connected to CP and CN should be placed close to the IC to minimize coupling of switching waveforms into other traces and circuits.
- Refer to [Figure 29](#) and the evaluation module User Guide ([SLVU670](#)) for an example of component placement, routing and thermal design.

### 11.2 Layout Example

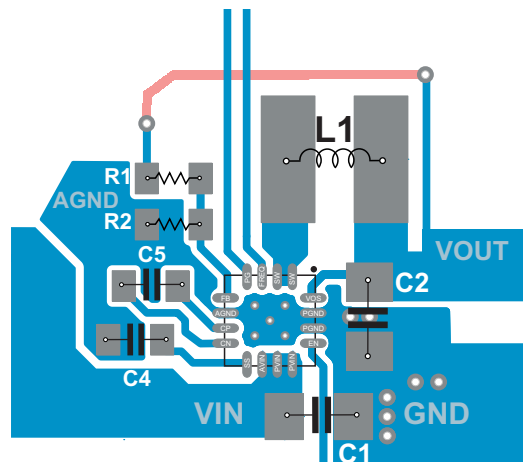

Figure 29. TPS6209x Layout

## 12 Device and Documentation Support

### 12.1 Device Support

#### 12.1.1 Third-Party Products Disclaimer

TI'S PUBLICATION OF INFORMATION REGARDING THIRD-PARTY PRODUCTS OR SERVICES DOES NOT CONSTITUTE AN ENDORSEMENT REGARDING THE SUITABILITY OF SUCH PRODUCTS OR SERVICES OR A WARRANTY, REPRESENTATION OR ENDORSEMENT OF SUCH PRODUCTS OR SERVICES, EITHER ALONE OR IN COMBINATION WITH ANY TI PRODUCT OR SERVICE.

### 12.2 Related Links

The table below lists quick access links. Categories include technical documents, support and community resources, tools and software, and quick access to sample or buy.

**Table 5. Related Links**

PARTS	PRODUCT FOLDER	SAMPLE & BUY	TECHNICAL DOCUMENTS	TOOLS & SOFTWARE	SUPPORT & COMMUNITY
TPS62090	<a href="#">Click here</a>	<a href="#">Click here</a>	<a href="#">Click here</a>	<a href="#">Click here</a>	<a href="#">Click here</a>
TPS62091	<a href="#">Click here</a>	<a href="#">Click here</a>	<a href="#">Click here</a>	<a href="#">Click here</a>	<a href="#">Click here</a>
TPS62092	<a href="#">Click here</a>	<a href="#">Click here</a>	<a href="#">Click here</a>	<a href="#">Click here</a>	<a href="#">Click here</a>
TPS62093	<a href="#">Click here</a>	<a href="#">Click here</a>	<a href="#">Click here</a>	<a href="#">Click here</a>	<a href="#">Click here</a>

### 12.3 Receiving Notification of Documentation Updates

To receive notification of documentation updates, navigate to the device product folder on ti.com. In the upper right corner, click on *Alert me* to register and receive a weekly digest of any product information that has changed. For change details, review the revision history included in any revised document.

### 12.4 Community Resources

The following links connect to TI community resources. Linked contents are provided "AS IS" by the respective contributors. They do not constitute TI specifications and do not necessarily reflect TI's views; see TI's [Terms of Use](#).

**TI E2E™ Online Community** *TI's Engineer-to-Engineer (E2E) Community*. Created to foster collaboration among engineers. At [e2e.ti.com](http://e2e.ti.com), you can ask questions, share knowledge, explore ideas and help solve problems with fellow engineers.

**Design Support** *TI's Design Support* Quickly find helpful E2E forums along with design support tools and contact information for technical support.

### 12.5 Trademarks

DCS-Control, E2E are trademarks of Texas Instruments.  
All other trademarks are the property of their respective owners.

### 12.6 Electrostatic Discharge Caution



These devices have limited built-in ESD protection. The leads should be shorted together or the device placed in conductive foam during storage or handling to prevent electrostatic damage to the MOS gates.

### 12.7 Glossary

**SLYZ022** — *TI Glossary*.

This glossary lists and explains terms, acronyms, and definitions.

## 13 Mechanical, Packaging, and Orderable Information

The following pages include mechanical, packaging, and orderable information. This information is the most current data available for the designated devices. This data is subject to change without notice and revision of this document. For browser-based versions of this data sheet, refer to the left-hand navigation.

**PACKAGING INFORMATION**

Orderable part number	Status (1)	Material type (2)	Package   Pins	Package qty   Carrier	RoHS (3)	Lead finish/ Ball material (4)	MSL rating/ Peak reflow (5)	Op temp (°C)	Part marking (6)
<a href="#">TPS62090RGTR</a>	Active	Production	VQFN (RGT)   16	3000   LARGE T&R	Yes	NIPDAU	Level-2-260C-1 YEAR	-40 to 85	SBW
TPS62090RGTR.Z	Active	Production	VQFN (RGT)   16	3000   LARGE T&R	Yes	NIPDAU	Level-2-260C-1 YEAR	-40 to 85	SBW
<a href="#">TPS62090RGTT</a>	Active	Production	VQFN (RGT)   16	250   SMALL T&R	Yes	NIPDAU	Level-2-260C-1 YEAR	-40 to 85	SBW
TPS62090RGTT.Z	Active	Production	VQFN (RGT)   16	250   SMALL T&R	Yes	NIPDAU	Level-2-260C-1 YEAR	-40 to 85	SBW
TPS62090RGTTG4.Z	Active	Production	VQFN (RGT)   16	250   SMALL T&R	Yes	NIPDAU	Level-2-260C-1 YEAR	-40 to 85	SBW
<a href="#">TPS62091RGTR</a>	Active	Production	VQFN (RGT)   16	3000   LARGE T&R	Yes	NIPDAU	Level-2-260C-1 YEAR	-40 to 85	SBX
TPS62091RGTR.Z	Active	Production	VQFN (RGT)   16	3000   LARGE T&R	Yes	NIPDAU	Level-2-260C-1 YEAR	-40 to 85	SBX
TPS62091RGTRG4.Z	Active	Production	VQFN (RGT)   16	3000   LARGE T&R	Yes	NIPDAU	Level-2-260C-1 YEAR	-40 to 85	SBX
<a href="#">TPS62091RGTT</a>	Active	Production	VQFN (RGT)   16	250   SMALL T&R	Yes	NIPDAU	Level-2-260C-1 YEAR	-40 to 85	SBX
TPS62091RGTT.Z	Active	Production	VQFN (RGT)   16	250   SMALL T&R	Yes	NIPDAU	Level-2-260C-1 YEAR	-40 to 85	SBX
<a href="#">TPS62092RGTR</a>	Active	Production	VQFN (RGT)   16	3000   LARGE T&R	Yes	NIPDAU	Level-2-260C-1 YEAR	-40 to 85	SBY
TPS62092RGTR.Z	Active	Production	VQFN (RGT)   16	3000   LARGE T&R	Yes	NIPDAU	Level-2-260C-1 YEAR	-40 to 85	SBY
<a href="#">TPS62092RGTT</a>	Active	Production	VQFN (RGT)   16	250   SMALL T&R	Yes	NIPDAU	Level-2-260C-1 YEAR	-40 to 85	SBY
TPS62092RGTT.Z	Active	Production	VQFN (RGT)   16	250   SMALL T&R	Yes	NIPDAU	Level-2-260C-1 YEAR	-40 to 85	SBY
<a href="#">TPS62093RGTR</a>	Active	Production	VQFN (RGT)   16	3000   LARGE T&R	Yes	NIPDAU	Level-2-260C-1 YEAR	-40 to 85	SBZ
TPS62093RGTR.Z	Active	Production	VQFN (RGT)   16	3000   LARGE T&R	Yes	NIPDAU	Level-2-260C-1 YEAR	-40 to 85	SBZ
<a href="#">TPS62093RGTT</a>	Active	Production	VQFN (RGT)   16	250   SMALL T&R	Yes	NIPDAU	Level-2-260C-1 YEAR	-40 to 85	SBZ
TPS62093RGTT.Z	Active	Production	VQFN (RGT)   16	250   SMALL T&R	Yes	NIPDAU	Level-2-260C-1 YEAR	-40 to 85	SBZ

(1) **Status:** For more details on status, see our [product life cycle](#).

(2) **Material type:** When designated, preproduction parts are prototypes/experimental devices, and are not yet approved or released for full production. Testing and final process, including without limitation quality assurance, reliability performance testing, and/or process qualification, may not yet be complete, and this item is subject to further changes or possible discontinuation. If available for ordering, purchases will be subject to an additional waiver at checkout, and are intended for early internal evaluation purposes only. These items are sold without warranties of any kind.

(3) **RoHS values:** Yes, No, RoHS Exempt. See the [TI RoHS Statement](#) for additional information and value definition.

(4) **Lead finish/Ball material:** Parts may have multiple material finish options. Finish options are separated by a vertical ruled line. Lead finish/Ball material values may wrap to two lines if the finish value exceeds the maximum column width.

(5) **MSL rating/Peak reflow:** The moisture sensitivity level ratings and peak solder (reflow) temperatures. In the event that a part has multiple moisture sensitivity ratings, only the lowest level per JEDEC standards is shown. Refer to the shipping label for the actual reflow temperature that will be used to mount the part to the printed circuit board.

(6) **Part marking:** There may be an additional marking, which relates to the logo, the lot trace code information, or the environmental category of the part.

Multiple part markings will be inside parentheses. Only one part marking contained in parentheses and separated by a "~" will appear on a part. If a line is indented then it is a continuation of the previous line and the two combined represent the entire part marking for that device.

**Important Information and Disclaimer:**The information provided on this page represents TI's knowledge and belief as of the date that it is provided. TI bases its knowledge and belief on information provided by third parties, and makes no representation or warranty as to the accuracy of such information. Efforts are underway to better integrate information from third parties. TI has taken and continues to take reasonable steps to provide representative and accurate information but may not have conducted destructive testing or chemical analysis on incoming materials and chemicals. TI and TI suppliers consider certain information to be proprietary, and thus CAS numbers and other limited information may not be available for release.

In no event shall TI's liability arising out of such information exceed the total purchase price of the TI part(s) at issue in this document sold by TI to Customer on an annual basis.

**OTHER QUALIFIED VERSIONS OF TPS62090 :**

- Automotive : [TPS62090-Q1](#)

NOTE: Qualified Version Definitions:

- Automotive - Q100 devices qualified for high-reliability automotive applications targeting zero defects

**TAPE AND REEL INFORMATION**

**QUADRANT ASSIGNMENTS FOR PIN 1 ORIENTATION IN TAPE**

\*All dimensions are nominal

Device	Package Type	Package Drawing	Pins	SPQ	Reel Diameter (mm)	Reel Width W1 (mm)	A0 (mm)	B0 (mm)	K0 (mm)	P1 (mm)	W (mm)	Pin1 Quadrant
TPS62090RGTR	VQFN	RGT	16	3000	330.0	12.4	3.3	3.3	1.1	8.0	12.0	Q2
TPS62090RGTT	VQFN	RGT	16	250	180.0	12.4	3.3	3.3	1.1	8.0	12.0	Q2
TPS62091RGTR	VQFN	RGT	16	3000	330.0	12.4	3.3	3.3	1.1	8.0	12.0	Q2
TPS62091RGTT	VQFN	RGT	16	250	180.0	12.5	3.3	3.3	1.1	8.0	12.0	Q2
TPS62091RGTT	VQFN	RGT	16	250	180.0	12.4	3.3	3.3	1.1	8.0	12.0	Q2
TPS62092RGTR	VQFN	RGT	16	3000	330.0	12.4	3.3	3.3	1.1	8.0	12.0	Q2
TPS62092RGTR	VQFN	RGT	16	3000	330.0	12.4	3.3	3.3	1.1	8.0	12.0	Q2
TPS62092RGTT	VQFN	RGT	16	250	180.0	12.4	3.3	3.3	1.1	8.0	12.0	Q2
TPS62092RGTT	VQFN	RGT	16	250	180.0	12.5	3.3	3.3	1.1	8.0	12.0	Q2
TPS62093RGTR	VQFN	RGT	16	3000	330.0	12.4	3.3	3.3	1.1	8.0	12.0	Q2
TPS62093RGTR	VQFN	RGT	16	3000	330.0	12.4	3.3	3.3	1.1	8.0	12.0	Q2
TPS62093RGTT	VQFN	RGT	16	250	180.0	12.5	3.3	3.3	1.1	8.0	12.0	Q2
TPS62093RGTT	VQFN	RGT	16	250	180.0	12.4	3.3	3.3	1.1	8.0	12.0	Q2



**TAPE AND REEL BOX DIMENSIONS**

\*All dimensions are nominal

Device	Package Type	Package Drawing	Pins	SPQ	Length (mm)	Width (mm)	Height (mm)
TPS62090RGTR	VQFN	RGT	16	3000	346.0	346.0	33.0
TPS62090RGTT	VQFN	RGT	16	250	210.0	185.0	35.0
TPS62091RGTR	VQFN	RGT	16	3000	338.0	355.0	50.0
TPS62091RGTT	VQFN	RGT	16	250	338.0	355.0	50.0
TPS62091RGTT	VQFN	RGT	16	250	210.0	185.0	35.0
TPS62092RGTR	VQFN	RGT	16	3000	338.0	355.0	50.0
TPS62092RGTR	VQFN	RGT	16	3000	346.0	346.0	33.0
TPS62092RGTT	VQFN	RGT	16	250	210.0	185.0	35.0
TPS62092RGTT	VQFN	RGT	16	250	338.0	355.0	50.0
TPS62093RGTR	VQFN	RGT	16	3000	338.0	355.0	50.0
TPS62093RGTR	VQFN	RGT	16	3000	346.0	346.0	33.0
TPS62093RGTT	VQFN	RGT	16	250	338.0	355.0	50.0
TPS62093RGTT	VQFN	RGT	16	250	210.0	185.0	35.0

**RGT 16**

**GENERIC PACKAGE VIEW**

**VQFN - 1 mm max height**

PLASTIC QUAD FLATPACK - NO LEAD



Images above are just a representation of the package family, actual package may vary.  
Refer to the product data sheet for package details.

4203495/1



SIDE WALL METAL THICKNESS DIM A	
OPTION 1	OPTION 2
0.1	0.2



4222419/D 04/2022

NOTES:

1. All linear dimensions are in millimeters. Any dimensions in parenthesis are for reference only. Dimensioning and tolerancing per ASME Y14.5M.
2. This drawing is subject to change without notice.
3. The package thermal pad must be soldered to the printed circuit board for thermal and mechanical performance.

# EXAMPLE BOARD LAYOUT

RGT0016C

VQFN - 1 mm max height

PLASTIC QUAD FLATPACK - NO LEAD

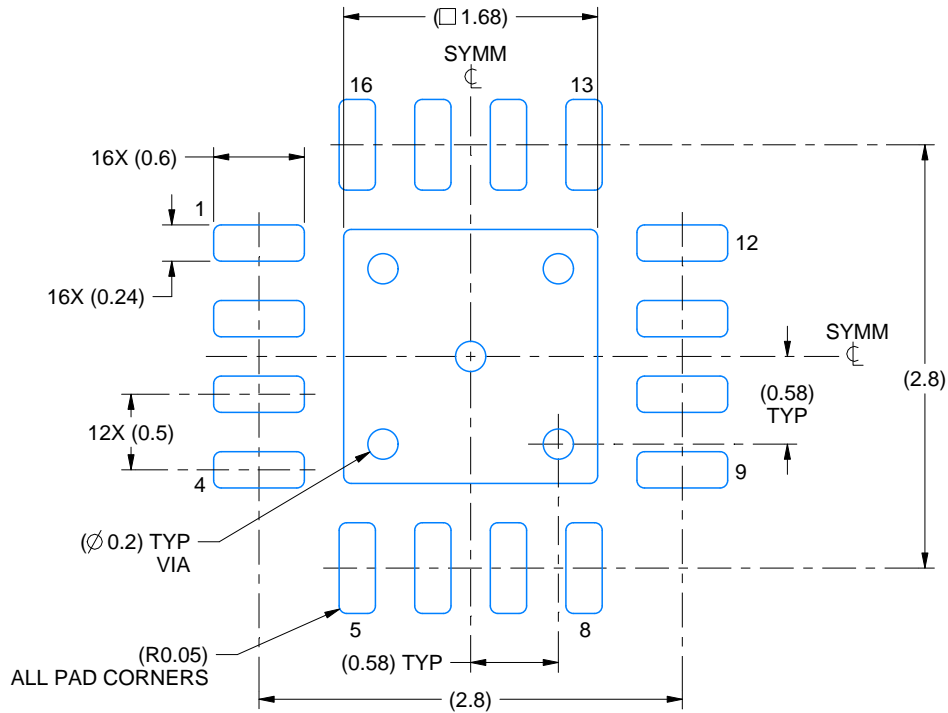

LAND PATTERN EXAMPLE  
EXPOSED METAL SHOWN  
SCALE:20X

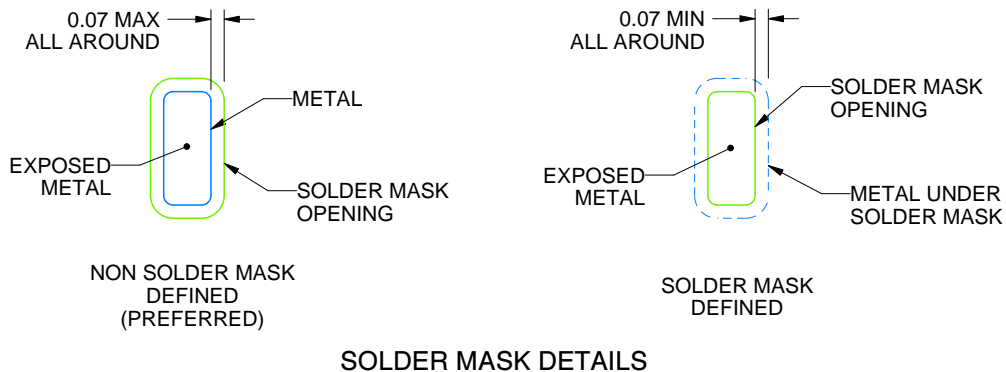

SOLDER MASK DETAILS

4222419/D 04/2022

NOTES: (continued)

4. This package is designed to be soldered to a thermal pad on the board. For more information, see Texas Instruments literature number SLUA271 ([www.ti.com/lit/slua271](http://www.ti.com/lit/slua271)).
5. Vias are optional depending on application, refer to device data sheet. If any vias are implemented, refer to their locations shown on this view. It is recommended that vias under paste be filled, plugged or tented.

# EXAMPLE STENCIL DESIGN

RGT0016C

VQFN - 1 mm max height

PLASTIC QUAD FLATPACK - NO LEAD

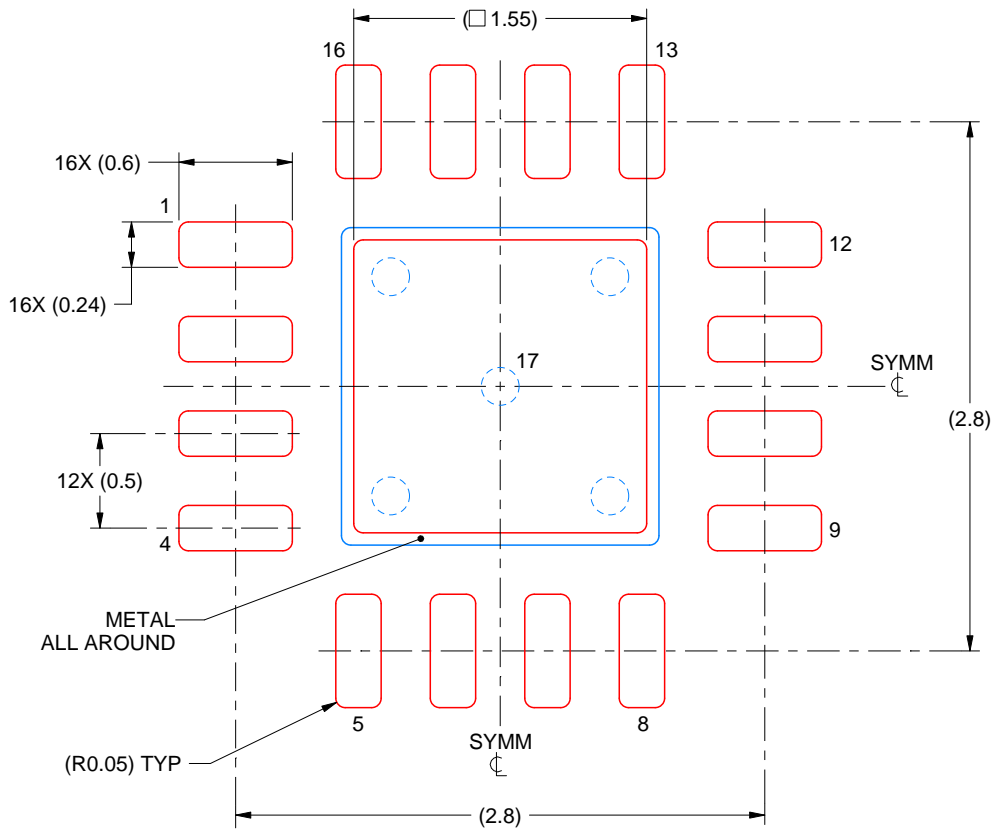

**SOLDER PASTE EXAMPLE**  
BASED ON 0.125 mm THICK STENCIL

EXPOSED PAD 17:  
85% PRINTED SOLDER COVERAGE BY AREA UNDER PACKAGE  
SCALE:25X

4222419/D 04/2022

NOTES: (continued)

6. Laser cutting apertures with trapezoidal walls and rounded corners may offer better paste release. IPC-7525 may have alternate design recommendations.

## IMPORTANT NOTICE AND DISCLAIMER

TI PROVIDES TECHNICAL AND RELIABILITY DATA (INCLUDING DATA SHEETS), DESIGN RESOURCES (INCLUDING REFERENCE DESIGNS), APPLICATION OR OTHER DESIGN ADVICE, WEB TOOLS, SAFETY INFORMATION, AND OTHER RESOURCES "AS IS" AND WITH ALL FAULTS, AND DISCLAIMS ALL WARRANTIES, EXPRESS AND IMPLIED, INCLUDING WITHOUT LIMITATION ANY IMPLIED WARRANTIES OF MERCHANTABILITY, FITNESS FOR A PARTICULAR PURPOSE OR NON-INFRINGEMENT OF THIRD PARTY INTELLECTUAL PROPERTY RIGHTS.

These resources are intended for skilled developers designing with TI products. You are solely responsible for (1) selecting the appropriate TI products for your application, (2) designing, validating and testing your application, and (3) ensuring your application meets applicable standards, and any other safety, security, regulatory or other requirements.

These resources are subject to change without notice. TI grants you permission to use these resources only for development of an application that uses the TI products described in the resource. Other reproduction and display of these resources is prohibited. No license is granted to any other TI intellectual property right or to any third party intellectual property right. TI disclaims responsibility for, and you will fully indemnify TI and its representatives against, any claims, damages, costs, losses, and liabilities arising out of your use of these resources.

TI's products are provided subject to [TI's Terms of Sale](#) or other applicable terms available either on [ti.com](https://www.ti.com) or provided in conjunction with such TI products. TI's provision of these resources does not expand or otherwise alter TI's applicable warranties or warranty disclaimers for TI products.

TI objects to and rejects any additional or different terms you may have proposed.

Mailing Address: Texas Instruments, Post Office Box 655303, Dallas, Texas 75265

Copyright © 2025, Texas Instruments Incorporated