

## 4.5V to 18V Input 1.5A, 2.5A, 1.5A Triple Synchronous Step-Down Converter

Check for Samples: [TPS65580](#)

### FEATURES

- **Advanced D-CAP2™ Control Mode**
  - Fast Transient Response
  - No External Parts Required For Loop Compensation
  - Compatible with Ceramic Output Capacitors
- **Wide Input Voltage Range : 4.5 V to 18 V**
- **Output Voltage Range : 0.76 V to 7.0 V**
- **Highly Efficient Integrated FETs Optimized for Low Duty Cycle Applications**
  - 160 mΩ (High Side) and 130 mΩ (Low Side) for 2.5A
  - 250mΩ (High Side) and 230mΩ (Low Side) for 1.5A
- **High Initial Reference Accuracy**
- **Low-Side  $R_{DS(on)}$  Loss-Less Current Sensing**
- **Fixed 1.2 ms Soft Start**
- **Non-Sinking Pre-Biased Soft Start**
- **700 kHz Switching Frequency**
- **Cycle-by-Cycle Over-Current Limiting Control**
- **OCL, OVP, UVP, UVLO, TSD Protections**
- **Hiccup Timer for Over Load Protection**
- **PowerGood**
- **Adaptive Gate Drivers with Integrated Boost PMOS Switch**
- **OCP Constant Due To Thermally Compensated  $r_{ds(on)}$  with 4000ppm/°C**
- **20-Pin HTSSOP**

### APPLICATIONS

- **Point-of-Load Regulation in Low Power Systems for Wide Range of Applications**
  - Digital TV Power Supply
  - Networking Home Terminal
  - Digital Set Top Box (STB)
  - DVD Player/Recorder
  - Gaming Consoles and Other

### DESCRIPTION

The TPS65580 is a triple, advanced D-CAP2™ mode synchronous buck converter. The TPS65580 enables system designers to complete the suite of various end equipment's power bus regulators with a cost effective, low component count, and low standby current solution. The main control loops of the TPS65580 uses the advanced D-CAP2™ mode control which provides a fast transient response with no external compensation components. The TPS65580 is able to adapt to both low equivalent series resistance (ESR) output capacitors such as POSCAP or SP-CAP, and ultra-low ESR, ceramic capacitors. The device provides convenient and efficient operation with input voltages from 4.5V to 18V.

The TPS65580 is available in 4.4mm × 6.5mm 20 pin TSSOP (PWP) package, and is specified from –40°C to 85°C ambient temperature range.



Please be aware that an important notice concerning availability, standard warranty, and use in critical applications of Texas Instruments semiconductor products and disclaimers thereto appears at the end of this data sheet.

D-CAP2, PowerPAD are trademarks of Texas Instruments.



These devices have limited built-in ESD protection. The leads should be shorted together or the device placed in conductive foam during storage or handling to prevent electrostatic damage to the MOS gates.

### HTSSOP APPLICATION DIAGRAM

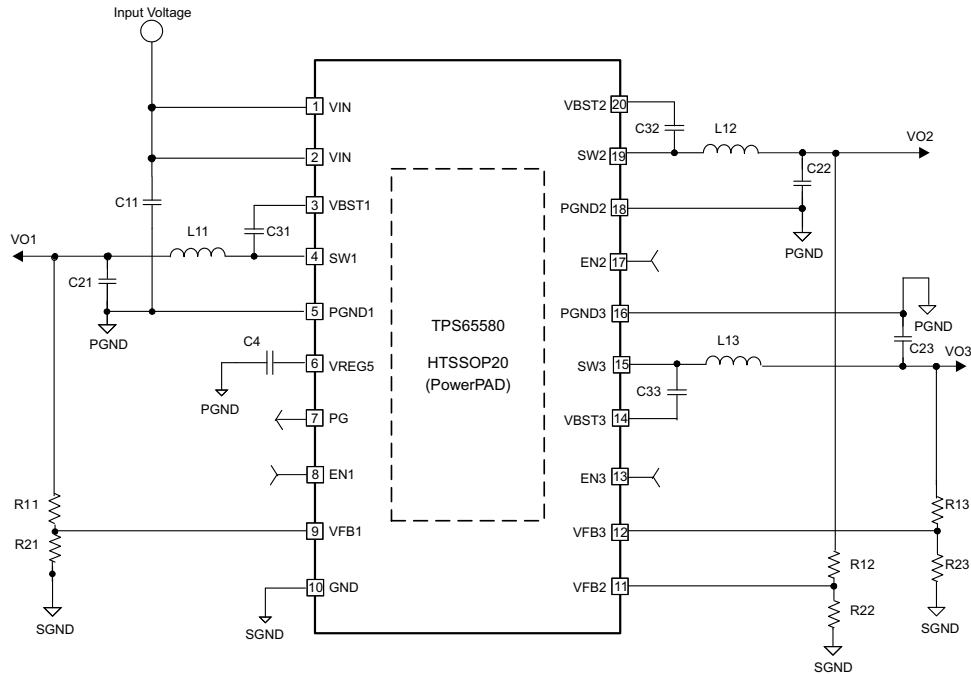

### ORDERING INFORMATION

T <sub>A</sub>	PACKAGE <sup>(1)</sup>	ORDERING PART NUMBER	PINS	OUTPUT SUPPLY	ECO PLAN
-40°C to 85°C	PWP	TPS65580PWPR	20	Tape-and-Reel	Green (RoHS & no Sb/Br)
		TPS65580PWP		Tube	

(1) For the most current package and ordering information, see the Package Option Addendum at the end of this document, or see the TI web site at [www.ti.com](http://www.ti.com)

## ABSOLUTE MAXIMUM RATINGS

 over operating free-air temperature range (unless otherwise noted)<sup>(1)(2)</sup>

		VALUE		UNIT
		MIN	MAX	
Input voltage range	VIN, EN1, EN2, EN3	-0.3	20	V
	VBST1, VBST2, VBST3	-0.3	26	
	VBST1, VBST2, VBST3 (10ns transient)	-0.3	28	
	VBST1–SW1, VBST2–SW2, VBST3–SW3	-0.3	6.5	
	VFB1, VFB2, VFB3	-0.3	6.5	
	SW1, SW2, SW3	-2	20	
	SW1, SW2, SW3 (10ns transient)	-3	22	
Output voltage range	VREG5, PG	-0.3	6.5	V
	PGND1, PGND2, PGND3	-0.3	0.3	
Electrostatic discharge	Human Body Model (HBM)	2		kV
	Charged Device Model (CDM)	500		V
T <sub>A</sub>	Operating ambient temperature range	-40	85	°C
T <sub>STG</sub>	Storage temperature range	-55	150	°C
T <sub>J</sub>	Junction temperature range	-40	150	°C

- (1) Stresses beyond those listed under "absolute maximum ratings" may cause permanent damage to the device. These are stress ratings only and functional operation of the device at these or any other conditions beyond those indicated under "recommended operating conditions" are not implied. Exposure to absolute-maximum-rated conditions for extended periods may affect device reliability.
- (2) All voltages are with respect to IC GND terminal.

## THERMAL INFORMATION

THERMAL METRIC <sup>(1)</sup>		TPS65580	UNITS
		PWP (20) PINS	
θ <sub>JA</sub>	Junction-to-ambient thermal resistance	40.0	°C/W
θ <sub>JCtop</sub>	Junction-to-case (top) thermal resistance	24.8	
θ <sub>JB</sub>	Junction-to-board thermal resistance	21.3	
ψ <sub>JT</sub>	Junction-to-top characterization parameter	0.8	
ψ <sub>JB</sub>	Junction-to-board characterization parameter	21.1	
θ <sub>JCbot</sub>	Junction-to-case (bottom) thermal resistance	1.7	

- (1) For more information about traditional and new thermal metrics, see the *IC Package Thermal Metrics application report*, [SPRA953](#).

## RECOMMENDED OPERATING CONDITIONS

over operating free-air temperature range (unless otherwise noted)

		VALUES		UNIT
		MIN	MAX	
Supply input voltage range	VIN	4.5	18	V
Input voltage range	VBST1, VBST2, VBST3	-0.1	24	V
	VBST1, VBST2, VBST3 (10ns transient)	-0.1	27	
	VBST1–SW1, VBST2–SW2, VBST3–SW3	-0.1	5.7	
	VFB1, VFB2, VFB3	-0.1	5.7	
	EN1, EN2, EN3	-0.1	18	
	SW1, SW2, SW3	-1.0	18	
	SW1, SW2, SW3 (10ns transient)	-3	21	
Output voltage range	VREG5, PG	-0.1	5.7	V
	PGND1, PGND2, PGND3	-0.1	0.1	
T <sub>A</sub>	Operating free-air temperature	-40	85	°C
T <sub>J</sub>	Operating Junction Temperature	-40	150	°C

## ELECTRICAL CHARACTERISTICS

over recommended free-air temperature range, VIN = 12 V (unless otherwise noted)

PARAMETER		CONDITIONS	MIN	TYP	MAX	UNIT
<b>SUPPLY CURRENT</b>						
I <sub>IN</sub>	VIN supply current	T <sub>A</sub> = 25°C, EN1 = EN2 = EN3 = 5 V, VFB1 = VFB2 = VFB3 = 1.0 V, Non-switching		2.9	3.6	mA
I <sub>VINSDN</sub>	VIN shutdown current	T <sub>A</sub> = 25°C, EN1 = EN2 = EN3 = 0 V		1.8	3	μA
<b>VFB VOLTAGE</b>						
V <sub>VFBTHLx</sub>	VFBx threshold voltage <sup>(1)</sup>	T <sub>A</sub> = 25°C, VO1=3.3V, VO2=1.2V, VO3=1.5V	752	764	776	mV
TC <sub>VFBx</sub>	Temperature coefficient	On the basis of 25°C <sup>(2)</sup>	-180		180	ppm/°C
<b>VREG5 OUTPUT</b>						
V <sub>UVREG5</sub>	VREG5 UVLO Threshold	VREG5 Rising		4.0		V
		Hysteresis		0.3		
V <sub>VREG5</sub>	VREG5 output voltage	T <sub>A</sub> = 25°C, VIN = 12 V, I <sub>VREG</sub> = 5 mA		5.5		V
I <sub>VREG5</sub>	Output current	VIN = 6 V, T <sub>A</sub> = 25°C	20			mA
<b>MOSFETs</b>						
r <sub>DS(on)H2</sub>	High side switch resistance for 2.5A	T <sub>A</sub> = 25°C, VBST2-SW2 = 5.5 V <sup>(2)</sup> , CH2		160		mΩ
r <sub>DS(on)L2</sub>	Low side switch resistance for 2.5A	T <sub>A</sub> = 25°C <sup>(2)</sup> , CH2		130		mΩ
r <sub>DS(on)Hx</sub>	High side switch resistance for 1.5A	T <sub>A</sub> = 25°C, VBSTx-SWx = 5.5 V <sup>(2)</sup> , CH1, CH3		250		mΩ
r <sub>DS(on)Lx</sub>	Low side switch resistance for 1.5A	T <sub>A</sub> = 25°C <sup>(2)</sup> , CH1, CH3		230		mΩ
<b>MIN ON/OFF TIME and SWfrequency</b>						
T <sub>ONminx</sub>	Min On Time	T <sub>A</sub> = 25°C, VOUT = 0.8V <sup>(2)</sup>	80			ns
T <sub>OFFminx</sub>	Min Off Time	T <sub>A</sub> = 25°C, VFBx = 0.7 V <sup>(2)</sup>		220		ns
F <sub>sw</sub>	SW-frequency	T <sub>A</sub> = 25°C		700		kHz
<b>SOFT START</b>						
T <sub>SS</sub>	Soft-start time	Internal soft-start time		1.2		ms

(1) x means either 1 or 2 or 3, that is, VFBx means VFB1, VFB2 or VFB3.

(2) Specified by design. Not production tested.

**ELECTRICAL CHARACTERISTICS (continued)**

over recommended free-air temperature range, VIN = 12 V (unless otherwise noted)

PARAMETER		CONDITIONS	MIN	TYP	MAX	UNIT
<b>POWER GOOD</b>						
V <sub>PGTH</sub>	PGx threshold	PG from lower VOx (going high)	84%			
		PG from higher VOx (going low)	116%			
R <sub>PG</sub>	PGx pull-down resistance	VPGx = 0.5 V	50	85	130	Ω
T <sub>PGDLY</sub>	PGx delay time	Delay for PGx going high	1.5			ms
		Delay for PGx going low	2			μs
T <sub>PGCOMPSS</sub>	PGOOD comparator start-up delay	PGx comparator wake-up delay	2.8			ms
<b>LOGIC THRESHOLD</b>						
V <sub>ENH</sub>	ENx H-level threshold voltage		2.0			V
V <sub>ENL</sub>	ENx L-level threshold voltage		0.4			V
R <sub>ENx_IN</sub>	ENx input resistance	ENx = 12 V	225	400	900	kΩ
<b>CURRENT LIMIT</b>						
I <sub>OCL1</sub>	Current limit	Lout = 3.3 μH <sup>(3)</sup> , VOUT = 3.3 V	1.7	2.0	3.4	A
I <sub>OCL2</sub>		Lout = 2.2 μH <sup>(3)</sup> VOUT = 1.2 V	2.9	3.5	4.9	A
I <sub>OCL3</sub>		Lout = 2.2 μH <sup>(3)</sup> VOUT = 1.5 V	1.8	2.2	3.6	A
<b>OVER / UNDER VOLTAGE PROTECTION</b>						
V <sub>OVP</sub>	Output OVP trip threshold	measured on VFBx	120%			
V <sub>UVP</sub>	Output UVP trip threshold	measured on VFBx	63%	68%	73%	
T <sub>UVPDEL</sub>	Output UVP delay time		0.5			ms
T <sub>UVPEN</sub>	Output UVP enable delay	UVP Enable Delay	2.8			ms
<b>THERMAL SHUTDOWN</b>						
T <sub>SD</sub>	Thermal shutdown threshold	Shutdown temperature <sup>(3)</sup>	155			°C
		Hysteresis <sup>(3)</sup>	30			

(3) Specified by design. Not production tested.

DEVICE INFORMATION

HTSSOP PACKAGE  
(TOP VIEW)

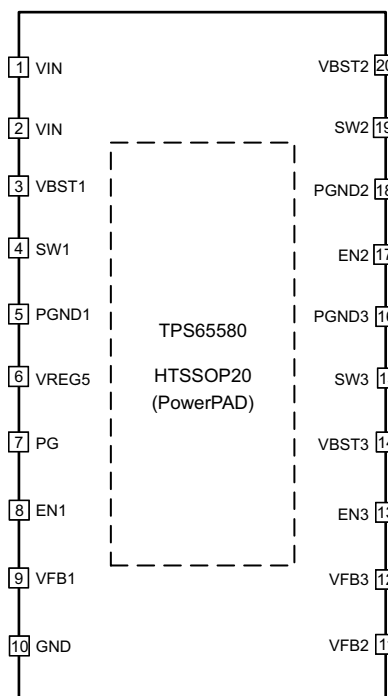

PIN FUNCTIONS<sup>(1)</sup>

PIN		I/O	DESCRIPTION
NAME	TSSOP20		
VIN	1, 2	I	Power input and connects to both high side NFET drains. Supply Input for 5.5V linear regulator.
VBST1, VBST2, VBST3	3, 14, 20	I	Supply input for high-side NFET gate drive circuit. Connect 0.1µF ceramic capacitor between VBSTx and SWx pins. An internal diode is connected between VREG5 and VBSTx
SW1, SW2, SW3	4, 15, 19	I/O	Switch node connections for both the high-side NFETs and low-side NFETs. Input of current comparator.
PGND1, PGND2, PGND3	5, 16, 18	I/O	Ground returns for low-side MOSFETs. Input of current comparator.
VREG5	6	O	Output of 5.5V linear regulator. Bypass to GND with a high-quality ceramic capacitor of at least 1.0µF. VREG5 is active when ENx is high level.
PG	7	O	Open drain power good output. Low means the output voltage is out of regulation.
EN1, EN2, EN3	8, 13, 17	I	Enable. Pull High to according converter.
VFB1, VFB2, VFB3	9, 11, 12	I	D-CAP2 feedback inputs. Connect to output voltage with resistor divider.
GND	10	I/O	Signal GND. Connect sensitive VFBx returns to GND at a single point.
Exposed Thermal Pad	Back side	I/O	Thermal pad of the package. Must be soldered to achieve appropriate dissipation. Must be connected to GND.

(1) x means either 1, 2 or 3, VFBx means VFB1, VFB2 or VFB3.

FUNCTIONAL BLOCK DIAGRAM

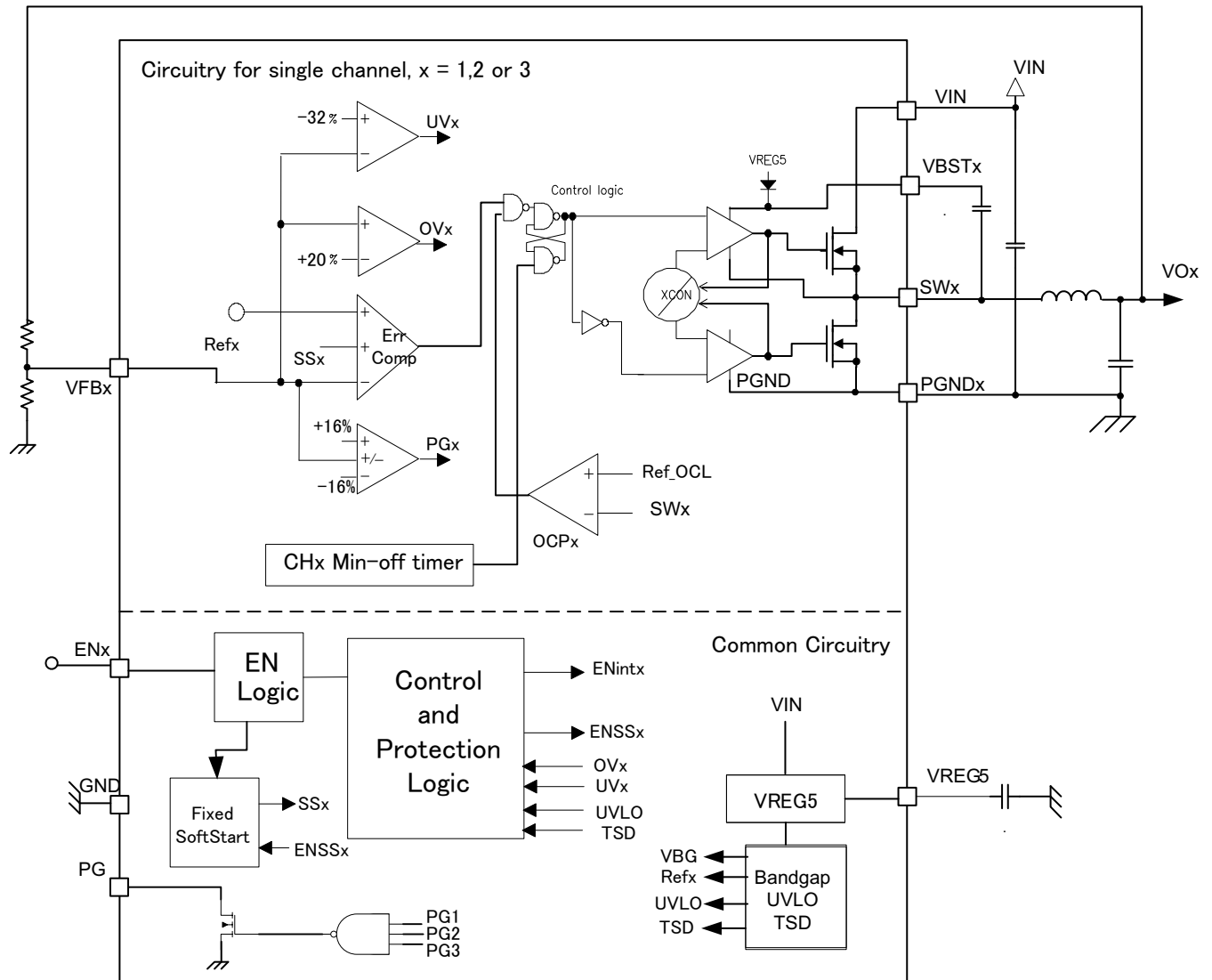

## OVERVIEW

The TPS65580 is a 1.5A/2.5A/1.5A triple synchronous step-down (buck) converter with two integrated N-channel MOSFETs for each channel. It operates using Advanced D-CAP2™ control mode. The fast transient response of Advanced D-CAP2™ control reduces the required output capacitance to meet a specific level of performance. Proprietary internal circuitry allows the use of low ESR output capacitors including ceramic and special polymer types.

## DETAILED DESCRIPTION

### PWM Operation

The main control loop of the TPS65580 is a fixed switching frequency pulse width modulation (PWM) controller that supports a proprietary advanced D-CAP2™ mode control. Advanced D-CAP2™ mode control combines constant switching frequency with an internal compensation circuit and low external component count configuration with both low ESR and ceramic output capacitors. It is stable even with virtually no ripple at the output.

### PWM Frequency and Adaptive On-Time Control

TPS65580 uses a advanced D-CAP2 mode control scheme and have a dedicated on board oscillator. The TPS65580 runs with fixed frequency of 700 kHz.

### Soft Start and Pre-Biased Soft Start

The TPS65580 has an internal, 1.2ms, soft-start for each channel. When the ENx pin becomes high, an internal DAC begins ramping up the reference voltage to the PWM comparator. Smooth control of the output voltage is maintained during start up.

The TPS65580 contains a unique circuit to prevent current from being pulled from the output during startup if the output is pre-biased. When the soft-start commands a voltage higher than the pre-bias level (internal soft start becomes greater than internal feedback voltage  $V_{FB}$ ), the controller slowly activates synchronous rectification by starting the first low side FET gate driver pulses with a narrow on-time. It then increments that on-time on a cycle-by-cycle basis until it coincides with the time dictated by  $(1-D)$ , where  $D$  is the duty cycle of the converter. This scheme prevents the initial sinking of the pre-biased output, and ensures that the output voltage ( $VOx$ ) starts and ramps up smoothly into regulation from pre-biased startup to normal mode operation.

### Overvoltage Protection

TPS65580 detects overvoltage conditions by monitoring the feedback voltage ( $V_{FB}$ ). When the feedback voltage becomes higher than 120% of the target voltage, the OVP comparator output goes high and the circuit drives as the high-side MOSFET driver turns off and the low-side MOSFET turns off.

This is a non-latch function.

### Current Protection

The output over-current protection (OCP) is implemented using a cycle-by-cycle valley detect control circuit and using HICCUP mode over current protection. The switch current is monitored by measuring the low-side FET switch voltage between the SWx pin and PGNDx. This voltage is proportional to the switch current and the on-resistance of the FET. To improve accuracy, the voltage sensing is temperature compensated.

During the on time of the high-side FET switch, the switch current increases at a linear rate determined by  $V_{in}$ ,  $V_{out}$ , the on-time and the output inductor value. During the on time of the low-side FET switch, this current decreases linearly. The average value of the switch current is the load current  $I_{ox}$ . If the sensed voltage on the low side FET is above the voltage proportional to the current limit, the converter keeps the low-side switch on until the measured voltage falls below the voltage corresponding to the current limit and a new switching cycle begins. In subsequent switching cycles, the on-time is set to the value determined for CCM and the current is monitored in the same manner.



Following are some important considerations for this type of over-current protection. The load current one half of the peak-to-peak inductor current higher than the over-current threshold. Also when the current is being limited, the output voltage tends to fall as the demanded load current may be higher than the current available from the converter. When the over current condition is removed, the output voltage returns to the regulated value. This protection is non-latching.

Load current less than 1.5 A for CH1 and CH3 is required at VOUT setting in high on-duty because overcurrent limit function causes degradation of load transient response.

### Hiccup Mode

Hiccup mode of operation protects the power supply from being damaged during an over-current fault condition. The operation of hiccup is as follows. If the OCL comparator circuit detects an over-current event the output voltage falls. When the feedback voltage falls below 68% of the reference voltage, the UVP comparator output goes high and an internal UVP delay counter begins counting. After counting UVP delay time, the TPS65580 shuts off the power supply for a given time (7x UVP Enable Delay Time) and then tries to re-start the power supply. If the over-load condition has been removed, the power supply starts and operates normally; otherwise, the TPS65580 detects another over-current event and shuts off the power supply again, repeating the previous cycle. Excess heat due to overload lasts for only a short duration in the hiccup cycle, therefore the junction temperature of the power devices is much lower.

### POWERGOOD

The TPS65580 has power-good output that are measured on VFBx. The power-good function is activated after the soft-start has finished. If the all output voltages of 3 channels are within 16% of the target voltage, the internal comparator detects the power good state and the power good signal becomes high after 1.5ms delay. During start-up, this internal delay starts after 1.5ms of the UVP Enable delay time to avoid a glitch of power-good signal. Even if at least one of the feedback voltages of 3 channels goes outside of  $\pm 16\%$  of target value, the power-good signal becomes low after  $2\mu s$ .

<Start up>

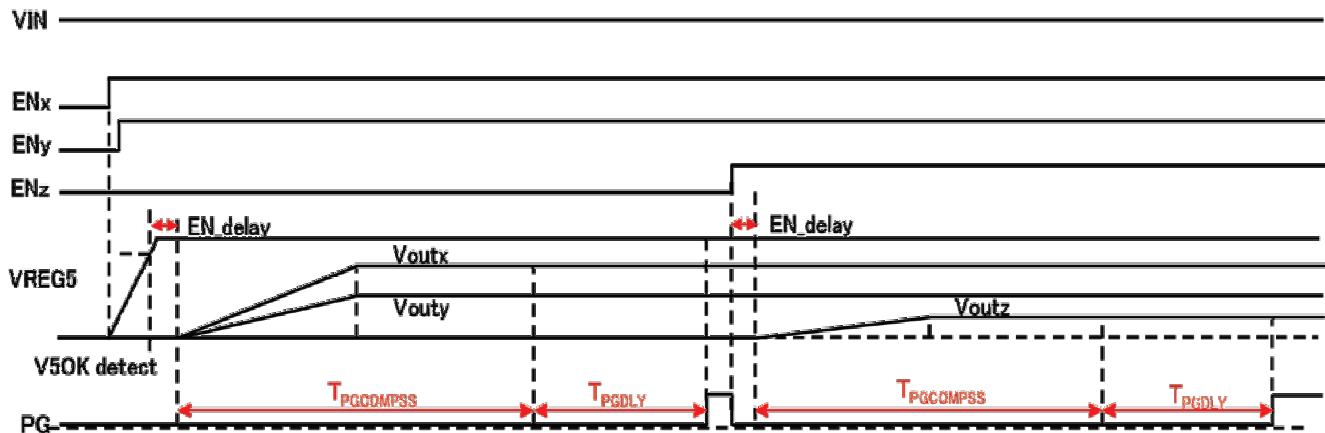

Figure 1. Start up

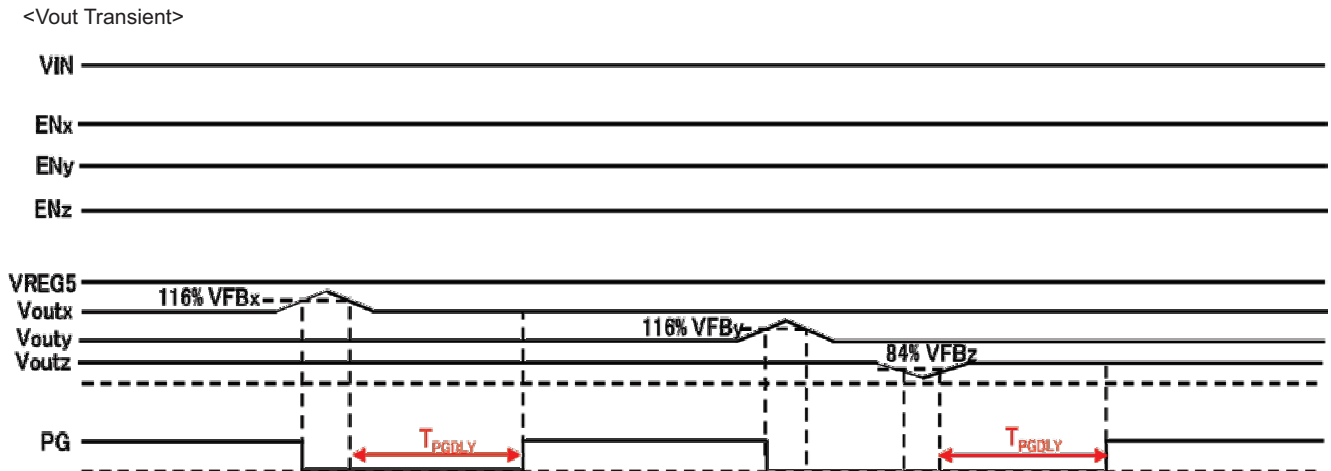

Figure 2. V<sub>OUT</sub> Transient

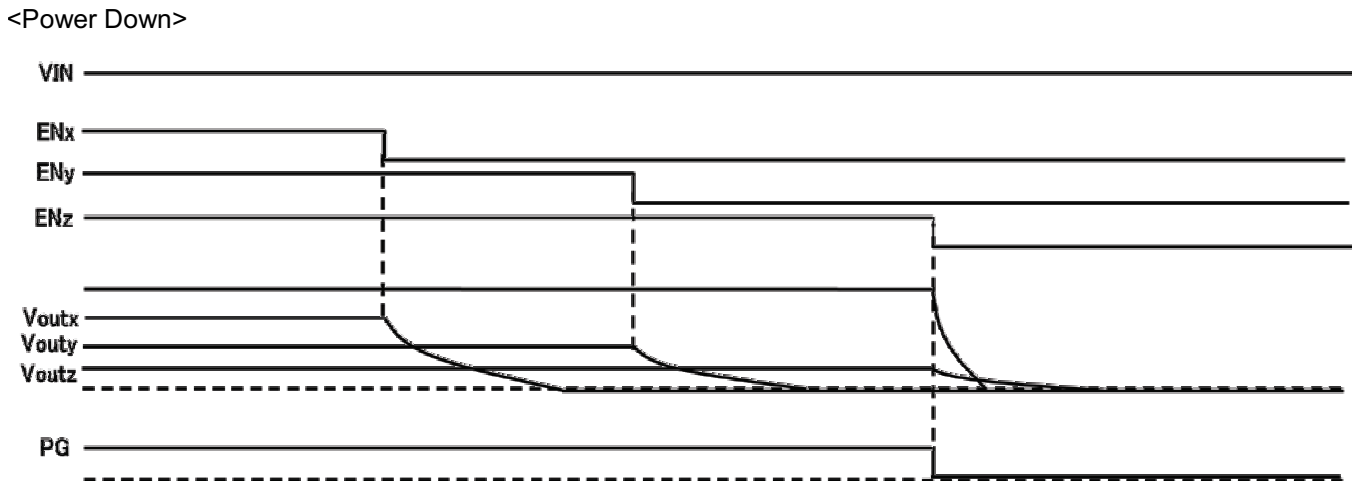

Figure 3. Power Down

**UVLO Protection**

Under voltage lock out protection (UVLO) monitors the voltage of the VREG5 pin. When the VREG5 voltage is lower than UVLO threshold voltage, the TPS65580 is shut down. As soon as the voltage increases above the UVLO threshold, the converter starts again.

**Thermal Shutdown**

TPS65580 monitors its temperature of itself. If the temperature exceeds the threshold value (typically 155°C), the device is shut down. When the temperature falls below the threshold, the IC starts again. When VIN starts up and VREG5 output voltage is below its nominal value, the thermal shutdown threshold is lower than 155°C. As long as VIN and VREG5 rise, T<sub>J</sub> must be kept below 110°C.

**TYPICAL CHARACTERISTICS**

V<sub>IN</sub> = 12 V, T<sub>A</sub> = 25°C (unless otherwise noted)

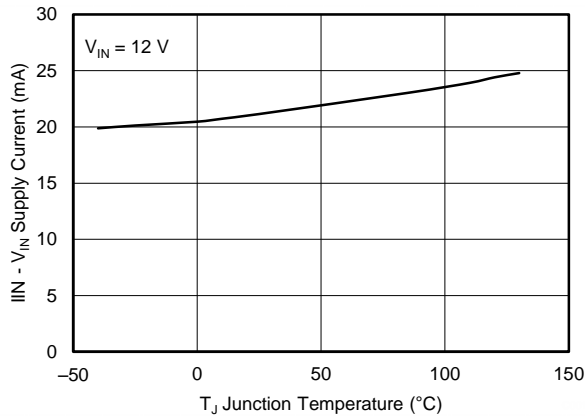

**Figure 4. VIN Current vs Junction Temperature (VIN Current at ALL Channels Switching with I<sub>O</sub> = 0A)**

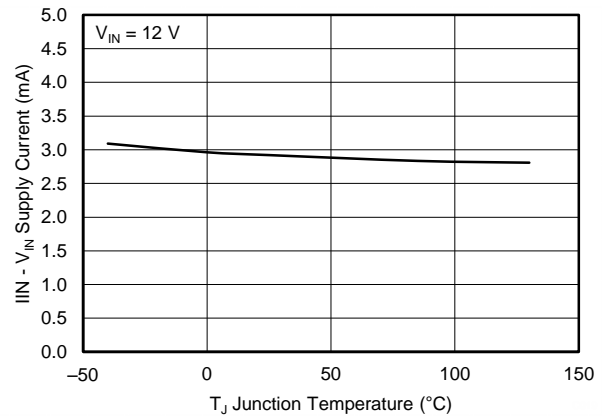

**Figure 5. VIN Current vs Junction Temperature (VIN Current at ALL Channels Non-switching EN = H)**

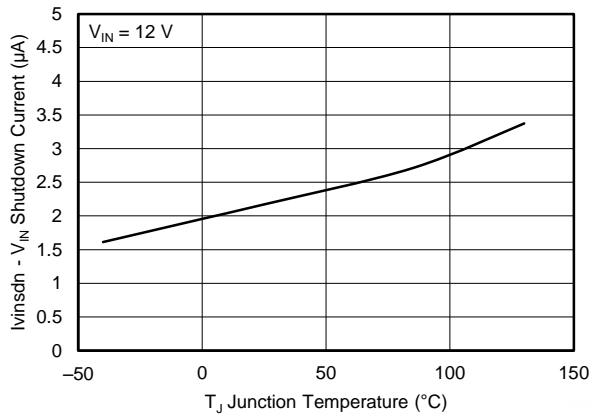

**Figure 6. VIN Shutdown Current vs Junction Temperature**

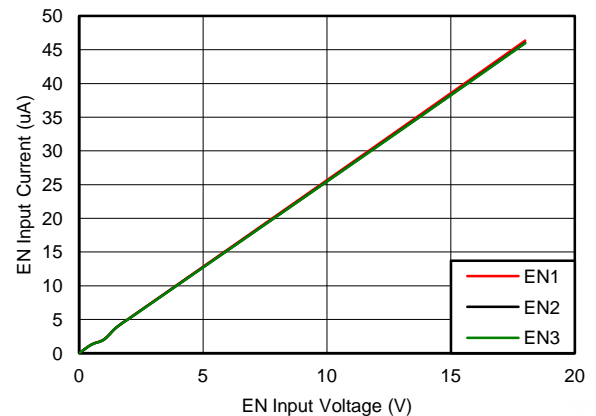

**Figure 7. EN Current vs EN Voltage**

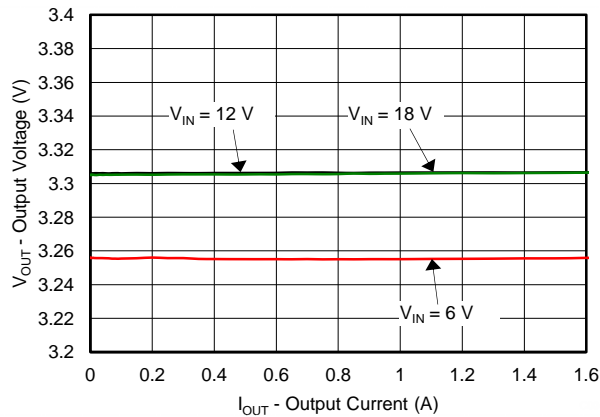

**Figure 8. VOUT1 = 3.3V Output Voltage vs Output Current**

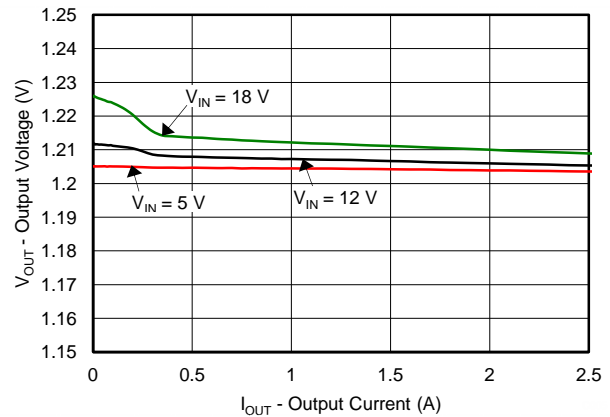

**Figure 9. VOUT2 = 1.2V Output Voltage vs Output Current**

**TYPICAL CHARACTERISTICS (continued)**

V<sub>IN</sub> = 12 V, T<sub>A</sub> = 25°C (unless otherwise noted)

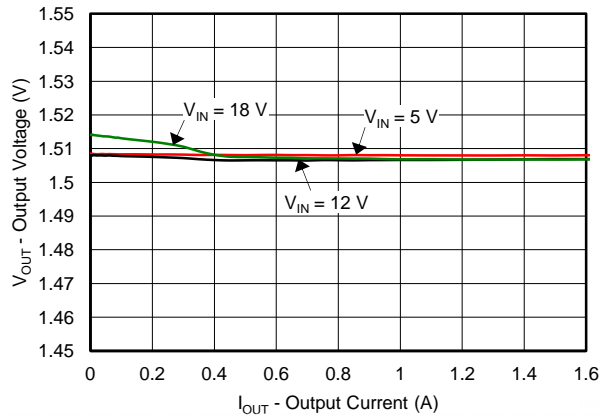

Figure 10. VOUT3 = 1.5V Output Voltage vs Output Current

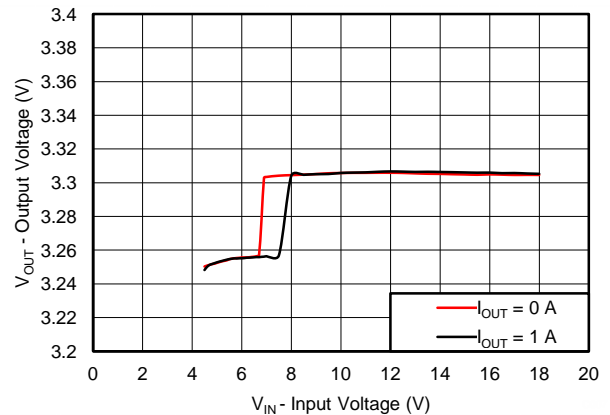

Figure 11. VOUT1 = 3.3V Output Voltage vs Input Voltage

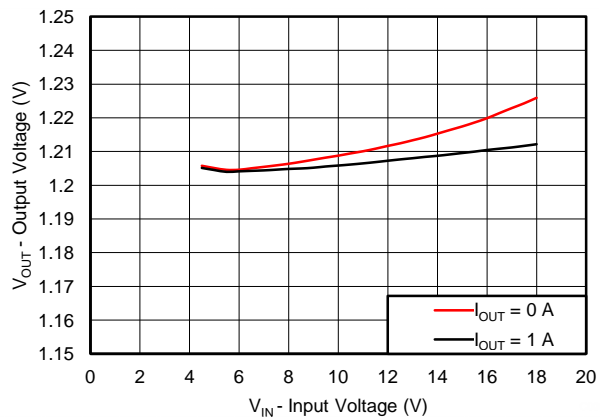

Figure 12. VOUT2 = 1.2V Output Voltage vs Input Voltage

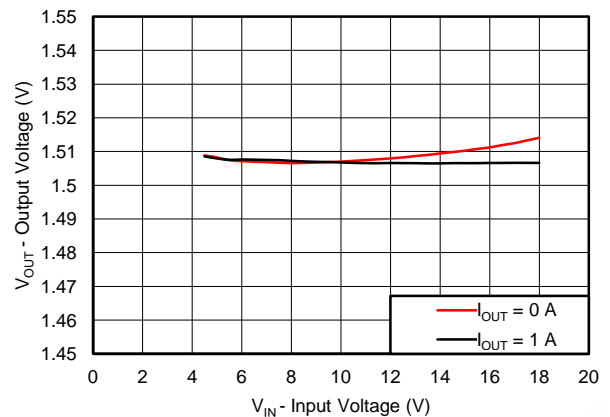

Figure 13. VOUT3 = 1.5V Output Voltage vs Input Voltage

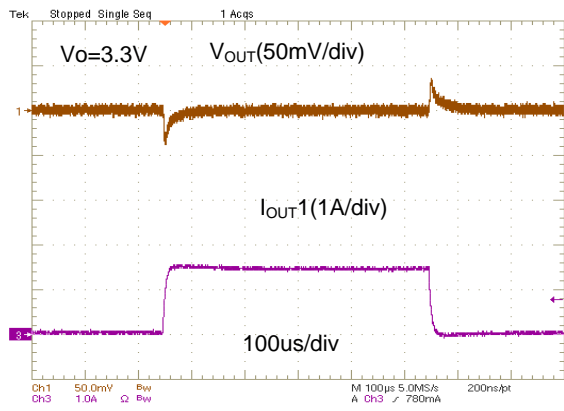

Figure 14. VOUT1 = 3.3V, 0A to 1.5A Load Transient Response

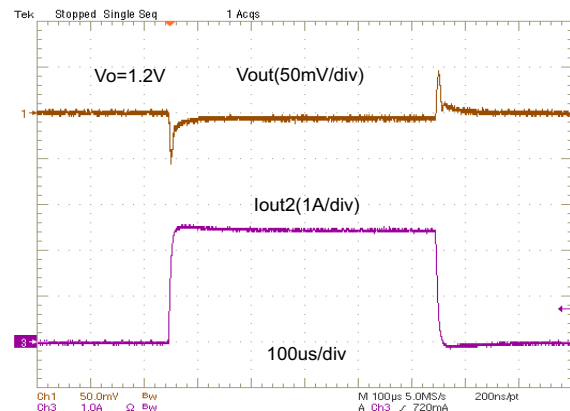

Figure 15. VOUT2 = 1.2V, 0A to 2.5A Load Transient Response

TYPICAL CHARACTERISTICS (continued)

VIN = 12 V, TA = 25°C (unless otherwise noted)

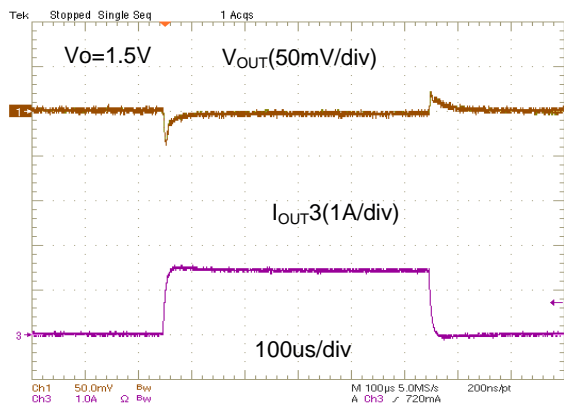

Figure 16. VOUT3 = 1.5V, 0A to 1.5A Load Transient Response

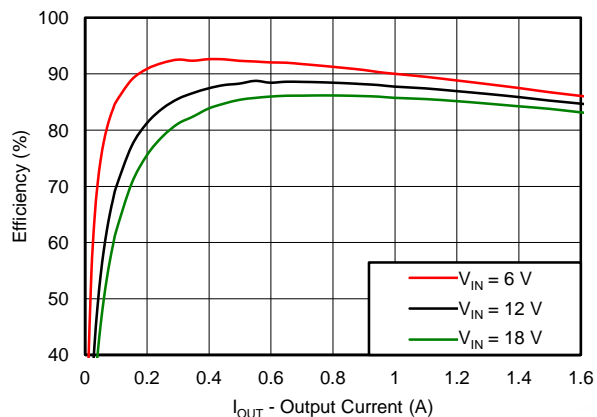

Figure 17. VOUT1 = 3.3V Light Load Efficiency vs Output Current

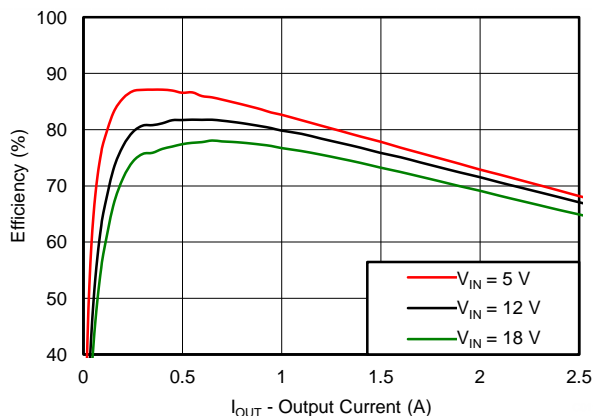

Figure 18. VOUT2 = 1.2V Light Load Efficiency vs Output Current

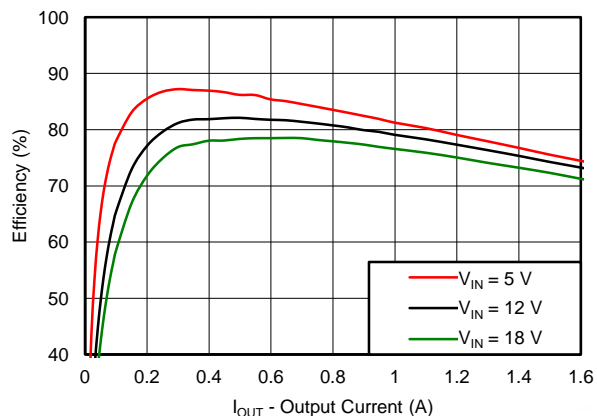

Figure 19. VOUT3=1.5V, Light Load Efficiency vs Output Current

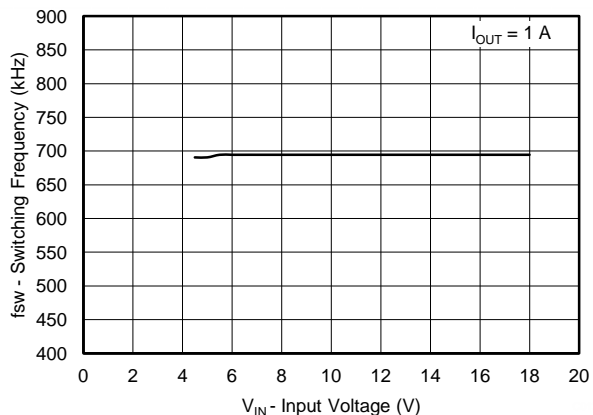

Figure 20. VOUT1 = 3.3V Switching Frequency vs Input Voltage

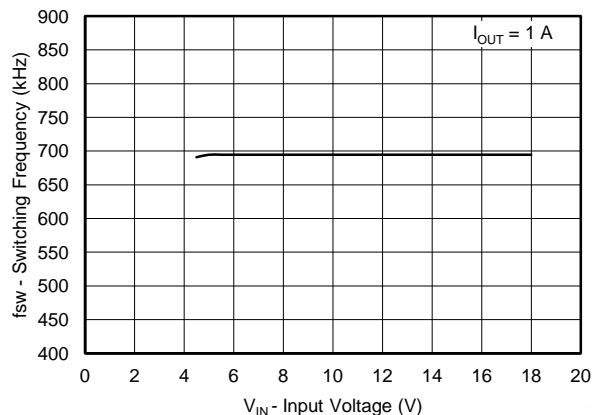
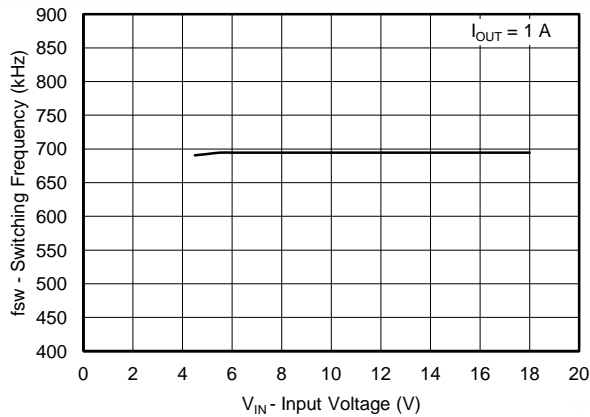

Figure 21. VOUT2 = 1.2V Switching Frequency vs Input Voltage

**TYPICAL CHARACTERISTICS (continued)**

VIN = 12 V, TA = 25°C (unless otherwise noted)



**Figure 22. VOUT3 = 1.5V Switching Frequency vs Input Voltage**

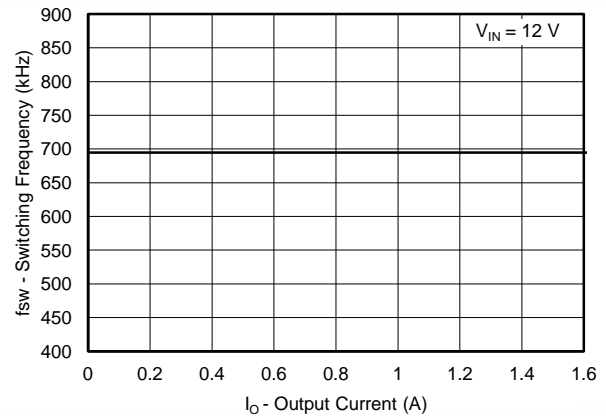

**Figure 23. VOUT1 = 3.3V Switching Frequency vs Output current**

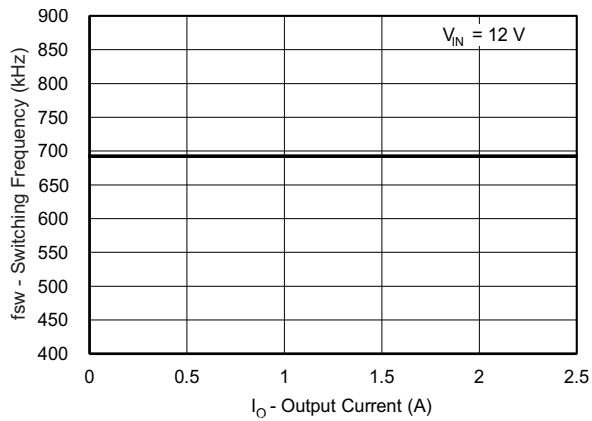

**Figure 24. VOUT2 = 1.2V, Switching Frequency vs Output Current**

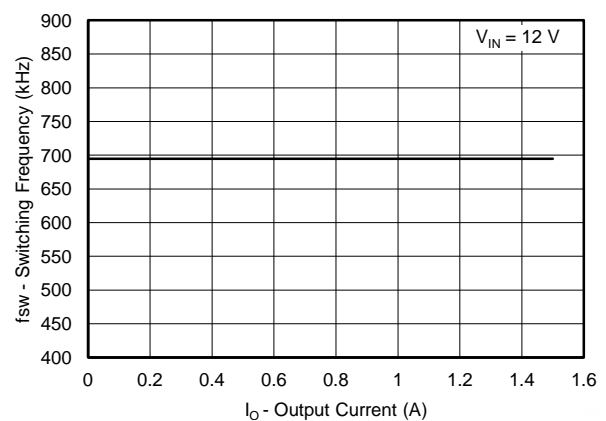

**Figure 25. VOUT3 = 1.5V, Switching Frequency vs Output Current**

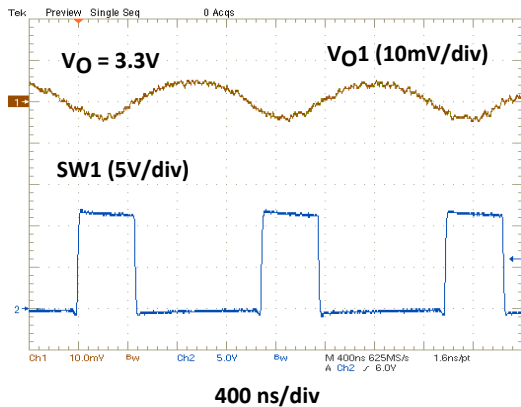

**Figure 26. VOUT1 = 3.3V, VO1 Ripple Voltage at IOUT1 = 1.5A**

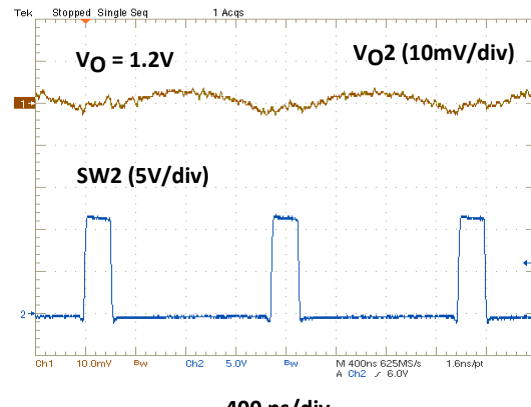

**Figure 27. VOUT2 = 1.2V, Ripple Voltage at IOUT2 = 2.5A**

TYPICAL CHARACTERISTICS (continued)

VIN = 12 V, TA = 25°C (unless otherwise noted)

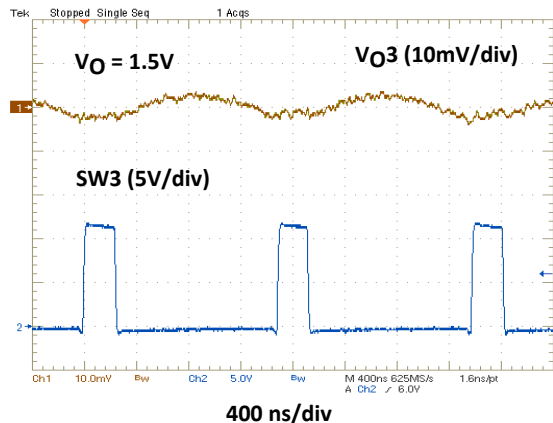

Figure 28. VOUT3 = 1.2V, Ripple Voltage at IOUT3 = 1.5A

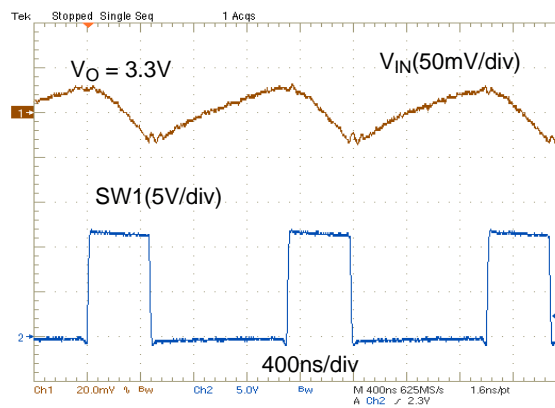

Figure 29. VOUT1 = 3.3V, VIN Ripple Voltage at IOUT1 = 1.5A

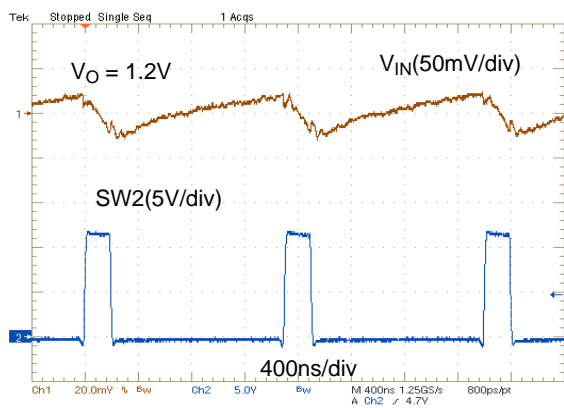

Figure 30. VOUT2 = 1.2V VIN Ripple at IOUT2 = 2.5A

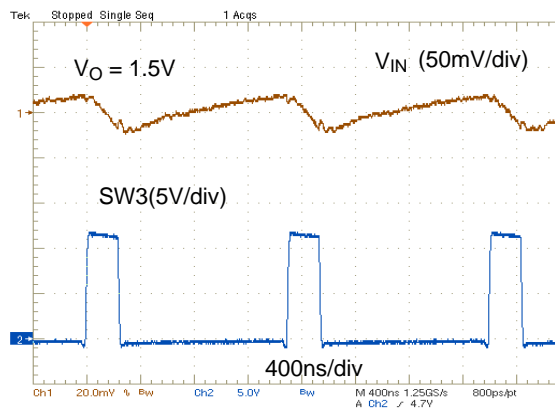

Figure 31. VOUT3 = 1.5V VIN Ripple at IOUT3 = 1.5A

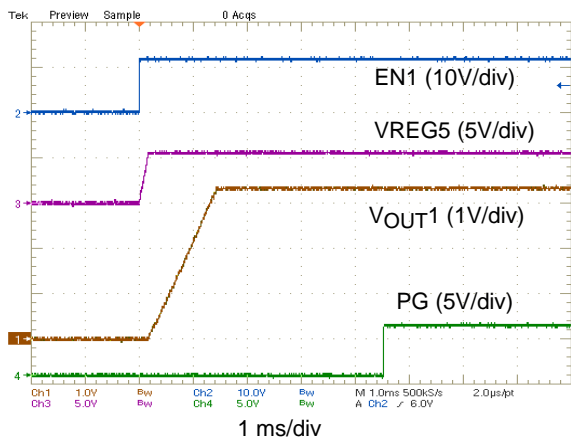

Figure 32. VOUT1 = 3.3V Soft-Start IOUT1 = 1.5A

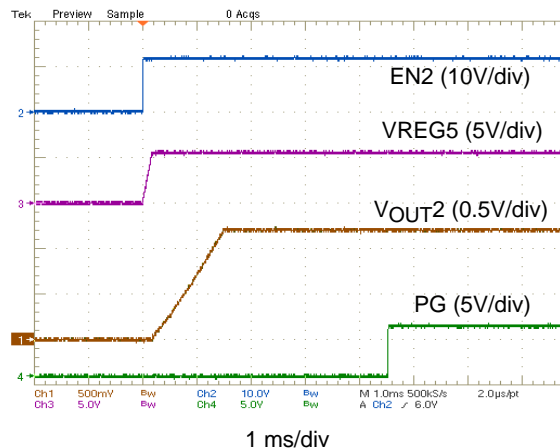
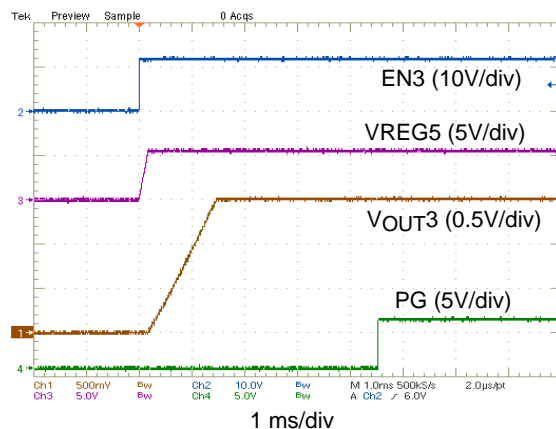

Figure 33. VOUT2 = 1.2V Soft-Start IOUT2 = 2.5A

**TYPICAL CHARACTERISTICS (continued)**

VIN = 12 V, TA = 25°C (unless otherwise noted)



**Figure 34. VOUT3 = 1.5V Soft-Start IOU3 = 1.5A**



## DESIGN GUIDE

### Step By Step Design Procedure

To begin the design process, you must know a few application parameters:

- Input voltage range
- Output voltage
- Output current

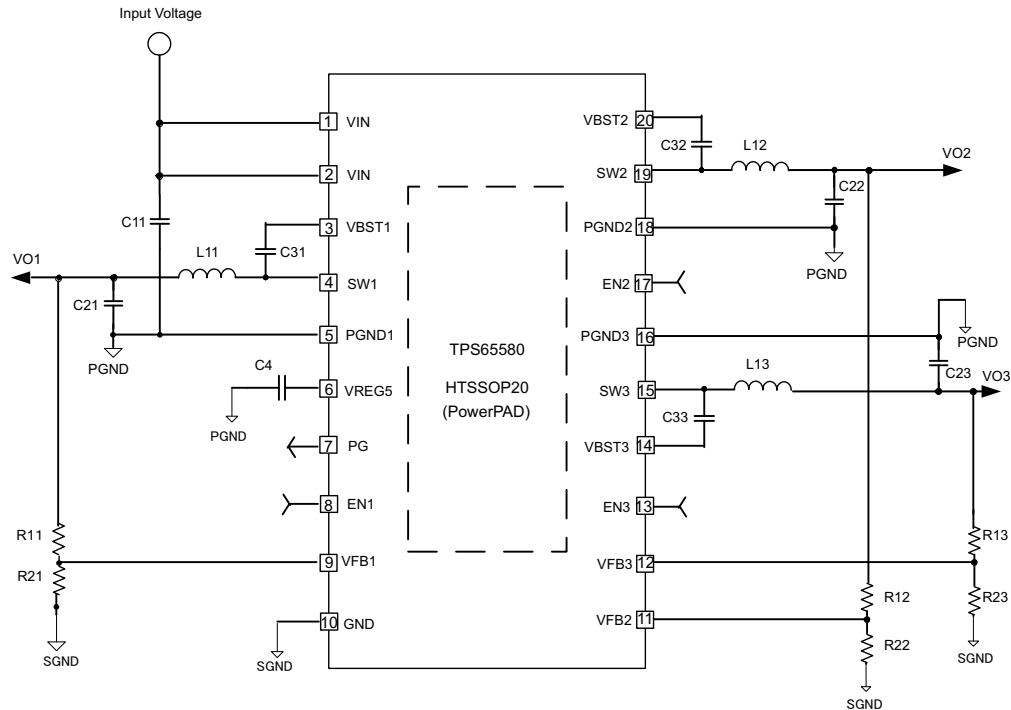

Figure 35. Schematic Diagram for the Design Example at  $V_{in}=12V$

### Output Voltage Resistors Selection

The output voltage is set with a resistor divider from the output node to the VFBx pin. It is recommended to use 1% tolerance or better divider resistors. Start by using Equation 1 to calculate  $V_{OX}$ .

To improve efficiency at very light loads consider using larger value resistors; although, resistance values too high cause more susceptibility to noise and voltage errors due to the VFBx input current being more noticeable.

$$V_{OX} = 0.764 \times \left( 1 + \frac{R1x}{R2x} \right) \quad (1)$$

### Output Filter Selection

The output filter used with the TPS65580 is an LC circuit. This LC filter has double pole at:

$$F_P = \frac{1}{2\pi\sqrt{L_{1X} \times C_{2X}}} \quad (2)$$

At low frequencies, the overall loop gain is set by the output set-point resistor divider network and the internal gain of the TPS65580. The low frequency phase is 180 degrees. At the output filter pole frequency, the gain rolls off at a –40 dB per decade rate and the phase drops rapidly. Advanced D-CAP2™ introduces a high frequency zero that reduces the gain roll off to –20 dB per decade and increases the phase to 90 degrees one decade above the zero frequency. The inductor and capacitor selected for the output filter must be selected so that the double pole of Equation 2 is located below the high frequency zero but close enough that the phase boost provided by the high frequency zero provides adequate phase margin for a stable circuit. To meet this requirement use the values recommended in Table 1.

**Table 1. Recommended Component Values**

OUTPUT VOLTAGE (V)	R1x (kΩ)	R2x (kΩ)	L1x (μH)	C2x (μF)
1	0.68	2.2	1.5 to 3.3	22 - 68
1.05	0.82	2.2	1.5 to 3.3	22 - 68
1.2	1.27	2.2	1.5 to 3.3	22 - 68
1.5	2.15	2.2	1.5 to 3.3	22 - 68
1.8	3.00	2.2	1.5 to 3.3	22 - 68
2.5	4.98	2.2	2.2 to 4.7	22 - 68
3.3	7.36	2.2	2.2 to 4.7	22 - 68
5	12.4	2.2	2.2 to 4.7	22 - 68
6.5	16.5	2.2	2.2 to 4.7	22 - 68

The inductor peak-to-peak ripple current, peak current and RMS current are calculated using Equation 3, Equation 4 and Equation 5. The inductor saturation current rating must be greater than the calculated peak current and the RMS or heating current rating must be greater than the calculated RMS current.

For the calculations, use 700 kHz as the switching frequency,  $f_{SW}$ . Make sure the chosen inductor is rated for the peak current of Equation 4 and the RMS current of Equation 5.

$$\Delta I_{L1X} = \frac{V_{OX}}{V_{IN(MAX)}} \times \frac{V_{IN(MAX)} - V_{OX}}{L1x \times f_{SW}} \quad (3)$$

$$I_{L1XPEAK} = I_{OX} + \frac{\Delta I_{L1X}}{2} \quad (4)$$

$$I_{L1X(RMS)} = \sqrt{I_{OX}^2 + \frac{1}{12} \Delta I_{L1X}^2} \quad (5)$$

For the above design example, the calculated peak current is 2.46 A and the calculated RMS current is 2.02 A. for Vo1. The inductor used is a TDK CLF7045-1R5N with a rated current of 7.3 A based on the inductance change and of 4.9A based on the temperature rise.

The capacitor value and ESR determines the amount of output voltage ripple. The TPS65580 is intended for use with ceramic or other low ESR capacitors. Recommended values range from 22μF to 68μF. Use Equation 6 to determine the required RMS current rating for the output capacitor(s).

$$I_{C2X(RMS)} = \frac{V_{OX} \times (V_{IN} - V_{OX})}{\sqrt{12} \times V_{IN} \times L1X \times f_{SW}} \quad (6)$$

For this design two TDK C3216X5R0J226M 22μF output capacitors are used. The typical ESR is 2 mΩ each. The calculated RMS current is 0.19A and each output capacitor is rated for 4A.

## Input Capacitor Selection

The TPS65580 requires an input decoupling capacitor and a bulk capacitor is needed depending on the application. A ceramic capacitor over 10μF × 2 is recommended for the decoupling capacitor. Accordingly, 0.1 μF ceramic capacitors from pin 1 to ground is recommended to improve the stability and reduce the SWx node overshoots. The capacitor voltage rating needs to be greater than the maximum input voltage.

### Bootstrap Capacitor Selection

A 0.1  $\mu\text{F}$  ceramic capacitors must be connected between the VBSTx and SWx pins for proper operation. It is recommended to use ceramic capacitors with a dielectric of X5R or better.

### VREG5 Capacitor Selection

A 1  $\mu\text{F}$  ceramic capacitor must be connected between the VREG5 and GND pins for proper operation. It is recommended to use a ceramic capacitor with a dielectric of X5R or better.

### Thermal Information

This 20-pin PWP package incorporates an exposed thermal pad that is designed to be directly to an external heatsink. The thermal pad must be soldered directly to the printed board (PCB). After soldering, the PCB can be used as a heatsink. In addition, through the use of thermal vias, the thermal pad can be attached directly to the appropriate copper plane shown in the electrical schematic for the device, or alternatively, can be attached to a special heatsink structure designed into the PCB. This design optimizes the heat transfer from the integrated circuit (IC).

For additional information on the exposed thermal pad and how to use the advantage of its heat dissipating abilities, refer to the Technical Brief, *PowerPAD™ Thermally Enhanced Package*, Texas Instruments Literature No. [SLMA002](#) and Application Brief, *PowerPAD™ Made Easy*, Texas Instruments Literature No. [SLMA004](#).

The exposed thermal pad dimensions for this package are shown in the following illustration.

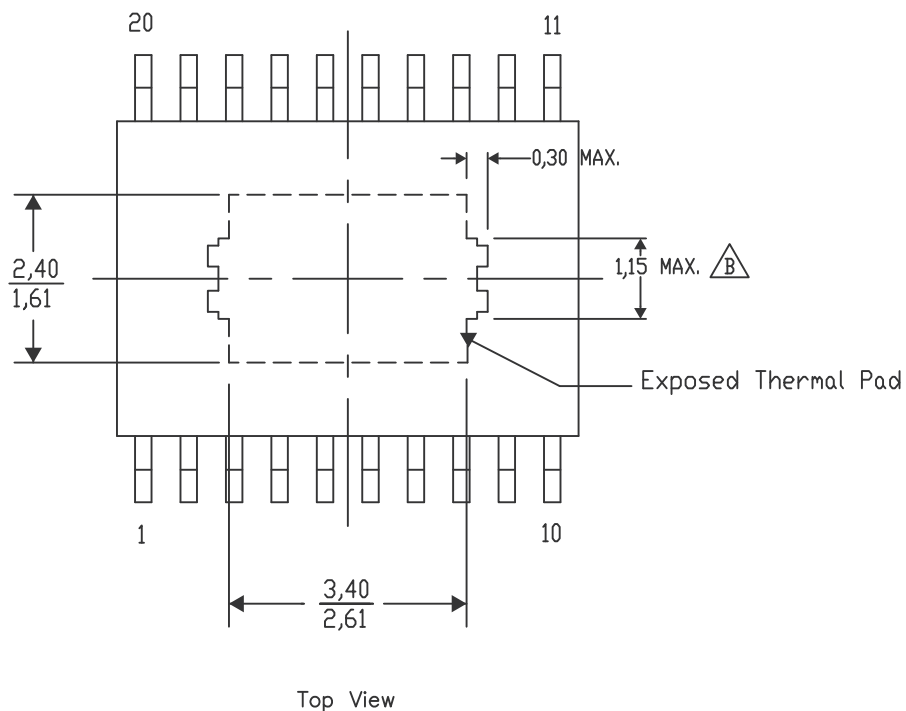

NOTE: A. All linear dimensions are in millimeters

Exposed tie strap features may not be present.

**Figure 36. Thermal Pad Dimensions**

### Layout Considerations

1. Keep the input current loop as small as possible. And avoid the input switching current through the thermal pad.
2. Keep the SW node as physically small and short as possible to minimize parasitic capacitance and inductance and to minimize radiated emissions. Kelvin connections should be brought from the output to the feedback pin of the device.
3. Keep analog and non-switching components away from switching components.
4. Make a single point connection from the signal ground to power ground.
5. Do not allow switching currents to flow under the device.
6. Keep the pattern lines for VIN and PGND broad.
7. Exposed pad of device must be connected to PGND with solder.
8. VREG5 capacitor should be placed near the device, and connected to PGND.
9. Output capacitors should be connected with a broad pattern to the PGND.
10. Voltage feedback loops should be as short as possible, and preferably with ground shield.
11. Kelvin connections should be brought from the output to the feedback pin of the device.
12. Providing sufficient vias is preferable for VIN, SW and PGND connection.
13. PCB pattern for VIN, SW, and PGND should be as broad as possible.
14. VIN Capacitor should be placed as near as possible to the device.

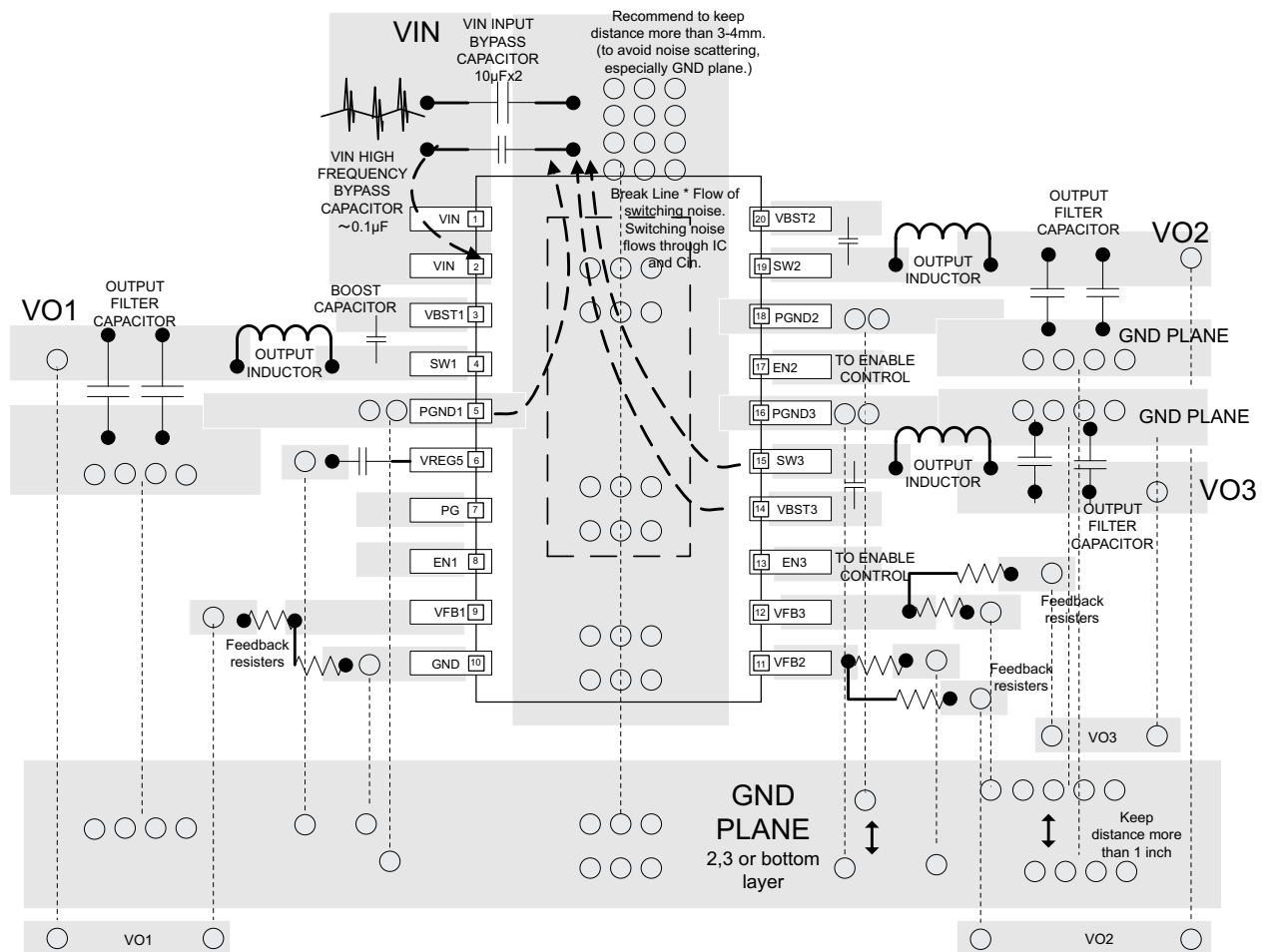

## REVISION HISTORY

Page numbers of current version may differ from previous versions.

<b>Changes from Original (September 2013) to Revision A</b>	<b>Page</b>
• Added text to Current Protection section for clarification. ....	9
• Added text to Output Voltage Resistors Selection for clarification. ....	17
• Corrected resistor R1x (k $\Omega$ ) values in <a href="#">Table 1</a> . ....	18

<b>Changes from Revision A (September 2013) to Revision B</b>	<b>Page</b>
• Added $V_{OVP}$ specification to ELEC CHARA, OVER / UNDER VOLTAGE PROTECTION .....	5
• Added Overvoltage Protection description. ....	8

**PACKAGING INFORMATION**

Orderable part number	Status (1)	Material type (2)	Package   Pins	Package qty   Carrier	RoHS (3)	Lead finish/ Ball material (4)	MSL rating/ Peak reflow (5)	Op temp (°C)	Part marking (6)
<a href="#">TPS65580PWP</a>	Active	Production	HTSSOP (PWP)   20	70   TUBE	Yes	NIPDAU	Level-2-260C-1 YEAR	-40 to 125	TPS65580
<a href="#">TPS65580PWPR</a>	Active	Production	HTSSOP (PWP)   20	2000   LARGE T&R	Yes	NIPDAU	Level-2-260C-1 YEAR	-40 to 125	TPS65580

(1) **Status:** For more details on status, see our [product life cycle](#).

(2) **Material type:** When designated, preproduction parts are prototypes/experimental devices, and are not yet approved or released for full production. Testing and final process, including without limitation quality assurance, reliability performance testing, and/or process qualification, may not yet be complete, and this item is subject to further changes or possible discontinuation. If available for ordering, purchases will be subject to an additional waiver at checkout, and are intended for early internal evaluation purposes only. These items are sold without warranties of any kind.

(3) **RoHS values:** Yes, No, RoHS Exempt. See the [TI RoHS Statement](#) for additional information and value definition.

(4) **Lead finish/Ball material:** Parts may have multiple material finish options. Finish options are separated by a vertical ruled line. Lead finish/Ball material values may wrap to two lines if the finish value exceeds the maximum column width.

(5) **MSL rating/Peak reflow:** The moisture sensitivity level ratings and peak solder (reflow) temperatures. In the event that a part has multiple moisture sensitivity ratings, only the lowest level per JEDEC standards is shown. Refer to the shipping label for the actual reflow temperature that will be used to mount the part to the printed circuit board.

(6) **Part marking:** There may be an additional marking, which relates to the logo, the lot trace code information, or the environmental category of the part.

Multiple part markings will be inside parentheses. Only one part marking contained in parentheses and separated by a "~" will appear on a part. If a line is indented then it is a continuation of the previous line and the two combined represent the entire part marking for that device.

**Important Information and Disclaimer:**The information provided on this page represents TI's knowledge and belief as of the date that it is provided. TI bases its knowledge and belief on information provided by third parties, and makes no representation or warranty as to the accuracy of such information. Efforts are underway to better integrate information from third parties. TI has taken and continues to take reasonable steps to provide representative and accurate information but may not have conducted destructive testing or chemical analysis on incoming materials and chemicals. TI and TI suppliers consider certain information to be proprietary, and thus CAS numbers and other limited information may not be available for release.

In no event shall TI's liability arising out of such information exceed the total purchase price of the TI part(s) at issue in this document sold by TI to Customer on an annual basis.

**TAPE AND REEL INFORMATION**

**QUADRANT ASSIGNMENTS FOR PIN 1 ORIENTATION IN TAPE**

\*All dimensions are nominal

Device	Package Type	Package Drawing	Pins	SPQ	Reel Diameter (mm)	Reel Width W1 (mm)	A0 (mm)	B0 (mm)	K0 (mm)	P1 (mm)	W (mm)	Pin1 Quadrant
TPS65580PWPR	HTSSOP	PWP	20	2000	330.0	16.4	6.95	7.1	1.6	8.0	16.0	Q1

**TAPE AND REEL BOX DIMENSIONS**

\*All dimensions are nominal

Device	Package Type	Package Drawing	Pins	SPQ	Length (mm)	Width (mm)	Height (mm)
TPS65580PWPR	HTSSOP	PWP	20	2000	350.0	350.0	43.0



**TUBE**

\*All dimensions are nominal

Device	Package Name	Package Type	Pins	SPQ	L (mm)	W (mm)	T (μm)	B (mm)
TPS65580PWP	PWP	HTSSOP	20	70	530	10.2	3600	3.5

## GENERIC PACKAGE VIEW

**PWP 20**

**HTSSOP - 1.2 mm max height**

6.5 x 4.4, 0.65 mm pitch

SMALL OUTLINE PACKAGE

This image is a representation of the package family, actual package may vary.  
Refer to the product data sheet for package details.

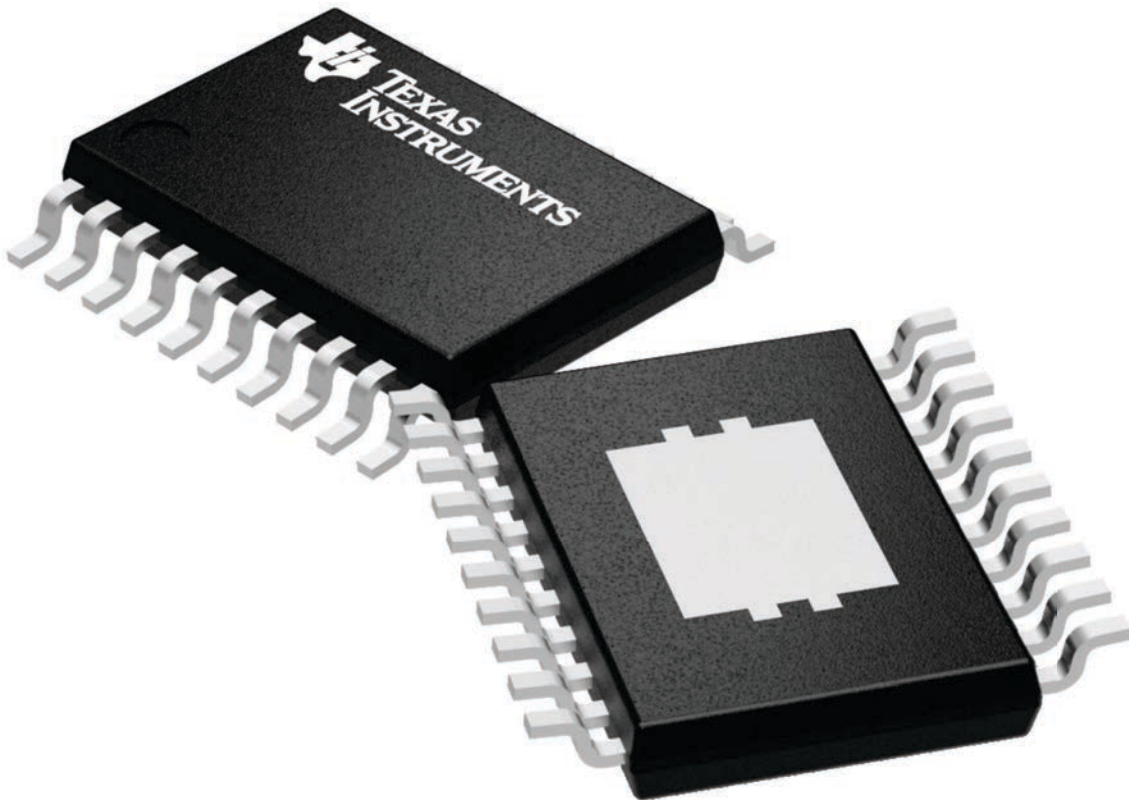

4224669/A

# MECHANICAL DATA

PWP (R-PDSO-G20)

PowerPAD™ PLASTIC SMALL OUTLINE



4073225-4/1 05/11

- NOTES:
- All linear dimensions are in millimeters.
  - This drawing is subject to change without notice.
  - Body dimensions do not include mold flash or protrusions. Mold flash and protrusion shall not exceed 0.15 per side.
  - This package is designed to be soldered to a thermal pad on the board. Refer to Technical Brief, PowerPad Thermally Enhanced Package, Texas Instruments Literature No. SLMA002 for information regarding recommended board layout. This document is available at [www.ti.com](http://www.ti.com) <<http://www.ti.com>>.
  - See the additional figure in the Product Data Sheet for details regarding the exposed thermal pad features and dimensions.
  - Falls within JEDEC MO-153

PowerPAD is a trademark of Texas Instruments.

# THERMAL PAD MECHANICAL DATA

## PWP (R-PDSO-G20) PowerPAD™ SMALL PLASTIC OUTLINE

### THERMAL INFORMATION

This PowerPAD™ package incorporates an exposed thermal pad that is designed to be attached to a printed circuit board (PCB). The thermal pad must be soldered directly to the PCB. After soldering, the PCB can be used as a heatsink. In addition, through the use of thermal vias, the thermal pad can be attached directly to the appropriate copper plane shown in the electrical schematic for the device, or alternatively, can be attached to a special heatsink structure designed into the PCB. This design optimizes the heat transfer from the integrated circuit (IC).

For additional information on the PowerPAD package and how to take advantage of its heat dissipating abilities, refer to Technical Brief, PowerPAD Thermally Enhanced Package, Texas Instruments Literature No. SLMA002 and Application Brief, PowerPAD Made Easy, Texas Instruments Literature No. SLMA004. Both documents are available at [www.ti.com](http://www.ti.com).

The exposed thermal pad dimensions for this package are shown in the following illustration.



Top View

Exposed Thermal Pad Dimensions

4206332-15/AO 01/16

NOTE: A. All linear dimensions are in millimeters

$\triangle B$  Exposed tie strap features may not be present.

PowerPAD is a trademark of Texas Instruments

PWP (R-PDSO-G20)

PowerPAD™ PLASTIC SMALL OUTLINE



- NOTES:
- All linear dimensions are in millimeters.
  - This drawing is subject to change without notice.
  - Customers should place a note on the circuit board fabrication drawing not to alter the center solder mask defined pad.
  - This package is designed to be soldered to a thermal pad on the board. Refer to Technical Brief, PowerPad Thermally Enhanced Package, Texas Instruments Literature No. SLMA002, SLMA004, and also the Product Data Sheets for specific thermal information, via requirements, and recommended board layout. These documents are available at [www.ti.com](http://www.ti.com) <<http://www.ti.com>>. Publication IPC-7351 is recommended for alternate designs.
  - Laser cutting apertures with trapezoidal walls and also rounding corners will offer better paste release. Customers should contact their board assembly site for stencil design recommendations. Example stencil design based on a 50% volumetric metal load solder paste. Refer to IPC-7525 for other stencil recommendations.
  - Customers should contact their board fabrication site for solder mask tolerances between and around signal pads.

## IMPORTANT NOTICE AND DISCLAIMER

TI PROVIDES TECHNICAL AND RELIABILITY DATA (INCLUDING DATA SHEETS), DESIGN RESOURCES (INCLUDING REFERENCE DESIGNS), APPLICATION OR OTHER DESIGN ADVICE, WEB TOOLS, SAFETY INFORMATION, AND OTHER RESOURCES "AS IS" AND WITH ALL FAULTS, AND DISCLAIMS ALL WARRANTIES, EXPRESS AND IMPLIED, INCLUDING WITHOUT LIMITATION ANY IMPLIED WARRANTIES OF MERCHANTABILITY, FITNESS FOR A PARTICULAR PURPOSE OR NON-INFRINGEMENT OF THIRD PARTY INTELLECTUAL PROPERTY RIGHTS.

These resources are intended for skilled developers designing with TI products. You are solely responsible for (1) selecting the appropriate TI products for your application, (2) designing, validating and testing your application, and (3) ensuring your application meets applicable standards, and any other safety, security, regulatory or other requirements.

These resources are subject to change without notice. TI grants you permission to use these resources only for development of an application that uses the TI products described in the resource. Other reproduction and display of these resources is prohibited. No license is granted to any other TI intellectual property right or to any third party intellectual property right. TI disclaims responsibility for, and you will fully indemnify TI and its representatives against, any claims, damages, costs, losses, and liabilities arising out of your use of these resources.

TI's products are provided subject to [TI's Terms of Sale](#) or other applicable terms available either on [ti.com](https://www.ti.com) or provided in conjunction with such TI products. TI's provision of these resources does not expand or otherwise alter TI's applicable warranties or warranty disclaimers for TI products.

TI objects to and rejects any additional or different terms you may have proposed.

Mailing Address: Texas Instruments, Post Office Box 655303, Dallas, Texas 75265

Copyright © 2025, Texas Instruments Incorporated