

TPS7A14 1-A, Low V_{IN} , Low V_{OUT} , Ultra-Low Dropout Regulator

1 Features

- Ultra-low input voltage range: 0.7 V to 2.2 V
- High efficiency:
 - Dropout voltage at 1 A: 70 mV (max, YBK)
 - Specified for $V_{IN} = V_{OUT} + 100$ mV
- Excellent load transient response:
 - 20 mV for $I_{LOAD} = 3$ mA to 600 mA in 20 μ s
- Accuracy over load, line, and temperature: 1%
- High PSRR:
 - 80 dB at 1 kHz ($V_{OUT} = 0.8$ V, $I_{OUT} = 500$ mA)
- Available in fixed-output voltages:
 - 0.5 V to 2.0 V (in 25-mV steps)
- V_{BIAS} range: 2.2 V to 5.5 V
- Packages:
 - 6-pin DSBGA: 0.71 mm \times 1.16 mm
 - 6-pin WSON: 2 mm \times 2 mm
- Active output discharge

2 Applications

- [Camera modules](#)
- [Wireless headphones and earbuds](#)
- [Smart watch and fitness trackers](#)
- [Smart phones and tablets](#)
- [Portable medical devices](#)
- [Solid state drives \(SSDs\)](#)

3 Description

The TPS7A14 is a small, ultra low-dropout regulator (LDO) with excellent transient response. This device can source 1 A with outstanding ac performance (load and line transient responses). The input voltage range is 0.7 V to 2.2 V, and the output range is 0.5 V to 2.0 V with a very high accuracy of 1% over load, line, and temperature.

The primary power path is through the IN pin and can be connected to a power supply as low as 50 mV above the output voltage. All electrical characteristics (including excellent output voltage tolerance, transient response, and PSRR) are specified for input voltages 100 mV greater than the output voltage, thereby yielding high practical efficiency. This regulator supports very low input voltages with the use of a higher, externally supplied V_{BIAS} rail that is used to power the internal circuitry of the LDO. For example, the supply voltage to the IN pin can be the output of a high-efficiency, DC/DC step-down regulator and the BIAS pin supply voltage can be a rechargeable battery.

The TPS7A14 is equipped with an active pulldown circuit to quickly discharge the output when disabled, and provides a known start-up state.

The TPS7A14 is available in a 2-mm \times 2-mm, 6-pin WSON package and an ultra-small 0.71-mm \times 1.16-mm, 6-bump WCSP package.

Package Information

PART NUMBER	PACKAGE ⁽¹⁾	PACKAGE SIZE ⁽²⁾
TPS7A14	YBK (WCSP, 6)	1.16 mm \times 0.71 mm
	DRV (WSON, 6)	2 mm \times 2 mm

- (1) For all available packages, see the orderable addendum at the end of the data sheet.
- (2) The package size (length \times width) is a nominal value and includes pins, where applicable.

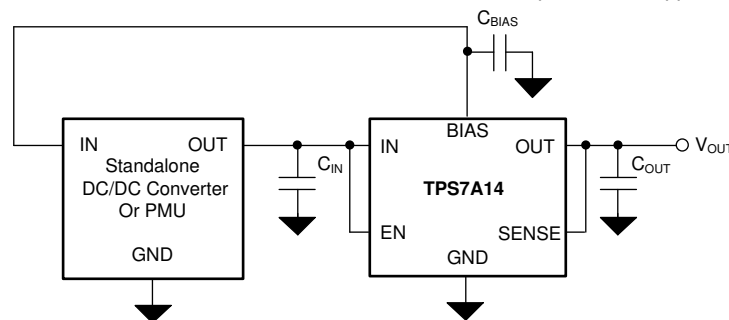

Typical Application Circuit



Table of Contents

1 Features	1	7.3 Feature Description.....	15
2 Applications	1	7.4 Device Functional Modes.....	17
3 Description	1	8 Application and Implementation	18
4 Revision History	2	8.1 Application Information.....	18
5 Pin Configuration and Functions	3	8.2 Typical Application.....	22
6 Specifications	5	8.3 Power Supply Recommendations.....	23
6.1 Absolute Maximum Ratings.....	5	8.4 Layout.....	24
6.2 ESD Ratings.....	5	9 Device and Documentation Support	25
6.3 Recommended Operating Conditions.....	5	9.1 Device Support.....	25
6.4 Thermal Information.....	6	9.2 Documentation Support.....	25
6.5 Electrical Characteristics.....	6	9.3 Receiving Notification of Documentation Updates.....	25
6.6 Switching Characteristics.....	8	9.4 Support Resources.....	25
6.7 Typical Characteristics.....	9	9.5 Trademarks.....	25
7 Detailed Description	14	9.6 Electrostatic Discharge Caution.....	25
7.1 Overview.....	14	9.7 Glossary.....	25
7.2 Functional Block Diagram.....	14		

4 Revision History

NOTE: Page numbers for previous revisions may differ from page numbers in the current version.

Changes from Revision C (July 2023) to Revision D (August 2023)	Page
• Changed DRV (WSO) package from <i>Advance Information</i> to <i>Production Data</i>	1
• Changed specifications for DRV package.....	6
• Added <i>Output Noise vs Frequency and I_{OUT}</i> curve for the DRV package.....	9
• Added <i>Recommended Layout (DRV Package)</i> figure.....	24

Changes from Revision B (May 2022) to Revision C (July 2023)	Page
• Added DRV (WSO) package to document as <i>Advance Information</i>	1
• Changed fixed-output voltages from 0.5 V to 2.05 V to 0.5 V to 2.0 V throughout document.....	1
• Changed description of packages in last paragraph of <i>Description</i> section.....	1

5 Pin Configuration and Functions

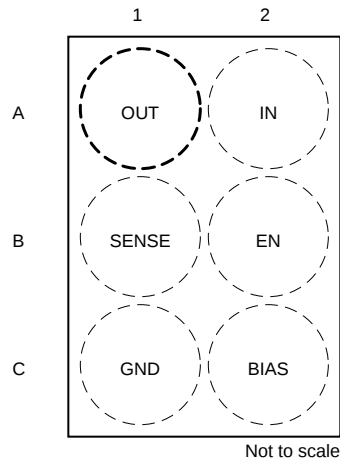

Figure 5-1. YBK Package, 6-Pin WCSP (Top View)

Table 5-1. Pin Functions: YBK Package

PIN		TYPE	DESCRIPTION
NO.	NAME		
A1	OUT	Output	Regulated output pin. A 2.2- μ F or greater capacitance is required from OUT to ground for stability. For best transient response, use an 8- μ F (nominal) or larger ceramic capacitor from OUT to ground. Place the output capacitor as close to OUT as possible.
A2	IN	Input	Input pin. A 0.75- μ F or greater capacitance is required from IN to ground for stability. Place the input capacitor as close to IN as possible.
B1	SENSE	Input	SENSE input. This pin is a feedback input to the regulator for SENSE connections. Connecting SENSE to the load helps eliminate voltage errors resulting from trace resistance between OUT and the load.
B2	EN	Input	Enable pin. Driving this pin to logic high enables the LDO. Driving this pin to logic low disables the LDO. If enable functionality is not required, EN must be connected to IN or BIAS.
C1	GND	—	Ground pin. This pin must be connected to ground.
C2	BIAS	Input	BIAS pin. This pin enables operation in low-input voltage, low-output voltage (LILLO) conditions. For best performance, use 0.47- μ F or larger ceramic capacitor from BIAS to ground. Place the bias capacitor as close to BIAS as possible.

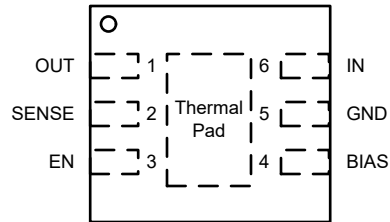

Figure 5-2. DRV Package, 6-Pin WSON With Exposed Thermal Pad (Top View)

Table 5-2. Pin Functions: DRV Package

PIN		TYPE	DESCRIPTION
NO.	NAME		
1	OUT	Output	Regulated output pin. A 2.2- μ F or greater capacitance is required from OUT to ground for stability. For best transient response, use an 8- μ F (nominal) or larger ceramic capacitor from OUT to ground. Place the output capacitor as close to OUT as possible.
2	SENSE	Input	SENSE input. This pin is a feedback input to the regulator for SENSE connections. Connecting SENSE to the load helps eliminate voltage errors resulting from trace resistance between OUT and the load.
3	EN	Input	Enable pin. Driving this pin to logic high enables the LDO. Driving this pin to logic low disables the LDO. If enable functionality is not required, EN must be connected to IN or BIAS.
4	BIAS	Input	BIAS pin. This pin enables operation in LILLO conditions. For best performance, use 0.47- μ F or larger ceramic capacitor from BIAS to ground. Place the bias capacitor as close to BIAS as possible.
5	GND	—	Ground pin. This pin must be connected to ground.
6	IN	Input	Input pin. A 0.75- μ F or greater capacitance is required from IN to ground for stability. Place the input capacitor as close to IN as possible.
Thermal Pad		—	The thermal pad is electrically connected to the GND node. Connect to the GND plane for improved thermal performance.

6 Specifications

6.1 Absolute Maximum Ratings

over operating free-air temperature range unless otherwise noted.⁽¹⁾

		MIN	MAX	UNIT
Voltage	Input, V_{IN}	-0.3	2.4	V
	Enable, V_{EN}	-0.3	6.0	
	Bias, V_{BIAS}	-0.3	6.0	
	Sense, V_{SENSE}	-0.3	$V_{IN} + 0.3$ ⁽²⁾	
	Output, V_{OUT}	-0.3	$V_{IN} + 0.3$ ⁽²⁾	
Current	Maximum output	Internally limited		A
Temperature	Operating junction, T_J	-40	150	°C
	Storage, T_{stg}	-65	150	°C

- Operation outside the Absolute Maximum Ratings may cause permanent device damage. Absolute maximum ratings do not imply functional operation of the device at these or any other conditions beyond those listed under Recommended Operating Conditions. If briefly operating outside the Recommended Operating Conditions but within the Absolute Maximum Ratings, the device may not sustain damage, but it may not be fully functional. Operating the device in this manner may affect device reliability, functionality, performance, and shorten the device lifetime.
- The absolute maximum rating is 2.4 V or ($V_{IN} + 0.3$ V), whichever is less.

6.2 ESD Ratings

			VALUE	UNIT
$V_{(ESD)}$	Electrostatic discharge	Human-body model (HBM), per ANSI/ESDA/JEDEC JS-001 ⁽¹⁾	±3000	V
		Charged-device model (CDM), per JEDEC specification JESD22-C101 ⁽²⁾	±750	

- JEDEC document JEP155 states that 500-V HBM allows safe manufacturing with a standard ESD control process.
- JEDEC document JEP157 states that 250-V CDM allows safe manufacturing with a standard ESD control process.

6.3 Recommended Operating Conditions

over operating junction temperature range (unless otherwise noted).⁽¹⁾

		MIN	NOM	MAX	UNIT
V_{IN}	Input voltage	0.7		2.2	V
V_{BIAS}	Bias voltage	Greater of 2.2 or $V_{OUT(NOM)} + 1.4$		5.5	V
V_{OUT}	Output voltage	0.5		2.0	V
I_{OUT}	Peak output current	0		1	A
C_{IN}	Input capacitance ⁽²⁾	0.75			µF
C_{BIAS}	Bias capacitance ⁽⁴⁾		0.1		µF
C_{OUT}	Output capacitance, DRV package	2.2		22	µF
C_{OUT}	Output capacitance, YBK package	2.2		47	µF
ESR	Output capacitor series resistance			100	mΩ
T_J	Operating junction temperature	-40		125	°C

- All voltages are with respect to GND.
- An input capacitor is required to counteract the effect of source resistance and inductance, which may in some cases cause symptoms of system level instability such as ringing or oscillation, especially in the presence of load transients. A larger input capacitor may be necessary depending on the source impedance and system requirements.
- A BIAS input capacitor is not required for LDO stability. However, a capacitor with a derated value of at least 0.1 µF is recommended to maintain transient, PSRR, and noise performance.

6.4 Thermal Information

THERMAL METRIC ⁽¹⁾		TPS7A14		UNIT
		WSN	DSBGA	
		6 PINS	6 PINS	
R _{θJA}	Junction-to-ambient thermal resistance	72.7	136.7	°C/W
R _{θJC(top)}	Junction-to-case (top) thermal resistance	84.9	1.1	°C/W
R _{θJB}	Junction-to-board thermal resistance	32.7	38.1	°C/W
Ψ _{JT}	Junction-to-top characterization parameter	3.2	0.5	°C/W
Ψ _{JB}	Junction-to-board characterization parameter	32.6	38.1	°C/W
R _{θJC(bot)}	Junction-to-case (bottom) thermal resistance	16.8	n/a	°C/W

(1) For more information about traditional and new thermal metrics, see the [Semiconductor and IC Package Thermal Metrics](#) application report.

6.5 Electrical Characteristics

specified at T_J = –40°C to +125°C, V_{IN} = V_{OUT(NOM)} + 0.1 V, V_{BIAS} = greater of 2.2 V or V_{OUT(NOM)} + 1.4 V, I_{OUT} = 1 mA, V_{EN} = 1.0 V, C_{IN} = 1 μF, C_{OUT} = 2.2 μF, and C_{BIAS} = 0.1 μF (unless otherwise noted); all typical values are at T_J = 25°C

PARAMETER	TEST CONDITIONS	MIN	TYP	MAX	UNIT		
V _{OUT}	Accuracy over temperature V _{OUT(NOM)} + 0.1 V ≤ V _{IN} ≤ 2.2 V, Greater of 2.2 V or V _{OUT(NOM)} + 1.4 V ≤ V _{BIAS} ≤ 5.5 V, 1 mA ≤ I _{OUT} ≤ 1 A	T _J = –40°C to +125°C, DRV package	–1.25		1	%	
		T _J = –40°C to +125°C, YBK package	–1.5		1		
		T _J = –40°C to +85°C	–1		1		
ΔV _{OUT} / ΔV _{IN}	V _{IN} line regulation V _{OUT(NOM)} + 0.1 V ≤ V _{IN} ≤ 2.2 V, DRV package V _{OUT(NOM)} + 0.1 V ≤ V _{IN} ≤ 2.2 V, T _J = –40°C to +85°C, YBK package		–3		3	mV	
			–2.5		2.5		
ΔV _{OUT} / ΔV _{BIAS}	V _{BIAS} line regulation V _{OUT(NOM)} + 1.4 V ≤ V _{BIAS} ≤ 5.5 V, DRV package V _{OUT(NOM)} + 1.4 V ≤ V _{BIAS} ≤ 5.5 V, T _J = –40°C to +85°C, YBK package		–3	±0.15	3	mV	
			–2.5	±0.15	2.5		
ΔV _{OUT} / ΔI _{OUT}	Load regulation 1 mA ≤ I _{OUT} ≤ 1 A		0.2			%/A	
I _{Q(BIAS)}	Bias pin current	I _{OUT} = 0 mA, DRV package			43	μA	
		I _{OUT} = 0 mA, T _J = –40°C to +85°C, YBK package			26		
		I _{OUT} = 1 A, DRV package			17	mA	
		I _{OUT} = 1 A, T _J = –40°C to +85°C, YBK package			12		
I _{Q(IN)}	Input pin current ⁽¹⁾	I _{OUT} = 0 mA, DRV package			118	μA	
		I _{OUT} = 0 mA, T _J = –40°C to +85°C			5.7		
I _{GND}	Ground pin current	I _{OUT} = 1 A, DRV package		480	660	μA	
		I _{OUT} = 1 A, T _J = –40°C to +85°C		480	620		
I _{SHDN(BIAS)}	V _{BIAS} shutdown current	V _{IN} = 2.2 V, V _{BIAS} = 5.5 V, V _{EN} ≤ 0.2 V, DRV package		0.3	9	μA	
		V _{IN} = 2.2 V, V _{BIAS} = 5.5 V, V _{EN} ≤ 0.2 V, T _J = –40°C to +85°C		0.3	3.8		
I _{SHDN(IN)}	V _{IN} shutdown current	V _{IN} = 1.8 V, V _{BIAS} = 5.5 V, V _{EN} ≤ 0.2 V, DRV package		1	41	μA	
		V _{IN} = 1.8 V, V _{BIAS} = 5.5 V, V _{EN} ≤ 0.2 V, T _J = –40°C to +85°C		1	9.2		
I _{CL}	Output current limit	V _{OUT} = 0.95 × V _{OUT(NOM)}	1.035	1.6	2.45	A	
I _{SC}	Short circuit current limit	V _{OUT} = 0 V		600		mA	
V _{DO(IN)}	V _{IN} dropout voltage ⁽²⁾	V _{IN} = 0.95 × V _{OUT(NOM)} , I _{OUT} = 1 A	T _J = –40°C to + 125°C		99	mV	
			T _J = –40°C to + 85°C, DRV package				77
			T _J = –40°C to + 85°C, YBK package				70

6.5 Electrical Characteristics (continued)

specified at $T_J = -40^\circ\text{C}$ to $+125^\circ\text{C}$, $V_{IN} = V_{OUT(NOM)} + 0.1\text{ V}$, V_{BIAS} = greater of 2.2 V or $V_{OUT(NOM)} + 1.4\text{ V}$, $I_{OUT} = 1\text{ mA}$, $V_{EN} = 1.0\text{ V}$, $C_{IN} = 1\text{ }\mu\text{F}$, $C_{OUT} = 2.2\text{ }\mu\text{F}$, and $C_{BIAS} = 0.1\text{ }\mu\text{F}$ (unless otherwise noted); all typical values are at $T_J = 25^\circ\text{C}$

PARAMETER	TEST CONDITIONS	MIN	TYP	MAX	UNIT		
$V_{DO(BIAS)}$	V_{BIAS} dropout voltage ⁽²⁾	V_{BIAS} = greater of 1.7V or $V_{OUT(nom)} + 0.6\text{ V}$, $V_{SENSE} = 0.95 \times V_{OUT(nom)}$, $I_{OUT} = 1\text{ A}$, DRV package		1.115	V		
		V_{BIAS} = greater of 1.7V or $V_{OUT(nom)} + 0.6\text{ V}$, $V_{SENSE} = 0.95 \times V_{OUT(nom)}$, $I_{OUT} = 1\text{ A}$, YBK package		1.1			
V_{IN} PSRR	V_{IN} power-supply rejection ratio	f = 100 Hz	$I_{OUT} = 3\text{ mA}$	90	dB		
			$I_{OUT} = 500\text{ mA}$	80			
			$I_{OUT} = 1\text{ A}$	80			
		f = 1 kHz	$I_{OUT} = 3\text{ mA}$	90			
			$I_{OUT} = 500\text{ mA}$	80			
			$I_{OUT} = 1\text{ A}$	70			
		f = 10 kHz	$I_{OUT} = 3\text{ mA}$	70			
			$I_{OUT} = 500\text{ mA}$	60			
			$I_{OUT} = 1\text{ A}$	50			
		f = 100 kHz	$I_{OUT} = 3\text{ mA}$	60			
			$I_{OUT} = 500\text{ mA}$	43			
			$I_{OUT} = 1\text{ A}$	33			
f = 1 MHz	$I_{OUT} = 3\text{ mA}$	60					
	$I_{OUT} = 500\text{ mA}$	24					
	$I_{OUT} = 1\text{ A}$	15					
f = 1 MHz, $V_{IN} = V_{OUT} + 150\text{ mV}$	$I_{OUT} = 3\text{ mA}$	69					
	$I_{OUT} = 500\text{ mA}$	42					
	$I_{OUT} = 1\text{ A}$	33					
V_{BIAS} PSRR	V_{BIAS} power-supply rejection ratio	$I_{OUT} = 500\text{ mA}$	f = 1 kHz	65	dB		
			f = 100 kHz	45			
			f = 1 MHz	25			
V_n	Output voltage noise	Bandwidth = 10 Hz to 100 kHz, $V_{OUT} = 0.8\text{ V}$, $5\text{ mA} \leq I_{OUT} \leq 1\text{ A}$		7.2	μV_{RMS}		
$V_{UVLO(BIAS)}$	Bias supply UVLO	V_{BIAS} rising	1.15	1.42	1.7	V	
		V_{BIAS} falling	1.0	1.3	1.63		
$V_{UVLO_HYST(BIAS)}$	Bias supply hysteresis	V_{BIAS} hysteresis		100	mV		
$V_{UVLO(IN)}$	Input supply UVLO	V_{IN} rising	584	603	623	mV	
		V_{IN} falling	530	552	566		
$V_{UVLO_HYST(IN)}$	Input supply hysteresis	V_{IN} hysteresis		50	mV		
t_{STR}	Start-up time ⁽³⁾			186	μs		
$V_{EN(HI)}$	EN pin logic high voltage ⁽⁴⁾			0.6	6	V	
$V_{EN(LOW)}$	EN pin logic low voltage ⁽⁴⁾			0	0.25	V	
I_{EN}	EN pin current	$V_{IN} = 5.5\text{ V}$, DRV package		-25	10	25	nA
		$V_{IN} = 5.5\text{ V}$, $T_J = -40^\circ\text{C}$ to $+85^\circ\text{C}$		-20	10	20	
$R_{PULLDOWN}$	Pulldown resistor	$V_{IN} = 0.9\text{ V}$, $V_{OUT(nom)} = 0.8\text{ V}$, $V_{BIAS} = 1\text{ V}$, $V_{EN} = 0\text{ V}$, P version only		36		Ω	
T_{SD}	Thermal shutdown temperature	Shutdown, temperature rising		165	°C		
		Reset, temperature falling		140			

- (1) This is the current flowing from V_{IN} to GND.
- (2) Dropout is not measured for $V_{OUT} < 0.6\text{ V}$. V_{BIAS} dropout applies only for V_{BIAS} of 2.2 V or greater.
- (3) Startup time = time from EN assertion to $0.95 \times V_{OUT(NOM)}$.
- (4) An input voltage within the minimum to maximum range is interpreted as the correct logic level.

6.6 Switching Characteristics

specified at $T_J = -40^\circ\text{C}$ to $+125^\circ\text{C}$, $V_{IN} = V_{OUT(NOM)} + 0.1\text{ V}$, $V_{BIAS} = \text{greater of } 2.2\text{ V or } V_{OUT(NOM)} + 1.4\text{ V}$, $I_{OUT} = 1\text{ mA}$, $V_{EN} = 1.0\text{ V}$, $C_{IN} = 1\text{ }\mu\text{F}$, $C_{OUT} = 2.2\text{ }\mu\text{F}$, and $C_{BIAS} = 0.1\text{ }\mu\text{F}$ (unless otherwise noted); all typical values are at $T_J = 25^\circ\text{C}$; all transients values are over multiple load or line pulses with periods of $100\mu\text{s}$ on (high load) and $100\mu\text{s}$ off (low load)

PARAMETER		TEST CONDITIONS		MIN	TYP	MAX	UNIT
ΔV_{OUT}	Line transient ⁽¹⁾	$V_{IN} = (V_{OUT(NOM)} + 0.1\text{ V})$ to 2.1 V	Transition time, $t_R = 1\text{ V} / \mu\text{s}$			1	% V_{OUT}
		$V_{IN} = 2.1\text{ V}$ to $(V_{OUT(NOM)} + 0.1\text{ V})$	Transition time, $t_F = 1\text{ V} / \mu\text{s}$	-1			
ΔV_{OUT}	Load transient ⁽¹⁾	$I_{OUT} = 3\text{ mA}$ to 600 mA	Transition time, $t_R = 20\text{ }\mu\text{s}$, $t_F = 20\text{ }\mu\text{s}$, $t_{OFF} = 200\text{ }\mu\text{s}$, $t_{ON} = 1\text{ ms}$, $C_{IN} = 5\text{ }\mu\text{F}$, $C_{OUT} = 5\text{ }\mu\text{F}$	-2			% V_{OUT}
		$I_{OUT} = 600\text{ mA}$ to 3 mA					

(1) This specification is verified by design.

6.7 Typical Characteristics

at operating temperature $T_J = 25^\circ\text{C}$, $V_{\text{OUT(NOM)}} = 0.8\text{ V}$, $V_{\text{IN}} = V_{\text{OUT(NOM)}} + 0.1\text{ V}$, $V_{\text{BIAS}} = V_{\text{OUT(NOM)}} + 1.4\text{ V}$, $I_{\text{OUT}} = 1\text{ mA}$, $V_{\text{EN}} = V_{\text{IN}}$, $C_{\text{IN}} = 2.2\text{ }\mu\text{F}$, $C_{\text{OUT}} = 2.2\text{ }\mu\text{F}$, and $C_{\text{BIAS}} = 0.47\text{ }\mu\text{F}$ (unless otherwise noted)

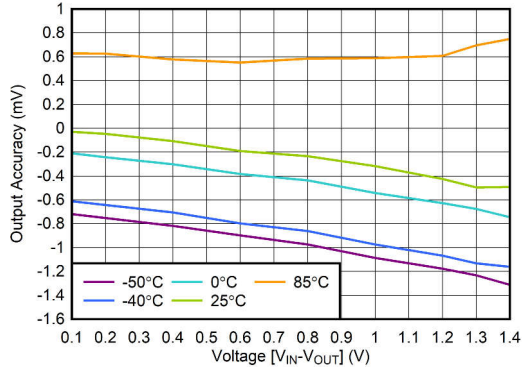

Figure 6-1. Output Voltage Accuracy vs V_{IN}

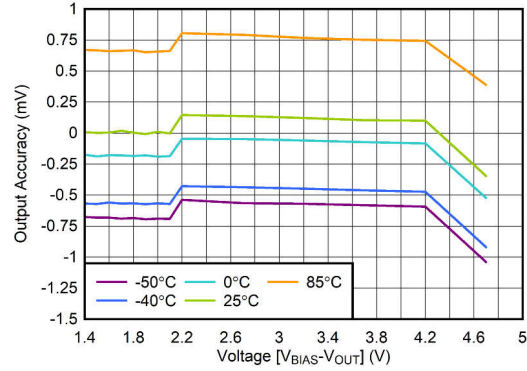

Figure 6-2. Output Voltage Accuracy vs V_{BIAS}

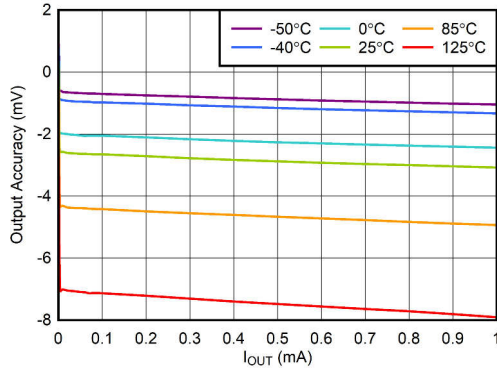

Figure 6-3. Output Voltage Accuracy vs I_{OUT}

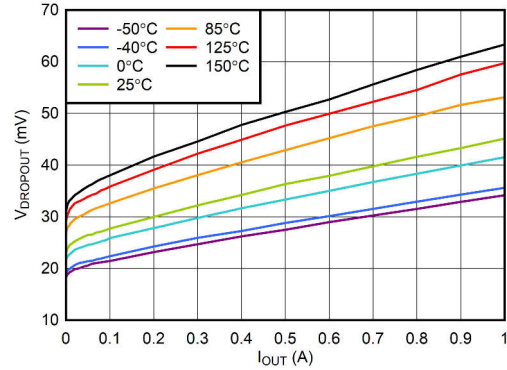

Figure 6-4. V_{IN} Dropout Voltage vs I_{OUT}

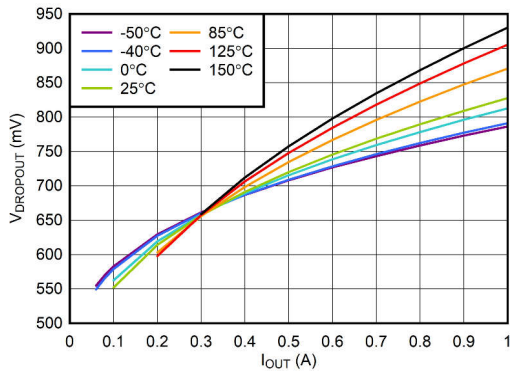

Figure 6-5. V_{BIAS} Dropout Voltage vs I_{OUT}

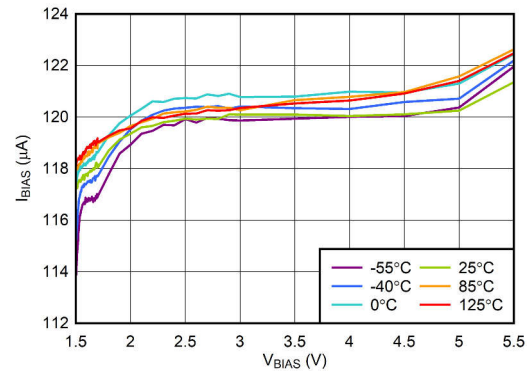

Figure 6-6. V_{BIAS} Input Current vs V_{BIAS}

6.7 Typical Characteristics (continued)

at operating temperature $T_J = 25^\circ\text{C}$, $V_{\text{OUT(NOM)}} = 0.8\text{ V}$, $V_{\text{IN}} = V_{\text{OUT(NOM)}} + 0.1\text{ V}$, $V_{\text{BIAS}} = V_{\text{OUT(NOM)}} + 1.4\text{ V}$, $I_{\text{OUT}} = 1\text{ mA}$, $V_{\text{EN}} = V_{\text{IN}}$, $C_{\text{IN}} = 2.2\text{ }\mu\text{F}$, $C_{\text{OUT}} = 2.2\text{ }\mu\text{F}$, and $C_{\text{BIAS}} = 0.47\text{ }\mu\text{F}$ (unless otherwise noted)

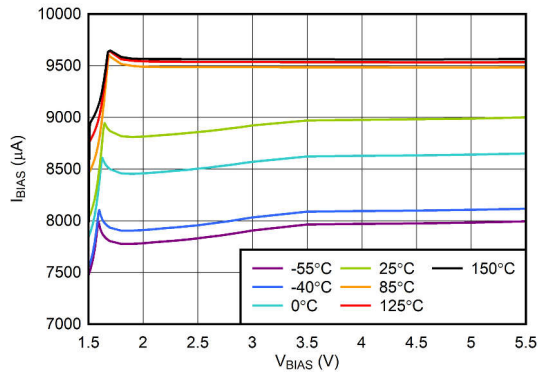

Figure 6-7. V_{BIAS} Input Current vs V_{BIAS}

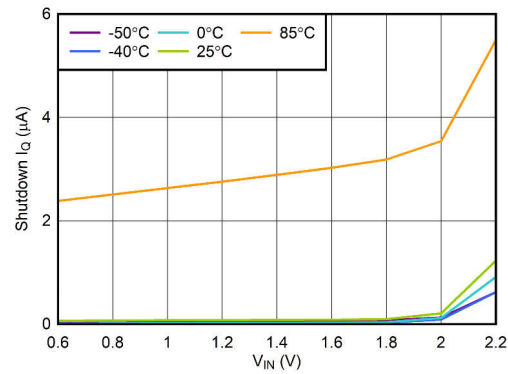

Figure 6-8. V_{IN} Shutdown I_{Q} vs V_{IN}

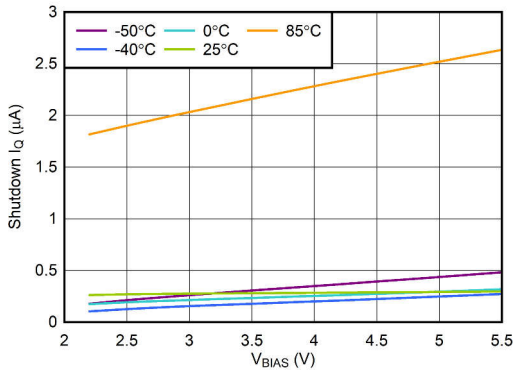

Figure 6-9. V_{BIAS} Shutdown I_{Q} vs V_{BIAS}

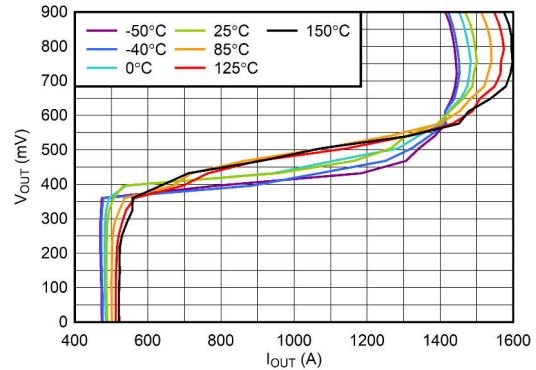

Figure 6-10. V_{OUT} Foldback Current Limit vs Output Current

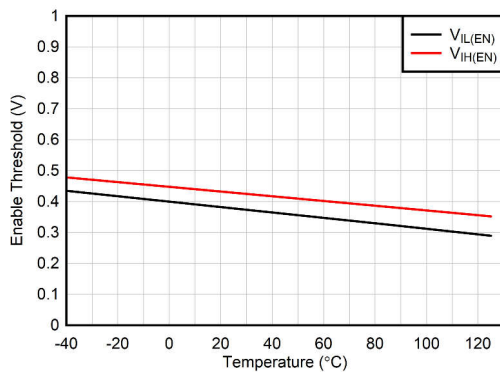

Figure 6-11. Enable Threshold vs Temperature

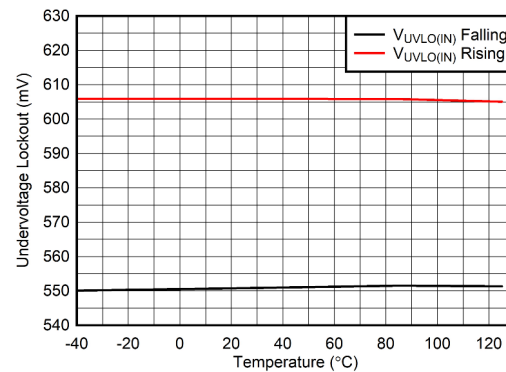

Figure 6-12. V_{IN} UVLO vs Temperature

6.7 Typical Characteristics (continued)

at operating temperature $T_J = 25^\circ\text{C}$, $V_{OUT(NOM)} = 0.8\text{ V}$, $V_{IN} = V_{OUT(NOM)} + 0.1\text{ V}$, $V_{BIAS} = V_{OUT(NOM)} + 1.4\text{ V}$, $I_{OUT} = 1\text{ mA}$, $V_{EN} = V_{IN}$, $C_{IN} = 2.2\text{ }\mu\text{F}$, $C_{OUT} = 2.2\text{ }\mu\text{F}$, and $C_{BIAS} = 0.47\text{ }\mu\text{F}$ (unless otherwise noted)

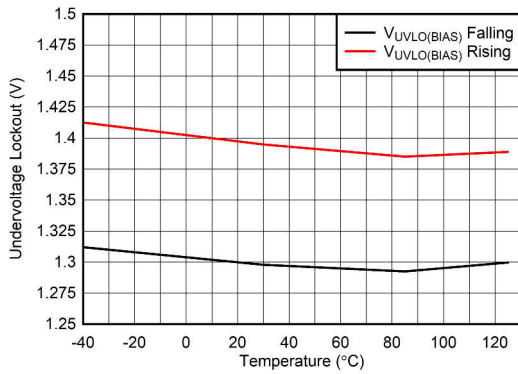
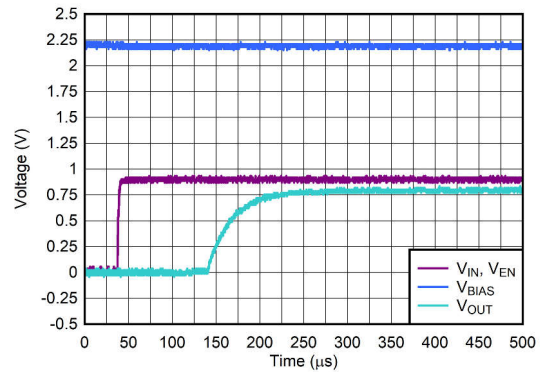
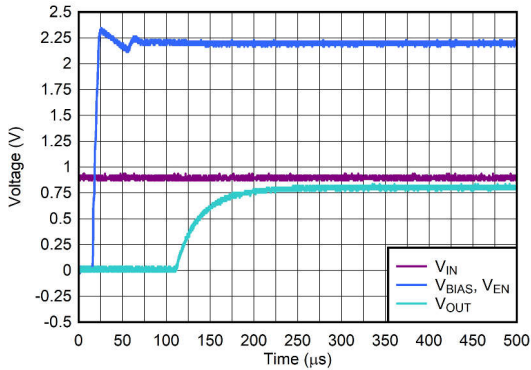

Figure 6-13. V_{BIAS} UVLO vs Temperature



$t_r = 1\text{ }\mu\text{s}$

Figure 6-14. Start-Up With V_{BIAS} Before V_{IN}



$t_r = 1\text{ }\mu\text{s}$

Figure 6-15. Start-Up With V_{IN} Before V_{BIAS} and V_{EN}

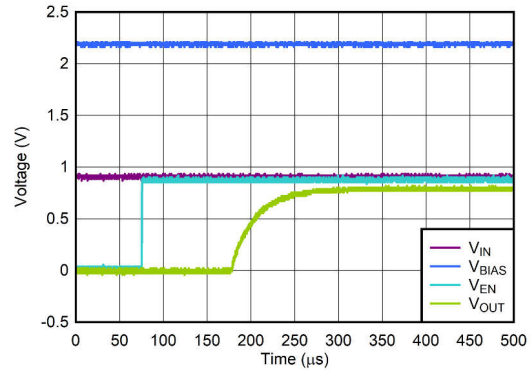

$t_r = 1\text{ }\mu\text{s}$

Figure 6-16. Start-Up With V_{IN} and V_{BIAS} Before V_{EN}

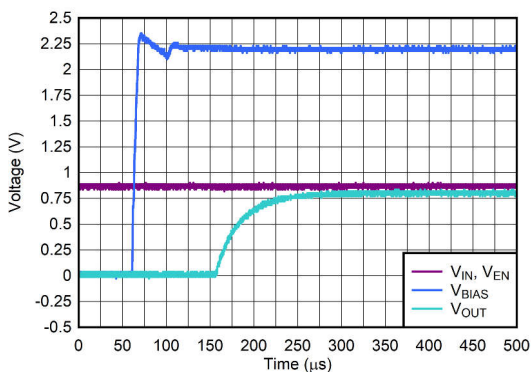

$t_r = 1\text{ }\mu\text{s}$

Figure 6-17. Start-Up With V_{IN} and V_{EN} Before V_{BIAS}

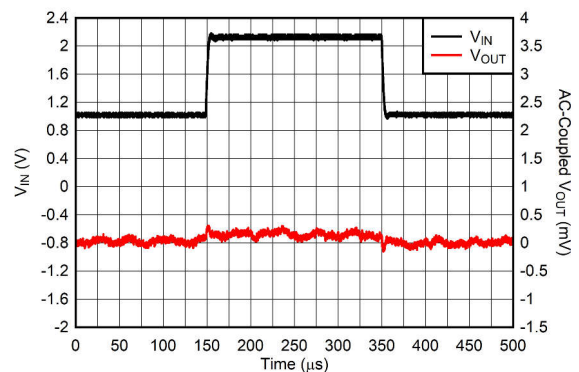

$t_r = t_f = 10\text{ }\mu\text{s}$, $I_{OUT} = 1\text{ mA}$

Figure 6-18. Line Transient From 1 V to 2.2 V

6.7 Typical Characteristics (continued)

at operating temperature $T_J = 25^\circ\text{C}$, $V_{OUT(NOM)} = 0.8\text{ V}$, $V_{IN} = V_{OUT(NOM)} + 0.1\text{ V}$, $V_{BIAS} = V_{OUT(NOM)} + 1.4\text{ V}$, $I_{OUT} = 1\text{ mA}$, $V_{EN} = V_{IN}$, $C_{IN} = 2.2\text{ }\mu\text{F}$, $C_{OUT} = 2.2\text{ }\mu\text{F}$, and $C_{BIAS} = 0.47\text{ }\mu\text{F}$ (unless otherwise noted)

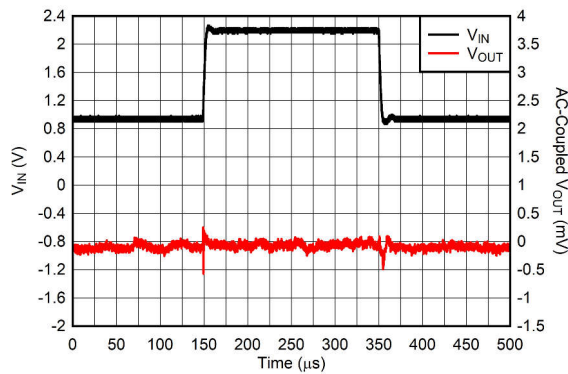

$t_r = t_f = 10\text{ }\mu\text{s}$, $I_{OUT} = 500\text{ mA}$

Figure 6-19. Line Transient From 1 V to 2.2 V

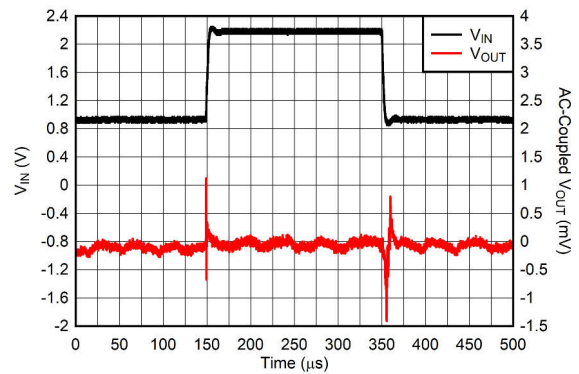

$t_r = t_f = 10\text{ }\mu\text{s}$, $I_{OUT} = 1\text{ A}$

Figure 6-20. Line Transient From 1 V to 2.2 V

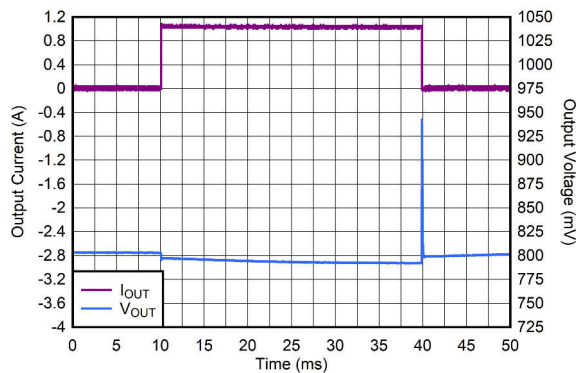

$t_r = t_f = 1\text{ }\mu\text{s}$

Figure 6-21. Load Transient From 100 μA to 1 A

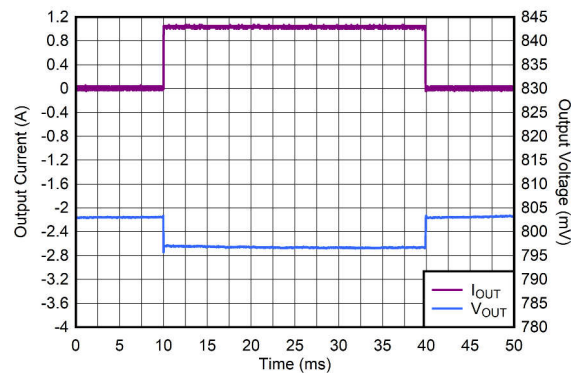

$t_r = t_f = 20\text{ }\mu\text{s}$

Figure 6-22. Load Transient From 100 μA to 1 A

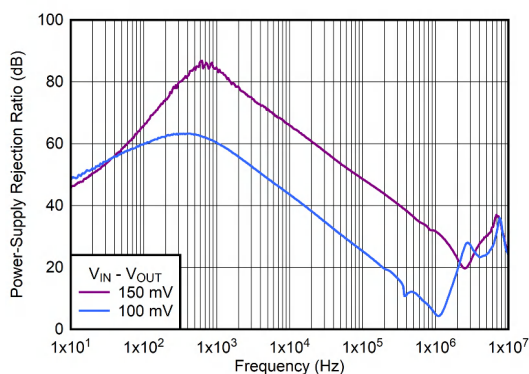

$C_{BIAS} = 0\text{ }\mu\text{F}$, $I_{OUT} = 1\text{ A}$

Figure 6-23. PSRR vs Frequency and $V_{IN} - V_{OUT}$

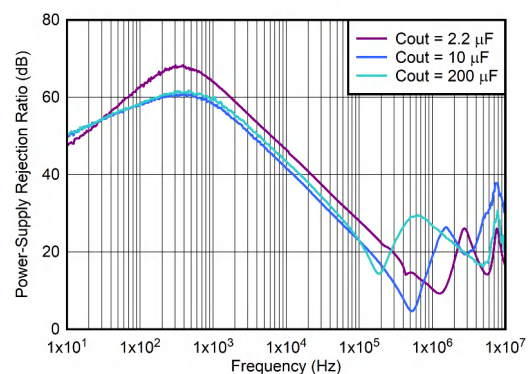

$C_{BIAS} = 0\text{ }\mu\text{F}$, $I_{OUT} = 1\text{ A}$

Figure 6-24. PSRR vs Frequency and C_{OUT}

6.7 Typical Characteristics (continued)

at operating temperature $T_J = 25^\circ\text{C}$, $V_{OUT(NOM)} = 0.8\text{ V}$, $V_{IN} = V_{OUT(NOM)} + 0.1\text{ V}$, $V_{BIAS} = V_{OUT(NOM)} + 1.4\text{ V}$, $I_{OUT} = 1\text{ mA}$, $V_{EN} = V_{IN}$, $C_{IN} = 2.2\text{ }\mu\text{F}$, $C_{OUT} = 2.2\text{ }\mu\text{F}$, and $C_{BIAS} = 0.47\text{ }\mu\text{F}$ (unless otherwise noted)

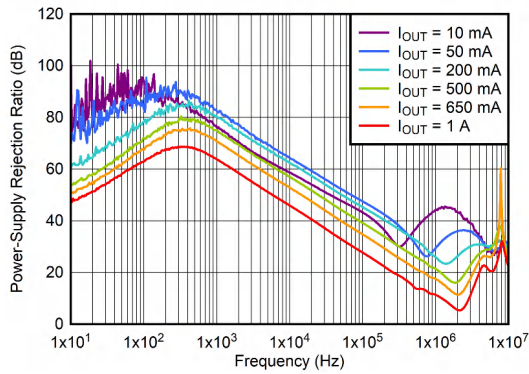

Figure 6-25. PSRR vs Frequency and I_{OUT}

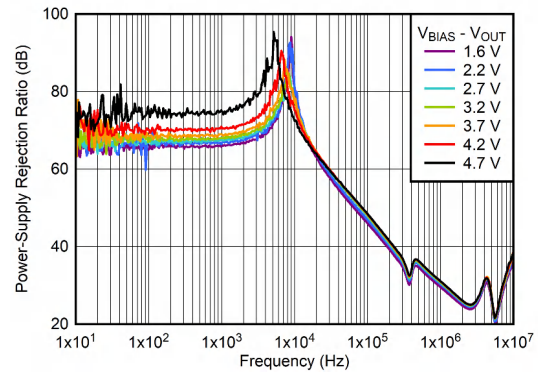

Figure 6-26. PSRR vs Frequency and $V_{BIAS} - V_{OUT}$

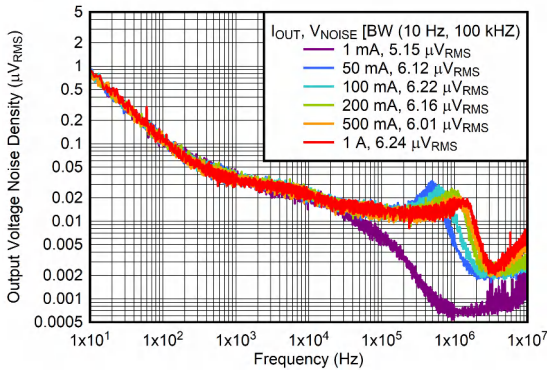

Figure 6-27. Output Noise vs Frequency and I_{OUT}

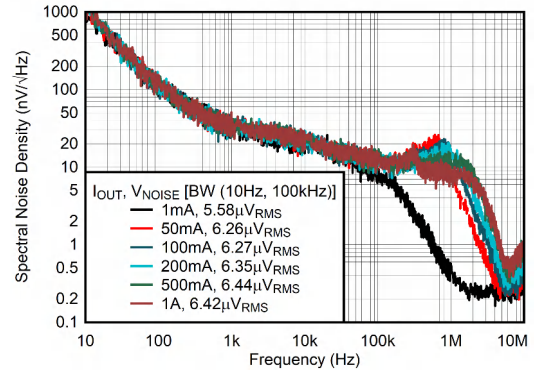

Figure 6-28. Output Noise vs Frequency and I_{OUT}

7 Detailed Description

7.1 Overview

The TPS7A14 is a low-input, ultra-low dropout, low-quiescent-current linear regulator that is optimized for excellent transient performance. These characteristics make the device designed for most battery-powered applications. The low operating $V_{IN} - V_{OUT}$, combined with the BIAS pin, dramatically improve the efficiency of low-voltage output applications by powering the voltage reference and control circuitry and allowing the use of a pre-regulated, low-voltage input supply (IN) for the main power path. This low-dropout regulator (LDO) offers foldback current limit, shutdown, thermal protection, and an optional active discharge.

7.2 Functional Block Diagram

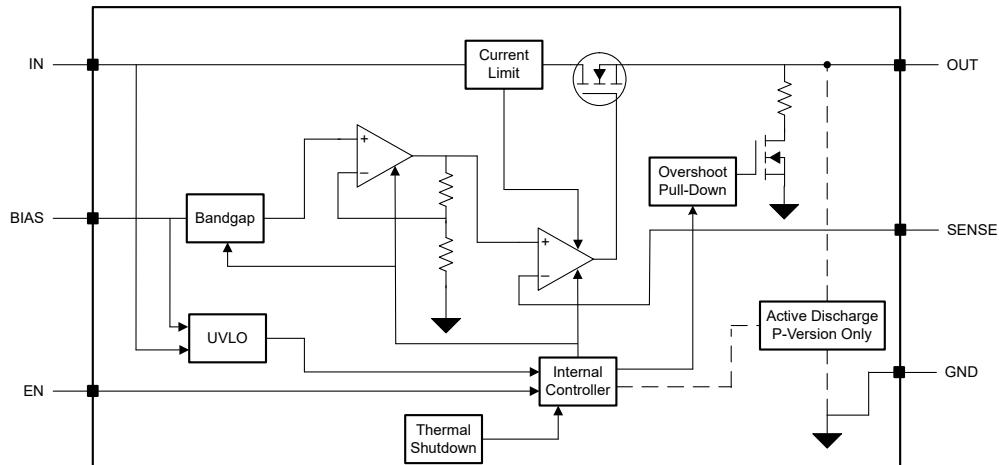

7.3 Feature Description

7.3.1 Excellent Transient Response

The TPS7A14 responds quickly to a change on the input supply (line transient) or the output current (load transient) given the device high input impedance and low output impedance across frequency. This same capability also means that this LDO has a high power-supply rejection ratio (PSRR) and, when coupled with a low internal noise floor (e_n), the LDO can be used to create an excellent power supply with outstanding line and load transient performance.

The choice of external component values optimizes the transient response; see the [Input, Output, and Bias Capacitor Requirements](#) section for proper capacitor selection.

7.3.2 Global Undervoltage Lockout (UVLO)

The TPS7A14 uses two undervoltage lockout circuits: one on the BIAS pin and one on the IN pin to prevent the device from turning on before both V_{BIAS} and V_{IN} rise above their lockout voltages. The two UVLO signals are connected internally through an AND gate, as shown in [Figure 7-1](#), that turns off the device when the voltage on either input is below their respective UVLO thresholds.

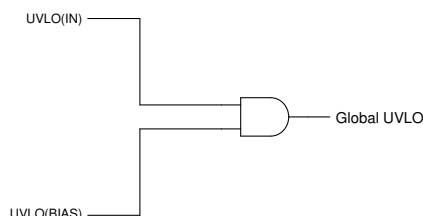

Figure 7-1. Global UVLO circuit

7.3.3 Enable Input

The enable input (EN) is active high. Applying a voltage greater than $V_{EN(HI)}$ to EN enables the regulator output voltage, and applying a voltage less than $V_{EN(LOW)}$ to EN disables the regulator output. If independent control of the output voltage is not needed, connect EN to either IN or BIAS.

7.3.4 Internal Foldback Current Limit

The device has an internal current limit circuit that protects the regulator during transient high-load current faults or shorting events. The current limit is a hybrid brick-wall foldback scheme. The current limit transitions from a brick-wall scheme to a foldback scheme at the foldback voltage ($V_{FOLDBACK}$). In a high-load current fault with the output voltage above $V_{FOLDBACK}$, the brick-wall scheme limits the output current to the current limit (I_{CL}). When the voltage drops below $V_{FOLDBACK}$, a foldback current limit activates that scales back the current as the output voltage approaches GND. When the output is shorted, the device supplies a typical current called the short-circuit current limit (I_{SC}). I_{CL} and I_{SC} are listed in the [Electrical Characteristics](#) table.

For this device, $V_{FOLDBACK}$ is approximately $60\% \times V_{OUT(nom)}$.

The output voltage is not regulated when the device is in current limit. When a current limit event occurs, the device begins to heat up because of the increase in power dissipation. When the device is in brick-wall current limit, the pass transistor dissipates power $[(V_{IN} - V_{OUT}) \times I_{CL}]$. When the device output is shorted and the output is below $V_{FOLDBACK}$, the pass transistor dissipates power $[(V_{IN} - V_{OUT}) \times I_{SC}]$. If thermal shutdown is triggered, the device turns off. After the device cools down, the internal thermal shutdown circuit turns the device back on. If the output current fault condition continues, the device cycles between current limit and thermal shutdown. For more information on current limits, see the [Know Your Limits application report](#).

Figure 7-2 shows a diagram of the foldback current limit.

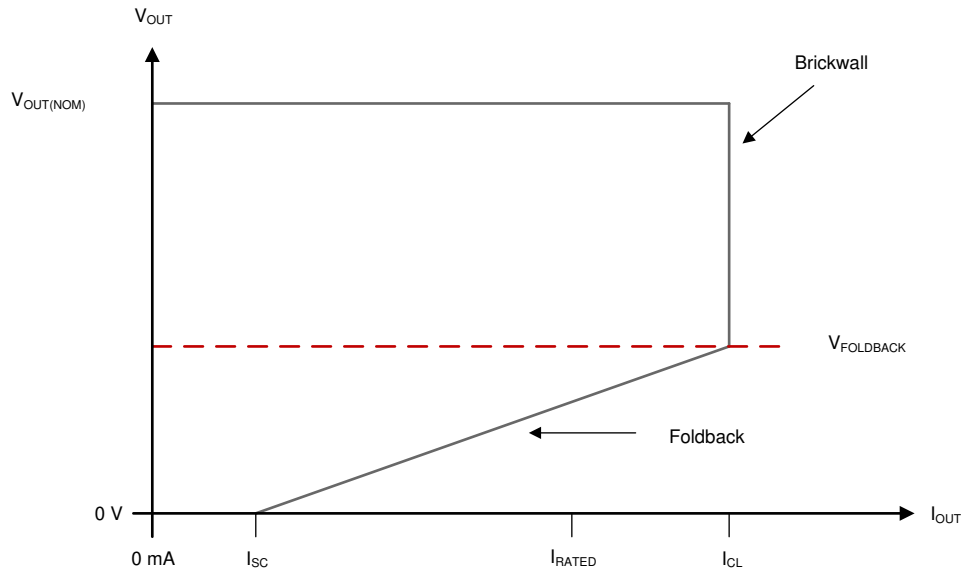

Figure 7-2. Foldback Current Limit

7.3.5 Active Discharge

The active discharge function uses an internal MOSFET that connects a resistor ($R_{PULLDOWN}$) to ground when the LDO is disabled in order to actively discharge the output voltage. The active discharge circuit is activated by driving EN to logic low to disable the device, when the voltage at IN or BIAS is below the UVLO threshold, or when the regulator is in thermal shutdown.

The discharge time after disabling the device depends on the output capacitance (C_{OUT}) and the load resistance (R_L) in parallel with the pull-down resistor.

Do not rely on the active discharge circuit for discharging a large amount of output capacitance after the input supply has collapsed because reverse current can flow from the output to the input. This reverse current flow can cause damage to the device. Limit reverse current to no more than 5% of the rated output current for a short period of time.

7.3.6 Thermal Shutdown

The internal thermal shutdown protection circuit disables the output when the thermal junction temperature (T_J) of the pass transistor rises to the thermal shutdown temperature threshold, $T_{SD(shutdown)}$ (typical). The thermal shutdown circuit hysteresis makes sure that the LDO resets (turns on) when the temperature falls to $T_{SD(reset)}$ (typical).

The thermal time constant of the semiconductor die is fairly short; thus, the device can cycle on and off when thermal shutdown is reached until the power dissipation is reduced. Power dissipation during start up can be high from large $V_{IN} - V_{OUT}$ voltage drops across the device or from high inrush currents charging large output capacitors. Under some conditions, the thermal shutdown protection disables the device before start up completes.

For reliable operation, limit the junction temperature to the maximum listed in the [Recommended Operating Conditions](#) table. Operation above this maximum temperature causes the device to exceed operational specifications. Although the internal protection circuitry is designed to protect against thermal overload conditions, this circuitry is not intended to replace proper heat sinking. Continuously running the regulator into thermal shutdown or above the maximum recommended junction temperature reduces long-term reliability.

7.4 Device Functional Modes

Table 7-1 shows the conditions that lead to the different modes of operation. See the [Electrical Characteristics](#) table for parameter values.

Table 7-1. Device Functional Mode Comparison

OPERATING MODE	PARAMETER				
	V _{IN}	V _{BIAS}	V _{EN}	I _{OUT}	T _J
Normal mode	V _{IN} ≥ V _{OUT (nom)} + V _{DO} and V _{IN} ≥ V _{IN(min)}	V _{BIAS} ≥ V _{OUT} + V _{DO(BIAS)}	V _{EN} ≥ V _{IH(EN)}	I _{OUT} < I _{CL}	T _J < T _{SD} for shutdown
Dropout mode	V _{IN(min)} < V _{IN} < V _{OUT (nom)} + V _{DO(IN)}	V _{BIAS} < V _{OUT} + V _{DO(BIAS)}	V _{EN} > V _{IH(EN)}	I _{OUT} < I _{CL}	T _J < T _{SD} for shutdown
Disabled mode (any true condition disables the device)	V _{IN} < V _{UVLO(IN)}	V _{BIAS} < V _{BIAS(UVLO)}	V _{EN} < V _{IL(EN)}	—	T _J ≥ T _{SD} for shutdown

7.4.1 Normal Operation

The device regulates to the nominal output voltage when the following conditions are met:

- The input voltage is greater than the nominal output voltage plus the dropout voltage (V_{OUT(nom)} + V_{DO})
- The bias voltage is greater than the nominal output voltage plus the dropout voltage (V_{OUT(nom)} + V_{DO})
- The output current is less than the current limit (I_{OUT} < I_{CL})
- The device junction temperature is less than the thermal shutdown temperature (T_J < T_{SD(shutdown)})
- The enable voltage has previously exceeded the enable rising threshold voltage and has not yet decreased to less than the enable falling threshold

7.4.2 Dropout Operation

If the input voltage is lower than the nominal output voltage plus the specified dropout voltage, but all other conditions are met for normal operation, the device operates in dropout mode. Similarly, if the bias voltage is lower than the nominal output voltage plus the specified dropout voltage, but all other conditions are met for normal operation, the device operates in dropout mode as well. In this mode, the output voltage tracks the input voltage. During this mode, the transient performance of the device becomes significantly degraded because the pass transistor is in the ohmic or triode region, and acts as a switch. Line or load transients in dropout can result in large output voltage deviations.

When the device is in a steady dropout state, defined as when the device is in dropout, (V_{IN} < V_{OUT} + V_{DO} or V_{BIAS} < V_{OUT} + V_{DO} directly after being in normal regulation state, but not during start up), the pass transistor is driven into the ohmic or triode region. When the input voltage returns to a value greater than or equal to the nominal output voltage plus the dropout voltage (V_{OUT(NOM)} + V_{DO}), the output voltage can overshoot for a short time when the device pulls the pass transistor back into the linear region.

7.4.3 Disable Mode

The output of the device can be shutdown by forcing the voltage of the enable pin to less than V_{IL(EN)} (see the [Electrical Characteristics](#) table). When disabled, the pass transistor is turned off, internal circuits are shutdown, and the output voltage is actively discharged to ground by an internal discharge circuit from the output to ground.

8 Application and Implementation

Note

Information in the following applications sections is not part of the TI component specification, and TI does not warrant its accuracy or completeness. TI's customers are responsible for determining suitability of components for their purposes, as well as validating and testing their design implementation to confirm system functionality.

8.1 Application Information

Successfully implementing an LDO in a system depends on the system requirements. This section discusses key device features and how to best implement them to achieve a reliable design.

8.1.1 Recommended Capacitor Types

The regulator is designed to be stable using low equivalent series resistance (ESR) ceramic capacitors at the input, output, and bias pins. Multilayer ceramic capacitors are the industry standard for use with LDOs, but must be used with good judgment. Ceramic capacitors that use X7R-, X5R-, and COG-rated dielectric materials provide relatively good capacitive stability across temperature, whereas the use of Y5V-rated capacitors is discouraged because of large variations in capacitance. Regardless of the ceramic capacitor type selected, ceramic capacitance varies with operating voltage and temperature. Generally, assume that effective capacitance decreases by as much as 50%. The input, output, and bias capacitors recommended in the [Recommended Operating Conditions](#) table account for an effective capacitance of approximately 50% of the nominal value.

8.1.2 Input, Output, and Bias Capacitor Requirements

A minimum input ceramic capacitor is required for stability. A minimum output ceramic capacitor is also required for stability, see the [Recommended Operating Conditions](#) table for the minimum capacitors values.

The input capacitor counteracts reactive input sources and improves transient response, input ripple, and PSRR. A higher-value input capacitor can be necessary if large, fast rise-time load or line transients are anticipated, or if the device is located several inches from the input power source. Dynamic performance of the device is improved with the use of an output capacitor larger than the minimum value specified in the [Recommended Operating Conditions](#) table.

Although a bias capacitor is not required, good design practice is to connect a 0.1- μ F ceramic capacitor from BIAS to GND. This capacitor counteracts reactive bias source if the source impedance is not sufficiently low. Place the input, output, and bias capacitors as close as possible to the device to minimize trace parasitics.

If the BIAS source is susceptible to fast voltage drops (for example, a 2-V drop in less than 1 μ s) when the LDO load current is near the maximum value, the BIAS voltage drop can cause the output voltage to fall briefly. In such cases, use a BIAS capacitor large enough to slow the voltage ramp rate to less than 0.5 V/ μ s. For smaller or slower BIAS transients, any output voltage dips must be less than 5% of the nominal voltage.

8.1.3 Dropout Voltage

Dropout voltage (V_{DO}) is defined as the input voltage minus the output voltage ($V_{IN} - V_{OUT}$) at the rated output current (I_{RATED}), where the pass transistor is fully on. I_{RATED} is the maximum I_{OUT} listed in the [Recommended Operating Conditions](#) table. The pass transistor is in the ohmic or triode region of operation, and acts as a switch. The dropout voltage indirectly specifies a minimum input voltage greater than the nominal programmed output voltage at which the output voltage is expected to stay in regulation. If the input voltage falls to less than the nominal output regulation, then the output voltage falls as well.

For a CMOS regulator, the dropout voltage is determined by the drain-source on-state resistance ($R_{DS(ON)}$) of the pass transistor. Therefore, if the linear regulator operates at less than the rated current, the dropout voltage for that current scales accordingly. Use [Equation 1](#) to calculate the $R_{DS(ON)}$ of the device.

$$R_{DS(ON)} = \frac{V_{DO}}{I_{RATED}} \quad (1)$$

The use of bias rail enables the TPS7A14 to achieve a lower dropout voltage between IN and OUT. However, a minimum bias voltage above the nominal programmed output voltage must be maintained. [Figure 6-13](#) specifies the minimum V_{BIAS} headroom required to maintain output regulation.

8.1.4 Behavior During Transition From Dropout Into Regulation

Some applications can have transients that place this device into dropout, especially when this device can be powered from a battery with relatively high ESR. The load transient saturates the output stage of the error amplifier when the pass transistor is driven fully on, making the pass transistor function like a resistor from V_{IN} to V_{OUT} . The error amplifier response time to this load transient is extended because the error amplifier must first recover from saturation and then must place the pass transistor back into active mode. During this recovery period, V_{OUT} overshoots because the pass transistor is functioning as a resistor from V_{IN} to V_{OUT} .

When V_{IN} ramps up slowly for start up, the slow ramp-up voltage can place the device in dropout. As with many other LDOs, the output can overshoot on recovery from this condition. However, this condition is easily avoided through the use of the enable signal.

If operating under these conditions, apply a higher dc load current or increase the output capacitance to reduce the overshoot. These approaches provide a path to absorb the excess charge.

8.1.5 Device Enable Sequencing Requirement

The IN, BIAS, and EN pin voltages can be sequenced in any order without causing damage to the device. Start up is always monotonic regardless of the sequencing order or the ramp rates of the IN, BIAS, and EN pins. See the [Recommended Operating Conditions](#) table for proper voltage ranges of the IN, BIAS, and EN pins.

8.1.6 Load Transient Response

The load-step transient response is the output voltage response by the LDO to a step in load current while output voltage regulation is maintained. See [Figure 6-21](#) and [Figure 6-22](#) for typical load transient response plots. There are two key transitions during a load transient response: the transition from a light to a heavy load, and the transition from a heavy to a light load. The regions in [Figure 8-1](#) are broken down as described in this section. Regions A, E, and H are where the output voltage is in steady-state operation.

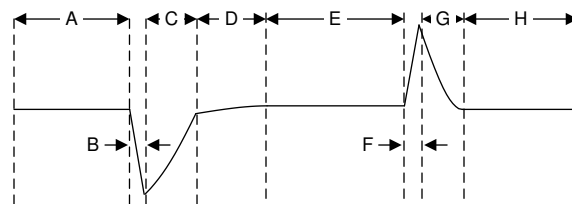

Figure 8-1. Load Transient Waveform

During transitions from a light load to a heavy load, the following behavior can be observed:

- The initial voltage dip is a result of the depletion of the output capacitor charge and parasitic impedance to the output capacitor (region B)
- Recovery from the dip results from the LDO increasing the sourcing current, and leads to output voltage regulation (region C)

During transitions from a heavy load to a light load, the following behavior can be observed:

- The initial voltage rise results from the LDO sourcing a large current, and leads to an increase in the output capacitor charge (region F)
- Recovery from the rise results from the LDO decreasing the sourcing current in combination with the load discharging the output capacitor (region G)

A larger output capacitance reduces the peaks during a load transient but slows down the response time of the device. A larger dc load also reduces the peaks because the amplitude of the transition is lowered and a higher current discharge path is provided for the output capacitor.

8.1.7 Undervoltage Lockout Circuit Operation

The V_{IN} UVLO circuit makes sure that the regulator remains disabled when the input supply voltage is below the minimum operational voltage range, and makes sure that the regulator shuts down when the input supply collapses. Similarly, the V_{BIAS} UVLO circuit makes sure that the regulator remains disabled when the bias supply voltage is less than the minimum operational voltage range, and makes sure that the regulator shuts down when the bias supply collapses.

Figure 8-2 shows the UVLO circuit response to various input or bias voltage events. The diagram can be separated into the following parts:

- Region A: The output remains off while the input or bias voltage is below the UVLO rising threshold
- Region B: Normal operation, regulating device
- Region C: Brownout event above the UVLO falling threshold (UVLO rising threshold – UVLO hysteresis). The output can possibly fall out of regulation but the device remains enabled.
- Region D: Normal operation, regulating device
- Region E: Brownout event below the UVLO falling threshold. The device is disabled in most cases and the output falls as a result of the load and active discharge circuit. The device is re-enabled when the UVLO rising threshold is reached and a normal start up follows.
- Region F: Normal operation followed by the input or bias falling to the UVLO falling threshold
- Region G: The device is disabled when the input or bias voltages fall below the UVLO falling threshold to 0 V. The output falls as a result of the load and active discharge circuit.

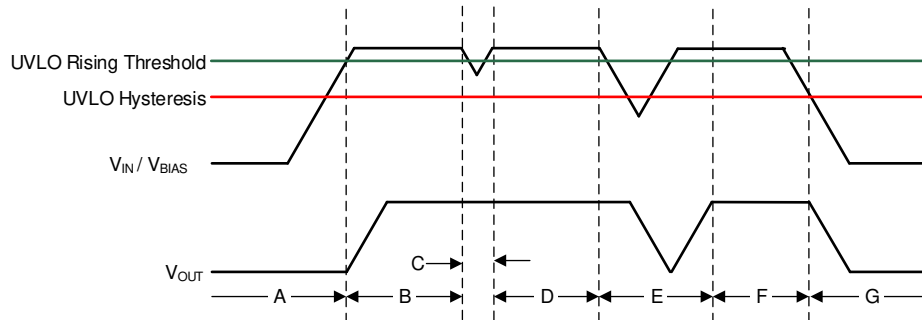

Figure 8-2. Typical V_{IN} or V_{BIAS} UVLO Circuit Operation

8.1.8 Power Dissipation (P_D)

Circuit reliability demands that proper consideration be given to device power dissipation, location of the circuit on the printed circuit board (PCB), and correct sizing of the thermal plane. The PCB area around the regulator must be as free as possible of other heat-generating devices that cause added thermal stresses.

Equation 2 calculates the maximum allowable power dissipation for the device in a given package:

$$P_{D-MAX} = [(T_J - T_A) / R_{\theta JA}] \quad (2)$$

Equation 3 represents the actual power being dissipated in the device:

$$P_D = ((I_{GND(IN)} + I_{IN}) \times V_{IN} + I_{GND(BIAS)} \times V_{BIAS}) - (I_{OUT} \times V_{OUT}) \quad (3)$$

If the load current is much greater than $I_{GND(IN)}$ and $I_{GND(BIAS)}$ Equation 3 can be simplified as:

$$P_D = (V_{IN} - V_{OUT}) \times I_{OUT} \quad (4)$$

Power dissipation can be minimized, and thus greater efficiency achieved, by proper selection of the system voltage rails. Proper selection allows the minimum input-to-output voltage differential to be obtained. The low dropout of the TPS7A14 allows for maximum efficiency across a wide range of output voltages.

The main heat conduction path depends on the ambient temperature and the thermal resistance across the various interfaces between the die junction and ambient air.

The maximum allowable junction temperature (T_J) determines the maximum power dissipation for the device. According to [Equation 5](#), maximum power dissipation and junction temperature are most often related by the junction-to-ambient thermal resistance ($R_{\theta JA}$) of the combined PCB and device package and the temperature of the ambient air (T_A). The equation is rearranged in [Equation 6](#) for output current.

$$T_J = T_A + (R_{\theta JA} \times P_D) \quad (5)$$

$$I_{OUT} = (T_J - T_A) / [R_{\theta JA} \times (V_{IN} - V_{OUT})] \quad (6)$$

Unfortunately, this thermal resistance ($R_{\theta JA}$) is highly dependent on the heat-spreading capability built into the particular PCB design, and therefore varies according to the total copper area, copper weight, and location of the planes. The $R_{\theta JA}$ recorded in the [Electrical Characteristics](#) table is determined by the JEDEC standard, PCB, and copper-spreading area, and is only used as a relative measure of package thermal performance. For a well-designed thermal layout, $R_{\theta JA}$ is actually the sum of the YBK package junction-to-case (bottom) thermal resistance ($R_{\theta JC(bot)}$) plus the thermal resistance contribution by the PCB copper.

8.1.9 Estimating Junction Temperature

The JEDEC standard now recommends the use of psi (Ψ) thermal metrics to estimate the junction temperatures of the LDO when in-circuit on a typical PCB board application. These metrics are not strictly speaking thermal resistances, but rather offer practical and relative means of estimating junction temperatures. These psi metrics are determined to be significantly independent of the copper-spreading area. The key thermal metrics (Ψ_{JT} and Ψ_{JB}) are used in accordance with [Equation 7](#) and are given in the [Electrical Characteristics](#) table.

$$\Psi_{JT} : T_J = T_T + \Psi_{JT} \times P_D \text{ and } \Psi_{JB} : T_J = T_B + \Psi_{JB} \times P_D \quad (7)$$

where:

- P_D is the power dissipated as explained in [Equation 3](#) and the [Power Dissipation \(\$P_D\$ \)](#) section
- T_T is the temperature at the center-top of the device package
- T_B is the PCB surface temperature measured 1 mm from the device package and centered on the package edge

8.1.10 Recommended Area for Continuous Operation

The operational area of an LDO is limited by the dropout voltage, output current, junction temperature, and input voltage. The recommended area for continuous operation for a linear regulator is provided in [Figure 8-3](#) and can be separated into the following regions:

- Dropout voltage limits the minimum differential voltage between the input and the output ($V_{IN} - V_{OUT}$) at a given output current level; see the [Dropout Operation](#) section for more details.
- The rated output current limits the maximum recommended output current level. Exceeding this rating causes the device to fall out of specification.
- The rated junction temperature limits the maximum junction temperature of the device. Exceeding this rating causes the device to fall out of specification and reduces long-term reliability.
 - [Equation 6](#) provides the shape of the slope. The slope is nonlinear because the maximum rated junction temperature of the LDO is controlled by the power dissipation across the LDO, thus when $V_{IN} - V_{OUT}$ increases the output current must decrease.
- The rated input voltage range governs both the minimum and maximum of $V_{IN} - V_{OUT}$.

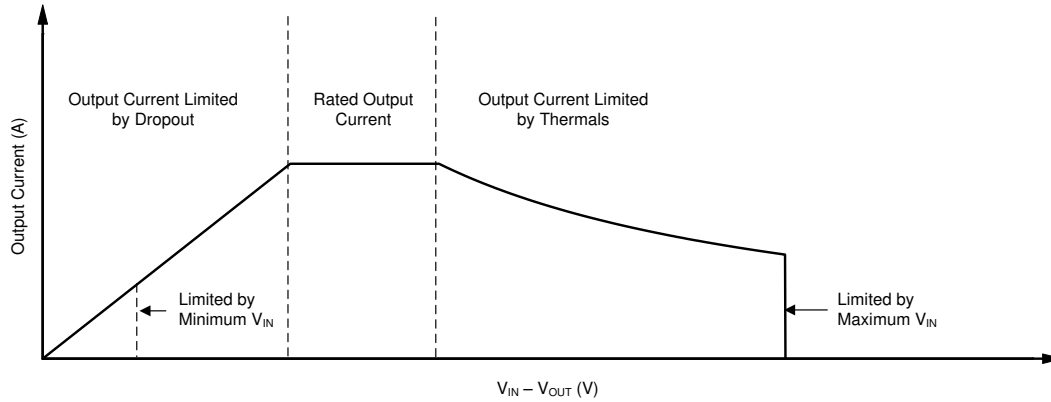

Figure 8-3. Continuous Operation Diagram With Description of Regions

8.2 Typical Application

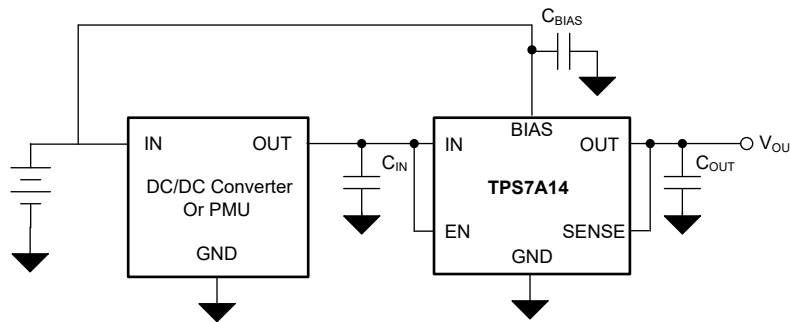

Figure 8-4. High-Efficiency Supply From a Rechargeable Battery

8.2.1 Design Requirements

Table 8-1 lists the parameters for this design example.

Table 8-1. Design Parameters

DESIGN PARAMETER	EXAMPLE VALUE
V_{IN}	0.95 V
V_{BIAS}	2.4 V to 5.5 V
V_{OUT}	0.8 V
I_{OUT}	600 mA (typical), 900 mA (peak)

8.2.2 Detailed Design Procedure

This design example is powered by a rechargeable battery that can be a building block in many portable applications. Noise-sensitive portable electronics require an efficient, small-size solution for their power supply. Traditional LDOs are known for their low efficiency in contrast to low-input, low-output voltage (LILO) LDOs such as the TPS7A14. The use of a bias rail in the TPS7A14 allows the main power path of the LDO to operate at a lower input voltage, thus reducing the voltage drop across the pass transistor and maximizing device efficiency. Because the voltage drop across the pass transistor can be so low, the efficiency of the TPS7A14 can approximate that of a dc-dc converter. Equation 8 calculates the efficiency for this design.

$$\text{Efficiency} = \eta = P_{OUT} / P_{IN} \times 100 \% = (V_{OUT} \times I_{OUT}) / (V_{IN} \times I_{IN} + V_{BIAS} \times I_{BIAS}) \times 100 \% \quad (8)$$

Equation 8 reduces to Equation 9 because the design example load current is much greater than the quiescent current of the bias rail.

$$\text{Efficiency} = \eta = (V_{OUT} \times I_{OUT}) / (V_{IN} \times I_{IN}) \times 100\% \quad (9)$$

8.2.3 Application Curve

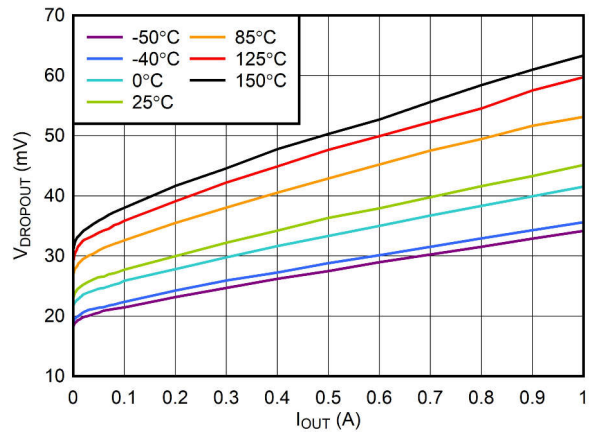

$$V_{BIAS} = V_{OUT(NOM)} + 1.4 \text{ V}, V_{EN} = V_{IN}, C_{IN} = 2.2 \mu\text{F}, C_{OUT} = 2.2 \mu\text{F}, \text{ and } C_{BIAS} = 0.47 \mu\text{F}$$

Figure 8-5. V_{IN} Dropout Voltage vs I_{OUT}

8.3 Power Supply Recommendations

This device is designed to operate from an input supply voltage range of 0.6 V to 2.2 V and a bias supply voltage range of 1.5 V to 5.5 V. The input and bias supplies must be well regulated and free of spurious noise. To make sure that the output voltage is well regulated and dynamic performance is optimum, the input supply must be at least $V_{OUT(nom)} + V_{DO}$ and $V_{BIAS} = V_{OUT(nom)} + V_{DO(BIAS)}$.

8.4 Layout

8.4.1 Layout Guidelines

For correct printed circuit board (PCB) layout, follow these guidelines:

- Place input, output, and bias capacitors as close to the device as possible
- Use copper planes for device connections to optimize thermal performance
- Place thermal vias around the device to distribute heat

8.4.2 Layout Examples

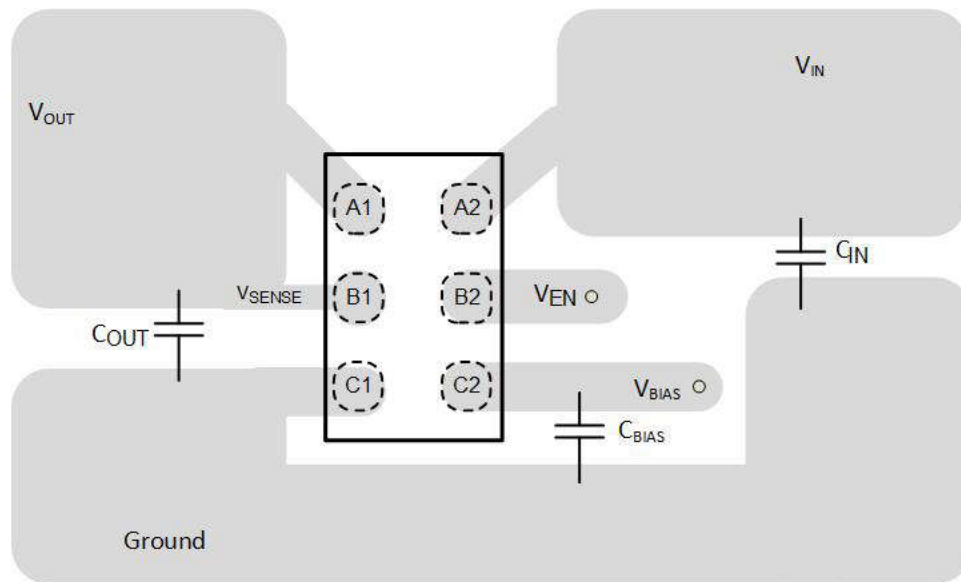

Figure 8-6. Recommended Layout (YBK Package)

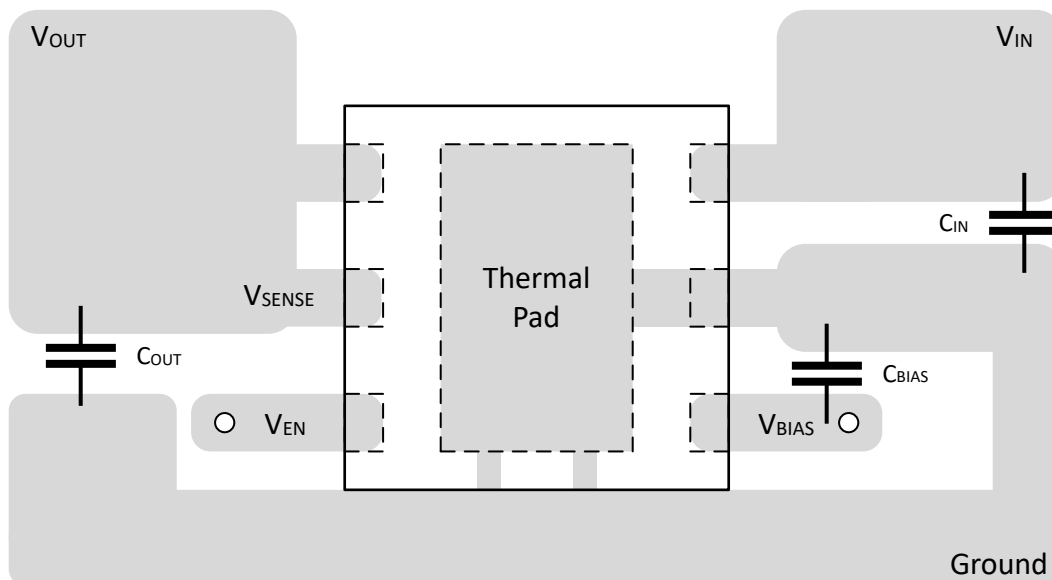

Figure 8-7. Recommended Layout (DRV Package)

9 Device and Documentation Support

9.1 Device Support

9.1.1 Development Support

9.1.1.1 Evaluation Module

An evaluation module (EVM) is available to assist in the initial circuit performance evaluation using the TPS7A14. The EVM can be requested at the Texas Instruments web site through the [product folder](#) or purchased directly from the TI eStore.

9.1.2 Device Nomenclature

Table 9-1. Device Nomenclature⁽¹⁾⁽²⁾

PRODUCT	DESCRIPTION
TPS7A14xx(x)(P)yyyz	<p>xx(x) is the nominal output voltage. Two or more digits are used in the ordering number (for example, 09 = 0.9 V, 95 = 0.95 V, 125 = 1.25 V).</p> <p>P indicates active pull down; if there is no P, then the device does not have the active pull down feature.</p> <p>yyy is the package designator.</p> <p>z is the package quantity. R indicates reel (12000 pieces for YBK package; 3000 pieces for DRV package).</p>

- (1) For the most current package and ordering information see the Package Option Addendum at the end of this document, or visit the device product folder on www.ti.com.
- (2) Output voltages from 0.5 V to 2.0 V in 25-mV increments are available. Contact the factory for details and availability.

9.2 Documentation Support

9.2.1 Related Documentation

For related documentation see the following:

- Texas Instruments, [Using New Thermal Metrics application report](#)
- Texas Instruments, [AN-1112 DSBGA Wafer Level Chip Scale Package application report](#)
- Texas Instruments, [TPS7A14EVM-058 Evaluation Module user guide](#)

9.3 Receiving Notification of Documentation Updates

To receive notification of documentation updates, navigate to the device product folder on ti.com. Click on *Subscribe to updates* to register and receive a weekly digest of any product information that has changed. For change details, review the revision history included in any revised document.

9.4 Support Resources

[TI E2E™ support forums](#) are an engineer's go-to source for fast, verified answers and design help — straight from the experts. Search existing answers or ask your own question to get the quick design help you need.

Linked content is provided "AS IS" by the respective contributors. They do not constitute TI specifications and do not necessarily reflect TI's views; see TI's [Terms of Use](#).

9.5 Trademarks

TI E2E™ is a trademark of Texas Instruments.

All trademarks are the property of their respective owners.

9.6 Electrostatic Discharge Caution



This integrated circuit can be damaged by ESD. Texas Instruments recommends that all integrated circuits be handled with appropriate precautions. Failure to observe proper handling and installation procedures can cause damage.

ESD damage can range from subtle performance degradation to complete device failure. Precision integrated circuits may be more susceptible to damage because very small parametric changes could cause the device not to meet its published specifications.

9.7 Glossary

[TI Glossary](#) This glossary lists and explains terms, acronyms, and definitions.

Mechanical, Packaging, and Orderable Information

The following pages include mechanical, packaging, and orderable information. This information is the most current data available for the designated devices. This data is subject to change without notice and revision of this document. For browser-based versions of this data sheet, refer to the left-hand navigation.

10.1 Mechanical Data

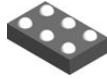

YBK0006-C02

PACKAGE OUTLINE

DSBGA - 0.33 mm max height

DIE SIZE BALL GRID ARRAY

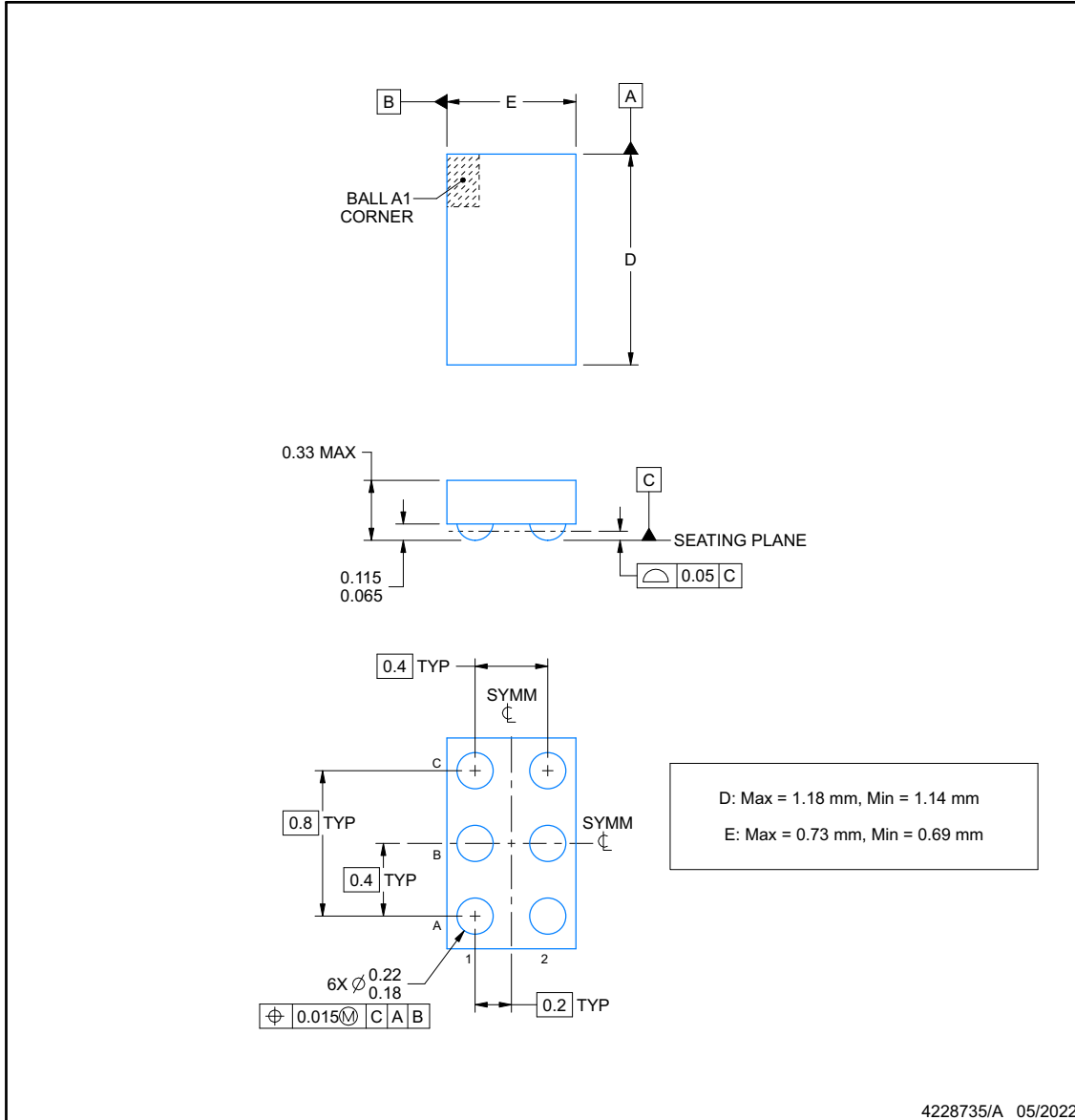

NOTES:

1. All linear dimensions are in millimeters. Any dimensions in parenthesis are for reference only. Dimensioning and tolerancing per ASME Y14.5M.
2. This drawing is subject to change without notice.

EXAMPLE BOARD LAYOUT

YBK0006-C02

DSBGA - 0.33 mm max height

DIE SIZE BALL GRID ARRAY

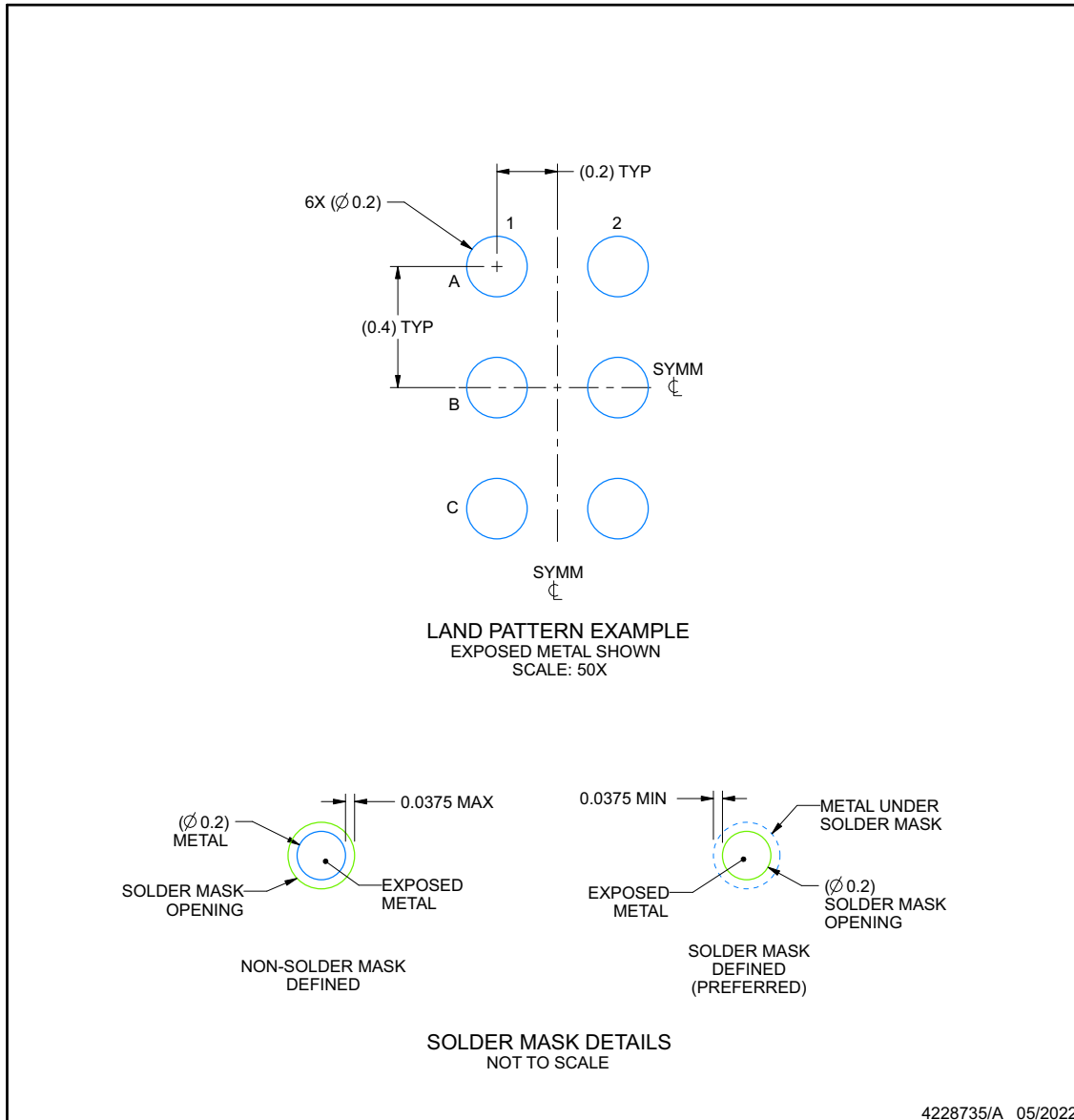

NOTES: (continued)

- Final dimensions may vary due to manufacturing tolerance considerations and also routing constraints. See Texas Instruments Literature No. SNVA009 (www.ti.com/lit/snva009).

EXAMPLE STENCIL DESIGN

YBK0006-C02

DSBGA - 0.33 mm max height

DIE SIZE BALL GRID ARRAY

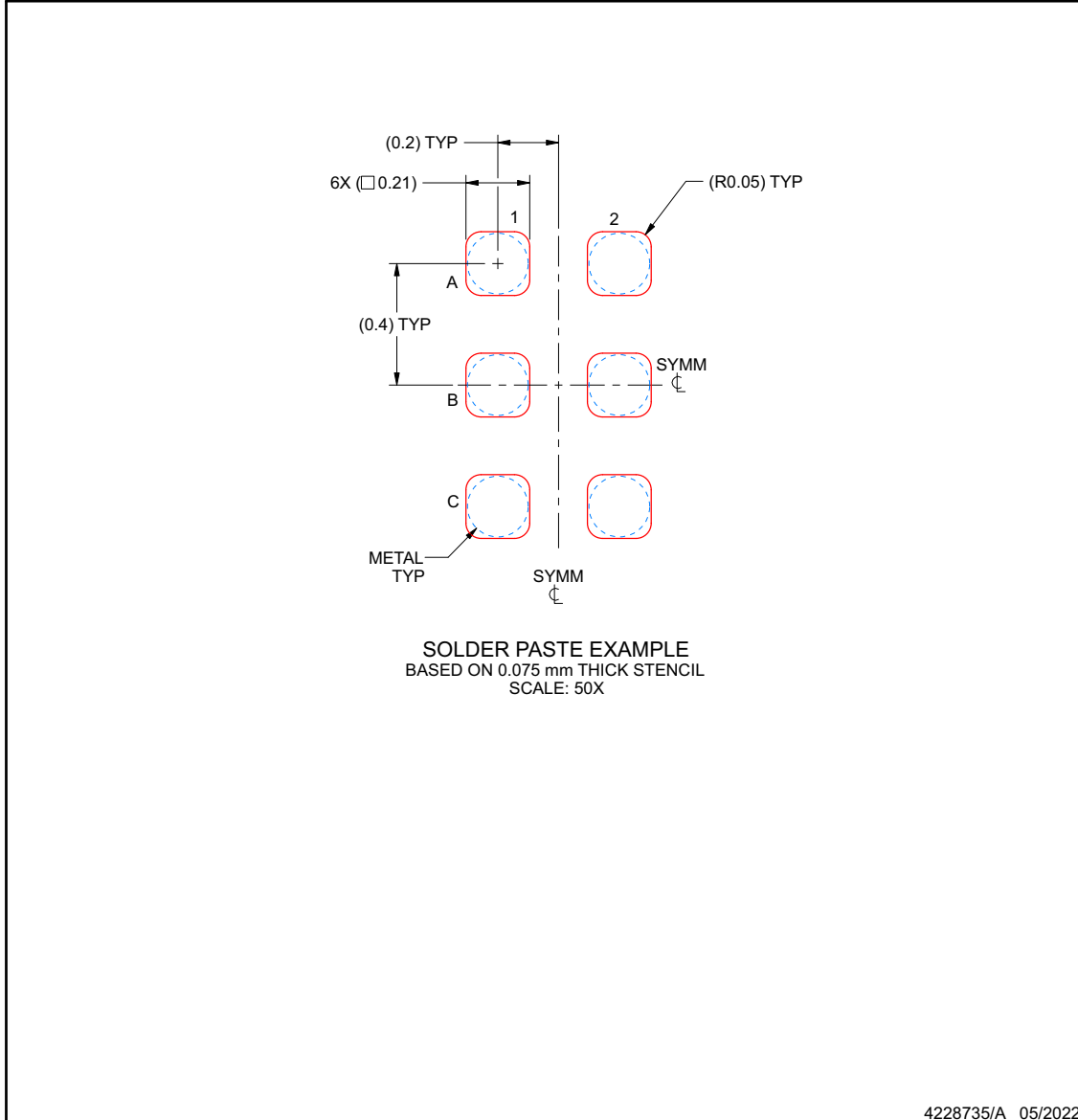

NOTES: (continued)

4. Laser cutting apertures with trapezoidal walls and rounded corners may offer better paste release.

PACKAGING INFORMATION

Orderable Device	Status (1)	Package Type	Package Drawing	Pins	Package Qty	Eco Plan (2)	Lead finish/ Ball material (6)	MSL Peak Temp (3)	Op Temp (°C)	Device Marking (4/5)	Samples
TPS7A1408PDRVR	ACTIVE	WSO	DRV	6	3000	RoHS & Green	NIPDAU	Level-1-260C-UNLIM	-40 to 125	33PH	Samples
TPS7A1408PYBKR	ACTIVE	DSBGA	YBK	6	12000	RoHS & Green	SNAGCU	Level-1-260C-UNLIM	-40 to 125	M8	Samples
TPS7A1409PDRVR	ACTIVE	WSO	DRV	6	3000	RoHS & Green	NIPDAU	Level-1-260C-UNLIM	-40 to 125	33QH	Samples
TPS7A1409PYBKR	ACTIVE	DSBGA	YBK	6	12000	RoHS & Green	SNAGCU	Level-1-260C-UNLIM	-40 to 125	MD	Samples
TPS7A14105PDRVR	ACTIVE	WSO	DRV	6	3000	RoHS & Green	NIPDAU	Level-1-260C-UNLIM	-40 to 125	33SH	Samples
TPS7A1410PDRVR	ACTIVE	WSO	DRV	6	3000	RoHS & Green	NIPDAU	Level-1-260C-UNLIM	-40 to 125	33RH	Samples
TPS7A1411PYBKR	ACTIVE	DSBGA	YBK	6	12000	RoHS & Green	SNAGCU	Level-1-260C-UNLIM	-40 to 125	P6	Samples
TPS7A1412PDRVR	ACTIVE	WSO	DRV	6	3000	RoHS & Green	NIPDAU	Level-1-260C-UNLIM	-40 to 125	33UH	Samples
TPS7A1412PYBKR	ACTIVE	DSBGA	YBK	6	12000	RoHS & Green	SNAGCU	Level-1-260C-UNLIM	-40 to 125	MG	Samples
TPS7A1413PYBKR	ACTIVE	DSBGA	YBK	6	12000	RoHS & Green	SNAGCU	Level-1-260C-UNLIM	-40 to 125	MH	Samples
TPS7A1418PDRVR	ACTIVE	WSO	DRV	6	3000	RoHS & Green	NIPDAU	Level-1-260C-UNLIM	-40 to 125	33WH	Samples
TPS7A1485PYBKR	ACTIVE	DSBGA	YBK	6	12000	RoHS & Green	SNAGCU	Level-1-260C-UNLIM	-40 to 125	M9	Samples
XS7A1408PDRVR	ACTIVE	WSO	DRV	6	3000	TBD	Call TI	Call TI	-40 to 125		Samples
XS7A1418PDRVR	ACTIVE	WSO	DRV	6	3000	TBD	Call TI	Call TI	-40 to 125		Samples

(1) The marketing status values are defined as follows:

ACTIVE: Product device recommended for new designs.

LIFEBUY: TI has announced that the device will be discontinued, and a lifetime-buy period is in effect.

NRND: Not recommended for new designs. Device is in production to support existing customers, but TI does not recommend using this part in a new design.

PREVIEW: Device has been announced but is not in production. Samples may or may not be available.

OBSELETE: TI has discontinued the production of the device.

(2) **RoHS:** TI defines "RoHS" to mean semiconductor products that are compliant with the current EU RoHS requirements for all 10 RoHS substances, including the requirement that RoHS substance do not exceed 0.1% by weight in homogeneous materials. Where designed to be soldered at high temperatures, "RoHS" products are suitable for use in specified lead-free processes. TI may reference these types of products as "Pb-Free".

RoHS Exempt: TI defines "RoHS Exempt" to mean products that contain lead but are compliant with EU RoHS pursuant to a specific EU RoHS exemption.

Green: TI defines "Green" to mean the content of Chlorine (Cl) and Bromine (Br) based flame retardants meet JS709B low halogen requirements of ≤ 1000 ppm threshold. Antimony trioxide based flame retardants must also meet the ≤ 1000 ppm threshold requirement.

(3) MSL, Peak Temp. - The Moisture Sensitivity Level rating according to the JEDEC industry standard classifications, and peak solder temperature.

(4) There may be additional marking, which relates to the logo, the lot trace code information, or the environmental category on the device.

(5) Multiple Device Markings will be inside parentheses. Only one Device Marking contained in parentheses and separated by a "~" will appear on a device. If a line is indented then it is a continuation of the previous line and the two combined represent the entire Device Marking for that device.

(6) Lead finish/Ball material - Orderable Devices may have multiple material finish options. Finish options are separated by a vertical ruled line. Lead finish/Ball material values may wrap to two lines if the finish value exceeds the maximum column width.

Important Information and Disclaimer: The information provided on this page represents TI's knowledge and belief as of the date that it is provided. TI bases its knowledge and belief on information provided by third parties, and makes no representation or warranty as to the accuracy of such information. Efforts are underway to better integrate information from third parties. TI has taken and continues to take reasonable steps to provide representative and accurate information but may not have conducted destructive testing or chemical analysis on incoming materials and chemicals. TI and TI suppliers consider certain information to be proprietary, and thus CAS numbers and other limited information may not be available for release.

In no event shall TI's liability arising out of such information exceed the total purchase price of the TI part(s) at issue in this document sold by TI to Customer on an annual basis.

TAPE AND REEL INFORMATION



QUADRANT ASSIGNMENTS FOR PIN 1 ORIENTATION IN TAPE



*All dimensions are nominal

Device	Package Type	Package Drawing	Pins	SPQ	Reel Diameter (mm)	Reel Width W1 (mm)	A0 (mm)	B0 (mm)	K0 (mm)	P1 (mm)	W (mm)	Pin1 Quadrant
TPS7A1408PDRVR	WSO	DRV	6	3000	180.0	8.4	2.3	2.3	1.15	4.0	8.0	Q2
TPS7A1408PYBKR	DSBGA	YBK	6	12000	180.0	8.4	0.8	1.26	0.36	2.0	8.0	Q1
TPS7A1408PYBKR	DSBGA	YBK	6	12000	180.0	8.4	0.8	1.26	0.36	2.0	8.0	Q1
TPS7A1409PDRVR	WSO	DRV	6	3000	180.0	8.4	2.3	2.3	1.15	4.0	8.0	Q2
TPS7A1409PYBKR	DSBGA	YBK	6	12000	180.0	8.4	0.8	1.26	0.36	2.0	8.0	Q1
TPS7A1409PYBKR	DSBGA	YBK	6	12000	180.0	8.4	0.8	1.26	0.36	2.0	8.0	Q1
TPS7A14105PDRVR	WSO	DRV	6	3000	180.0	8.4	2.3	2.3	1.15	4.0	8.0	Q2
TPS7A1410PDRVR	WSO	DRV	6	3000	180.0	8.4	2.3	2.3	1.15	4.0	8.0	Q2
TPS7A1411PYBKR	DSBGA	YBK	6	12000	180.0	8.4	0.8	1.26	0.36	2.0	8.0	Q1
TPS7A1412PDRVR	WSO	DRV	6	3000	180.0	8.4	2.3	2.3	1.15	4.0	8.0	Q2
TPS7A1412PYBKR	DSBGA	YBK	6	12000	180.0	8.4	0.8	1.26	0.36	2.0	8.0	Q1
TPS7A1412PYBKR	DSBGA	YBK	6	12000	180.0	8.4	0.8	1.26	0.36	2.0	8.0	Q1
TPS7A1413PYBKR	DSBGA	YBK	6	12000	180.0	8.4	0.8	1.26	0.36	2.0	8.0	Q1
TPS7A1413PYBKR	DSBGA	YBK	6	12000	180.0	8.4	0.8	1.26	0.36	2.0	8.0	Q1
TPS7A1418PDRVR	WSO	DRV	6	3000	180.0	8.4	2.3	2.3	1.15	4.0	8.0	Q2
TPS7A1485PYBKR	DSBGA	YBK	6	12000	180.0	8.4	0.8	1.26	0.36	2.0	8.0	Q1

Device	Package Type	Package Drawing	Pins	SPQ	Reel Diameter (mm)	Reel Width W1 (mm)	A0 (mm)	B0 (mm)	K0 (mm)	P1 (mm)	W (mm)	Pin1 Quadrant
TPS7A1485PYBKR	DSBGA	YBK	6	12000	180.0	8.4	0.8	1.26	0.36	2.0	8.0	Q1

TAPE AND REEL BOX DIMENSIONS

*All dimensions are nominal

Device	Package Type	Package Drawing	Pins	SPQ	Length (mm)	Width (mm)	Height (mm)
TPS7A1408PDRVR	WSON	DRV	6	3000	210.0	185.0	35.0
TPS7A1408PYBKR	DSBGA	YBK	6	12000	182.0	182.0	20.0
TPS7A1408PYBKR	DSBGA	YBK	6	12000	182.0	182.0	20.0
TPS7A1409PDRVR	WSON	DRV	6	3000	210.0	185.0	35.0
TPS7A1409PYBKR	DSBGA	YBK	6	12000	182.0	182.0	20.0
TPS7A1409PYBKR	DSBGA	YBK	6	12000	182.0	182.0	20.0
TPS7A14105PDRVR	WSON	DRV	6	3000	210.0	185.0	35.0
TPS7A1410PDRVR	WSON	DRV	6	3000	210.0	185.0	35.0
TPS7A1411PYBKR	DSBGA	YBK	6	12000	182.0	182.0	20.0
TPS7A1412PDRVR	WSON	DRV	6	3000	210.0	185.0	35.0
TPS7A1412PYBKR	DSBGA	YBK	6	12000	182.0	182.0	20.0
TPS7A1412PYBKR	DSBGA	YBK	6	12000	182.0	182.0	20.0
TPS7A1413PYBKR	DSBGA	YBK	6	12000	182.0	182.0	20.0
TPS7A1413PYBKR	DSBGA	YBK	6	12000	182.0	182.0	20.0
TPS7A1418PDRVR	WSON	DRV	6	3000	210.0	185.0	35.0
TPS7A1485PYBKR	DSBGA	YBK	6	12000	182.0	182.0	20.0
TPS7A1485PYBKR	DSBGA	YBK	6	12000	182.0	182.0	20.0

GENERIC PACKAGE VIEW

DRV 6

WSON - 0.8 mm max height

PLASTIC SMALL OUTLINE - NO LEAD

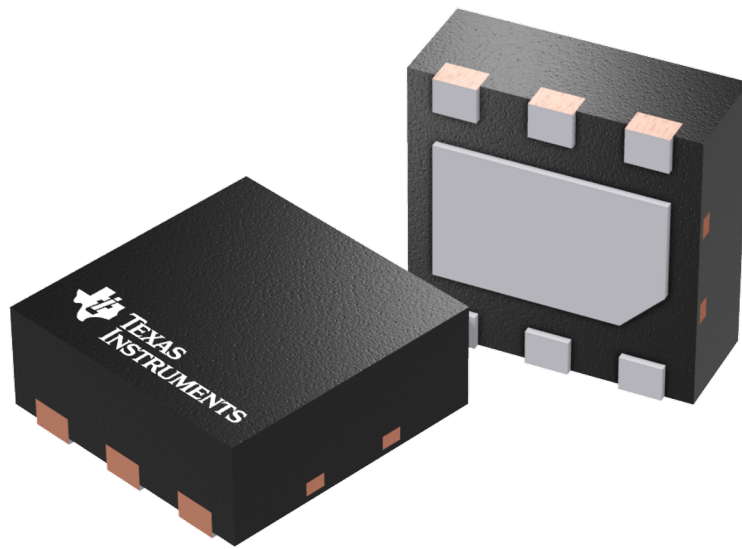

Images above are just a representation of the package family, actual package may vary.
Refer to the product data sheet for package details.

4206925/F

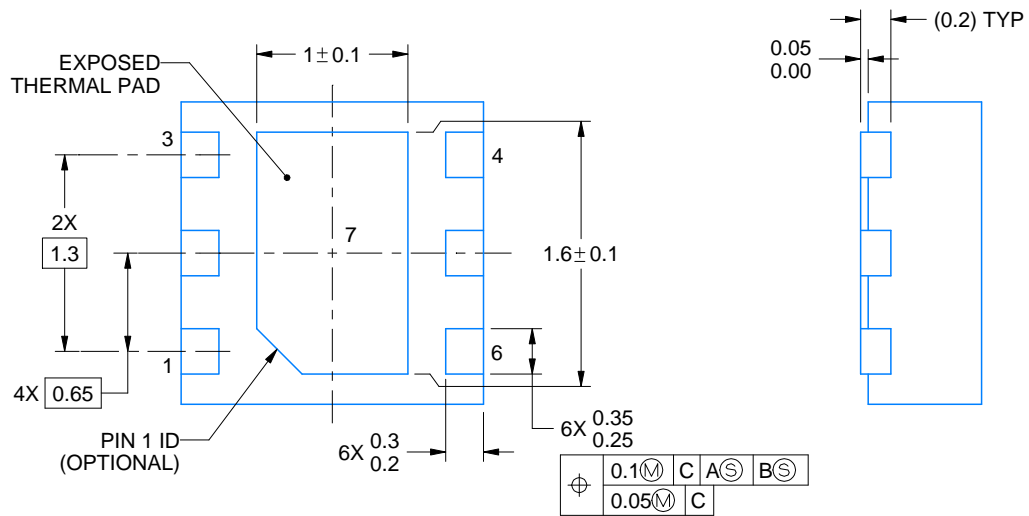
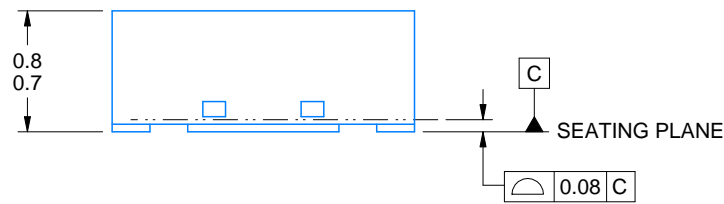
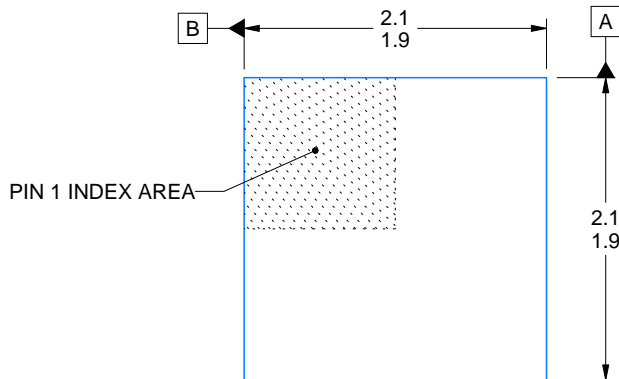
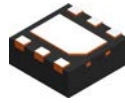

4222173/B 04/2018

NOTES:

1. All linear dimensions are in millimeters. Any dimensions in parenthesis are for reference only. Dimensioning and tolerancing per ASME Y14.5M.
2. This drawing is subject to change without notice.
3. The package thermal pad must be soldered to the printed circuit board for thermal and mechanical performance.

EXAMPLE STENCIL DESIGN

DRV0006A

WSON - 0.8 mm max height

PLASTIC SMALL OUTLINE - NO LEAD

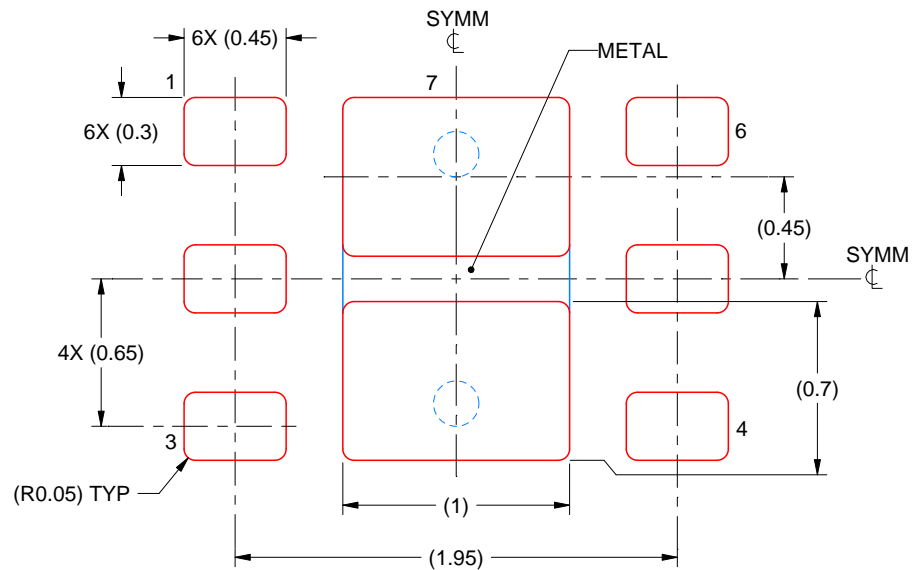

SOLDER PASTE EXAMPLE
BASED ON 0.125 mm THICK STENCIL

EXPOSED PAD #7
88% PRINTED SOLDER COVERAGE BY AREA UNDER PACKAGE
SCALE:30X

4222173/B 04/2018

NOTES: (continued)

6. Laser cutting apertures with trapezoidal walls and rounded corners may offer better paste release. IPC-7525 may have alternate design recommendations.

IMPORTANT NOTICE AND DISCLAIMER

TI PROVIDES TECHNICAL AND RELIABILITY DATA (INCLUDING DATA SHEETS), DESIGN RESOURCES (INCLUDING REFERENCE DESIGNS), APPLICATION OR OTHER DESIGN ADVICE, WEB TOOLS, SAFETY INFORMATION, AND OTHER RESOURCES "AS IS" AND WITH ALL FAULTS, AND DISCLAIMS ALL WARRANTIES, EXPRESS AND IMPLIED, INCLUDING WITHOUT LIMITATION ANY IMPLIED WARRANTIES OF MERCHANTABILITY, FITNESS FOR A PARTICULAR PURPOSE OR NON-INFRINGEMENT OF THIRD PARTY INTELLECTUAL PROPERTY RIGHTS.

These resources are intended for skilled developers designing with TI products. You are solely responsible for (1) selecting the appropriate TI products for your application, (2) designing, validating and testing your application, and (3) ensuring your application meets applicable standards, and any other safety, security, regulatory or other requirements.

These resources are subject to change without notice. TI grants you permission to use these resources only for development of an application that uses the TI products described in the resource. Other reproduction and display of these resources is prohibited. No license is granted to any other TI intellectual property right or to any third party intellectual property right. TI disclaims responsibility for, and you will fully indemnify TI and its representatives against, any claims, damages, costs, losses, and liabilities arising out of your use of these resources.

TI's products are provided subject to [TI's Terms of Sale](#) or other applicable terms available either on [ti.com](https://www.ti.com) or provided in conjunction with such TI products. TI's provision of these resources does not expand or otherwise alter TI's applicable warranties or warranty disclaimers for TI products.

TI objects to and rejects any additional or different terms you may have proposed.

Mailing Address: Texas Instruments, Post Office Box 655303, Dallas, Texas 75265
Copyright © 2024, Texas Instruments Incorporated