

UCC12050 High-Density, Low-EMI, 5-kV_{RMS} Reinforced Isolation DC/DC Module

1 Features

- High-density DC/DC module with optimized integrated transformer technology
- Input voltage range: 4.5 V to 5.5 V
- Output voltages (selectable): 5.4 V, 5.0 V, 3.7 V, 3.3 V
- Output power: 500 mW
- Peak efficiency: 60%
- Line regulation (typical): 1%
- Load regulation (typical): 1.5%
- Meets CISPR32 Class B EMI limits without ferrite beads on a 2-layer PCB
- Spread spectrum modulation (SSM)
- Robust isolation barrier:
 - Isolation rating: 5 kV_{RMS}
 - Surge capability: 10 kV_{PK}
 - Working voltage: 1.2 kV_{RMS}
 - CMTI (typical): ±100 V/ns
- Short circuit recovery
- Thermal shutdown
- 16-pin wide-body SOIC package with > 8-mm creepage and clearance
- Extended temperature range: –40°C to 125°C
- **Safety-related certifications:**
 - 7071-V_{PK} reinforced isolation per DIN V VDE V 0884-11:2017-01
 - 5000-V_{RMS} isolation for 1 minute per UL 1577
 - UL certification per IEC 60950-1, IEC 62368-1 and IEC 60601-1 end equipment standards
 - CQC approval per GB4943.1-2011

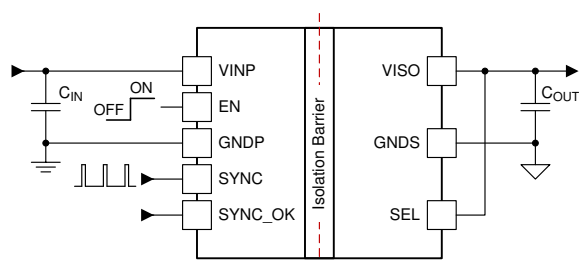

Simplified Application

2 Applications and Uses

- On-board charger
- Battery management system
- Traction inverter
- DC/DC converter for HEV/EVs

3 Description

UCC12050 is an automotive qualified DC/DC power module with 5-kV_{RMS} reinforced isolation rating designed to provide efficient, isolated power to isolated circuits that require a bias supply with a well-regulated output voltage. The device integrates a transformer and DC/DC controller with a proprietary architecture to provide 500 mW (typical) of isolated power with low EMI.

The UCC12050 integrates protection features for increased system robustness. The device also has an enable pin, synchronization capability, and regulated 5-V or 3.3-V output options with headroom. The UCC12050 is a low-profile, miniaturized solution offered in a wide-body SOIC package with 2.65-mm height (typical).

Device Information⁽¹⁾

PART NUMBER	PACKAGE	BODY SIZE (NOM)
UCC12050	DVE SOIC (16)	10.30 mm × 7.50 mm

- (1) For all available packages, see the orderable addendum at the end of the data sheet.

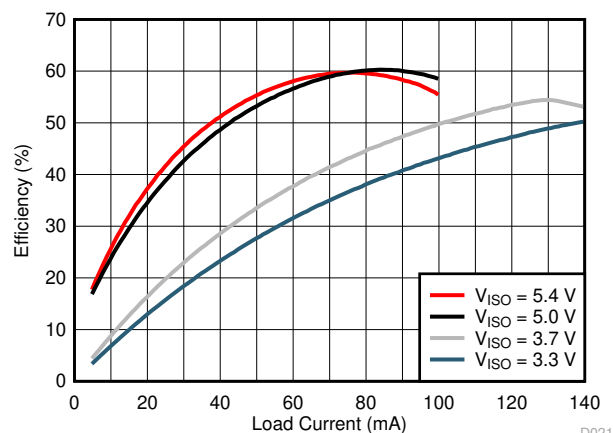

V_{INP} = 5.0 V

T_A = 25°C

Typical Efficiency vs. Load



Table of Contents

1 Features	1	7.2 Functional Block Diagram.....	15
2 Applications and Uses	1	7.3 Feature Description.....	15
3 Description	1	7.4 Device Functional Modes.....	17
4 Revision History	2	8 Application and Implementation	18
5 Pin Configuration and Functions	3	8.1 Application Information.....	18
6 Specifications	4	8.2 Typical Application.....	18
6.1 Absolute Maximum Ratings.....	4	9 Power Supply Recommendations	24
6.2 ESD Ratings.....	4	10 Layout	24
6.3 Recommended Operating Conditions.....	4	10.1 Layout Guidelines.....	24
6.4 Thermal Information.....	4	10.2 Layout Example.....	25
6.5 Power Ratings.....	5	11 Device and Documentation Support	26
6.6 Insulation Specifications.....	5	11.1 Device Support.....	26
6.7 Safety-Related Certifications.....	6	11.2 Documentation Support.....	26
6.8 Safety Limiting Values.....	6	11.3 Receiving Notification of Documentation Updates..	26
6.9 Electrical Characteristics.....	7	11.4 Support Resources.....	26
6.10 Switching Characteristics.....	8	11.5 Trademarks.....	26
6.11 Insulation Characteristics Curves.....	9	11.6 Electrostatic Discharge Caution.....	26
6.12 Typical Characteristics.....	10	11.7 Glossary.....	26
7 Detailed Description	15	12 Mechanical and Packaging Information	26
7.1 Overview.....	15		

4 Revision History

NOTE: Page numbers for previous revisions may differ from page numbers in the current version.

Changes from Revision C (April 2020) to Revision D (February 2021)	Page
• Added updates to the text throughout the document.	1
• Updated ESD values.	4
• Updated thermal footnote description.....	4
• Updated voltage isolation specs per DIN V VDE V 0884-11:2017-01.....	5
• Added certification numbers.....	6
• Updated Switching Characteristics (non-sync).....	8
• Added Section number included	17

Changes from Revision B (December 2019) to Revision C (April 2020)	Page
• Added updates to the text throughout the document.	1
• Added footnote to Insulation Specifications table.....	5
• Removed Pout_max as a Loading parameter. Removed Pout_max from graph.....	16

Changes from Revision A (September 2019) to Revision B (December 2019)	Page
• Changed marketing status from Advance Information to Initial Release.....	1

5 Pin Configuration and Functions

DVE Package 16-Pin SOIC Top View

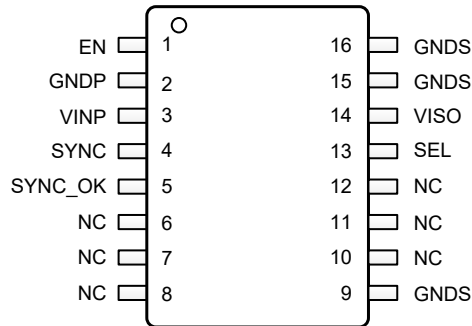

Table 5-1. Pin Functions

PIN		TYPE ⁽¹⁾	DESCRIPTION
NAME	NO.		
EN	1	I	Enable pin. Forcing EN low disables the device. Pull high to enable normal device functionality.
GNDP	2	P	Power ground return connection for VINP.
GNDP	9	P	Connect to GNDP plane on printed circuit board. Do not use as only ground connection for VISO. Ensure pin 15 is connected to circuit ground.
	16		
GNDP	15	P	Secondary side ground return connection for VISO. Connect bypass capacitor from VISO to this pin.
NC	6	—	Pins internally connected together. No other electrical connection. Pins belong to primary-side voltage domain. Connect to GNDP on printed circuit board.
	7		
	8		
	10	—	No internal connection. Pin belongs to isolated voltage domain. Connect to GNDP on printed circuit board.
	11		
	12		
SYNC	4	I	Synchronous clock input pin. Provide a clock signal to synchronize multiple devices or connect to GNDP for standalone operation using the internal oscillator. If the SYNC pin is left open make sure to separate it from any switching noise to avoid false clock coupling.
SYNC_OK	5	O	Active-low, open-drain diagnostic output. Pin is asserted LOW if there is no external SYNC clock or one that is outside of the operating range is detected. In this state, the external clock is ignored and the DC/DC converter is clocked by the internal oscillator. The pin is in high-impedance if a clock is applied on SYNC.
SEL	13	I	V _{ISO} selection pin. V _{ISO} setpoint is 5.0 V when SEL is shorted to V _{ISO} , 5.4 V when SEL is connected to V _{ISO} through a 100-kΩ resistor, 3.3 V when SEL is shorted to GNDP, and 3.7 V when SEL is connected to GNDP through a 100-kΩ resistor. For more information see the Section 7.4 section.
VINP	3	P	Primary side input supply voltage pin. A 10-μF ceramic capacitor to GNDP on pin 2, placed close to the device pins, is required.
VISO	14	P	Isolated supply voltage pin. A 10-μF ceramic capacitor to GNDP on pin 15, placed close to the device pins, is required. See Section 8.2.2.1 section.

(1) P = Power, G = Ground, I = Input, O = Output

6 Specifications

6.1 Absolute Maximum Ratings

over operating free-air temperature range (unless otherwise noted)⁽¹⁾

	MIN	MAX	UNIT
V _{INP} to GNDP	-0.3	6.0	V
EN, SYNC, SYNC_OK, to GNDP	-0.3	V _{INP} + 0.3, ≤ 6.0	V
V _{ISO} to GNDS	-0.3	6.0	V
SEL to GNDS	-0.3	V _{ISO} + 0.3, ≤ 6.0	V
V _{ISO} output power at T _a = 25°C, P _{OUT_MAX} ⁽²⁾		675	mW
Operating junction temperature range, T _J	-40	150	°C
Storage temperature, T _{stg}	-65	150	°C

- (1) Stresses beyond those listed under *Absolute Maximum Ratings* may cause permanent damage to the device. These are stress ratings only, which do not imply functional operation of the device at these or any other conditions beyond those indicated under *Recommended Operating Conditions*. Exposure to absolute-maximum-rated conditions for extended periods may affect device reliability.
- (2) See the [Section 7.3.3](#) section for maximum rated values across temperature and V_{INP} conditions for each different V_{ISO} output mode.

6.2 ESD Ratings

			VALUE	UNIT
V _(ESD)	Electrostatic discharge	Human-body model (HBM), per ANSI/ESDA/JEDEC JS-001 ⁽¹⁾	±3000	V
		Charged-device model (CDM), per JEDEC specification JESD22-C101 ⁽²⁾	±1000	

- (1) JEDEC document JEP155 states that 500-V HBM allows safe manufacturing with a standard ESD control process.
- (2) JEDEC document JEP157 states that 250-V CDM allows safe manufacturing with a standard ESD control process.

6.3 Recommended Operating Conditions

over operating free-air temperature range (unless otherwise noted)

		MIN	NOM	MAX	UNIT
V _{INP}	Primary side supply voltage	4.5	5.0	5.5	V
V _{EN}	EN pin input voltage	0		5.5	V
V _{SYNC}	SYNC pin input voltage	0		5.5	V
V _{SYNC-OK}	SYNC_OK pin drain pin voltage	0		5.5	V
V _{ISO}	Isolated power supply voltage	0		5.7	V
V _{SEL}	Input voltage	0		5.7	V
f _{SYNC}	External DC/DC converter synchronization signal frequency	14.4	16.0	17.6	MHz
P _{VISO}	V _{ISO} output power at T _a = 25°C ⁽¹⁾			500	mW
T _a	Ambient temperature	-40		125	°C
T _J	Junction temperature	-40		150	°C

- (1) See the [Section 7.3.3](#) section for maximum rated values across temperature and V_{INP} conditions for each different V_{ISO} output mode.

6.4 Thermal Information

THERMAL METRIC ⁽¹⁾		UCC12050	UNIT
		DVE (SOIC)	
		16 PINS	
R _{θJA}	Junction-to-ambient thermal resistance	63.8	°C/W
R _{θJC(top)}	Junction-to-case (top) thermal resistance	21.4	°C/W
R _{θJB}	Junction-to-board thermal resistance	38.5	°C/W
ψ _{JT}	Junction-to-top characterization parameter	10.2	°C/W
ψ _{JB}	Junction-to-board characterization parameter	37.2	°C/W

THERMAL METRIC ⁽¹⁾		UCC12050	UNIT
		DVE (SOIC)	
		16 PINS	
R _{θJC(bot)}	Junction-to-case (bottom) thermal resistance	—	°C/W

(1) The value of R_{θJA} given in this table is only valid for comparison with other packages and can not be used for design purposes. This value was calculated in accordance with JESD 51-7, and simulated on a 4-layer JEDEC board when P_{DP} = 129 mW, P_{DS} = 142 mW and P_{DT} = 129 mW. The board temperature is taken from Pin 12. For more information about traditional and new thermal metrics, see the [Semiconductor and IC Package Thermal Metrics](#) application report.

6.5 Power Ratings

V_{INP} = 5.0V, C_{INP} = C_{OUT} = 10 uF, T_J = 150°C, Internal Clock mode

PARAMETER		TEST CONDITIONS	VALUE	UNIT
P _D	Power dissipation	SEL connected to GNDS (3.3-V V _{ISO} output mode), I _{ISO} = 135 mA	460	mW
P _{DP}	Power dissipation by driver side (primary)		148	mW
P _{DS}	Power dissipation by rectifier side (secondary)		164	mW
P _{DT}	Power dissipation by transformer		148	mW

6.6 Insulation Specifications

PARAMETER		TEST CONDITIONS	VALUE	UNIT
GENERAL				
CLR	External clearance ⁽¹⁾	Shortest terminal-to-terminal distance through air	> 8	mm
CPG	External creepage ⁽¹⁾	Shortest terminal-to-terminal distance across the package surface	> 8	mm
DTI	Distance through the insulation	Minimum internal gap (internal clearance)	> 120	μm
CTI	Comparative tracking index	DIN EN 60112 (VDE 0303-11); IEC 60112	> 600	V
	Material group	According to IEC 60664-1	I	
	Overvoltage Category	Rated mains voltage ≤ 300 V _{RMS}	I-IV	
		Rated mains voltage ≤ 600 V _{RMS}	I-IV	
		Rated mains voltage ≤ 1000 V _{RMS}	I-III	
DIN V VDE V 0884-11:2017-01⁽²⁾				
V _{IORM}	Maximum repetitive peak isolation voltage	AC voltage (bipolar)	1697	V _{PK}
V _{IOWM}	Maximum working isolation voltage	AC voltage (sine wave) Time dependent dielectric breakdown (TDDb) test	1200	V _{RMS}
		DC voltage	1697	V _{DC}
V _{IOTM}	Maximum transient isolation voltage	V _{TEST} = V _{IOTM} , t = 60s (qualification); V _{TEST} = 1.2 × V _{IOTM} , t = 1s (100% production)	7071	V _{PK}
V _{IOSM}	Maximum surge isolation voltage ⁽³⁾	Test method per IEC 62368-1, 1.2/50 μs waveform, V _{TEST} = 1.6 × V _{IOSM} = 10000 V _{PK} (qualification)	6250	V _{PK}
q _{pd}	Apparent charge ⁽⁴⁾	Method a: After I/O safety test subgroup 2/3, V _{ini} = V _{IOTM} , t _{ini} = 60 s; V _{pd(m)} = 1.2 × V _{IORM} = 1696 V _{PK} , t _m = 10 s	≤ 5	pC
		Method a: After environmental tests subgroup 1, V _{ini} = V _{IOTM} , t _{ini} = 60 s; V _{pd(m)} = 1.6 × V _{IORM} = 2262 V _{PK} , t _m = 10 s	≤ 5	
		Method b1: At routine test (100% production) and preconditioning (type test) V _{ini} = 1.2 × V _{IOTM} , t _{ini} = 1 s; V _{pd(m)} = 1.875 × V _{IORM} = 2651 V _{PK} , t _m = 1 s	≤ 5	
C _{IO}	Barrier capacitance, input to output ⁽⁵⁾	V _{IO} = 0.4 sin(2πft), f = 1 MHz	~3.5	pF
R _{IO}	Isolation resistance, input to output ⁽⁵⁾	V _{IO} = 500 V, T _A = 25°C	> 10 ¹²	Ω
		V _{IO} = 500 V, 100°C ≤ T _A ≤ 125°C	> 10 ¹¹	
		V _{IO} = 500 V at T _S = 150°C	> 10 ⁹	
	Pollution degree		2	
	Climatic category		40/125/21	
UL 1577				

PARAMETER		TEST CONDITIONS	VALUE	UNIT
V_{ISO}	Withstand isolation voltage	$V_{TEST} = V_{ISO} = 5000 V_{RMS}$, $t = 60$ s (qualification); $V_{TEST} = 1.2 \times V_{ISO} = 6000 V_{RMS}$, $t = 1$ s (100% production)	5000	V_{RMS}

- Creepage and clearance requirements should be applied according to the specific equipment isolation standards of an application. Care should be taken to maintain the creepage and clearance distance of a board design to ensure that the mounting pads of the isolator on the printed-circuit board do not reduce this distance. Creepage and clearance on a printed-circuit board become equal in certain cases. Techniques such as inserting grooves and/or ribs on a printed circuit board are used to help increase these specifications.
- This coupler is suitable for *safe electrical insulation* only within the maximum operating ratings. Compliance with the safety ratings shall be ensured by means of suitable protective circuits.
- Testing is carried out in air or oil to determine the intrinsic surge immunity of the isolation barrier.
- Apparent charge is electrical discharge caused by a partial discharge (pd).
- All pins on each side of the barrier tied together creating a two-terminal device

6.7 Safety-Related Certifications

VDE		UL		CQC
Certified according to DIN V VDE V 0884-11:2017- 01	Certified according to IEC 60601-1	Certified according to IEC 60950-1 and IEC 62368- 1	Recognized under UL 1577 Component Recognition Program	Certified according to GB4943.1-2011
Reinforced insulation Maximum transient isolation voltage, 7071 VPK; Maximum repetitive peak isolation voltage, 1697 VPK; Maximum surge isolation voltage, 6250 VPK	Reinforced insulation per AAMI ES 60601-1:2005/(R)2012 and A1:2012, C1:2009/(R)2012 and A2:2010/(R)2012 CSA C22.2 No. 60601-1:2014 IEC 60601-1:2012, 2 MOPP (Means of Patient Protection), 250 VRMS maximum working voltage	Reinforced insulation per UL 60950-1-07+A1+A2, IEC 60950-1 2nd Ed.+A1+A2, UL 62368-1- 14 and IEC 62368-1 2nd Ed., 1200 VRMS maximum working voltage (pollution degree 1, material group I	Single protection, 5000 VRMS	Reinforced insulation, Altitude \leq 5000 m, Tropical Climate, 700 VRMS maximum working voltage
Certificate number: 40040142	Certificate number: US-36773-A1-UL	Certificate number: US-36706-UL, US-36707-UL	File number: E181974	Certificate number: CQC20001273822

6.8 Safety Limiting Values

Safety limiting intends to minimize potential damage to the isolation barrier upon failure of input or output circuitry.

PARAMETER		TEST CONDITIONS	MAX	UNIT
I_S	Safety input current ⁽¹⁾	$R_{\theta JA} = 63.8^\circ\text{C/W}$, $V_I = 5.5$ V, $T_J = 150^\circ\text{C}$, $T_A = 25^\circ\text{C}$	356	mA
		$R_{\theta JA} = 63.8^\circ\text{C/W}$, $V_I = 4.5$ V, $T_J = 150^\circ\text{C}$, $T_A = 25^\circ\text{C}$	435	
P_S	Safety input power	$R_{\theta JA} = 63.8^\circ\text{C/W}$, $T_J = 150^\circ\text{C}$, $T_A = 25^\circ\text{C}$	1960	mW
T_S	Safety temperature ⁽¹⁾		150	$^\circ\text{C}$

- The maximum safety temperature, T_S , has the same value as the maximum junction temperature, T_J , specified for the device. The I_S and P_S parameters represent the safety current and safety power respectively. The maximum limits of I_S and P_S should not be exceeded. These limits vary with the ambient temperature, T_A . The junction-to-air thermal resistance, $R_{\theta JA}$, in the [Thermal Information](#) table is that of a device installed on a high-K test board for leaded surface-mount packages. Use these equations to calculate the value for each parameter: $T_J = T_A + R_{\theta JA} \times P$, where P is the power dissipated in the device. $T_{J(max)} = T_S = T_A + R_{\theta JA} \times P_S$, where $T_{J(max)}$ is the maximum allowed junction temperature. $P_S = I_S \times V_I$, where V_I is the maximum input voltage.

6.9 Electrical Characteristics

Over operating temperature range ($T_J = -40^\circ\text{C}$ to 150°C), $V_{\text{INP}} = 4.5\text{V}$ to 5.5V , $C_{\text{INP}} = C_{\text{OUT}} = 10\ \mu\text{F}$, SEL connected to V_{ISO} , internal clock mode, unless otherwise noted. All typical values at $T_J = 25^\circ\text{C}$ and $V_{\text{INP}} = 5.0\text{V}$.

	PARAMETER	TEST CONDITIONS	MIN	TYP	MAX	UNIT
INPUT SUPPLY						
I_{VINQ}	VINP quiescent current, disabled	EN=LOW			100	μA
I_{VINO}	VINP operating current, no load	EN=HI; SEL shorted to V_{ISO} (5.0V output)		50		mA
		EN=HI; SEL 100k Ω to V_{ISO} (5.4V output)		45		
		EN=HI; SEL shorted to GNDS (3.3V output)		90		
		EN=HI; SEL 100k Ω to GNDS (3.7V output)		80		
$I_{\text{VIN_SC}}$	DC current from VINP supply under short circuit on V_{ISO}	V_{ISO} short to GNDS		245		mA
V_{UVPR}	VINP under-voltage lockout rising threshold			4.2		V
V_{UVPF}	VINP under-voltage lockout falling threshold			3.7		V
V_{UVPH}	VINP under-voltage lockout hysteresis			0.5		V
EN, SYNC INPUT PINS						
V_{IR}	Input voltage threshold, logic HIGH	Rising edge			2.2	V
V_{IF}	Input voltage threshold, logic LOW	Falling edge	0.8			V
I_{EN}	Enable Pin Input Current	$V_{\text{EN}} = 5.0\ \text{V}$		5	10	μA
I_{SYNC}	SYNC Pin Input Current	$V_{\text{SYNC}} = 5.0\ \text{V}$		0.02	1	μA
SYNC_OK PIN						
V_{OL}	SYNC_OK output low voltage	$I_{\text{SYNC_OK}} = -2\ \text{mA}$		0.15		V
$I_{\text{LKG_SYNC_OK}}$	SYNC_OK pin leakage current	$V_{\text{SYNC_OK}} = 5.0\ \text{V}$			1	μA
DC/DC CONVERTER						
V_{ISO}	Isolated supply output voltage	SEL shorted to V_{ISO} (5.0V output); $I_{\text{ISO}} = 55\ \text{mA}$ (2)	4.7	5	5.3	V
		SEL 100k Ω to V_{ISO} (5.4 V output); $I_{\text{ISO}} = 45\ \text{mA}$ (2)	5.1	5.4	5.7	V
		SEL shorted to GNDS (3.3V output); $I_{\text{ISO}} = 100\ \text{mA}$ (2)	3.1	3.3	3.5	V
		SEL 100k Ω to GNDS (3.7 V output); $I_{\text{ISO}} = 90\ \text{mA}$ (2)	3.5	3.7	3.9	V
$V_{\text{ISO(RIP)}}$	Voltage ripple on isolated supply output (pk-pk)	20-MHz bandwidth, CLOAD = 10 μF 0.1 μF , SEL shorted to V_{ISO} (5.0V output); $I_{\text{ISO}} = 100\ \text{mA}$		50		mV
		20-MHz bandwidth, CLOAD = 10 μF 0.1 μF , SEL 100k Ω to V_{ISO} (5.4V output); $I_{\text{ISO}} = 90\ \text{mA}$		50		mV
		20-MHz bandwidth, CLOAD = 10 μF 0.1 μF , SEL shorted to GNDS (3.3V output); $I_{\text{ISO}} = 145\ \text{mA}$		50		mV
		20-MHz bandwidth, CLOAD = 10 μF 0.1 μF , SEL shorted to GNDS (3.7V output); $I_{\text{ISO}} = 130\ \text{mA}$		50		mV
$V_{\text{ISO(LINE)}}$	V_{ISO} DC line regulation	SEL shorted to V_{ISO} (5.0 V output); $I_{\text{ISO}} = 50\ \text{mA}$, $V_{\text{INP}} = 4.5\ \text{V}$ to $5.5\ \text{V}$		1%		
		SEL shorted to GNDS (3.3 V output); $I_{\text{ISO}} = 75\ \text{mA}$, $V_{\text{INP}} = 4.5\ \text{V}$ to $5.5\ \text{V}$		1%		

UCC12050

SNVSB38D – SEPTEMBER 2019 – REVISED JANUARY 2021

Over operating temperature range ($T_J = -40^\circ\text{C}$ to 150°C), $V_{INP} = 4.5\text{V}$ to 5.5V , $C_{INP} = C_{OUT} = 10\ \mu\text{F}$, SEL connected to V_{ISO} , internal clock mode, unless otherwise noted. All typical values at $T_J = 25^\circ\text{C}$ and $V_{INP} = 5.0\text{V}$.

	PARAMETER	TEST CONDITIONS	MIN	TYP	MAX	UNIT
$V_{ISO(\text{LOAD})}$	V_{ISO} DC load regulation	SEL shorted to V_{ISO} (5.0 V output); $I_{ISO} = 0$ to 100 mA		1.5%		
	V_{ISO} DC load regulation	SEL shorted to GNDS (3.3 V output); $I_{ISO} = 0$ to 145 mA		1.5%		
EFF	Efficiency at maximum recommended load ⁽¹⁾	SEL shorted to V_{ISO} (5.0 V output); $I_{ISO} = 100$ mA		60%		
		SEL 100k Ω to V_{ISO} (5.4V output); $I_{ISO} = 90$ mA		60%		
		SEL shorted to GNDS (3.3V output); $I_{ISO} = 145$ mA		50%		
		SEL 100k Ω to GNDS (3.7V output); $I_{ISO} = 130$ mA		53%		
t_{RISE}	V_{ISO} rise time, 10% - 90%	EN = change from LO to HI, SEL shorted to V_{ISO} (5.0V output); $I_{ISO} = 1$ mA		750		μs
		EN = change from LO to HI, SEL 100k Ω to GNDS (3.3V output); $I_{ISO} = 1$ mA		300		μs
THERMAL SHUTDOWN						
TSD_{THR}	Thermal shutdown threshold	Junction Temperature, Rising		165		$^\circ\text{C}$
TSD_{HYST}	Thermal shutdown hysteresis	Junction Temperature, Falling		27		$^\circ\text{C}$

(1) Efficiency calculation: $EFF = (V_{ISO} \times I_{ISO}) / (V_{INP} \times I_{INP})$

(2) See the [Section 7.3.3](#) section for discussion of V_{ISO} regulation across load and temperature conditions for all output voltage settings.

6.10 Switching Characteristics

Over operating temperature range ($T_J = -40^\circ\text{C}$ to 150°C), $V_{INP} = 4.5\text{V}$ to 5.5V , $C_{INP} = C_{OUT} = 10\ \mu\text{F}$, SEL connected to V_{ISO} , internal clock mode, unless otherwise noted. All typical values at $T_J = 25^\circ\text{C}$ and $V_{INP} = 5.0\text{V}$.

	PARAMETER	TEST CONDITIONS	MIN	TYP	MAX	UNIT
f_{SW_INT}	DC/DC Converter Clock	Internal clock mode	7.2	8	8.8	MHz
CMTI	Static common-mode transient immunity	Slew Rate of GNDP versus GNDS, $V_{CM} = 1000\ \text{V}$		100		V/ns

6.11 Insulation Characteristics Curves

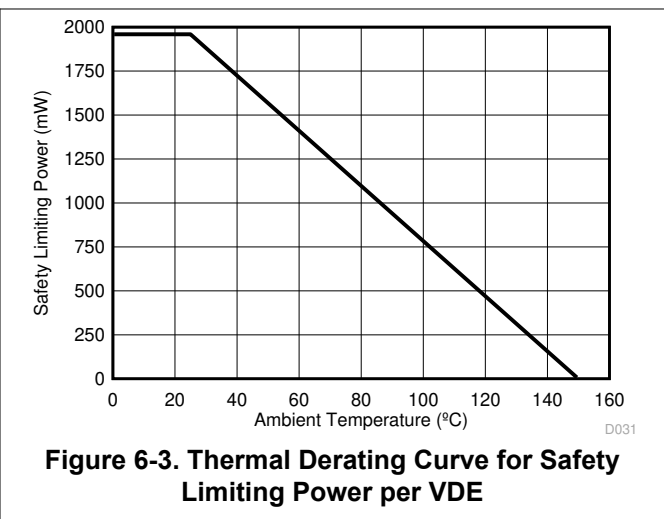
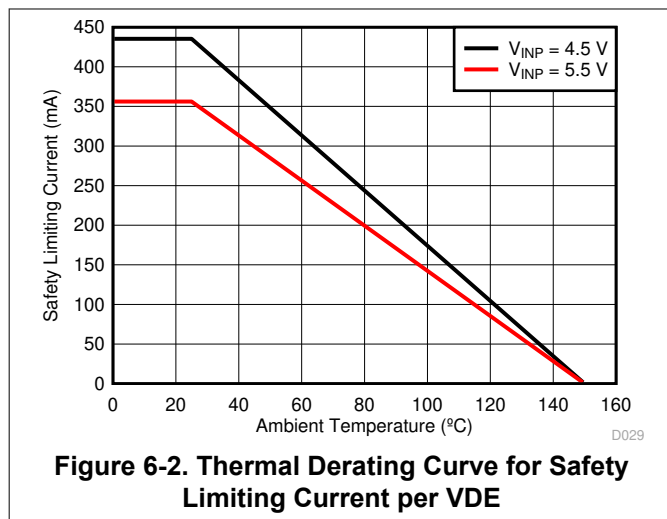
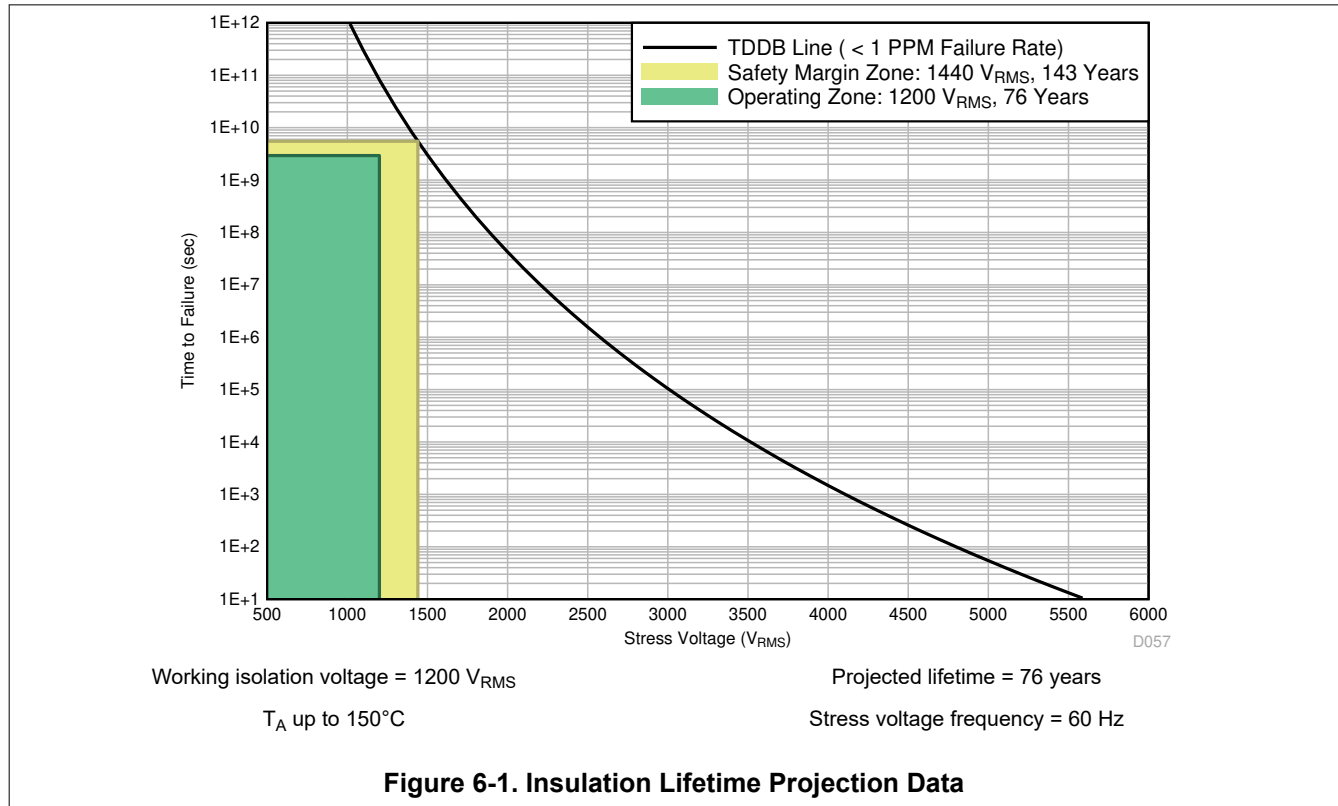

6.12 Typical Characteristics

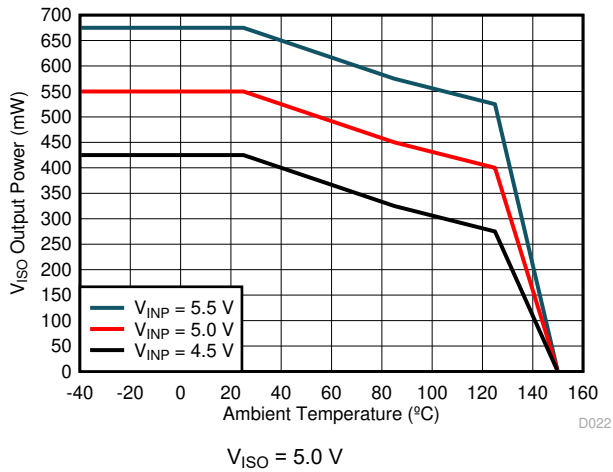

Figure 6-4. Maximum V_{ISO} Output Power vs. Temperature

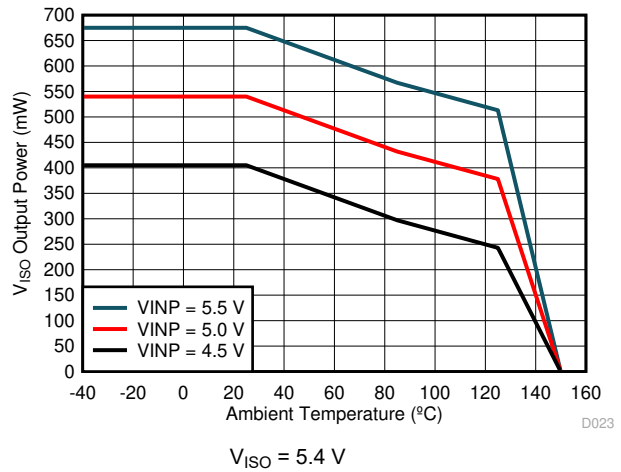

Figure 6-5. Maximum V_{ISO} Output Power vs. Temperature

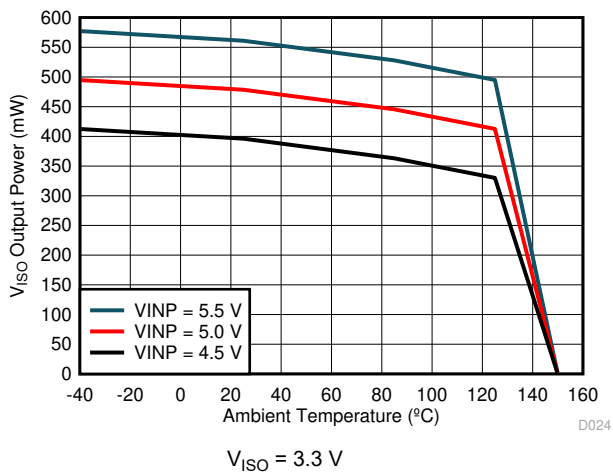

Figure 6-6. Maximum V_{ISO} Output Power vs. Temperature

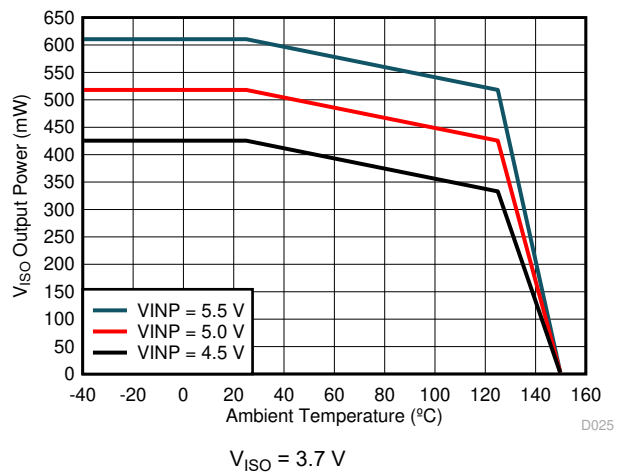

Figure 6-7. Maximum V_{ISO} Output Power vs. Temperature

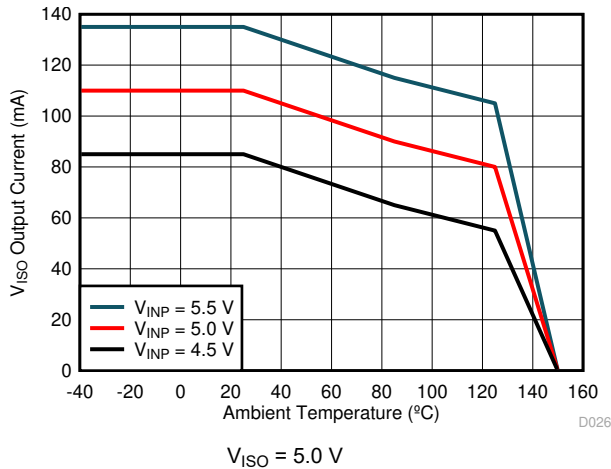

Figure 6-8. Maximum V_{ISO} Output Current vs. Temperature

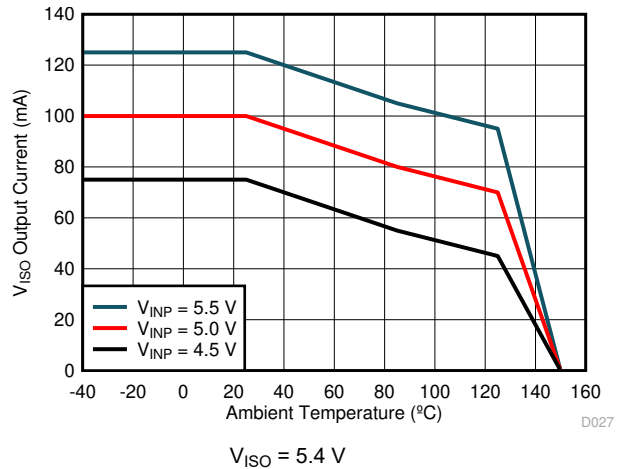

Figure 6-9. Maximum V_{ISO} Output Current vs. Temperature

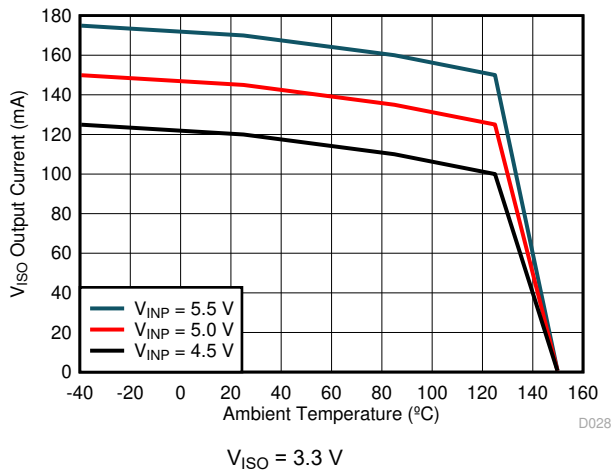

Figure 6-10. Maximum V_{ISO} Output Current vs. Temperature

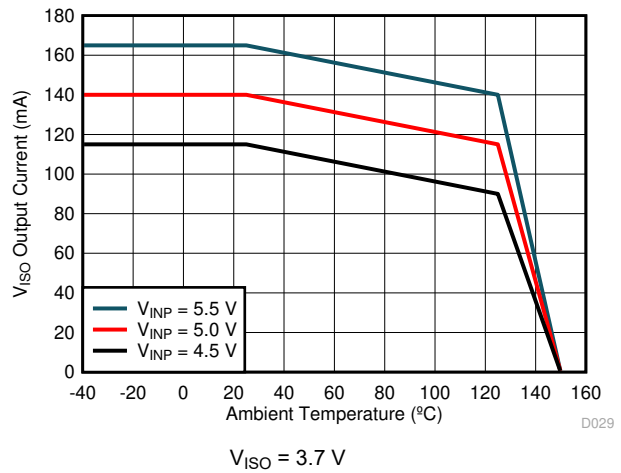

Figure 6-11. Maximum V_{ISO} Output Current vs. Temperature

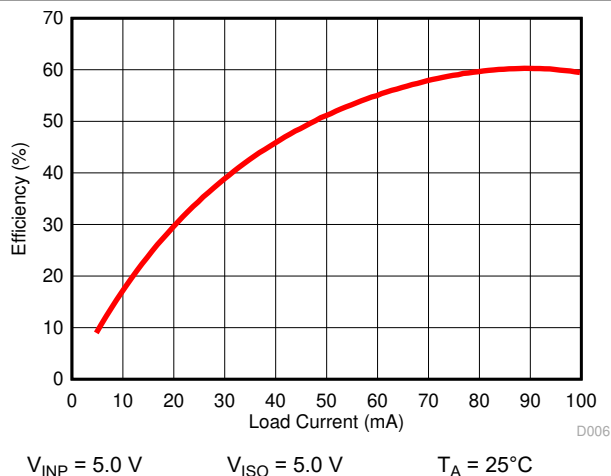

Figure 6-12. Power Supply Efficiency vs Load Current (I_{ISO})

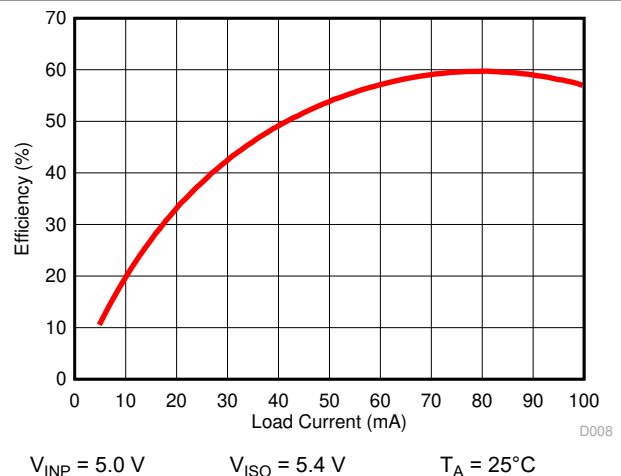

Figure 6-13. Power Supply Efficiency vs Load Current (I_{ISO})

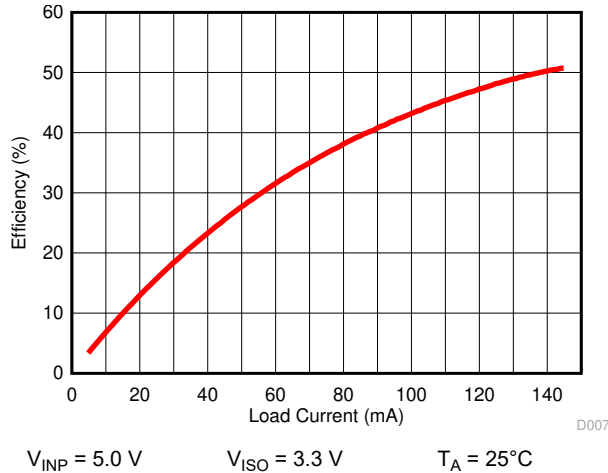

Figure 6-14. Power Supply Efficiency vs Load Current (I_{ISO})

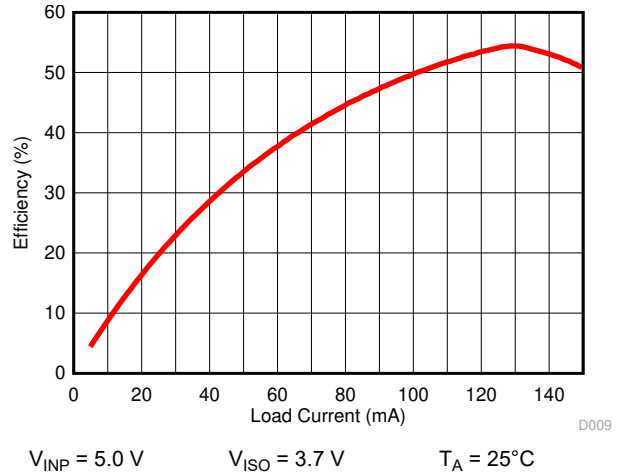

Figure 6-15. Power Supply Efficiency vs Load Current (I_{ISO})

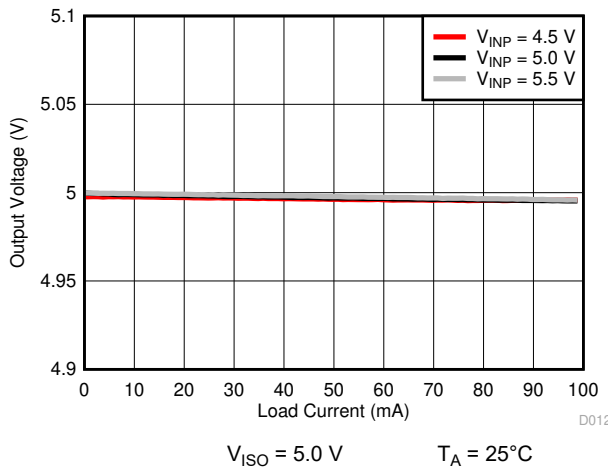

Figure 6-16. Isolated Supply Voltage (V_{ISO}) vs Load Current (I_{ISO})

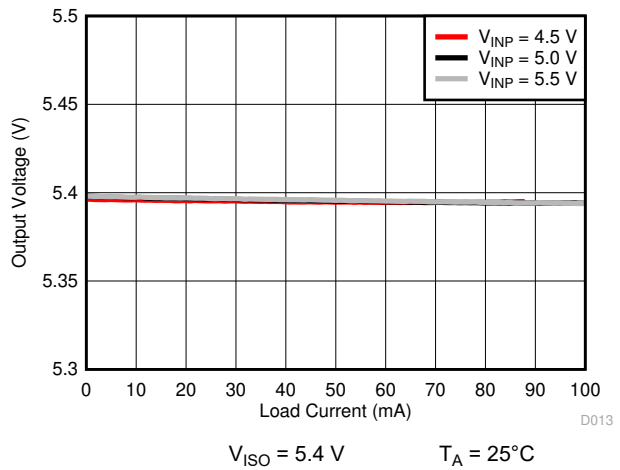

Figure 6-17. Isolated Supply Voltage (V_{ISO}) vs Load Current (I_{ISO})

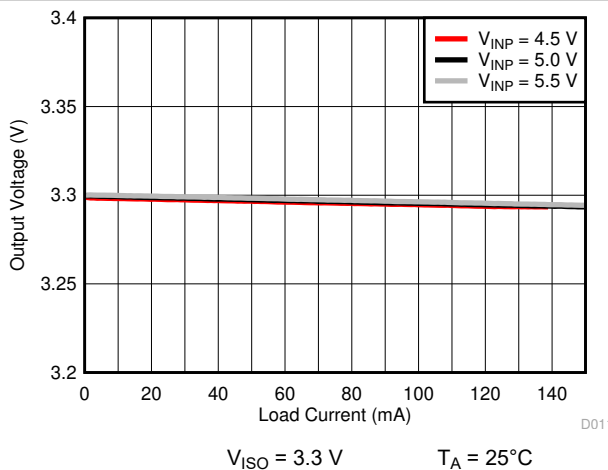

Figure 6-18. Isolated Supply Voltage (V_{ISO}) vs Load Current (I_{ISO})

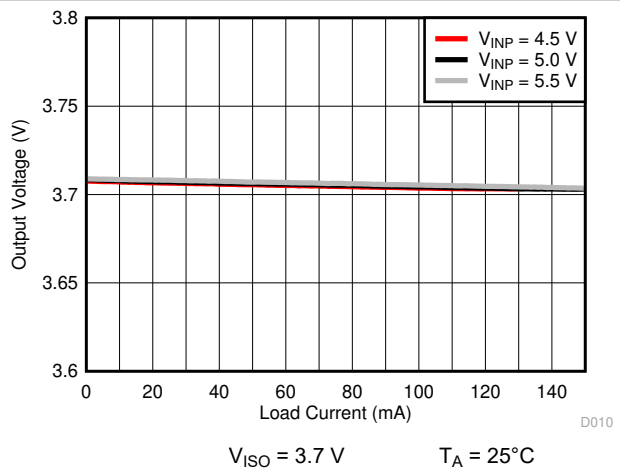

Figure 6-19. Isolated Supply Voltage (V_{ISO}) vs Load Current (I_{ISO})

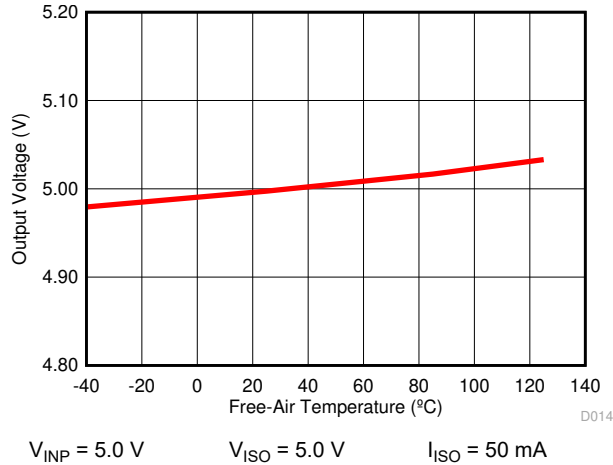

Figure 6-20. Isolated Supply Voltage (V_{ISO}) vs Free-Air Temperature

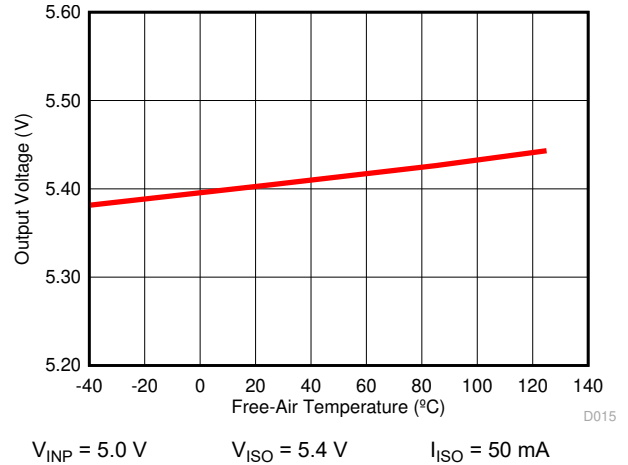

Figure 6-21. Isolated Supply Voltage (V_{ISO}) vs Free-Air Temperature

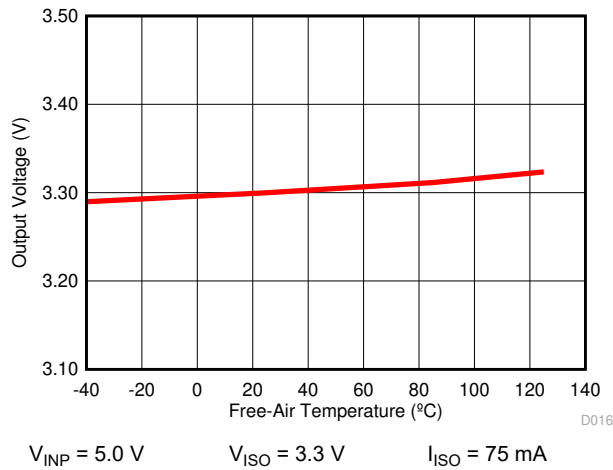

Figure 6-22. Isolated Supply Voltage (V_{ISO}) vs Free-Air Temperature

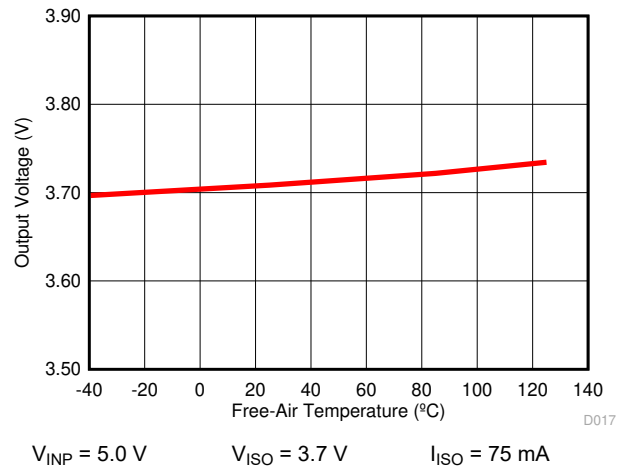

Figure 6-23. Isolated Supply Voltage (V_{ISO}) vs Free-Air Temperature

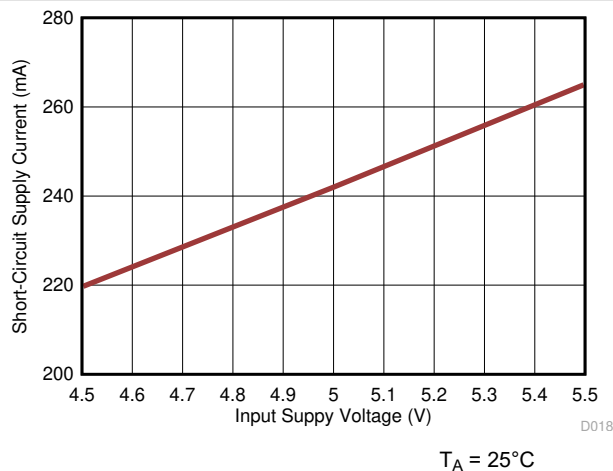

Figure 6-24. Short-Circuit Supply Current (I_{VIN_SC}) vs Supply Voltage (V_{INP})

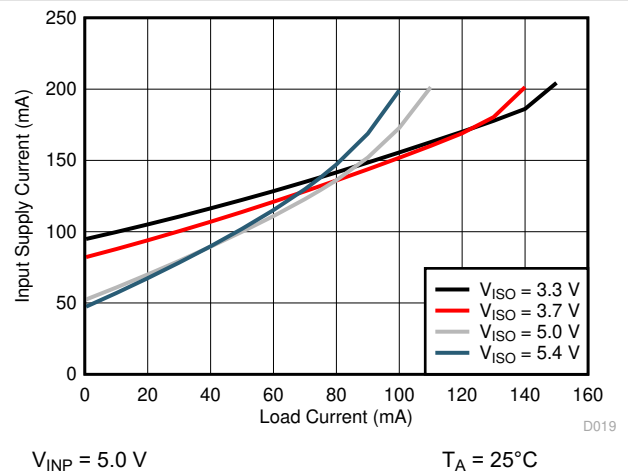

Figure 6-25. Input Supply Current (I_{VINP}) vs Load Current (I_{ISO})

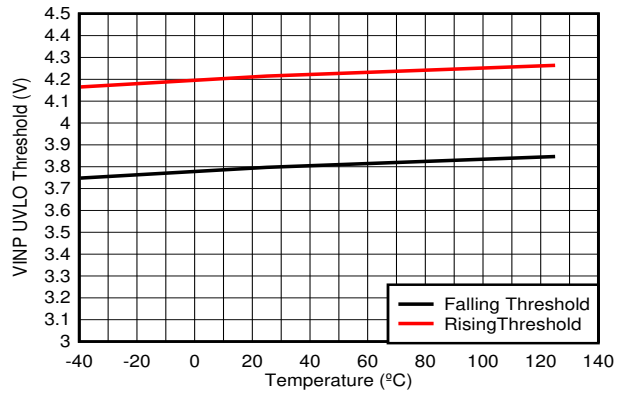

Figure 6-26. Typical V_{INP} UVLO Threshold vs Junction Temperature (T_J)

7 Detailed Description

7.1 Overview

The UCC12050 device integrates a high-efficiency, low-emissions isolated DC/DC converter. This approach provides typically 500 mW of clean, steady power across a 5000 V_{RMS} reinforced isolation barrier.

The integrated DC/DC converter uses switched mode operation and proprietary circuit techniques to reduce power losses and boost efficiency. Specialized control mechanisms, clocking schemes, and the use of an on-chip transformer provide high efficiency and low radiated emissions.

The VINP supply is provided to the primary power controller that switches the power stage connected to the integrated transformer. Power is transferred to the secondary side, rectified, and regulated to a level set by the SEL pin condition.

A fast feedback control loop monitors VISO and the output load, and ensures low overshoots and undershoots during load transients. Undervoltage lockout (UVLO) with hysteresis is integrated on the VINP supply, which ensures robust system performance under noisy conditions.

UCC12050 is suitable for applications that have limited board space and require more integration. These devices are also suitable for very-high voltage applications, where power transformers meeting the required isolation specifications are bulky and expensive.

7.2 Functional Block Diagram

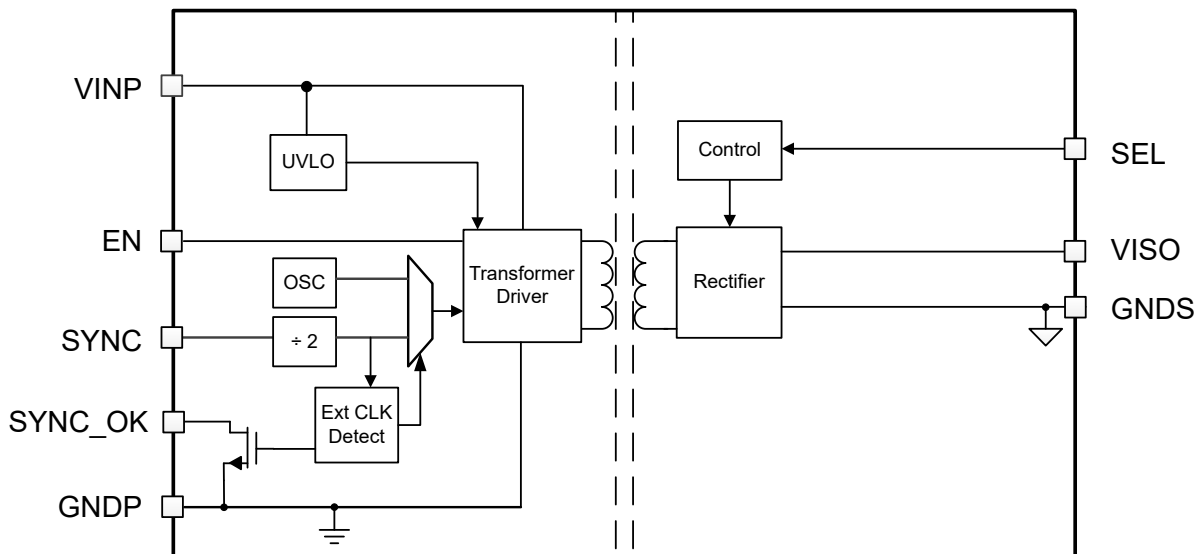

7.3 Feature Description

7.3.1 Enable and Disable

Forcing EN low disables the device, which greatly reduces the VINP power consumption. Pull the EN pin high to enable normal device functionality. The EN pin has a weak internal pull-down resistor, so the device floats to the disable state if the pin is left open.

7.3.2 UVLO, Power-Up, and Power-Down Behavior

The UCC12050 has an undervoltage lockout (UVLO) on the VINP power supply. Upon power-up, while the VINP voltage is below the threshold voltage V_{UVPR} , the primary side transformer driver is disabled, and VISO output is off. The output powers up once the threshold is met. Likewise, if VINP falls below V_{UVPF} , the converter is disabled and there is no output at VISO. Both UVLO threshold voltages have hysteresis to avoid chattering.

7.3.3 V_{ISO} Load Recommended Operating Area

Figure 7-1 depicts the device V_{ISO} regulation behavior across the output load range, including when the output is overloaded. For proper device operation, ensure that the device V_{ISO} output load does not exceed the maximum output current (I_{OUT_MAX}). The value for I_{OUT_MAX} over different temperature and V_{INP} conditions are shown from Figure 6-8 to Figure 6-11. The following protection mechanisms will be engaged if the UCC12050 is loaded beyond the recommended operating area:

1. The device limits the maximum output power. If a load exceeding I_{OUT_MAX} is applied, V_{ISO} drops accordingly to meet the maximum power limit.
2. If V_{ISO} drops below nominal 3.8 V while operating in the constant power limit region, the over-power fold-back feature will switch the power converter from active rectification to passive rectification, and the built-in recovery hysteresis will ensure the UCC12050 recovers at a lower output power. The device returns to active rectification when load drops and V_{ISO} increases above nominal 4.3V.
3. The device triggers a soft-start reset if V_{ISO} drops below the nominal 1.8-V threshold. This reset is designed to protect the device during V_{ISO} short-circuit conditions.
4. Thermal shutdown protection disables the converter if the device is operated in any of the above regions long enough to raise the silicon junction temperature above the thermal shutdown threshold. See the Section 7.3.4 section for more details on this device feature.

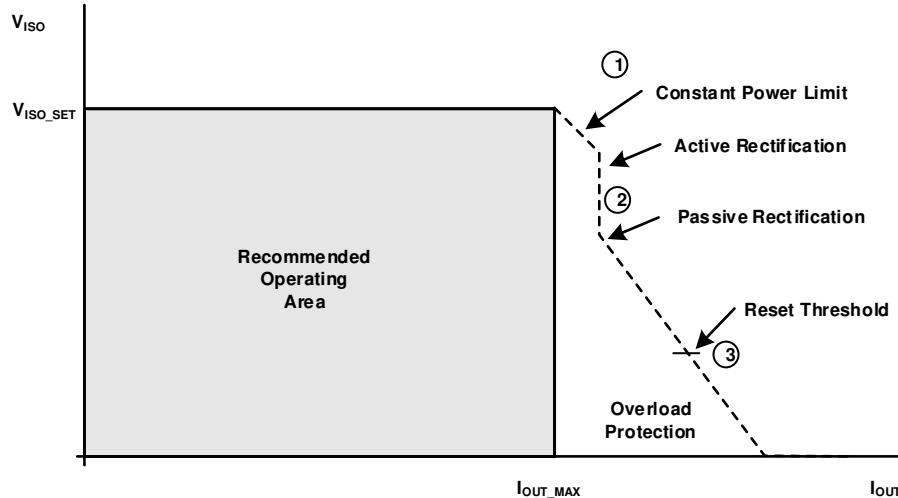

Figure 7-1. V_{ISO} Load Recommended Operating Area Description

7.3.4 Thermal Shutdown

Thermal protection is also integrated to help prevent the device from getting damaged during overload and short-circuit conditions on the isolated output. Under these conditions, the device temperature starts to increase. When the silicon junction temperature T_j sensed at the primary side die goes above the threshold TSD_{THR} (typical $165^{\circ}C$), thermal shutdown activates and the primary controller turns off which removes the energy supplied to the V_{ISO} load, which causes the device to cool off. When the junction temperature drops approximately $27^{\circ}C$ (TSD_{HYST}) from the shutdown point, the device starts to function normally. If an overload or output short-circuit condition prevails, this protection cycle is repeated. Make sure the design prevents the device junction temperatures from reaching such high values.

7.3.5 External Clocking and Synchronization

The UCC12050 has an internal oscillator trimmed to drive the transformer at 8.0 MHz. An external clock may be applied at the SYNC pin to override the internal oscillator. This external clock will be divided by 2, so the target range for the external clock signal at SYNC is 16 MHz $\pm 10\%$. When a valid external clock signal is detected, the internal spread spectrum modulation (SSM) algorithm is disabled. This allows an external clock signal with a unique SSM to be applied. The depth and frequency of SSM is a tradeoff versus low frequency modulated V_{ISO} voltage ripple. The SYNC_OK pin is asserted LOW if there is no external SYNC clock or one that is outside of

the operating range of the device is detected. In this state, the external clock is ignored and the DC/DC converter is clocked by the internal oscillator. The pin is in high impedance if a valid clock is applied on SYNC.

7.3.6 V_{ISO} Output Voltage Selection

The SEL pin is monitored during power-up — within the first 1 ms after applying VINP above the UVLO rising threshold or enabling via the EN pin — to detect the desired regulation voltage for the VISO output. Note that after this initial monitoring, the SEL pin no longer affects the VISO output level. In order to change the output mode selection, either the EN pin must be toggled or the VINP power supply must be cycled off and back on. Section 6.4 provides more details on the SEL pin functionality.

7.3.7 Electromagnetic Compatibility (EMC) Considerations

UCC12050 devices use spread spectrum modulation for the internal oscillator and advanced internal layout scheme to minimize radiated emissions at the system level.

Many applications in harsh industrial environment are sensitive to disturbances such as electrostatic discharge (ESD), electrical fast transient (EFT), surge and electromagnetic emissions. These electromagnetic disturbances are regulated by international standards such as IEC 61000-4-x and CISPR 32. Although system-level performance and reliability depends, to a large extent, on the application board design and layout, the device incorporates many chip-level design improvements for overall system robustness.

7.4 Device Functional Modes

Table 7-1 lists the supply functional modes for this device.

Table 7-1. Device Functional Modes

INPUTS		Isolated Supply Output Voltage (V _{ISO}) Setpoint
EN	SEL	
HIGH	Shorted to VISO	5.0 V
HIGH	100 kΩ to VISO	5.4 V
HIGH	Shorted to GNDS	3.3 V
HIGH	100 kΩ to GNDS	3.7 V
HIGH	OPEN ⁽¹⁾	UNSUPPORTED
LOW	X	0 V

(1) The SEL pin has an internal weak pull-down resistance to ground, but leaving this pin open is not recommended.

8 Application and Implementation

Note

Information in the following applications sections is not part of the TI component specification, and TI does not warrant its accuracy or completeness. TI's customers are responsible for determining suitability of components for their purposes, as well as validating and testing their design implementation to confirm system functionality.

8.1 Application Information

The UCC12050 device is suitable for applications that have limited board space and desire more integration. This device is also suitable for very high voltage applications, where power transformers meeting the required isolation specifications are bulky and expensive.

8.2 Typical Application

Figure 8-1 shows the typical application schematic for the UCC12050 device supplying an isolated load.

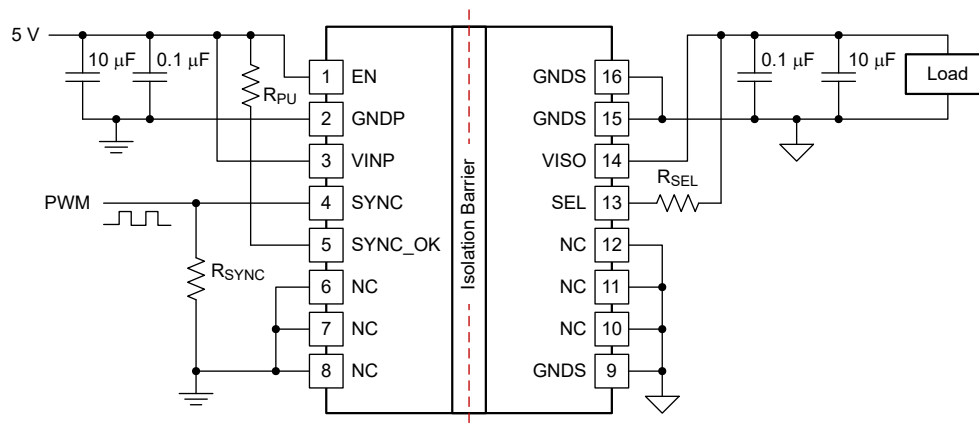

Figure 8-1. Typical Application

8.2.1 Design Requirements

To design using UCC12050, a few simple design considerations must be evaluated. [Table 8-1](#) shows some recommended values for a typical application. See [Section 9](#) and [Section 10](#) sections to review other key design considerations for the UCC12050.

Table 8-1. Design Parameters

PARAMETER	RECOMMENDED VALUE
Input supply voltage, V_{INP}	4.5 V to 5.5 V
Decoupling capacitance between V_{INP} and GNDP	10 μ F, 16 V, \pm 10%, X7R
Decoupling capacitance between V_{ISO} and GNDS ⁽¹⁾	10 μ F, 16 V, \pm 10%, X7R
Optional additional capacitance on V_{ISO} or V_{INP} to reduce high-frequency ripple	0.1 μ F, 50 V, \pm 10%, X7R
Pull-up resistor from SYNC_OK to V_{INP} , R_{PU}	100 k Ω
Pull-up resistor from SEL to V_{ISO} for 5.0V output voltage mode, R_{SEL}	0 Ω
Pull-up resistor from SEL to V_{ISO} for 5.4V output voltage mode, R_{SEL}	100 k Ω
Optional SYNC signal impedance-matching resistor, R_{SYNC}	Match source — typical values are 50 Ω , 75 Ω , 100 Ω , or 1 k Ω
External clock signal applied on SYNC	16 MHz

(1) See [Section 8.2.2.1](#) section.

8.2.2 Detailed Design Procedure

Place ceramic decoupling capacitors as close as possible to the device pins. For the input supply, place the capacitor(s) between pin 3 (V_{INP}) and pin 2 (GNDP). For the isolated output supply, place the capacitor(s) between pin 14 (V_{ISO}) and pin 15 (GNDS). This location is of particular importance to the input decoupling capacitor, because this capacitor supplies the transient current associated with the fast switching waveforms of the power drive circuits. The recommended capacitor value is 10 μ F. Ensure the capacitor dielectric material is compatible with the target application temperature.

8.2.2.1 V_{ISO} Output Capacitor Selection

The UCC12050 is optimized to run with an effective output capacitance of 5 μ F to 20 μ F. A ceramic capacitor is recommended. Ceramic capacitors have DC-Bias and temperature derating effects, which both have influence the final effective capacitance. Choose the right capacitor carefully in combination with considering its package size, dielectric and voltage rating. It is good design practice to include one 0.1- μ F capacitor close to the device for high-frequency noise reduction.

8.2.3 Application Curves

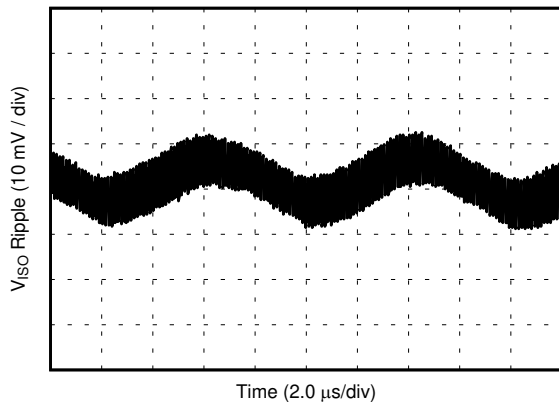

D033

$V_{INP} = 5.0\text{ V}$ $V_{ISO} = 5.4\text{ V}$ Bandwidth = 20 MHz

Figure 8-2. V_{ISO} Ripple, 5.4-V Output, 10% Load

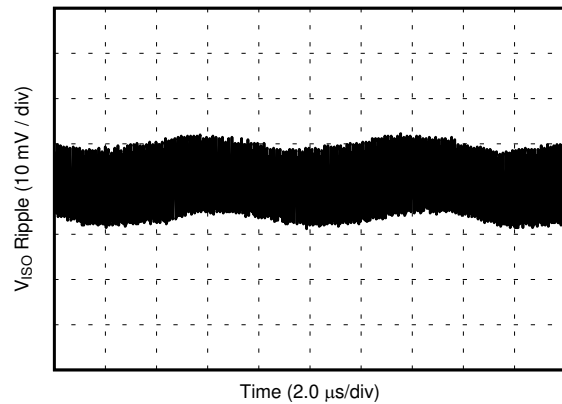

D034

$V_{INP} = 5.0\text{ V}$ $V_{ISO} = 5.4\text{ V}$ Bandwidth = 20 MHz

Figure 8-3. V_{ISO} Ripple, 5.4-V Output, 90% Load

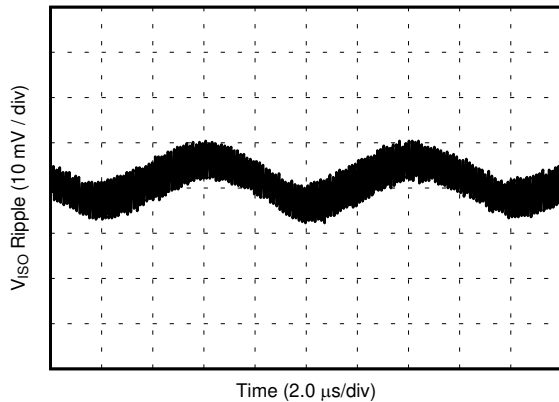

D035

$V_{INP} = 5.0\text{ V}$ $V_{ISO} = 5.0\text{ V}$ Bandwidth = 20 MHz

Figure 8-4. V_{ISO} Ripple, 5.0-V Output, 10% Load

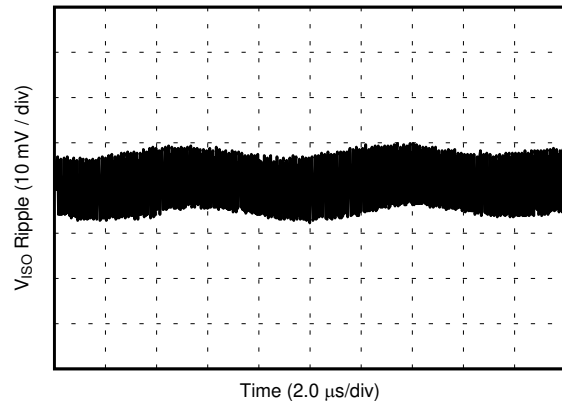

D036

$V_{INP} = 5.0\text{ V}$ $V_{ISO} = 5.0\text{ V}$ Bandwidth = 20 MHz

Figure 8-5. V_{ISO} Ripple, 5.0-V Output, 90% Load

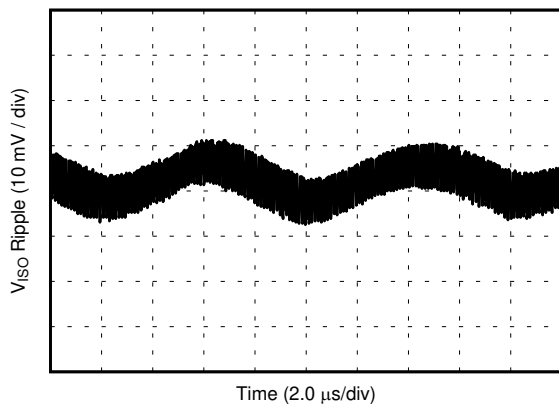

D037

$V_{INP} = 5.0\text{ V}$ $V_{ISO} = 3.7\text{ V}$ Bandwidth = 20 MHz

Figure 8-6. V_{ISO} Ripple, 3.7-V Output, 10% Load

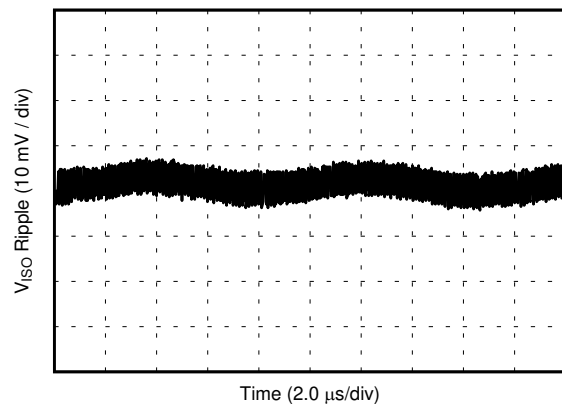

D038

$V_{INP} = 5.0\text{ V}$ $V_{ISO} = 3.7\text{ V}$ Bandwidth = 20 MHz

Figure 8-7. V_{ISO} Ripple, 3.7-V Output, 90% Load

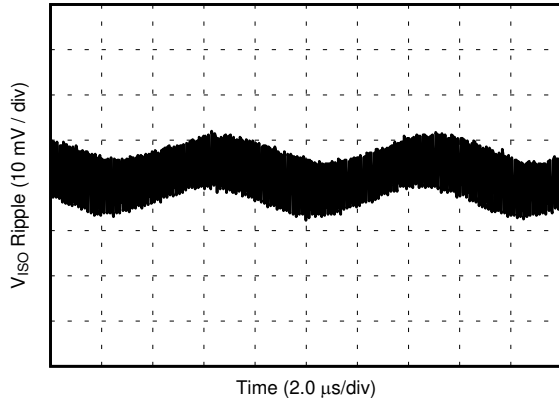

D039

$V_{INP} = 5.0\text{ V}$ $V_{ISO} = 3.3\text{ V}$ Bandwidth = 20 MHz

Figure 8-8. V_{ISO} Ripple, 3.3-V Output, 10% Load

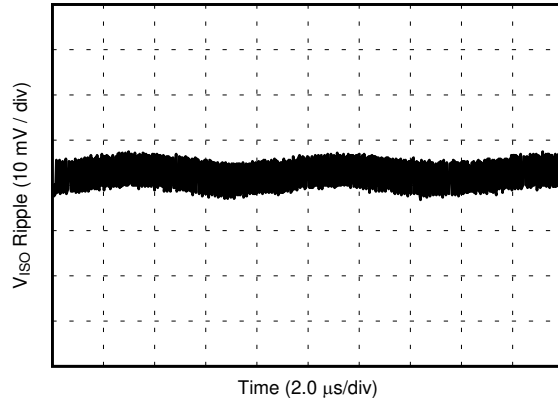

D040

$V_{INP} = 5.0\text{ V}$ $V_{ISO} = 3.3\text{ V}$ Bandwidth = 20 MHz

Figure 8-9. V_{ISO} Ripple, 3.3-V Output, 90% Load

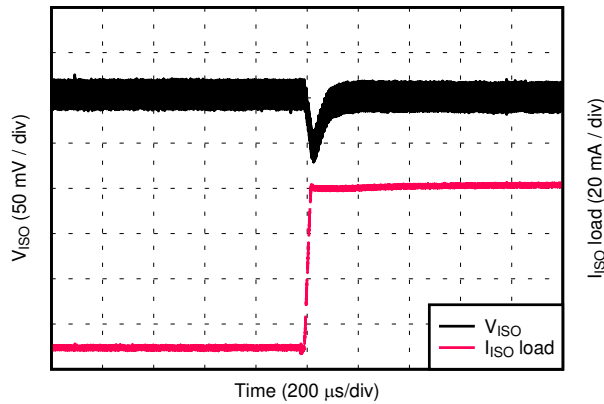

D041

Figure 8-10. V_{ISO} Load Transient Response, 10% to 90% Load Step, 5.0-V Input, 5.4-V Output

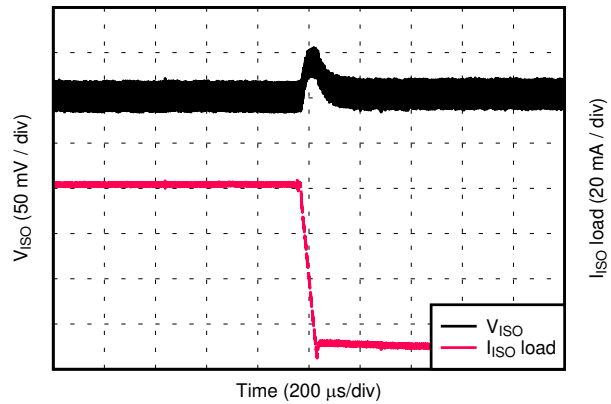

D042

Figure 8-11. V_{ISO} Load Transient Response, 90% to 10% Load Step, 5.0-V Input, 5.4-V Output

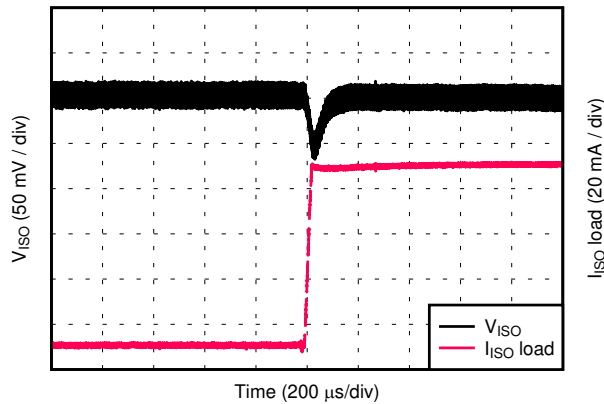

D043

Figure 8-12. V_{ISO} Load Transient Response, 10% to 90% Load Step, 5.0-V Input, 5.0-V Output

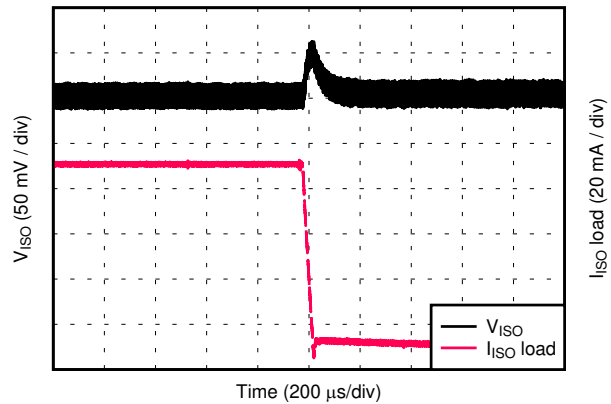

D044

Figure 8-13. V_{ISO} Load Transient Response, 90% to 10% Load Step, 5.0-V Input, 5.0-V Output

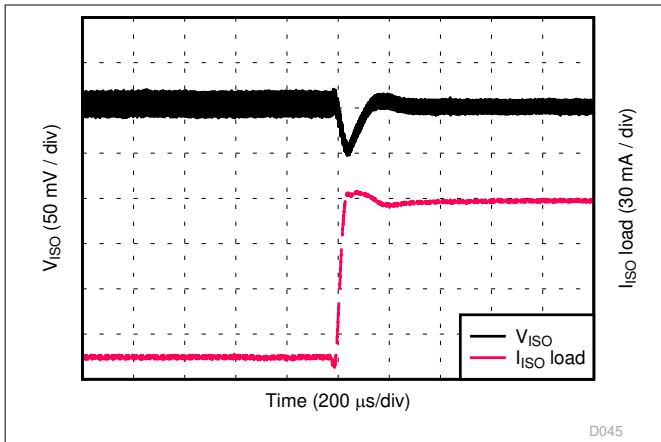

Figure 8-14. V_{ISO} Load Transient Response, 10% to 90% Load Step, 5.0-V Input, 3.7-V Output

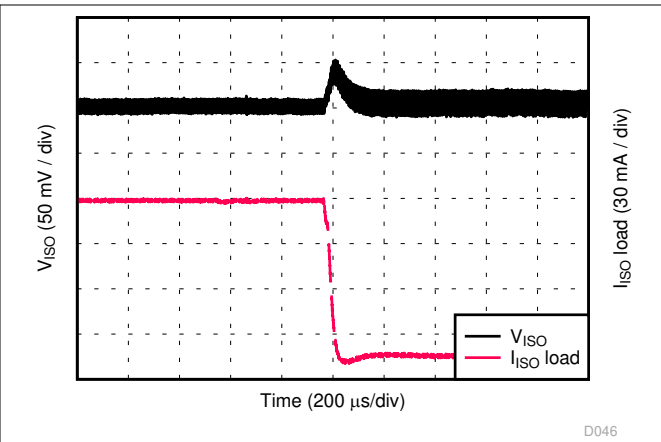

Figure 8-15. V_{ISO} Load Transient Response, 90% to 10% Load Step, 5.0-V Input, 3.7-V Output

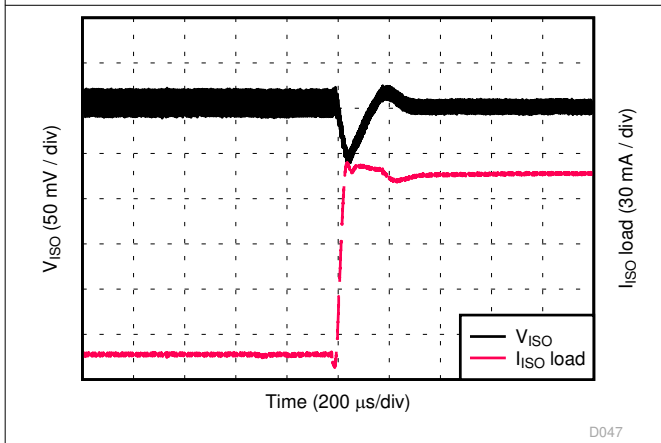

Figure 8-16. V_{ISO} Load Transient Response, 10% to 90% Load Step, 5.0-V Input, 3.3-V Output

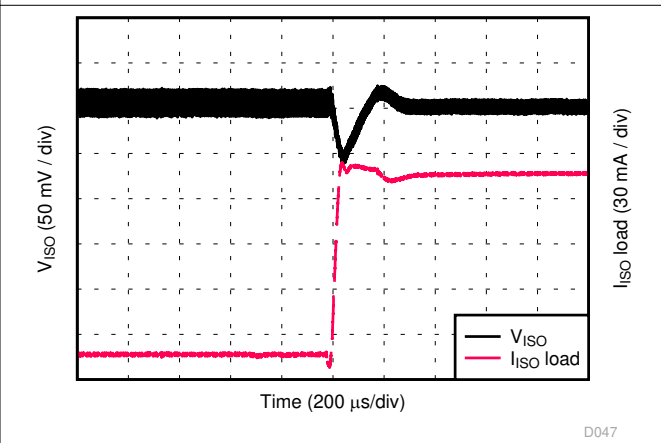

Figure 8-17. V_{ISO} Load Transient Response, 90% to 10% Load Step, 5.0-V Input, 3.3-V Output

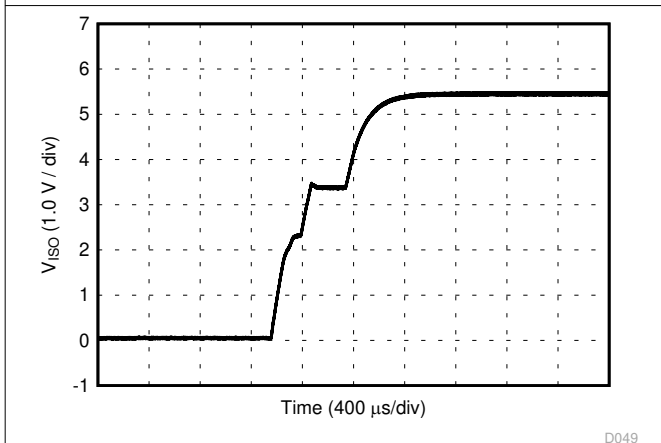

Figure 8-18. V_{ISO} Soft Start at 10% Rated Load, 5.0-V Input, 5.4-V Output

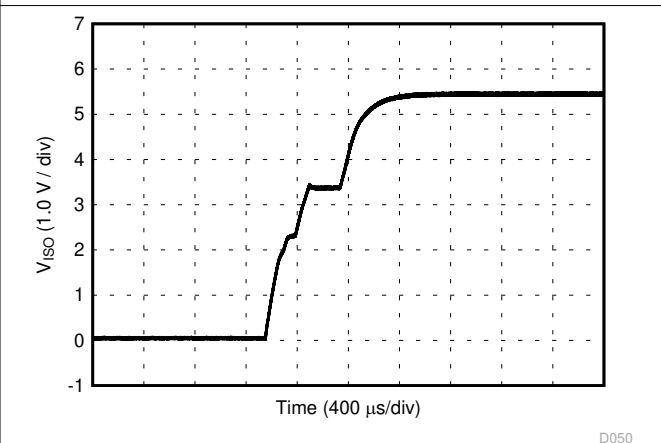
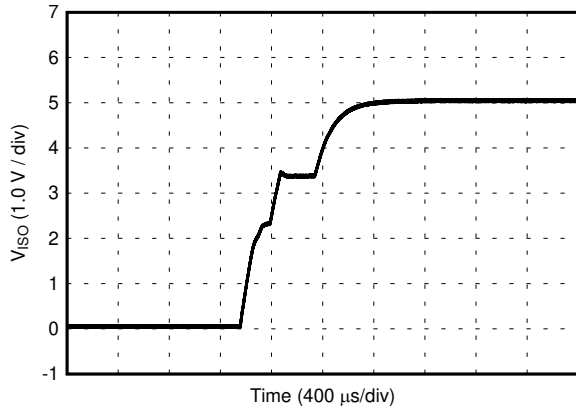
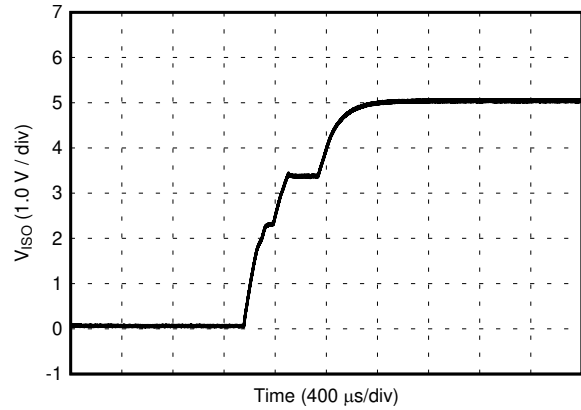

Figure 8-19. V_{ISO} Soft Start at 90% Rated Load, 5.0-V Input, 5.4-V Output



D051

Figure 8-20. V_{ISO} Soft Start at 10% Rated Load, 5.0-V Input, 5.0-V Output



D052

Figure 8-21. V_{ISO} Soft Start at 90% Rated Load, 5.0-V Input, 5.0-V Output

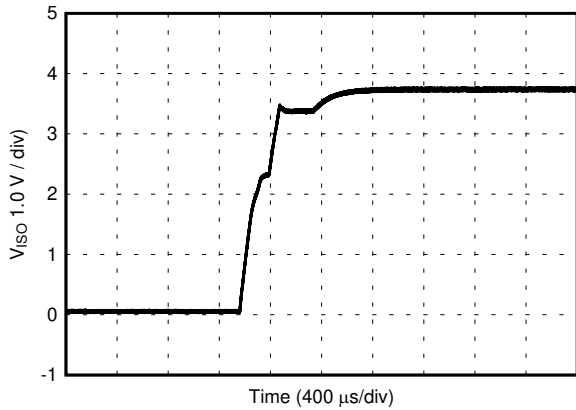

D053

Figure 8-22. V_{ISO} Soft Start at 10% Rated Load, 5.0-V Input, 3.7-V Output

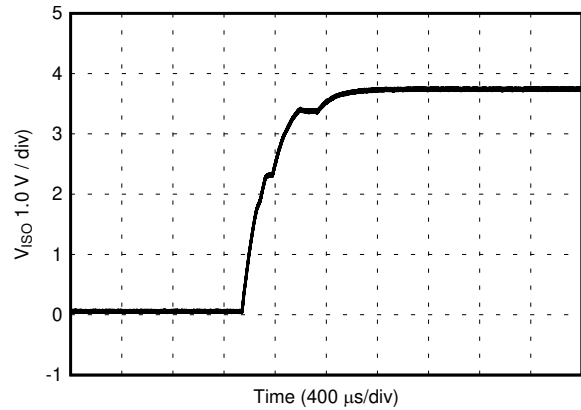

D054

Figure 8-23. V_{ISO} Soft Start at 90% Rated Load, 5.0-V Input, 3.7-V Output

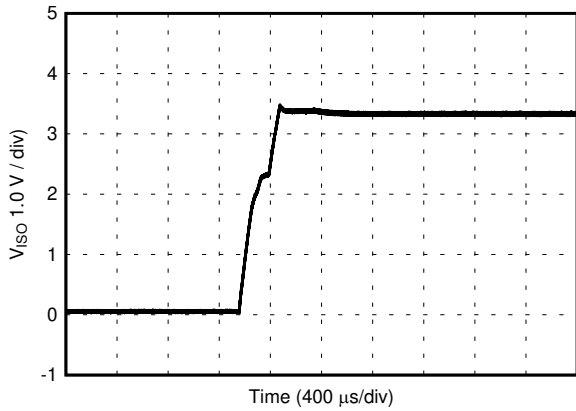

D055

Figure 8-24. V_{ISO} Soft Start at 10% Rated Load, 5.0-V Input, 3.3-V Output

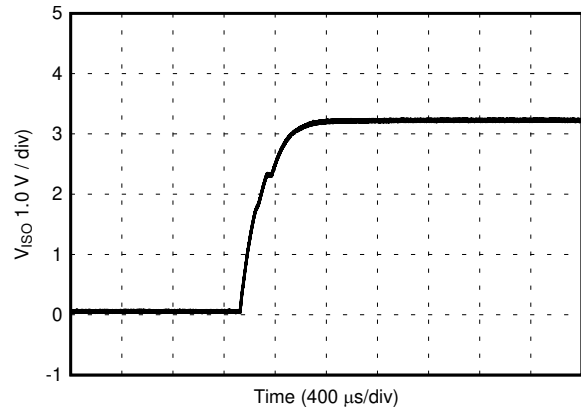

D056

Figure 8-25. V_{ISO} Soft Start at 90% Rated Load, 5.0-V Input, 3.3-V Output

9 Power Supply Recommendations

The recommended input supply voltage (VINP) for the UCC12050 is between 4.5 V and 5.5 V. To help ensure reliable operation, adequate decoupling capacitors must be located as close to supply pins as possible. Place local bypass capacitors between the VINP and GNDP pins at the input, and between VISO and GNDS at the isolated output supply. Low ESR, ceramic surface mount capacitors are recommended. It is further suggested that one place two such capacitors: one with a value of 10 μ F for supply bypassing, and an additional 100-nF capacitor in parallel for high frequency filtering. The input supply must have an appropriate current rating to support output load required by the end application.

10 Layout

10.1 Layout Guidelines

The UCC12050 integrated isolated power solution simplifies system design and reduces board area usage. Proper PCB layout is important in order to achieve optimum performance. Here is a list of recommendations:

1. Place decoupling capacitors as close as possible to the device pins. For the input supply, place the capacitor(s) between pin 3 (VINP) and pin 2 (GNDP). For the isolated output supply, place the capacitor(s) between pin 14 (VISO) and pin 15 (GNDS). This location is of particular importance to the input decoupling capacitor, because this capacitor supplies the transient current associated with the fast switching waveforms of the power drive circuits.
2. Because the device does not have a thermal pad for heat-sinking, the device dissipates heat through the respective GND pins. Ensure that enough copper (preferably a connection to the ground plane) is present on all GNDP and GNDS pins for best heat-sinking.
3. If space and layer count allow, it is also recommended to connect the VINP, GNDP, VISO and GNDS pins to internal ground or power planes through multiple vias of adequate size. Alternatively, make traces for these nets as wide as possible to minimize losses.
4. TI also recommends grounding the no-connect pins (NC) to their respective ground planes. For pins 6, 7, and 8, connect to GNDP. For pins 10, 11, and 12, connect to GNDS. This will allow more continuous ground planes and larger thermal mass for heat-sinking.
5. A minimum of four layers is recommended to accomplish a low-EMI PCB design. Inner layers can be spaced closer than outer layers and used to create a high-frequency bypass capacitor between GNDP and GNDS to reduce radiated emissions. Ensure proper spacing, both inter-layer and layer-to-layer, is implemented to avoid reducing isolation capabilities. These spacings will vary based on the printed circuit board construction parameters, such as dielectric material and thickness.
6. Pay close attention to the spacing between primary ground plane (GNDP) and secondary ground plane (GNDS) on the PCB outer layers. The effective creepage and or clearance of the system will be reduced if the two ground planes have a lower spacing than that of the device package.
7. To ensure isolation performance between the primary and secondary side, avoid placing any PCB traces or copper below the UCC12050 device on the outer copper layers.

10.2 Layout Example

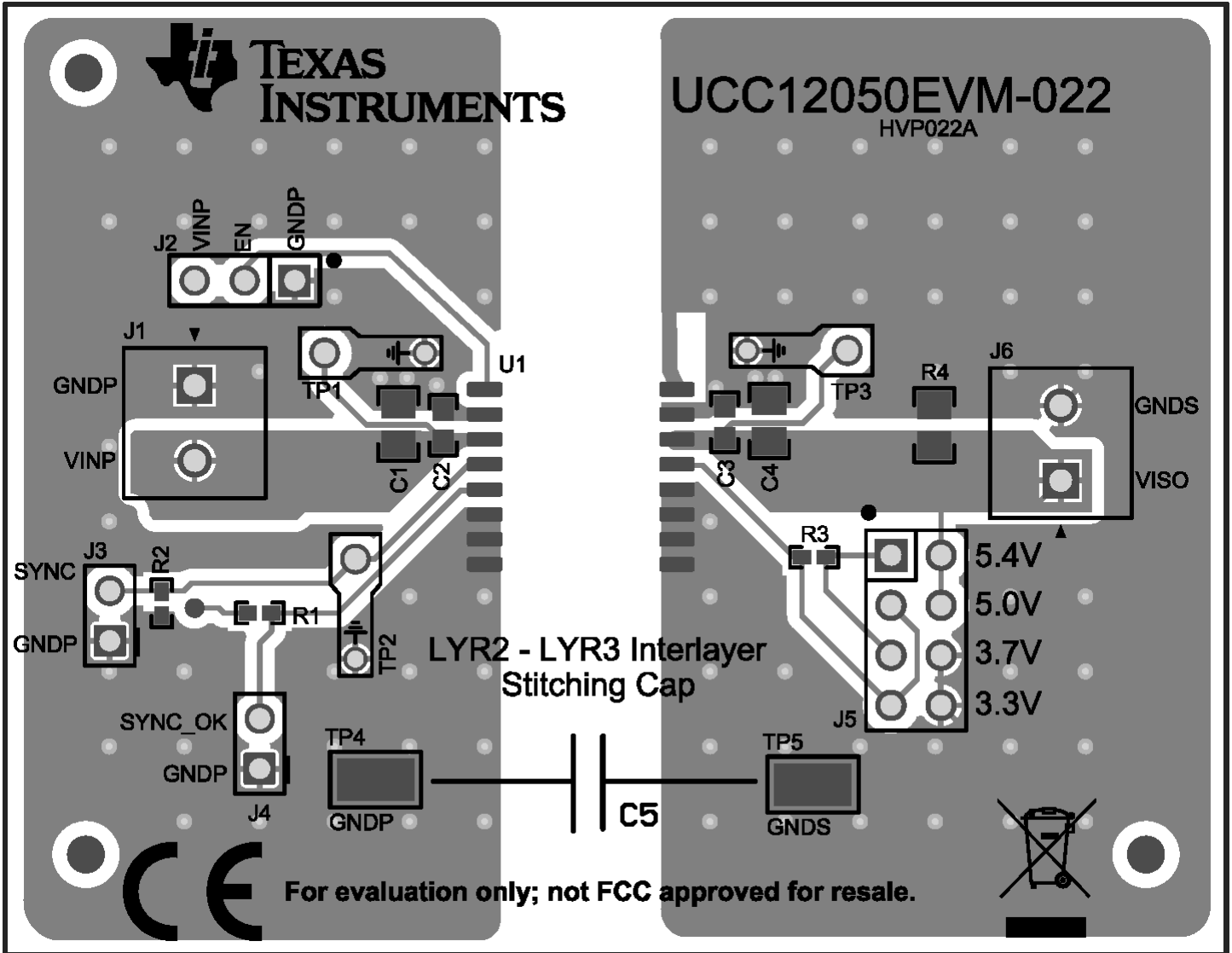

Figure 10-1. Layout Example

11 Device and Documentation Support

11.1 Device Support

11.1.1 Development Support

For development support, refer to:

- [High-efficiency, low-emission, isolated DC/DC converter-based analog input module reference design](#)
- [Isolated delta-sigma modulator based AC/DC voltage and current measurement module reference design](#)
- [Isolated power architecture reference design for communication and analog input/output modules](#)

11.2 Documentation Support

11.2.1 Related Documentation

For related documentation see the following:

- [UCC12050 Evaluation Module User Guide](#)
- [Isolation Glossary](#)
- [A Reinforced-isolated Analog Input Chain for Space-constrained Applications](#)

11.3 Receiving Notification of Documentation Updates

To receive notification of documentation updates, navigate to the device product folder on [ti.com](#). Click on *Subscribe to updates* to register and receive a weekly digest of any product information that has changed. For change details, review the revision history included in any revised document.

11.4 Support Resources

[TI E2E™ support forums](#) are an engineer's go-to source for fast, verified answers and design help — straight from the experts. Search existing answers or ask your own question to get the quick design help you need.

Linked content is provided "AS IS" by the respective contributors. They do not constitute TI specifications and do not necessarily reflect TI's views; see TI's [Terms of Use](#).

11.5 Trademarks

TI E2E™ is a trademark of Texas Instruments.

All trademarks are the property of their respective owners.

11.6 Electrostatic Discharge Caution



This integrated circuit can be damaged by ESD. Texas Instruments recommends that all integrated circuits be handled with appropriate precautions. Failure to observe proper handling and installation procedures can cause damage.

ESD damage can range from subtle performance degradation to complete device failure. Precision integrated circuits may be more susceptible to damage because very small parametric changes could cause the device not to meet its published specifications.

11.7 Glossary

[TI Glossary](#) This glossary lists and explains terms, acronyms, and definitions.

12 Mechanical and Packaging Information

The following pages include mechanical, packaging, and orderable information. This information is the most current data available for the designated devices. This data is subject to change without notice and revision of this document. For browser-based versions of this data sheet, refer to the left-hand navigation.

PACKAGING INFORMATION

Orderable part number	Status (1)	Material type (2)	Package Pins	Package qty Carrier	RoHS (3)	Lead finish/ Ball material (4)	MSL rating/ Peak reflow (5)	Op temp (°C)	Part marking (6)
UCC12050DVE	Active	Production	SO-MOD (DVE) 16	40 TUBE	Yes	NIPDAU	Level-3-260C-168 HR	-40 to 125	UCC12050
UCC12050DVER	Active	Production	SO-MOD (DVE) 16	2000 LARGE T&R	Yes	NIPDAU	Level-3-260C-168 HR	-40 to 125	UCC12050

(1) **Status:** For more details on status, see our [product life cycle](#).

(2) **Material type:** When designated, preproduction parts are prototypes/experimental devices, and are not yet approved or released for full production. Testing and final process, including without limitation quality assurance, reliability performance testing, and/or process qualification, may not yet be complete, and this item is subject to further changes or possible discontinuation. If available for ordering, purchases will be subject to an additional waiver at checkout, and are intended for early internal evaluation purposes only. These items are sold without warranties of any kind.

(3) **RoHS values:** Yes, No, RoHS Exempt. See the [TI RoHS Statement](#) for additional information and value definition.

(4) **Lead finish/Ball material:** Parts may have multiple material finish options. Finish options are separated by a vertical ruled line. Lead finish/Ball material values may wrap to two lines if the finish value exceeds the maximum column width.

(5) **MSL rating/Peak reflow:** The moisture sensitivity level ratings and peak solder (reflow) temperatures. In the event that a part has multiple moisture sensitivity ratings, only the lowest level per JEDEC standards is shown. Refer to the shipping label for the actual reflow temperature that will be used to mount the part to the printed circuit board.

(6) **Part marking:** There may be an additional marking, which relates to the logo, the lot trace code information, or the environmental category of the part.

Multiple part markings will be inside parentheses. Only one part marking contained in parentheses and separated by a "~" will appear on a part. If a line is indented then it is a continuation of the previous line and the two combined represent the entire part marking for that device.

Important Information and Disclaimer:The information provided on this page represents TI's knowledge and belief as of the date that it is provided. TI bases its knowledge and belief on information provided by third parties, and makes no representation or warranty as to the accuracy of such information. Efforts are underway to better integrate information from third parties. TI has taken and continues to take reasonable steps to provide representative and accurate information but may not have conducted destructive testing or chemical analysis on incoming materials and chemicals. TI and TI suppliers consider certain information to be proprietary, and thus CAS numbers and other limited information may not be available for release.

In no event shall TI's liability arising out of such information exceed the total purchase price of the TI part(s) at issue in this document sold by TI to Customer on an annual basis.

TAPE AND REEL INFORMATION

QUADRANT ASSIGNMENTS FOR PIN 1 ORIENTATION IN TAPE

*All dimensions are nominal

Device	Package Type	Package Drawing	Pins	SPQ	Reel Diameter (mm)	Reel Width W1 (mm)	A0 (mm)	B0 (mm)	K0 (mm)	P1 (mm)	W (mm)	Pin1 Quadrant
UCC12050DVER	SO-MOD	DVE	16	2000	330.0	16.4	10.75	10.7	2.7	12.0	16.0	Q1

TAPE AND REEL BOX DIMENSIONS



*All dimensions are nominal

Device	Package Type	Package Drawing	Pins	SPQ	Length (mm)	Width (mm)	Height (mm)
UCC12050DVER	SO-MOD	DVE	16	2000	350.0	350.0	43.0

TUBE

*All dimensions are nominal

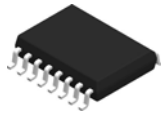
Device	Package Name	Package Type	Pins	SPQ	L (mm)	W (mm)	T (μm)	B (mm)
UCC12050DVE	DVE	SO-MOD	16	40	506.98	12.7	4826	6.6



PACKAGE OUTLINE

DVE0016A

SO-MOD - 2.65 mm max height

SMALL OUTLINE INTEGRATED CIRCUIT

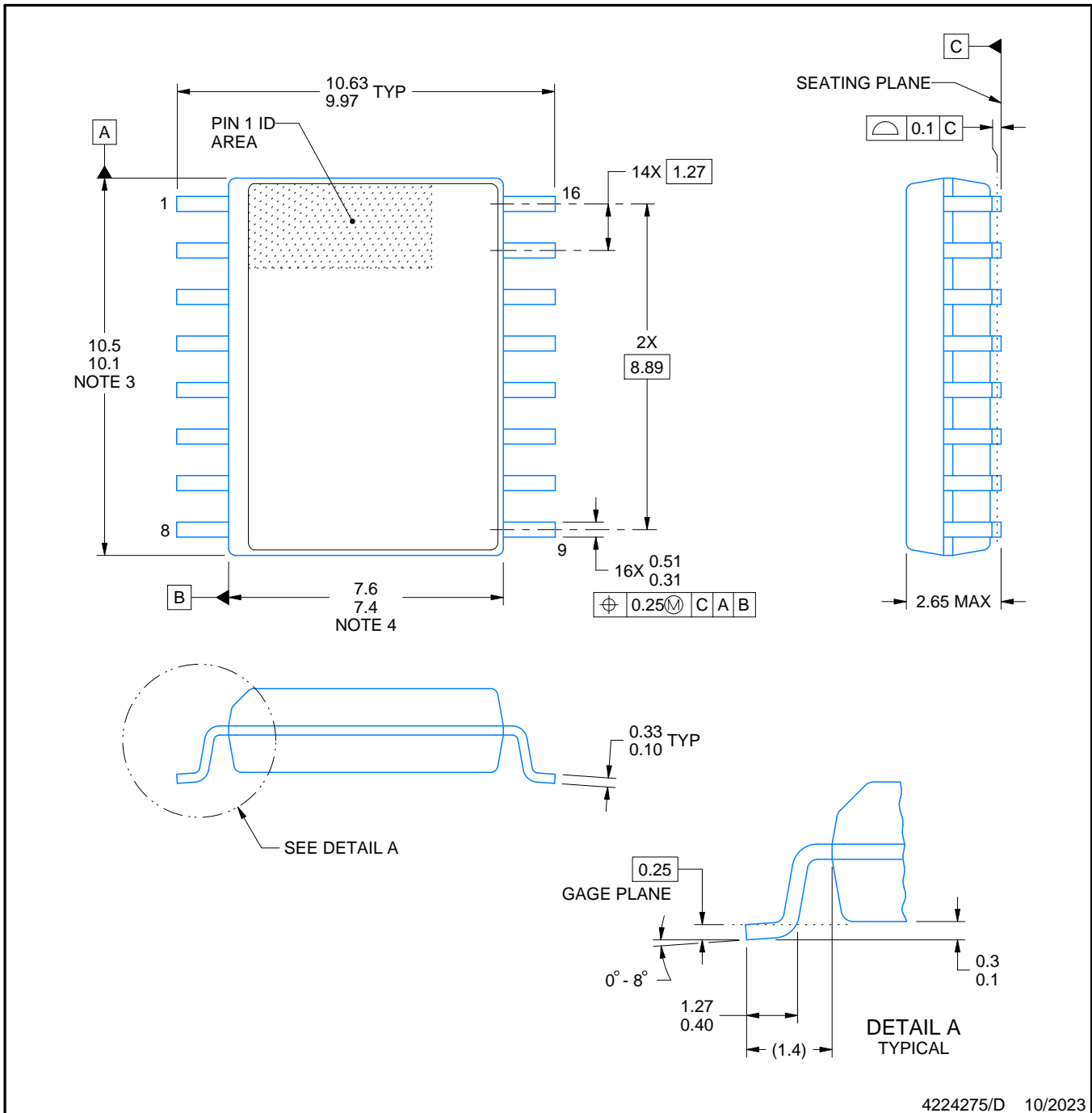

NOTES:

1. All linear dimensions are in millimeters. Any dimensions in parenthesis are for reference only. Dimensioning and tolerancing per ASME Y14.5M.
2. This drawing is subject to change without notice.
3. This dimension does not include mold flash, protrusions, or gate burrs. Mold flash, protrusions, or gate burrs shall not exceed 0.15 mm, per side.
4. This dimension does not include interlead flash. Interlead flash shall not exceed 0.25 mm, per side.
5. Reference JEDEC registration MS-013.

EXAMPLE BOARD LAYOUT

DVE0016A

SO-MOD - 2.65 mm max height

SMALL OUTLINE INTEGRATED CIRCUIT

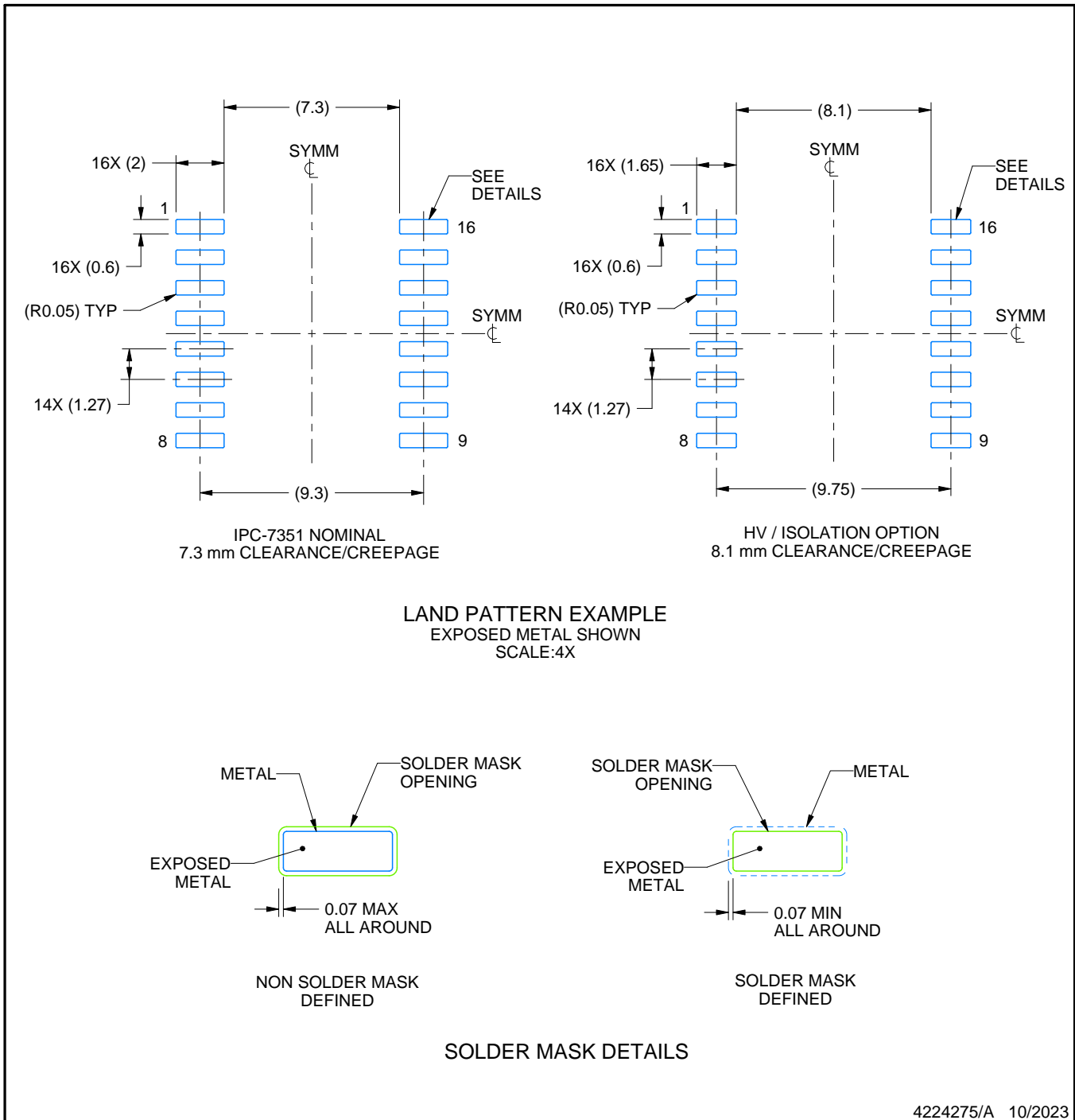

NOTES: (continued)

6. Publication IPC-7351 may have alternate designs.
7. Solder mask tolerances between and around signal pads can vary based on board fabrication site.

EXAMPLE STENCIL DESIGN

DVE0016A

SO-MOD - 2.65 mm max height

SMALL OUTLINE INTEGRATED CIRCUIT

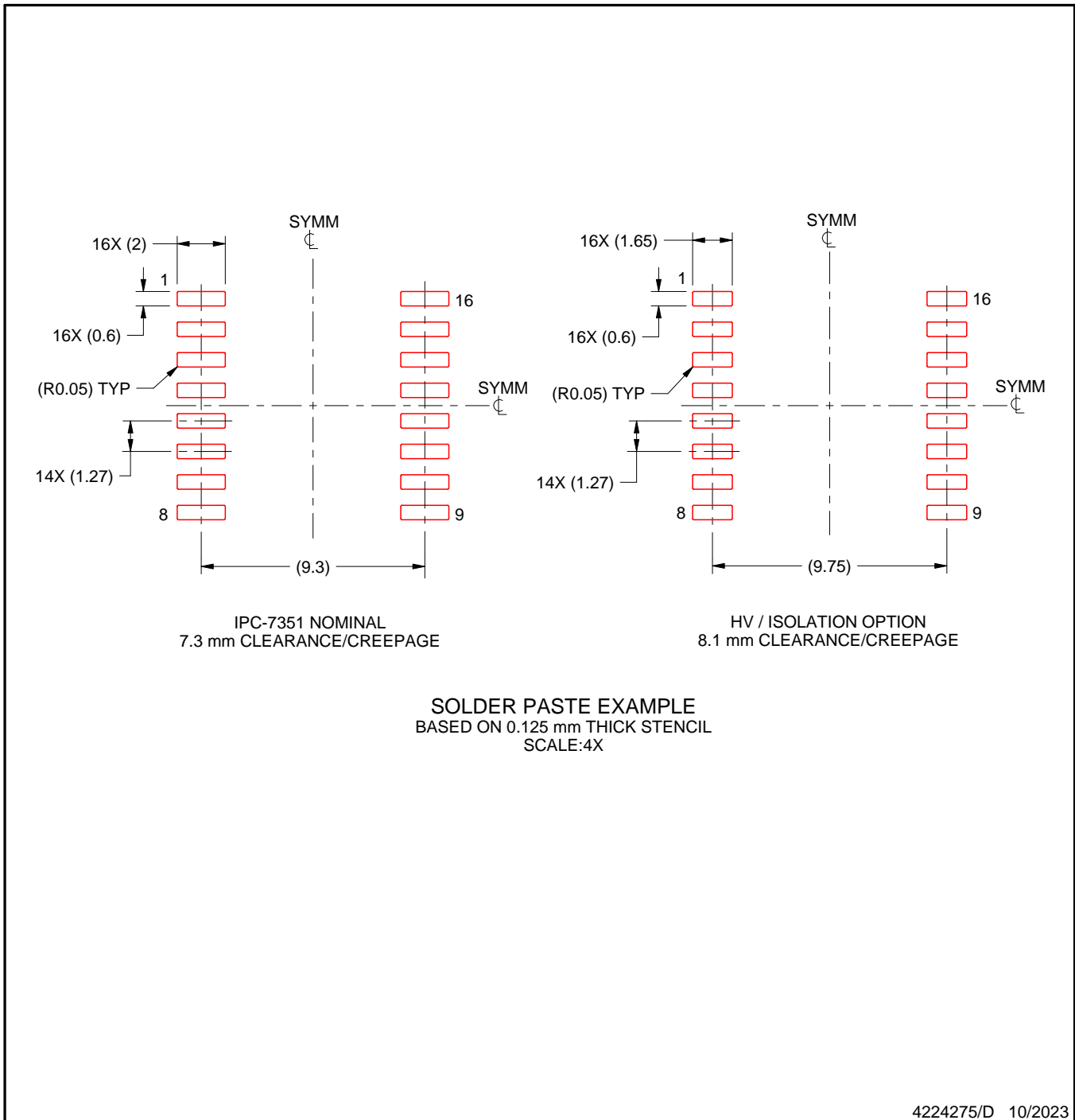

NOTES: (continued)

8. Laser cutting apertures with trapezoidal walls and rounded corners may offer better paste release. IPC-7525 may have alternate design recommendations.
9. Board assembly site may have different recommendations for stencil design.

IMPORTANT NOTICE AND DISCLAIMER

TI PROVIDES TECHNICAL AND RELIABILITY DATA (INCLUDING DATA SHEETS), DESIGN RESOURCES (INCLUDING REFERENCE DESIGNS), APPLICATION OR OTHER DESIGN ADVICE, WEB TOOLS, SAFETY INFORMATION, AND OTHER RESOURCES "AS IS" AND WITH ALL FAULTS, AND DISCLAIMS ALL WARRANTIES, EXPRESS AND IMPLIED, INCLUDING WITHOUT LIMITATION ANY IMPLIED WARRANTIES OF MERCHANTABILITY, FITNESS FOR A PARTICULAR PURPOSE OR NON-INFRINGEMENT OF THIRD PARTY INTELLECTUAL PROPERTY RIGHTS.

These resources are intended for skilled developers designing with TI products. You are solely responsible for (1) selecting the appropriate TI products for your application, (2) designing, validating and testing your application, and (3) ensuring your application meets applicable standards, and any other safety, security, regulatory or other requirements.

These resources are subject to change without notice. TI grants you permission to use these resources only for development of an application that uses the TI products described in the resource. Other reproduction and display of these resources is prohibited. No license is granted to any other TI intellectual property right or to any third party intellectual property right. TI disclaims responsibility for, and you will fully indemnify TI and its representatives against, any claims, damages, costs, losses, and liabilities arising out of your use of these resources.

TI's products are provided subject to [TI's Terms of Sale](#) or other applicable terms available either on [ti.com](https://www.ti.com) or provided in conjunction with such TI products. TI's provision of these resources does not expand or otherwise alter TI's applicable warranties or warranty disclaimers for TI products.

TI objects to and rejects any additional or different terms you may have proposed.

Mailing Address: Texas Instruments, Post Office Box 655303, Dallas, Texas 75265

Copyright © 2025, Texas Instruments Incorporated