

MSP430G2412 Device Erratasheet

1 Functional Errata Revision History

Errata impacting device's operation, function or parametrics.

✓ The check mark indicates that the issue is present in the specified revision.

Errata Number	Rev B	Rev A
BCL12	✓	✓
BCL14	✓	✓
SYS15	✓	✓
TA12	✓	✓
TA16	✓	✓
TA21	✓	✓
TAB22	✓	✓
USI4	✓	✓
USI5	✓	✓
XOSC5	✓	✓

2 Preprogrammed Software Errata Revision History

Errata impacting pre-programmed software into the silicon by Texas Instruments.

✓ The check mark indicates that the issue is present in the specified revision.

The device doesn't have Software in ROM errata.

3 Debug only Errata Revision History

Errata only impacting debug operation.

✓ The check mark indicates that the issue is present in the specified revision.

Errata Number	Rev B	Rev A
EEM20	✓	✓

4 Fixed by Compiler Errata Revision History

Errata completely resolved by compiler workaround. Refer to specific erratum for IDE and compiler versions with workaround.

✓ The check mark indicates that the issue is present in the specified revision.

Errata Number	Rev B	Rev A
CPU4	✓	✓

Refer to the following MSP430 compiler documentation for more details about the CPU bugs workarounds.

TI MSP430 Compiler Tools (Code Composer Studio IDE)

- [MSP430 Optimizing C/C++ Compiler](#): Check the --silicon_errata option
- [MSP430 Assembly Language Tools](#)

MSP430 GNU Compiler (MSP430-GCC)

- [MSP430 GCC Options](#): Check -msilicon-errata= and -msilicon-errata-warn= options
- [MSP430 GCC User's Guide](#)

IAR Embedded Workbench

- [IAR workarounds for msp430 hardware issues](#)

5 Package Markings

N20

PDIP (N), 20 Pin

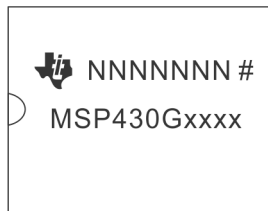

= Die revision
N = Lot trace code

PW14

TSSOP (PW), 14 Pin



= Die revision
○ = Pin 1 location
N = Lot trace code

PW20

TSSOP (PW), 20 Pin

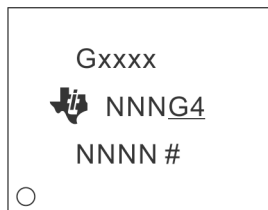

= Die revision
○ = Pin 1 location
N = Lot trace code

RSA16

QFN (RSA), 16 Pin

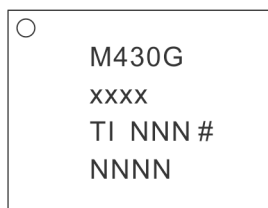

= Die revision
○ = Pin 1 location
N = Lot trace code

6 Detailed Bug Description

BCL12 *BCS Module*

Category Functional

Function Switching RSELx or modifying DCOCTL can cause DCO dead time or a complete DCO stop

Description After switching RSELx bits (located in register BCCTL1) from a value of >13 to a value of <12 OR from a value of <12 to a value of >13, the resulting clock delivered by the DCO can stop before the new clock frequency is applied. This dead time is approximately 20 us. In some instances, the DCO may completely stop, requiring a power cycle.

Furthermore, if all of the RSELx bits in the BCCTL1 register are set, modifying the DCOCTL register to change the DCOx or the MODx bits could also result in DCO dead time or DCO hang up.

Workaround - When switching RSEL from >13 to <12, use an intermediate frequency step. The intermediate RSEL value should be 13.

Current RSEL	Target RSEL	Recommended Transition Sequence
15	14	Switch directly to target RSEL
14 or 15	13	Switch directly to target RSEL
14 or 15	0 to 12	Switch to 13 first, and then to target RSEL (two step sequence)
0 to 13	0 to 12	Switch directly to target RSEL

AND

- When switching RSEL from <12 to >13 it's recommended to set RSEL to its default value first (RSEL = 7) before switching to the desired target frequency.

AND

- In case RSEL is at 15 (highest setting) it's recommended to set RSEL to its default value first (RSEL = 7) before accessing DCOCTL to modify the DCOx and MODx bits. After the DCOCTL register modification the RSEL bits can be manipulated in an additional step.

In the majority of cases switching directly to intermediate RSEL steps as described above will prevent the occurrence of BCL12. However, a more reliable method can be implemented by changing the RSEL bits step by step in order to guarantee safe function without any dead time of the DCO.

Note that the 3-step clock startup sequence consisting of clearing DCOCTL, loading the BCCTL1 target value, and finally loading the DCOCTL target value as suggested in the in the "TLV Structure" chapter of the [MSP430x2xx Family User's Guide](#) is not affected by BCL12 if (and only if) it is executed after a device reset (PUC) prior to any other modifications being made to BCCTL1 since in this case RSEL still is at its default value of 7. However any further changes to the DCOx and MODx bits will require the consideration of the workaround outlined above.

BCL14 *BCS Module*

Category Functional

Function Oscillator fault forced in bypass mode when P2SEL.7 bit is not set

Description When the LFXT1 oscillator is used in bypass mode and P2SEL.7 is not set, the oscillator

fault flag (OFIFG) will be forced to set and cannot be cleared. Due to the failsafe logic, LFXT1 cannot be used as MCLK in this case. The bug only affects the behavior of the oscillator fault, the clocking itself works properly.

Workaround

Set both P2SEL.6 and P2SEL.7 if the application requires correct function of the oscillator fault flag (e.g. MCLK failsafe logic).

NOTE: Setting P2SEL.7 bit disables the GPIO functionality and enables the input schmitt trigger of the pin. P2.7 should be tied to a fixed voltage level (VCC or GND) to prevent cross current.

CPU4
CPU Module

Category

Compiler-Fixed

Function

PUSH #4, PUSH #8CPU4 - Bug

Description

The single operand instruction PUSH cannot use the internal constants (CG) 4 and 8. The other internal constants (0, 1, 2, -1) can be used. The number of clock cycles is different:

PUSH #CG uses address mode 00, requiring 3 cycles, 1 word instruction

PUSH #4/#8 uses address mode 11, requiring 5 cycles, 2 word instruction

Workaround

Refer to the table below for compiler-specific fix implementation information.

IDE/Compiler	Version Number	Notes
IAR Embedded Workbench	IAR EW430 v2.x until v6.20	User is required to add the compiler flag option below. --hw_workaround=CPU4
IAR Embedded Workbench	IAR EW430 v6.20 or later	Workaround is automatically enabled
TI MSP430 Compiler Tools (Code Composer Studio)	v1.1 or later	
MSP430 GNU Compiler (MSP430-GCC)	MSP430-GCC 4.9 build 167 or later	

EEM20
EEM Module

Category

Debug

Function

Debugger might clear interrupt flags

Description

During debugging read-sensitive interrupt flags might be cleared as soon as the debugger stops. This is valid in both single-stepping and free run modes.

Workaround

None.

SYS15
SYS Module

Category

Functional

Function

LPM3 and LPM4 currents exceed specified limits

Description LPM3 and LPM4 currents may exceed specified limits if the SMCLK source is switched from DCO to VLO or LFXT1 just before the instruction to enter LPM3 or LPM4 mode.

Workaround After clock switching, a delay of at least four new clock cycles (VLO or LFXT1) must be implemented to complete the clock synchronization before going into LPM3 or LPM4.

TA12 *TIMER_A Module*

Category Functional

Function Interrupt is lost (slow ACLK)

Description Timer_A counter is running with slow clock (external TACLK or ACLK) compared to MCLK. The compare mode is selected for the capture/compare channel and the CCRx register is incremented by one with the occurring compare interrupt (if TAR = CCRx). Due to the fast MCLK the CCRx register increment (CCRx = CCRx+1) happens before the Timer_A counter has incremented again. Therefore the next compare interrupt should happen at once with the next Timer_A counter increment (if TAR = CCRx + 1). This interrupt gets lost.

Workaround Switch capture/compare mode to capture mode before the CCRx register increment. Switch back to compare mode afterwards.

TA16 *TIMER_A Module*

Category Functional

Function First increment of TAR erroneous when IDx > 00

Description The first increment of TAR after any timer clear event (POR/TACLR) happens immediately following the first positive edge of the selected clock source (INCLK, SMCLK, ACLK or TACLK). This is independent of the clock input divider settings (ID0, ID1). All following TAR increments are performed correctly with the selected IDx settings.

Workaround None

TA21 *TIMER_A Module*

Category Functional

Function TAIFG Flag is erroneously set after Timer A restarts in Up Mode

Description In Up Mode, the TAIFG flag should only be set when the timer counts from TACCR0 to zero. However, if the Timer A is stopped at TAR = TACCR0, then cleared (TAR=0) by setting the TACLR bit, and finally restarted in Up Mode, the next rising edge of the TACLK will erroneously set the TAIFG flag.

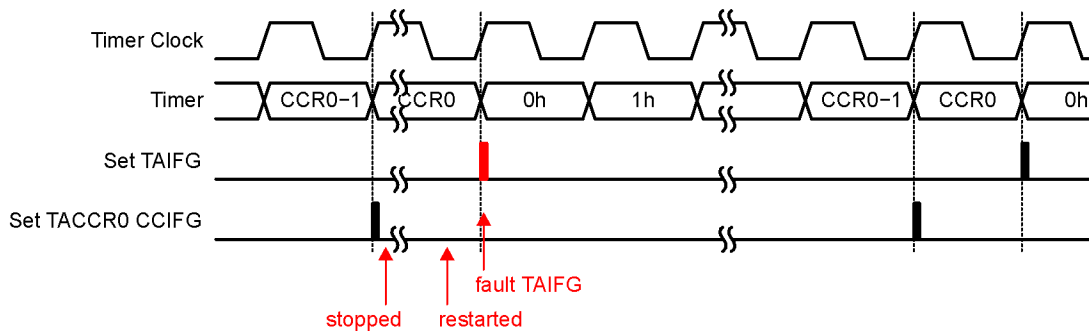

Workaround None.

TAB22 *TIMER_A/TIMER_B Module*

Category Functional

Function Timer_A/Timer_B register modification after Watchdog Timer PUC

Description Unwanted modification of the Timer_A/Timer_B registers TACTL/TBCTL and TAIV/TBIV can occur when a PUC is generated by the Watchdog Timer(WDT) in Watchdog mode and any Timer_A/Timer_B counter register TACCRx/TBCCRx is incremented/decremented (Timer_A/Timer_B does not need to be running).

Workaround Initialize TACTL/TBCTL register after the reset occurs using a MOV instruction (BIS/BIC may not fully initialize the register). TAIV/TBIV is automatically cleared following this initialization.

Example code:

```
MOV.W #VAL, &TACTL
```

or

```
MOV.W #VAL, &TBCTL
```

Where, VAL=0, if Timer is not used in application otherwise, user defined per desired function.

USI4 *USI Module*

Category Functional

Function I2C Slave mode can generate a glitch at SCL

Description USI I2C Slave Operation at slower communication rates (less than 20kbps). During I2C bus active operation, if USICNT is written while SCL is high, I2C module will generate a glitch on SCL that can corrupt the I2C bus sequence.

Workaround Verify that SCL is low before writing USICNT register.

USI5 *USI Module*

Category Functional

Function	SPI master generates one additional clock after module reset
Description	Initializing the USI in SPI MASTER mode with the USICKPH bit set generates one additional clock pulse than defined by the value in the USICNTx bits on the SCLK pin during the first data transfer after module reset. For example, if the USICNTx bits hold the value eight, nine clock pulses are generated on the SCLK pin for the first transfer only.
Workaround	Load USICNTx with a count of N-1 bits (where N is the required number of bits) for the first transfer only.

XOSC5 *XOSC Module*

Category	Functional
Function	LF crystal failures may not be properly detected by the oscillator fault circuitry
Description	The oscillator fault error detection of the LFXT1 oscillator in low frequency mode (XTS = 0) may not work reliably causing a failing crystal to go undetected by the CPU, i.e. OFIFG will not be set.
Workaround	None

7 Document Revision History

Changes from family erratasheet to device specific erratasheet.

1. Errata EEM20 was added
2. Errata TA22 was renamed to TAB22
3. Description for TAB22 was updated

Changes from device specific erratasheet to document Revision A.

1. USI5 Workaround was updated.

Changes from document Revision A to Revision B.

1. BCL12 Workaround was updated.

Changes from document Revision B to Revision C.

1. Errata TA21 was added to the errata documentation.

Changes from document Revision C to Revision D.

1. Silicon Revision B was added to the errata documentation.

Changes from document Revision D to Revision E.

1. BCL14 Workaround was updated.

Changes from document Revision E to Revision F.

1. Package Markings section was updated.

Changes from document Revision F to Revision G.

1. TA21 Description was updated.

Changes from document Revision G to Revision H.

1. Function for CPU4 was updated.
2. Workaround for CPU4 was updated.

Changes from document Revision H to Revision I.

1. Erratasheet format update.
2. Added errata category field to "Detailed bug description" section

IMPORTANT NOTICE FOR TI DESIGN INFORMATION AND RESOURCES

Texas Instruments Incorporated ("TI") technical, application or other design advice, services or information, including, but not limited to, reference designs and materials relating to evaluation modules, (collectively, "TI Resources") are intended to assist designers who are developing applications that incorporate TI products; by downloading, accessing or using any particular TI Resource in any way, you (individually or, if you are acting on behalf of a company, your company) agree to use it solely for this purpose and subject to the terms of this Notice.

TI's provision of TI Resources does not expand or otherwise alter TI's applicable published warranties or warranty disclaimers for TI products, and no additional obligations or liabilities arise from TI providing such TI Resources. TI reserves the right to make corrections, enhancements, improvements and other changes to its TI Resources.

You understand and agree that you remain responsible for using your independent analysis, evaluation and judgment in designing your applications and that you have full and exclusive responsibility to assure the safety of your applications and compliance of your applications (and of all TI products used in or for your applications) with all applicable regulations, laws and other applicable requirements. You represent that, with respect to your applications, you have all the necessary expertise to create and implement safeguards that (1) anticipate dangerous consequences of failures, (2) monitor failures and their consequences, and (3) lessen the likelihood of failures that might cause harm and take appropriate actions. You agree that prior to using or distributing any applications that include TI products, you will thoroughly test such applications and the functionality of such TI products as used in such applications. TI has not conducted any testing other than that specifically described in the published documentation for a particular TI Resource.

You are authorized to use, copy and modify any individual TI Resource only in connection with the development of applications that include the TI product(s) identified in such TI Resource. NO OTHER LICENSE, EXPRESS OR IMPLIED, BY ESTOPPEL OR OTHERWISE TO ANY OTHER TI INTELLECTUAL PROPERTY RIGHT, AND NO LICENSE TO ANY TECHNOLOGY OR INTELLECTUAL PROPERTY RIGHT OF TI OR ANY THIRD PARTY IS GRANTED HEREIN, including but not limited to any patent right, copyright, mask work right, or other intellectual property right relating to any combination, machine, or process in which TI products or services are used. Information regarding or referencing third-party products or services does not constitute a license to use such products or services, or a warranty or endorsement thereof. Use of TI Resources may require a license from a third party under the patents or other intellectual property of the third party, or a license from TI under the patents or other intellectual property of TI.

TI RESOURCES ARE PROVIDED "AS IS" AND WITH ALL FAULTS. TI DISCLAIMS ALL OTHER WARRANTIES OR REPRESENTATIONS, EXPRESS OR IMPLIED, REGARDING TI RESOURCES OR USE THEREOF, INCLUDING BUT NOT LIMITED TO ACCURACY OR COMPLETENESS, TITLE, ANY EPIDEMIC FAILURE WARRANTY AND ANY IMPLIED WARRANTIES OF MERCHANTABILITY, FITNESS FOR A PARTICULAR PURPOSE, AND NON-INFRINGEMENT OF ANY THIRD PARTY INTELLECTUAL PROPERTY RIGHTS.

TI SHALL NOT BE LIABLE FOR AND SHALL NOT DEFEND OR INDEMNIFY YOU AGAINST ANY CLAIM, INCLUDING BUT NOT LIMITED TO ANY INFRINGEMENT CLAIM THAT RELATES TO OR IS BASED ON ANY COMBINATION OF PRODUCTS EVEN IF DESCRIBED IN TI RESOURCES OR OTHERWISE. IN NO EVENT SHALL TI BE LIABLE FOR ANY ACTUAL, DIRECT, SPECIAL, COLLATERAL, INDIRECT, PUNITIVE, INCIDENTAL, CONSEQUENTIAL OR EXEMPLARY DAMAGES IN CONNECTION WITH OR ARISING OUT OF TI RESOURCES OR USE THEREOF, AND REGARDLESS OF WHETHER TI HAS BEEN ADVISED OF THE POSSIBILITY OF SUCH DAMAGES.

You agree to fully indemnify TI and its representatives against any damages, costs, losses, and/or liabilities arising out of your non-compliance with the terms and provisions of this Notice.

This Notice applies to TI Resources. Additional terms apply to the use and purchase of certain types of materials, TI products and services. These include; without limitation, TI's standard terms for semiconductor products (<http://www.ti.com/sc/docs/stdterms.htm>), [evaluation modules](#), and [samples](http://www.ti.com/sc/docs/sampterm.htm) (<http://www.ti.com/sc/docs/sampterm.htm>).

Mailing Address: Texas Instruments, Post Office Box 655303, Dallas, Texas 75265
Copyright © 2018, Texas Instruments Incorporated