



12-Bit, 8-Channel, Parallel Output ANALOG-TO-DIGITAL CONVERTER

FEATURES

- 2.5V INTERNAL REFERENCE
- 8 INPUT CHANNELS
- 500kHz SAMPLING RATE
- SINGLE 5V SUPPLY
- ± 1 LSB: INL, DNL
- NO MISSING CODES
- 70dB SINAD
- LOW POWER: 13mW
- TQFP-32 PACKAGE

APPLICATIONS

- DATA ACQUISITION
- TEST AND MEASUREMENT
- INDUSTRIAL PROCESS CONTROL
- MEDICAL INSTRUMENTS

DESCRIPTION

The ADS7852 is an 8-channel, 12-bit Analog-to-Digital (A/D) converter complete with sample-and-hold, internal 2.5V reference and a full 12-bit parallel output interface. Typical power dissipation is 13mW at 500kHz throughput rate. The ADS7852 features both a nap mode and a sleep mode, further reducing the power consumption to 2mW. The input range is from 0V to twice the reference voltage. The reference voltage can be overdriven by an external voltage.

The ADS7852 is ideal for multi-channel applications where low power and small size are critical. Medical instrumentation, high-speed data acquisition and laboratory equipment are just a few of the applications that would take advantage of the special features offered by the ADS7852. The ADS7852 is available in an TQFP-32 package and is fully specified and ensured over the -40°C to $+85^{\circ}\text{C}$ temperature range.

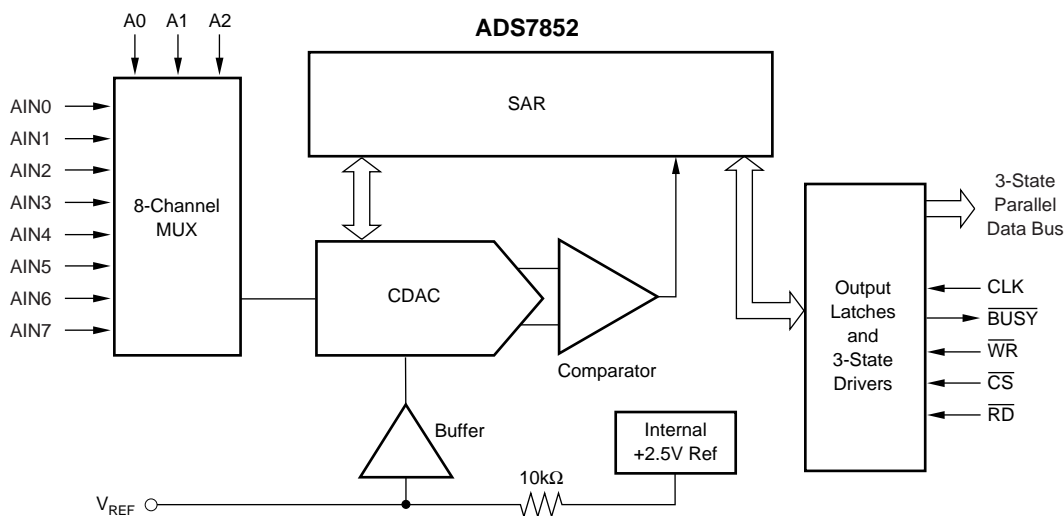

Please be aware that an important notice concerning availability, standard warranty, and use in critical applications of Texas Instruments semiconductor products and disclaimers thereto appears at the end of this data sheet.

All trademarks are the property of their respective owners.

ABSOLUTE MAXIMUM RATINGS⁽¹⁾

Analog Inputs to AGND, Any Channel Input	-0.3V to ($V_D + 0.3V$)
REF _{IN}	-0.3V to ($V_D + 0.3V$)
Digital Inputs to DGND	-0.3V to ($V_D + 0.3V$)
Ground Voltage Differences: AGND, DGND	±0.3V
+V _{SS} to AGND	-0.3V to 6V
Power Dissipation	325mW
Maximum Junction Temperature	+150°C
Operating Temperature Range	-40°C to +85°C
Storage Temperature Range	-65°C to +150°C
Lead Temperature (soldering, 10s)	+300°C

NOTE: (1) Stresses above those listed under "Absolute Maximum Ratings" may cause permanent damage to the device. Exposure to absolute maximum conditions for extended periods may affect device reliability.



ELECTROSTATIC DISCHARGE SENSITIVITY

This integrated circuit can be damaged by ESD. Texas Instruments recommends that all integrated circuits be handled with appropriate precautions. Failure to observe proper handling and installation procedures can cause damage.

ESD damage can range from subtle performance degradation to complete device failure. Precision integrated circuits may be more susceptible to damage because very small parametric changes could cause the device not to meet published specifications.

PACKAGE/ORDERING INFORMATION⁽¹⁾

PRODUCT	MAXIMUM RELATIVE ACCURACY (LSB)	MAXIMUM GAIN ERROR (LSB)	PACKAGE-LEAD	PACKAGE DESIGNATOR	SPECIFIED TEMPERATURE RANGE	PACKAGE MARKING	ORDERING NUMBER	TRANSPORT MEDIA, QUANTITY
ADS7852Y	±2	±40	TQFP-32	PBS	-40°C to +85°C	A52Y	ADS7852Y/250	Tape and Reel, 250
ADS7852Y	"	"	"	"	"	"	ADS7852Y/2K	Tape and Reel, 2000
ADS7852YB	±1	±25	TQFP-32	PBS	-40°C to +85°C	A52YB	ADS7852YB/250	Tape and Reel, 250
ADS7852YB	"	"	"	"	"	"	ADS7852YB/2K	Tape and Reel, 2000

NOTE: (1) For the most current package and ordering information, see the Package Option Addendum located at the end of this data sheet.

ADS7852 CHANNEL SELECTION

A2	A1	A0	CHANNEL SELECTED
0	0	0	Channel 0
0	0	1	Channel 1
0	1	0	Channel 2
0	1	1	Channel 3
1	0	0	Channel 4
1	0	1	Channel 5
1	1	0	Channel 6
1	1	1	Channel 7

ELECTRICAL CHARACTERISTICS

At $T_A = -40^{\circ}\text{C}$ to $+85^{\circ}\text{C}$, $f_S = 500\text{kHz}$, $f_{\text{CLK}} = 16 \cdot f_S$, and $V_{\text{SS}} = +5\text{V}$, using internal reference, unless otherwise specified.

PARAMETER	CONDITIONS	ADS7852Y			ADS7852YB			UNITS
		MIN	TYP	MAX	MIN	TYP	MAX	
RESOLUTION				12			*	Bits
ANALOG INPUT Input Voltage Range Input Impedance Input Capacitance Input Leakage Current		0	5M 15 ± 1	5	*	*	*	V Ω pF μA
DC ACCURACY No Missing Codes Integral Linearity Error Differential Linearity Error Offset Error Offset Error Drift Offset Error Match Gain Error ⁽¹⁾ Gain Error Gain Error Drift Gain Error Match Noise Power Supply Rejection Ratio	Ext Ref = 2.5000V Int Ref Worst-Case Δ , $+V_{\text{SS}} = 5\text{V} \pm 5\%$	12	± 1 ± 2 ± 4 ± 25 150 1.2	± 2 ± 5 ± 1 ± 15 ± 40 ± 1	*	± 0.5 ± 1 *	± 1 *	Bits LSB ⁽¹⁾ LSB LSB ppm/ $^{\circ}\text{C}$ LSB LSB LSB ppm/ $^{\circ}\text{C}$ LSB μV_{rms} LSB
SAMPLING DYNAMICS Conversion Time Acquisition Time Throughput Rate Multiplexer Settling Time Aperture Delay Aperture Jitter		1.5	500 5 30	13.5 500	*	*	*	Clk Cycles Clk Cycles kHz ns ns ps
AC ACCURACY Signal-to-Noise Ratio Total Harmonic Distortion ⁽³⁾ Signal-to-(Noise+Distortion) Spurious Free Dynamic Range Channel-to-Channel Isolation	$V_{\text{IN}} = 5\text{Vp-p}$ at 50kHz $V_{\text{IN}} = 5\text{Vp-p}$ at 50kHz $V_{\text{IN}} = 5\text{Vp-p}$ at 50kHz $V_{\text{IN}} = 5\text{Vp-p}$ at 50kHz	68 76	72 -74 70 74 95	-72	71 78	* -77 72 77 *	-76	dB dB dB dB dB
REFERENCE OUTPUT Internal Reference Voltage Internal Reference Drift Input Impedance Source Current ⁽⁴⁾	$\overline{\text{CS}} = \text{GND}$ $\overline{\text{CS}} = V_{\text{SS}}$ Static Load	2.48	2.50 30 5 5	2.52 50	*	*	*	V ppm/ $^{\circ}\text{C}$ $\text{G}\Omega$ $\text{G}\Omega$ μA
REFERENCE INPUT Range Resistance ⁽⁵⁾	to Internal Reference Voltage	2.0	10	2.55	*	*	*	V k Ω
DIGITAL INPUT/OUTPUT Logic Family Logic Levels: V_{IH} V_{IL} V_{OH} V_{OL} Data Format	$I_{\text{IH}} = +5\mu\text{A}$ $I_{\text{IL}} = +5\mu\text{A}$ $I_{\text{OH}} = 250\mu\text{A}$ $I_{\text{OL}} = 250\mu\text{A}$	3 -0.3 3.5	CMOS	$+V_{\text{SS}} + 0.3$ 0.8 0.4	*	*	*	V V V V Straight Binary
POWER SUPPLY REQUIREMENT $+V_{\text{SS}}$ Quiescent Current Normal Power Nap Mode Current ⁽⁶⁾ Sleep Mode Current ⁽⁶⁾	Specified Performance	4.75	2.6 13 600 10	5.25 3.5 17.5 800 30	*	*	*	V mA mW μA μA
TEMPERATURE RANGE Specified Performance Storage		-40 -65		+85 +150	*	*	*	$^{\circ}\text{C}$ $^{\circ}\text{C}$

* Specifications same as ADS7852Y.

NOTES: (1) LSB means Least Significant Bit, with V_{REF} equal to $+2.5\text{V}$, one LSB is 1.22mV . (2) Measured relative to an ideal, full-scale input of 4.999V . Thus, gain error includes the error of the internal voltage reference. (3) Calculated on the first nine harmonics of the input frequency. (4) If the internal reference is required to source current to an external load, the reference voltage will change due to the internal $10\text{k}\Omega$ resistor. (5) Can vary $\pm 30\%$. (6) See Timing Characteristics for further detail.

PIN CONFIGURATION

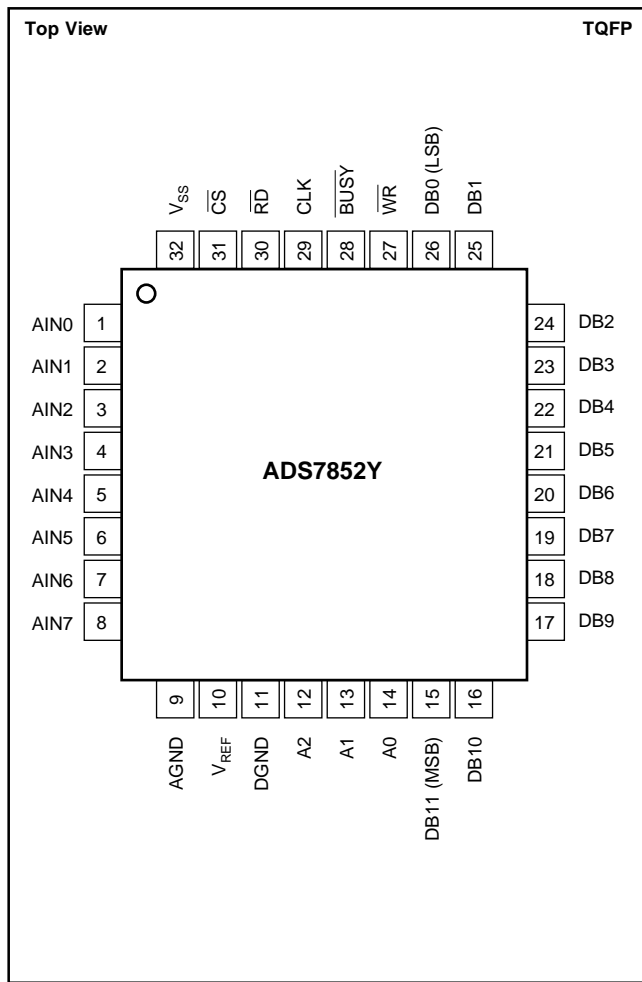

PIN DESCRIPTIONS

PIN	NAME	DESCRIPTION
1	AIN0	Analog Input Channel 0
2	AIN1	Analog Input Channel 1
3	AIN2	Analog Input Channel 2
4	AIN3	Analog Input Channel 3
5	AIN4	Analog Input Channel 4
6	AIN5	Analog Input Channel 5
7	AIN6	Analog Input Channel 6
8	AIN7	Analog Input Channel 7
9	AGND	Analog Ground, GND = 0V
10	V_{REF}	Voltage Reference Input and Output. See Electrical Characteristics table for ranges. Decouple to ground with a 0.1 μ F ceramic capacitor and a 2.2 μ F tantalum capacitor.
11	DGND	Digital Ground, GND = 0V
12	A2	Channel Address. See Channel Selection Table for details.
13	A1	Channel Address. See Channel Selection Table for details.
14	A0	Channel Address. See Channel Selection Table for details.
15	DB11	Data Bit 11 (MSB)
16	DB10	Data Bit 10
17	DB9	Data Bit 9
18	DB8	Data Bit 8
19	DB7	Data Bit 7
20	DB6	Data Bit 6
21	DB5	Data Bit 5
22	DB4	Data Bit 4
23	DB3	Data Bit 3
24	DB2	Data Bit 2
25	DB1	Data Bit 1
26	DB0	Data Bit 0 (LSB)
27	\overline{WR}	Write Input. Active LOW. Use to start a new conversion and to select an analog channel via address inputs A0, A1 and A2 in combination with \overline{CS} .
28	\overline{BUSY}	\overline{BUSY} output goes LOW and stays LOW during a conversion. \overline{BUSY} rises when a conversion is complete.
29	CLK	External Clock Input. The clock speed determines the conversion rate by the equation: $f_{CLK} = 16 \cdot f_{SAMPLE}$.
30	\overline{RD}	Read Input. Active LOW. Use to read the data outputs in combination with \overline{CS} . Also use (in conjunction with A0 or A1) to place device in power-down mode.
31	\overline{CS}	Chip Select Input. Active LOW. The combination of \overline{CS} taken LOW and \overline{WR} taken LOW initiates a new conversion and places the outputs in tri-state mode.
32	V_{SS}	Voltage Supply Input. Nominally +5V. Decouple to ground with a 0.1 μ F ceramic capacitor and a 10 μ F tantalum capacitor.

TYPICAL CHARACTERISTICS

At $T_A = +25^\circ\text{C}$, $V_{SS} = +5\text{V}$, $f_{\text{SAMPLE}} = 500\text{kHz}$, $f_{\text{CLK}} = 16 \cdot f_{\text{SAMPLE}}$, and internal reference, unless otherwise specified.

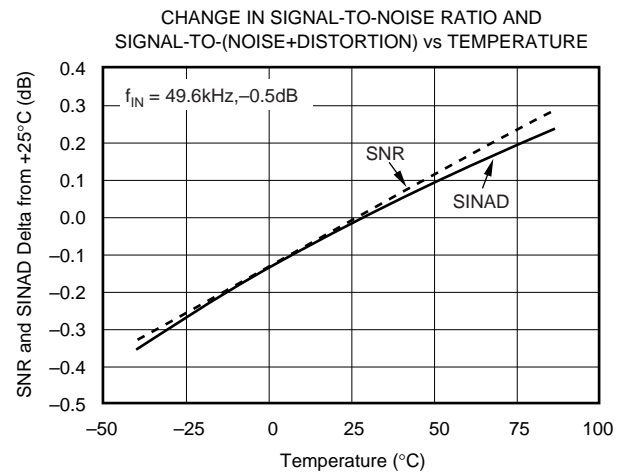
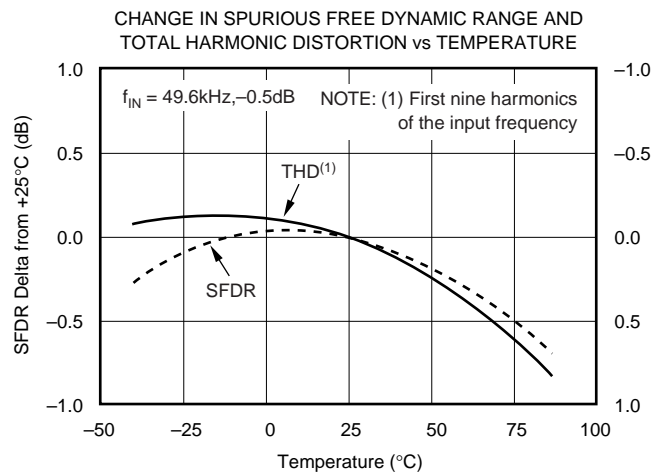
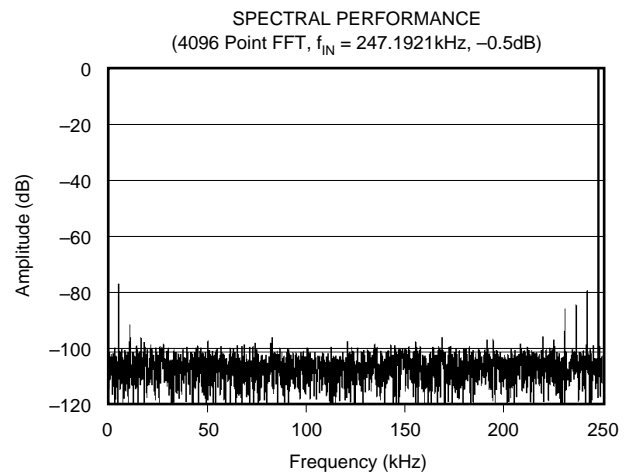
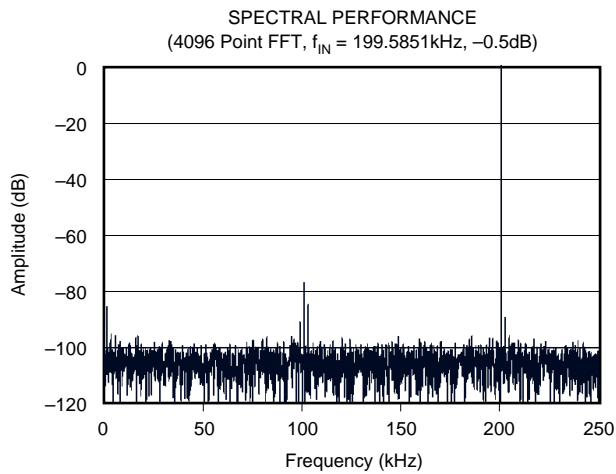
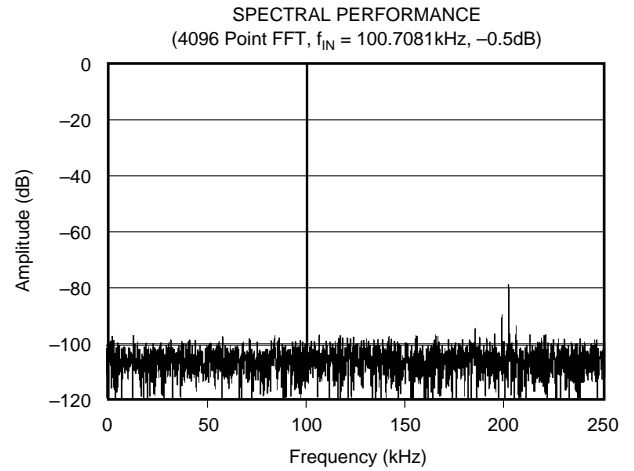
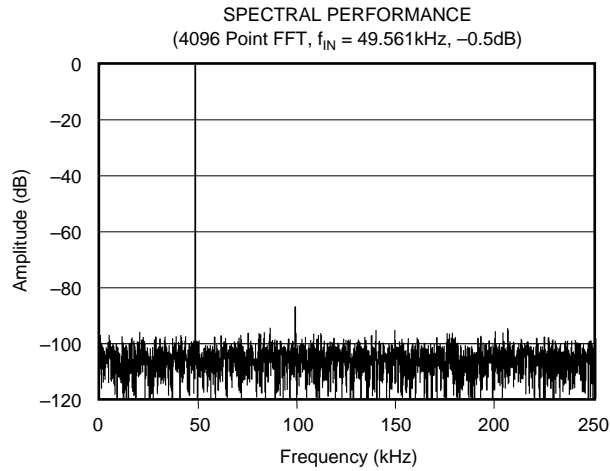

TYPICAL CHARACTERISTICS (Cont.)

At $T_A = +25^\circ\text{C}$, $V_{SS} = +5\text{V}$, $f_{\text{SAMPLE}} = 500\text{kHz}$, $f_{\text{CLK}} = 16 \cdot f_{\text{SAMPLE}}$, and internal reference, unless otherwise specified.

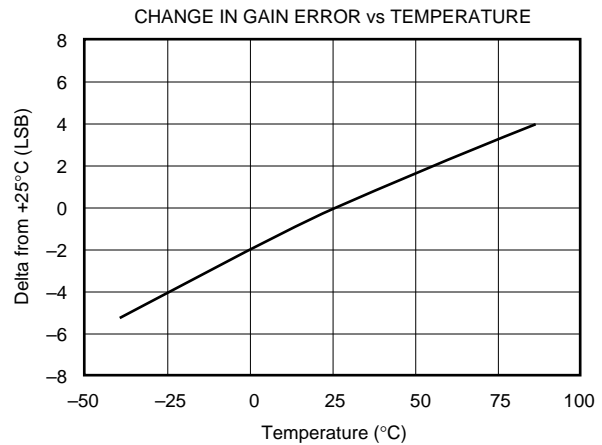
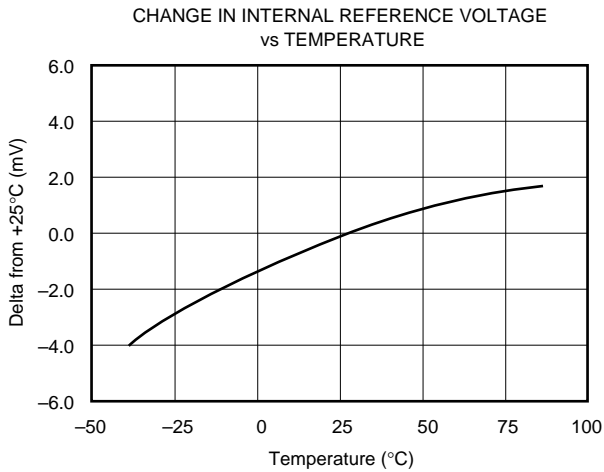
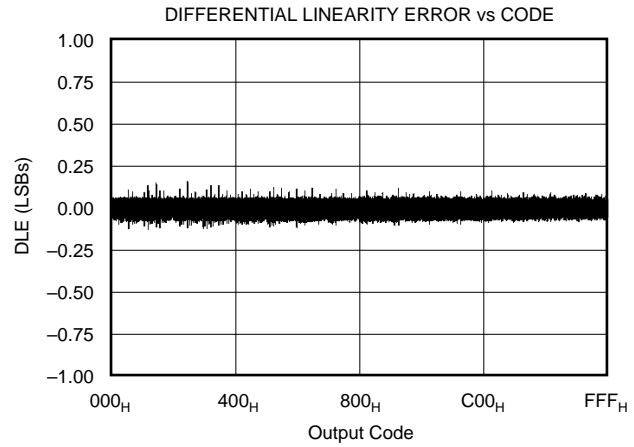
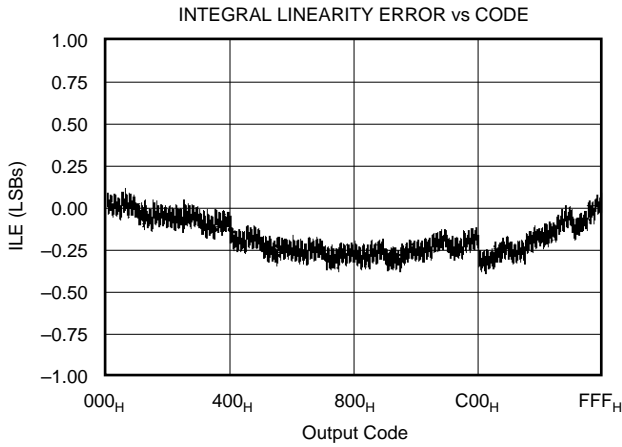
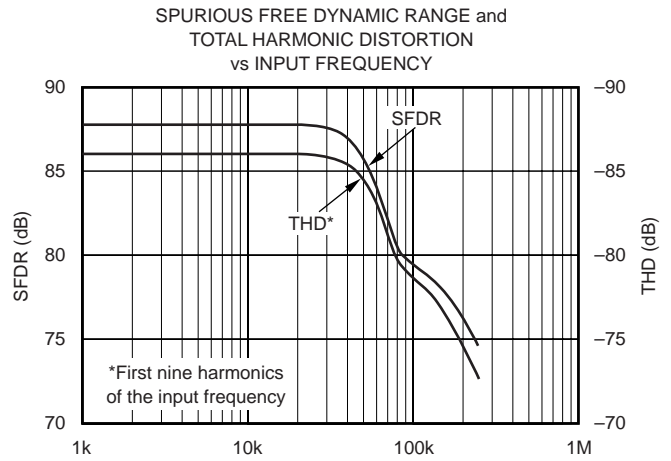
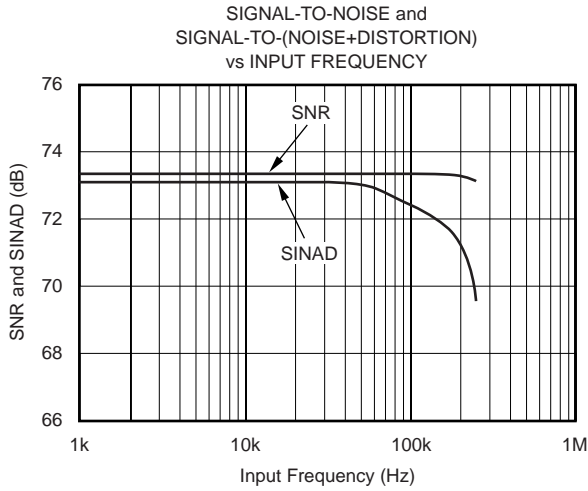

TYPICAL CHARACTERISTICS (Cont.)

At $T_A = +25^\circ\text{C}$, $V_{SS} = +5\text{V}$, $f_{\text{SAMPLE}} = 500\text{kHz}$, $f_{\text{CLK}} = 16 \cdot f_{\text{SAMPLE}}$, and internal reference, unless otherwise specified.

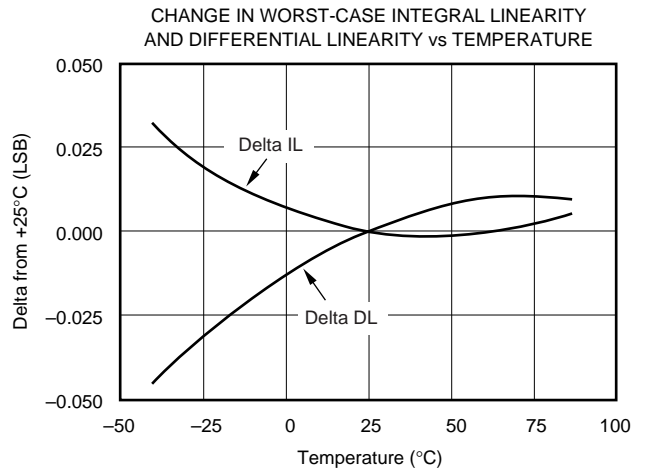
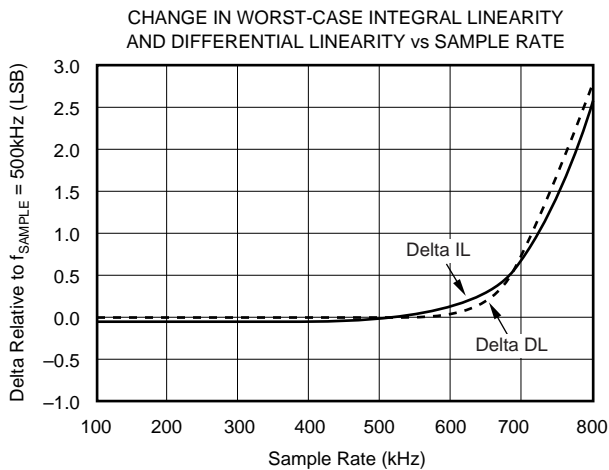
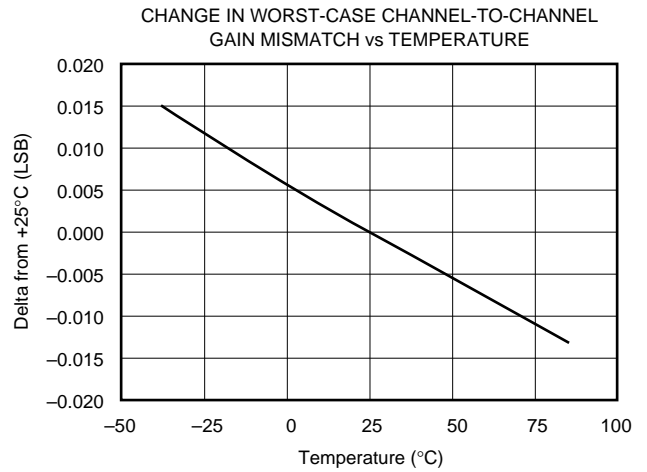
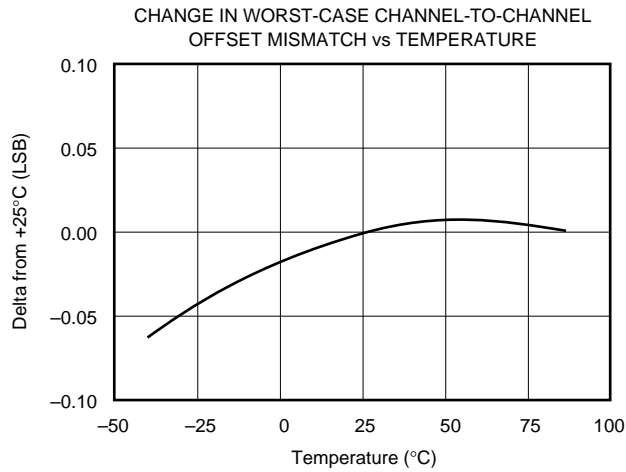
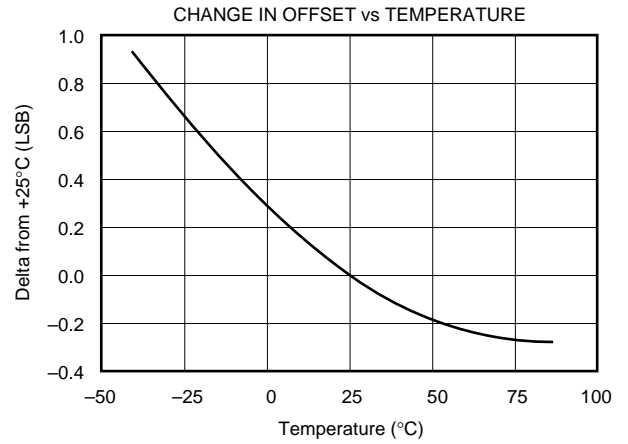
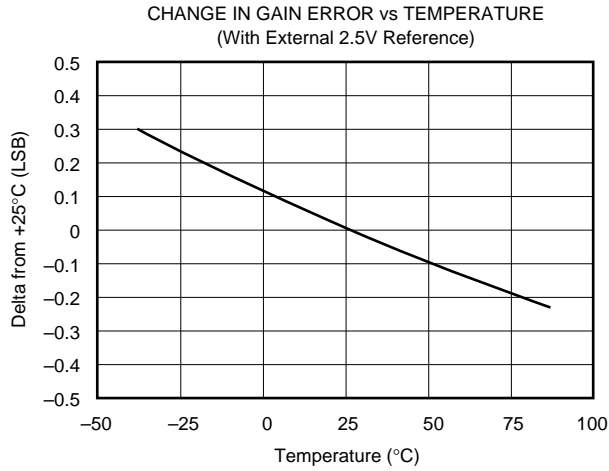

TYPICAL CHARACTERISTICS (Cont.)

At $T_A = +25^\circ\text{C}$, $V_{SS} = +5\text{V}$, $f_{\text{SAMPLE}} = 500\text{kHz}$, $f_{\text{CLK}} = 16 \cdot f_{\text{SAMPLE}}$, and internal reference, unless otherwise specified.

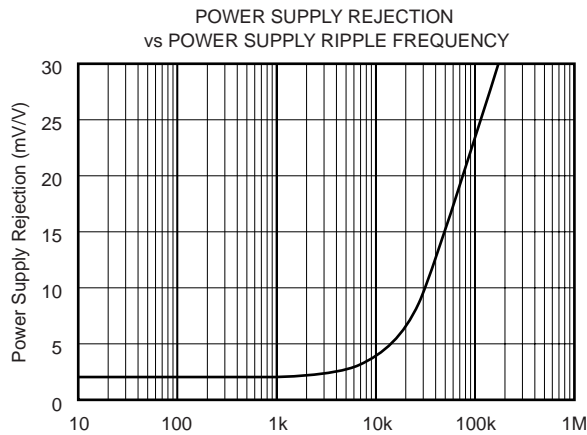
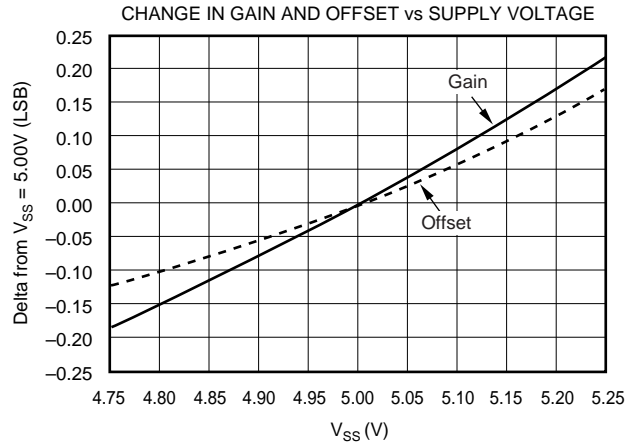
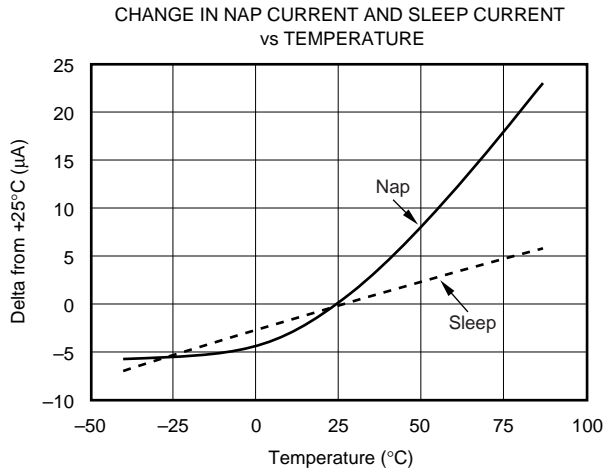
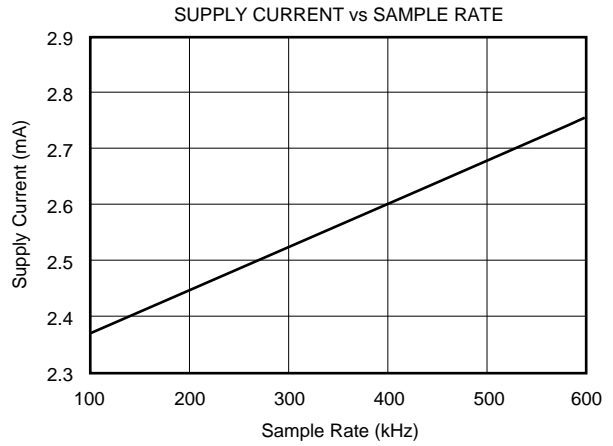
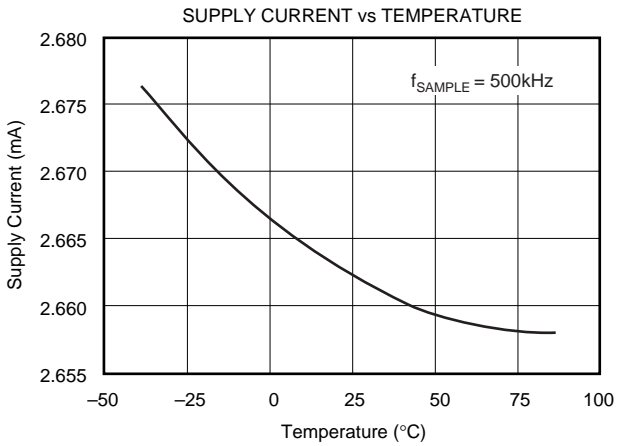

THEORY OF OPERATION

The ADS7852 is a high-speed successive approximation register (SAR) Analog-to-Digital (A/D) converter with an internal 2.5V bandgap reference. The architecture is based on capacitive redistribution, which inherently includes a sample/hold function. The converter is fabricated on a 0.6micron CMOS process. Figure 1 shows the basic operating circuit for the ADS7852.

The ADS7852 requires an external clock to run the conversion process. This clock can vary between 200kHz (12.5Hz throughput) and 8MHz (500kHz throughput). The duty cycle of the clock is unimportant as long as the minimum HIGH and LOW times are at least 50ns and the clock period is at least 125ns. The minimum clock frequency is governed by the parasitic leakage of the Capacitive Digital-to-Analog (CDAC) capacitors internal to the ADS7852.

The front-end input multiplexer of the ADS7852 features eight single-ended analog inputs. Channel selection is performed using the address pins A0 (pin 14), A1 (pin 13), and A2 (pin 12). When a conversion is initiated, the input voltage is sampled on the internal capacitor array. While a conversion is in progress, all channel inputs are disconnected from any internal function.

The range of the analog input is set by the voltage on the V_{REF} pin. With the internal 2.5V reference, the input range is 0V to 5V. An external reference voltage can be placed on V_{REF} , overdriving the internal voltage. The range for the external voltage is 2.0V to 2.55V, giving an input voltage range of 4.0V to 5.1V.

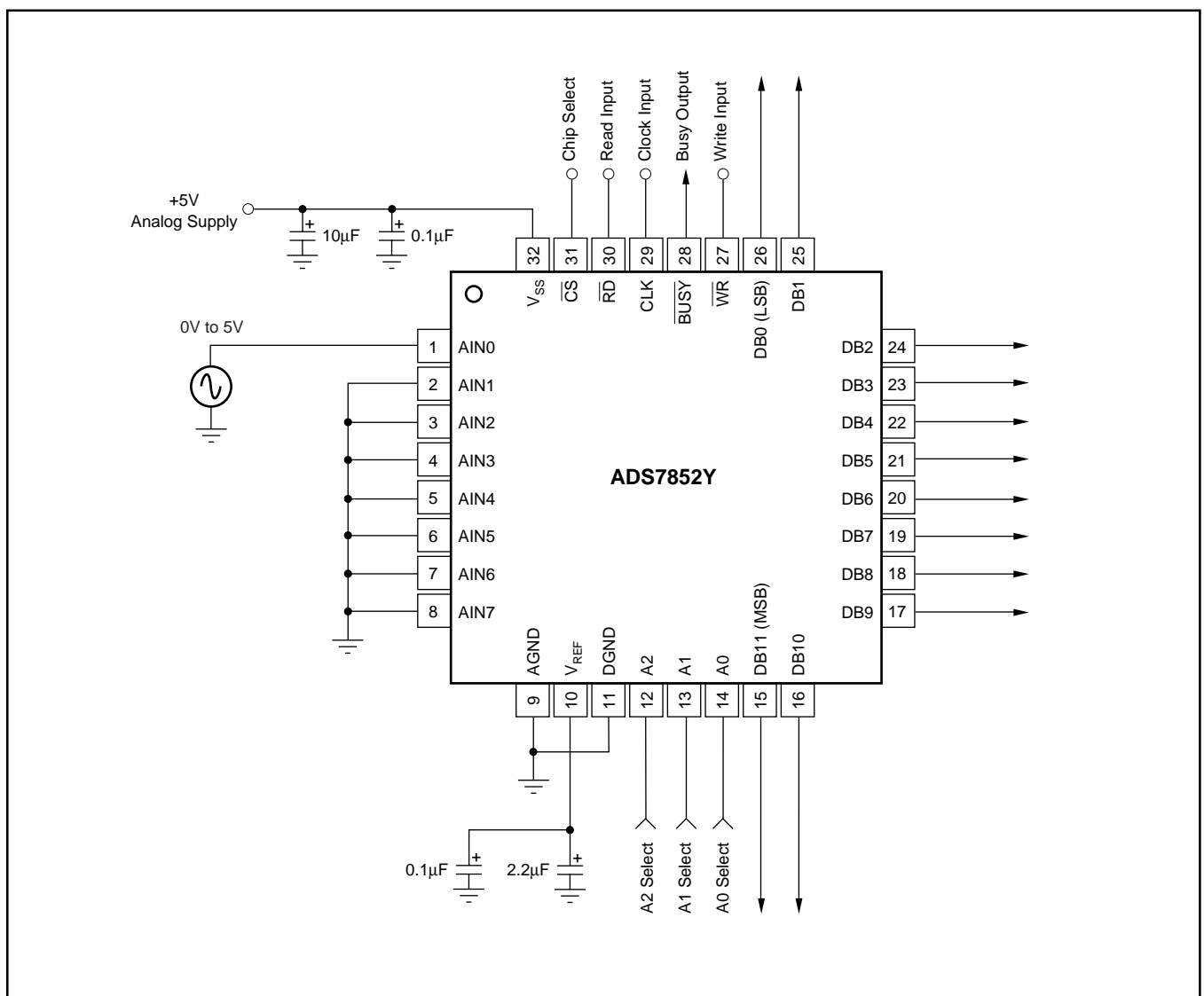

FIGURE 1. Typical Circuit Configuration.

ANALOG INPUTS

The ADS7852 features eight single-ended inputs. While the static current into each analog input is basically zero, the dynamic current depends on the input voltage and sample rate. The current into the device must charge the internal hold capacitor during the sample period. After this capacitor has been fully charged, no further input current is required. For optimum performance, the source driving the analog inputs must be capable of charging the input capacitance to a 12-bit settling level within the sample period. This can be as little as 350ns in some operating modes. While the converter is in the hold mode, or after the sampling capacitor has been fully charged, the input impedance of the analog input is greater than 1G Ω .

REFERENCE

The reference voltage on the V_{REF} pin establishes the full-scale range of the analog input. The ADS7852 can operate with a reference in the range of 2.0V to 2.55V corresponding to a full-scale range of 4.0V to 5.1V.

The voltage at the V_{REF} pin is internally buffered, and this buffer drives the capacitor DAC portion of the converter. This feature is important because the buffer greatly reduces the dynamic load placed on the reference source. Since the voltage at V_{REF} will be unavoidably affected by noise and glitches generated during the conversion process, it is highly recommended that the V_{REF} pin be bypassed to ground as outlined in the sections that follow.

INTERNAL REFERENCE

The ADS7852 contains an onboard 2.5V reference, resulting in a 0V to 5V input range on the analog input. The Specifications Table gives the various specifications for the internal reference. This reference can be used to supply a small amount of source current to an external load but the load should be static. Due to the internal 10k Ω resistor, a dynamic load will cause variations in the reference voltage, and will dramatically affect the conversion result. Note that even a static load will reduce the internal reference voltage seen at the buffer input. The amount of reduction depends on the load and the actual value of the internal 10k Ω resistor. The value of this resistor can vary by $\pm 30\%$.

The V_{REF} pin should be bypassed with a 0.1 μ F ceramic capacitor placed as close to the ADS7852 as possible. In addition, a 2.2 μ F tantalum capacitor should be used in parallel with the ceramic capacitor.

EXTERNAL REFERENCE

The internal reference is connected to the V_{REF} pin and to the internal buffer via an on-chip 10k Ω series resistor. Because of this configuration, the internal reference voltage can easily be overridden by an external reference voltage. The voltage range for the external voltage is 2.00V to 2.55V, corresponding to an analog input range of 4.0V to 5.1V.

While the external reference will not have to provide significant dynamic current to the V_{REF} in, it does have to drive the series

10k Ω resistor that is connected to the 2.5V internal reference. Accounting for the maximum difference between the external reference voltage and the internal reference voltage, and the processing variations for the on-chip 10k Ω resistor, this current can be as high as 75 μ A. In addition, the V_{REF} pin should still be bypassed to ground with at least a 0.1 μ F ceramic capacitor placed as close to the ADS7852 as possible. Depending on the particular reference and A/D conversion speed, additional bypass capacitance may be required, such as the 2.2 μ F tantalum capacitor shown in the Typical Circuit Configuration (Figure 1). Close attention should be paid to the stability of any external reference source that is driving the large bypass capacitors present at the V_{REF} pin.

BASIC OPERATION

Figure 1 shows the simple circuit required to operate the ADS7852 with Channel 0 selected. A conversion can be initiated by bringing the \overline{WR} pin (pin 27) LOW for a minimum of 35ns. \overline{BUSY} (pin 28) will output a LOW during the conversion process and rises only after the conversion is complete. The 12 bits of output data will be valid on pins 15 through 26 following the rising edge of \overline{BUSY} .

STARTING A CONVERSION

A conversion is initiated on the falling edge of the \overline{WR} input, with valid signals on A0, A1, A2, and \overline{CS} . The ADS7852 will enter the conversion mode on the first rising edge of the external clock following the \overline{WR} pin going LOW. The conversion process takes 13.5 clock cycles (1.5 cycles for the DB0 decision, 2 clock cycles for the DB5 decision, and 1 clock cycle for each of the other bit decisions). This allows 2.5 clock cycles for sampling. Upon initiating a conversion, the \overline{BUSY} output will go LOW approximately 20ns after the falling edge of the \overline{WR} pin. The \overline{BUSY} output will return HIGH just after the ADS7852 has finished a conversion and the output data will be valid on pins 15 through 26. The rising edge of \overline{BUSY} can be used to latch the output data into an external device. It is recommended that the data be read immediately after each conversion since the switching noise of the asynchronous data transfer can cause digital feedthrough degrading the converter performance (see Figure 2).

CHANNEL ADDRESSING

The selection of the analog input channel to be converted is controlled by address pins A0, A1, and A2. This channel becomes active on the rising edge of \overline{WR} with \overline{CS} held LOW. The data on the address pins should be stable for at least 10ns prior to \overline{WR} going HIGH.

The address pins are also used to control the power-down functions of the ADS7852. Careful attention must be paid to the status of the address pins following each conversion. If the user does not want the ADS7852 to enter either of the power-down modes following a conversion, the A0 and A1 pins must be LOW when \overline{RD} and \overline{CS} are returned HIGH after reading the data at the end of a conversion (see the Power-Down Mode section of this data sheet for more details).

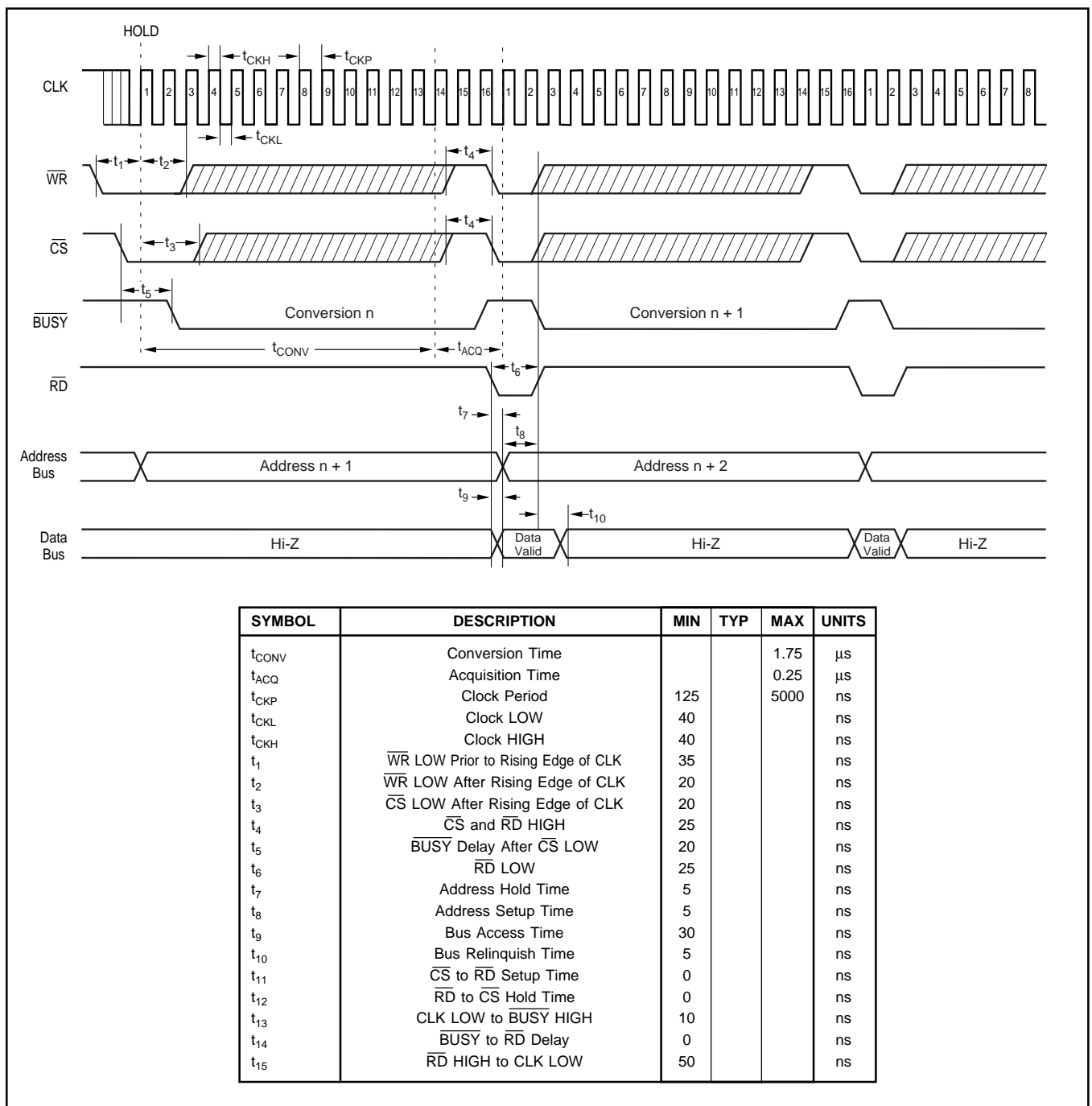

FIGURE 2. ADS7852 Write/Read Timing.

READING DATA

Data from the ADS7852 will appear at pins 15 through 26. The MSB will output on pin 15 while the LSB will output on pin 26. The outputs are coded in Straight Binary (with $0V = 000_H$ and $5V = FFF_H$). Following a conversion, the \overline{BUSY} pin will go HIGH. After \overline{BUSY} has been HIGH for at least t_{14} seconds, the \overline{CS} and \overline{RD} pins may be brought LOW to enable the 12-bit output bus. \overline{CS} and \overline{RD} must be held LOW for at least 25ns following \overline{BUSY} HIGH. Data will be valid 30ns after the falling edge of both \overline{CS} and \overline{RD} . The output data will remain valid for 20ns following the rising edge of both \overline{CS} and \overline{RD} (see Figure 2 for the read cycle timing diagram).

DESCRIPTION	ANALOG INPUT	DIGITAL OUTPUT STRAIGHT BINARY	
		BINARY CODE	HEX CODE
Least Significant Bit (LSB)	1.2207mV		
Full Scale	4.99878V	1111 1111 1111	FFF
Midscale	2.5V	1000 0000 0000	800
Midscale -1LSB	2.49878V	0111 1111 1111	7FF
Zero Full Scale	0V	0000 0000 0000	000

Table I. Ideal Input Voltages and Output Codes.

POWER-DOWN MODE

The ADS7852 has two different power-down modes: the Nap mode and the Sleep mode. In Nap mode, all analog and digital circuitry is powered off, with the exception of the voltage reference. In Sleep mode, the device is completely powered off.

While the Sleep mode affords the lowest power consumption, the time to come out of Sleep mode can be considerable since it takes the internal reference voltage a finite amount of time to power up and reach a stable value. This latency can result in spurious output data for a minimum of ten conversion cycles at a 500kHz sampling rate. It should also be noted that any external load connected to the V_{REF} pin will increase this effect since a discharge path for the V_{REF} bypass capacitor is provided during the Sleep cycle. Even the parasitic leakage of the bypass capacitor itself should be considered if the unit is left in the Sleep mode for an extended period. After power-up, this capacitor must be recharged by the internal reference voltage and the on-chip 10k Ω series resistor. Under worst-case conditions (for example, the bypass capacitor is completely discharged), the output data can be invalid for several hundred milliseconds.

Since the Nap mode maintains the voltage on the V_{REF} pin by keeping the internal reference powered-up, valid conversions are available immediately after the Nap mode is terminated.

The simplest way to use the power-down mode is following a conversion. After a conversion has finished and \overline{BUSY} has returned HIGH, \overline{CS} and \overline{RD} must be brought LOW for a minimum of 25ns. When \overline{RD} and \overline{CS} are returned HIGH, the ADS7852 will enter the power-down mode on the rising edge of \overline{RD} . If \overline{CS} is always kept LOW, the power-down mode will be controlled exclusively by \overline{RD} . Depending on the status of the A0 and A1 address pins, the ADS7852 will either enter the Nap mode, the Sleep mode, or be returned to normal operation in the sampling mode. See Table II and Figures 3 and 4 for further details.

\overline{RD}	A2	A1	A0	POWER-DOWN MODE
$\overline{\uparrow}$	X	0	0	None
$\overline{\uparrow}$	X	1	0	Sleep
$\overline{\uparrow}$	X	0	1	Nap
$\overline{\uparrow}$	X	1	1	Sleep

$\overline{\uparrow}$ = Signifies rising edge of \overline{RD} pin. X = Don't care

TABLE II. ADS7852 Power-Down Mode.

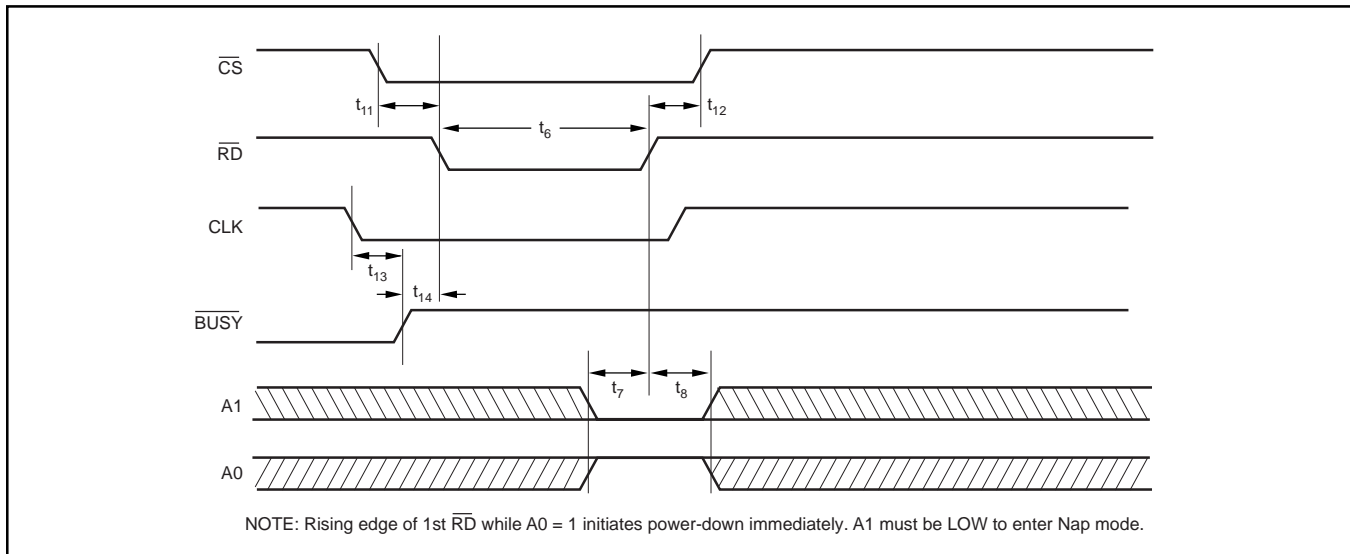

FIGURE 3. Entering Nap Using \overline{RD} and A0.

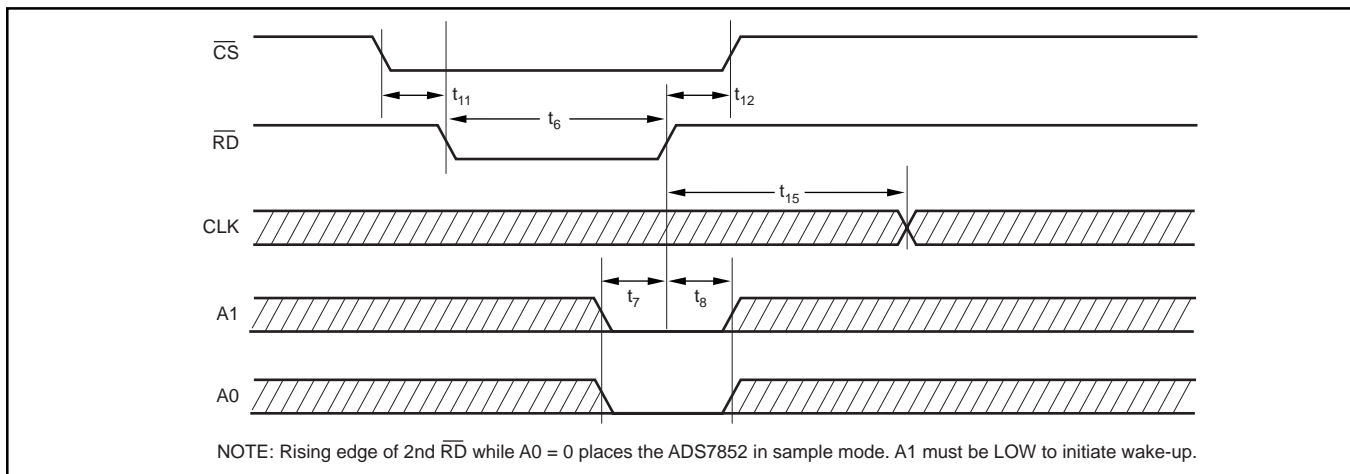

FIGURE 4. Initiating Wake-Up Using \overline{RD} and A0.

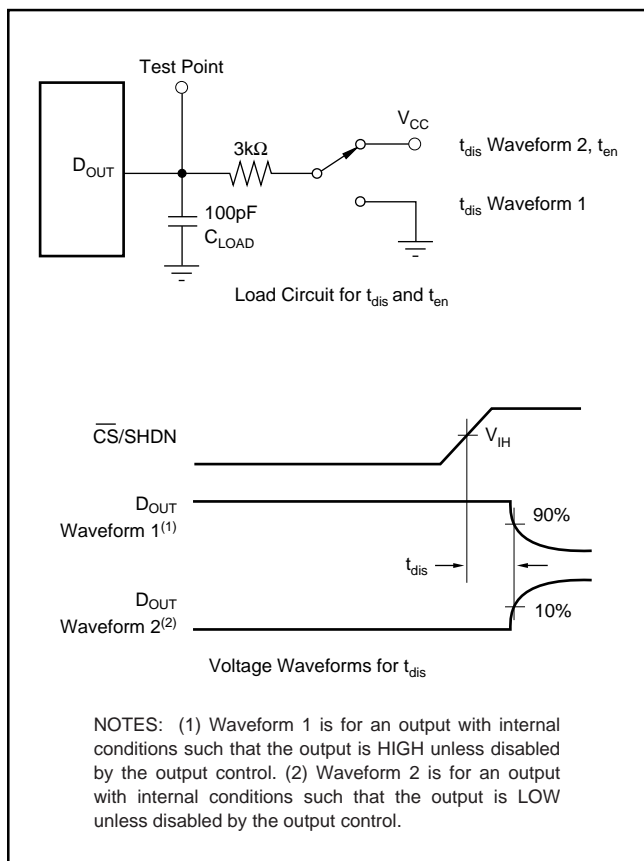

FIGURE 5. Timing Diagram and Test Circuits for Parameters in Figure 2.

In addition to using the address pins in conjunction with \overline{RD} , the power-down mode can also be terminated implicitly by starting a new conversion (for example, taking \overline{WR} LOW while \overline{CS} is LOW). If it is desired to keep the ADS7852 in a power-down state for a period that is greater than dictated by the sampling rate, the convert signal driving the \overline{WR} pin must be disabled.

The typical supply current of the ADS7852 is 2.6mA, with a 5V supply and a 500kHz sampling rate. In the Nap mode, the typical supply current is 600 μ A. In the Sleep mode, the current is typically reduced to 10 μ A.

LAYOUT

For optimum performance, care should be taken with the physical layout of the ADS7852 circuitry. This is particularly true if the CLK input is approaching the maximum throughput rate.

The basic SAR architecture is sensitive to glitches or sudden changes on the power supply, reference, ground connections, and digital inputs that occur just prior to latching the output of the analog comparator. Thus, driving any single conversion for an n-bit SAR converter, there are n “windows” in which large external transient voltages can affect the conversion result. Such glitches might originate from switching power supplies, nearby digital logic, or high power devices. The degree of error in the digital output depends on the reference voltage, layout, and the exact timing of the external event. This error can change if the external event changes in times with respect to the CLK input.

With this effect in mind, power to the ADS7852 should be clean and well bypassed. A 0.1 μ F ceramic bypass capacitor should be placed as close to the device as possible. In addition, a 1 μ F to 10 μ F capacitor is recommended. If needed, an even larger capacitor and a 5 Ω or 10 Ω series resistor may be used to low pass filter a noisy supply. The ADS7852 draws very little current from an external reference on average as the reference voltage is internally buffered. However, glitches from the conversion process appear at the V_{REF} input and the reference source must be able to handle this. Whether the reference is internal or external, the V_{REF} pin should be bypassed with a 0.1 μ F capacitor. An additional larger capacitor may also be used, if desired. If the reference voltage is external and originates from an op amp, make sure it can drive the bypass capacitor or capacitors without oscillation.

The GND pin should be connected to a clean ground point. In many cases, this will be the “analog” ground. Avoid connections which are too near the grounding point of a microcontroller or digital signal processor. If needed, run a ground trace directly from the converter to the power supply entry point. The ideal layout will include an analog ground plane dedicated to the converter and associated analog circuitry.

PACKAGING INFORMATION

Orderable part number	Status (1)	Material type (2)	Package Pins	Package qty Carrier	RoHS (3)	Lead finish/ Ball material (4)	MSL rating/ Peak reflow (5)	Op temp (°C)	Part marking (6)
ADS7852Y/250	Last Time Buy	Production	TQFP (PBS) 32	250 SMALL T&R	Yes	Call TI	Level-3-260C-168 HR	-40 to 85	A52Y
ADS7852Y/250.B	Last Time Buy	Production	TQFP (PBS) 32	250 SMALL T&R	Yes	Call TI	Level-3-260C-168 HR	-40 to 85	A52Y
ADS7852Y/250G4	Last Time Buy	Production	TQFP (PBS) 32	250 SMALL T&R	Yes	Call TI	Level-3-260C-168 HR	-40 to 85	A52Y
ADS7852Y/2K	Last Time Buy	Production	TQFP (PBS) 32	2000 LARGE T&R	Yes	NIPDAU	Level-3-260C-168 HR	-	A52Y
ADS7852Y/2K.B	Last Time Buy	Production	TQFP (PBS) 32	2000 LARGE T&R	Yes	NIPDAU	Level-3-260C-168 HR	-40 to 85	A52Y
ADS7852YB/250	Last Time Buy	Production	TQFP (PBS) 32	250 SMALL T&R	Yes	Call TI	Level-3-260C-168 HR	-	A52Y B
ADS7852YB/250.B	Last Time Buy	Production	TQFP (PBS) 32	250 SMALL T&R	Yes	Call TI	Level-3-260C-168 HR	-40 to 85	A52Y B
ADS7852YB/2K	Last Time Buy	Production	TQFP (PBS) 32	2000 LARGE T&R	Yes	NIPDAU	Level-3-260C-168 HR	-	A52Y B
ADS7852YB/2K.B	Last Time Buy	Production	TQFP (PBS) 32	2000 LARGE T&R	Yes	NIPDAU	Level-3-260C-168 HR	-40 to 85	A52Y B

(1) **Status:** For more details on status, see our [product life cycle](#).

(2) **Material type:** When designated, preproduction parts are prototypes/experimental devices, and are not yet approved or released for full production. Testing and final process, including without limitation quality assurance, reliability performance testing, and/or process qualification, may not yet be complete, and this item is subject to further changes or possible discontinuation. If available for ordering, purchases will be subject to an additional waiver at checkout, and are intended for early internal evaluation purposes only. These items are sold without warranties of any kind.

(3) **RoHS values:** Yes, No, RoHS Exempt. See the [TI RoHS Statement](#) for additional information and value definition.

(4) **Lead finish/Ball material:** Parts may have multiple material finish options. Finish options are separated by a vertical ruled line. Lead finish/Ball material values may wrap to two lines if the finish value exceeds the maximum column width.

(5) **MSL rating/Peak reflow:** The moisture sensitivity level ratings and peak solder (reflow) temperatures. In the event that a part has multiple moisture sensitivity ratings, only the lowest level per JEDEC standards is shown. Refer to the shipping label for the actual reflow temperature that will be used to mount the part to the printed circuit board.

(6) Part marking: There may be an additional marking, which relates to the logo, the lot trace code information, or the environmental category of the part.

Multiple part markings will be inside parentheses. Only one part marking contained in parentheses and separated by a "-" will appear on a part. If a line is indented then it is a continuation of the previous line and the two combined represent the entire part marking for that device.

Important Information and Disclaimer:The information provided on this page represents TI's knowledge and belief as of the date that it is provided. TI bases its knowledge and belief on information provided by third parties, and makes no representation or warranty as to the accuracy of such information. Efforts are underway to better integrate information from third parties. TI has taken and continues to take reasonable steps to provide representative and accurate information but may not have conducted destructive testing or chemical analysis on incoming materials and chemicals. TI and TI suppliers consider certain information to be proprietary, and thus CAS numbers and other limited information may not be available for release.

In no event shall TI's liability arising out of such information exceed the total purchase price of the TI part(s) at issue in this document sold by TI to Customer on an annual basis.

PBS (S-PQFP-G32)

PLASTIC QUAD FLATPACK

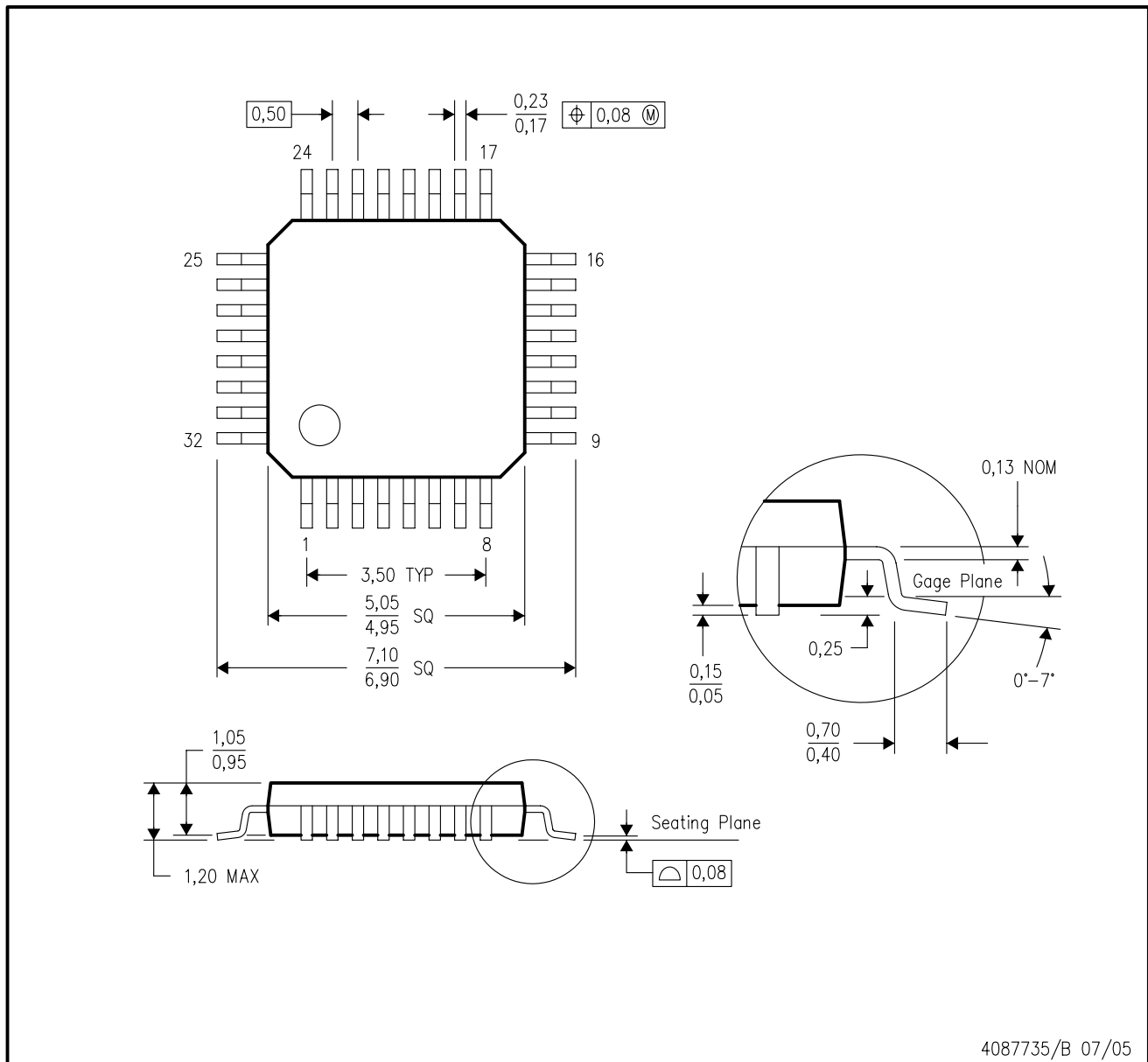

4087735/B 07/05

- NOTES:
- A. All linear dimensions are in millimeters.
 - B. This drawing is subject to change without notice.

PBS (S-PQFP-G32)

PLASTIC QUAD FLATPACK

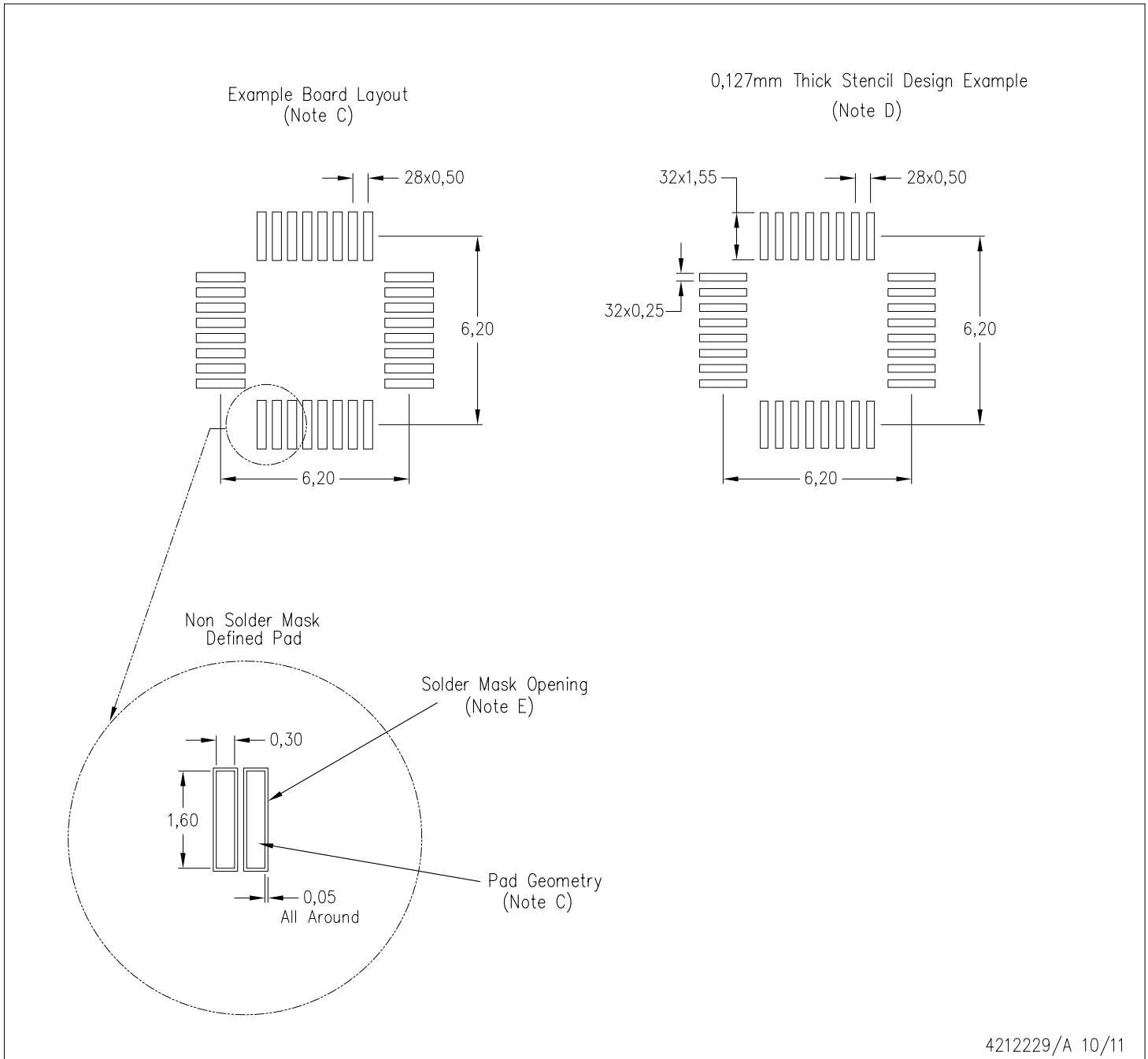

- NOTES:
- A. All linear dimensions are in millimeters.
 - B. This drawing is subject to change without notice.
 - C. Publication IPC-7351 is recommended for alternate designs.
 - D. Laser cutting apertures with trapezoidal walls and also rounding corners will offer better paste release. Customers should contact their board assembly site for stencil design recommendations. Refer to IPC 7525 for stencil design considerations.
 - E. Customers should contact their board fabrication site for recommended solder mask tolerances between and around signal pads.

IMPORTANT NOTICE AND DISCLAIMER

TI PROVIDES TECHNICAL AND RELIABILITY DATA (INCLUDING DATASHEETS), DESIGN RESOURCES (INCLUDING REFERENCE DESIGNS), APPLICATION OR OTHER DESIGN ADVICE, WEB TOOLS, SAFETY INFORMATION, AND OTHER RESOURCES "AS IS" AND WITH ALL FAULTS, AND DISCLAIMS ALL WARRANTIES, EXPRESS AND IMPLIED, INCLUDING WITHOUT LIMITATION ANY IMPLIED WARRANTIES OF MERCHANTABILITY, FITNESS FOR A PARTICULAR PURPOSE OR NON-INFRINGEMENT OF THIRD PARTY INTELLECTUAL PROPERTY RIGHTS.

These resources are intended for skilled developers designing with TI products. You are solely responsible for (1) selecting the appropriate TI products for your application, (2) designing, validating and testing your application, and (3) ensuring your application meets applicable standards, and any other safety, security, regulatory or other requirements.

These resources are subject to change without notice. TI grants you permission to use these resources only for development of an application that uses the TI products described in the resource. Other reproduction and display of these resources is prohibited. No license is granted to any other TI intellectual property right or to any third party intellectual property right. TI disclaims responsibility for, and you fully indemnify TI and its representatives against any claims, damages, costs, losses, and liabilities arising out of your use of these resources.

TI's products are provided subject to [TI's Terms of Sale](#), [TI's General Quality Guidelines](#), or other applicable terms available either on ti.com or provided in conjunction with such TI products. TI's provision of these resources does not expand or otherwise alter TI's applicable warranties or warranty disclaimers for TI products. Unless TI explicitly designates a product as custom or customer-specified, TI products are standard, catalog, general purpose devices.

TI objects to and rejects any additional or different terms you may propose.

Copyright © 2026, Texas Instruments Incorporated

Last updated 10/2025