

# BQ25618/619 I<sup>2</sup>C Controlled 1-Cell 1.5A Battery Charger with 20mA Termination and 1A Boost Operation

## 1 Features

- Single chip solution to charge wearable accessories from adapter or battery
- High-efficiency, 1.5MHz, synchronous switch-mode buck charger
  - 95.5% charge efficiency at 0.5A and 94.5% efficiency at 1A
  - $\pm 0.5\%$  charge voltage regulation (10mV step)
  - I<sup>2</sup>C programmable JEITA profile of charge voltage, current and temperature thresholds
  - Low termination current with high accuracy 20mA $\pm$ 10mA
  - Small inductor form factor of 2.5 x 2.0 x 1.0mm<sup>3</sup>
- Boost mode with output from 4.6V to 5.15V
  - 94% boost efficiency at 1A output
  - Integrated control to switch between Charge and Boost mode
  - PMID\_GOOD pin control external PMOS FET for protection against fault conditions
- Single input supporting USB input, high-voltage adapter, or wireless power
  - Support 4V to 13.5V input voltage range with 22V absolute max input rating
  - Programmable input current limit (IINDPM) with I<sup>2</sup>C (100mA to 3.2A, 100mA/step)
  - Maximum power tracking by input voltage limit (VINDPM) up to 5.4V
  - VINDPM threshold automatically tracks battery voltage
- Narrow VDC (NVDC) power path management
  - System instant-on with no battery or deeply discharged battery
- Flexible I<sup>2</sup>C configuration and autonomous charging for optimal system performance
- High integration includes all MOSFETs, current sensing and loop compensation
- Low R<sub>DS(ON)</sub> 19.5m $\Omega$  BATFET to minimize charging loss and extend battery run time
  - BATFET control for Ship mode, and full system reset with and without adapter
- 7 $\mu$ A low battery leakage current in Ship mode
- 9.5 $\mu$ A low battery leakage current with system standby
- High accuracy battery charging profile
  - $\pm 5\%$  charge current regulation
  - $\pm 7.5\%$  input current regulation
  - Remote battery sensing to charge faster
  - Programmable top-off timer for full battery charging

- Safety Related Certifications:
  - IEC 62368-1 CB Certification

## 2 Applications

- Consumer wearables, smartwatch
- Personal care and fitness
- Headsets/headphone
- Earbuds (True Wireless or TWS) charging case
- Hearing aids charging case

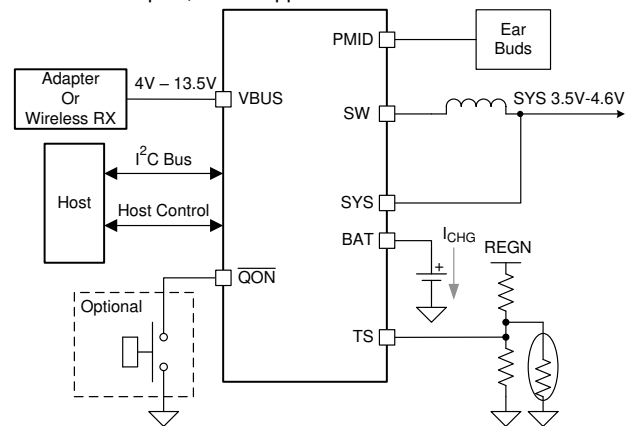
## 3 Description

The BQ25618/619 integrates charge, boost converter and voltage protection in a single device. It offers the industry's lowest termination current for switching chargers to charge wearable devices by full battery capacity. The BQ25618/619 best-in-class low quiescent current reduces battery leakage down to 6 $\mu$ A in Ship mode, which conserves battery energy to double the shelf life for the device. The BQ25619 is in a 4mm x 4mm QFN package for easy layout. The BQ25618 is in a 2.0mm x 2.4mm WCSP package for space limited design.

### Package Information

| PART NUMBER | PACKAGE <sup>(1)</sup> | PACKAGE SIZE <sup>(2)</sup> | BODY SIZE (NOM) |
|-------------|------------------------|-----------------------------|-----------------|
| BQ25618     | YFF (DSBGA, 30)        | 2.20mm x 2.60mm             | 2.00mm x 2.40mm |
| BQ25619     | RTW (WQFN, 24)         | 4.00mm x 4.00mm             | 4.00mm x 4.00mm |

- (1) For all available packages, see [Section 13](#).
- (2) The package size (length x width) is a nominal value and includes pins, where applicable.



**Simplified Application**



## Table of Contents

|  |    |  |    |
|--|----|--|----|
| <b>1 Features</b> .....                        | 1  | 7.5 Register Maps.....   | 32 |
| <b>2 Applications</b> .....                    | 1  | <b>8 Application and Implementation</b> .....                    | 46 |
| <b>3 Description</b> .....                     | 1  | 8.1 Application Information.....                                 | 46 |
| <b>4 Description (continued)</b> .....         | 3  | 8.2 Typical Application.....                                     | 46 |
| <b>5 Pin Configuration and Functions</b> ..... | 4  | <b>9 Power Supply Recommendations</b> .....                      | 51 |
| <b>6 Specifications</b> .....                  | 7  | <b>10 Layout</b> .....   | 52 |
| 6.1 Absolute Maximum Ratings.....              | 7  | 10.1 Layout Guidelines.....                                      | 52 |
| 6.2 ESD Ratings.....                           | 7  | 10.2 Layout Example.....   | 52 |
| 6.3 Recommended Operating Conditions.....      | 7  | <b>11 Device and Documentation Support</b> .....                 | 54 |
| 6.4 Thermal Information.....                   | 8  | 11.1 Device Support.....   | 54 |
| 6.5 Thermal Information.....                   | 8  | 11.2 Documentation Support.....                                  | 54 |
| 6.6 Electrical Characteristics.....            | 8  | 11.3 Receiving Notification of Documentation Updates..           | 54 |
| 6.7 Timing Requirements.....                   | 13 | 11.4 Support Resources.....                                      | 54 |
| 6.8 Typical Characteristics.....               | 14 | 11.5 Trademarks.....   | 54 |
| <b>7 Detailed Description</b> .....            | 16 | 11.6 Electrostatic Discharge Caution.....                        | 54 |
| 7.1 Overview.....                              | 16 | 11.7 Glossary.....   | 54 |
| 7.2 Functional Block Diagram.....              | 16 | <b>12 Revision History</b> .....                                 | 54 |
| 7.3 Feature Description.....                   | 17 | <b>13 Mechanical, Packaging, and Orderable Information</b> ..... | 56 |
| 7.4 Device Functional Modes.....               | 31 |  |    |

## 4 Description (continued)

The BQ25619/618 is a highly integrated 1.5A switch-mode battery charge management and system power path management device for Li-ion and Li-polymer battery. It features fast charging with high input voltage support for a wide range of applications including wearables, and earphone charging case. Its low impedance power path optimizes switch-mode operation efficiency, reduces battery charging time, and extends battery run time during discharging phase. Its input voltage and current regulation, low termination current, and battery remote sensing deliver maximum charging power to the battery. The solution is highly integrated with input reverse-blocking FET (RBFET, Q1), high-side switching FET (HSFET, Q2), low-side switching FET (LSFET, Q3), and battery FET (BATFET, Q4) between system and battery. It also integrates the bootstrap diode for the high-side gate drive for simplified system design. The I<sup>2</sup>C serial interface with charging and system settings makes the device a truly flexible solution.

The device supports a wide range of input sources, including standard USB host port, USB charging port, USB compliant high voltage adapter and wireless power. It is compliant with USB 2.0 and USB 3.0 power spec with input current and voltage regulation. The device takes the result from the detection circuit in the system, such as USB PHY device.

The device integrates the buck charger and boost regulator into one solution with single inductor. The Boost mode supplies 5V (adjustable 4.6V/4.75V/5V/5.15V) on PMID pin. Boost mode is used to save BOM and charge another battery by control of PMID\_GOOD. The PMID\_GOOD pin is used to drive the external PMOS FET to disconnect boost output PMID from the attached accessories.

The power path management regulates the system slightly above battery voltage but does not drop below 3.5V minimum system voltage (programmable) with adapter applied. With this feature, the system maintains operation even when the battery is completely depleted or removed. When the input current limit or voltage limit is reached, the power path management automatically reduces the charge current. As the system load continues to increase, the battery starts to discharge the battery until the system power requirement is met. This supplement mode prevents overloading the input source.

The device initiates and completes a charging cycle without software control. It senses the battery voltage and charges the battery in three phases: pre-conditioning, constant current and constant voltage. At the end of the charging cycle, the charger automatically terminates when the charge current is below a preset limit and the battery voltage is higher than the recharge threshold. If the fully charged battery falls below the recharge threshold, the charger automatically starts another charging cycle.

The charger provides various safety features for battery charging and system operations, including battery negative temperature coefficient thermistor monitoring, charging safety timer and overvoltage and overcurrent protections. Thermal regulation reduces charge current when the junction temperature exceeds 110°C. The status register reports the charging status and any fault conditions. With I<sup>2</sup>C, the VBUS\_GD bit indicates if a good power source is present, and the  $\overline{\text{INT}}$  output immediately notifies host when a fault occurs.

The device also provides the  $\overline{\text{QON}}$  pin for BATFET enable and reset control to exit low power Ship mode or full system reset function.

The BQ25619 device is available in 24-pin, 4mm × 4mm × 0.75mm thin WQFN package and BQ25618 is available in 30-ball, 2.0mm × 2.4mm WCSP package.

## 5 Pin Configuration and Functions

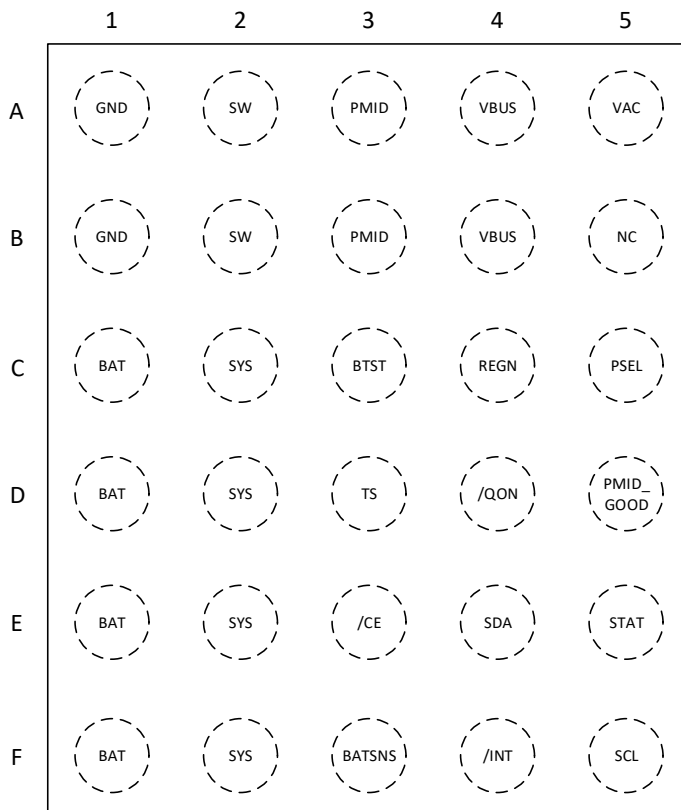


Figure 5-1. BQ25618 YFF Package 30-Pin WCSP Top View

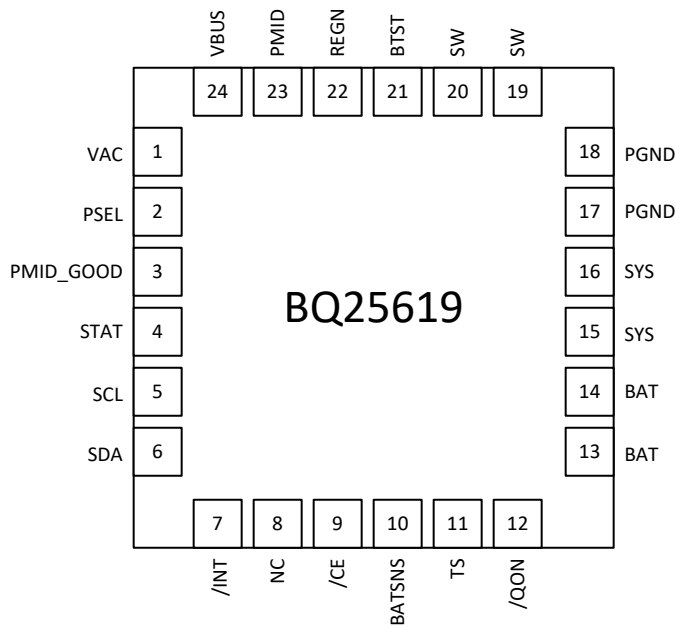


Figure 5-2. BQ25619 RTW Package 24-Pin WQFN Top View

**Table 5-1. Pin Functions**

| PIN       |                |             | TYPE <sup>(1)</sup> | DESCRIPTION  |
|-----------|----------------|-------------|---------------------|--|
| NAME      | BQ25618 NO.    | BQ25619 NO. |                     |  |
| BAT       | C1, D1, E1, F1 | 13          | P                   | Battery connection point to the positive terminal of the battery pack. The internal current sensing resistor is connected between SYS and BAT. Connect a 10 $\mu$ F closely to the BAT pin.  |
|           |                | 14          |                     |  |
| BATSNS    | F3             | 10          | AIO                 | Battery voltage sensing pin for charge voltage regulation. In order to minimize the parasitic trace resistance during charging, BATSNS pin is connected to the positive terminal of battery pack as close as possible. If BATSNS pin is open or short to ground, BATSNS_STAT bit is set to 1 and charger regulates the battery voltage through BAT pin.  |
| BTST      | C3             | 21          | P                   | PWM high-side driver positive supply. Internally, the BTST is connected to the cathode of the boot-strap diode. Connect the 0.047- $\mu$ F bootstrap capacitor from SW to BTST.  |
| CE        | E3             | 9           | DI                  | Charge enable pin. When this pin is driven LOW, battery charging is enabled.   |
| GND       | A1, B1         | 17          | P                   | Ground   |
|           |                | 18          |                     |  |
| INT       | F4             | 7           | DO                  | Open-drain interrupt output. Connect the INT to a logic rail through a 10-k $\Omega$ resistor. The INT pin sends an active low, 256- $\mu$ s pulse to the host to report charger device status and fault.  |
| NC        | B5             | 8           |                     | Not connected  |
| PMID      | A3, B3         | 23          | DO                  | Boost mode output. Connected to the drain of the reverse blocking MOSFET (RBFET) and the drain of HSFET. Consider the total input capacitance, put 1 $\mu$ F on VBUS to GND, and the rest capacitance on PMID to GND (typical 2x4.7 $\mu$ F plus 1 nF).  |
| PMID_GOOD | D5             | 3           | DO                  | Open drain active high PMID good indicator. Connect to the pullup rail REGN through 10-k $\Omega$ resistor. HIGH indicates PMID voltage is below 5.2 V and the current through Q1 is below 110% of input current limit. This signal can be used to drive external PMOS FET to disconnect the PMID under charging load when Boost mode output voltage is too high or output current is too high.  |
| PSEL      | C5             | 2           | DI                  | Power source selection input. HIGH indicates 500-mA input current limit. LOW indicates 2.4-A input current limit. Once the device gets into Host mode, the host can program a different input current limit to the IINDPM register.  |
| QON       | D4             | 12          | DI                  | BATFET enable/reset control input. When the BATFET is in Ship mode, a logic LOW of $t_{SHIPMODE}$ duration turns on BATFET to exit Ship mode. When the BATFET is not in Ship mode, a logic LOW of $t_{QON\_RST}$ (minimum 8 s) duration resets SYS (system power) by turning BATFET off for $t_{BATFET\_RST}$ (minimum 250 ms) and then re-enables BATFET to provide full system power reset. The host chooses the BATFET reset function with VBUS unplug or not through I <sup>2</sup> C bit BATFET_RST_WVBUS. The pin is pulled up to $V_{BAT}$ through 200 k $\Omega$ to maintain default HIGH logic during Ship mode. It has an internal clamp to 6.5 V. |
| REGN      | C4             | 22          | P                   | PWM low-side driver positive supply output. Internally, REGN is connected to the anode of the bootstrap diode. Connect a 4.7- $\mu$ F (10-V rating) ceramic capacitor from REGN to analog GND. The capacitor should be placed close to the IC.   |
| SCL       | F5             | 5           | DI                  | I <sup>2</sup> C interface clock. Connect SCL to the logic rail through a 10-k $\Omega$ resistor.  |
| SDA       | E4             | 6           | DIO                 | I <sup>2</sup> C interface data. Connect SDA to the logic rail through a 10-k $\Omega$ resistor.   |
| STAT      | E5             | 4           | DO                  | Open-drain interrupt output. Connect the STAT pin to a logic rail via 10-k $\Omega$ resistor. The STAT pin indicates charger status.<br>Charge in progress: LOW<br>Charge complete or charger in Sleep mode: HIGH<br>Charge suspend (fault response): Blink at 1 Hz  |
| SW        | A2, B2         | 19          | P                   | Switching node connecting to output inductor. Internally SW is connected to the source of the n-channel HSFET and the drain of the n-channel LSFET. Connect the 0.047- $\mu$ F bootstrap capacitor from SW to BTST.  |
|           |                | 20          |                     |  |
| SYS       | C2, D2, E2, F2 | 15          | P                   | Converter output connection point. The internal current sensing resistor is connected between SYS and BAT. Connect a 10 $\mu$ F (min) closely to the SYS pin.  |
|           |                | 16          |                     |  |
| TS        | D3             | 11          | AI                  | Battery temperature qualification voltage input. Connect a negative temperature coefficient thermistor (NTC). Program temperature window with a resistor divider from REGN to TS to GND. Charge and Boost mode suspend when TS pin voltage is out of range. When TS pin is not used, connect a 10-k $\Omega$ resistor from REGN to TS and a 10-k $\Omega$ resistor from TS to GND or set TS_IGNORE to HIGH to ignore TS pin. It is recommended to use a 103AT-2 thermistor.  |
| VAC       | A5             | 1           | AI                  | Input voltage sensing. This pin must be tied to VBUS.  |

**Table 5-1. Pin Functions (continued)**

| PIN         |             |             | TYPE <sup>(1)</sup> | DESCRIPTION   |
|-------------|-------------|-------------|---------------------|---|
| NAME        | BQ25618 NO. | BQ25619 NO. |                     |   |
| VBUS        | A4, B4      | 24          | P                   | Charger input voltage. The internal n-channel reverse block MOSFET (RBFET) is connected between VBUS and PMID with VBUS on source. Place a 1- $\mu$ F ceramic capacitor from VBUS to GND and place it as close as possible to IC.   |
| Thermal Pad | —           | —           | P                   | Ground reference for the device that is also the thermal pad used to conduct heat from the device. This connection serves two purposes. The first purpose is to provide an electrical ground connection for the device. The second purpose is to provide a low thermal-impedance path from the device die to the PCB. This pad should be tied externally to a ground plane. |

(1) AI = Analog input, AO = Analog Output, AIO = Analog input Output, DI = Digital input, DO = Digital Output, DIO = Digital input Output, P = Power

## 6 Specifications

### 6.1 Absolute Maximum Ratings

over operating free-air temperature range (unless otherwise noted)<sup>(1)</sup>

|                     |   | MIN  | MAX | UNIT |
|---------------------|---|------|-----|------|
| Voltage             | VAC (converter not switching)                     | -2   | 22  | V    |
| Voltage             | VBUS (converter not switching)                    | -2   | 22  | V    |
| Voltage             | PMID (converter not switching)                    | -0.3 | 22  | V    |
| Voltage             | SW  | -0.3 | 16  | V    |
| Voltage             | BAT, SYS (converter not switching)                | -0.3 | 7   | V    |
| Voltage             | BTST  | -0.3 | 22  | V    |
| Voltage             | BATSNS (converter not switching)                  | -0.3 | 7   | V    |
| Voltage             | PSEL, STAT, SCL, SDA, INT, PMID_GOOD, CE, TS, QON | -0.3 | 7   | V    |
| Output Sink Current | SDA, STAT, INT, PMID_GOOD                         |      | 6   | mA   |
| T <sub>J</sub>      | Junction temperature                              | -40  | 150 | °C   |
| T <sub>stg</sub>    | Storage temperature                               | -55  | 150 | °C   |

- (1) Stresses beyond those listed under *Absolute Maximum Rating* may cause permanent damage to the device. These are stress ratings only, which do not imply functional operation of the device at these or any other conditions beyond those indicated under *Recommended Operating Condition*. Exposure to absolute-maximum-rated conditions for extended periods may affect device reliability.

### 6.2 ESD Ratings

|                    |                         | VALUE  | UNIT  |
|--------------------|-------------------------|--|-------|
| V <sub>(ESD)</sub> | Electrostatic discharge | Human body model (HBM), per ANSI/ESDA/JEDEC JS-001, all pins <sup>(1)</sup>              | ±2000 |
|                    |                         | Charged device model (CDM), per JEDEC specification JESD22-C101, all pins <sup>(2)</sup> | ±250  |

- (1) JEDEC document JEP155 states that 500-V HBM allows safe manufacturing with a standard ESD control process.  
(2) JEDEC document JEP157 states that 250-V CDM allows safe manufacturing with a standard ESD control process.

### 6.3 Recommended Operating Conditions

over operating free-air temperature range (unless otherwise noted)

|                   |                       | MIN | NOM | MAX  | UNIT |
|-------------------|-----------------------|-----|-----|------|------|
| V <sub>VBUS</sub> | Input voltage         | 4   |     | 13.5 | V    |
| V <sub>BAT</sub>  | Battery voltage       |     |     | 4.52 | V    |
| I <sub>VBUS</sub> | Input current         |     |     | 3.2  | A    |
| I <sub>SW</sub>   | Output current (SW)   |     |     | 1.8  | A    |
| I <sub>BAT</sub>  | Fast charging current |     |     | 1.5  | A    |
| I <sub>BAT</sub>  | RMS discharge current |     |     | 5    | A    |
| T <sub>A</sub>    | Ambient temperature   | -40 |     | 85   | °C   |
| L                 | Inductance            |     | 1   | 2.2  | μH   |
| C <sub>VBUS</sub> | VBUS capacitance      |     | 1   |      | μF   |
| C <sub>PMID</sub> | PMID capacitance      |     | 10  |      | μF   |
| C <sub>SYS</sub>  | SYS capacitance       |     | 10  |      | μF   |
| C <sub>BAT</sub>  | BAT capacitance       |     | 10  |      | μF   |
| C <sub>REGN</sub> | REGN capacitance      |     | 4.7 |      | μF   |

## 6.4 Thermal Information

| THERMAL METRIC <sup>(1)</sup> |  | BQ25618     | UNIT |
|-------------------------------|--|-------------|------|
|                               |  | YFF (DSBGA) |      |
|                               |  | 30 Balls    |      |
| R <sub>θJA</sub>              | Junction-to-ambient thermal resistance (JEDEC <sup>(1)</sup> ) | 58.8        | °C/W |
| R <sub>θJC(top)</sub>         | Junction-to-case (top) thermal resistance                      | 0.2         | °C/W |
| R <sub>θJB</sub>              | Junction-to-board thermal resistance                           | 8.3         | °C/W |
| Ψ <sub>JT</sub>               | Junction-to-top characterization parameter                     | 1.4         | °C/W |
| Ψ <sub>JB</sub>               | Junction-to-board characterization parameter                   | 8.3         | °C/W |
| R <sub>θJC(bot)</sub>         | Junction-to-case (bottom) thermal resistance                   | N/A         | °C/W |

(1) For more information about traditional and new thermal metrics, see the [Semiconductor and IC Package Thermal Metrics](#) application report.

## 6.5 Thermal Information

| THERMAL METRIC <sup>(1)</sup> |  | BQ25619    | UNIT |
|-------------------------------|--|------------|------|
|                               |  | RTW (WQFN) |      |
|                               |  | 24 Pins    |      |
| R <sub>θJA</sub>              | Junction-to-ambient thermal resistance (JEDEC <sup>(1)</sup> ) | 35.6       | °C/W |
| R <sub>θJC(top)</sub>         | Junction-to-case (top) thermal resistance                      | 22.7       | °C/W |
| R <sub>θJB</sub>              | Junction-to-board thermal resistance                           | 11.9       | °C/W |
| Ψ <sub>JT</sub>               | Junction-to-top characterization parameter                     | 0.2        | °C/W |
| Ψ <sub>JB</sub>               | Junction-to-board characterization parameter                   | 12         | °C/W |
| R <sub>θJC(bot)</sub>         | Junction-to-case (bottom) thermal resistance                   | 2.6        | °C/W |

(1) For more information about traditional and new thermal metrics, see the [Semiconductor and IC Package Thermal Metrics](#) application report.

## 6.6 Electrical Characteristics

$V_{VBUS\_UVLOZ} < V_{VBUS} < V_{VBUS\_OV}$  and  $V_{VBUS} > V_{BAT} + V_{SLEEP}$ ,  $T_J = -40^{\circ}\text{C}$  to  $+125^{\circ}\text{C}$ , and  $T_J = 25^{\circ}\text{C}$  for typical values (unless otherwise noted)

| PARAMETER                 |  | TEST CONDITIONS  | MIN | TYP  | MAX  | UNIT |
|---------------------------|--|--|-----|------|------|------|
| <b>QUIESCENT CURRENTS</b> |  |  |     |      |      |      |
| I <sub>Q_BAT</sub>        | Quiescent battery current (BATSNS, BAT, SYS, SW)   | VBAT = 4.5V, VBUS floating, SCL, SDA = 0V or 1.8V, T <sub>J</sub> < 85 °C, BATFET enabled  |     | 9.5  | 15   | μA   |
| I <sub>SHIP_BAT</sub>     | Shipmode battery current (BATSNS, BAT, SYS, SW)  | VBAT = 4.5V, VBUS floating, SCL, SDA = 0V or 1.8V, T <sub>J</sub> < 85 °C, BATFET disabled |     | 7    | 9.5  | μA   |
| I <sub>VBUS</sub>         | Input current (VBUS) in buck mode when converter is switching                              | VBUS=5V, charge disabled, converter switching, ISYS = 0A                                   |     | 2.3  |      | mA   |
| I <sub>HIZ_VBUS</sub>     | Quiescent input current in HIZ   | VAC/VBUS = 5V, HIZ mode, no battery  |     | 37   | 50   | μA   |
|                           |  | VAC/VBUS = 12V, HIZ mode, no battery   |     | 68   | 90   | μA   |
| I <sub>BST</sub>          | Quiescent battery current (BATSNS, BAT, SYS, SW) in boost mode when converter is switching | VBAT = 4.5V, VBUS = 5V, boost mode enabled, converter switching, I <sub>PMID</sub> = 0A    |     | 2.4  |      | mA   |
| <b>VBUS / VBAT SUPPLY</b> |  |  |     |      |      |      |
| V <sub>VBUS_OP</sub>      | VBUS operating range   |  | 4   |      | 13.5 | V    |
| V <sub>VBUS_UVLOZ</sub>   | VBUS rising for active I2C, no battery   | VBUS rising  |     | 3.3  | 3.7  | V    |
| V <sub>VBUS_UVLO</sub>    | VBUS falling to turnoff I2C, no battery  | VBUS falling   |     | 3    | 3.3  | V    |
| V <sub>VBUS_PRESENT</sub> | VBUS to enable REGN  | VBUS rising  |     | 3.65 | 3.9  | V    |



## 6.6 Electrical Characteristics (continued)

$V_{VBUS\_UVLOZ} < V_{VBUS} < V_{VBUS\_OV}$  and  $V_{VBUS} > V_{BAT} + V_{SLEEP}$ ,  $T_J = -40^{\circ}\text{C}$  to  $+125^{\circ}\text{C}$ , and  $T_J = 25^{\circ}\text{C}$  for typical values (unless otherwise noted)

| PARAMETER                    |   | TEST CONDITIONS   | MIN   | TYP  | MAX    | UNIT |
|------------------------------|---|---|-------|------|--------|------|
| $V_{VBUS\_PRESENTZ}$         | VBUS to disable REGN                                  | VBUS falling  |       | 3.15 | 3.4    | V    |
| $V_{SLEEP}$                  | Enter Sleep mode threshold                            | VBUS falling, $V_{BUS} - V_{BAT}$ , $V_{BAT} = 4\text{V}$                   | 15    | 60   | 110    | mV   |
| $V_{SLEEPZ}$                 | Exit Sleep mode threshold                             | VBUS rising, $V_{BUS} - V_{BAT}$ , $V_{BAT} = 4\text{V}$                    | 115   | 220  | 340    | mV   |
| $V_{ACOV}$                   | VAC overvoltage rising threshold to turn of switching | VAC rising, OVP[1:0]=00   | 5.45  | 5.85 | 6.07   | V    |
|                              |   | VAC rising, OVP[1:0]=01   | 6.1   | 6.4  | 6.75   | V    |
|                              |   | VAC rising, OVP[1:0]=10   | 10.45 | 11   | 11.55  | V    |
|                              |   | VAC rising, OVP[1:0]=11 (default)   | 13.5  | 14.2 | 14.85  | V    |
|                              | VAC overvoltage falling threshold to resume switching | VAC falling, OVP[1:0]=00  | 5.2   | 5.6  | 5.8    | V    |
|                              |   | VAC falling, OVP[1:0]=01  | 5.8   | 6.2  | 6.45   | V    |
|                              |   | VAC falling, OVP[1:0]=10  | 10    | 10.7 | 11.1   | V    |
|                              |   | VAC falling, OVP[1:0]=11 (default)  | 13    | 13.9 | 14.5   | V    |
| $V_{BAT\_UVLOZ}$             | BAT voltage for active I2C, no VBUS                   | VBAT rising   | 2.5   |      |        | V    |
| $V_{BAT\_DPLZ}$              | BAT depletion rising threshold to turn on BATFET      | VBAT rising   | 2.35  |      | 2.8    | V    |
| $V_{BAT\_DPL}$               | BAT depletion falling threshold to turn off BATFET    | VBAT falling  | 2.18  |      | 2.62   | V    |
| $V_{POORSRC}$                | Bad adapter detection threshold                       | VBUS falling  | 3.75  | 3.9  | 4.0    | V    |
| <b>POWER PATH MANAGEMENT</b> |   |   |       |      |        |      |
| $V_{SYS\_MIN}$               | Typical minimum system regulation voltage             | $V_{BAT}=3.2\text{V} < V_{SYS\_MIN} = 3.5\text{V}$ , $I_{SYS} = 0\text{A}$  | 3.5   | 3.65 |        | V    |
| $V_{SYS\_OVP}$               | System overvoltage threshold                          | $V_{REG} = 4.35\text{V}$ , Charge disabled, $I_{SYS} = 0\text{A}$           |       | 4.7  |        | V    |
| $R_{ON\_RBFET}$              | Blocking FET on-resistance (BQ25618)                  |   |       | 35   |        | mΩ   |
| $R_{ON\_RBFET}$              | Blocking FET on-resistance (BQ25619)                  |   |       | 45   |        | mΩ   |
| $R_{ON\_HSFET}$              | High-side switching FET on-resistance (BQ25618)       |   |       | 55   |        | mΩ   |
| $R_{ON\_HSFET}$              | High-side switching FET on-resistance (BQ25619)       |   |       | 62   |        | mΩ   |
| $R_{ON\_LSFET}$              | Low-side switching FET on-resistance (BQ25618)        |   |       | 60   |        | mΩ   |
| $R_{ON\_LSFET}$              | Low-side switching FET on-resistance (BQ25619)        |   |       | 71   |        | mΩ   |
| $V_{BATFET\_FWD}$            | BATFET forward voltage in supplement mode             | BAT discharge current 10mA, converter running                               |       | 30   |        | mV   |
| <b>BATTERY CHARGER</b>       |   |   |       |      |        |      |
| $V_{REG\_RANGE}$             | Typical charge voltage regulation range               |   | 3.5   |      | 4.52   | V    |
| $V_{REG\_STEP}$              | Typical charge voltage step                           | $4.3\text{V} < V_{REG} < 4.52\text{V}$                                      |       | 10   |        | mV   |
| $V_{REG\_ACC}$               | Charge voltage accuracy                               | $V_{REG} = 4.2\text{V}$ , $T_J = -40^{\circ}\text{C} - 85^{\circ}\text{C}$  | 4.183 | 4.2  | 4.2168 | V    |
| $V_{REG\_ACC}$               | Charge voltage accuracy                               | $V_{REG} = 4.35\text{V}$ , $T_J = -40^{\circ}\text{C} - 85^{\circ}\text{C}$ | 4.333 | 4.35 | 4.367  | V    |
| $V_{REG\_ACC}$               | Charge voltage accuracy                               | $V_{REG} = 4.45\text{V}$ , $T_J = -40^{\circ}\text{C} - 85^{\circ}\text{C}$ | 4.432 | 4.45 | 4.468  | V    |
| $I_{CHG\_RANGE}$             | Typical charge current regulation range               |   | 0     |      | 1.5    | A    |
| $I_{CHG\_STEP}$              | Typical charge current regulation step                |   |       | 20   |        | mA   |

## 6.6 Electrical Characteristics (continued)

$V_{VBUS\_UVLOZ} < V_{VBUS} < V_{VBUS\_OV}$  and  $V_{VBUS} > V_{BAT} + V_{SLEEP}$ ,  $T_J = -40^{\circ}\text{C}$  to  $+125^{\circ}\text{C}$ , and  $T_J = 25^{\circ}\text{C}$  for typical values (unless otherwise noted)

| PARAMETER                                      |  | TEST CONDITIONS  | MIN   | TYP  | MAX   | UNIT |
|--|--|--|-------|------|-------|------|
| I <sub>CHG_ACC</sub>                           | Fast charge current regulation accuracy                    | ICHG = 0.24A, VBAT = 3.1V or 3.8V, T <sub>J</sub> = -40°C - 85°C | 0.216 | 0.24 | 0.264 | A    |
|  |  | ICHG = 0.72A, VBAT = 3.1V or 3.8V, T <sub>J</sub> = -40°C - 85°C | 0.684 | 0.72 | 0.756 | A    |
|  |  | ICHG = 1.50A, VBAT = 3.1V or 3.8V, T <sub>J</sub> = -40°C - 85°C | 1.425 | 1.5  | 1.575 | A    |
| I <sub>PRECHG_RANGE</sub>                      | Typical pre-charge current range                           |  | 20    | 260  | mA    |      |
| I <sub>PRECHG_STEP</sub>                       | Typical pre-charge current step                            |  |       | 20   | mA    |      |
| I <sub>PRECHG_ACC</sub>                        | Precharge current accuracy                                 | VBAT = 2.6V, IPRECHG = 40mA                                      | 28    | 40   | 52    | mA   |
|  |  | VBAT = 2.6V, IPRECHG = 120mA                                     | 84    | 120  | 156   | mA   |
| I <sub>TERM_RANGE</sub>                        | Typical termination current range                          |  | 20    | 260  | mA    |      |
| I <sub>TERM_STEP</sub>                         | Typical termination current step                           |  |       | 20   | mA    |      |
| I <sub>TERM_ACC</sub>                          | Termination current accuracy                               | ITERM=40mA, ICHG>260mA, VREG=4.35V, T <sub>J</sub> = 0°C - 85°C  | 30    | 40   | 50    | mA   |
|  |  | ITERM=20mA, ICHG<260mA, VREG=4.35V, T <sub>J</sub> = 0°C - 85°C  | 10    | 20   | 30    | mA   |
| V <sub>BAT_SHORTZ</sub>                        | Battery short voltage rising threshold to start pre-charge | VBAT rising  | 2.13  | 2.25 | 2.35  | V    |
| V <sub>BAT_SHORT</sub>                         | Battery short voltage falling threshold to stop pre-charge | VBAT falling   | 1.85  | 2    | 2.15  | V    |
| I <sub>BAT_SHORT</sub>                         | Battery short trickle charging current                     | VBAT < V <sub>BAT_SHORTZ</sub>                                   | 15    | 25   | 30    | mA   |
| V <sub>BATLOWV</sub>                           | Battery LOWV rising threshold to start fast-charge         | VBAT rising  | 3     | 3.12 | 3.24  | V    |
|  | Battery LOWV falling threshold to stop fast-charge         | VBAT falling   | 2.7   | 2.8  | 2.9   | V    |
| V <sub>RECHG</sub>                             | Battery recharge threshold                                 | VRECHG=0, VBAT falling (default)                                 | 90    | 120  | 150   | mV   |
|  |  | VRECHG=1, VBAT falling   | 185   | 210  | 245   | mV   |
| I <sub>SYS_LOAD</sub>                          | System discharge load current during SYSOVP                |  |       | 30   | mA    |      |
| R <sub>ON_BATFET</sub>                         | Battery FET on-resistance                                  | T <sub>J</sub> = -40°C - 85°C                                    |       | 19.5 | 26    | mΩ   |
|  |  | T <sub>J</sub> = -40°C - 125°C                                   |       | 19.5 | 30    | mΩ   |
| <b>BATTERY OVERVOLTAGE PROTECTION</b>          |  |  |       |      |       |      |
| V <sub>BAT_OVP</sub>                           | Battery overvoltage rising threshold                       | VBAT rising, as percentage of VREG                               | 103   | 104  | 105   | %    |
|  | Battery overvoltage falling threshold                      | VBAT falling, as percentage of VREG                              | 101   | 102  | 103   | %    |
| <b>INPUT VOLTAGE / CURRENT REGULATION</b>      |  |  |       |      |       |      |
| V <sub>INDPM_RANGE</sub>                       | Typical input voltage regulation range                     |  | 3.9   |      | 5.4   | V    |
| V <sub>INDPM_STEP</sub>                        | Typical input voltage regulation step                      |  |       | 100  |       | mV   |
| V <sub>INDPM_ACC</sub>                         | Typical input voltage regulation accuracy                  |  | 4.365 | 4.5  | 4.635 | V    |
| V <sub>INDPM_TRACK</sub>                       | VINDPM threshold to track battery voltage                  | VBAT = 4.35V, VINDPM_BAT_TRACK = VBAT+200mV                      | 4.45  | 4.55 | 4.74  | V    |
| I <sub>INDPM_RANGE</sub>                       | Typical input current regulation range                     |  | 0.1   |      | 3.2   | A    |
| I <sub>INDPM_STEP</sub>                        | Typical input current regulation step                      |  |       | 100  |       | mA   |
| I <sub>INDPM_ACC</sub>                         | Input current regulation accuracy                          | IINDPM = 500mA (T <sub>J</sub> =-40°C - 85°C)                    | 450   | 465  | 500   | mA   |
| I <sub>INDPM_ACC</sub>                         | Input current regulation accuracy                          | IINDPM = 900mA (T <sub>J</sub> =-40°C-85°C)                      | 750   | 835  | 900   | mA   |
| I <sub>INDPM_ACC</sub>                         | Input current regulation accuracy                          | IINDPM = 1500mA (T <sub>J</sub> =-40°C-85°C)                     | 1300  | 1390 | 1500  | mA   |
| <b>THERMAL REGULATION AND THERMAL SHUTDOWN</b> |  |  |       |      |       |      |

## 6.6 Electrical Characteristics (continued)

$V_{VBUS\_UVLOZ} < V_{VBUS} < V_{VBUS\_OV}$  and  $V_{VBUS} > V_{BAT} + V_{SLEEP}$ ,  $T_J = -40^{\circ}\text{C}$  to  $+125^{\circ}\text{C}$ , and  $T_J = 25^{\circ}\text{C}$  for typical values (unless otherwise noted)

| PARAMETER   |   | TEST CONDITIONS                               | MIN   | TYP   | MAX   | UNIT |
|---|---|---|-------|-------|-------|------|
| T <sub>REG</sub>  | Junction temperature regulation accuracy  | TREG = 90°C                                   |       | 90    |       | °C   |
|   |   | TREG = 110°C                                  |       | 110   |       | °C   |
| T <sub>SHUT</sub>   | Thermal Shutdown Rising threshold   | Temperature Increasing                        |       | 150   |       | °C   |
|   | Thermal Shutdown Falling threshold  | Temperature Decreasing                        |       | 130   |       | °C   |
| <b>CHARGE MODE THERMISTOR COMPARATOR (JEITA 616J or HOT/COLD 616)</b> |   |   |       |       |       |      |
| V <sub>T1_RISE%</sub>   | TS pin voltage rising threshold. Charge suspended above this voltage.                           | As Percentage to REGN (0°C w/ 103AT)          | 72.4  | 73.3  | 74.2  | %    |
| V <sub>T1_FALL%</sub>   | TS pin voltage falling threshold. Charge re-enabled to 20% of ICHG and VREG below this voltage. | As Percentage to REGN                         | 71.5  | 72    | 72.5  | %    |
| V <sub>T2_RISE%</sub>   | TS pin voltage rising threshold. Charge back to 20% of ICHG and VREG above this voltage.        | As Percentage to REGN, JEITA_T2=5°C w/ 103AT  | 70.25 | 70.75 | 71.25 | %    |
|   |   | As Percentage to REGN, JEITA_T2=10°C w/ 103AT | 67.75 | 68.25 | 68.75 | %    |
|   |   | As Percentage to REGN, JEITA_T2=15°C w/ 103AT | 64.75 | 65.25 | 65.75 | %    |
|   |   | As Percentage to REGN, JEITA_T2=20°C w/ 103AT | 61.75 | 62.25 | 62.75 | %    |
| V <sub>T2_FALL%</sub>   | TS pin voltage falling threshold. Charge back to ICHG and VREG below this voltage.              | As Percentage to REGN, JEITA_T2=5°C w/ 103AT  | 68.7  | 69.2  | 69.7  | %    |
|   |   | As Percentage to REGN, JEITA_T2=10°C w/ 103AT | 66.45 | 66.95 | 67.45 | %    |
|   |   | As Percentage to REGN, JEITA_T2=15°C w/ 103AT | 63.7  | 64.2  | 64.7  | %    |
|   |   | As Percentage to REGN, JEITA_T2=20°C w/ 103AT | 60.7  | 61.2  | 61.7  | %    |
| V <sub>T3_FALL%</sub>   | TS pin voltage falling threshold. Charge to ICHG and 4.1V below this voltage.                   | As Percentage to REGN, JEITA_T3=40°C w/ 103AT | 47.75 | 48.25 | 48.75 | %    |
|   |   | As Percentage to REGN, JEITA_T3=45°C w/ 103AT | 44.25 | 44.75 | 45.25 | %    |
|   |   | As Percentage to REGN, JEITA_T3=50°C w/ 103AT | 40.2  | 40.7  | 41.2  | %    |
|   |   | As Percentage to REGN, JEITA_T3=55°C w/ 103AT | 37.2  | 37.7  | 38.2  | %    |
| V <sub>T3_RISE%</sub>   | TS pin voltage rising threshold. Charge back to ICHG and VREG above this voltage.               | As Percentage to REGN, JEITA_T3=40°C w/ 103AT | 48.8  | 49.3  | 49.8  | %    |
|   |   | As Percentage to REGN, JEITA_T3=45°C w/ 103AT | 45.3  | 45.8  | 46.3  | %    |
|   |   | As Percentage to REGN, JEITA_T3=50°C w/ 103AT | 41.3  | 41.8  | 42.3  | %    |
|   |   | As Percentage to REGN, JEITA_T3=55°C w/ 103AT | 38.5  | 39    | 39.5  | %    |
| V <sub>T5_FALL%</sub>   | TS pin voltage falling threshold, charge suspended below this voltage.                          | As Percentage to REGN (60°C w/ 103AT)         | 33.7  | 34.2  | 35.1  | %    |
| V <sub>T5_RISE%</sub>   | TS pin voltage rising threshold. Charge back to ICHG and 4.1V above this voltage.               | As Percentage to REGN                         | 35    | 35.5  | 36    | %    |
| <b>BOOST MODE THERMISTOR COMPARATOR (HOT/COLD)</b>                    |   |   |       |       |       |      |

## 6.6 Electrical Characteristics (continued)

$V_{VBUS\_UVLOZ} < V_{VBUS} < V_{VBUS\_OV}$  and  $V_{VBUS} > V_{BAT} + V_{SLEEP}$ ,  $T_J = -40^{\circ}\text{C}$  to  $+125^{\circ}\text{C}$ , and  $T_J = 25^{\circ}\text{C}$  for typical values (unless otherwise noted)

| PARAMETER                       |  | TEST CONDITIONS  | MIN  | TYP  | MAX  | UNIT          |
|---------------------------------|--|--|------|------|------|---------------|
| $V_{BCOLD\_RISE\%}$             | TS pin voltage rising threshold, boost mode is suspended above this voltage. | As Percentage to REGN ( $-19.5^{\circ}\text{C}$ w/ 103AT)              | 79.5 | 80   | 80.5 | %             |
| $V_{BCOLD\_FALL\%}$             | TS pin voltage falling threshold   | As Percentage to REGN ( $0^{\circ}\text{C}$ w/ 103AT)                  |      | 72   |      | %             |
| $V_{BHOT\_FALL\%}$              | TS pin voltage threshold. boost mode is suspended below this voltage.        | As Percentage to REGN, ( $64^{\circ}\text{C}$ w/ 103AT)                | 30.2 | 31.2 | 32.2 | %             |
| $V_{BHOT\_RISE\%}$              | TS pin voltage rising threshold  | As Percentage to REGN, ( $55^{\circ}\text{C}$ w/ 103AT), REG0C[1:0]=11 |      | 39   |      | %             |
| <b>SWITCHING CONVERTER</b>      |  |  |      |      |      |               |
| $F_{SW}$                        | PWM switching frequency  | Oscillator frequency   | 1.32 | 1.5  | 1.68 | MHz           |
| $D_{MAX}$                       | Maximum PWM Duty Cycle   |  |      | 97   |      | %             |
| <b>BOOST MODE CONVERTER</b>     |  |  |      |      |      |               |
| $V_{BATLOWV\_OTG}$              | Battery voltage exiting boost mode   | $V_{VBAT}$ falling   | 2.6  | 2.8  | 2.9  | V             |
|                                 | Battery voltage entering boost mode  | $V_{VBAT}$ rising  | 2.9  | 3.0  | 3.15 | V             |
| $V_{BST\_BAT}$                  | Battery voltage exiting boost mode   | BAT falling $V_{VBAT}$   | 2.4  | 2.5  | 2.6  | V             |
| $V_{BST\_RANGE}$                | Typical boost mode voltage regulation range                                  |  | 4.6  |      | 5.15 | V             |
| $V_{BST\_ACC}$                  | Boost mode voltage regulation accuracy                                       | $I_{VBUS} = 0\text{A}$ , $BOOST\_V = 5\text{V}$                        | 4.85 | 5    | 5.15 | V             |
| $I_{SYS\_OCP\_Q4}$              | Boost mode battery discharge current clamp on BATFET Q4                      |  | 5    | 6    |      | A             |
| $V_{BST\_OVP}$                  | Boost mode overvoltage threshold on PMID                                     |  | 5.55 | 5.8  | 6.15 | V             |
| <b>REGN LDO</b>                 |  |  |      |      |      |               |
| $V_{REGN}$                      | REGN LDO output voltage  | $V_{VBUS} = 5\text{V}$ , $I_{REGN} = 20\text{mA}$                      | 4.58 | 4.7  | 4.8  | V             |
|                                 |  | $V_{VBUS} = 9\text{V}$ , $I_{REGN} = 20\text{mA}$                      | 5.6  | 6    | 6.5  | V             |
| $I_{REGN}$                      | REGN LDO current limit   | $V_{VBUS} = 5\text{V}$ , $V_{REGN} = 3.8\text{V}$                      | 50   |      |      | mA            |
| <b>I2C INTERFACE (SCL, SDA)</b> |  |  |      |      |      |               |
| $V_{IH}$                        | Input high threshold level, SDA and SCL                                      | Pull up rail 1.8V  | 1.3  |      |      | V             |
| $V_{IL}$                        | Input low threshold level  | Pull up rail 1.8V  |      |      | 0.4  | V             |
| $V_{OL}$                        | Output low threshold level   | Sink current = 5mA   |      |      | 0.4  | V             |
| $I_{BIAS}$                      | High-level leakage current   | Pull up rail 1.8V  |      |      | 1    | $\mu\text{A}$ |
| $V_{IH\_SDA}$                   | Input high threshold level, SDA  | Pull up rail 1.8V  | 1.3  |      |      | V             |
| $V_{IL\_SDA}$                   | Input low threshold level  | Pull up rail 1.8V  |      |      | 0.4  | V             |
| $V_{OL\_SDA}$                   | Output low threshold level   | Sink current = 5mA   |      |      | 0.4  | V             |
| $I_{BIAS\_SDA}$                 | High-level leakage current   | Pull up rail 1.8V  |      |      | 1    | $\mu\text{A}$ |
| $V_{IH\_SCL}$                   | Input high threshold level, SDA  | Pull up rail 1.8V  | 1.3  |      |      | V             |
| $V_{IL\_SCL}$                   | Input low threshold level  | Pull up rail 1.8V  |      |      | 0.4  | V             |
| $V_{OL\_SCL}$                   | Output low threshold level   | Sink current = 5mA   |      |      | 0.4  | V             |
| $I_{BIAS\_SCL}$                 | High-level leakage current   | Pull up rail 1.8V  |      |      | 1    | $\mu\text{A}$ |
| <b>LOGIC INPUT PIN</b>          |  |  |      |      |      |               |
| $V_{IH}$                        | Input high threshold level (/CE, PSEL)                                       |  | 1.3  |      |      | V             |
| $V_{IL}$                        | Input low threshold level (/CE, PSEL)  |  |      |      | 0.4  | V             |
| $I_{IN\_BIAS}$                  | High-level leakage current (/CE, PSEL)                                       | Pull up rail 1.8V  |      |      | 1    | $\mu\text{A}$ |

## 6.6 Electrical Characteristics (continued)

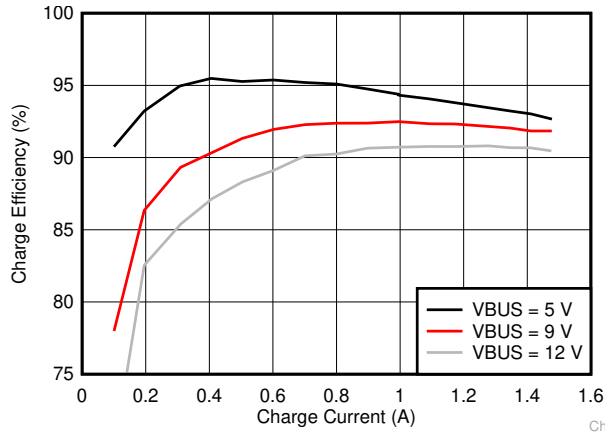
$V_{VBUS\_UVLOZ} < V_{VBUS} < V_{VBUS\_OV}$  and  $V_{VBUS} > V_{BAT} + V_{SLEEP}$ ,  $T_J = -40^{\circ}\text{C}$  to  $+125^{\circ}\text{C}$ , and  $T_J = 25^{\circ}\text{C}$  for typical values (unless otherwise noted)

| PARAMETER               |  | TEST CONDITIONS    | MIN | TYP | MAX | UNIT          |
|-------------------------|--|--------------------|-----|-----|-----|---------------|
| <b>LOGIC OUTPUT PIN</b> |  |                    |     |     |     |               |
| $V_{OL}$                | Output low threshold level (/INT, STAT, PMID_GOOD) | Sink current = 5mA |     |     | 0.4 | V             |
| $I_{OUT\_BIAS}$         | High-level leakage current (/INT, STAT, PMID_GOOD) | Pull up rail 1.8V  |     |     | 1   | $\mu\text{A}$ |

## 6.7 Timing Requirements

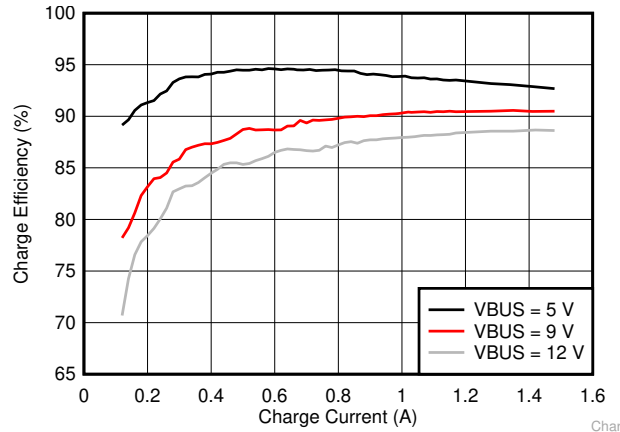
|                                   |  | MIN | NOM | MAX | UNIT |
|-----------------------------------|--|-----|-----|-----|------|
| <b>VBUS / VBAT POWER UP</b>       |  |     |     |     |      |
| $t_{VBUS\_OV}$                    | VBUS OVP Reaction-time   |     | 130 |     | ns   |
| $t_{POORSRC}$                     | Bad adapter detection duration   |     | 30  |     | ms   |
| $t_{POORSRC\_RETRY}$              | Bad adapter detection retry wait time  |     | 2   |     | s    |
| <b>BATTERY CHARGER</b>            |  |     |     |     |      |
| $t_{TERM\_DGL}$                   | Deglitch time for charge termination   |     | 30  |     | ms   |
| $t_{RECHG\_DGL}$                  | Deglitch time for recharge threshold   |     | 30  |     | ms   |
| $t_{TOP\_OFF}$                    | Typical top-off timer accuracy TOP_OFF_TIMER[1:0]=10   | 24  | 30  | 36  | min  |
| $t_{SAFETY}$                      | Charge safety timer accuracy, CHG_TIMER = 20hr   | 17  | 20  | 24  | hr   |
| $t_{SAFETY}$                      | Charge safety timer accuracy, CHG_TIMER = 10hr   | 8   | 10  | 12  | hr   |
| <b>QON Timing</b>                 |  |     |     |     |      |
| $t_{SHIPMODE}$                    | $\overline{QON}$ low time to turn on BATFET and exit shipmode ( $-10^{\circ}\text{C} \leq T_J \leq 60^{\circ}\text{C}$ ) | 0.9 |     | 1.3 | s    |
| $t_{QON\_RST}$                    | $\overline{QON}$ low time before BATFET full system reset ( $-10^{\circ}\text{C} \leq T_J \leq 60^{\circ}\text{C}$ )     | 8   |     | 12  | s    |
| $t_{BATFET\_RST}$                 | BATFET off time during full system reset ( $-10^{\circ}\text{C} \leq T_J \leq 60^{\circ}\text{C}$ )                      | 250 |     | 400 | ms   |
| $t_{BATFET\_DLY}$                 | Delay time before BATFET turn off in ship mode ( $-10^{\circ}\text{C} \leq T_J \leq 60^{\circ}\text{C}$ )                | 10  |     | 15  | s    |
| <b>I2C INTERFACE</b>              |  |     |     |     |      |
| $f_{SCL}$                         | SCL clock frequency  |     |     | 400 | kHz  |
| <b>DIGITAL CLOCK AND WATCHDOG</b> |  |     |     |     |      |
| $f_{LPDIG}$                       | Digital low-power clock (REGN LDO is disabled)   |     | 30  |     | kHz  |
| $f_{DIG}$                         | Digital power clock  |     | 500 |     | kHz  |
| $t_{LP\_WDT}$                     | Watchdog Reset time  |     | 160 |     | s    |
| $t_{WDT}$                         | Watchdog Reset time (WATCHDOG REG05[5:4] = 160s)   |     | 160 |     | s    |

## 6.8 Typical Characteristics



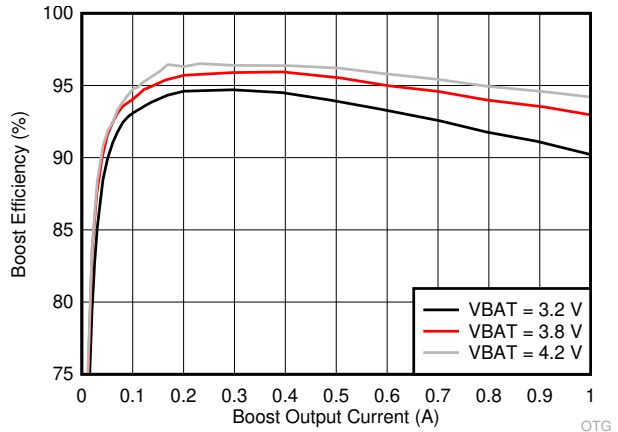
BQ25619EVM  $V_{BAT} = 3.8V$  Inductor  $2.2\mu H$ , DCR =  $40\ m\Omega$

**Figure 6-1. Charge Efficiency**



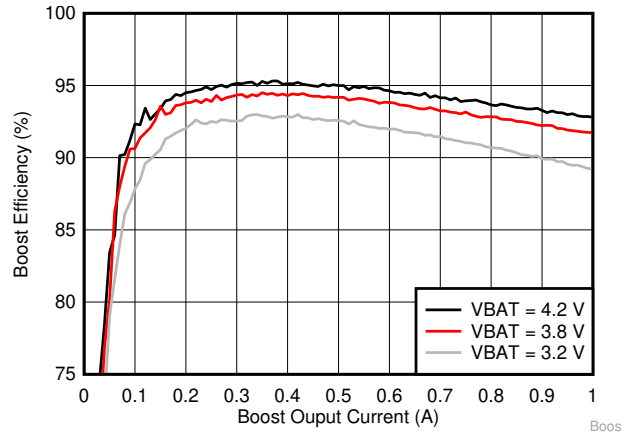
BQ25618EVM  $V_{BAT} = 3.8V$  Inductor  $1.0\mu H$ , DCR =  $27\ m\Omega$

**Figure 6-2. Charge Efficiency**



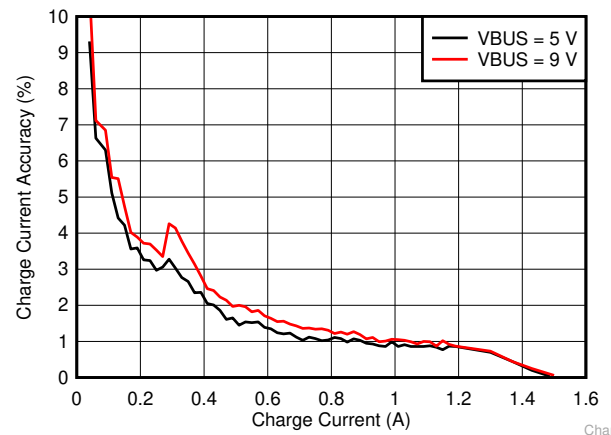
BQ25619EVM  $V_{PMID} = 4.6V$  Inductor  $2.2\mu H$ , DCR =  $40\ m\Omega$

**Figure 6-3. Boost Efficiency**

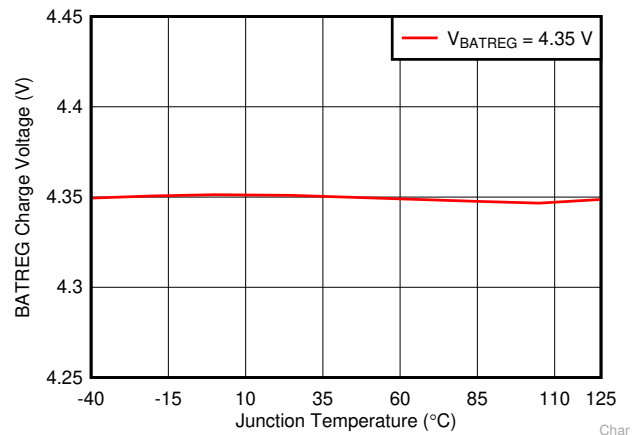


BQ25618EVM  $V_{PMID} = 4.6V$   $1.0\ \mu H$  Inductor, DCR =  $27\ m\Omega$

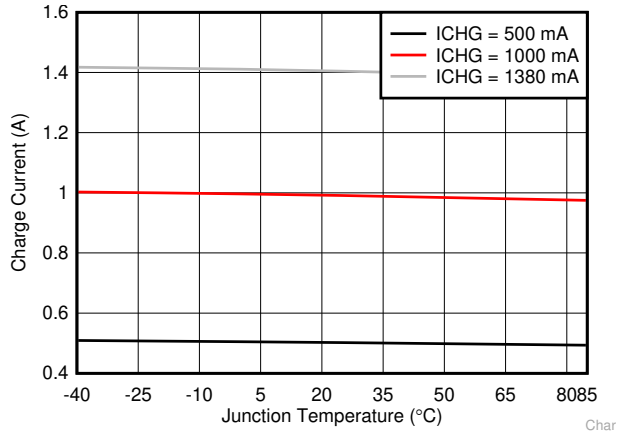
**Figure 6-4. Boost Efficiency**



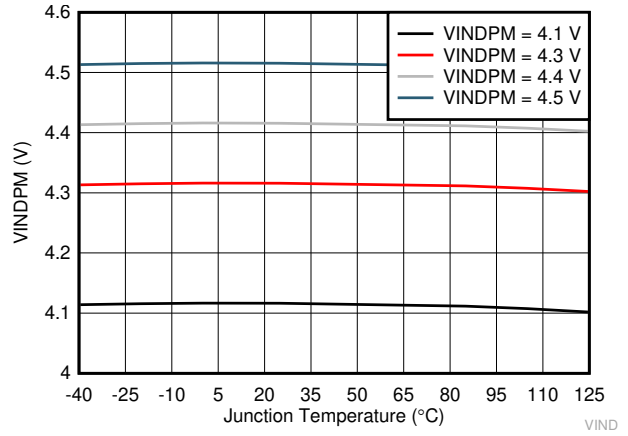
**Figure 6-5. Charge Current Accuracy**



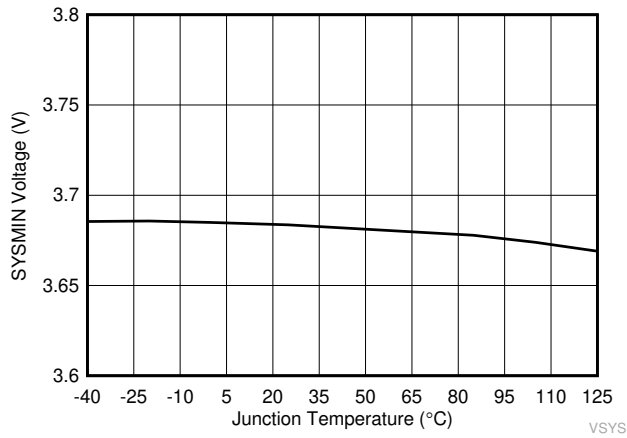
**Figure 6-6. Battery Charge Voltage vs Junction Temperature**



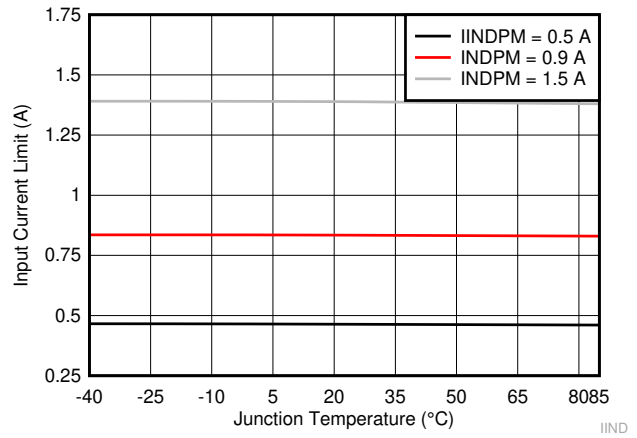
**Figure 6-7. Charge Current vs Junction Temperature**



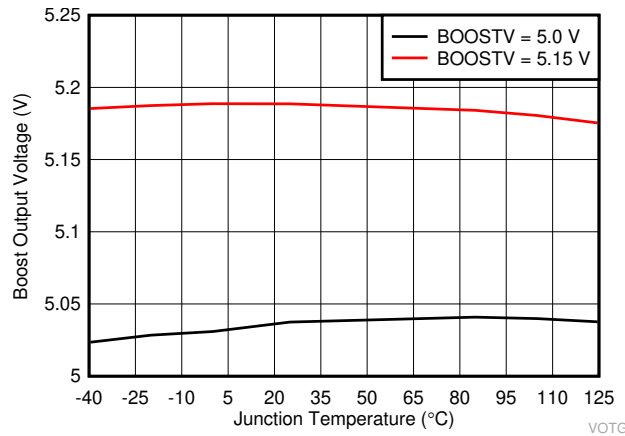
**Figure 6-8. VINDPM vs Junction Temperature**



**Figure 6-9. SYSMIN Voltage vs Junction Temperature (VSYS set at 3.5 V)**



**Figure 6-10. Input Current Limit vs Junction Temperature**



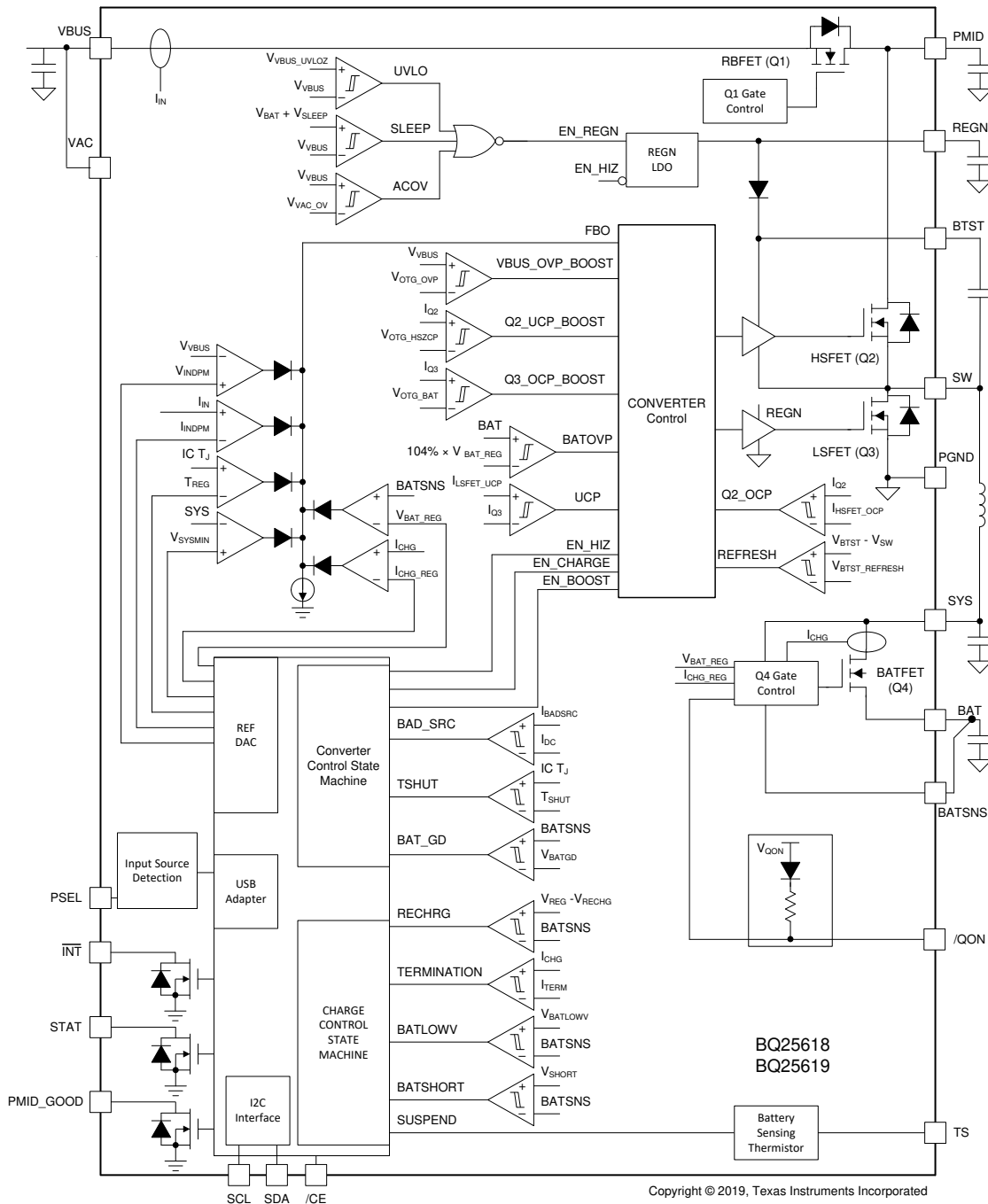
**Figure 6-11. Boost Output Voltage vs Junction Temperature**

## 7 Detailed Description

### 7.1 Overview

The BQ25619/618 device is a highly integrated 1.5-A switch-mode battery charger for single cell Li-ion and Li-polymer battery. It includes an input reverse-blocking FET (RBFET, Q1), high-side switching FET (HSFET, Q2), low-side switching FET (LSFET, Q3), and battery FET (BATFET, Q4), and bootstrap diode for the high-side gate drive.

### 7.2 Functional Block Diagram





## 7.3 Feature Description

### 7.3.1 Power-On-Reset (POR)

The device powers internal bias circuits from the higher voltage of V<sub>BUS</sub> and BAT. When V<sub>VBUS</sub> rises above V<sub>VBUS\_UVLOZ</sub> or V<sub>BAT</sub> rises above V<sub>BAT\_UVLOZ</sub>, the sleep comparator, battery depletion comparator, and BATFET driver are active. The I<sup>2</sup>C interface is ready for communication and all registers are reset to default values. The host can access all registers after POR.

### 7.3.2 Device Power Up From Battery Without Input Source

If only the battery is present and the voltage is above depletion threshold (V<sub>BAT\_DPLZ</sub>), the BATFET turns on and connects the battery to the system. The REGN stays off to minimize the quiescent current. The low R<sub>DS(on)</sub> of BATFET and the low quiescent current on BAT minimize the conduction loss and maximize the battery run time.

The device always monitors the discharge current through the BATFET. When the system is overloaded or shorted (I<sub>BAT</sub> > I<sub>SYS\_OCP\_Q4</sub>), the device turns off BATFET immediately.

With I<sup>2</sup>C, when the BATFET turns off due to overcurrent, the device sets the BATFET\_DIS bit to indicate the BATFET is disabled until the input source plugs in again or one of the methods described in [Section 7.3.7.2](#) is applied to re-enable BATFET.

### 7.3.3 Power Up From Input Source

When an input source is plugged in, the device checks the input source voltage to turn on the REGN LDO and all the bias circuits. It detects and sets the input current limit before the buck converter is started. The power-up sequence from input source is as listed:

1. Power Up REGN LDO, see [Section 7.3.3.1](#)
2. Poor Source Qualification, see [Section 7.3.3.2](#)
3. Input Source Type Detection is based on PSEL to set default input current limit (IINDPM threshold), see [Section 7.3.3.3](#)
4. Input Voltage Limit Threshold Setting (VINDPM threshold), see [Section 7.3.3.4](#)
5. Power Up Converter, see [Section 7.3.3.5](#)

#### 7.3.3.1 Power Up REGN LDO

The REGN LDO supplies internal bias circuits as well as the HSFET and LSFET gate drive. It also provides the bias rail to TS external resistors. The pull-up rail of STAT can be connected to REGN as well. The REGN LDO is enabled when all the below conditions are valid:

- V<sub>VBUS</sub> > V<sub>VBUS\_UVLOZ</sub>
- In buck mode, V<sub>VBUS</sub> > V<sub>BAT</sub> + V<sub>SLEEPZ</sub>
- In boost mode, V<sub>VBUS</sub> < V<sub>BAT</sub> + V<sub>SLEEPZ</sub>
- After 220-ms delay is completed

During high impedance mode when EN\_HIZ bit is 1, REGN LDO turns off. The battery powers up the system.

#### 7.3.3.2 Poor Source Qualification

After the REGN LDO powers up, the device starts to check current capability of the input source. The first step is poor source detection.

- V<sub>BUS</sub> voltage above V<sub>POORSRC</sub> when pulling I<sub>BADSR</sub>C (typical 30 mA)

With I<sup>2</sup>C, once the input source passes poor source detection, the status register bit V<sub>BUS\_GD</sub> is set to 1 and the INT pin is pulsed to signal to the host.

If the device fails the poor source detection, it repeats poor source qualification every 2 seconds.

### 7.3.3.3 Input Source Type Detection (IINDPM Threshold)

After poor source detection, the device runs input source detection through the PSEL pin. The PSEL pin sets input current limit 0.5 A (HIGH) or 2.4 A (LOW). After input source type detection is completed, the PMID\_GOOD pin is asserted to HIGH and the PG\_STAT bit goes to 1.

With I<sup>2</sup>C, after input source type detection is completed, an  $\overline{\text{INT}}$  pulse is asserted to the host. In addition, the following register bits are updated:

1. Input Current Limit (IINDPM) register is updated from detection result
2. VBUS\_STAT bit is updated to indicate USB or other input source
3. PG\_STAT bit is updated to indicate good adapter plugs in

The host can overwrite the IINDPM register to change the input current limit if needed.

#### 7.3.3.3.1 PSEL Pins Sets Input Current Limit

The device with the PSEL pin directly takes the USB PHY device output to decide whether the input is a USB host or charging port. When the device operates in host-control mode, the host needs the INDET\_EN bit set to 1 to update the IINDPM register. When the device is in default mode, the PSEL value updates IINDPM in real time.

**Table 7-1. Input Current Limit Setting from PSEL**

| INPUT DETECTION | PSEL PIN | INPUT CURRENT LIMIT (ILIM) | VBUS_STAT |
|-----------------|----------|----------------------------|-----------|
| USB SDP         | HIGH     | 500 mA                     | 001       |
| Adapter         | LOW      | 2.4 A                      | 011       |

### 7.3.3.4 Input Voltage Limit Threshold Setting (VINDPM Threshold)

The device has two modes to set the VINDPM threshold.

- Fixed VINDPM threshold. VINDPM is in default set at 4.5 V (programmable from 3.9 V to 5.4 V) .
- VINDPM threshold tracks the battery voltage to optimize the converter headroom between input and output. When it is enabled in REG07[1:0], the actual input voltage limit is the higher of the VINDPM setting in register and  $V_{\text{BAT}} + \text{offset voltage in VINDPM\_BAT\_TRACK}[1:0]$  .

### 7.3.3.5 Power Up Converter in Buck Mode

After the input current limit is set, the converter is enabled and the HSFET and LSFET start switching. The system voltage is powered from the converter instead of the battery. If battery charging is disabled, the BATFET turns off. Otherwise, the BATFET stays on to charge the battery.

The device provides soft start when the system rail is ramping up. When the system rail is below  $V_{\text{BAT\_SHORT}}$ , the input current is limited to the lower of 200 mA or IINDPM register setting. The system load should be appropriately planned not to exceed the 200-mA IINDPM limit. After the system rises above  $V_{\text{BAT\_SHORTZ}}$ , the device input current limit is the value set by the IINDPM register.

As a battery charger, the device deploys a highly efficient 1.5-MHz step-down switching regulator. The fixed frequency oscillator keeps tight control of the switching frequency under all conditions of input voltage, battery voltage, charge current, and temperature simplifying output filter design.

The converter supports PFM operation by default for fast transient response during system voltage regulation and better light load efficiency. The PFM\_DIS bit disables PFM operation if system voltage is not in regulation.

### 7.3.3.6 HIZ Mode with Adapter Present

By setting the EN\_HIZ bit to 1 with adapter, the device enters a high impedance state (HIZ). In HIZ mode, the system is powered from the battery even with good adapter present. The device is in the low input quiescent current state with Q1 RBFET, REGN LDO, and the bias circuits off.

### 7.3.4 Boost Mode Operation From Battery

The device supports boost converter operation to deliver power from the battery to other portable devices through a USB port. The output voltage is regulated at 5 V (programmable 4.6/4.75/5.0/5.15 V) and output current is up to 1 A. The user needs to have at least 350 mV between  $V_{BAT}$  and Boost mode regulation voltage ( $V_{BST}$ ) to power up Boost mode reliably. For example, the BOOSTV[1:0] setting is recommended to be 4.75 V or higher if the battery voltage is 4.4 V.

Boost operation is enabled if the conditions below are valid:

1. Register setting: BATFET\_DIS = 0, CHG\_CONFIGN = 0 and BST\_CONFIG = 1
2. BAT above  $V_{BST\_BAT}$  set by MIN\_VBAT\_SEL bit,
3. VBUS less than  $V_{BAT} + V_{SLEEP}$  (in sleep mode) before converter starts.
4. Voltage at TS (thermistor) pin, as a percentage of  $V_{REGN}$ , is within acceptable range ( $V_{BHOT\_RISE\%} < V_{TS\%} < V_{BCOLD\_FALL\%}$ )

During Boost mode, the status register VBUS\_STAT bits are set to 111.

The converter supports PFM operation at light load in Boost mode. The PFM\_DIS bit can be used to disable PFM operation in boost configuration.

The BQ25619/618 keeps the Q1 FET off during Boost mode. During adapter plug-in or removal, the charger automatically transitions between charging mode and Boost mode by setting the BST\_CONFIG bit and CHG\_CONFIG bit both to 1. When the adapter plugs in and the conditions to start a new charge cycle are valid, the device is in charging mode. If the adapter is removed and the boost enable conditions are valid, the device transits to Boost mode to power the accessories connected to PMID automatically.

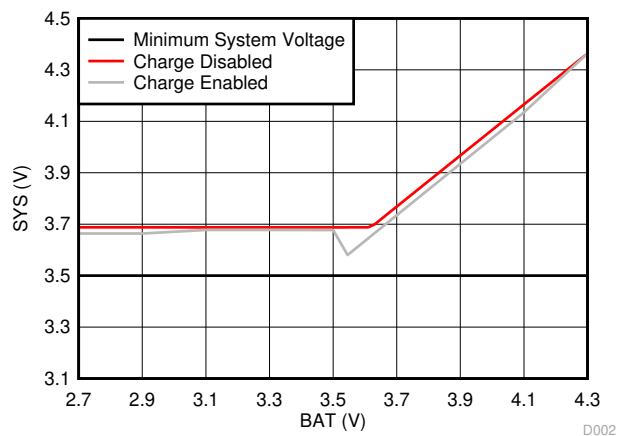
### 7.3.5 Power Path Management

The device accommodates a wide range of input sources such as USB, wall adapter, or car charger. The device provides automatic power path selection to supply the system (SYS) from the input source (VBUS), battery (BAT), or both.

#### 7.3.5.1 Narrow VDC Architecture

When the battery is below the minimum system voltage setting, the BATFET operates in linear mode (LDO mode), and the system is typically 180 mV above the minimum system voltage setting. As the battery voltage rises above the minimum system voltage, the BATFET is fully on and the voltage difference between the system and battery is the  $V_{DS}$  of the BATFET.

When battery charging is disabled and above the minimum system voltage setting or charging is terminated, the system is always regulated at typically 50 mV above the battery voltage. The status register VSYS\_STAT bit goes to 1 when the system is in minimum system voltage regulation.



**Figure 7-1. System Voltage vs Battery Voltage**

### 7.3.5.2 Dynamic Power Management

To meet the maximum current limit in the USB specification and avoid overloading the adapter, the device features Dynamic Power Management (DPM), which continuously monitors the input current and input voltage. When input source is overloaded, either the current exceeds the input current limit (IINDPM) or the voltage falls below the input voltage limit (VINDPM). The device then reduces the charge current until the input current falls below the input current limit or the input voltage rises above the input voltage limit.

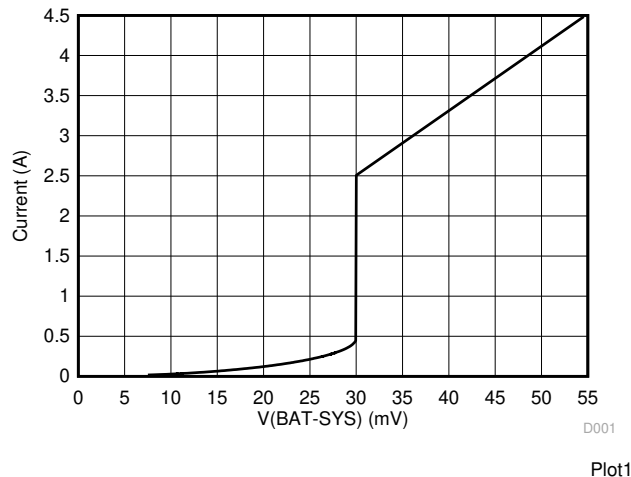
When the charge current is reduced to zero, but the input source is still overloaded, the system voltage starts to drop. Once the system voltage falls below the battery voltage, the device automatically enters the supplement mode where the BATFET turns on and the battery starts discharging so that the system is supported from both the input source and battery.

During DPM mode, the status register bits VINDPM\_STAT or IINDPM\_STAT go to 1.

### 7.3.5.3 Supplement Mode

When the system voltage falls below the battery voltage, the BATFET turns on and the BATFET gate is regulated so that the minimum BATFET  $V_{DS}$  stays at 30 mV when the current is low. This prevents oscillation from entering and exiting the supplement mode.

As the discharge current increases, the BATFET gate is regulated with a higher voltage to reduce  $R_{DS(on)}$  until the BATFET is in full conduction. At this point onwards, the BATFET  $V_{DS}$  linearly increases with discharge current. [Figure 7-2](#) shows the V-I curve of the BATFET gate regulation operation. The BATFET turns off to exit supplement mode when the battery is below battery depletion threshold.



**Figure 7-2. BATFET V-I Curve**

### 7.3.6 Battery Charging Management

The device charges a 1-cell Li-ion battery with up to 1.5-A charge current for a high capacity tablet battery. The 19.5-m $\Omega$  BATFET improves charging efficiency and minimizes the voltage drop during discharging.

#### 7.3.6.1 Autonomous Charging Cycle

When battery charging is enabled (CHG\_CONFIG bit = 1 and  $\overline{CE}$  pin is LOW), the device autonomously completes a charging cycle without host involvement. The device default charging parameters are listed in [Table 7-2](#). The host configures the power path and charging parameters by writing to the corresponding registers through I<sup>2</sup>C.

**Table 7-2. Charging Parameter Default Settings**

| DEFAULT MODE     | BQ25619/618 |
|------------------|-------------|
| Charging voltage | 4.20 V      |
| Charging current | 340 mA      |

**Table 7-2. Charging Parameter Default Settings  
(continued)**

| DEFAULT MODE        | BQ25619/618 |
|---------------------|-------------|
| Pre-charge current  | 40 mA       |
| Termination current | 60 mA       |
| Temperature profile | JEITA       |
| Safety timer        | 10 hours    |

A new charge cycle starts when the following conditions are valid:

- Converter starts
- Battery charging is enabled (CHG\_CONFIG bit = 1 and I<sub>CHG</sub> register is not 0 mA and  $\overline{CE}$  is low)
- No thermistor fault on TS. (TS pin can be ignored by setting TS\_IGNORE bit to 1)
- No safety timer fault
- BATFET is not forced to turn off (BATFET\_DIS bit = 0)

The device automatically terminates the charging cycle when the charging current is below the termination threshold, the battery voltage is above the recharge threshold, and the device is not in DPM mode or thermal regulation. When a fully charged battery is discharged below recharge threshold (selectable through VRECHG bit), the device automatically starts a new charging cycle. After the charge is done, a toggle of the  $\overline{CE}$  pin or CHG\_CONFIG bit initiates a new charging cycle. Adapter removal and replug will also restart a charging cycle.

The STAT output indicates charging status: charging (LOW), charging complete or charge disable (HIGH), or charging fault (blinking). The status register (CHRG\_STAT) indicates the different charging phases: 00-charging disable, 01-precharge, 10-fast charge (CC) and constant voltage (CV), 11-charging done. Once a charging cycle is completed, an  $\overline{INT}$  pulse is asserted to notify the host.

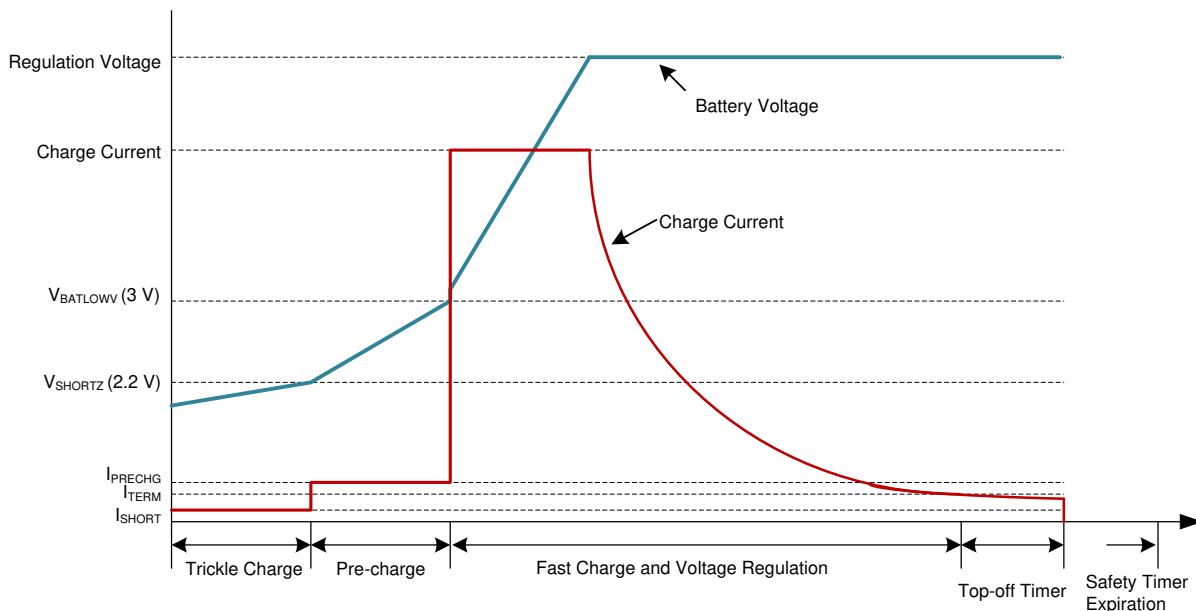
### 7.3.6.2 Battery Charging Profile

The device charges the battery in five phases: battery short, preconditioning, constant current, constant voltage, and top-off trickle charging (optional). At the beginning of a charging cycle, the device checks the battery voltage and regulates current and voltage accordingly.

Resistance between charger output and battery cell terminal such as board routing, connector, MOSFETs, and sense resistor can force the charging process to move from constant current to constant voltage too early and increase charge time. To speed up the charging cycle, the device provides the BATSNS pin to extend the constant current charge time to deliver maximum power to battery. The BATSNS pin is connected directly to the battery cell terminal to remotely sense battery cell voltage. BATSNS is by default enabled and can be disabled through the BATSNS\_DIS bit. If BATSNS is connected to GND or left floating, the charger regulates the BAT pin instead.

**Table 7-3. Charging Current Setting**

| V <sub>BAT</sub> | CHARGING CURRENT       | DEFAULT SETTING | CHRG_STAT |
|------------------|------------------------|-----------------|-----------|
| < 2.2 V          | I <sub>BAT_SHORT</sub> | 25 mA           | 01        |
| 2.2 V to 3 V     | I <sub>PRECHG</sub>    | 40 mA           | 01        |
| > 3 V            | I <sub>CHG</sub>       | 340 mA          | 10        |



**Figure 7-3. Battery Charging Profile**

### 7.3.6.3 Charging Termination

The device terminates a charge cycle when the battery voltage is above the recharge threshold, and the current is below termination current. After the charging cycle has completed, the BATFET turns off. STAT is asserted HIGH to indicate charging is done. The converter keeps running to power the system, and BATFET can turn on again to engage [Section 7.3.5.3](#).

If the device is in IINDPM/VINDPM regulation, or thermal regulation, the actual charging current will be less than the termination value. In this case, termination is temporarily disabled.

When termination occurs, the STAT pin goes HIGH. The status register CHRG\_STAT is set to 11, and an  $\overline{\text{INT}}$  pulse is asserted to the host. Termination can be disabled by writing 0 to the EN\_TERM bit prior to charge termination.

Termination current is set in REG03[3:0]. For a small capacity battery, the termination current can be set as low as 20 mA for full charge. Due to the termination current accuracy, the actual termination current may be higher than the termination target. In order to compensate for termination accuracy, a programmable top-off timer can be applied after termination is detected. The top-off timer will follow safety timer constraints, such that if the safety timer is suspended, so will the top-off timer. Similarly, if the safety timer is doubled, so will the termination top-off timer. The TOPOFF\_ACTIVE bit reports whether the top-off timer is active or not. The host can read CHRG\_STAT and TOPOFF\_ACTIVE to find out the termination status. The STAT pin stays HIGH during a top-off timer counting cycle.

Top-off timer settings are read in once termination is detected by the charger. Programming a top-off timer value (01, 10, 11) after termination has no effect unless a recharge cycle is initiated. The top-off timer immediately stops if it is disabled (00). An  $\overline{\text{INT}}$  is asserted to the host when entering a top-off timer segment as well as when the top-off timer expires.

### 7.3.6.4 Thermistor Qualification

The device provides a single thermistor input for battery temperature monitoring.

### 7.3.6.4.1 JEITA Guideline Compliance During Charging Mode

To improve the safety of charging Li-ion batteries, the JEITA guideline was released on April 20, 2007. The guideline emphasized the importance of avoiding a high charge current and high charge voltage at certain low and high temperature ranges.

To initiate a charge cycle, the voltage on TS pin, as a percentage of  $V_{REGN}$ , must be within the  $V_{T1\_FALL\%}$  to  $V_{T5\_RISE\%}$  thresholds. If the TS voltage percentage exceeds the T1-T5 range, the controller suspends charging, a TS fault is reported and waits until the battery temperature is within the T1-T5 range.

At cool temperature (T1-T2), the charge current is reduced to a programmable fast charge current (0%, 20% default, 50%, 100% of  $I_{CHG}$ , by JEITA\_ISET). At warm temperature (T3-T5), the charge voltage is reduced to 4.1 V or kept at  $V_{REG}$  (JEITA\_VSET), and the charge current can be reduced to a programmable level (0%, 20%, 50%, 100% default). Battery termination is disabled in T3-T5. The charger provides more flexible settings on a T2 and T3 threshold as well to program the temperature profile beyond JEITA. When T1 is set to 0°C and T5 is set to 60°C, T2 can be programmed to 5.5°C/10°C (default)/15°C/20°C, and T3 can be programmed to 40°C/45.5°C (default)/50.5°C/54.5°C.

When the charger does not need to monitor the NTC, the host sets the TS\_IGNORE bit to 1 to ignore the TS pin condition during charging and Boost mode. If the TS\_IGNORE bit is set to 1, the TS pin is ignored and the charger ignores the TS pin input. In this case, the NTC\_FAULT bits are 000 to report normal TS status.

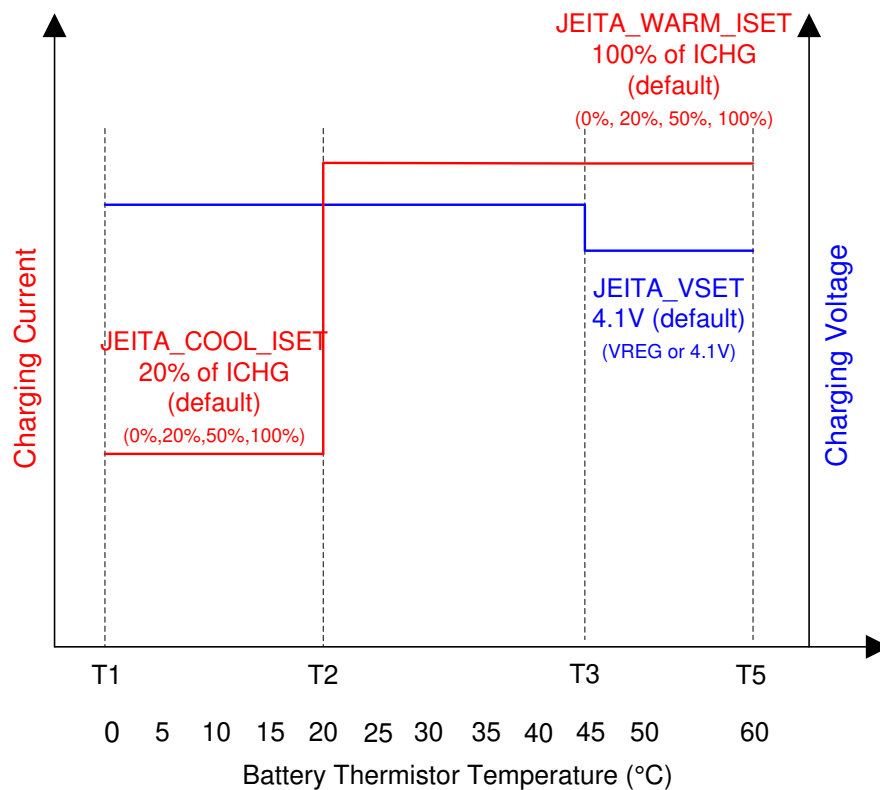


Figure 7-4. JEITA Profile

Equation 1 through Equation 2 describe how to calculate resistor divider values on the TS pin.



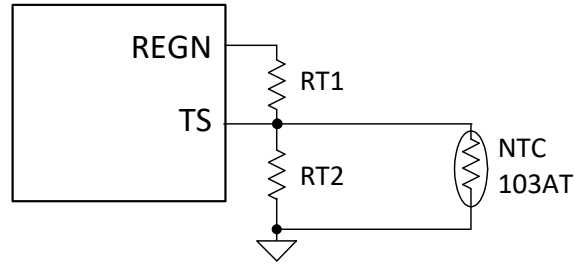


Figure 7-5. TS Pin Resistor Network

$$RT1 = \frac{\frac{1}{V_{T1\%}} - 1}{\frac{1}{R_{T2}} + \frac{1}{R_{NTC,T1}}} \quad (1)$$

$$RT2 = \frac{R_{NTC,T1} \times R_{NTC,T5} \times \left( \frac{1}{V_{T5\%}} - \frac{1}{V_{T1\%}} \right)}{R_{NTC,T1} \times \left( \frac{1}{V_{T1\%}} - 1 \right) - R_{NTC,T5} \times \left( \frac{1}{V_{T5\%}} - 1 \right)} \quad (2)$$

In the equations above,  $R_{NTC, T1}$  is the NTC thermistor resistance value at temperature T1 and  $R_{NTC, T5}$  is the NTC thermistor resistance value at temperature T5. Selecting a 0°C to 60°C range for a Li-ion or Li-polymer battery then:

- $R_{NTC, T1} = 27.28 \text{ k}\Omega$  (0°C)
- $R_{NTC, T5} = 3.02 \text{ k}\Omega$  (60°C)
- $RT1 = 5.3 \text{ k}\Omega$
- $RT2 = 31.14 \text{ k}\Omega$

#### 7.3.6.4.2 Boost Mode Thermistor Monitor During Battery Discharge Mode

For battery protection during Boost mode, the device monitors battery temperature to be within the  $V_{BCOLD}$  and  $V_{BHOT}$  thresholds. When  $RT1$  is 5.3 k $\Omega$  and  $RT2$  is 31.14 k $\Omega$ ,  $T_{BCOLD}$  default is -19.5°C and  $T_{BHOT}$  default is 64°C. When the temperature is outside of the temperature thresholds, Boost mode is suspended. In addition, the  $V_{BUS\_STAT}$  bits are set to 000 and  $NTC\_FAULT$  is reported. Once the temperature returns within the thresholds, Boost mode is recovered and  $NTC\_FAULT$  is cleared.

#### 7.3.6.5 Charging Safety Timer

The device has a built-in safety timer to prevent an extended charging cycle due to abnormal battery conditions. The safety timer is 2 hours when the battery is below the  $V_{BATLOWV}$  threshold and 10 hours (10/20 hours in  $REG05[2]$ ) when the battery is higher than the  $V_{BATLOWV}$  threshold. When the safety timer expires, the  $STAT$  pin is blinking at 1 Hz to report a safety timer expiration fault.

The user can program the fast charge safety timer through I<sup>2</sup>C ( $CHG\_TIMER$  bit  $REG05[2]$ ). When the safety timer expires, the fault register  $CHRG\_FAULT$  bits ( $REG09[5:4]$ ) are set to 11 and an  $\overline{INT}$  is asserted to the host. The safety timer (both fast charge and precharge) can be disabled through I<sup>2</sup>C by setting the  $EN\_TIMER$  bit.

During IINDP/VINDP regulation, thermal regulation, or JEITA cool/warm when fast charge current is reduced, the safety timer counts at a half clock rate, because the actual charge current is likely below the setting. For example, if the charger is in input current regulation ( $IINDP\_STAT = 1$ ) throughout the whole charging cycle, and the safety time is set to 10 hours, the safety timer will expire in 20 hours. This half clock rate feature can be disabled by writing 0 to the  $TMR2X\_EN$  bit.



During faults of BAT\_FAULT, NTC\_FAULT that lead to charging suspend, the safety timer is suspended as well. Once the fault goes away, the timer resumes. If the user stops the current charging cycle, and starts it again, the timer gets reset (toggle of  $\overline{CE}$  pin or CHG\_CONFIG bit).

### 7.3.7 Ship Mode and $\overline{QON}$ Pin

#### 7.3.7.1 BATFET Disable (Enter Ship Mode)

To extend battery life and minimize power when the system is powered off during system idle, shipping, or storage, the device turns off BATFET so that the system voltage is floating to minimize the battery leakage current. When the host sets the BATFET\_DIS bit, the charger can turn off the BATFET immediately or delay by  $t_{BATFET\_DLY}$  as configured by the BATFET\_DLY bit. To set the device into ship mode with the adapter present, the host has to first set BATFET\_RST\_VBUS to 1 and then BATFET\_DIS to 1. The charger will turn off the BATFET (no charging, no supplement) while the adapter is still attached. When the adapter is removed, the charger will enter ship mode.

#### 7.3.7.2 BATFET Enable (Exit Ship Mode)

When the BATFET is disabled (in ship mode) as indicated by setting BATFET\_DIS, one of the following events can enable the BATFET to restore system power:

1. Plug in adapter
2. Clear BATFET\_DIS bit
3. Set REG\_RST bit to reset all registers including BATFET\_DIS bit to default (0)
4. A logic high to low transition on  $\overline{QON}$  pin with  $t_{SHIPMODE}$  deglitch time to enable BATFET to exit ship mode. EN\_HIZ bit is set to 1 (regardless of adapter present or not). Host has to set EN\_HIZ bit to 0 before boost mode enable. Once adapter plugs in, EN\_HIZ will be cleared.

#### 7.3.7.3 BATFET Full System Reset

The BATFET functions as a load switch between the battery and system when an input source is not plugged in. When BATFET\_RST\_EN = 1 and BATFET\_DIS = 0, the BATFET full system reset function is enabled. By changing the state of BATFET from on to off, systems connected to SYS can be effectively forced to have a power-on-reset. After the reset is complete, the device is in the POR state, and all registers are in POR default settings. The  $\overline{QON}$  pin supports a push-button interface to reset system power without the host by changing the state of BATFET. Internally, it is pulled up to the  $V_{QON}$  voltage through a 200-k $\Omega$  resistor.

When the  $\overline{QON}$  pin is driven to logic low for  $t_{QON\_RST}$ , the BATFET reset process starts. The BATFET is turned off for  $t_{BATFET\_RST}$  and then it is re-enabled to reset system power. This function can be disabled by setting the BATFET\_RST\_EN bit to 0.

The BATFET full system reset functions either with or without an adapter present. If BATFET\_RST\_WVBUS = 1, the system reset function starts after  $t_{QON\_RST}$  when the  $\overline{QON}$  pin is pushed to LOW. Once the reset process starts, the device first goes into HIZ mode to turn off the converter, and then power cycles BATFET. If BATFET\_RST\_WVBUS = 0, the system reset function does not start until  $t_{QON\_RST}$  after the  $\overline{QON}$  pin is pushed to LOW and the adapter is removed.

After the BATFET full system reset is complete, the device powers up again if EN\_HIZ is not set to 1 before the system reset.

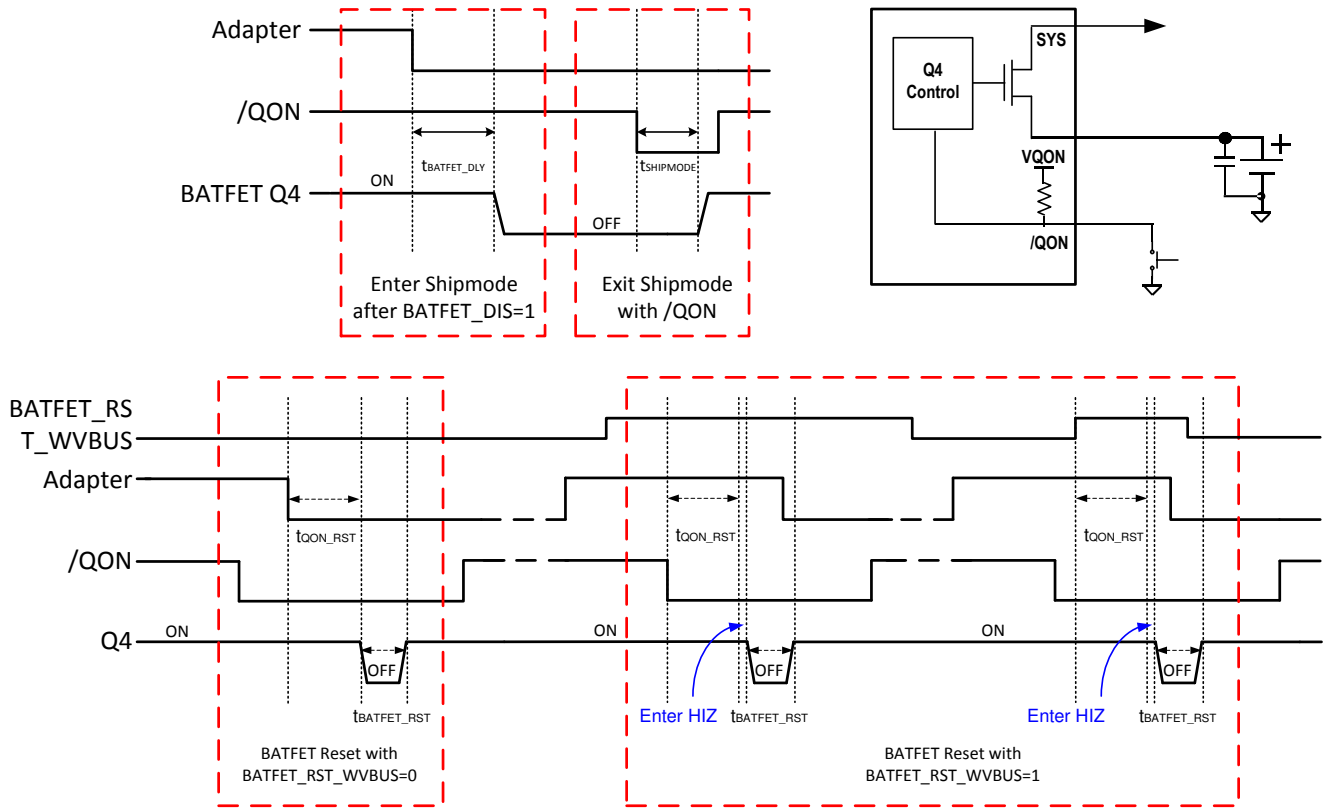


Figure 7-6. QON Timing

### 7.3.8 Status Outputs (STAT, $\overline{INT}$ , PMID\_GOOD)

#### 7.3.8.1 Power Good Indicator (PG\_STAT Bit)

The PG\_STAT bit goes to 1 to indicate a good input source when:

- $V_{VBUS}$  above  $V_{VBUS\_UVLO}$
- $V_{VBUS}$  above battery (not in sleep)
- $V_{VBUS}$  below  $V_{ACOV}$  threshold
- $V_{VBUS}$  above  $V_{POORSRC}$  (typical 3.8 V) when  $I_{BADSRC}$  (typical 30 mA) current is applied (not a poor source)
- Completed [Section 7.3.3.3](#)

#### 7.3.8.2 Charging Status Indicator (STAT)

The device indicates the charging state on the open drain STAT pin. The STAT pin can drive an LED.

Table 7-4. STAT Pin State

| CHARGING STATE  | STAT INDICATOR   |
|---|------------------|
| Charging in progress (including recharge)   | LOW              |
| Charging termination (top off timer may be running)                                     | HIGH             |
| Sleep mode, charge disable, Boost mode  | HIGH             |
| Charge suspend (input overvoltage, TS fault, safety timer fault, or system overvoltage) | Blinking at 1 Hz |

#### 7.3.8.3 Interrupt to Host ( $\overline{INT}$ )

In some applications, the host does not always monitor charger operation. The  $\overline{INT}$  pulse notifies the host on device operation. The following events generate a 256- $\mu$ s  $\overline{INT}$  pulse.

- Good input source detected:
  - $V_{VBUS}$  above battery (not in sleep)
  - $V_{VBUS}$  below  $V_{ACOV}$  threshold

- $V_{VBUS}$  above  $V_{POORSRC}$  (typical 3.8 V) when  $I_{BADSRC}$  (typical 30 mA) current is applied (not a poor source)
- Input adapter removed
- USB/adapter source identified during [Section 7.3.3.3](#).
- Charge complete
- Any FAULT event in REG09
- VINDPM / IINDPM event detected (REG0A[1:0], maskable)
- Top-off timer starts and expires

REG09[7:0] and REG0A[6:4] report charger operation faults and status change to the host. When a fault/status change occurs, the charger sends out an  $\overline{INT}$  pulse and keeps the state in REG09[7:0]/REG0A[6:4] until the host reads the registers. Before the host reads REG09[7:0]/REG0A[6:4] and all the ones are cleared, the charger does not send any  $\overline{INT}$  upon new fault/status change. To read the current status, the host has to read REG09/REG0A two times consecutively. The first read reports the pre-existing register status and the second read reports the current register status.

#### 7.3.8.4 PMID Voltage Indicator (PMID\_GOOD)

In the BQ25619/618, the accessory devices can be connected to the charger PMID pin to get power either from the adapter through the Q1 direct path or from battery Boost mode. An optional external PMOS FET can be placed between the charger PMID pin and accessory input to disconnect the power path during overcurrent and overvoltage conditions. PMID\_GOOD is used to drive an external PMOS FET through an inverter. PMID\_GOOD HIGH turns on an inverter to pull the PMOS FET gate low to turn on the PMOS FET, and PMID\_GOOD LOW turns off the PMOS FET.

Upon adapter plug-in, PMID\_GOOD goes from LOW to HIGH when VBUS rises above the battery but below  $V_{ACOV}$ , and passes poor source detection. During the operation, PMID\_GOOD goes from HIGH to LOW if Q1 current exceeds 115% of the IINDPM threshold, ( $I_{BLK\_OCP}$ ), or adapter voltage rises above 5.8 V ( $V_{BST\_OVP}$ ).

The high-voltage adapter over  $V_{BST\_OVP}$  keeps charging the battery if all conditions are valid. The external PMOS FET stays off to protect the accessory from an overvoltage fault.

When the adapter is removed, PMID\_GOOD goes LOW before battery Boost mode starts.

In battery Boost mode, the device regulates PMID voltage between 4.6 V to 5.15 V as a stable power supply to the accessory devices. PMID\_GOOD goes from LOW to HIGH when PMID voltage rises above 3.8 V ( $V_{POORSRC}$ ). Similar to the adapter present scenario, the PMID valid voltage range is between  $V_{POORSRC}$  and  $V_{BST\_OVP}$ . Once PMID voltage is out of this range, PMID\_GOOD goes LOW to disconnect the accessory device from PMID. During Boost mode, all of the conditions to exit Boost mode will drive PMID\_GOOD from HIGH to LOW, including Boost mode disable in register, ACOV, TS fault, battery depleted ( $V_{BAT\_DPL}$ ), BATFET overcurrent, ( $I_{SYS\_OCP\_Q4}$ ), etc.

### 7.3.9 Protections

#### 7.3.9.1 Voltage and Current Monitoring in Buck Mode

##### 7.3.9.1.1 Input Overvoltage Protection (ACOV)

The input voltage is sensed via the VAC pin. The default OVP threshold is 14.2 V, and can be programmed at 5.7 V/6.4 V/11 V/14.2 V via OVP[1:0] register bits. ACOV event immediately stops converter switching whether in buck or Boost mode. The device automatically resumes normal operation once the input voltage drops back below the OVP threshold. During ACOV, REGN LDO is on, and the device does not enter HIZ mode.

During ACOV, the fault register CHRG\_FAULT bits are set to 01. An  $\overline{INT}$  pulse is asserted to the host.

##### 7.3.9.1.2 System Overvoltage Protection (SYSOVP)

The charger device clamps the system voltage during a load transient so that the components connected to the system are not damaged due to high voltage. The  $V_{SYS\_OVP}$  threshold is about 300 mV above battery regulation voltage when battery charging is terminated. Upon SYSOVP, the converter stops switching immediately to clamp the overshoot. The charger pulls 30-mA  $I_{SYS\_LOAD}$  discharge current to bring down the system voltage.

### 7.3.9.2 Voltage and Current Monitoring in Boost Mode

#### 7.3.9.2.1 Boost Mode Overvoltage Protection

When PMID voltage rises above the regulation target and exceeds  $V_{BST\_OVP}$ , the device stops switching immediately and the device exits Boost mode and PMID\_GOOD is pulled low as well. The BST\_CONFIG bit is set to 0. During Boost mode overvoltage, the fault register bit BOOST\_FAULT is set to 1 to indicate a fault in boost operation. An  $\overline{INT}$  is asserted to the host.

#### 7.3.9.2.2 PMID Overcurrent Protection

The BQ25619/618 closely monitors the battery discharge current through BATFET (Q4) to ensure safe Boost mode operation. During an overcurrent condition when boost input current exceeds  $I_{SYS\_OCP\_Q4}$ , the device latches off in 100  $\mu$ s. When an overcurrent condition is detected, the fault register bit BOOST\_FAULT is set high to indicate a fault in boost operation. An  $\overline{INT}$  is asserted to the host.

### 7.3.9.3 Thermal Regulation and Thermal Shutdown

#### 7.3.9.3.1 Thermal Protection in Buck Mode

Besides the battery temperature monitor on the TS pin, the device monitors the internal junction temperature  $T_J$  to avoid overheating the chip and limits the IC junction temperature in buck mode. When the internal junction temperature exceeds the thermal regulation limit (110°C), the device lowers down the charge current. During thermal regulation, the actual charging current is usually below the programmed battery charging current. Therefore, termination is disabled, the safety timer runs at half the clock rate, and the status register THERM\_STAT bit goes high.

Additionally, the device has thermal shutdown to turn off the converter and the BATFET when the IC surface temperature exceeds  $T_{SHUT}$  150°C. The BATFET and converter are enabled to recover when IC temperature is 130°C. The fault register CHRГ\_FAULT is set to 10 during thermal shutdown and an  $\overline{INT}$  is asserted to the host.

#### 7.3.9.3.2 Thermal Protection in Boost Mode

Besides the battery temperature monitor on the TS pin, the device monitors the internal junction temperature to provide thermal shutdown during Boost mode. When the IC junction temperature exceeds  $T_{SHUT}$  150°C, Boost mode is disabled by setting the BST\_CONFIG bit low. When the IC junction temperature is below 145°C, the host can re-enable Boost mode.

### 7.3.9.4 Battery Protection

#### 7.3.9.4.1 Battery Overvoltage Protection (BATOVP)

The battery overvoltage limit is clamped at 4% above battery regulation voltage. When battery overvoltage occurs, the charger device immediately stops switching. The fault register BAT\_FAULT bit goes high and an  $\overline{INT}$  is asserted to the host.

#### 7.3.9.4.2 Battery Overdischarge Protection

When the battery is discharged below  $V_{BAT\_DPL\_FALL}$ , the BATFET latches off to protect the battery from overdischarge. To recover from overdischarge latch-off, an input source plug-in is required at VAC/VBUS.

#### 7.3.9.4.3 System Overcurrent Protection

$I_{SYS\_OCP\_Q4}$  sets the battery discharge current limit. Once  $I_{BAT} > I_{SYS\_OCP\_Q4}$ , the charger latches off Q4 and puts the device into Ship mode. All methods to exit Ship mode are valid to bring the part out of Q4 latch-off.

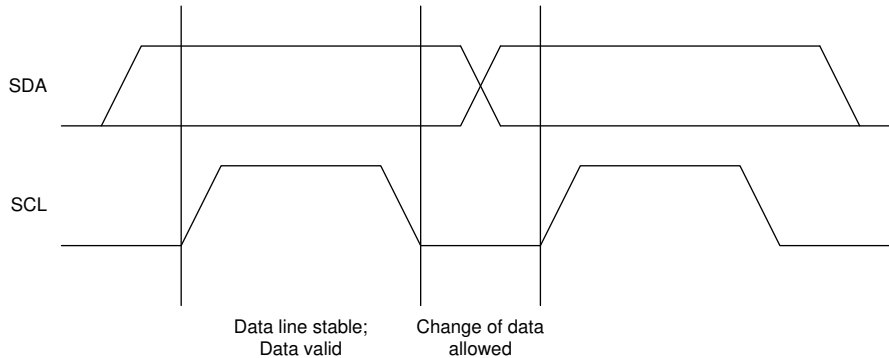
### 7.3.10 Serial Interface

The device uses an I<sup>2</sup>C compatible interface for flexible charging parameter programming and instantaneous device status reporting. I<sup>2</sup>C™ is a bi-directional 2-wire serial interface developed by Philips Semiconductor (now NXP Semiconductors). Only two bus lines are required: a serial data line (SDA) and a serial clock line (SCL). Devices can be considered as masters or slaves when performing data transfers. A master is the device which initiates a data transfer on the bus and generates the clock signals to permit that transfer. At that time, any device addressed is considered a slave.

The device operates as a slave device with address 6AH, receiving control inputs from the master device like a microcontroller or a digital signal processor through REG00 to REG0C. A register read beyond REG0C returns 0xFF. The I<sup>2</sup>C interface supports both standard mode (up to 100 kbits), and fast mode (up to 400 kbits), connecting to the positive supply voltage via a current source or pullup resistor. When the bus is free, both lines are HIGH. The SDA and SCL pins are open drain.

**7.3.10.1 Data Validity**

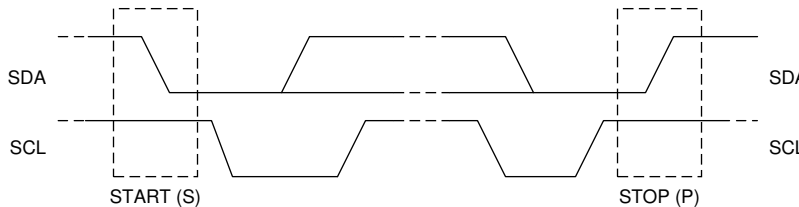
The data on the SDA line must be stable during the HIGH period of the clock. The HIGH or LOW state of the data line can only change when the clock signal on the SCL line is LOW. One clock pulse is generated for each data bit transferred.



**Figure 7-7. Bit Transfer on the I<sup>2</sup>C Bus**

**7.3.10.2 START and STOP Conditions**

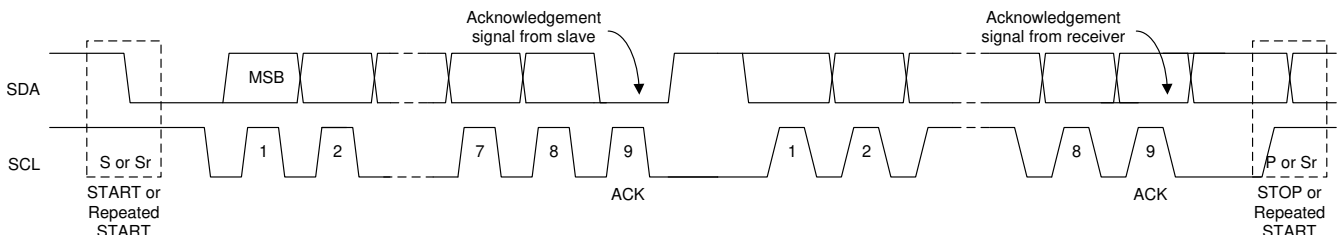
All transactions begin with a START (S) and can be terminated by a STOP (P). A HIGH to LOW transition on the SDA line while SCL is HIGH defines a START condition. A LOW to HIGH transition on the SDA line when the SCL is HIGH defines a STOP condition. START and STOP conditions are always generated by the master. The bus is considered busy after the START condition, and free after the STOP condition.



**Figure 7-8. TS START and STOP conditions**

**7.3.10.3 Byte Format**

Every byte on the SDA line must be 8 bits long. The number of bytes to be transmitted per transfer is unrestricted. Each byte has to be followed by an Acknowledge bit. Data is transferred with the Most Significant Bit (MSB) first. If a slave cannot receive or transmit another complete byte of data until it has performed some other function, it can hold the clock line SCL low to force the master into a wait state (clock stretching). Data transfer then continues when the slave is ready for another byte of data and release the clock line SCL.



**Figure 7-9. Data Transfer on the I<sup>2</sup>C Bus**

### 7.3.10.4 Acknowledge (ACK) and Not Acknowledge (NACK)

The acknowledge takes place after every byte. The acknowledge bit allows the receiver to signal the transmitter that the byte was successfully received and another byte may be sent. All clock pulses, including the acknowledge ninth clock pulse, are generated by the master. The transmitter releases the SDA line during the acknowledge clock pulse so the receiver can pull the SDA line LOW and it remains stable LOW during the HIGH period of this clock pulse.

When SDA remains HIGH during the ninth clock pulse, this is the Not Acknowledge signal. The master can then generate either a STOP to abort the transfer or a repeated START to start a new transfer.

### 7.3.10.5 Slave Address and Data Direction Bit

After the START, a slave address is sent. This address is 7 bits long followed by the eighth bit as a data direction bit (bit R/W). A zero indicates a transmission (WRITE) and a one indicates a request for data (READ).

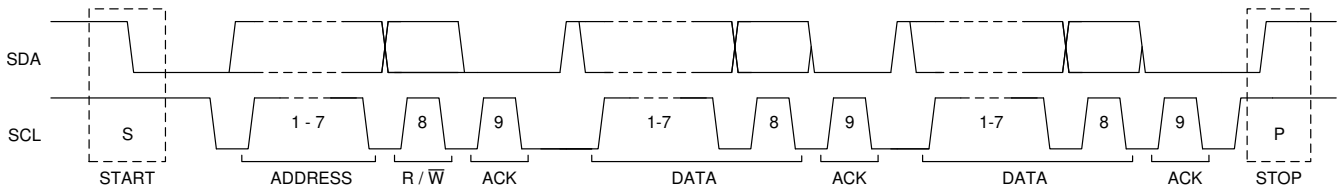


Figure 7-10. Complete Data Transfer

### 7.3.10.6 Single Read and Write

If the register address is not defined, the charger IC sends back NACK and goes back to the idle state.

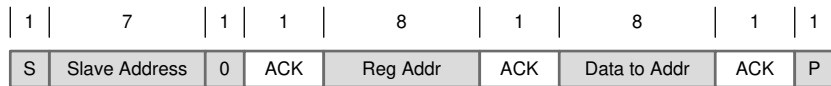


Figure 7-11. Single Write

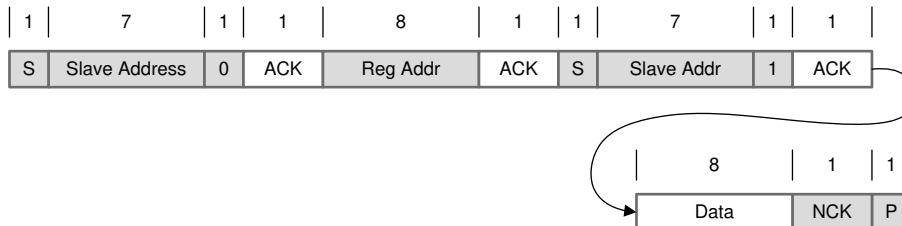


Figure 7-12. Single Read

### 7.3.10.7 Multi-Read and Multi-Write

The charger device supports multi-read and multi-write on REG00 through REG0C.

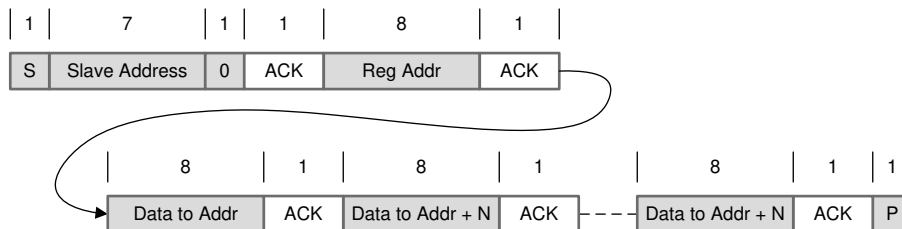


Figure 7-13. Multi-Write

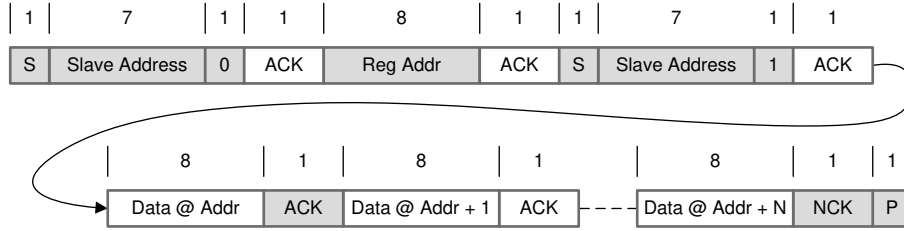


Figure 7-14. Multi-Read

REG09[7:0]/REG0A[6:4] are fault/status change registers. They keep all of the fault/status information from the last read until the host issues a new read. For example, if a Charge Safety Timer Expiration fault occurs but recovers later, the fault register REG09 reports the fault when it is read the first time, but returns to normal when it is read the second time. In order to get the fault information at present, the host has to read REG09/REG0A for the second time.

## 7.4 Device Functional Modes

### 7.4.1 Host Mode and Default Mode

The device is a host controlled charger, but it can operate in default mode without host management. In default mode, the device can be used as an autonomous charger with no host or while the host is in sleep mode. When the charger is in default mode, the WATCHDOG\_FAULT bit is HIGH. When the charger is in host mode, the WATCHDOG\_FAULT bit is LOW.

After power-on-reset, the device starts in default mode with watchdog timer expired, or default mode. All registers are in the default settings.

In default mode, the device keeps charging the battery with the 10-hour fast charging safety timer. At the end of the 10-hour, charging is stopped and the buck converter continues to operate to supply system load. Any write command to the device transitions the charger from default mode to host mode. All device parameters can be programmed by the host. To keep the device in host mode, the host has to reset the watchdog timer by writing a 1 to the WD\_RST bit before the watchdog timer expires (WATCHDOG\_FAULT bit is set), or disable the watchdog timer by setting the WATCHDOG bits = 00.

All device parameters can be programmed by the host. To keep the device in host mode, the host has to reset the watchdog timer by writing a 1 to the WD\_RST bit before the watchdog timer expires (WATCHDOG\_FAULT bit is set), or disable the watchdog timer by setting the WATCHDOG bits = 00.

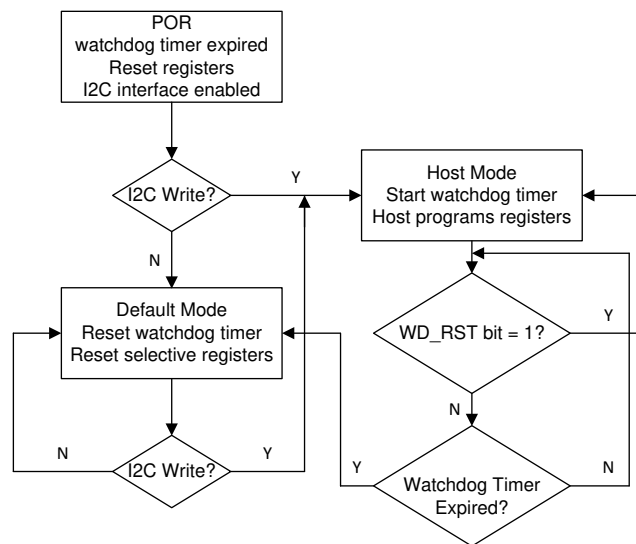


Figure 7-15. Watchdog Timer Flow Chart



## 7.5 Register Maps

I<sup>2</sup>C Slave Address: 6AH

Default I<sup>2</sup>C Slave Address: 0x6A (1101 010B + R/  $\overline{W}$ )

**Table 7-5. I<sup>2</sup>C Registers**

| Address | Access Type | Acronym | Register Name                           | Section            |
|---------|-------------|---------|---|--------------------|
| 00h     | R/W         | REG00   | Input Current Limit                     | <a href="#">Go</a> |
| 01h     | R/W         | REG01   | Charger Control 0                       | <a href="#">Go</a> |
| 02h     | R/W         | REG02   | Charge Current Limit                    | <a href="#">Go</a> |
| 03h     | R/W         | REG03   | Precharge and Termination Current Limit | <a href="#">Go</a> |
| 04h     | R/W         | REG04   | Battery Voltage Limit                   | <a href="#">Go</a> |
| 05h     | R/W         | REG05   | Charger Control 1                       | <a href="#">Go</a> |
| 06h     | R/W         | REG06   | Charger Control 2                       | <a href="#">Go</a> |
| 07h     | R/W         | REG07   | Charger Control 3                       | <a href="#">Go</a> |
| 08h     | R           | REG08   | Charger Status 0                        | <a href="#">Go</a> |
| 09h     | R           | REG09   | Charger Status 1                        | <a href="#">Go</a> |
| 0Ah     | R           | REG0A   | Charger Status 2                        | <a href="#">Go</a> |
| 0Bh     | R           | REG0B   | Part Information                        | <a href="#">Go</a> |
| 0Ch     | R/W         | REG0C   | Charger Control 4                       | <a href="#">Go</a> |

Complex bit access types are encoded to fit into small table cells. [Table 7-6](#) shows the codes that are used for access types in this section.

**Table 7-6. I<sup>2</sup>C Access Type Codes**

| Access Type | Code | Description       |
|-------------|------|-------------------|
| Read Type   |      |                   |
| R           | R    | Read              |
| Write Type  |      |                   |
| W           | W    | Write             |
| Reset Value |      |                   |
| -n          |      | Value after reset |
| -X          |      | Undefined value   |



### 7.5.1 Input Current Limit Register (Address = 00h) [Reset = 17h]

**Figure 7-16. REG00 Register**

| 7   | 6   | 5   | 4   | 3   | 2   | 1   | 0   |
|-----|-----|-----|-----|-----|-----|-----|-----|
| 0   | 0   | 0   | 1   | 0   | 1   | 1   | 1   |
| R/W | R/W | R/W | R/W | R/W | R/W | R/W | R/W |

LEGEND: R/W = Read/Write; R = Read only; -n = value after reset

**Table 7-7. REG00 Field Descriptions**

| Bit | Field      | POR | Type | Reset                     | Description  |
|-----|------------|-----|------|---------------------------|--|
| 7   | EN_HIZ     | 0   | R/W  | by REG_RST<br>by Watchdog | HIZ mode enable in buck mode.<br>0 – Disable (default)<br>1 – Enable   |
| 6   | TS_IGNORE  | 0   | R/W  | by REG_RST                | When charger does not monitor the NTC, host sets this bit to 1 to ignore the TS pin condition during charging and boost mode.<br>0 – Include TS pin into charge and boost mode enable conditions. (default)<br>1 – Ignore TS pin. Always consider TS is good to allow charging and boost mode. NTC_FAULT bits are 000 to report normal status. |
| 5   | BATSNS_DIS | 0   | R/W  | by REG_RST                | Select either BATSNS pin or BAT pin to regulate battery voltage.<br>0 – Enable BATSNS in battery CV regulation. If the device fails BATSNS open/short detection (BATSNS_STAT = 1). Battery voltage is regulated through BAT pin. (default)<br>1 – Disable BATSNS. Use BAT pin in battery CV regulation.  |
| 4   | IINDPM[4]  | 1   | R/W  | by REG_RST                | 1600 mA  |
| 3   | IINDPM[3]  | 0   | R/W  | by REG_RST                | 800 mA   |
| 2   | IINDPM[2]  | 1   | R/W  | by REG_RST                | 400 mA   |
| 1   | IINDPM[1]  | 1   | R/W  | by REG_RST                | 200 mA   |
| 0   | IINDPM[0]  | 1   | R/W  | by REG_RST                | 100 mA   |

Input current limit setting (maximum limit, not typical)  
Offset: 100 mA  
Range: 100 mA (000000) – 3.2 A (11111)  
Default: 2400 mA (10111)  
IINDPM bits are changed automatically after [Section 7.3.3.3](#) is completed  
PSEL HIGH = 500 mA  
PSEL LOW = 2.4 A  
Host can reprogram IINDPM register bits after input source detection is completed.

LEGEND: R/W = Read/Write; R = Read only

## 7.5.2 Charger Control 0 Register (Address = 01h) [Reset = 1Ah]

Figure 7-17. REG01 Register

| 7   | 6   | 5   | 4   | 3   | 2   | 1   | 0   |
|-----|-----|-----|-----|-----|-----|-----|-----|
| 0   | 0   | 0   | 1   | 1   | 0   | 1   | 0   |
| R/W | R/W | R/W | R/W | R/W | R/W | R/W | R/W |

LEGEND: R/W = Read/Write; R = Read only; -n = value after reset

Table 7-8. REG01 Field Descriptions

| Bit | Field        | POR | Type | Reset                     | Description  |
|-----|--------------|-----|------|---------------------------|--|
| 7   | PFM_DIS      | 0   | R/W  | by REG_RST                | PFM disable in both buck and boost mode.<br>0 – PFM enable (default)<br>1 – PFM disable  |
| 6   | WD_RST       | 0   | R/W  | by REG_RST<br>by Watchdog | I <sup>2</sup> C Watchdog timer reset. Back to 0 after watchdog timer reset<br>0 – Normal (default)<br>1 – Reset   |
| 5   | BST_CONFIG   | 0   | R/W  | by REG_RST<br>by Watchdog | Boost mode enable. In charging case application, based on adapter plug-in or removal, the charger will automatically transit between charging mode and boost mode by setting BST_CONFIG bit and CHG_CONFIG bit both to 1.<br>0 – Boost mode disable (default)<br>1 – Boost mode enable |
| 4   | CHG_CONFIG   | 1   | R/W  | by REG_RST<br>by Watchdog | Battery charging buck mode enable. Charging is enabled when $\overline{CE}$ pin is pulled low, CHG_CONFIG bit is 1 and charge current is not zero.<br>0 – Charge Disable<br>1 – Charge Enable (default)  |
| 3   | SYS_MIN[2]   | 1   | R/W  | by REG_RST                | System minimum voltage setting.<br>000 – 2.6 V<br>001 – 2.8 V<br>010 – 3 V<br>011 – 3.2 V<br>100 – 3.4 V<br>101 – 3.5 V (default)<br>110 – 3.6 V<br>111 – 3.7 V  |
| 2   | SYS_MIN[1]   | 0   | R/W  | by REG_RST                |  |
| 1   | SYS_MIN[0]   | 1   | R/W  | by REG_RST                |  |
| 0   | MIN_VBAT_SEL | 0   | R/W  | by REG_RST                | Minimum battery voltage when exiting boost mode. The rising threshold allows the device to start boost mode if other conditions are valid.<br>0 – 2.8 V V <sub>BAT</sub> falling, 3 V rising (default)<br>1 – 2.5 V V <sub>BAT</sub> falling, 2.8 V rising                             |

LEGEND: R/W = Read/Write; R = Read only

### 7.5.3 Charge Current Limit Register (Address = 02h) [Reset = 91h]

**Figure 7-18. REG02 Register**

|     |     |     |     |     |     |     |     |
|-----|-----|-----|-----|-----|-----|-----|-----|
| 7   | 6   | 5   | 4   | 3   | 2   | 1   | 0   |
| 1   | 0   | 0   | 1   | 0   | 0   | 0   | 1   |
| R/W | R/W | R/W | R/W | R/W | R/W | R/W | R/W |

LEGEND: R/W = Read/Write; R = Read only; -n = value after reset

**Table 7-9. REG02 Field Descriptions**

| Bit | Field     | POR | Type | Reset                     | Description  |
|-----|-----------|-----|------|---------------------------|--|
| 7   | Reserved  | 1   | R/W  |                           |  |
| 6   | Q1_FULLON | 0   | R/W  | by REG_RST                | In buck mode, charger will fully turn on Q1 RBFET according to this bit setting when IINDPM is below 700 mA. When IINDPM is over 700 mA, Q1 is always fully on.<br>0 – Partially turn on Q1 for better regulation accuracy when IINDPM is below 700 mA. (default)<br>1 – Fully turn on Q1 for better efficiency when IINDPM is below 700 mA. |
| 5   | ICHG[5]   | 0   | R/W  | by REG_RST<br>by Watchdog | 640 mA   |
| 4   | ICHG[4]   | 1   | R/W  | by REG_RST<br>by Watchdog | 320 mA   |
| 3   | ICHG[3]   | 0   | R/W  | by REG_RST<br>by Watchdog | 160 mA   |
| 2   | ICHG[2]   | 0   | R/W  | by REG_RST<br>by Watchdog | 80 mA  |
| 1   | ICHG[1]   | 0   | R/W  | by REG_RST<br>by Watchdog | 40 mA  |
| 0   | ICHG[0]   | 1   | R/W  | by REG_RST<br>by Watchdog | 20 mA  |

Fast charge current setting  
Default: 340 mA (010001)  
Range: 0 mA (0000001) – 1180 mA (111011), 20 mA/step  
111100: 1290 mA  
111101: 1360 mA  
111110: 1430 mA  
111111: 1500 mA  
ICHG 0 mA disables charge.

LEGEND: R/W = Read/Write; R = Read only

### 7.5.4 Precharge and Termination Current Limit Register (Address = 03h) [Reset = 12h]

Figure 7-19. REG03 Register

| 7   | 6   | 5   | 4   | 3   | 2   | 1   | 0   |
|-----|-----|-----|-----|-----|-----|-----|-----|
| 0   | 0   | 0   | 1   | 0   | 0   | 1   | 0   |
| R/W | R/W | R/W | R/W | R/W | R/W | R/W | R/W |

LEGEND: R/W = Read/Write; R = Read only; -n = value after reset

Table 7-10. REG03 Field Descriptions

| Bit | Field      | POR | Type | Reset                     | Description |
|-----|------------|-----|------|---------------------------|-------------|
| 7   | IPRECHG[3] | 0   | R/W  | by REG_RST<br>by Watchdog | 160 mA      |
| 6   | IPRECHG[2] | 0   | R/W  | by REG_RST<br>by Watchdog | 80 mA       |
| 5   | IPRECHG[1] | 0   | R/W  | by REG_RST<br>by Watchdog | 40 mA       |
| 4   | IPRECHG[0] | 1   | R/W  | by REG_RST<br>by Watchdog | 20 mA       |
| 3   | ITERM[3]   | 0   | R/W  | by REG_RST<br>by Watchdog | 160 mA      |
| 2   | ITERM[2]   | 0   | R/W  | by REG_RST<br>by Watchdog | 80 mA       |
| 1   | ITERM[1]   | 1   | R/W  | by REG_RST<br>by Watchdog | 40 mA       |
| 0   | ITERM[0]   | 0   | R/W  | by REG_RST<br>by Watchdog | 20 mA       |

Precharge current setting  
Default: 40 mA (0001)  
Range: 20 mA (0000) – 260 mA (1100)  
Offset: 20 mA  
Note: I<sub>PRECHG</sub> > 260 mA is clamped to 260 mA (1100)

Termination current setting  
Default: 60 mA (0010)  
Range: 20 mA – 260 mA (1100)  
Offset: 20 mA  
Note: I<sub>TERM</sub> > 260 mA is clamped to 260 mA (1100)

LEGEND: R/W = Read/Write; R = Read only

### 7.5.5 Battery Voltage Limit Register (Address = 04h) [Reset = 40h]

**Figure 7-20. REG04 Register**

| 7   | 6   | 5   | 4   | 3   | 2   | 1   | 0   |
|-----|-----|-----|-----|-----|-----|-----|-----|
| 0   | 1   | 0   | 0   | 0   | 0   | 0   | 0   |
| R/W | R/W | R/W | R/W | R/W | R/W | R/W | R/W |

LEGEND: R/W = Read/Write; R = Read only; -n = value after reset

**Table 7-11. REG04 Field Descriptions**

| Bit | Field           | POR | Type | Reset                     | Description  |
|-----|-----------------|-----|------|---------------------------|--|
| 7   | VBATREG[4]      | 0   | R/W  | by REG_RST<br>by Watchdog | Battery voltage setting, also called $V_{REG}$ .<br>Default: 4.200 V (01000)   |
| 6   | VBATREG[3]      | 1   | R/W  | by REG_RST<br>by Watchdog | 00000 – 3.504 V<br>00001 – 3.600 V<br>00010 – 3.696 V  |
| 5   | VBATREG[2]      | 0   | R/W  | by REG_RST<br>by Watchdog | 00011 – 3.800 V<br>00100 – 3.904 V   |
| 4   | VBATREG[1]      | 0   | R/W  | by REG_RST<br>by Watchdog | 00101 – 4.000 V<br>00110 – 4.100 V<br>00111 – 4.150 V  |
| 3   | VBATREG[0]      | 0   | R/W  | by REG_RST<br>by Watchdog | 01000 – 4.200 V<br>01001 - 11111 – 4.300 V - 4.520 V, 10 mV/step<br>01110 4.350 V, 10011 4.400 V, 11000 4.450 V, 11101 4.500 V |
| 2   | TOPOFF_TIMER[1] | 0   | R/W  | by REG_RST<br>by Watchdog | Top-off timer setting.<br>00 – Disabled (default)  |
| 1   | TOPOFF_TIMER[0] | 0   | R/W  | by REG_RST<br>by Watchdog | 01 – 15 minutes<br>10 – 30 minutes<br>11 – 45 minutes  |
| 0   | VRECHG          | 0   | R/W  | by REG_RST<br>by Watchdog | Battery recharge threshold setting.<br>0 – 120 mV (default)<br>1 – 210 mV  |

LEGEND: R/W = Read/Write; R = Read only

### 7.5.6 Charger Control 1 Register (Address = 05h) [Reset = 9Eh]

Figure 7-21. REG05 Register

| 7   | 6   | 5   | 4   | 3   | 2   | 1   | 0   |
|-----|-----|-----|-----|-----|-----|-----|-----|
| 1   | 0   | 0   | 1   | 1   | 1   | 1   | 0   |
| R/W | R/W | R/W | R/W | R/W | R/W | R/W | R/W |

LEGEND: R/W = Read/Write; R = Read only; -n = value after reset

Table 7-12. REG05 Field Descriptions

| Bit | Field                | POR | Type | Reset                     | Description  |
|-----|----------------------|-----|------|---------------------------|--|
| 7   | EN_TERM              | 1   | R/W  | by REG_RST<br>by Watchdog | Battery charging termination enable.<br>0 – Disable<br>1 – Enable (default)  |
| 6   | Reserved             | 0   | R/W  | by REG_RST<br>by Watchdog | Reserved   |
| 5   | WATCHDOG[1]          | 0   | R/W  | by REG_RST<br>by Watchdog | Watchdog timer setting.<br>00 – Disable timer<br>01 – 40 s (default)   |
| 4   | WATCHDOG[0]          | 1   | R/W  | by REG_RST<br>by Watchdog | 10 – 80 s<br>11 – 160 s  |
| 3   | EN_TIMER             | 1   | R/W  | by REG_RST<br>by Watchdog | Battery charging safety timer enable, including both fast charge and precharge timers. Precharge timer is 2 hours. Fast charge timer is set by REG05[2]<br>0 – Disable<br>1 – Enable timer (default) |
| 2   | CHG_TIMER            | 1   | R/W  | by REG_RST<br>by Watchdog | Battery fast charging safety timer setting.<br>0 – 20 hrs<br>1 – 10 hrs (default)  |
| 1   | TREG                 | 1   | R/W  | by REG_RST<br>by Watchdog | Thermal regulation threshold:<br>0 – 90°C<br>1 – 110°C (default)   |
| 0   | JEITA_VSET (45C-60C) | 0   | R/W  | by REG_RST<br>by Watchdog | Battery voltage setting during JEITA warm (T3 - T5, typically 45C - 60C)<br>0 – Set charge voltage to 4.1 V (max) (default)<br>1 – Set charge voltage to $V_{REG}$                                   |

LEGEND: R/W = Read/Write; R = Read only

**7.5.7 Charger Control 2 Register (Address = 06h) [Reset = E6h]**

**Figure 7-22. REG06 Register**

|     |     |     |     |     |     |     |     |
|-----|-----|-----|-----|-----|-----|-----|-----|
| 7   | 6   | 5   | 4   | 3   | 2   | 1   | 0   |
| 1   | 1   | 1   | 0   | 0   | 1   | 1   | 0   |
| R/W | R/W | R/W | R/W | R/W | R/W | R/W | R/W |

LEGEND: R/W = Read/Write; R = Read only; -n = value after reset

**Table 7-13. REG06 Field Descriptions**

| Bit | Field     | POR | Type | Reset      | Description   |
|-----|-----------|-----|------|------------|---|
| 7   | OVP[1]    | 1   | R/W  | by REG_RST | V <sub>ACO</sub> V threshold during buck mode and boost mode.<br>00 – 5.85 V<br>01 – 6.4 V (5-V input)<br>10 – 11 V (9-V input)<br>11 – 14.2 V (12-V input) (default) |
| 6   | OVP[0]    | 1   | R/W  | by REG_RST |   |
| 5   | BOOSTV[1] | 1   | R/W  | by REG_RST | Boost regulation voltage setting<br>00 – 4.6 V<br>01 – 4.75 V<br>10 – 5.0 V (default)<br>11 – 5.15 V  |
| 4   | BOOSTV[0] | 0   | R/W  | by REG_RST |   |
| 3   | VINDPM[3] | 0   | R/W  | by REG_RST | VINDPM threshold setting<br>Default: 4.5 V (0110)<br>Range: 3.9 V (0000) – 5.4 V (1111)<br>Offset: 3.9 V  |
| 2   | VINDPM[2] | 1   | R/W  | by REG_RST |   |
| 1   | VINDPM[1] | 1   | R/W  | by REG_RST |   |
| 0   | VINDPM[0] | 0   | R/W  | by REG_RST |   |

LEGEND: R/W = Read/Write; R = Read only

### 7.5.8 Charger Control 3 Register (Address = 07h) [Reset = 4Ch]

Figure 7-23. REG07 Register

| 7   | 6   | 5   | 4   | 3   | 2   | 1   | 0   |
|-----|-----|-----|-----|-----|-----|-----|-----|
| 0   | 1   | 0   | 0   | 1   | 1   | 0   | 0   |
| R/W | R/W | R/W | R/W | R/W | R/W | R/W | R/W |

LEGEND: R/W = Read/Write; R = Read only; -n = value after reset

Table 7-14. REG07 Field Descriptions

| Bit | Field               | POR | Type | Reset                     | Description   |
|-----|---------------------|-----|------|---------------------------|---|
| 7   | IINDET_EN           | 0   | R/W  | by REG_RST<br>by Watchdog | Force input source type detection. After the detection is complete, this bit returns to 0.<br>0 – Not in input current limit detection. (default)<br>1 – Force input current limit detection when adapter is present.   |
| 6   | TMR2X_EN            | 1   | R/W  | by REG_RST<br>by Watchdog | Safety timer is slowed by 2X during input DPM, JEITA cool/warm or thermal regulation.<br>0 – Disable. Safety timer duration is set by REG05[2].<br>1 – Safety timer slowed by 2X during input DPM (both V and I) or JEITA cool/warm (except I <sub>CHG</sub> =100%), or thermal regulation. (default) |
| 5   | BATFET_DIS          | 0   | R/W  | by REG_RST                | BATFET Q4 ON/OFF control. Set this bit to 1 to enter ship mode. To reset the device with adapter present, the host shall set BATFET_RST_WVBUS to 1 and then BATFET_DIS to 1.<br>0 – Turn on Q4. (default)<br>1 – Turn off Q4 after t <sub>BATFET_DLY</sub> delay time (REG07[3])                      |
| 4   | BATFET_RST_WVBUS    | 0   | R/W  | by REG_RST                | Start BATFET full system reset with or without adapter present.<br>0 – Start BATFET full system reset after adapter is removed from VBUS. (default)<br>1 – Start BATFET full system reset when adapter is present on VBUS.  |
| 3   | BATFET_DLY          | 1   | R/W  | by REG_RST                | Delay from BATFET_DIS (REG07[5]) set to 1 to BATFET turn off during ship mode.<br>0 – Turn off BATFET immediately when BATFET_DIS bit is set.<br>1 – Turn off BATFET after t <sub>BATFET_DLY</sub> (typ 10 s) when BATFET_DIS bit is set. (default)   |
| 2   | BATFET_RST_EN       | 1   | R/W  | by REG_RST<br>by Watchdog | Enable BATFET full system reset. The time to start of BATFET full system reset is based on the setting of BATFET_RST_WVBUS bit.<br>0 – Disable BATFET reset function<br>1 – Enable BATFET reset function when REG07[5] is also 1. (default)   |
| 1   | VINDPM_BAT_TRACK[1] | 0   | R/W  | by REG_RST                | Sets VINDPM to track BAT voltage. Actual VINDPM is higher of register value and V <sub>BAT</sub> + VINDPM_BAT_TRACK.<br>00 – Disable function (VINDPM set by register) (default)<br>01 – V <sub>BAT</sub> + 200 mV<br>10 – V <sub>BAT</sub> + 250 mV<br>11 – V <sub>BAT</sub> + 300 mV                |
| 0   | VINDPM_BAT_TRACK[0] | 0   | R/W  | by REG_RST                |   |

LEGEND: R/W = Read/Write; R = Read only



### 7.5.9 Charger Status 0 Register (Address = 08h)

**Figure 7-24. REG08**

| 7 | 6 | 5 | 4 | 3 | 2 | 1 | 0 |
|---|---|---|---|---|---|---|---|
| x | x | x | x | x | x | x | x |
| R | R | R | R | R | R | R | R |

LEGEND: R/W = Read/Write; R = Read only; -n = value after reset

**Table 7-15. REG08 Field Descriptions**

| Bit | Field        | POR | Type | Reset | Description  |
|-----|--------------|-----|------|-------|--|
| 7   | VBUS_STAT[2] | x   | R    | NA    | VBUS Status register<br>000 – No input<br>001 – USB host SDP (500 mA) → PSEL pin HIGH<br>011 – Adapter 2.4 A → PSEL pin LOW<br>111 – Boost mode<br>Software current limit is reported in IINDPM register |
| 6   | VBUS_STAT[1] | x   | R    | NA    |  |
| 5   | VBUS_STAT[0] | x   | R    | NA    |  |
| 4   | CHRG_STAT[1] | x   | R    | NA    | Charging status:<br>00 – Not charging<br>01 – Precharge or trickle charge ( $< V_{BATLOWV}$ )<br>10 – Fast charging<br>11 – Charge termination   |
| 3   | CHRG_STAT[0] | x   | R    | NA    |  |
| 2   | PG_STAT      | x   | R    | NA    | Power Good status:<br>0 – Power Not Good<br>1 – Power Good   |
| 1   | THERM_STAT   | x   | R    | NA    | 0 – Not in thermal regulation<br>1 – In thermal regulation   |
| 0   | VSYS_STAT    | x   | R    | NA    | 0 – Not in SYS_MIN regulation ( $V_{BAT} > V_{SYS\_MIN}$ )<br>1 – In SYS_MIN regulation ( $V_{BAT} < V_{SYS\_MIN}$ )   |

LEGEND: R/W = Read/Write; R = Read only

**7.5.10 Charger Status 1 Register (Address = 09h)**
**Figure 7-25. REG09 Register**

| 7 | 6 | 5 | 4 | 3 | 2 | 1 | 0 |
|---|---|---|---|---|---|---|---|
| 1 | x | x | x | x | x | x | x |
| R | R | R | R | R | R | R | R |

LEGEND: R/W = Read/Write; R = Read only; -n = value after reset

**Table 7-16. REG09 Field Descriptions**

| Bit | Field          | POR | Type | Reset | Description   |
|-----|----------------|-----|------|-------|---|
| 7   | WATCHDOG_FAULT | 1   | R    | NA    | 0 – Normal, device is in host mode,<br>1 – Watchdog timer expiration, device is in default mode.  |
| 6   | BOOST_FAULT    | x   | R    | NA    | 0 – Normal<br>1 – Fault detected in boost mode (any conditions that are not valid for boost operation), including VBUS overloaded (BST_OVP) or battery is too low (BST_BAT) |
| 5   | CHRG_FAULT[1]  | x   | R    | NA    | 00 – Normal   |
| 4   | CHRG_FAULT[0]  | x   | R    | NA    | 01 – Input fault<br>10 – Thermal shutdown<br>11 – Charge safety timer expiration  |
| 3   | BAT_FAULT      | x   | R    | NA    | 0 – Normal,<br>1 – Battery overvoltage.   |
| 2   | NTC_FAULT[2]   | x   | R    | NA    | TS fault in buck mode   |
| 1   | NTC_FAULT[1]   | x   | R    | NA    | 000 – Normal<br>010 – Warm<br>011 – Cool<br>101 – Cold<br>110 – Hot   |
| 0   | NTC_FAULT[0]   | x   | R    | NA    | TS fault in boost mode<br>000 – Normal<br>101 – Cold<br>110 – Hot   |

LEGEND: R/W = Read/Write; R = Read only

### 7.5.11 Charger Status 2 Register (Address = 0Ah)

**Figure 7-26. REG0A Register**

| 7 | 6 | 5 | 4 | 3 | 2 | 1   | 0   |
|---|---|---|---|---|---|-----|-----|
| x | x | x | x | x | x | 0   | 0   |
| R | R | R | R | R | R | R/W | R/W |

LEGEND: R/W = Read/Write; R = Read only; -n = value after reset

**Table 7-17. REG0A Field Descriptions**

| Bit | Field           | POR | Type | Reset      | Description   |
|-----|-----------------|-----|------|------------|---|
| 7   | VBUS_GD         | x   | R    | NA         | 0 – VBUS does not pass poor source detection<br>1 – VBUS passes poor source detection   |
| 6   | VINDPM_STAT     | x   | R    | NA         | 0 – Not in VINDPM<br>1 – In VINDPM  |
| 5   | IINDPM_STAT     | x   | R    | NA         | 0 – Not in IINDPM<br>1 – In IINDPM  |
| 4   | BATSNS_STAT     | x   | R    | NA         | 0 – BATSNS pin is in good connection. Regulation battery voltage through BATSNS pin.<br>1 – BATSNS pin is open/short. Regulate battery voltage through BAT pin.   |
| 3   | TOPOFF_ACTIVE   | x   | R    | NA         | 0 – Top off timer not counting.<br>1 – Top off timer counting   |
| 2   | ACOV_STAT       | x   | R    | NA         | 0 – Not in ACOV<br>1 – In ACOV  |
| 1   | VINDPM_INT_MASK | 0   | R/W  | by REG_RST | Allow or block $\overline{\text{INT}}$ pulse assertion to host during VINDPM.<br>0 – $\overline{\text{INT}}$ is asserted to host during VINDPM (default).<br>1 – No $\overline{\text{INT}}$ pulse asserted to host during VINDPM. |
| 0   | IINDPM_INT_MASK | 0   | R/W  | by REG_RST | Allow or block $\overline{\text{INT}}$ pulse assertion to host during IINDPM.<br>0 – $\overline{\text{INT}}$ is asserted to host during IINDPM (default).<br>1 – No $\overline{\text{INT}}$ pulse asserted to host during IINDPM. |

LEGEND: R/W = Read/Write; R = Read only

**7.5.12 Part Information Register (Address = 0Bh)**

**Figure 7-27. REG0B Register**

|     |   |   |   |   |   |   |   |
|-----|---|---|---|---|---|---|---|
| 7   | 6 | 5 | 4 | 3 | 2 | 1 | 0 |
| 0   | 0 | 1 | 0 | 1 | 1 | 0 | 0 |
| R/W | R | R | R | R | R | R | R |

LEGEND: R/W = Read/Write; R = Read only; -n = value after reset

**Table 7-18. REG0B Field Descriptions**

| Bit | Field    | POR | Type | Reset | Description  |
|-----|----------|-----|------|-------|--|
| 7   | REG_RST  | 0   | R/W  | NA    | Register reset<br>0 – Keep current register setting (default).<br>1 – Reset to default register value and reset safety timer. This bit returns to 0 after register reset is completed. |
| 6   | PN[3]    | 0   | R    | NA    | Reserved   |
| 5   | PN[2]    | 1   | R    | NA    |  |
| 4   | PN[1]    | 0   | R    | NA    |  |
| 3   | PN[0]    | 1   | R    | NA    |  |
| 2   | Reserved | 1   | R    | NA    | Reserved   |
| 1   | Reserved | 0   | R    | NA    | Reserved   |
| 0   | Reserved | 0   | R    | NA    |  |

LEGEND: R/W = Read/Write; R = Read only

**7.5.13 Charger Control 4 Register (Address = 0Ch) [Reset = 75h]**  
**Figure 7-28. REG0C**

|     |     |     |     |     |     |     |     |
|-----|-----|-----|-----|-----|-----|-----|-----|
| 7   | 6   | 5   | 4   | 3   | 2   | 1   | 0   |
| 0   | 1   | 1   | 1   | 0   | 1   | 0   | 1   |
| R/W | R/W | R/W | R/W | R/W | R/W | R/W | R/W |

LEGEND: R/W = Read/Write; R = Read only; -n = value after reset

**Table 7-19. REG0C Field Descriptions**

| Bit | Field               | POR | Type | Reset                     | Description  |
|-----|---------------------|-----|------|---------------------------|--|
| 7   | JEITA_COOL_ISET [1] | 0   | R/W  | by REG_RST<br>by Watchdog | Fast charge current setting during cool temperature range (T1 - T2), as percentage of I <sub>CHG</sub> in REG02[5:0].<br>00 – No Charge<br>01 – 20% of I <sub>CHG</sub> (default)<br>10 – 50% of I <sub>CHG</sub><br>11 – 100% of I <sub>CHG</sub> (safety timer does not become 2X) |
| 6   | JEITA_COOL_ISET [0] | 1   | R/W  | by REG_RST<br>by Watchdog |  |
| 5   | JEITA_WARM_ISET [1] | 1   | R/W  | by REG_RST<br>by Watchdog | Fast charge current setting during warm temperature range (T3 - T5), as percentage of I <sub>CHG</sub> in REG02[5:0].<br>00 – No Charge<br>01 – 20% of I <sub>CHG</sub><br>10 – 50% of I <sub>CHG</sub><br>11 – 100% of I <sub>CHG</sub> (safety timer does not become 2X) (default) |
| 4   | JEITA_WARM_ISET [0] | 1   | R/W  | by REG_RST<br>by Watchdog |  |
| 3   | JEITA_VT2 [1]       | 0   | R/W  | by REG_RST<br>by Watchdog | 00 – VT2% = 70.75% (5.5°C)<br>01 – VT2% = 68.25% (10°C) (default)<br>10 – VT2% = 65.25% (15°C)<br>11 – VT2% = 62.25% (20°C)  |
| 2   | JEITA_VT2 [0]       | 1   | R/W  | by REG_RST<br>by Watchdog |  |
| 1   | JEITA_VT3 [1]       | 0   | R/W  | by REG_RST<br>by Watchdog | 00 – VT3% = 48.25% (40°C)<br>01 – VT3% = 44.75% (44.5°C) (default)<br>10 – VT3% = 40.75% (50.5°C)<br>11 – VT3% = 37.75% (54.5°C)   |
| 0   | JEITA_VT3 [0]       | 1   | R/W  | by REG_RST<br>by Watchdog |  |

LEGEND: R/W = Read/Write; R = Read only

## 8 Application and Implementation

### Note

Information in the following applications sections is not part of the TI component specification, and TI does not warrant its accuracy or completeness. TI's customers are responsible for determining suitability of components for their purposes, as well as validating and testing their design implementation to confirm system functionality.

### 8.1 Application Information

A typical application consists of the device configured as an I<sup>2</sup>C controlled power path management device and a single cell battery charger for Li-ion and Li-polymer batteries used in a wide range of smart phones and other portable devices. It integrates an input reverse-block FET (RBFET, Q1), high-side switching FET (HSFET, Q2), low-side switching FET (LSFET, Q3), and battery FET (BATFET Q4) between the system and battery. The device also integrates a bootstrap diode for the high-side gate drive.

### 8.2 Typical Application

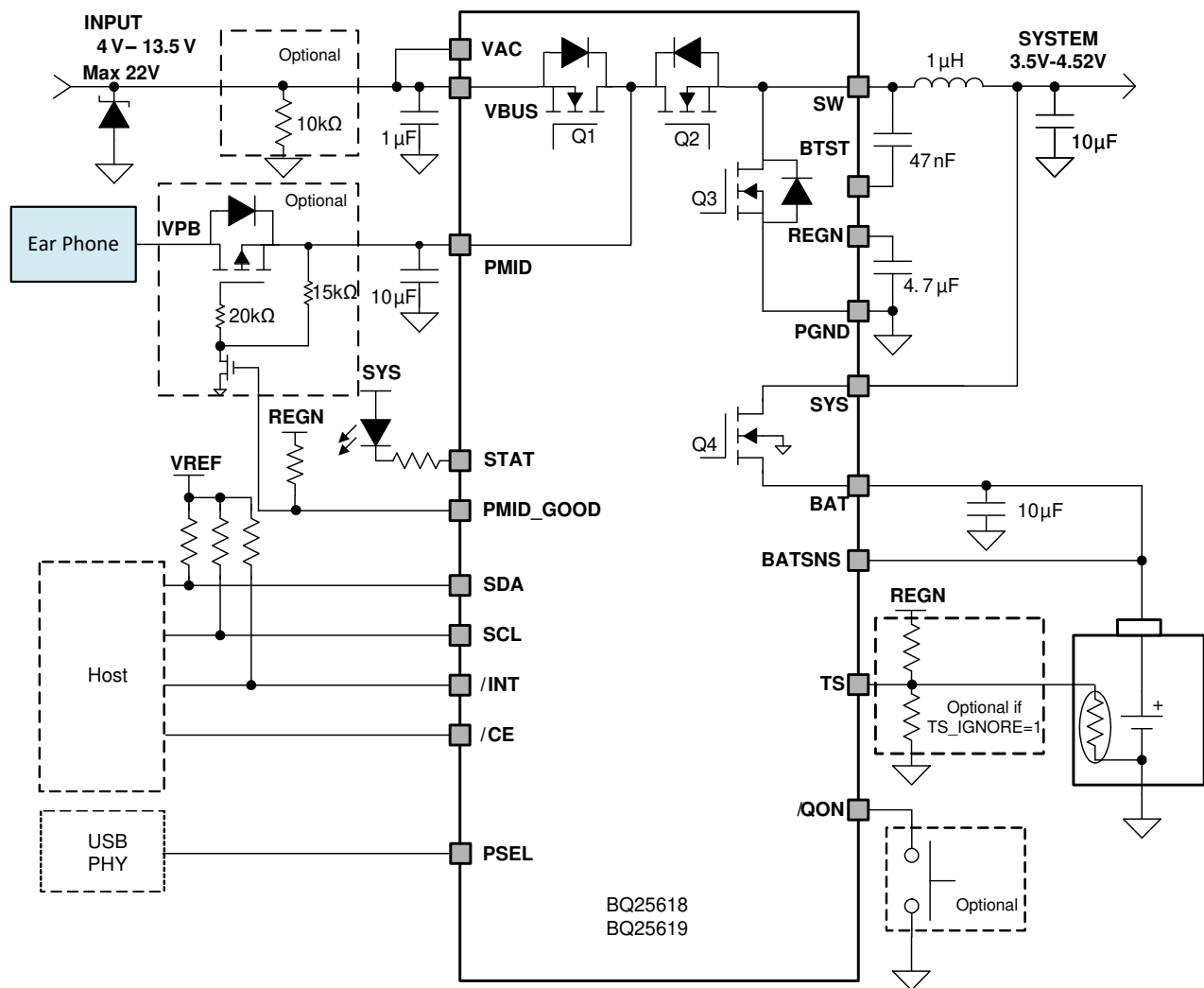


Figure 8-1. BQ25619 Application Diagram with Optional PMOS

See the [BQ25618 BMS024 Evaluation Module User's Guide](#) and [BQ25619 BMS025 Evaluation Module EVM User's Guide](#) for complete schematic and component placement with trace and via locations.

### 8.2.1 Design Requirements

For this design example, use the parameters shown in the table below.

**Table 8-1. Design Parameters**

| PARAMETER                               | VALUE         |
|---|---------------|
| V <sub>VBUS</sub> voltage range         | 4 V to 13.5 V |
| Input current limit (REG00[4:0])        | 2.4 A         |
| Fast charge current limit (REG02[5:0])  | 1.024 A       |
| Minimum system voltage (REG01[3:1])     | 3.5 V         |
| Battery regulation voltage (REG04[7:3]) | 4.2 V         |

### 8.2.2 Detailed Design Procedure

#### 8.2.2.1 Inductor Selection

The 1.5-MHz switching frequency allows the use of small inductor and capacitor values to maintain an inductor saturation current higher than the charging current (I<sub>CHG</sub>) plus half the ripple current (I<sub>RIPPLE</sub>):

$$I_{SAT} \geq I_{CHG} + (1/2) I_{RIPPLE} \quad (3)$$

The inductor ripple current depends on the input voltage (V<sub>VBUS</sub>), the duty cycle ( $D = V_{BAT}/V_{VBUS}$ ), the switching frequency (f<sub>S</sub>) and the inductance (L).

$$I_{RIPPLE} = \frac{V_{IN} \times D \times (1 - D)}{f_s \times L} \quad (4)$$

The maximum inductor ripple current occurs when the duty cycle (D) is 0.5 or approximately 0.5. Usually inductor ripple is designed in the range between 20% and 40% maximum charging current as a trade-off between inductor size and efficiency for a practical design.

For compact solution size and efficiency at high current, a 1-μH inductor is recommended. To achieve better light load efficiency during boost mode (output current below 500 mA), the device also supports a 2.2-μH inductor with a 10-μF (min) cap on the system.

#### 8.2.2.2 Input Capacitor and Resistor

Design the input capacitance to provide enough ripple current rating to absorb the input switching ripple current. Worst case RMS ripple current is half of the charging current when the duty cycle is 0.5. If the converter does not operate at 50% duty cycle, then the worst case capacitor RMS current I<sub>CIN</sub> occurs where the duty cycle is closest to 50% and can be estimated using [Equation 5](#).

$$I_{CIN} = I_{CHG} \times \sqrt{D \times (1 - D)} \quad (5)$$

A low ESR ceramic capacitor such as X7R or X5R is preferred for the input decoupling capacitor and should be placed as close as possible to the drain of the high-side MOSFET and source of the low-side MOSFET. The voltage rating of the capacitor must be higher than the normal input voltage level. A 25-V or higher rated capacitor is preferred for a 12-V input voltage. Minimum capacitance of 10 μF is suggested for typical of 1.5-A charging current.

During high current output over 700 mA in boost mode, a 10-kΩ pull-down resistor on VBUS is recommended to keep VBUS low in case Q1 RBFET leakage gets high.

#### 8.2.2.3 Output Capacitor

Ensure that the output capacitance has enough ripple current rating to absorb the output switching ripple current. [Equation 6](#) shows the output capacitor RMS current I<sub>COU</sub>T calculation.



$$I_{\text{COUT}} = \frac{I_{\text{RIPPLE}}}{2 \times \sqrt{3}} \approx 0.29 \times I_{\text{RIPPLE}} \quad (6)$$

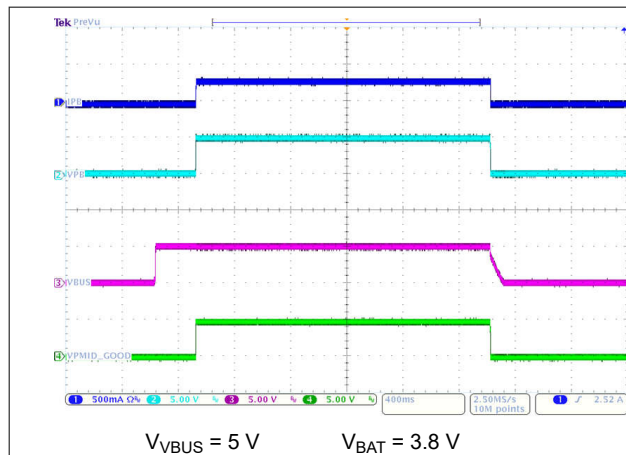
The output capacitor voltage ripple can be calculated as follows:

$$\Delta V_{\text{O}} = \frac{V_{\text{OUT}}}{8LCf_s^2} \left( 1 - \frac{V_{\text{OUT}}}{V_{\text{IN}}} \right) \quad (7)$$

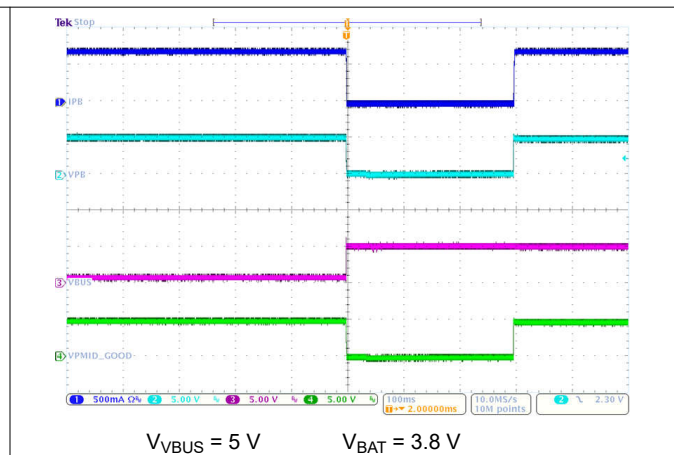
At certain input and output voltages and switching frequency, the voltage ripple can be reduced by increasing the output filter LC.

The charger device has internal loop compensation optimized for >10-μF ceramic output capacitance. The preferred ceramic capacitor is 10-V rating, X7R or X5R.

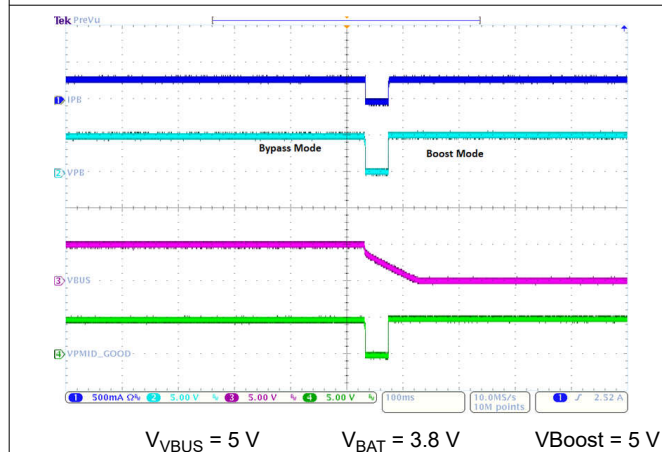
### 8.2.3 Application Curves



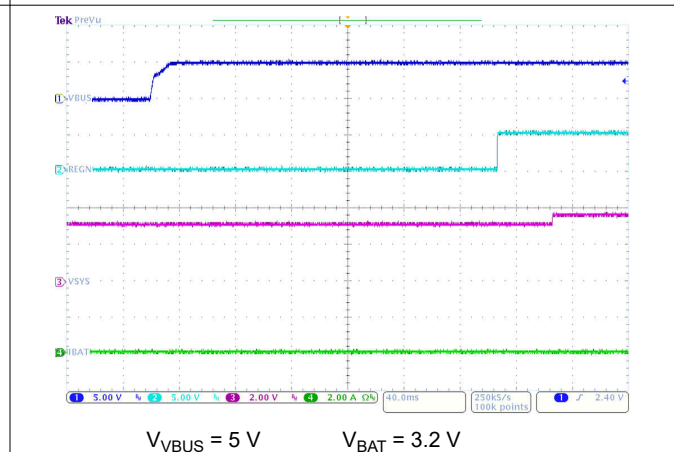
**Figure 8-2. VBUS Plugged In and Unplugged with Boost Mode Disabled**



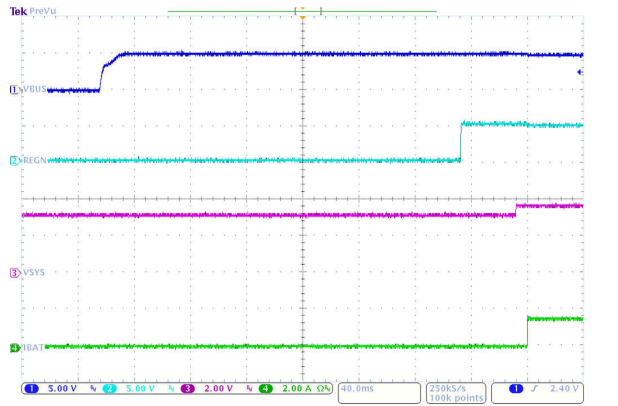
**Figure 8-3. VBUS Plugged In with Boost Mode Enabled**



**Figure 8-4. VBUS Unplugged with Boost Mode Enabled**

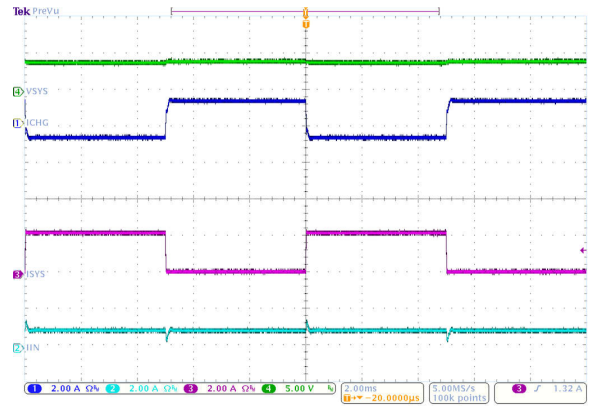


**Figure 8-5. Power Up with Charge Disabled**



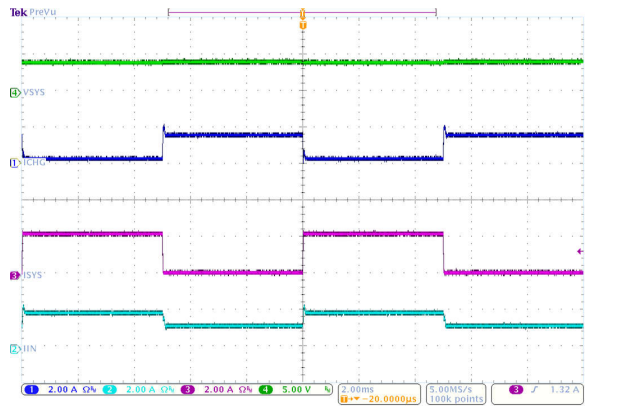
$I_{CHG} = 1.5\text{ A}$        $V_{VBUS} = 5\text{ V}$        $V_{BAT} = 3.2\text{ V}$

**Figure 8-6. Power Up with Charge Enabled**



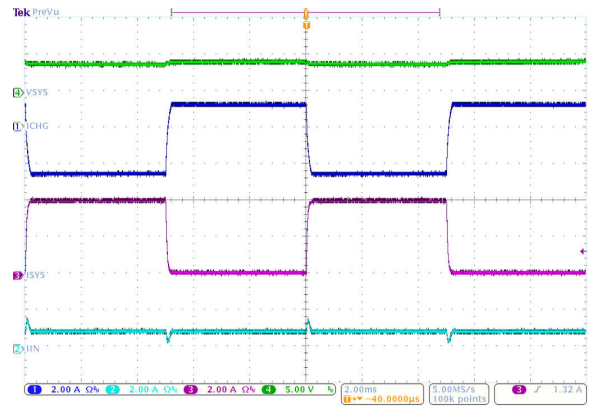
$I_{SYS} = 0 - 2\text{ A}$        $V_{VBUS} = 5\text{ V}$        $I_{INDPM} = 1\text{ A}$   
 $I_{CHG} = 1.5\text{ A}$        $V_{BAT} = 3.7\text{ V}$

**Figure 8-7. System Load Transient Response**



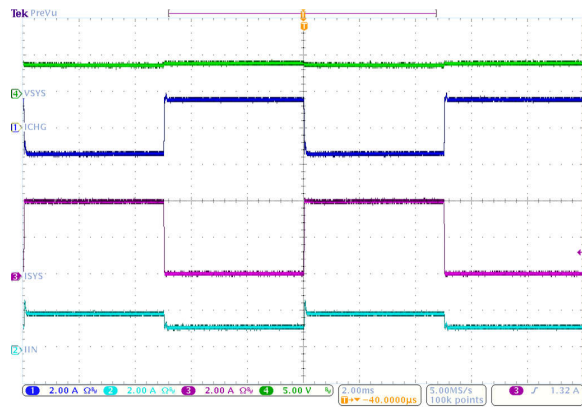
$I_{SYS} = 0 - 2\text{ A}$        $V_{VBUS} = 5\text{ V}$        $I_{INDPM} = 2\text{ A}$   
 $I_{CHG} = 1\text{ A}$        $V_{BAT} = 3.7\text{ V}$

**Figure 8-8. System Load Transient Response**



$I_{SYS} = 0 - 4\text{ A}$        $V_{VBUS} = 5\text{ V}$        $I_{INDPM} = 1\text{ A}$   
 $I_{CHG} = 1.5\text{ A}$        $V_{BAT} = 3.7\text{ V}$

**Figure 8-9. System Load Transient Response**



$I_{SYS} = 0 - 4\text{ A}$        $V_{VBUS} = 5\text{ V}$        $I_{INDPM} = 2\text{ A}$   
 $I_{CHG} = 1.5\text{ A}$        $V_{BAT} = 3.7\text{ V}$

**Figure 8-10. System Load Transient Response**

## 9 Power Supply Recommendations

In order to provide an output voltage on SYS, the battery charger requires a power supply between 4 V and 13.5 V input with at least a 100-mA current rating connected to VBUS and a single-cell Li-ion battery with battery voltage greater than  $V_{BAT\_UVLOZ}$  connected to BAT. The source current rating needs to be at least 3 A in order for the buck converter of the charger to provide maximum output power to SYS.

## 10 Layout

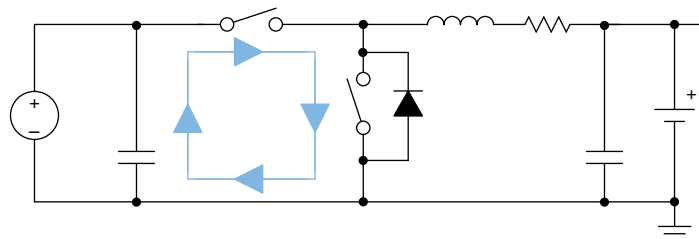
### 10.1 Layout Guidelines

The switching node rise and fall times should be minimized for minimum switching loss. Proper layout of the components to minimize the high frequency current path loop (see [Figure 10-1](#)) is important to prevent electrical and magnetic field radiation and high frequency resonant problems. Follow this specific order carefully to achieve the proper layout.

1. Place an input capacitor as close as possible to the PMID pin and GND pin connections and use the shortest copper trace connection or GND plane. Add a 1-nF small size (such as 0402 or 0201) decoupling cap for the high frequency noise filter and EMI improvement.
2. Place the inductor input pin as close as possible to SW pin. Minimize the copper area of this trace to lower electrical and magnetic field radiation but make the trace wide enough to carry the charging current. Do not use multiple layers in parallel for this connection. Minimize parasitic capacitance from this area to any other trace or plane.
3. Put the output capacitor near to the inductor and the device. Ground connections need to be tied to the IC ground with a short copper trace connection or GND plane.
4. Route the analog ground separately from power ground. Connect the analog ground and connect power ground separately. Connect the analog ground and power ground together using the thermal pad as the single ground connection point. Or use a 0- $\Omega$  resistor to tie the analog ground to power ground.
5. Use a single ground connection to tie the charger power ground to the charger analog ground just beneath the device. Use ground copper pour but avoid power pins to reduce inductive and capacitive noise coupling.
6. Place the decoupling capacitors next to the IC pins and make the trace connection as short as possible.
7. It is critical that the exposed thermal pad on the backside of the device package be soldered to the PCB ground. Ensure that there are sufficient thermal vias directly under the IC, connecting to the ground plane on the other layers.
8. Ensure that the number and sizes of vias allow enough copper for a given current path.

See the [BQ25618 BMS024 Evaluation Module User's Guide](#) and [BQ25619 BMS025 Evaluation Module EVM User's Guide](#) for the recommended component placement with trace and via locations. For the VQFN information, refer to [Quad Flatpack No-Lead Logic Packages Application Report](#) and [QFN and SON PCB Attachment Application Report](#).

### 10.2 Layout Example



**Figure 10-1. High Frequency Current Path**

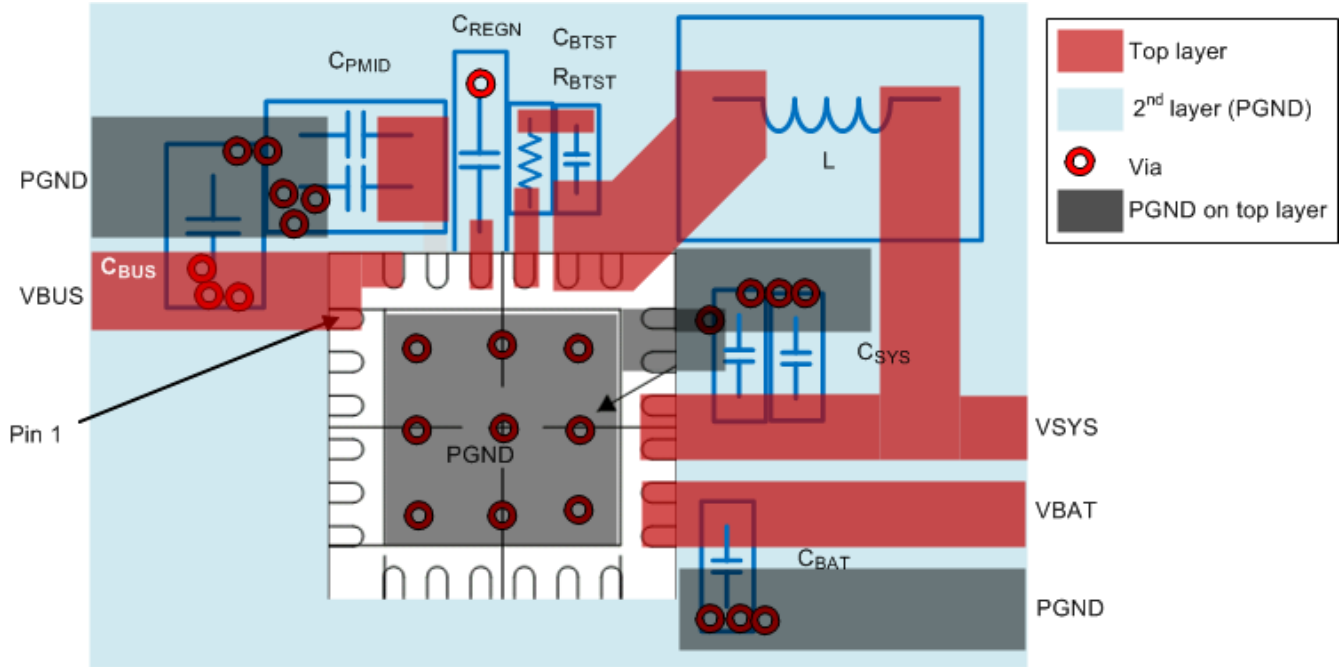


Figure 10-2. Layout Example

## 11 Device and Documentation Support

### 11.1 Device Support

#### 11.1.1 Third-Party Products Disclaimer

TI'S PUBLICATION OF INFORMATION REGARDING THIRD-PARTY PRODUCTS OR SERVICES DOES NOT CONSTITUTE AN ENDORSEMENT REGARDING THE SUITABILITY OF SUCH PRODUCTS OR SERVICES OR A WARRANTY, REPRESENTATION OR ENDORSEMENT OF SUCH PRODUCTS OR SERVICES, EITHER ALONE OR IN COMBINATION WITH ANY TI PRODUCT OR SERVICE.

### 11.2 Documentation Support

#### 11.2.1 Related Documentation

For related documentation see the following:

- [BQ25619 BMS025 Evaluation Module User's Guide](#)
- [BQ25618 BMS024 Evaluation Module User's Guide](#)

### 11.3 Receiving Notification of Documentation Updates

To receive notification of documentation updates, navigate to the device product folder on [ti.com](http://ti.com). Click on *Notifications* to register and receive a weekly digest of any product information that has changed. For change details, review the revision history included in any revised document.

### 11.4 Support Resources

[TI E2E™ support forums](#) are an engineer's go-to source for fast, verified answers and design help — straight from the experts. Search existing answers or ask your own question to get the quick design help you need.

Linked content is provided "AS IS" by the respective contributors. They do not constitute TI specifications and do not necessarily reflect TI's views; see TI's [Terms of Use](#).

### 11.5 Trademarks

TI E2E™ is a trademark of Texas Instruments.

All trademarks are the property of their respective owners.

### 11.6 Electrostatic Discharge Caution



This integrated circuit can be damaged by ESD. Texas Instruments recommends that all integrated circuits be handled with appropriate precautions. Failure to observe proper handling and installation procedures can cause damage.

ESD damage can range from subtle performance degradation to complete device failure. Precision integrated circuits may be more susceptible to damage because very small parametric changes could cause the device not to meet its published specifications.

### 11.7 Glossary

[TI Glossary](#) This glossary lists and explains terms, acronyms, and definitions.

## 12 Revision History

NOTE: Page numbers for previous revisions may differ from page numbers in the current version.

| Changes from Revision E (May 2024) to Revision F (February 2025)                                      | Page |
|---|------|
| • Updated charge current regulation to +/-5% in <a href="#">Features</a> .....                        | 1    |
| • Updated fast charge current regulation to +/-5% in <a href="#">Electrical Characteristics</a> ..... | 8    |

---

**Changes from Revision D (December 2021) to Revision E (July 2024) Page**

- Changed BAT, SYS (converter not switching) MAX value from 17V to 7V in [Absolute Maximum Ratings](#) ..... 7
  - Changed I<sub>Q\_BAT</sub> and I<sub>SHIP\_BAT</sub> test conditions in [Electrical Characteristics](#) ..... 8
- 

**Changes from Revision C (June 2021) to Revision D (December 2021) Page**

- Deleted t<sub>SU\_STA</sub>, t<sub>HD\_DAT</sub>, t<sub>rDA</sub>, and t<sub>fDA</sub> from Timing Requirements..... 13
- 

**Changes from Revision B (September 2019) to Revision C (June 2021) Page**

- Added Safety Related Certifications: IEC 62368-1 CB Certification.....1
  - Changed REG2 ICHG[5:0] 111100: 1430 mA to 111110: 1430 mA and 111100: 1500 mA to 111111: 1500 mA..... 32
- 

**Changes from Revision A (July 2019) to Revision B (September 2019) Page**

- Added BQ25618..... 1
- 

**Changes from Revision \* (June 2019) to Revision A (July 2019) Page**

- Changed from Advance Information to Production Data ..... 1
-

## 13 Mechanical, Packaging, and Orderable Information

The following pages include mechanical, packaging, and orderable information. This information is the most current data available for the designated devices. This data is subject to change without notice and revision of this document. For browser-based versions of this data sheet, refer to the left-hand navigation.



**PACKAGING INFORMATION**

| Orderable part number       | Status<br>(1) | Material type<br>(2) | Package   Pins   | Package qty   Carrier | RoHS<br>(3) | Lead finish/<br>Ball material<br>(4) | MSL rating/<br>Peak reflow<br>(5) | Op temp (°C) | Part marking<br>(6) |
|-----------------------------|---------------|----------------------|------------------|-----------------------|-------------|--------------------------------------|-----------------------------------|--------------|---------------------|
| <a href="#">BQ25618YFFR</a> | Active        | Production           | DSBGA (YFF)   30 | 3000   LARGE T&R      | Yes         | SNAGCU                               | Level-1-260C-UNLIM                | -40 to 85    | BQ25618             |
| BQ25618YFFR.A               | Active        | Production           | DSBGA (YFF)   30 | 3000   LARGE T&R      | Yes         | SNAGCU                               | Level-1-260C-UNLIM                | -40 to 85    | BQ25618             |
| <a href="#">BQ25618YFFT</a> | Active        | Production           | DSBGA (YFF)   30 | 250   SMALL T&R       | Yes         | SNAGCU                               | Level-1-260C-UNLIM                | -40 to 85    | BQ25618             |
| BQ25618YFFT.A               | Active        | Production           | DSBGA (YFF)   30 | 250   SMALL T&R       | Yes         | SNAGCU                               | Level-1-260C-UNLIM                | -40 to 85    | BQ25618             |
| <a href="#">BQ25619RTWR</a> | Active        | Production           | WQFN (RTW)   24  | 3000   LARGE T&R      | Yes         | NIPDAU                               | Level-1-260C-UNLIM                | -40 to 85    | BQ25619             |
| BQ25619RTWR.A               | Active        | Production           | WQFN (RTW)   24  | 3000   LARGE T&R      | Yes         | NIPDAU                               | Level-1-260C-UNLIM                | -40 to 85    | BQ25619             |
| <a href="#">BQ25619RTWT</a> | Active        | Production           | WQFN (RTW)   24  | 250   SMALL T&R       | Yes         | NIPDAU                               | Level-1-260C-UNLIM                | -40 to 85    | BQ25619             |
| BQ25619RTWT.A               | Active        | Production           | WQFN (RTW)   24  | 250   SMALL T&R       | Yes         | NIPDAU                               | Level-1-260C-UNLIM                | -40 to 85    | BQ25619             |

(1) **Status:** For more details on status, see our [product life cycle](#).

(2) **Material type:** When designated, preproduction parts are prototypes/experimental devices, and are not yet approved or released for full production. Testing and final process, including without limitation quality assurance, reliability performance testing, and/or process qualification, may not yet be complete, and this item is subject to further changes or possible discontinuation. If available for ordering, purchases will be subject to an additional waiver at checkout, and are intended for early internal evaluation purposes only. These items are sold without warranties of any kind.

(3) **RoHS values:** Yes, No, RoHS Exempt. See the [TI RoHS Statement](#) for additional information and value definition.

(4) **Lead finish/Ball material:** Parts may have multiple material finish options. Finish options are separated by a vertical ruled line. Lead finish/Ball material values may wrap to two lines if the finish value exceeds the maximum column width.

(5) **MSL rating/Peak reflow:** The moisture sensitivity level ratings and peak solder (reflow) temperatures. In the event that a part has multiple moisture sensitivity ratings, only the lowest level per JEDEC standards is shown. Refer to the shipping label for the actual reflow temperature that will be used to mount the part to the printed circuit board.

(6) **Part marking:** There may be an additional marking, which relates to the logo, the lot trace code information, or the environmental category of the part.

Multiple part markings will be inside parentheses. Only one part marking contained in parentheses and separated by a "-" will appear on a part. If a line is indented then it is a continuation of the previous line and the two combined represent the entire part marking for that device.

**Important Information and Disclaimer:** The information provided on this page represents TI's knowledge and belief as of the date that it is provided. TI bases its knowledge and belief on information provided by third parties, and makes no representation or warranty as to the accuracy of such information. Efforts are underway to better integrate information from third parties. TI has taken and continues to take reasonable steps to provide representative and accurate information but may not have conducted destructive testing or chemical analysis on incoming materials and chemicals. TI and TI suppliers consider certain information to be proprietary, and thus CAS numbers and other limited information may not be available for release.

In no event shall TI's liability arising out of such information exceed the total purchase price of the TI part(s) at issue in this document sold by TI to Customer on an annual basis.

**TAPE AND REEL INFORMATION**

**QUADRANT ASSIGNMENTS FOR PIN 1 ORIENTATION IN TAPE**


\*All dimensions are nominal

| Device      | Package Type | Package Drawing | Pins | SPQ  | Reel Diameter (mm) | Reel Width W1 (mm) | A0 (mm) | B0 (mm) | K0 (mm) | P1 (mm) | W (mm) | Pin1 Quadrant |
|-------------|--------------|-----------------|------|------|--------------------|--------------------|---------|---------|---------|---------|--------|---------------|
| BQ25618YFFR | DSBGA        | YFF             | 30   | 3000 | 180.0              | 8.4                | 2.09    | 2.59    | 0.78    | 4.0     | 8.0    | Q1            |
| BQ25618YFFT | DSBGA        | YFF             | 30   | 250  | 180.0              | 8.4                | 2.09    | 2.59    | 0.78    | 4.0     | 8.0    | Q1            |
| BQ25619RTWR | WQFN         | RTW             | 24   | 3000 | 330.0              | 12.4               | 4.25    | 4.25    | 1.15    | 8.0     | 12.0   | Q2            |
| BQ25619RTWT | WQFN         | RTW             | 24   | 250  | 180.0              | 12.4               | 4.25    | 4.25    | 1.15    | 8.0     | 12.0   | Q2            |

## TAPE AND REEL BOX DIMENSIONS



\*All dimensions are nominal

| Device      | Package Type | Package Drawing | Pins | SPQ  | Length (mm) | Width (mm) | Height (mm) |
|-------------|--------------|-----------------|------|------|-------------|------------|-------------|
| BQ25618YFFR | DSBGA        | YFF             | 30   | 3000 | 182.0       | 182.0      | 20.0        |
| BQ25618YFFT | DSBGA        | YFF             | 30   | 250  | 182.0       | 182.0      | 20.0        |
| BQ25619RTWR | WQFN         | RTW             | 24   | 3000 | 367.0       | 367.0      | 35.0        |
| BQ25619RTWT | WQFN         | RTW             | 24   | 250  | 210.0       | 185.0      | 35.0        |

## GENERIC PACKAGE VIEW

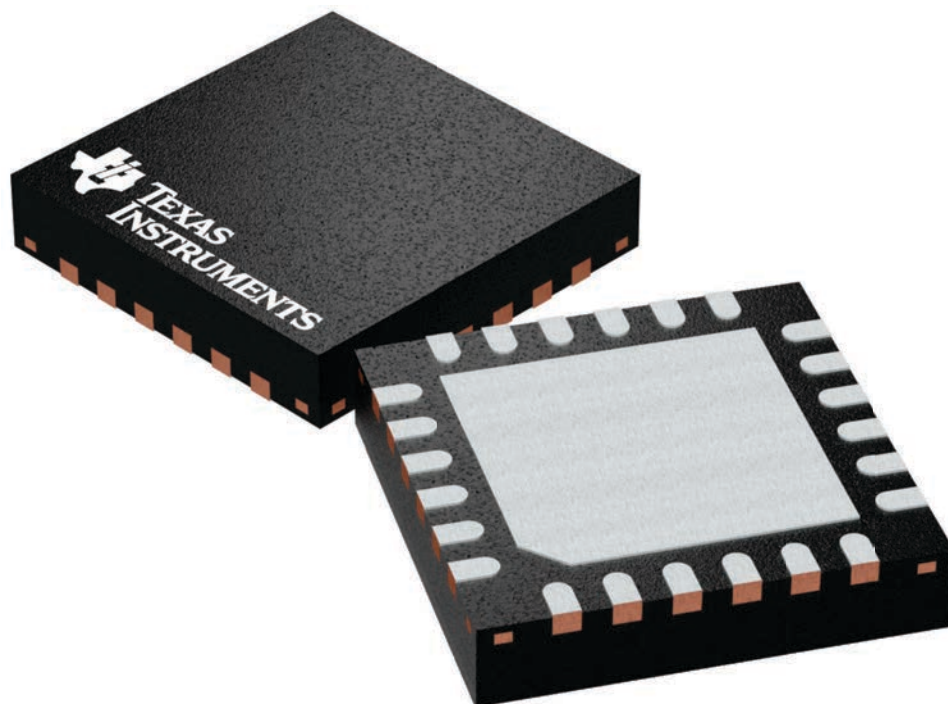
**RTW 24**

**WQFN - 0.8 mm max height**

4 x 4, 0.5 mm pitch

PLASTIC QUAD FLATPACK - NO LEAD

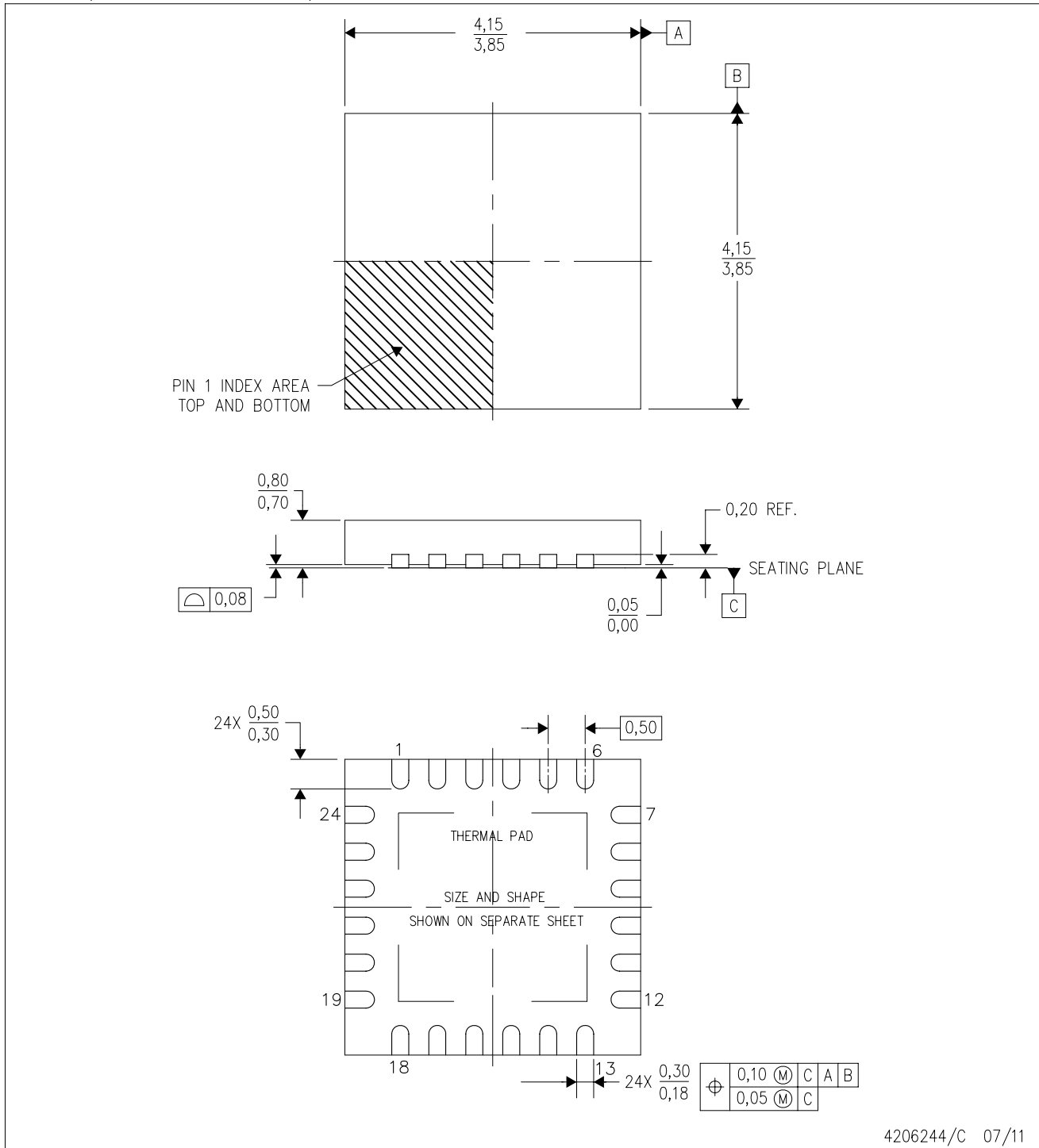
This image is a representation of the package family, actual package may vary.  
Refer to the product data sheet for package details.



4224801/A

RTW (S-PWQFN-N24)

PLASTIC QUAD FLATPACK NO-LEAD



4206244/C 07/11

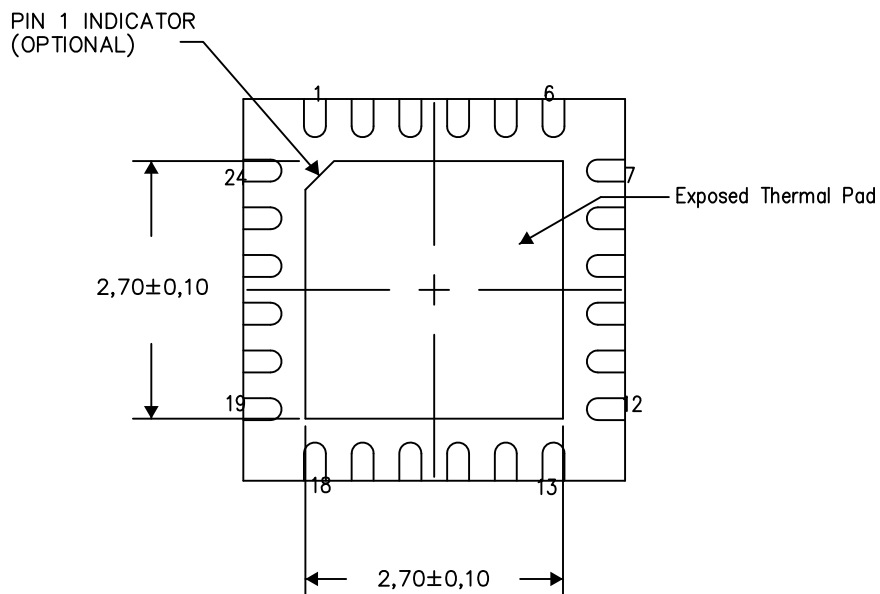
- NOTES:
- A. All linear dimensions are in millimeters. Dimensioning and tolerancing per ASME Y14.5M-1994.
  - B. This drawing is subject to change without notice.
  - C. Quad Flatpack, No-Leads (QFN) package configuration.
  - D. The package thermal pad must be soldered to the board for thermal and mechanical performance.
  - E. See the additional figure in the Product Data Sheet for details regarding the exposed thermal pad features and dimensions.
  - F. Falls within JEDEC MO-220.

THERMAL INFORMATION

This package incorporates an exposed thermal pad that is designed to be attached directly to an external heatsink. The thermal pad must be soldered directly to the printed circuit board (PCB). After soldering, the PCB can be used as a heatsink. In addition, through the use of thermal vias, the thermal pad can be attached directly to the appropriate copper plane shown in the electrical schematic for the device, or alternatively, can be attached to a special heatsink structure designed into the PCB. This design optimizes the heat transfer from the integrated circuit (IC).

For information on the Quad Flatpack No-Lead (QFN) package and its advantages, refer to Application Report, QFN/SON PCB Attachment, Texas Instruments Literature No. SLUA271. This document is available at [www.ti.com](http://www.ti.com).

The exposed thermal pad dimensions for this package are shown in the following illustration.



Bottom View

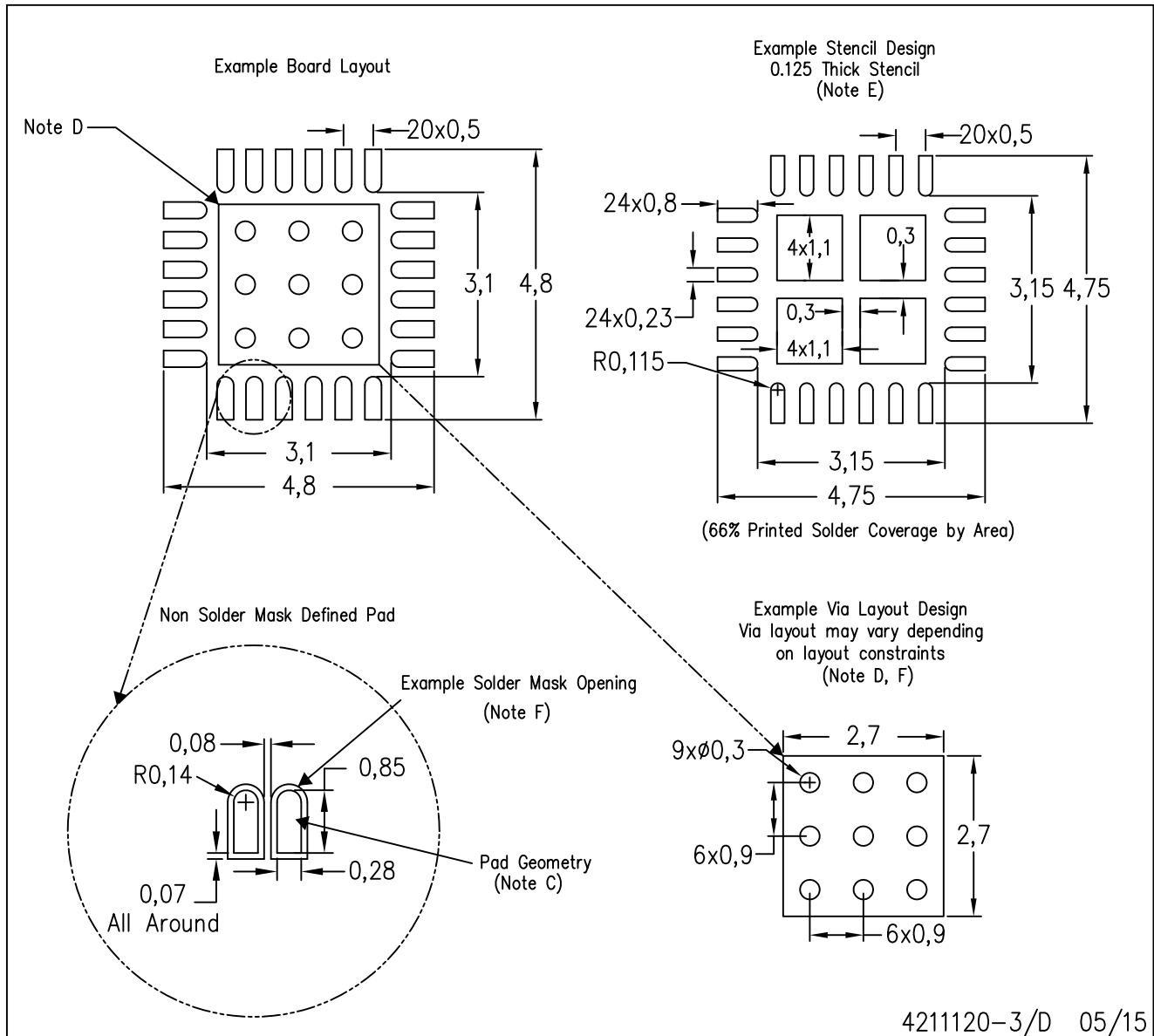
Exposed Thermal Pad Dimensions

4206249-5/P 05/15

NOTES: A. All linear dimensions are in millimeters

RTW (S-PWQFN-N24)

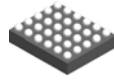
PLASTIC QUAD FLATPACK NO-LEAD



- NOTES:
- All linear dimensions are in millimeters.
  - This drawing is subject to change without notice.
  - Publication IPC-7351 is recommended for alternate designs.
  - This package is designed to be soldered to a thermal pad on the board. Refer to Application Note, Quad Flat-Pack Packages, Texas Instruments Literature No. SLUA271, and also the Product Data Sheets for specific thermal information, via requirements, and recommended board layout. These documents are available at [www.ti.com](http://www.ti.com) <<http://www.ti.com>>.
  - Laser cutting apertures with trapezoidal walls and also rounding corners will offer better paste release. Customers should contact their board assembly site for stencil design recommendations. Refer to IPC 7525 for stencil design considerations.
  - Customers should contact their board fabrication site for recommended solder mask tolerances and via tenting recommendations for vias placed in the thermal pad.



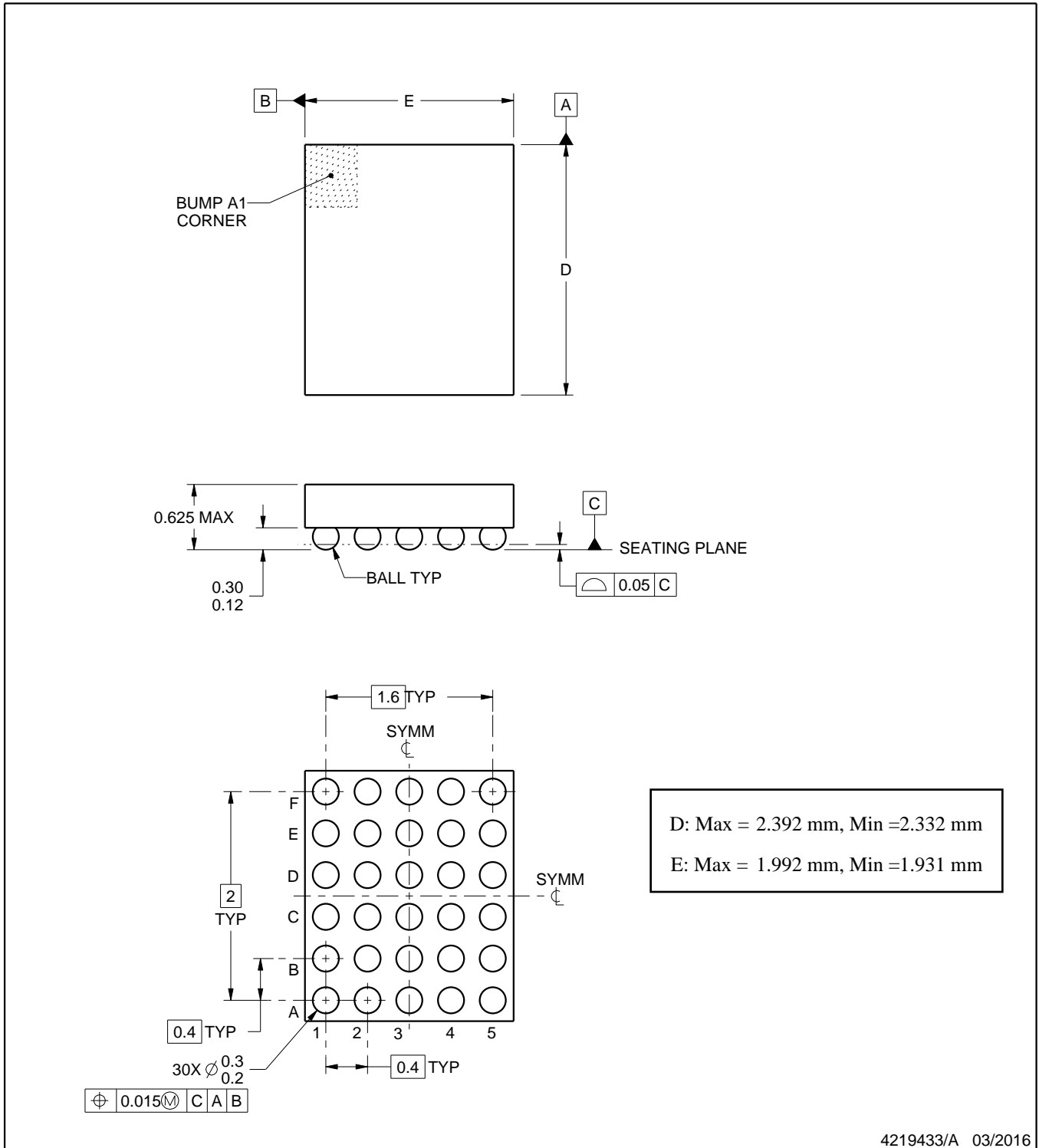
YFF0030



PACKAGE OUTLINE

DSBGA - 0.625 mm max height

DIE SIZE BALL GRID ARRAY



NOTES:

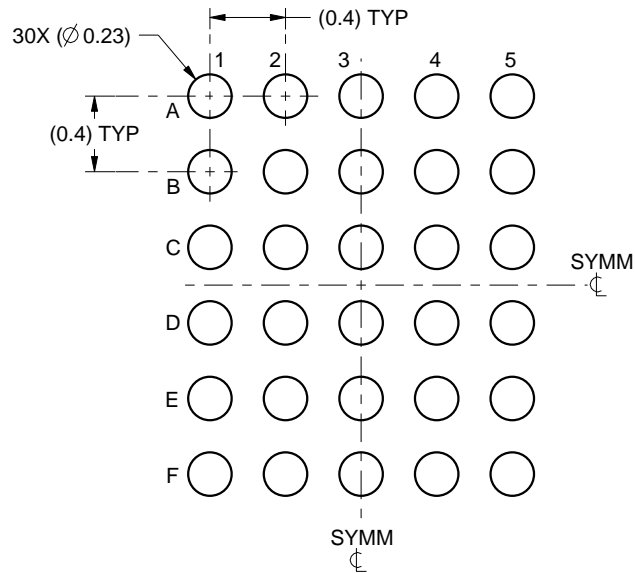
1. All linear dimensions are in millimeters. Any dimensions in parenthesis are for reference only. Dimensioning and tolerancing per ASME Y14.5M.
2. This drawing is subject to change without notice.

# EXAMPLE BOARD LAYOUT

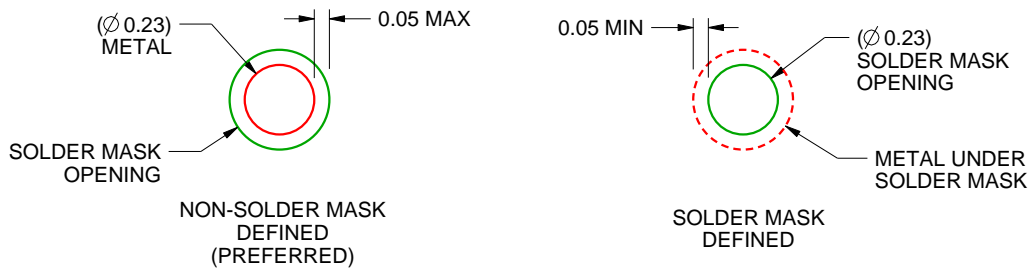
YFF0030

DSBGA - 0.625 mm max height

DIE SIZE BALL GRID ARRAY



LAND PATTERN EXAMPLE  
SCALE:25X



SOLDER MASK DETAILS  
NOT TO SCALE

4219433/A 03/2016

NOTES: (continued)

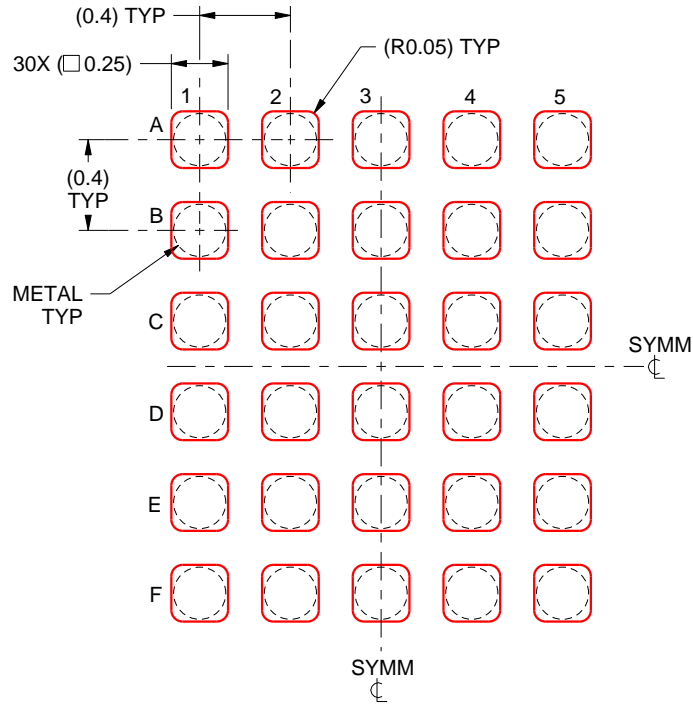
- Final dimensions may vary due to manufacturing tolerance considerations and also routing constraints. For more information, see Texas Instruments literature number SNVA009 ([www.ti.com/lit/snva009](http://www.ti.com/lit/snva009)).

# EXAMPLE STENCIL DESIGN

YFF0030

DSBGA - 0.625 mm max height

DIE SIZE BALL GRID ARRAY



SOLDER PASTE EXAMPLE  
BASED ON 0.1 mm THICK STENCIL  
SCALE:30X

4219433/A 03/2016

NOTES: (continued)

4. Laser cutting apertures with trapezoidal walls and rounded corners may offer better paste release.

## IMPORTANT NOTICE AND DISCLAIMER

TI PROVIDES TECHNICAL AND RELIABILITY DATA (INCLUDING DATASHEETS), DESIGN RESOURCES (INCLUDING REFERENCE DESIGNS), APPLICATION OR OTHER DESIGN ADVICE, WEB TOOLS, SAFETY INFORMATION, AND OTHER RESOURCES "AS IS" AND WITH ALL FAULTS, AND DISCLAIMS ALL WARRANTIES, EXPRESS AND IMPLIED, INCLUDING WITHOUT LIMITATION ANY IMPLIED WARRANTIES OF MERCHANTABILITY, FITNESS FOR A PARTICULAR PURPOSE OR NON-INFRINGEMENT OF THIRD PARTY INTELLECTUAL PROPERTY RIGHTS.

These resources are intended for skilled developers designing with TI products. You are solely responsible for (1) selecting the appropriate TI products for your application, (2) designing, validating and testing your application, and (3) ensuring your application meets applicable standards, and any other safety, security, regulatory or other requirements.

These resources are subject to change without notice. TI grants you permission to use these resources only for development of an application that uses the TI products described in the resource. Other reproduction and display of these resources is prohibited. No license is granted to any other TI intellectual property right or to any third party intellectual property right. TI disclaims responsibility for, and you fully indemnify TI and its representatives against any claims, damages, costs, losses, and liabilities arising out of your use of these resources.

TI's products are provided subject to [TI's Terms of Sale](#), [TI's General Quality Guidelines](#), or other applicable terms available either on [ti.com](http://ti.com) or provided in conjunction with such TI products. TI's provision of these resources does not expand or otherwise alter TI's applicable warranties or warranty disclaimers for TI products. Unless TI explicitly designates a product as custom or customer-specified, TI products are standard, catalog, general purpose devices.

TI objects to and rejects any additional or different terms you may propose.

Copyright © 2025, Texas Instruments Incorporated

Last updated 10/2025