

CD74AC540, CDx4ACT54x, CDx4AC541 Octal Buffer/Line Drivers, 3-State

1 Features

- SCR-latchup-resistant CMOS process and circuit design
- Speed of bipolar FAST[®]/AS/S with significantly reduced power consumption
- Balanced propagation delays
- AC types feature 1.5V to 5.5V operation and balanced noise immunity at 30% of the supply.
- $\pm 24\text{mA}$ output drive current
 - Fanout to 15 FAST[®]ICs
 - Drives 50 Ω transmission lines

2 Description

The CD54/74AC540, -541, and CD54/74ACT540, -541 octal buffer/line drivers use the RCA ADVANCED

CMOS technology. The CD54/74AC/ACT540 are inverting 3-state buffers having two active-LOW output enables. The CD54/74AC/ACT541 are non-inverting 3-state buffers having two active-LOW output enables.

Device Information

PART NUMBER	PACKAGE ⁽¹⁾	PACKAGE SIZE ⁽²⁾	BODY SIZE ⁽³⁾
CD74AC540, CDx4ACT54x, CDx4AC541	DW (SOIC, 20)	12.8mm x 10.3mm	12.8mm x 7.5mm
	DB (SSOP, 20)	7.2mm x 7.8mm	7.2mm x 5.3mm
	N (PDIP, 20)	24.33mm x 9.4mm	24.33mm x 6.35mm

- (1) For all available packages, see [Section 10](#).
- (2) The package size (length x width) is a nominal value and includes pins, where applicable.
- (3) The body size (length x width) is a nominal value and does not include pins.

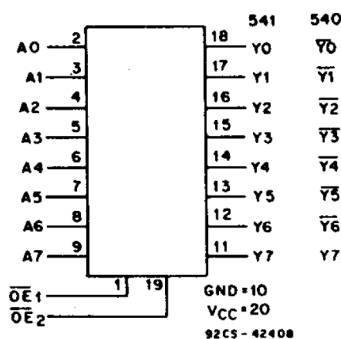

Functional Block Diagram

Table of Contents

1 Features	1	6.2 Functional Block Diagram.....	11
2 Description	1	6.3 Device Functional Modes.....	11
3 Pin Configuration and Functions	3	7 Application and Implementation	12
4 Specifications	4	7.1 Power Supply Recommendations.....	12
4.1 Absolute Maximum Ratings.....	4	7.2 Layout.....	12
4.2 ESD Ratings.....	4	8 Device and Documentation Support	13
4.3 Recommended Operating Conditions.....	4	8.1 Documentation Support (Analog).....	13
4.4 Thermal Information.....	4	8.2 Receiving Notification of Documentation Updates... 13	
4.5 Electrical Characteristics, AC Series.....	5	8.3 Support Resources.....	13
4.6 Electrical Characteristics, ACT Series.....	6	8.4 Trademarks.....	13
4.7 Switching Characteristics, AC Series.....	7	8.5 Electrostatic Discharge Caution.....	13
4.8 Switching Characteristics, ACT Series.....	8	8.6 Glossary.....	13
5 Parameter Measurement Information	9	9 Revision History	13
6 Detailed Description	11	10 Mechanical, Packaging, and Orderable Information	14
6.1 Overview.....	11		

3 Pin Configuration and Functions

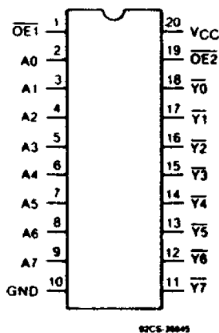

Figure 3-1. CDx4AC540, CDx4ACT540

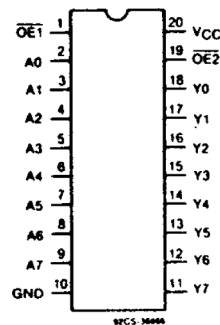

Figure 3-2. CDx4AC541, CDx4ACT541

Table 3-1. Pin Functions

PIN			
NO.	NAME	I/O ¹	DESCRIPTION
!MR	1	I	Master reset, active low
Q0	2	O	Output Q0
D0	3	I	Input D0
D1	4	I	Input D1
Q1	5	O	Output Q1
Q2	6	O	Output Q2
D2	7	I	Input D2
D3	8	I	Input D3
Q3	9	O	Output Q3
GND	10	-	Ground
CP	11	I	Clock, rising edge triggered
Q4	12	O	Output Q4
D4	13	I	Input D4
D5	14	I	Input D5
Q5	15	O	Output Q5
Q6	16	O	Output Q6
D6	17	I	Input D6
D7	18	I	Input D7
Q7	19	O	Output Q7
V _{CC}	20	-	Supply

1. I = input, O = output, P = power, FB = feedback, GND = ground, N/A = not applicable

4 Specifications

4.1 Absolute Maximum Ratings

over operating free-air temperature range (unless otherwise noted)

		MIN	MAX	UNIT
V_{CC}	Supply voltage	-0.5	6	V
I_{IK}	Input diode current	$(V_I < -0.5 \text{ or } V_I > V_{CC} + 0.5 \text{ V})$		± 20 mA
I_{OK}	Output diode current	$(V_O < -0.5 \text{ or } V_O > V_{CC} + 0.5 \text{ V})$		± 50 mA
I_O	Output source or sink current per output PIN	$(V_O > -0.5 \text{ or } V_O < V_{CC} + 0.5 \text{ V})$		± 50 mA
	V_{CC} or ground current, I_{CC} or I_{GND} ⁽¹⁾		± 100	mA
T_{stg}	Storage temperature	-65	+150	°C

(1) For up to 4 outputs per device: add ± 25 mA for each additional output.

4.2 ESD Ratings

		VALUE	UNIT
$V_{(ESD)}$	Electrostatic discharge	Human-body model (HBM), per ANSI/ESDA/ JEDEC JS-001 ¹	± 2000 V

(1) JEDEC document JEP155 states that 500-V HBM allows safe manufacturing with a standard ESD control process.

4.3 Recommended Operating Conditions

over operating free-air temperature range (unless otherwise noted)⁽¹⁾

		MIN	MAX	UNIT
V_{CC}	Supply voltage (For T_A = full package-temperature range)			
	AC types	1.5	5.5	V
	ACT types	4.5	5.5	V
V_I, V_O	Input or output voltage	0	V_{CC}	V
T_A	Operating temperature	-55	+125	°C
dt/dv	Input rise and fall slew rate			
	at 1.5V to 3V (AC types)	0	50	ns/V
	at 3.6V to 5.5V (AC types)	0	20	ns/V
	at 4.5V to 5.5V (ACT types)	0	10	ns/V

(1) Unless otherwise specified, all voltages are referenced to ground.

4.4 Thermal Information

THERMAL METRIC ⁽¹⁾		CD74AC540, CDx4ACT54x, CDx4AC541		UNIT
		N (PDIP)	DW (SOIC)	
		20 PINS	20 PINS	
$R_{\theta JA}$	Thermal Resistance	69	101.2	°C/W

(1) The package thermal impedance is calculated in accordance with JESD 51.



4.5 Electrical Characteristics, AC Series

PARAMETER	TEST CONDITIONS		V _{CC} (V)	(T _A) - °C						UNIT
				+25		-40 to +85		-55 to +125		
	V _I (V)	I _O (mA)		MIN	MAX	MIN	MAX	MIN	MAX	
V _{IH} High-level input voltage			1.5	1.2	—	1.2	—	1.2	—	V
			3	2.1	—	2.1	—	2.1	—	
			5.5	3.85	—	3.85	—	3.85	—	
V _{IL} Low-level input voltage			1.5	—	0.3	—	0.3	—	0.3	V
			3	—	0.9	—	0.9	—	0.9	
			5.5	—	1.65	—	1.65	—	1.65	
V _{OH} High-level output voltage	V _{IH} or V _{IL} (1), (2)	-0.05	1.5	1.4	—	1.4	—	1.4	—	V
		-0.05	3	2.9	—	2.9	—	2.9	—	
		-0.05	4.5	4.4	—	4.4	—	4.4	—	
		-4	3	2.58	—	2.48	—	2.4	—	
		-24	4.5	3.94	—	3.8	—	3.7	—	
		-75	5.5	—	—	3.85	—	—	—	
		-50	5.5	—	—	—	—	3.85	—	
V _{OL} Low-level output voltage	V _{IH} or V _{IL} (1), (2)	0.05	1.5	—	0.1	—	0.1	—	0.1	V
		0.05	3	—	0.1	—	0.1	—	0.1	
		0.05	4.5	—	0.1	—	0.1	—	0.1	
		12	3	—	0.36	—	0.44	—	0.5	
		24	4.5	—	0.36	—	0.44	—	0.5	
		75	5.5	—	—	—	1.65	—	—	
		50	5.5	—	—	—	—	—	1.65	
I _I Input leakage current	V _{CC} or GND		5.5	—	±0.1	—	±1	—	±1	μA
I _{OZ} 3-state leakage current	V _{IH} or V _{IL} V _O = V _{CC} or GND		5.5	—	±0.5	—	±5	—	±10	μA
I _{CC} Quiescent supply current, MSI	V _{CC} or GND	0	5.5	—	8	—	80	—	160	μA

- (1) Test one output at a time for a 1-second maximum duration. Measurement is made by forcing current and measuring voltage to minimize power dissipation.
(2) Test verifies a minimum 50-ohm transmission-line-drive capability at +85°C, 75 ohms at +125°C.

4.6 Electrical Characteristics, ACT Series

PARAMETER	TEST CONDITIONS		V _{CC} (V)	(T _A) - °C						UNIT	
				+25		-40 to +85		-55 to +125			
	V _I (V)	I _O (mA)		MIN	MAX	MIN	MAX	MIN	MAX		
V _{IH}	High-level input voltage		4.5 to 5.5	2	—	2	—	2	—	V	
V _{IL}	Low-level input voltage		4.5 to 5.5	—	0.8	—	0.8	—	0.8	V	
V _{OH}	High-level output voltage	V _{IH} or V _{IL} (1), (2)	-0.05	4.5	4.4	—	4.4	—	4.4	—	V
			-24	4.5	3.94	—	3.8	—	3.7	—	
			-75	5.5	—	—	3.85	—	—	—	
			-50	5.5	—	—	—	—	3.85	—	
V _{OL}	Low-level output voltage	V _{IH} or V _{IL} (1), (2)	0.05	4.5	—	0.1	—	0.1	—	0.1	V
			24	4.5	—	0.36	—	0.44	—	0.5	
			75	5.5	—	—	—	1.65	—	—	
			50	5.5	—	—	—	—	—	1.65	
I _I	Input leakage current	V _{CC} or GND	5.5	—	±0.1	—	±1	—	±1	μA	
I _{OZ}	3-state leakage current	V _{IH} or V _{IL} V _O = V _{CC} or GND	5.5	—	±0.5	—	±5	—	±10	μA	
I _{CC}	Quiescent supply current, MSI	V _{CC} or GND	0	5.5	—	8	—	80	—	160	μA
	Additional quiescent supply current per input pin	V _{CC} -2.1	4.5 to 5.5	—	2.4	—	28	—	3	mA	
ΔI _{CC}	TTL inputs high 1 unit load										

- (1) Test one output at a time for a 1-second maximum duration. Measurement is made by forcing current and measuring voltage to minimize power dissipation.
- (2) Test verifies a minimum 50-ohm transmission-line-drive capability at +85°C, 75 ohms at +125°C.

Table 4-1. Act Input Loading Table

INPUT	UNIT LOAD ⁽²⁾	
	540	541
DATA	1.42	0.5
OE1, OE2	1.3	1.3



4.7 Switching Characteristics, AC Series

$t_r, t_f = 3\text{ns}$, $C_L = 50\text{pF}$ (See Section 5)

PARAMETER	V_{CC} (V)	$(T_A) - ^\circ\text{C}$				UNIT
		-40 to +85		-55 to +125		
		MIN	MAX	MIN	MAX	
Propagation Delays: Data to Output						
	AC540					
t_{PLH}	1.5	—	77	—	85	
t_{PHL}	3.3*	2.4	8.6	2.4	9.5	ns
	5†	1.8	6.2	1.7	6.8	
	AC541					
t_{PLH}	1.5	—	89	—	98	
t_{PHL}	3.3	2.8	9.9	2.7	10.9	ns
	5	2.1	7.1	2	7.8	
	Enable, to Output to Output					
t_{PZL}	1.5	—	136	—	150	
t_{PZH}	3.3	4.6	16.4	4.5	18	ns
	5	3.1	10.9	3	12	
	Disable to Output to Output					
t_{PLZ}	1.5	—	136	—	150	
t_{PHZ}	3.3	3.9	13.6	3.8	15	ns
	5	3.1	10.9	3	12	
$C_{PD} \ddagger$	Power Dissipation Capacitance	AC540	—	60 Typ.	60 Typ.	pF
		AC541	—	60 Typ.	60 Typ.	
V_{OHV}	Min. (Valley) V_{OH}	During Switching of Other Outputs (Output Under Test Not Switching)	5	4 Typ. @ 25°C		V
V_{OLP}	Max. (Peak) V_{OL}	During Switching of Other Outputs (Output Under Test Not Switching)	5	1 Typ. @ 25°C		V
C_I	Input Capacitance		—	10	10	pF
C_O	3-State Output Capacitance		—	15	15	pF

4.8 Switching Characteristics, ACT Series

$t_r, t_f = 3\text{ns}$, $C_L = 50\text{pF}$ (See Section 5)

PARAMETER		V_{CC} (V)	$(T_A) - ^\circ\text{C}$				UNIT
			-40 to +85		-55 to =125		
			MIN	MAX	MIN	MAX	
t_{PLH} t_{PHL} t_{PZL} t_{PZH} t_{PLZ} t_{PHZ}	Propagation Delays:						
	Data to Output: ACT540	5 ⁽¹⁾	1.9	6.5	1.8	7.2	ns
	ACT541	5 ⁽¹⁾	2.1	7.5	2.1	8.2	ns
	Enable to Output	5	5	3.5	12.2	3.4	ns
	Disable to Output	5	3.5	12.2	3.4	13.4	ns
C_{PD} <small><i>CPD is used to determine the dynamic power consumption, per channel.</i></small>	Power Dissipation Capacitance ACT540/ ACT541	—	60 Typ.		60 Typ.		pF
V_{OHV}	Min. (Valley) V_{OH} During Switching of Other Outputs (Output Under Test Not Switching)	5	4 Typ. @ 25°C				V
V_{OLP}	Max. (Peak) V_{OL} During Switching of Other Outputs (Output Under Test Not Switching)	5	1 Typ. @ 25°C				V
C_I	Input Capacitance	—	—	10	—	10	pF
C_O	3-State Output Capacitance	—	—	15	—	15	pF

- (1) 5V: min. is @5.5 V
 (2) C_{PD} is used to determine the dynamic power consumption, per channel.

5 Parameter Measurement Information

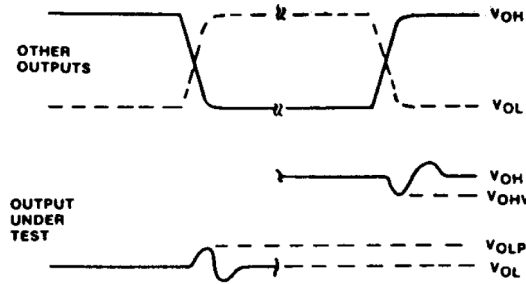

NOTES:

1. V_{OHV} AND V_{OLP} ARE MEASURED WITH RESPECT TO A GROUND REFERENCE NEAR THE OUTPUT UNDER TEST.
2. INPUT PULSES HAVE THE FOLLOWING CHARACTERISTICS:
 $PRR \leq 1$ MHz, $t_r = 3$ ns, $t_f = 3$ ns, SKEW 1 ns.
3. R.F. FIXTURE WITH 700-MHz DESIGN RULES REQUIRED. IC SHOULD BE SOLDERED INTO TEST BOARD AND BYPASSED WITH $0.1 \mu F$ CAPACITOR. SCOPE AND PROBES REQUIRE 700-MHz BANDWIDTH.

92CS-42406

- A. V_{OHV} AND V_{OLP} ARE MEASURED WITH RESPECT TO A GROUND REFERENCE NEAR THE OUTPUT UNDER TEST,
- B. INPUT PULSES HAVE THE FOLLOWING CHARACTERISTICS: $PRR \leq 1$ MHz, $t_r = 3$ ns, $t_f = 3$ ns, SKEW 1 ns.
- C. R.F. FIXTURE WITH 700-MHz DESIGN RULES REQUIRED. IC SHOULD BE SOLDERED INTO TEST BOARD AND BYPASSED WITH $0.1 \mu F$ CAPACITOR. SCOPE AND PROBES REQUIRE 700-MHz BANDWIDTH.
- D. 92CS-42406

Figure 5-1. Simultaneous Switching Transient Waveforms.

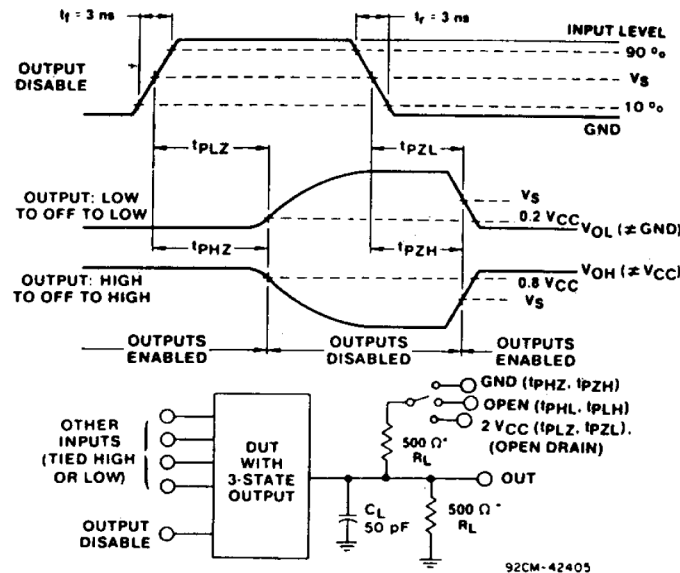

*FOR AC SERIES ONLY: WHEN $V_{CC} = 1.5$ V, $R_L = 1$ k Ω

Figure 5-2. Three-state Propagation Delay Waveforms and Test Circuit.

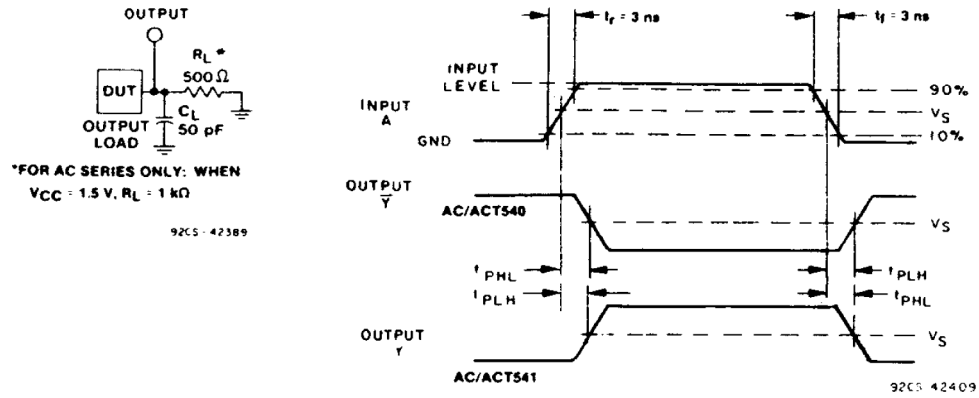

Figure 5-3. Propagation Delay Times and Test Circuit.

	CD54/74AC	CD54/74ACT
Input Level	V_{CC}	3 V
input Switching Voltage, V_S	$0.5 V_{CC}$	1.5 V
Output Switching Voltage, V_S	$0.5 V_{CC}$	$0.5 V_{CC}$

6 Detailed Description

6.1 Overview

The CD74AC540, -541, and CD74ACT540, -541 are supplied in 20-lead dual-in-line plastic packages (E suffix) and in 20-lead dual-in-line small-outline plastic packages (M suffix). Both package types are operable over the following temperature ranges: Industrial (-40 to +85°C) and Extended Industrial/Military (-55 to +125°C).

The CD54AC540, -541, and CD54ACT540, -541, available in chip form (H suffix), are operable over the -55 to +125°C temperature range.

6.2 Functional Block Diagram

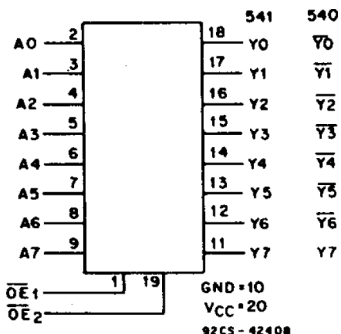

6.3 Device Functional Modes

Table 6-1. Truth Table

CD54/74AC/ACT540		
INPUTS		OUTPUTS
$\overline{OE1}, OE1$	A	Y
L	L	H
L	H	L
H	X	Z

Table 6-2. Truth Table

CD54/74AC/ACT541		
INPUTS		OUTPUTS
$\overline{OE1}, \overline{OE2}$	A	Y
L	L	L
L	H	H
H	X	Z

7 Application and Implementation

Note

Information in the following applications sections is not part of the TI component specification, and TI does not warrant its accuracy or completeness. TI's customers are responsible for determining suitability of components for their purposes, as well as validating and testing their design implementation to confirm system functionality.

7.1 Power Supply Recommendations

The power supply can be any voltage between the min and max supply voltage rating located in [Section 4.3](#).

Each V_{CC} terminal should have a good bypass capacitor to prevent power disturbance. For devices with a single supply, TI recommends 0.1 μF and if there are multiple V_{CC} terminals, then TI recommends .01 μF or .022 μF for each power terminal. It is okay to parallel multiple bypass capacitors to reject different frequencies of noise. A 0.1 μF and 1 μF are commonly used in parallel. The bypass capacitor should be installed as close to the power terminal as possible for best results.

7.2 Layout

7.2.1 Layout Guidelines

When using multiple bit logic devices inputs should not ever float. In many cases, functions or parts of functions of digital logic devices are unused, for example, when only two inputs of a triple-input AND gate are used or only three of the four buffer gates are used. Such input pins should not be left unconnected because the undefined voltages at the outside connections result in undefined operational states. Specified below are the rules that must be observed under all circumstances. All unused inputs of digital logic devices must be connected to a high or low bias to prevent them from floating. The logic level that should be applied to any particular unused input depends on the function of the device. Generally they will be tied to GND or V_{CC} whichever make more sense or is more convenient. Floating outputs is generally acceptable, unless the part is a transceiver. If the transceiver has an output enable pin it will disable the outputs section of the part when asserted. This will not disable the input section of the I.O's so they also cannot float when disabled.

8 Device and Documentation Support

8.1 Documentation Support (Analog)

8.1.1 Related Documentation

The table below lists quick access links. Categories include technical documents, support and community resources, tools and software, and quick access to sample or buy.

Table 8-1. Related Links

PARTS	PRODUCT FOLDER	SAMPLE & BUY	TECHNICAL DOCUMENTS	TOOLS & SOFTWARE	SUPPORT & COMMUNITY
CD74AC540	Click here	Click here	Click here	Click here	Click here
CD54AC541	Click here	Click here	Click here	Click here	Click here
CD74AC541	Click here	Click here	Click here	Click here	Click here
CD54ACT540	Click here	Click here	Click here	Click here	Click here
CD74ACT540	Click here	Click here	Click here	Click here	Click here
CD54ACT541	Click here	Click here	Click here	Click here	Click here
CD74ACT541	Click here	Click here	Click here	Click here	Click here

8.2 Receiving Notification of Documentation Updates

To receive notification of documentation updates, navigate to the device product folder on ti.com. Click on *Notifications* to register and receive a weekly digest of any product information that has changed. For change details, review the revision history included in any revised document.

8.3 Support Resources

[TI E2E™ support forums](#) are an engineer's go-to source for fast, verified answers and design help — straight from the experts. Search existing answers or ask your own question to get the quick design help you need.

Linked content is provided "AS IS" by the respective contributors. They do not constitute TI specifications and do not necessarily reflect TI's views; see TI's [Terms of Use](#).

8.4 Trademarks

TI E2E™ is a trademark of Texas Instruments.
All trademarks are the property of their respective owners.

8.5 Electrostatic Discharge Caution



This integrated circuit can be damaged by ESD. Texas Instruments recommends that all integrated circuits be handled with appropriate precautions. Failure to observe proper handling and installation procedures can cause damage.

ESD damage can range from subtle performance degradation to complete device failure. Precision integrated circuits may be more susceptible to damage because very small parametric changes could cause the device not to meet its published specifications.

8.6 Glossary

[TI Glossary](#) This glossary lists and explains terms, acronyms, and definitions.

9 Revision History

NOTE: Page numbers for previous revisions may differ from page numbers in the current version.

Changes from Revision A (December 1998) to Revision B (May 2024)	Page
• Added <i>Device Information</i> table, <i>Pin Functions</i> table, <i>ESD Ratings</i> table, <i>Thermal Information</i> table, <i>Device Functional Modes</i> , <i>Application and Implementation</i> section, <i>Device and Documentation Support</i> section, and <i>Mechanical, Packaging, and Orderable Information</i> section	1
• Updated θ_{JA} value: DW = 58 to 101.2, all values in °C/W	4

10 Mechanical, Packaging, and Orderable Information

The following pages include mechanical, packaging, and orderable information. This information is the most current data available for the designated devices. This data is subject to change without notice and revision of this document. For browser-based versions of this data sheet, refer to the left-hand navigation.

PACKAGING INFORMATION

Orderable part number	Status (1)	Material type (2)	Package Pins	Package qty Carrier	RoHS (3)	Lead finish/ Ball material (4)	MSL rating/ Peak reflow (5)	Op temp (°C)	Part marking (6)
CD54AC541F3A	Active	Production	CDIP (J) 20	20 TUBE	No	SNPB	N/A for Pkg Type	-55 to 125	CD54AC541F3A
CD54AC541F3A.A	Active	Production	CDIP (J) 20	20 TUBE	No	SNPB	N/A for Pkg Type	-55 to 125	CD54AC541F3A
CD54ACT540F3A	Active	Production	CDIP (J) 20	20 TUBE	No	SNPB	N/A for Pkg Type	-55 to 125	CD54ACT540F3A
CD54ACT540F3A.A	Active	Production	CDIP (J) 20	20 TUBE	No	SNPB	N/A for Pkg Type	-55 to 125	CD54ACT540F3A
CD54ACT541F3A	Active	Production	CDIP (J) 20	20 TUBE	No	SNPB	N/A for Pkg Type	-55 to 125	CD54ACT541F3A
CD54ACT541F3A.A	Active	Production	CDIP (J) 20	20 TUBE	No	SNPB	N/A for Pkg Type	-55 to 125	CD54ACT541F3A
CD74AC540M	Obsolete	Production	SOIC (DW) 20	-	-	Call TI	Call TI	-55 to 125	AC540M
CD74AC540M96	Active	Production	SOIC (DW) 20	2000 LARGE T&R	Yes	NIPDAU	Level-1-260C-UNLIM	-	AC540M
CD74AC540M96.A	Active	Production	SOIC (DW) 20	2000 LARGE T&R	Yes	NIPDAU	Level-1-260C-UNLIM	-55 to 125	AC540M
CD74AC541E	Active	Production	PDIP (N) 20	20 TUBE	Yes	NIPDAU	N/A for Pkg Type	-55 to 125	CD74AC541E
CD74AC541E.A	Active	Production	PDIP (N) 20	20 TUBE	Yes	NIPDAU	N/A for Pkg Type	-55 to 125	CD74AC541E
CD74AC541EE4	Active	Production	PDIP (N) 20	20 TUBE	Yes	NIPDAU	N/A for Pkg Type	-55 to 125	CD74AC541E
CD74AC541M96	Active	Production	SOIC (DW) 20	2000 LARGE T&R	Yes	NIPDAU	Level-1-260C-UNLIM	-55 to 125	(AC541, AC541M)
CD74AC541M96.A	Active	Production	SOIC (DW) 20	2000 LARGE T&R	Yes	NIPDAU	Level-1-260C-UNLIM	-55 to 125	(AC541, AC541M)
CD74AC541M96E4	Active	Production	SOIC (DW) 20	2000 LARGE T&R	Yes	NIPDAU	Level-1-260C-UNLIM	-55 to 125	(AC541, AC541M)
CD74AC541SM96	Active	Production	SSOP (DB) 20	2000 LARGE T&R	Yes	NIPDAU	Level-1-260C-UNLIM	-55 to 125	AC541SM
CD74AC541SM96.A	Active	Production	SSOP (DB) 20	2000 LARGE T&R	Yes	NIPDAU	Level-1-260C-UNLIM	-55 to 125	AC541SM
CD74ACT540E	Active	Production	PDIP (N) 20	20 TUBE	Yes	NIPDAU	N/A for Pkg Type	-55 to 125	CD74ACT540E
CD74ACT540E.A	Active	Production	PDIP (N) 20	20 TUBE	Yes	NIPDAU	N/A for Pkg Type	-55 to 125	CD74ACT540E
CD74ACT540M	Obsolete	Production	SOIC (DW) 20	-	-	Call TI	Call TI	-55 to 125	ACT540M
CD74ACT540M96	Active	Production	SOIC (DW) 20	2000 LARGE T&R	Yes	NIPDAU	Level-1-260C-UNLIM	-55 to 125	ACT540M
CD74ACT540M96.A	Active	Production	SOIC (DW) 20	2000 LARGE T&R	Yes	NIPDAU	Level-1-260C-UNLIM	-55 to 125	ACT540M
CD74ACT541E	Active	Production	PDIP (N) 20	20 TUBE	Yes	NIPDAU	N/A for Pkg Type	-55 to 125	CD74ACT541E
CD74ACT541E.A	Active	Production	PDIP (N) 20	20 TUBE	Yes	NIPDAU	N/A for Pkg Type	-55 to 125	CD74ACT541E
CD74ACT541EE4	Active	Production	PDIP (N) 20	20 TUBE	Yes	NIPDAU	N/A for Pkg Type	-55 to 125	CD74ACT541E
CD74ACT541M96	Active	Production	SOIC (DW) 20	2000 LARGE T&R	Yes	NIPDAU	Level-1-260C-UNLIM	-55 to 125	ACT541M
CD74ACT541M96.A	Active	Production	SOIC (DW) 20	2000 LARGE T&R	Yes	NIPDAU	Level-1-260C-UNLIM	-55 to 125	ACT541M
CD74ACT541M96E4	Active	Production	SOIC (DW) 20	2000 LARGE T&R	Yes	NIPDAU	Level-1-260C-UNLIM	-55 to 125	ACT541M
CD74ACT541M96G4	Active	Production	SOIC (DW) 20	2000 LARGE T&R	Yes	NIPDAU	Level-1-260C-UNLIM	-55 to 125	ACT541M

Orderable part number	Status (1)	Material type (2)	Package Pins	Package qty Carrier	RoHS (3)	Lead finish/ Ball material (4)	MSL rating/ Peak reflow (5)	Op temp (°C)	Part marking (6)
CD74ACT541SM96	Active	Production	SSOP (DB) 20	2000 LARGE T&R	Yes	NIPDAU	Level-1-260C-UNLIM	-55 to 125	ACT541SM
CD74ACT541SM96.A	Active	Production	SSOP (DB) 20	2000 LARGE T&R	Yes	NIPDAU	Level-1-260C-UNLIM	-55 to 125	ACT541SM

(1) **Status:** For more details on status, see our [product life cycle](#).

(2) **Material type:** When designated, preproduction parts are prototypes/experimental devices, and are not yet approved or released for full production. Testing and final process, including without limitation quality assurance, reliability performance testing, and/or process qualification, may not yet be complete, and this item is subject to further changes or possible discontinuation. If available for ordering, purchases will be subject to an additional waiver at checkout, and are intended for early internal evaluation purposes only. These items are sold without warranties of any kind.

(3) **RoHS values:** Yes, No, RoHS Exempt. See the [TI RoHS Statement](#) for additional information and value definition.

(4) **Lead finish/Ball material:** Parts may have multiple material finish options. Finish options are separated by a vertical ruled line. Lead finish/Ball material values may wrap to two lines if the finish value exceeds the maximum column width.

(5) **MSL rating/Peak reflow:** The moisture sensitivity level ratings and peak solder (reflow) temperatures. In the event that a part has multiple moisture sensitivity ratings, only the lowest level per JEDEC standards is shown. Refer to the shipping label for the actual reflow temperature that will be used to mount the part to the printed circuit board.

(6) **Part marking:** There may be an additional marking, which relates to the logo, the lot trace code information, or the environmental category of the part.

Multiple part markings will be inside parentheses. Only one part marking contained in parentheses and separated by a "-" will appear on a part. If a line is indented then it is a continuation of the previous line and the two combined represent the entire part marking for that device.

Important Information and Disclaimer: The information provided on this page represents TI's knowledge and belief as of the date that it is provided. TI bases its knowledge and belief on information provided by third parties, and makes no representation or warranty as to the accuracy of such information. Efforts are underway to better integrate information from third parties. TI has taken and continues to take reasonable steps to provide representative and accurate information but may not have conducted destructive testing or chemical analysis on incoming materials and chemicals. TI and TI suppliers consider certain information to be proprietary, and thus CAS numbers and other limited information may not be available for release.

In no event shall TI's liability arising out of such information exceed the total purchase price of the TI part(s) at issue in this document sold by TI to Customer on an annual basis.

OTHER QUALIFIED VERSIONS OF CD54AC541, CD54ACT540, CD54ACT541, CD74AC541, CD74ACT540, CD74ACT541 :

- Catalog : [CD74AC541](#), [CD74ACT540](#), [CD74ACT541](#)

- Military : [CD54AC541](#), [CD54ACT540](#), [CD54ACT541](#)

NOTE: Qualified Version Definitions:

- Catalog - TI's standard catalog product
- Military - QML certified for Military and Defense Applications

TAPE AND REEL INFORMATION

QUADRANT ASSIGNMENTS FOR PIN 1 ORIENTATION IN TAPE

*All dimensions are nominal

Device	Package Type	Package Drawing	Pins	SPQ	Reel Diameter (mm)	Reel Width W1 (mm)	A0 (mm)	B0 (mm)	K0 (mm)	P1 (mm)	W (mm)	Pin1 Quadrant
CD74AC540M96	SOIC	DW	20	2000	330.0	24.4	10.8	13.3	2.7	12.0	24.0	Q1
CD74AC541M96	SOIC	DW	20	2000	330.0	24.4	10.8	13.3	2.7	12.0	24.0	Q1
CD74AC541M96	SOIC	DW	20	2000	330.0	24.4	10.9	13.3	2.7	12.0	24.0	Q1
CD74AC541SM96	SSOP	DB	20	2000	330.0	16.4	8.2	7.5	2.5	12.0	16.0	Q1
CD74ACT540M96	SOIC	DW	20	2000	330.0	24.4	10.9	13.3	2.7	12.0	24.0	Q1
CD74ACT540M96	SOIC	DW	20	2000	330.0	24.4	10.8	13.3	2.7	12.0	24.0	Q1
CD74ACT541M96	SOIC	DW	20	2000	330.0	24.4	10.8	13.3	2.7	12.0	24.0	Q1
CD74ACT541M96	SOIC	DW	20	2000	330.0	24.4	10.9	13.3	2.7	12.0	24.0	Q1
CD74ACT541SM96	SSOP	DB	20	2000	330.0	16.4	8.2	7.5	2.5	12.0	16.0	Q1

TAPE AND REEL BOX DIMENSIONS

*All dimensions are nominal

Device	Package Type	Package Drawing	Pins	SPQ	Length (mm)	Width (mm)	Height (mm)
CD74AC540M96	SOIC	DW	20	2000	356.0	356.0	45.0
CD74AC541M96	SOIC	DW	20	2000	356.0	356.0	45.0
CD74AC541M96	SOIC	DW	20	2000	356.0	356.0	45.0
CD74AC541SM96	SSOP	DB	20	2000	353.0	353.0	32.0
CD74ACT540M96	SOIC	DW	20	2000	356.0	356.0	45.0
CD74ACT540M96	SOIC	DW	20	2000	356.0	356.0	45.0
CD74ACT541M96	SOIC	DW	20	2000	356.0	356.0	45.0
CD74ACT541M96	SOIC	DW	20	2000	356.0	356.0	45.0
CD74ACT541SM96	SSOP	DB	20	2000	353.0	353.0	32.0

TUBE

*All dimensions are nominal

Device	Package Name	Package Type	Pins	SPQ	L (mm)	W (mm)	T (μm)	B (mm)
CD74AC541E	N	PDIP	20	20	506	13.97	11230	4.32
CD74AC541E.A	N	PDIP	20	20	506	13.97	11230	4.32
CD74AC541EE4	N	PDIP	20	20	506	13.97	11230	4.32
CD74ACT540E	N	PDIP	20	20	506	13.97	11230	4.32
CD74ACT540E.A	N	PDIP	20	20	506	13.97	11230	4.32
CD74ACT541E	N	PDIP	20	20	506	13.97	11230	4.32
CD74ACT541E.A	N	PDIP	20	20	506	13.97	11230	4.32
CD74ACT541EE4	N	PDIP	20	20	506	13.97	11230	4.32

DB0020A



PACKAGE OUTLINE

SSOP - 2 mm max height

SMALL OUTLINE PACKAGE



4214851/B 08/2019

NOTES:

1. All linear dimensions are in millimeters. Any dimensions in parenthesis are for reference only. Dimensioning and tolerancing per ASME Y14.5M.
2. This drawing is subject to change without notice.
3. This dimension does not include mold flash, protrusions, or gate burrs. Mold flash, protrusions, or gate burrs shall not exceed 0.15 mm per side.
4. This dimension does not include interlead flash. Interlead flash shall not exceed 0.25 mm per side.
5. Reference JEDEC registration MO-150.

EXAMPLE BOARD LAYOUT

DB0020A

SSOP - 2 mm max height

SMALL OUTLINE PACKAGE



LAND PATTERN EXAMPLE
EXPOSED METAL SHOWN
SCALE: 10X



4214851/B 08/2019

NOTES: (continued)

- 6. Publication IPC-7351 may have alternate designs.
- 7. Solder mask tolerances between and around signal pads can vary based on board fabrication site.

EXAMPLE STENCIL DESIGN

DB0020A

SSOP - 2 mm max height

SMALL OUTLINE PACKAGE



SOLDER PASTE EXAMPLE
BASED ON 0.125 mm THICK STENCIL
SCALE: 10X

4214851/B 08/2019

NOTES: (continued)

8. Laser cutting apertures with trapezoidal walls and rounded corners may offer better paste release. IPC-7525 may have alternate design recommendations.
9. Board assembly site may have different recommendations for stencil design.

N (R-PDIP-T**)

PLASTIC DUAL-IN-LINE PACKAGE

16 PINS SHOWN



- NOTES:
- A. All linear dimensions are in inches (millimeters).
 - B. This drawing is subject to change without notice.
 - $\triangle C$ Falls within JEDEC MS-001, except 18 and 20 pin minimum body length (Dim A).
 - $\triangle D$ The 20 pin end lead shoulder width is a vendor option, either half or full width.

DW0020A



PACKAGE OUTLINE

SOIC - 2.65 mm max height

SOIC



4220724/A 05/2016

NOTES:

1. All linear dimensions are in millimeters. Dimensions in parenthesis are for reference only. Dimensioning and tolerancing per ASME Y14.5M.
2. This drawing is subject to change without notice.
3. This dimension does not include mold flash, protrusions, or gate burrs. Mold flash, protrusions, or gate burrs shall not exceed 0.15 mm per side.
4. This dimension does not include interlead flash. Interlead flash shall not exceed 0.43 mm per side.
5. Reference JEDEC registration MS-013.

EXAMPLE BOARD LAYOUT

DW0020A

SOIC - 2.65 mm max height

SOIC



LAND PATTERN EXAMPLE
SCALE:6X



SOLDER MASK DETAILS

4220724/A 05/2016

NOTES: (continued)

- 6. Publication IPC-7351 may have alternate designs.
- 7. Solder mask tolerances between and around signal pads can vary based on board fabrication site.

EXAMPLE STENCIL DESIGN

DW0020A

SOIC - 2.65 mm max height

SOIC



SOLDER PASTE EXAMPLE
BASED ON 0.125 mm THICK STENCIL
SCALE:6X

4220724/A 05/2016

NOTES: (continued)

8. Laser cutting apertures with trapezoidal walls and rounded corners may offer better paste release. IPC-7525 may have alternate design recommendations.
9. Board assembly site may have different recommendations for stencil design.

IMPORTANT NOTICE AND DISCLAIMER

TI PROVIDES TECHNICAL AND RELIABILITY DATA (INCLUDING DATASHEETS), DESIGN RESOURCES (INCLUDING REFERENCE DESIGNS), APPLICATION OR OTHER DESIGN ADVICE, WEB TOOLS, SAFETY INFORMATION, AND OTHER RESOURCES "AS IS" AND WITH ALL FAULTS, AND DISCLAIMS ALL WARRANTIES, EXPRESS AND IMPLIED, INCLUDING WITHOUT LIMITATION ANY IMPLIED WARRANTIES OF MERCHANTABILITY, FITNESS FOR A PARTICULAR PURPOSE OR NON-INFRINGEMENT OF THIRD PARTY INTELLECTUAL PROPERTY RIGHTS.

These resources are intended for skilled developers designing with TI products. You are solely responsible for (1) selecting the appropriate TI products for your application, (2) designing, validating and testing your application, and (3) ensuring your application meets applicable standards, and any other safety, security, regulatory or other requirements.

These resources are subject to change without notice. TI grants you permission to use these resources only for development of an application that uses the TI products described in the resource. Other reproduction and display of these resources is prohibited. No license is granted to any other TI intellectual property right or to any third party intellectual property right. TI disclaims responsibility for, and you fully indemnify TI and its representatives against any claims, damages, costs, losses, and liabilities arising out of your use of these resources.

TI's products are provided subject to [TI's Terms of Sale](#), [TI's General Quality Guidelines](#), or other applicable terms available either on [ti.com](#) or provided in conjunction with such TI products. TI's provision of these resources does not expand or otherwise alter TI's applicable warranties or warranty disclaimers for TI products. Unless TI explicitly designates a product as custom or customer-specified, TI products are standard, catalog, general purpose devices.

TI objects to and rejects any additional or different terms you may propose.

Copyright © 2026, Texas Instruments Incorporated

Last updated 10/2025