

CDCE6214 Ultra-Low Power Clock Generator With One PLL, Four Differential Outputs, Two Inputs, and Internal EEPROM

1 Features

- Configurable high performance, low-power, frac-N PLL with RMS jitter with spurs (12kHz – 20MHz, $F_{out} > 100\text{MHz}$) as:
 - Integer mode:
 - Differential output: 350fs typical (typ.), 600fs maximum (max)
 - LVCMOS output: 1.05ps typ., 1.5ps max
 - Fractional mode:
 - Differential output: 1.7ps typ., 2.1ps max
 - LVCMOS output: 2.0ps typ., 4.0ps max
- Supports PCIe Gen1/2/3/4 with SSC and Gen 1/2/3/4/5/6 without SSC
- Typ. power consumption: 65mA for 4-output channel, 23mA for 1-output channel.
- Universal clock input
 - Differential AC-coupled or LVCMOS: 10MHz to 200MHz
 - Crystal: 10MHz to 50MHz
- Flexible output clock distribution
 - Four channel dividers: Up to five unique output frequencies from 24kHz to 328.125MHz
 - Combination of LVDS-like, LP-HCSL or LVCMOS outputs on OUT0 – OUT4 pins
 - Glitchless output divider switching and output channel synchronization
 - Individual output enable through GPIO and register
- Frequency margining options
 - DCO mode: frequency increment/decrement with 10ppb or less step-size
- Fully-integrated, configurable loop bandwidth: 100kHz to 1.6MHz
- Single or mixed supply for level translation: 1.8V, 2.5V, 3.3V
- Configurable GPIOs and flexible configuration options
 - I²C-compatible interface: up to 400kHz
 - Integrated EEPROM with two pages and external select pin. In-situ programming allowed.
- Supports 100Ω systems
- Low electromagnetic emissions
- Small footprint: 24-pin VQFN (4mm × 4mm)

2 Applications

- PCIe Gen 1 - Gen 6 clocking
- [Data center & enterprise computing](#)
- [PC & notebooks](#)
- [Enterprise machine - multifunction printer](#)
- [Test & measurement - handheld equipment](#)

3 Description

The CDCE6214 is a four-channel, ultra-low power, medium grade jitter, clock generator that can generate five independent clock outputs selectable between various modes of drivers. The input source can be a single-ended or differential input clock source, or a crystal. The CDCE6214 features a frac-N PLL to synthesize unrelated base frequency from any input frequency. The CDCE6214 can be configured through the I²C interface. In the absence of the serial interface, the GPIO pins can be used in Pin Mode to configure the product into distinctive configurations.

The CDCE6214 can be configured through the I²C interface in fall-back mode only. In the absence of the serial interface, the GPIO pins can be used in pin mode to configure the product into distinctive configurations.

On-chip EEPROM can be used to change the configuration, which is pre-selectable through the pins. The device provides frequency margining options with glitch-free operation to support system design verification tests (DVT) and Ethernet Audio-Video Bridging (eAVB). Fine frequency margining is available on any output channel by steering the fractional feedback divider in DCO mode.

Internal power conditioning provides excellent power supply ripple rejection (PSRR), reducing the cost and complexity of the power delivery network. The analog and digital core blocks operate from either a 1.8V, 2.5V, or 3.3V ±5% supply, and output blocks operate from a 1.8V, 2.5V, or 3.3V ±5% supply.

The CDCE6214 enables high-performance clock trees from a single reference at ultra-low power with a small footprint. The factory- and user-programmable EEPROM features make the CDCE6214 an easy-to-use, instant on clocking device with a low power consumption.



Table 3-1. Package Information

PART NUMBER	PACKAGE ⁽¹⁾	PACKAGE SIZE ⁽²⁾
CDCE6214	RGE (VQFN, 24)	4.00mm × 4.00mm

- (1) For more information, see [Section 11](#).
- (2) The package size (length × width) is a nominal value and includes pins, where applicable.

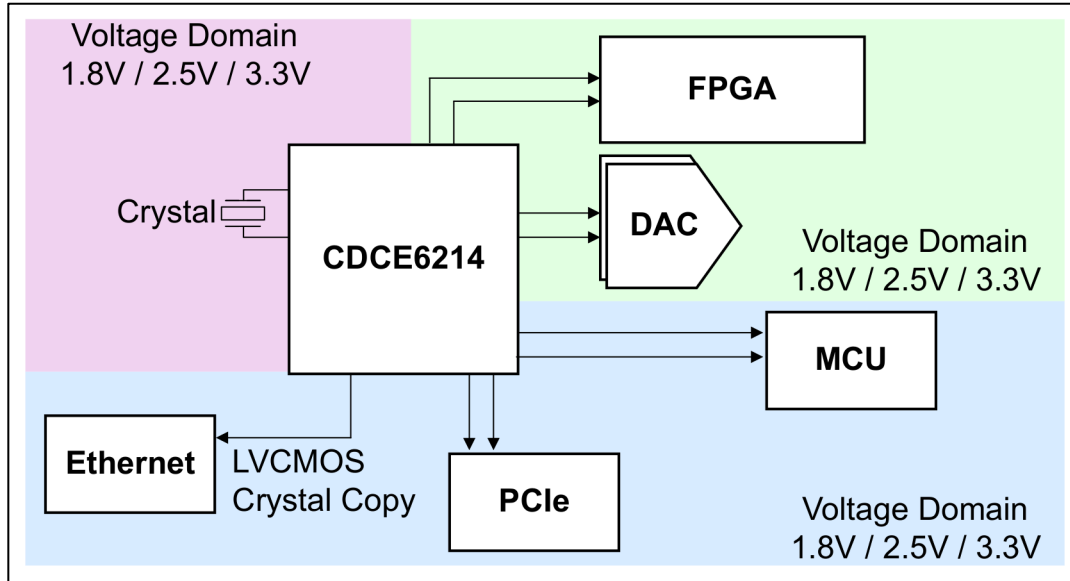

Application Example CDCE6214

Table of Contents

1 Features	1	5.25 Typical Characteristics.....	14
2 Applications	1	6 Parameter Measurement Information	16
3 Description	1	6.1 Reference Inputs.....	16
4 Pin Configuration and Functions	4	6.2 Outputs.....	16
5 Specifications	7	6.3 Serial Interface.....	17
5.1 Absolute Maximum Ratings.....	7	6.4 PSNR Test.....	17
5.2 ESD Ratings.....	7	6.5 Clock Interfacing and Termination.....	18
5.3 Recommended Operating Conditions.....	7	7 Detailed Description	19
5.4 Thermal Information.....	7	7.1 Overview.....	19
5.5 EEPROM Characteristics.....	8	7.2 Functional Block Diagram.....	19
5.6 Reference Input, Single-Ended Characteristics.....	8	7.3 Feature Description.....	19
5.7 Reference Input, Differential Characteristics.....	8	7.4 Device Functional Modes.....	33
5.8 Reference Input, Crystal Mode Characteristics.....	8	7.5 Programming.....	34
5.9 General-Purpose Input Characteristics.....	9	8 Application and Implementation	41
5.10 Triple Level Input Characteristics.....	9	8.1 Application Information.....	41
5.11 Logic Output Characteristics.....	9	8.2 Typical Application.....	42
5.12 Phase Locked Loop Characteristics.....	9	8.3 Power Supply Recommendations.....	43
5.13 Closed-Loop Output Jitter Characteristics.....	10	8.4 Layout.....	44
5.14 Input and Output Isolation.....	10	9 Device and Documentation Support	46
5.15 Buffer Mode Characteristics.....	10	9.1 Device Support.....	46
5.16 PCIe Spread Spectrum Generator.....	11	9.2 Documentation Support.....	46
5.17 LVCMOS Output Characteristics.....	11	9.3 Receiving Notification of Documentation Updates.....	46
5.18 LP-HCSL Output Characteristics.....	11	9.4 Support Resources.....	46
5.19 LVDS Output Characteristics.....	12	9.5 Trademarks.....	46
5.20 Output Synchronization Characteristics.....	12	9.6 Electrostatic Discharge Caution.....	46
5.21 Power-On Reset Characteristics.....	13	9.7 Glossary.....	46
5.22 I ² C-Compatible Serial Interface Characteristics.....	13	10 Revision History	46
5.23 Timing Requirements, I ² C-Compatible Serial Interface.....	13	11 Mechanical, Packaging, and Orderable Information	47
5.24 Power Supply Characteristics.....	14		

4 Pin Configuration and Functions

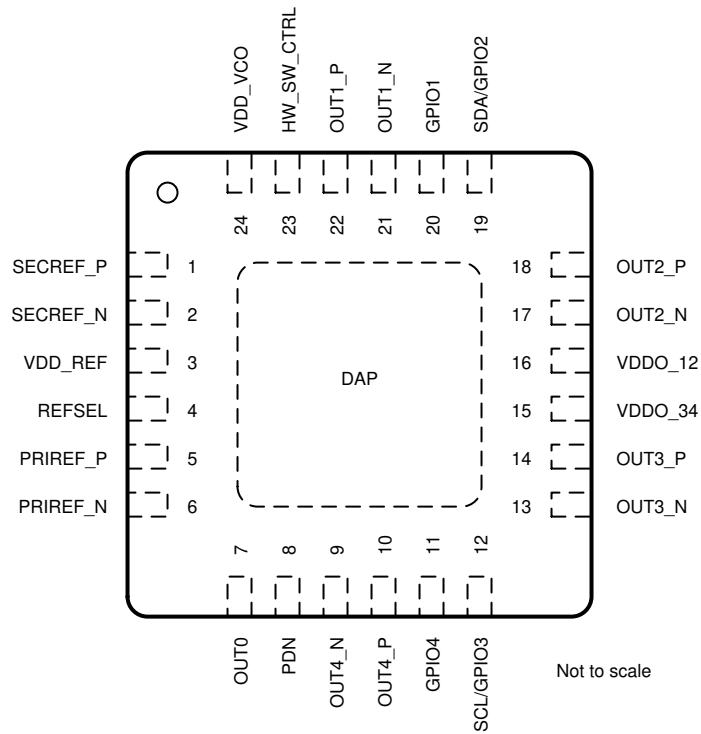

Figure 4-1. RGE Package 24-Pin VQFN Top View

Table 4-1. Pin Functions

PIN		Type ⁽¹⁾	DESCRIPTION
NAME	NO.		
POWER			
DAP	—	G	Die Attach Pad. The DAP is an electrical connection and provides a thermal dissipation path. For proper electrical and thermal performance of the device, the DAP must be connected to PCB ground plane.
VDD_REF	3	P	1.8-V, 2.5-V, or 3.3-V Power Supply for Reference Input and Digital.
VDD_VCO	24	P	1.8-V, 2.5-V, or 3.3-V Power Supply for PLL/VCO.
VDDO_12	16	P	1.8-V, 2.5-V, or 3.3-V Power Supply for OUT1 and OUT2 channels
VDDO_34	15	P	1.8-V, 2.5-V, or 3.3-V Power Supply for OUT0, OUT3, and OUT4 channels
INPUT BLOCK			
HW_SW_C TRL	23	I, RPUPD	Manual selection pin for EEPROM pages (tri-state). Weak Pullup/Pulldown. R _P U = 50 kΩ. R _P D = 50 kΩ.
PRIREF_P	5	I	Primary reference clock. Accepts a differential or single-ended input. Input pins need AC-coupling capacitors and internally biased in differential mode. For LVCMOS, input must be provided on PRIREF_P and the non-driven input pin must be pulled down to ground. Internal biasing for differential mode is disabled in single-ended mode.
PRIREF_N	6	I	
REFSEL	4	I, RPUPD	Manual selection pin of reference input (tri-state). Weak Pullup/Pulldown. R _P U = 50 kΩ. R _P D = 50 kΩ.
SECREP_P	1	I	Secondary reference clock. Accepts a differential or single-ended input or XTAL. Input pins need AC-coupling capacitors and internally biased in differential mode. For XTAL input, connect crystal between SECREP_P and SECREP_N pin. SECREP_P is XOUT, SECREP_N is XIN. This device do not need any power limiting resistor on XOUT. For LVCMOS input, input must be provided on SECREP_P, and the non-driven input pin must be pulled down to ground. Internal biasing for differential mode is disabled in single-ended and XTAL mode.
SECREP_N	2	I	
OUTPUT BLOCK			
OUT0	7	O	LVCMOS Output 0. Reference Input can be bypassed into this output. Output slew-rate configurable on all LVCMOS outputs.
OUT1_P	22	O	LVDS-like/LP-HCSL/LVCMOS Output Pair 1. Programmable driver with LVDS-like/LP-HCSL or 2x LVCMOS outputs.
OUT1_N	21	O	
OUT2_P	18	O	LVDS-like/LP-HCSL Output Pair 2. Programmable driver with LVDS-like/LP-HCSL outputs.
OUT2_N	17	O	
OUT3_P	14	O	LVDS-like/LP-HCSL Output Pair 3. Programmable driver with LVDS-like/LP-HCSL outputs.
OUT3_N	13	O	
OUT4_P	10	O	LVDS-like/LP-HCSL/LVCMOS Output Pair 4. Programmable driver with LVDS-like/LP-HCSL or 2x LVCMOS outputs.
OUT4_N	9	O	
DIGITAL CONTROL / INTERFACES			
GPIO1	20	I/O	STATUS output or GPIO1 input.
GPIO4	11	I/O	STATUS output or GPIO4 input.
PDN	8	I, RPU	Device Power-down/RESET (active low) or SYNCN. Weak pullup resistor. R _P U = 50 kΩ. Pullup resistor disabled in output mode.
SDA/GPIO2	19	I/O	I ² C Serial Data (bidirectional, open-drain) or GPIO2 input. Requires an external pullup resistor to VDD_REF in I ² C mode. I ² C address is initialized from on-chip EEPROM. Fail-safe Input.

Table 4-1. Pin Functions (continued)

PIN		Type ⁽¹⁾	DESCRIPTION
NAME	NO.		
SCL/GPIO3	12	I	I ² C Serial Clock or GPIO3 input. Requires an external pullup resistor to VDD_REF in I ² C mode. Fail-safe Input.

(1) Type:

- G = Ground
- P = Power
- I = Input
- I/O = Input/Output
- O = Output
- I, RPUPD = Input with Resistive Pullup and Pulldown
- I, RPU = Input with Resistive Pullup
- I/O, RPU = Input/Output with Resistive Pullup

5 Specifications

5.1 Absolute Maximum Ratings

over operating free-air temperature range (unless otherwise noted)⁽¹⁾

		MIN	MAX	UNIT
VDD_REF, VDD_VCO, VDDO_12, VDDO_34	Supply Voltage	-0.3	3.63	V
PRIREF_P, PRIREF_N, SECREP_P, SECREP_N	Input Voltage	-0.3	VDD_REF + 0.3	V
GPIO1, SDA/GPIO2, SCL/GPIO3, GPIO4, REFSEL, HW_SW_CTRL, PDN	Input Voltage	-0.3	VDD_REF + 0.3	V
OUT0, OUT1_P, OUT1_N, OUT2_P, OUT2_N, OUT3_P, OUT3_N, OUT4_P, OUT4_N ⁽²⁾	Output Voltage	-0.3	VDDO_X ⁽²⁾ + 0.3	V
T _J	Junction Temperature		125	°C
T _{stg}	Storage temperature	-65	150	°C

- (1) Operation outside the *Absolute Maximum Ratings* may cause permanent device damage. *Absolute Maximum Ratings* do not imply functional operation of the device at these or any other conditions beyond those listed under *Recommended Operating Conditions*. If used outside the *Recommended Operating Conditions* but within the *Absolute Maximum Ratings*, the device may not be fully functional, and this may affect device reliability, functionality, performance, and shorten the device lifetime.
- (2) VDDO_X refers to the output supply for a specific output channel, where X denotes the channel index.

5.2 ESD Ratings

			VALUE	UNIT
V _(ESD)	Electrostatic discharge	Human-body model (HBM), per ANSI/ESDA/JEDEC JS-001 ⁽¹⁾	2000	V
		Charged-device model (CDM), per ANSI/ESDA/JEDEC JS-002 ⁽²⁾	750	V

- (1) JEDEC document JEP155 states that 500-V HBM allows safe manufacturing with a standard ESD control process.
- (2) JEDEC document JEP157 states that 250-V CDM allows safe manufacturing with a standard ESD control process.

5.3 Recommended Operating Conditions

over operating free-air temperature range (unless otherwise noted)

		MIN	NOM	MAX	UNIT
VDD_VCO	Core supply voltage	1.71	1.8, 2.5, 3.3	3.465	V
VDDO_12, VDDO_34	Output supply voltage	1.71	1.8, 2.5, 3.3	3.465	V
VDD_REF	Reference supply voltage	1.71	1.8, 2.5, 3.3	3.465	V
T _A	Ambient temperature	-40		105	°C
T _J	Junction temperature	-40		125	°C
T _{LOCK}	Continuous lock over temperature (without VCO calibration)			145	°C
t _{RAMP}	Maximum supply voltage ramp time ⁽¹⁾	0.1		30	ms

- (1) VDD pin must monotonically reach 95% of the final value within supply ramp time. All VDD pins are tied together for this evaluation. For non-monotonic or slower power supply ramp, pulling down the PDN pin until VDD pins has reached 95% of the final value is recommended. PDN pin has a 50 kΩ pullup resistor. When PDN pin can not be actively controlled, TI recommends to add a capacitor to GND on PDN pin to delay the release of reset.

5.4 Thermal Information

THERMAL METRIC ⁽¹⁾		CDCE6214Q1	UNIT
		TM	
		RGE (VQFN) 24 PINS	
R _{θJA}	Junction-to-ambient thermal resistance	32.5	°C/W
R _{θJC(top)}	Junction-to-case (top) thermal resistance	32.5	°C/W
R _{θJB}	Junction-to-board thermal resistance	12.2	°C/W
R _{θJC(bot)}	Junction-to-case (bottom) thermal resistance	2.0	°C/W
ψ _{JT}	Junction-to-top characterization parameter	0.4	°C/W

THERMAL METRIC ⁽¹⁾		CDCE6214Q1 TM	UNIT
		RGE (VQFN)	
		24 PINS	
Ψ_{JB}	Junction-to-board characterization parameter	12.2	°C/W

(1) For more information about traditional and new thermal metrics, see the [Semiconductor and IC Package Thermal Metrics](#) application note.

5.5 EEPROM Characteristics

VDD_VCO, VDDO_12, VDDO_34, VDD_REF = 1.8 V ± 5%, 2.5 V ± 5%, 3.3 V ± 5% and T_A = -40°C to 105°C

PARAMETER	TEST CONDITIONS	MIN	TYP	MAX	UNIT
n_{EEcyc}	EEPROM programming cycles	each word		10	cycles
t_{EEret}	EEPROM data retention			10	years

5.6 Reference Input, Single-Ended Characteristics

VDD_VCO, VDDO_12, VDDO_34, VDD_REF = 1.8 V ± 5%, 2.5 V ± 5%, 3.3 V ± 5% and T_A = -40°C to 105°C

PARAMETER	TEST CONDITIONS	MIN	TYP	MAX	UNIT
f_{IN_Ref}	Reference frequency	10		200	MHz
V _{IH}	Input high voltage	LVCMOS Input Buffer			V
V _{IL}	Input low voltage	LVCMOS Input Buffer		0.2 × VDD_REF	V
dV _{IN} /dT	Input slew rate	20% - 80%		1	V/ns
IDC	Input duty cycle	40		60	%
I _{IN_LEAKAGE}	Input leakage current	-100		100	μA
C _{IN_REF}	Input capacitance	at 25°C		5	pF

5.7 Reference Input, Differential Characteristics

VDD_VCO, VDDO_12, VDDO_34, VDD_REF = 1.8 V ± 5%, 2.5 V ± 5%, 3.3 V ± 5% and T_A = -40°C to 105°C

PARAMETER	TEST CONDITIONS	MIN	TYP	MAX	UNIT
f_{IN_Ref}	Reference frequency	10		200	MHz
V _{IN_DIFF}	Differential input voltage swing, peak-to-peak	VDD_REF = 2.5 V/3.3 V		1.6	V
V _{IN_DIFF}	Differential input voltage swing, peak-to-peak	VDD_REF = 1.8 V		1.0	V
dV _{IN} /dT	Input slew rate	20% - 80%		1	V/ns
IDC	Input duty cycle	40		60	%
I _{IN_LEAKAGE}	Input leakage current	-100		100	μA
C _{IN_REF}	Input capacitance	at 25°C		5	pF

5.8 Reference Input, Crystal Mode Characteristics

VDD_VCO, VDDO_12, VDDO_34, VDD_REF = 1.8 V ± 5%, 2.5 V ± 5%, 3.3 V ± 5% and T_A = -40°C to 105°C⁽¹⁾

PARAMETER	TEST CONDITIONS	MIN	TYP	MAX	UNIT
f_{IN_Xtal}	Crystal frequency	Fundamental mode		50	MHz
Z _{ESR}	Crystal equivalent series resistance	f_{XTAL} = 10 MHz to 16 MHz		60	Ω
Z _{ESR}	Crystal equivalent series resistance	f_{XTAL} = 16 MHz to 30 MHz		50	Ω
Z _{ESR}	Crystal equivalent series resistance	f_{XTAL} = 30 MHz to 50 MHz		30	Ω
C _L	Crystal load capacitance	Using on-chip load capacitance. A supported Crystal is within		12.8	pF
P _{XTAL}	Crystal tolerated drive power	A supported crystal tolerates up to		200	μW

VDD_VCO, VDDO_12, VDDO_34, VDD_REF = 1.8 V ± 5%, 2.5 V ± 5%, 3.3 V ± 5% and T_A = -40°C to 105°C⁽¹⁾

PARAMETER		TEST CONDITIONS	MIN	TYP	MAX	UNIT
C _{XIN_LOAD}	On-Chip load capacitance	Programmable in typ. 200 fF steps	3		9.1	pF

- (1) For detailed application report on configuring the XTAL Input, please refer to [SNAA331: CDCI6214 and CDCE6214-Q1 design with crystal input](#).

5.9 General-Purpose Input Characteristics

VDD_VCO, VDDO_12, VDDO_34, VDD_REF = 1.8 V ± 5%, 2.5 V ± 5%, 3.3 V ± 5% and T_A = -40°C to 105°C

PARAMETER		TEST CONDITIONS	MIN	TYP	MAX	UNIT
V _{IH}	Input high voltage		0.8 × VDD_REF			V
V _{IL}	Input low voltage				0.2 × VDD_REF	V
I _{IH}	Input high level current	V _{IH} = VDD_REF, GPIO[1:4], PDN	-5		5	μA
I _{IL}	Input low level current	V _{IL} = GND, GPIO[2:3]	-5		5	μA
I _{IL}	Input low level current	V _{IL} = GND, GPIO[1], GPIO[4], PDN	-100		100	μA
dV _{IN} /dT	Input slew rate	20% - 80%	0.5			V/ns
T _{PULSE_WIDT H}	Pulse width for correct operation		10			ns
R _{PU}	Pullup Resistance	Pins PDN, GPIO[1], GPIO[4]	30	55	80	kΩ
C _{IN}	Pin Capacitance				10	pF

5.10 Triple Level Input Characteristics

VDD_VCO, VDDO_12, VDDO_34, VDD_REF = 1.8 V ± 5%, 2.5 V ± 5%, 3.3 V ± 5% and T_A = -40°C to 105°C

PARAMETER		TEST CONDITIONS	MIN	TYP	MAX	UNIT
V _{IH}	Input high voltage		0.8 × VDD_REF			V
V _{IM}	Input mid voltage	Float pin	0.41 × VDD_REF	0.5 × VDD_REF	0.58 × VDD_REF	V
V _{IL}	Input low voltage				0.2 × VDD_REF	V
I _{IH}	Input high level current	V _{IH} = VDD_REF	20	50	100	μA
I _{IL}	Input low level current	V _{IL} = GND	-100	-50	-20	μA

5.11 Logic Output Characteristics

VDD_VCO, VDDO_12, VDDO_34, VDD_REF = 1.8 V ± 5%, 2.5 V ± 5%, 3.3 V ± 5% and T_A = -40°C to 105°C

PARAMETER		TEST CONDITIONS	MIN	TYP	MAX	UNIT
VOH	Output high voltage		0.8 × VDD_REF			V
VOL	Output low voltage				0.2 × VDD_REF	V

5.12 Phase Locked Loop Characteristics

VDD_VCO, VDDO_12, VDDO_34, VDD_REF = 1.8 V ± 5%, 2.5 V ± 5%, 3.3 V ± 5% and T_A = -40°C to 105°C

PARAMETER		TEST CONDITIONS	MIN	TYP	MAX	UNIT
f _{PDF}	Phase Detector Frequency	Integer and Fractional PLL mode	1		100	MHz
f _{VCO}	Voltage Controlled Oscillator Frequency		2335		2625	MHz
f _{BW}	Configurable closed-loop PLL Bandwidth	REF = 25 MHz	100		1600	kHz
K _{VCO}	Voltage-Controlled Oscillator Gain	f _{VCO} = 2.4 GHz		140		MHz/V
K _{VCO}	Voltage-Controlled Oscillator Gain	f _{VCO} = 2.5 GHz		175		MHz/V
ΔT _{CL}	Allowable Temperature Drift for Continuous Lock ⁽¹⁾	dT/dt ≤ 20 K / min			145	°C

VDD_VCO, VDDO_12, VDDO_34, VDD_REF = 1.8 V ± 5%, 2.5 V ± 5%, 3.3 V ± 5% and T_A = -40°C to 105°C

PARAMETER		TEST CONDITIONS	MIN	TYP	MAX	UNIT
f _{MAX-ERROR}	Maximum frequency error with frac-N PLL				0.1	ppm

- (1) The maximum allowable temperature drift for continuous lock: how far the temperature can drift in either direction from the previous value, when the On-Chip VCO is calibrated while the PLL stays in lock throughout the temperature drift. The internal VCO calibration takes place: at device start-up, when the device is reset using the RESET pin and when REGISTER bit is changed. This implies the device works over the entire frequency range, but if the temperature drifts more than the 'maximum allowable temperature drift for continuous lock', then re-calibrating the VCO, using the appropriate REGISTER bit, is necessary to verify that the PLL stays in lock. Regardless of what temperature the part is initially calibrated at, the temperature can never drift outside the ambient temperature range of -40°C to 105°C.

5.13 Closed-Loop Output Jitter Characteristics

VDD_VCO, VDDO_12, VDDO_34, VDD_REF = 1.8 V ± 5%, 2.5 V ± 5%, 3.3 V ± 5% and T_A = -40°C to 105°C

PARAMETER		TEST CONDITIONS	MIN	TYP	MAX	UNIT
t _{RJ_CL}	RMS Phase Jitter	RMS jitter with spurs from 12 kHz to 20 MHz, Input Crystal = 25 MHz, Differential OUTx > 100 MHz, int-PLL		350	600	fs
t _{RJ_CL}	RMS Phase Jitter ⁽¹⁾	RMS jitter with spurs from 12 kHz to 20 MHz, Input Crystal = 25 MHz, Differential OUTx > 100 MHz, frac-PLL		1600	2100	fs
t _{RJ_CL_PCIE}	RMS Phase Jitter	PCIe Gen 3 Filter applied, XIN = Crystal 25 MHz, OUTx = 100 MHz, frac-N PLL with and without SSC, LP-HCSL or LVDS output		475	1000	fs

- (1) F_{IN} = 25MHz, F_{OUT} = 161.1328MHz, F_{PFD} = 25MHz, RMS Noise = 1.83ps. F_{IN} = 25MHz, F_{OUT} = 161.1328MHz, F_{PFD} = 50MHz, RMS Noise = 1.33ps. F_{IN} = 25MHz, F_{OUT} = 148.5MHz, F_{PFD} = 25MHz, RMS Noise = 1.74ps. F_{IN} = 25MHz, F_{OUT} = 148.5MHz, F_{PFD} = 50MHz, RMS Noise = 1.43ps. F_{IN} = 25MHz, F_{OUT} = 148.3516MHz, F_{PFD} = 25MHz, RMS Noise = 1.6ps. F_{IN} = 25MHz, F_{OUT} = 148.3516MHz, F_{PFD} = 50MHz, RMS Noise = 1.5ps. F_{IN} = 25MHz, F_{OUT} = 106.5MHz, F_{PFD} = 25MHz, RMS Noise = 0.8ps. F_{IN} = 25MHz, F_{OUT} = 106.5MHz, F_{PFD} = 50MHz, RMS Noise = 1.3ps.

5.14 Input and Output Isolation

VDD_VCO, VDDO_12, VDDO_34, VDD_REF = 1.8 V ± 5%, 2.5 V ± 5%, 3.3 V ± 5% and T_A = -40°C to 105°C

PARAMETER		TEST CONDITIONS	MIN	TYP	MAX	UNIT
P _{ISOLATION}	Reference input isolation	Crosstalk between reference inputs, PRIREF = 27MHz LVCMOS, SECREf = 25MHz XTAL		-64		dB
P _{ISOLATION}	Reference input isolation	Crosstalk between reference inputs, PRIREF = 100MHz LVDS, SECREf = 25MHz LVCMOS		-72		dB
P _{ISOLATION}	Clock output isolation	Crosstalk between clock outputs, OUT1 = 100MHz LP-HCSL, OUT2 = 156.25MHz LVDS, PFD = 25MHz, int-PLL		-65		dB
P _{ISOLATION}	Clock output isolation	Crosstalk between clock outputs, OUT1 = 156.25MHz LVDS, OUT0 = 25MHz LVCMOS		-42		dB

5.15 Buffer Mode Characteristics

VDD_VCO, VDDO_12, VDDO_34, VDD_REF = 1.8 V ± 5%, 2.5 V ± 5%, 3.3 V ± 5% and T_A = -40°C to 105°C

PARAMETER		TEST CONDITIONS	MIN	TYP	MAX	UNIT
t _{RJ_ADD}	Additive RMS Phase Jitter, System Level	int. Range from 10 kHz to 20 MHz, REF = HCSSL 100 MHz with 0.5 V/ns, OUTx = 100 MHz LP-HCSL			350	fs
t _{PROP, LVCMOS}	Input-to-output propagation delay	REF = LVCMOS 25 MHz, OUTx = 25 MHz LVCMOS		1		ns
t _{PROP, Differential}	Input-to-output propagation delay ⁽¹⁾	REF = AC-LVDS 100 MHz, OUTx = 100 MHz. Measured on OUT0		2.3		ns

VDD_VCO, VDDO_12, VDDO_34, VDD_REF = 1.8 V ± 5%, 2.5 V ± 5%, 3.3 V ± 5% and T_A = -40°C to 105°C

PARAMETER		TEST CONDITIONS	MIN	TYP	MAX	UNIT
t _{PROP-VARIATION}	Input-to-output delay variation in ZDB mode	ZDB mode, LVCMOS input = LVCMOS output = 25 MHz, PLL BW = 300 kHz to 900 kHz across temperature	-400		400	ps

- (1) OUT1/OUT4 and OUT2/OUT3 are matched pair-wise. OUT1/OUT4 has LVCMOS buffer while OUT2/OUT3 do not have LVCMOS buffer. There is an additional skew 150 ps - 250 ps between OUT1/OUT4 and OUT2/OUT3.

5.16 PCIe Spread Spectrum Generator

VDD_VCO, VDDO_12, VDDO_34, VDD_REF = 1.8 V ± 5%, 2.5 V ± 5%, 3.3 V ± 5% and T_A = -40°C to 105°C

PARAMETER		TEST CONDITIONS	MIN	TYP	MAX	UNIT
f _{SSC-RATE}	SSC modulation rate	OUTx = 100 MHz	30	31.5	33	kHz
P _{AMPL-RED}	SSC amplitude reduction	OUTx = 100 MHz, -0.25% Down spread		6.8		dB
P _{AMPL-RED}	SSC amplitude reduction	OUTx = 100 MHz, -0.50% Down spread		9.9		dB
f _{SSC-STEP}	Down and Center spread SSC step size	OUTx = 100 MHz		0.25		%
t _{SSC_FREQ_DEVIATION}	Down spread minimum/maximum deviation	OUTx = 100 MHz. F _{PPFD} = 25 MHz, 50 MHz, 100 MHz	-0.5		0	%
t _{SSC_FREQ_DEVIATION}	Center spread minimum/maximum deviation	OUTx = 100 MHz. F _{PPFD} = 25 MHz, 50 MHz, 100 MHz	-0.5		0.5	%

5.17 LVCMOS Output Characteristics

VDD_VCO, VDDO_12, VDDO_34, VDD_REF = 1.8 V ± 5%, 2.5 V ± 5%, 3.3 V ± 5% and T_A = -40°C to 105°C

PARAMETER		TEST CONDITIONS	MIN	TYP	MAX	UNIT
f _{O_LVCMOS}	Output frequency	2 pF to GND, normal mode	0.024		200	MHz
V _{OH_LVCMOS}	Output high voltage	I _{OH} = 1 mA, VDDO_x is corresponding supply voltage.	0.8 × VDDO_x			V
V _{OL_LVCMOS}	Output low voltage	I _{OL} = 1 mA, VDDO_x is corresponding supply voltage.			0.2 × VDDO_x	V
I _{OH}	Output high current	Vout = 0.8 × VDDO_x, VDDO_x = 1.8 V		-6		mA
I _{OH}	Output high current	Vout = 0.8 × VDDO_x, VDDO_x = 2.5 V		-8.5		mA
I _{OH}	Output high current	Vout = 0.8 × VDDO_x, VDDO_x = 3.3 V		-11.2		mA
I _{OL}	Output low current	Vout = 0.2 × VDDO_x, VDDO_x = 1.8 V		6		mA
I _{OL}	Output low current	Vout = 0.2 × VDDO_x, VDDO_x = 2.5 V		8.5		mA
I _{OL}	Output low current	Vout = 0.2 × VDDO_x, VDDO_x = 3.3 V		11.2		mA
T _{RISE-FALL}	Output rise/fall time	20/80%, C _L = 5 pF, normal mode	300	500	700	ps
T _{RISE-FALL}	Output rise/fall time	20/80%, C _L = 5 pF, slow mode, measured on OUT0		1000		ps
T _{SKEW}	Output-to-output skew ⁽¹⁾	LVCMOS-to-LVCMOS outputs, same divide value		100		ps
T _{SKEW}	Output-to-output skew ⁽¹⁾	LVCMOS-to-Differential outputs, same divide value		400		ps
ODC	Output duty cycle	Not in PLL bypass mode	45		55	%
R _{ON_LVCMOS}	Output impedance	Normal mode	45	60	75	Ω
R _{ON_LVCMOS}	Output impedance	Slow mode	50	65	85	Ω

- (1) OUT1/OUT4 and OUT2/OUT3 are matched pair-wise. OUT1/OUT4 has LVCMOS buffer while OUT2/OUT3 do not have LVCMOS buffer. OUT1/OUT4 is matched within T_{OUT-SKEW}. OUT2/OUT3 is matched within T_{OUT-SKEW}.

5.18 LP-HCSL Output Characteristics

VDD_VCO, VDDO_12, VDDO_34, VDD_REF = 1.8 V ± 5%, 2.5 V ± 5%, 3.3 V ± 5% and T_A = -40°C to 105°C

PARAMETER		TEST CONDITIONS	MIN	TYP	MAX	UNIT
f _{O_HCSL}	Output frequency		0.024		328.125	MHz
V _{OH}	Output high voltage ⁽³⁾		660		850	mV
V _{OL}	Output low voltage		-150		150	mV

$VDD_VCO, VDDO_12, VDDO_34, VDD_REF = 1.8\text{ V} \pm 5\%, 2.5\text{ V} \pm 5\%, 3.3\text{ V} \pm 5\%$ and $T_A = -40^\circ\text{C}$ to 105°C

PARAMETER		TEST CONDITIONS	MIN	TYP	MAX	UNIT
Z _{DIFF}	Differential Output Impedance ⁽³⁾		90	100	110	Ω
V _{CROSS}	Absolute crossing point	12-in, 100 Ω ±10% diff. trace with 2 pF±5%/pin in FR4.	250		550	mV
ΔV _{CROSS}	Relative crossing point variation	With respect to average crossing point			140	mV
dV/dt	Slew rate for rising and falling edge	Differential, at V _{CROSS} +/-150 mV, f _{O_HCSL} =100 MHz ⁽¹⁾	1		4	V/ns
ΔdV/dt	Slew rate matching	Single-ended, at V _{CROSS} +/-75 mV, f _{O_HCSL} =100 MHz ⁽¹⁾			20	%
V _{rb}	Output ringback voltage	Measured on differential output at 100 MHz and specifies minimum voltage from zero crossing	-100		100	mV
T _{stable}	Time elapsed until ringback	Minimum time until ringback is allowed	500			ps
ODC	Output duty cycle	Not in PLL bypass mode	45		55	%
T _{OUT-SKEW}	Output skew ⁽²⁾	Same divide value, LP-HCSL to LP-HCSL		100		ps

- (1) PCIe test load slew rate
- (2) OUT1/OUT4 and OUT2/OUT3 are matched pair-wise. OUT1/OUT4 has LVCMOS buffer while OUT2/OUT3 do not have LVCMOS buffer. OUT1/OUT4 is matched within T_{OUT-SKEW}. OUT2/OUT3 is matched within T_{OUT-SKEW}. There is an additional skew 150 ps - 250 ps between OUT1/OUT4 and OUT2/OUT3.
- (3) Differential Output characteristic is trimmed in factory and trim settings are stored in EEPROM. Parameter not valid in Fall-back mode.

5.19 LVDS Output Characteristics

 $VDD_VCO, VDDO_12, VDDO_34, VDD_REF = 1.8\text{ V} \pm 5\%, 2.5\text{ V} \pm 5\%, 3.3\text{ V} \pm 5\%$ and $T_A = -40^\circ\text{C}$ to 105°C

PARAMETER		TEST CONDITIONS	MIN	TYP	MAX	UNIT
f _{O_PRG_AC}	Output frequency		0.024		328.125	MHz
V _{CM}	Output common mode ⁽¹⁾	VDDO_X = 2.5 V, 3.3 V	1.025	1.2	1.375	V
V _{CM}	Output common mode ⁽¹⁾	VDDO_X = 1.8 V	0.85	0.95	1.05	V
V _{OD}	Differential output voltage ⁽¹⁾	VDDO_X = 1.8 V (F _{out} < 200 MHz), 2.5 V, 3.3 V.	0.25	0.30	0.45	V
V _{OD}	Differential output voltage ⁽¹⁾	VDDO_X = 1.8 V & F _{out} > 200 MHz	0.22	0.30	0.45	V
t _{RF}	Output rise/fall times	LVDS (20% to 80%)	450	650	900	ps
ODC	Output duty cycle	Not in PLL bypass mode	45		55	%
T _{OUT-SKEW}	Output skew ⁽²⁾	Same divide value, LVDS to LVDS output		100		ps

- (1) Output Common Mode voltage and Differential output swing is dependent upon register settings DIFFBUF_IBIAS_TRIM, LVDS_CMTRIM_DEC and LVDS_CMTRIM_INC. Parameters defined for DIFFBUF_IBIAS_TRIM=6h, LVDS_CMTRIM_DEC=0h and LVDS_CMTRIM_INC=0h. Output Common Mode tested at DC.
- (2) OUT1/OUT4 and OUT2/OUT3 are matched pair-wise. OUT1/OUT4 has LVCMOS buffer while OUT2/OUT3 do not have LVCMOS buffer. OUT1/OUT4 is matched within T_{OUT-SKEW}. OUT2/OUT3 is matched within T_{OUT-SKEW}. There is an additional skew 150 ps- 250 ps between OUT1/OUT4 and OUT2/OUT3.

5.20 Output Synchronization Characteristics

 $VDD_VCO, VDDO_12, VDDO_34, VDD_REF = 1.8\text{ V} \pm 5\%, 2.5\text{ V} \pm 5\%, 3.3\text{ V} \pm 5\%$ and $T_A = -40^\circ\text{C}$ to 105°C

PARAMETER		TEST CONDITIONS	MIN	TYP	MAX	UNIT
t _{SU_SYNC}	Setup time SYNC pulse	With respect to PLL reference rising edge at 100 MHz with R=1	3			ns
t _{H_SYNC}	Hold time SYNC pulse	With respect to PLL reference rising edge at 100 MHz with R=1			3	ns
t _{PWH_SYNC}	High pulse width for SYNC	With R = 1, at least 2 PFD periods + 24 feedback pre-scaler periods	60			ns
t _{PWL_SYNC}	Low pulse width for SYNC	With R = 1, at least 1 PFD period	6			ns
t _{EN}	Individual output enable time ⁽¹⁾	Tri-state to first valid rising edge			4	nCK
t _{DIS}	Individual output disable time ⁽¹⁾	Last valid falling edge to tri-state			4	nCK

- (1) Output clock cycles of respective output channel. Global output enable handled by digital logic, additional propagation is added.

5.21 Power-On Reset Characteristics

VDD_VCO, VDDO_12, VDDO_34, VDD_REF = 1.8 V ± 5%, 2.5 V ± 5%, 3.3 V ± 5% and T_A = -40°C to 105°C

PARAMETER		TEST CONDITIONS	MIN	TYP	MAX	UNIT
V _{THRESHOLD}	POR threshold voltage ⁽¹⁾		0.875		1.275	V
t _{STARTUP}	Start-up time	Start-up time after VDD reaches 95% to the time outputs are toggling with correct frequency (input = crystal or external clock)		9		ms
t _{VDD}	Power supply ramp time ⁽²⁾	Timing requirement for any VDD pin while PDN=LOW	0.1		30	ms

- (1) POR threshold voltage is the power supply voltage at which the internal reset is deasserted. The threshold voltage is qualified internally with PDN.
- (2) VDD pin just monotonically reach 95% of the final value within supply ramp time. Parameters specified by characterization. All VDD pins are tied together for this evaluation. For non-monotonic or slower power supply ramp, pulling down the PDN pin until VDD pins has reached 95% of the final value is recommended. The PDN pin has a 50 kΩ pullup resistor. When PDN pin can not be actively controlled, TI recommends to add a capacitor to GND on PDN pin to delay the release of reset.

5.22 I²C-Compatible Serial Interface Characteristics

VDD_VCO, VDDO_12, VDDO_34, VDD_REF = 1.8 V ± 5%, 2.5 V ± 5%, 3.3 V ± 5% and T_A = -40°C to 105°C

PARAMETER		TEST CONDITIONS	MIN	TYP	MAX	UNIT
V _{IH}	Input Voltage, Logic High		0.7 × VDD_REF			V
V _{IL}	Input Voltage, Logic Low				0.3 × VDD_REF	V
I _{IH}	Input Leakage Current	VDD_REF ± 10%	-5		5	μA
V _{OL}	Low Level Output Voltage	At 3 mA sink current			0.4	V
C _{IN}	Input Capacitance				10	pF
C _{OUT}	Output Capacitance	Maximum bus capacitance per pin			400	pF

5.23 Timing Requirements, I²C-Compatible Serial Interface

VDD_VCO, VDDO_12, VDDO_34, VDD_REF = 1.8 V ± 5%, 2.5 V ± 5%, 3.3 V ± 5% and T_A = -40°C to 105°C

PARAMETER		TEST CONDITIONS	MIN	TYP	MAX	UNIT
t _{PW_G}	Pulse Width of Suppressed Glitches				50	ns
f _{SCL}	SCL Clock Frequency	Standard		100		kHz
f _{SCL}	SCL Clock Frequency	Fast-mode		400		kHz
t _{SU_STA}	Setup Time Start Condition	SCL=V _{IH} before SDA=V _{IL}		0.6		μs
t _{H_STA}	Hold Time Start Condition	SCL=V _{IL} after SCL=V _{IL} . After this time, the first clock edge is generated.		0.6		μs
t _{SU_SDA}	Setup Time Data	SDA valid after SCL=V _{IL} , f _{SCL} =100 kHz	250			ns
t _{SU_SDA}	Setup Time Data	SDA valid after SCL=V _{IL} , f _{SCL} =400 kHz	100			ns
t _{H_SDA}	Hold Time Data ⁽¹⁾	SDA valid before SCL=V _{IH}	0 ⁽²⁾		⁽³⁾	μs
t _{VD_SDA}	Valid Data or Acknowledge Time	f _{SCL} =100 kHz ⁽³⁾			3.45	μs
t _{VD_SDA}	Valid Data or Acknowledge Time	f _{SCL} =400 kHz ⁽²⁾			0.9	μs
t _{PWH_SCL}	Pulse Width High, SCL	f _{SCL} =100 kHz	4.0			μs
t _{PWH_SCL}	Pulse Width High, SCL	f _{SCL} =400 kHz	0.6			μs
t _{PWL_SCL}	Pulse Width Low, SCL	f _{SCL} =100 kHz	4.7			μs
t _{PWL_SCL}	Pulse Width Low, SCL	f _{SCL} =400 kHz	1.3			μs
t _{IR}	Input Rise Time				300	ns
t _{IF}	Input Fall Time				300	ns
t _{OF}	Output Fall Time	10 pF ≤ C _{OUT} ≤ 400 pF			250	ns
t _{SU_STOP}	Setup Time Stop Condition			0.6		μs

CDCE6214

SNAS811A – JULY 2020 – REVISED JULY 2025

 $VDD_VCO, VDDO_12, VDDO_34, VDD_REF = 1.8\text{ V} \pm 5\%, 2.5\text{ V} \pm 5\%, 3.3\text{ V} \pm 5\%$ and $T_A = -40^\circ\text{C}$ to 105°C

PARAMETER		TEST CONDITIONS	MIN	TYP	MAX	UNIT
t_{BUS}	Bus-Free Time	Time between a Stop and a Start condition		1.3		μs

- (1) t_{H_SDA} is the data hold time that is measured from the falling edge of SCL, applies to data in transmission and the acknowledge.
- (2) A device must internally provide a hold time of at least 300 ns for the SDA signal (with respect to the $V_{IH(\min)}$ of the SCL signal) to bridge the undefined region of the falling edge of SCL.
- (3) The maximum t_{H_SDA} can be 3.45 μs and 0.9 μs for Standard-mode and Fast-mode, but must be less than the maximum of t_{VD_SDA} by a transition time. This maximum must only be met if the device does not stretch the LOW period (t_{PWL_SCL}) of the SCL signal. If the clock stretches the SCL, the data must be valid by the setup time before the I²C Master releases the clock.

5.24 Power Supply Characteristics

 $VDD_VCO, VDDO_12, VDDO_34, VDD_REF = 1.8\text{ V} \pm 5\%, 2.5\text{ V} \pm 5\%, 3.3\text{ V} \pm 5\%$ and $T_A = -40^\circ\text{C}$ to 105°C

PARAMETER		TEST CONDITIONS	MIN	TYP	MAX	UNIT
I_{DD_REF}	VDD_REF supply current	25 MHz XTAL, DBL ON		8		mA
I_{DD_VCO}	VCO and PLL current	$f_{VCO}=2400\text{ MHz}$, PSA = PSB = 4 and N-divider = 48		14		mA
I_{DD_OUT}	Output Channel Current	IOD=6, LP-HCSL, 100MHz on OUT3 and OUT4, 25MHz on OUT0		22		mA
I_{DD_OUT}	Output Channel Current	IOD = 6, LP-HCSL, 100 MHz on OUT1 and OUT2		17.5		mA
I_{DD_PDN}	Power down current	Using reset pin / bits		2.8	5	mA
I_{DD_TYP}	Typical current	4 x 100 MHz LVDS case using crystal input and doubler, SSC off		50	70	mA
I_{DD_TYP}	Typical current	4 x 100 MHz LP-HCSL case using crystal input and doubler, SSC off		65	90	mA
L_{PSNR}	Power supply noise rejection	OUTx = 100 MHz differential, on one of VDDx injected sine wave at $f_{INJ} = 100\text{ kHz}$		-61		dB
L_{PSNR}	Power supply noise rejection	OUTx = 100 MHz differential, on one of VDDx injected sine wave at $f_{INJ} = 1\text{ MHz}$		-57		dB

5.25 Typical Characteristics

Measured at room temperature

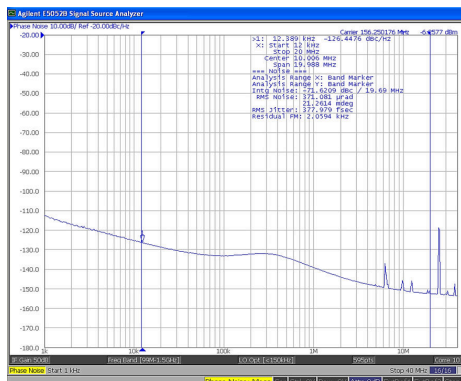

Reference: Crystal Closed-Loop Phase 156.25-MHz LVDS
Input 25 MHz Noise from 2.5-GHz
VCO

Figure 5-1. 156.25-MHz LVDS Output

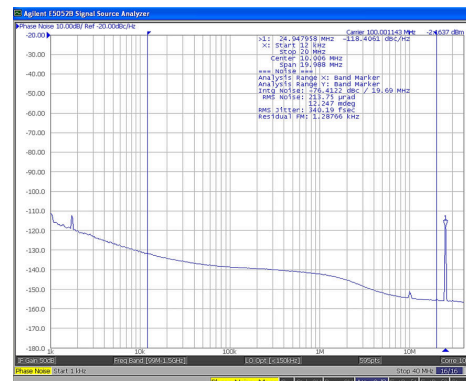

Reference: Crystal Closed-Loop Phase 100-MHz LP-HCSL
Input 25 MHz Noise from 2.4-GHz
VCO

Figure 5-2. 100-MHz LP-HCSL Output

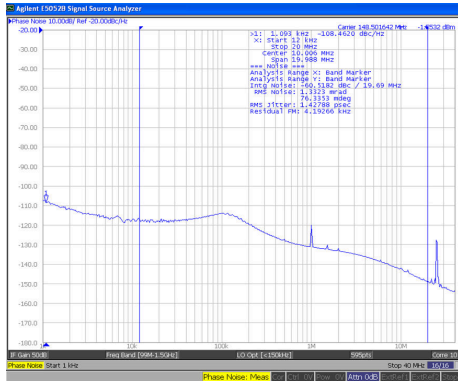

Reference: Crystal Closed-Loop Phase 148.5-MHz LVDS
Input 25 MHz Noise from 2.376-
GHz VCO

Figure 5-3. 148.5-MHz LVDS Output

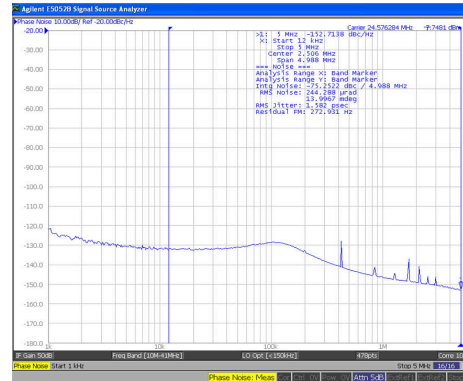

Reference: Crystal Closed-Loop Phase 24.576-MHz
Input 25 MHz Noise from 2.4576-
GHz VCO LVC MOS

Figure 5-4. 24.576-MHz LVC MOS Output

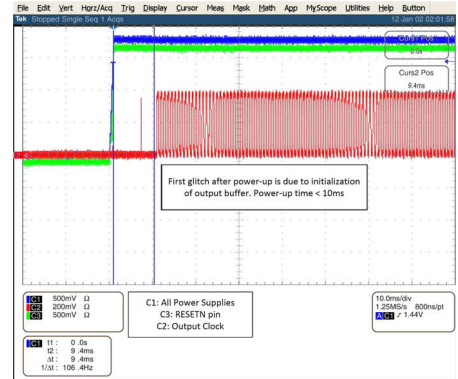

Figure 5-5. All Power Supply = 1.8 V, VDD Ramp Time = 1 ms

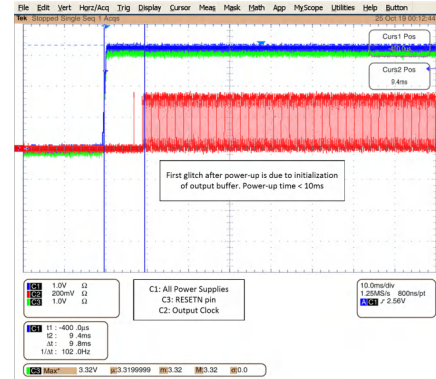

Figure 5-6. All Power Supply = 3.3 V, VDD Ramp Time = 1 ms

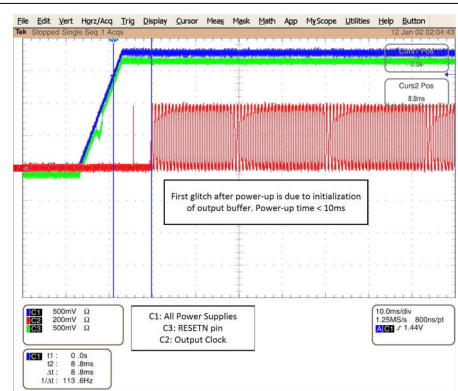

Figure 5-7. All Power Supply = 1.8 V, VDD Ramp Time = 10 ms

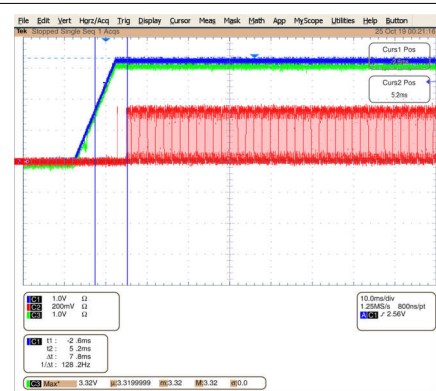

Figure 5-8. All Power Supply = 3.3 V, VDD Ramp Time = 10 ms

6 Parameter Measurement Information

6.1 Reference Inputs

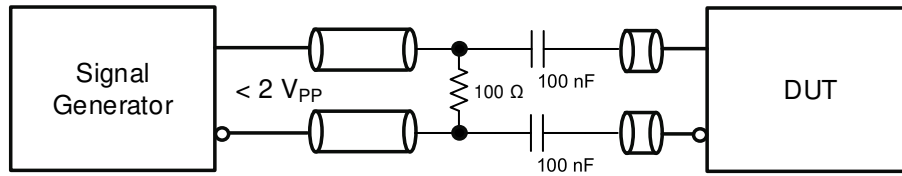

Figure 6-1. Differential AC-Coupled Input

6.2 Outputs

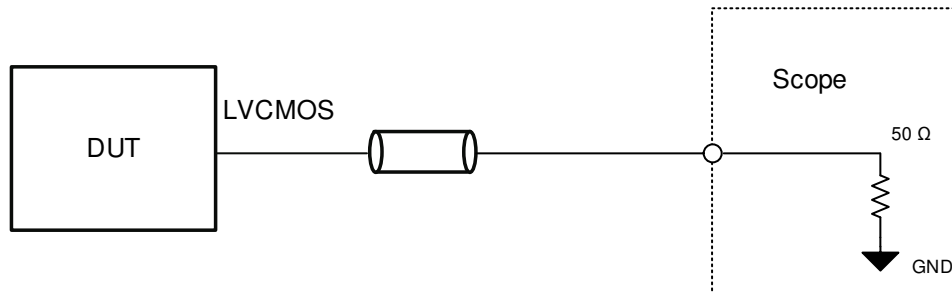

Figure 6-2. LVCMOS Output Test Configuration

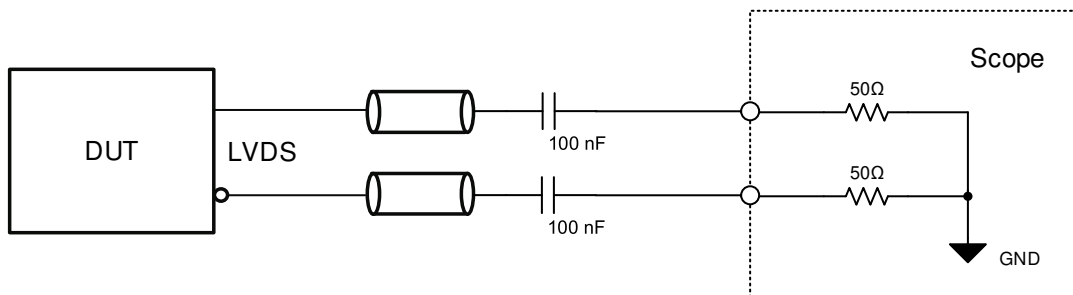

Figure 6-3. LVDS Output Test Configuration, AC-Coupled

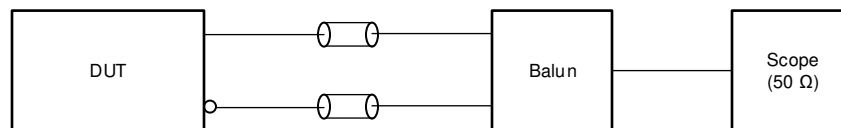

Figure 6-4. LP-HCSL Test Configuration, DC-Coupled

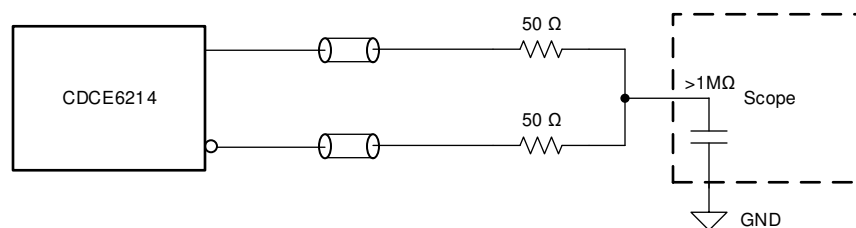

Figure 6-5. LVDS Common Mode Voltage, DC-Coupled

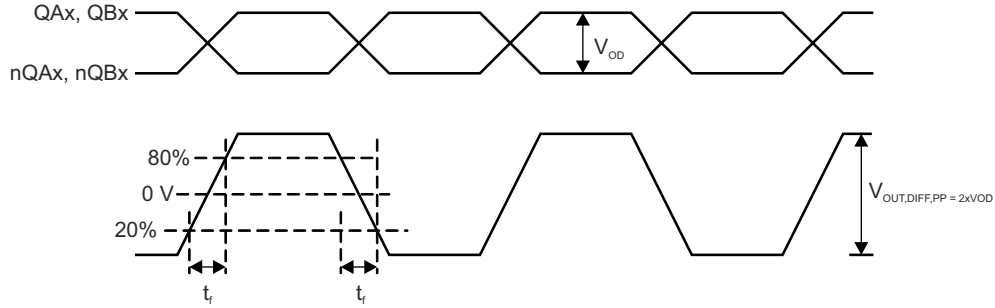

Figure 6-6. Differential Output Voltage and Rise/Fall Time

6.3 Serial Interface

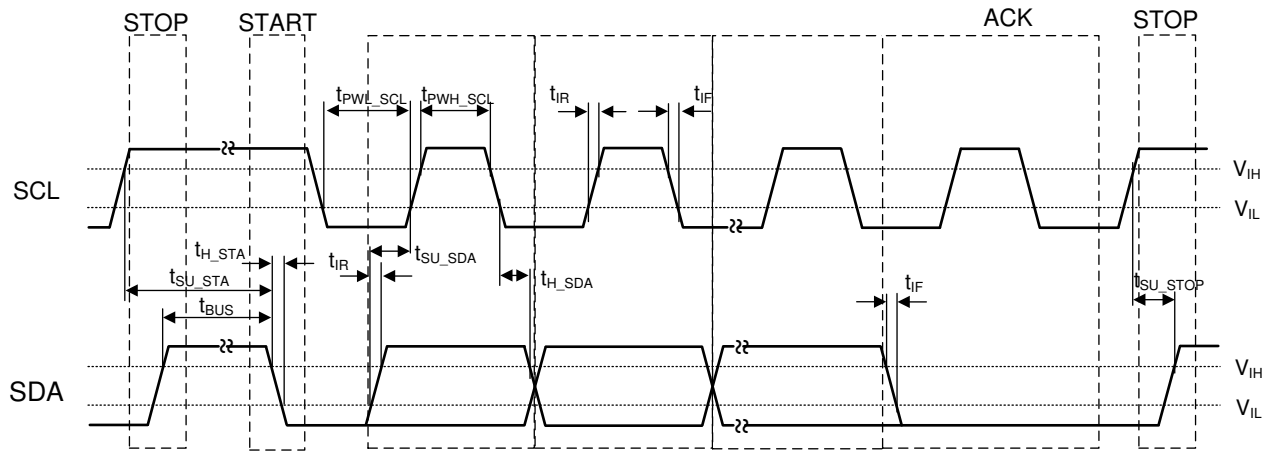

Figure 6-7. I²C Timing

6.4 PSNR Test

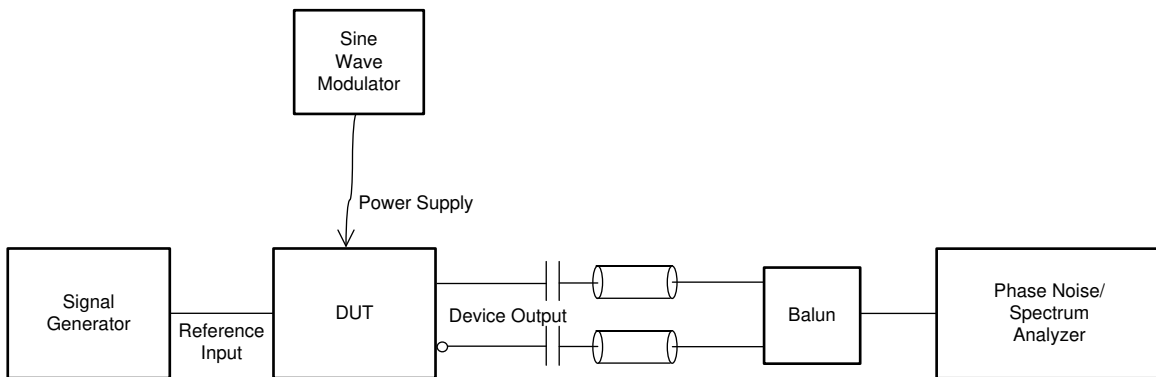

Figure 6-8. PSNR Test Configuration

6.5 Clock Interfacing and Termination

6.5.1 Reference Input

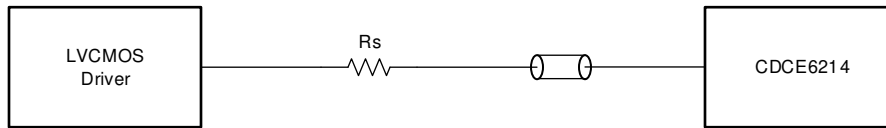

Figure 6-9. Single-Ended LVC MOS to Reference

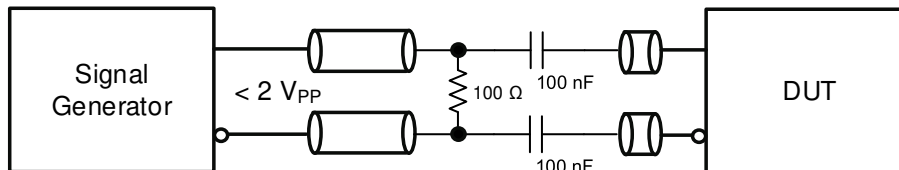

Figure 6-10. Differential Input to Reference

6.5.2 Outputs

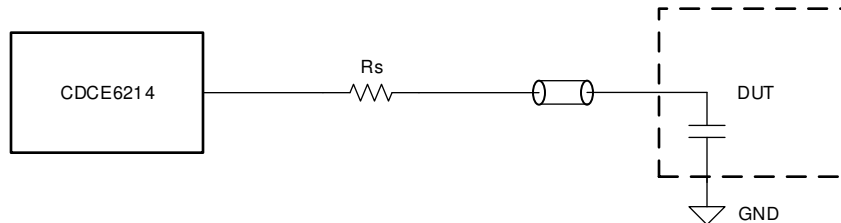
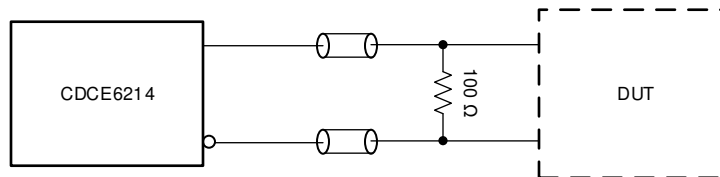

Figure 6-11. LVC MOS Output



A. Place 100-Ω Resistor Close to the DUT

Figure 6-12. LVDS Output - DC-Coupled

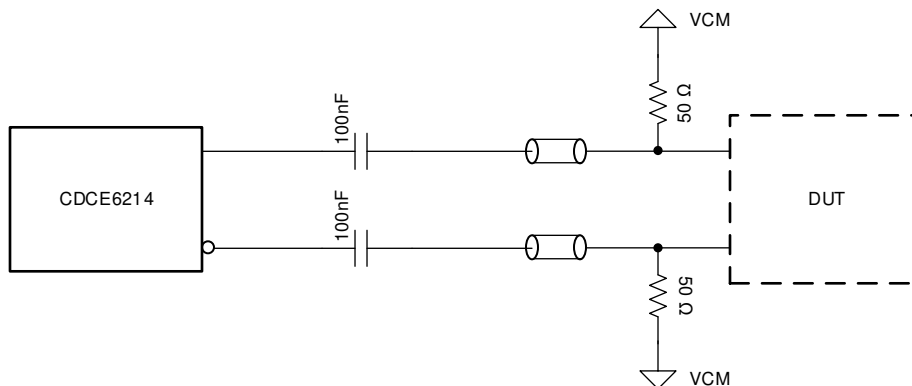

Figure 6-13. LVDS Output - AC-Coupled

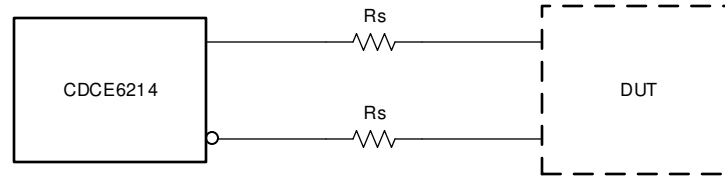

Figure 6-14. LP-HCSL Output

7 Detailed Description

7.1 Overview

The CDCE6214 clock generator is a Phase-Locked Loop (PLL) with integrated voltage-controlled oscillator (VCO) and integrated loop filter with selectable input reference. Input reference supports XTAL, Differential and single-ended LVCMOS inputs. The PLL has a Frac-N PLL with integrated VCO range of 2335 MHz - 2625 MHz. The output of the VCO is connected to the clock distribution network, which includes multiple frequency dividers and multiplexers. The output of these network is connected to 4 output channels with configurable differential and single-ended buffers. There are 4 power supply pins which can be independently configured to 1.8V/2.5V/3.3V. CDCE6214 can be configured using the I²C serial interface or built-in EEPROM at power up. This device supports various modes such as Digitally Controlled Oscillator (DCO) through GPIO/I2C and Internal/external Zero Delay mode.

7.2 Functional Block Diagram

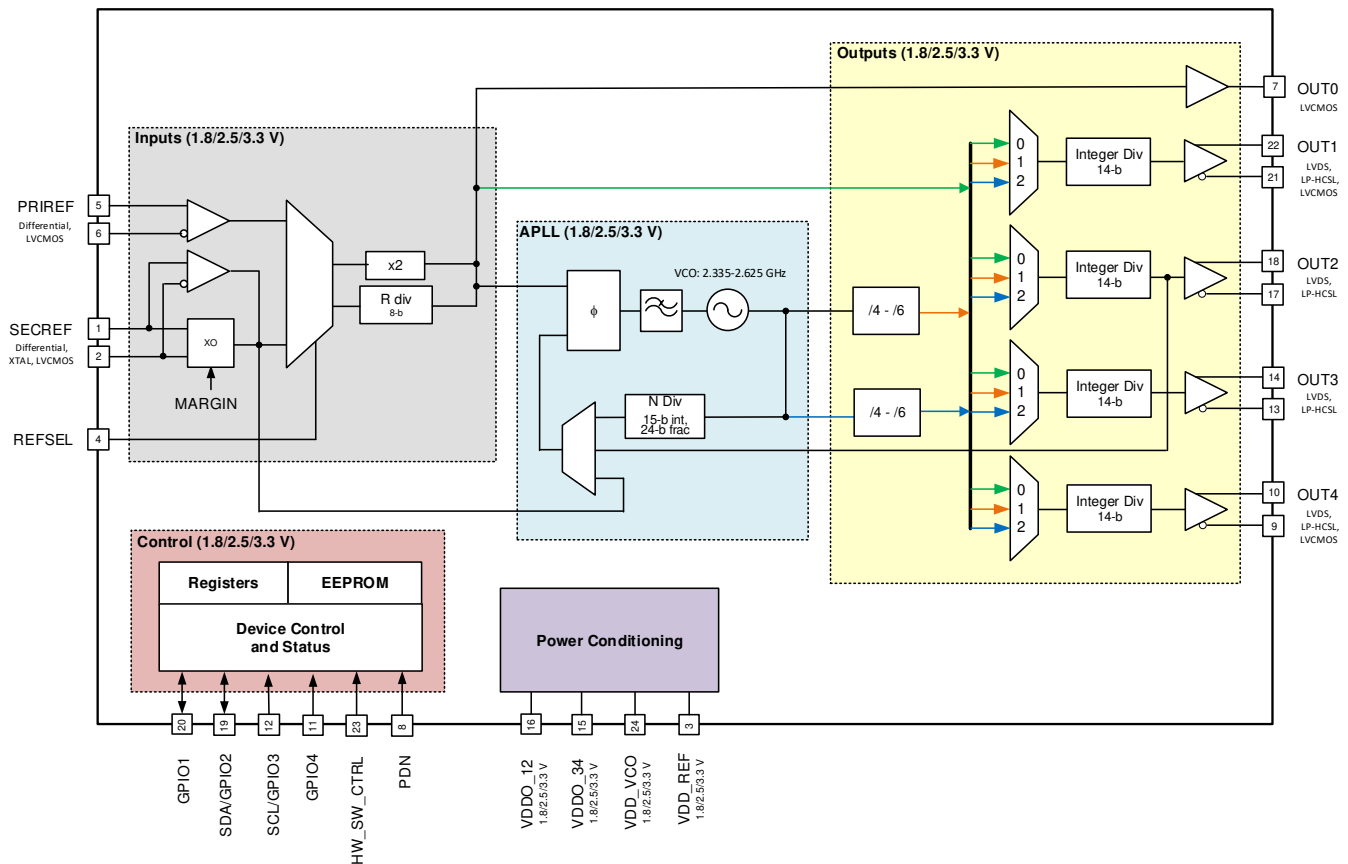

Figure 7-1. CDCE6214 Clock Generator With Two Inputs, One Fractional-N PLL, and Four Outputs

7.3 Feature Description

The following sections describe the individual blocks of the CDCE6214 ultra-low-power clock generator.

7.3.1 Reference Block

A reference clock to the PLL is fed to pins 1 (SECREP_P) and 2 (SECREP_N) or to pins 5 (PRIREF_P) and 6 (PRIREF_N). There are multiple input stages to accommodate various clock references. Pins 1 and 2 can be used to connect a XTAL across the clock, or provide an external single-ended LVCMOS clock or differential clock. These modes are selectable through register programming. When differential mode is selected, appropriated biasing is applied to the pin. In case of differential mode, an external AC-coupling capacitor is required. When XTAL or LVCMOS mode is selected, biasing circuitry is disengaged. Pins 5 and 6 can be used to provide an external single-ended LVCMOS clock or a differential clock.

The reference MUX selects the reference clock for the PLL. Setting REFSEL pin = L selects SECREP input, while setting REFSEL pin = H selects PRIREF Input. Alternatively, this can be configured through the register settings.

Table 7-1. Reference Input Selection

REGISTER BIT ADDRESS	REGISTER BIT FIELD NAME	VALUE	DESCRIPTION
R2[1:0]	REFSEL_SW	0h or 1h	Input Reference Mux controlled through Pin 4 (REFSEL)
	(Default: 0h)	2h	Pin1/Pin 2 SECREP Input selected. This is independent of Pin 4 status.
		3h	Pin 5/Pin 6 PRIREF Input selected. This is independent of Pin 4 status.
R24[1:0]	IP_SECREP_BUF_SEL	0h	XO enabled. Valid for SECREP pins.
	(Default: 0h)	1h	LVCMOS Buffer enabled. Valid for SECREP pins.
		2h or 3h	Differential Buffer enabled. Valid for SECREP pins.
R24[15]	IP_PRIREF_BUF_SEL	0h	LVCMOS Buffer enabled. Valid for PRIREF pins.
	(Default: 0h)	1h	Differential Buffer enabled. Valid for PRIREF pins.

A reference divider or a clock-doubler can be engaged to further multiply (2x) or divide the reference clock to the PLL. IP_RDIV[7:0] can be used to set the value of the divider. Setting IP_RDIV[7:0] to 00h enables the doubler.

The output clock from the reference block can be bypassed to the OUT0 and other output channels. The bypassed clock is selectable between the Input clock or PFD clock. See [Table 7-9](#).

The SECREP_P and SECREP_N pins provide a crystal oscillator stage to drive a fundamental mode crystal in the range of 10 MHz to 50 MHz. The crystal input stage integrates a tunable load capacitor array up to 9 pF and programmable through R24[12:8]. The drive capability of the oscillator is programmable through R24[5:2].

The LVCMOS input buffer threshold voltage follows VDD_REF. This device can be used as a level shifter because the outputs have separate supplies.

7.3.1.1 Zero Delay Mode, Internal and External Path

The CDCE6214 can operate in Zero Delay Mode with internal as well as external feedback. In Zero Delay Mode, PRIREF clock is used as the reference clock to the PFD. SECREP input clock can be used to feed an external source as feedback clock to the PFD. External feedback path is recommended for Zero Delay operation. Moreover there is an additional internal feedback path which is sourced from output channel 2. The Input-output propagation delay is expected to be higher in internal Zero Delay Mode than zero-delay mode.

Table 7-2. Zero Delay Operation ^{(1) (2) (3)}

OPERATION	REFSEL	R2[1:0] - REFSEL_SW	R24[1:0] - IP_SECREf_BUF_SEL	R24[15] - IP_PRIREF_BUF_SEL	R0[8] - ZDM_EN	R0[10] - ZDM_CLOCKSEL	DESCRIPTION
Normal Operation, XTAL Input	L	0h or 1h or 2h	0h	X	0h	0h	Normal Operation, XTAL Input
Normal Operation, Differential Input	L	0h or 1h or 2h	2h or 3h	X	0h	0h	SECREf/Differential Input
Normal Operation, Differential Input	H	0h or 1h or 3h	X	1h	0h	0h	PRIREF/Differential Input
Normal Operation, LVCMOS Input	L	0h or 1h or 2h	1h	X	0h	0h	SECREf/LVCMOS Input
Normal Operation, LVCMOS Input	H	0h or 1h or 3h	X	0h	0h	0h	PRIREF/LVCMOS Input
External Zero Delay Mode, Differential Input	H	0h or 1h or 3h	2h or 3h	1h	1h	1h	Input Clock on PRIREF, Feedback clock on SECREf
External Zero Delay Mode, LVCMOS Input	H	0h or 1h or 3h	1h	0h	1h	1h	Input Clock on PRIREF, Feedback clock on SECREf
Internal Zero Delay Mode, Differential Input	H	0h or 1h or 3h	X	1h	1h	0h	Input clock on PRIREF
Internal Zero Delay Mode, Differential Input	H	0h or 1h or 3h	X	0h	1h	0h	Input clock in PRIREF

- (1) In zero delay mode, all dividers must be programmed such that PLL can lock. On power-up in zero-delay mode, PLL locks automatically
- (2) For internal Zero delay mode, channel 2 is required. Channel 2 must not be powered down
- (3) "X" allows any possible bit-field value without any impact on the functionality

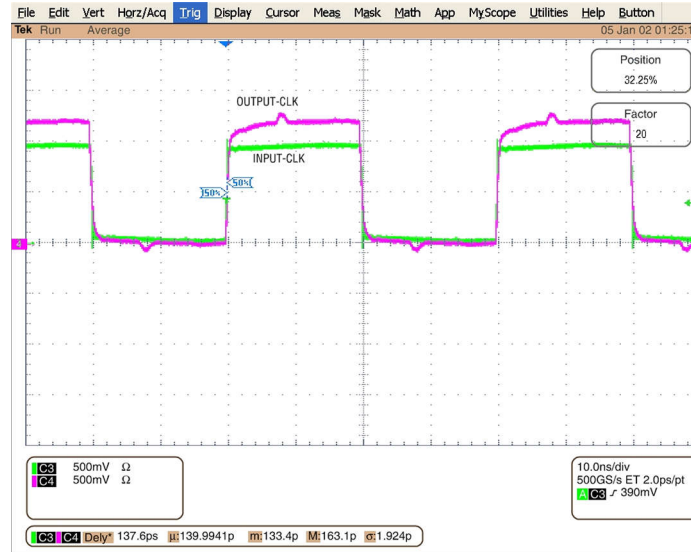

Figure 7-2. Input/Output Alignment in External Zero Delay Mode for LVCMOS Output

7.3.2 Phase-Locked Loop (PLL)

The CDCE6214 has a fully-integrated Phase-Locked Loop (PLL) circuit. The error between a reference phase and an internal feedback phase is compared at the phase-frequency detector. The comparison result is fed to a charge pump that is connected to an integrated loop filter. The control voltage resulting from the loop filter tunes an internal voltage-controlled oscillator (VCO). The frequency of the VCO is fed through a feedback divider (N-counter) back to the PFD.

- Integer and Fractional-N PLL mode of operation.
- First-, Second-, or Third-Order MASH operation in Fractional mode.
- 24-bit Numerator and Denominator can be used to generate fractional frequencies with 0 ppb frequency accuracy.
- PFD operates between 1 MHz and 100 MHz.
- Live Lock Detector (R7[0] or PLL_LOCK in GPIO) provides PLL Lock status (in fractional mode and SSC enabled, lock detect window must be widened. R50[10:8] = 7h). Additionally, sticky bit lock detect (R7[1]) detects if there is any temporary loss of lock.
- Integrated selectable loop filter components.
- For a 25-MHz PFD frequency, PFD bandwidth between 100 kHz and 1.6 MHz can be achieved to optimize PLL to input reference.
- Voltage-controlled oscillator (VCO) ranges from 2335 MHz to 2615 MHz.
- Supports 0.25% and 0.5% center and down spread Spread Spectrum Cloning (SSC) generation. Further, VCO also supports up to 0.5% SSC references at 100 MHz for PCIe clocking.

Table 7-3. Common Clock Generator Loop Filter Settings

f_{VCO} IN MHz	f_{PFD} IN MHz	BW IN MHz	PHASE MARGIN IN °	DAMPING FACTOR	I_{CP} IN mA	C_{Pcap} IN pF	R_{Res} IN kΩ	C_{Zcap} IN pF
2400	25	0.469	70	0.5	0.60	16.1	2.5	580
2400	50	0.938	70	2	0.60	8.2	2.5	276
2400	100	1.60	70	0.5	0.80	8.2	2.5	303
2457.6	61.44	1.04	70	1.15	0.60	9.2	2.0	331
2500	25	0.49	70	0.4	0.60	13.5	2.5	497
2500	50	0.93	70	1.0	0.60	11.7	2.5	386
2400	50	400	65	0.1	0.40	11.7	1.5	636

Table 7-4. Common PLL Divider Settings (1)

INPUT FREQUENCY IN MHz	f _{PFD} IN MHz	OUTPUT FREQUENCY IN MHz	f _{VCO}	N-COUNTER DIVIDER VALUE	NUMERATOR	DENOMINATOR	PSA	OUTPUT DIVIDER
25	50	100	2400	48	NA	NA	4	6
25	25	100	2400	96	NA	NA	4	6
25	50	156.25	2500	50	NA	NA	4	4
25	25	25	2400	96	NA	NA	4	24
25	25	24.576	2457.6	98	5071614	16682942	4	25
25	25	148.5	2376	95	664983	16624579	4	4

(1) Fractional Mode settings are based on DCO mode step size of 0.1ppm

7.3.2.1 PLL Configuration and Divider Settings

$$f_{PFD} = F_{in} / F_{factor} \quad (1)$$

F_{factor} is determined by R25[7:0] - ip_ref_div. F_{factor} = 0.5 when ip_ref_div = 0, F_{factor} = ip_ref_div, otherwise.

$$f_{VCO} = f_{PFD} \times (N + Num/Den). \quad (2)$$

N is set by R30[14:0] - PLL_NDIV. Num is the numerator of the fraction, set by {R32[7:0],R31[15:0]}. Den is the denominator of the fraction, set by R34[7:0],R33[15:0]. When {R34[7:0],R33[15:0]} = 0, Den=2²⁴.

The sigma delta modulator supports different order of MASH to shape the quantization noise. For integer mode, R27[1:0] is set as 0h. For fractional mode, R27[1:0] can be set to 1h, 2h or 3h for first, second and third order, respectively.

In integer mode, PLL is configured in single-ended PFD configuration by setting R51[6]=1h. In fractional mode, PLL must be configured in differential PFD configuration by setting R51[6]=0h. Further, R51[10] is set as 1h in fractional mode and 0h in integer mode.

7.3.2.2 Spread Spectrum Clocking

The energy of the harmonics from the rectangular clock signal can be spread over a certain frequency range. This frequency deviation leads to lowered average amplitude of the harmonics. This can help to mitigate electromagnetic interference (EMI) challenges in a system when the receiver supports this mode of operation. The modulation shape is triangular.

The SSC clock is generated through the fractional-N PLL. When SSC is enabled, SSC clock is available on all clock sourced from the PLL. Reference clock or PFD clock is available on the OUT1–OUT4 pins.

Down spread and center spread are supported. The following modes are supported.

- PFD frequencies: Either 25 MHz or 50 MHz.
- Down spread: –0.25% and ±0.5%
- Center spread: ±0.25% and ±0.5%

Pre-configured settings are available to select any of these combinations.

Using these pre-configured settings, fmod of 31.5 kHz is synthesized for 100-MHz output clock.

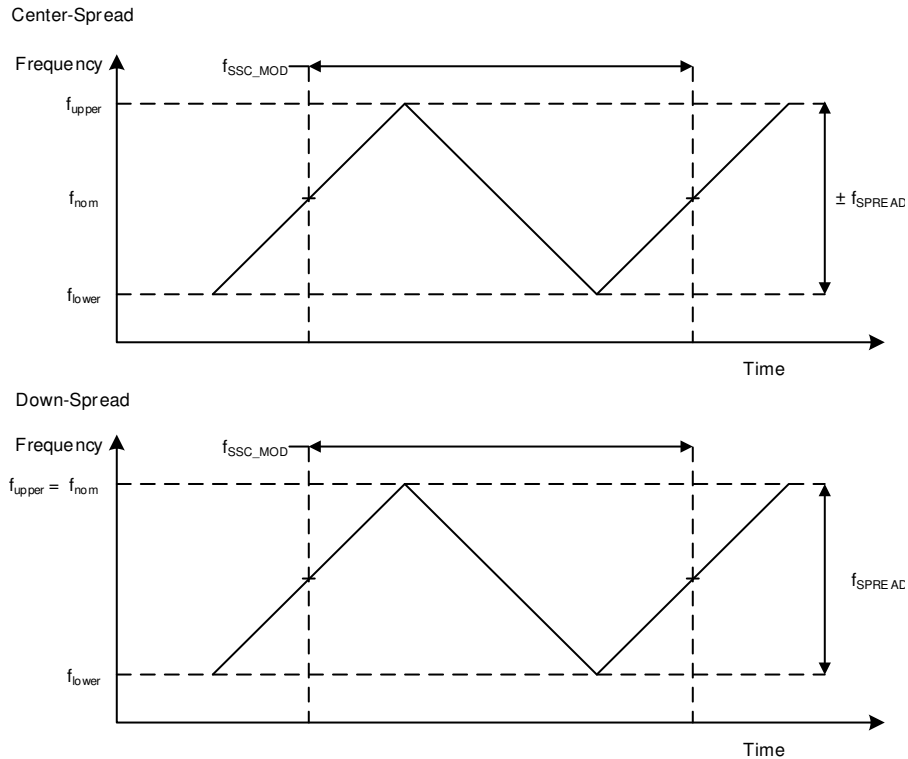

Figure 7-3. Spread Spectrum Clock

Table 7-5. Spread Spectrum Settings ⁽¹⁾ ⁽²⁾

R41[15] - SSC_EN	R42[5] - SSC_TYPE	R42[3:1] - SSC_SEL	DESCRIPTION
0h	X	X	No SSC modulation at output
1h	0h	X	Down spread SSC modulation. SSC spread is determined by ssc_sel
1h	1h	X	Center spread SSC modulation. SSC spread is determined by ssc_sel
1h	X	0h	25-MHz PFD, +/- 0.25% for Center spread, -0.25% for Down spread.
1h	X	1h	25-MHz PFD, +/- 0.50% for Center spread, -0.50% for Down spread.
1h	X	2h	50-MHz PFD, +/- 0.25% for Center spread, -0.25% for Down spread.
1h	X	3h	50-MHz PFD, +/- 0.50% for Center spread, -0.50% for Down spread.
1h	X	4h-7h	Do not use

(1) "X" signifies that this bit field can take any value

(2) For any other SSC spread and modulation rate, please contact a TI representative.

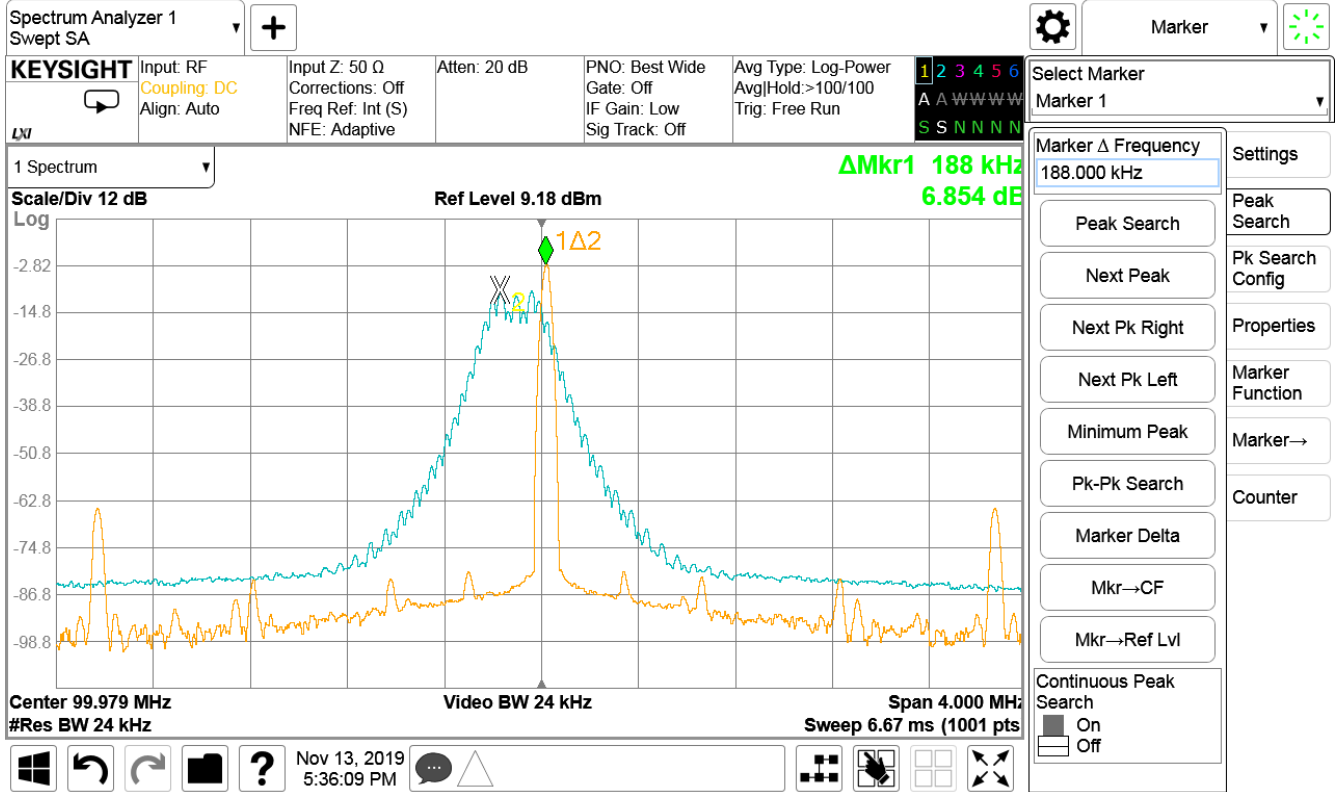

Figure 7-4. 100 MHz With -0.25% Down Spread With and Without Trace

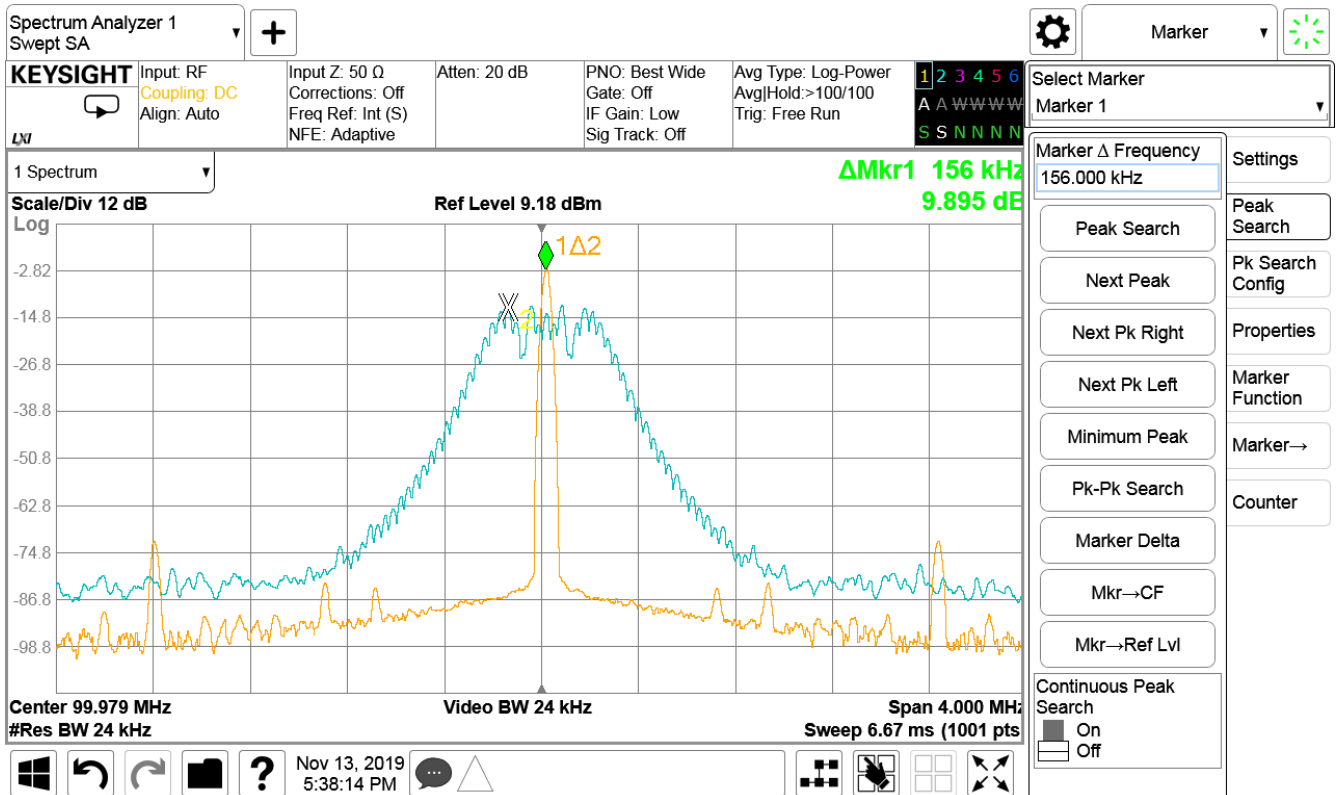

Figure 7-5. 100 MHz With $\pm 0.25\%$ Center Spread With and Without Trace

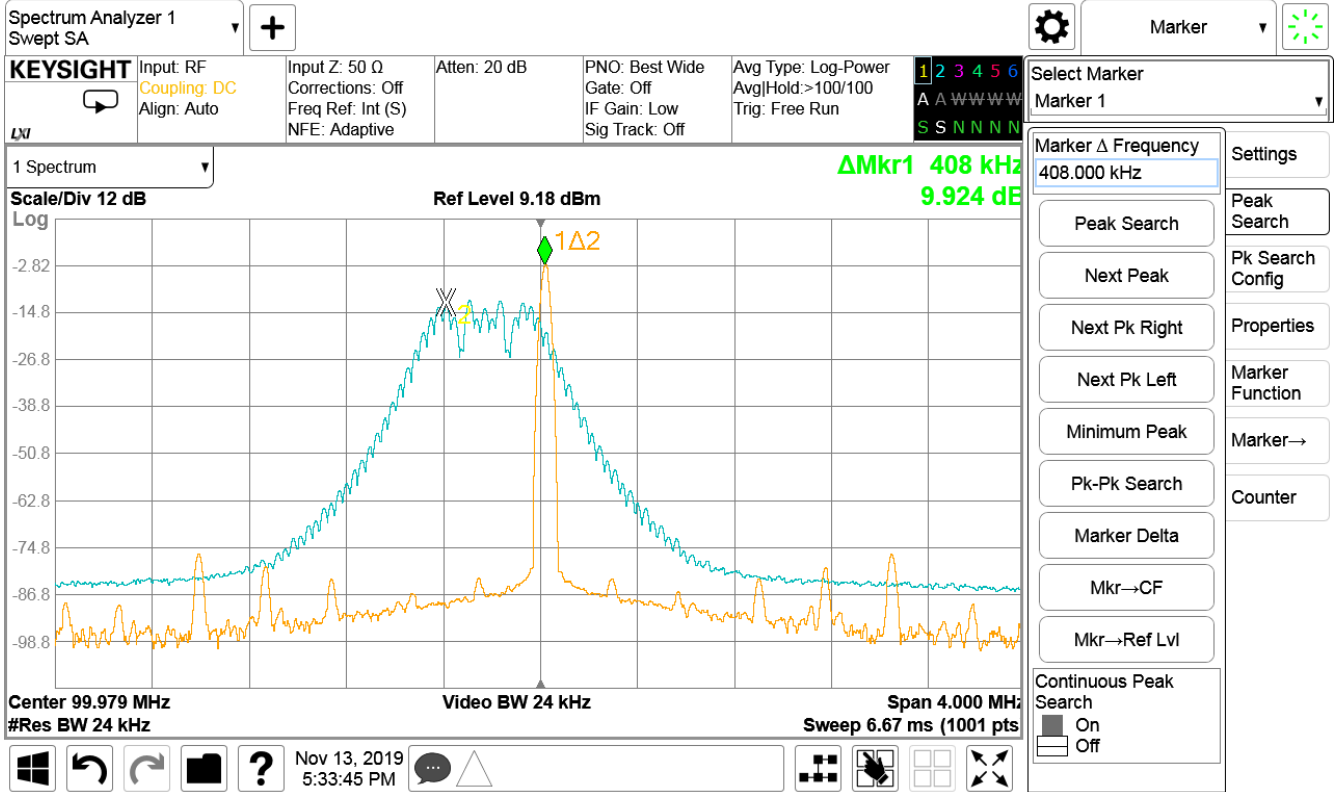

Figure 7-6. 100 MHz With -0.5% Down Spread With and Without Trace

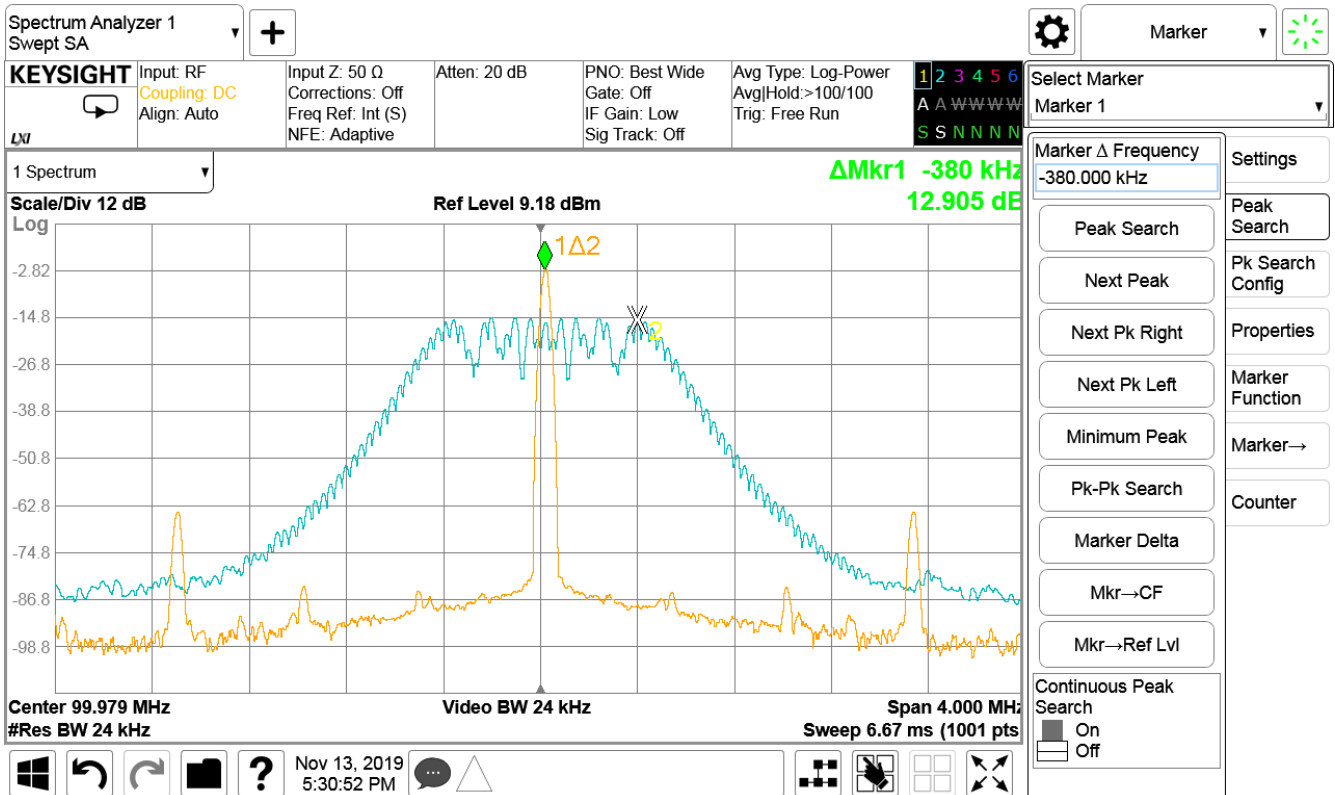

Figure 7-7. 100 MHz With $\pm 0.5\%$ Center Spread With and Without Trace

Table 7-6. PCI Express Compliance Measurement

NO.	CLASS	DATA RATE	ARCHITECTURE	MEASURED PNA METHOD	MEASURED SCOPE METHOD	SPEC LIMIT	RESULT
1	Gen4	16 Gb/s	CC	195 fs	260 fs	500 fs	PASS
2	Gen4	16 Gb/s	SRIS	-	490 fs	500 fs	PASS
3	Gen5	32 Gb/s	CC	87 fs	111 fs	150 fs	PASS
4	Gen5	32 Gb/s	SRIS	-	157 fs	*	*

7.3.2.3 Digitally-Controlled Oscillator and Frequency Increment or Decrement - Serial Interface Mode and GPIO Mode

In this mode, the output clock frequency can be incremented or decremented by a fixed frequency step. The frequency step size is determined by the register R43[15:0]. This value is added or subtracted to the numerator of the sigma-delta modulator. Every rising edge of `FREQ_INC` signal increases the output frequency, while every rising edge of `FREQ_DEC` signal decreases the output frequency. There are two ways to trigger the increment or decrement:

1. Appropriate configuration of the GPIOs and sending a `FREQ_INC` or `FREQ_DEC` signal through an external microcontroller or ASIC.
2. Using register bit fields controlled through serial interface.

Table 7-7. Register Settings for Frequency Increment or Decrement Functionality

REGISTER BIT ADDRESS	REGISTER BIT FIELD NAME	DESCRIPTION
R3[3]	FREQ_INC_DEC_EN	Enables/Disables DCO mode
R3[4]	FREQ_INC_DEC_REG_MODE	Selects DCO trigger through GPIOs or Serial Interface.
R3[6:5]	FREQ_DEC_REG, FREQ_INC_REG	Generates <code>FREQ_INC</code> or <code>FREQ_DEC</code> signal through serial Interface
R43[15:0]	FREQ_INC_DEC_DELTA	Frequency Increment or Decrement step size

Table 7-8. Computing Divider Settings in DCO Mode

PARAMETERS	VALUE (EXAMPLE)	DESCRIPTION
Input PFD Frequency (F_{PFD})	25 MHz	Set according to F_{PFD} .
Expected VCO Frequency (F_{VCO})	2457.6 MHz	F_{VCO} is set within the operating VCO range of 2335 MHz to 2625 MHz. F_{VCO} is selected such that $PSA/PSB/Output\ Divider$ is Integer.
Expected Output Frequency (F_{OUT})	24.576 MHz	$PSA = 4$, $IOD = 25$. $F_{VCO} = PSA \times IOD \times F_{OUT}$.
Expected step size (in ppm) (F_{step})	0.1	Every rising edge of <code>FREQ_INC</code> or <code>FREQ_DEC</code> changes the output by this step size.
N-divider Value (N)	98	$INT(F_{VCO}/F_{PFD})$
Minimum Numerator value to meet 0ppb accuracy (Num)	76	These values are computed to meet accuracy requirement at output. Must be less than 2^{24} .
Minimum Denominator to meet 0ppb accuracy (Den)	250	
Minimum Denominator value to meet ppm step size ($F_{DEN,min}$)	101725.26	$1/(F_{step} \times 1e6) / (F_{VCO}/F_{PFD})$
Final Denominator value ($F_{DEN,final}$)	500000	$F_{DEN,final}$ must be greater than $F_{DEN,min}$ and less than 2^{24} . $F_{DEN,final}$ and $F_{NUM,final}$ must be an integer multiple of Den and Num respectively. $F_{DEN,final}/Den = F_{NUM,final}/Num$
Final Numerator value ($F_{NUM,final}$)	152000	
Increment or Decrement step size	5	This value must be less than $2^{16}-1$. $F_{DEN,final}$ must be closest integer multiple of $F_{DEN,min}$.

7.3.3 Clock Distribution

The VCO output connects to two individually configurable pre-scalar dividers sourcing the on-chip clock distribution – PSA and PSB. PSA and PSB can be configured as division value of /4, /5 or /6 independently.

The clock distribution consists of four output channels. Each output channel contains an integer divider (IOD) with glitchless switching and synchronization capabilities.

IOD can be sourced from either the PSA, the PSB, or the Reference Clock. IOD can be bypassed to provide a Reference clock at the output.

There are five output channels – OUT0, OUT1, OUT2, OUT3, and OUT4.

The OUT0 is a slew-rate controllable LVCMOS output. Either the reference clock or PFD clock can be routed to this output through the clock distribution network.

The OUT1 and OUT4 are identical output channels. The output buffers in this channel are compatible with various signaling standards – LVCMOS, LP-HCSL, and LVDS-like.

The OUT2 and OUT3 are identical output channels. The output buffers in this channel are compatible with various signaling standards – LP-HCSL and LVDS-like.

- The LP-HCSL output buffer can be directly connected to the receiver without any termination resistor to GND. The output impedance of LP-HCSL is trimmed to $50\ \Omega \pm 10\%$. A series resistor can be used to adapt to the trace impedance.
- The LVDS-like requires a differential termination connected between the positive and negative polarity output pins. The termination can be connected directly or through an AC-coupling capacitor. For a 50- Ω system, a 100- Ω differential termination is appropriate.
- LVCMOS outputs are designed for capacitive loads only. The polarity of the positive and negative output pins can be configured individually.

The differential buffers support wide range of output frequencies up to 328.125 MHz. LVCMOS supports up to 200 MHz.

Table 7-9. Configuring Input Reference, PFD, or PLL Clock to Output ⁽¹⁾

REGISTER BIT ADDRESS	REGISTER BIT FIELD NAME	DESCRIPTION
R25[10]	IP_BYP_OUT0_EN	Enables Reference Clock or PFD Clock to OUT0.
R25[9]	REF_CH_MUX	Selects between PFD Clock or Input Reference Clock
R25[14:11]	IP_REF_TO_OUT4_EN, IP_REF_TO_OUT3_EN, IP_REF_TO_OUT2_EN, IP_REF_TO_OUT1_EN	Selects reference clock to OUT1-OUT4
R56[15:14]	CH1_MUX	Clock selection MUX control for OUT1
R62[15:14]	CH2_MUX	Clock selection MUX control for OUT2
R67[15:14]	CH3_MUX	Clock selection MUX control for OUT3
R72[15:14]	CH4_MUX	Clock selection MUX control for OUT4

(1) TI recommends to disable any clock when not in use to reduce crosstalk

Table 7-10. Configuring Clock Distribution Network

REGISTER BIT ADDRESS	REGISTER BIT FIELD NAME	DESCRIPTION
R47[6:5]	PLL_PSB	Programmable Pre-scalar divider PSB
R47[4:3]	PLL_PSA	Programmable Pre-scalar divider PSA
R56[13:0]	CH1_DIV	OUT1 Integer Divider value
R62[13:0]	CH2_DIV	OUT2 Integer Divider value
R67[13:0]	CH3_DIV	OUT3 Integer Divider value
R72[13:0]	CH4_DIV	OUT4 Integer Divider value

Table 7-11. Configuring LVCMOS Output Buffer (1) (2)

REGISTER BIT ADDRESS	REGISTER BIT FIELD NAME	DESCRIPTION
R78[12]	CH0_EN	Enables OUT0 LVCMOS Buffer
R79[3:0]	CH0_CMOS_SLEW_RATE_CTRL	Controls output slew rate of OUT0 LVCMOS Buffer
R59[14], R75[14]	CH1_CMOSN_EN, CH4_CMOSP_EN	Enables OUT1N/OUT4P LVCMOS Buffer
R59[13], R75[13]	CH1_CMOSP_EN, CH4_CMOSN_EN	Enables OUT1P/OUT4N LVCMOS Buffer
R59[12], R75[12]	CH1_CMOSN_POL, CH4_CMOSP_POL	Sets output polarity of OUT1N/OUT4P LVCMOS Buffer
R59[11], R75[11]	CH1_CMOSP_POL, CH4_CMOSN_POL	Sets output polarity of OUT1P/OUT4N LVCMOS Buffer
R60[3:0], R76[3:0]	CH1_CMOS_SLEW_RATE_CTRL, CH4_CMOS_SLEW_RATE_CTRL	Controls output slew rate of OUT1/OUT4 LVCMOS Buffer

- (1) Multiple output buffers must not be enabled at the same time
- (2) Based on the VDDO levels, ch1_1p8vdet, ch2_1p8vdet, ch3_1p8vdet, ch4_1p8vdet must be set accordingly. When setting for 1.8 V, safety_1p8v_mode must be set.

Table 7-12. Configuring LP-HCSL Output Buffer (1) (2) (3)

REGISTER BIT ADDRESS	REGISTER BIT FIELD NAME	DESCRIPTION
R57[14], R63[13], R68[13], R73[13]	CH1_HCSL_EN, CH2_HCSL_EN, CH3_HCSL_EN, CH4_HCSL_EN	Enables LP-HCSL buffer on OUT1/OUT2/OUT3/OUT4

- (1) Multiple output buffers must not be enabled at the same time
- (2) External termination not needed. Voltage mode driver.
- (3) Based on the VDDO levels, ch1_1p8vdet, ch2_1p8vdet, ch3_1p8vdet, ch4_1p8vdet must be set accordingly. When setting for 1.8 V, safety_1p8v_mode must be set.

Table 7-13. Configuring LVDS-Like Output Buffer (1) (2) (3)

REGISTER BIT ADDRESS	REGISTER BIT FIELD NAME	DESCRIPTION
R59[15], R65[11], R70[11], R75[15]	CH1_LVDS_EN, CH2_LVDS_EN, CH3_LVDS_EN, CH4_LVDS_EN	Enables LVDS-like buffer on OUT1/OUT2/OUT3/OUT4
R60[15:12], R66[3:0], R71[3:0], R76[9:6]	CH1_DIFFBUF_IBIAS_TRIM, CH2_DIFFBUF_IBIAS_TRIM, CH3_DIFFBUF_IBIAS_TRIM, CH4_DIFFBUF_IBIAS_TRIM	Sets the output swing and output common mode of OUT1/OUT2/OUT3/OUT4
R60[11:10], R66[5:4], R71[5:4], R76[5:4]	CH1_LVDS_CMTRIM_INC, CH2_LVDS_CMTRIM_INC, CH3_LVDS_CMTRIM_INC, CH4_LVDS_CMTRIM_INC	Increases the output common mode of OUT1/OUT2/OUT3/OUT4. 2.5 V/3.3 V mode only.
R60[5:4], R65[14:13], R71[10:9], R77[1:0]	CH1_LVDS_CMTRIM_DEC, CH2_LVDS_CMTRIM_DEC, CH3_LVDS_CMTRIM_DEC, CH4_LVDS_CMTRIM_DEC	Decreases the output common mode of OUT1/OUT2/OUT3/OUT4. For 2.5-V or 3.3-V mode only.

- (1) Multiple output buffers must not be enabled at the same time.
- (2) 100 Ω differential termination needed in DC-coupled mode. A 50-Ω, single-ended or 100-Ω differential termination is needed in AC-coupled mode
- (3) Based on the VDDO levels, ch1_1p8vdet, ch2_1p8vdet, ch3_1p8vdet, ch4_1p8vdet must be set accordingly. When setting for 1.8 V, safety_1p8v_mode must be set.

7.3.3.1 Glitchless Operation

The bit fields ch{x}_glitchless_en can be used to enable glitchless output divider update. This feature verifies that the high pulse of a clock period is not cut off by the output divider update process. This feature also verifies that setup and hold time of a receiver is not violated. The low pulse in the transition from earlier period to the new period is extended accordingly.

Glitch-Less Divider Disabled:

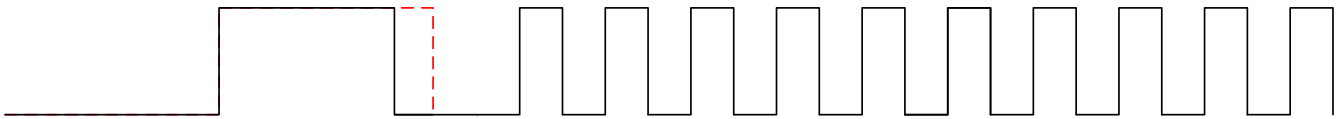

Glitch-Less Divider Enabled:

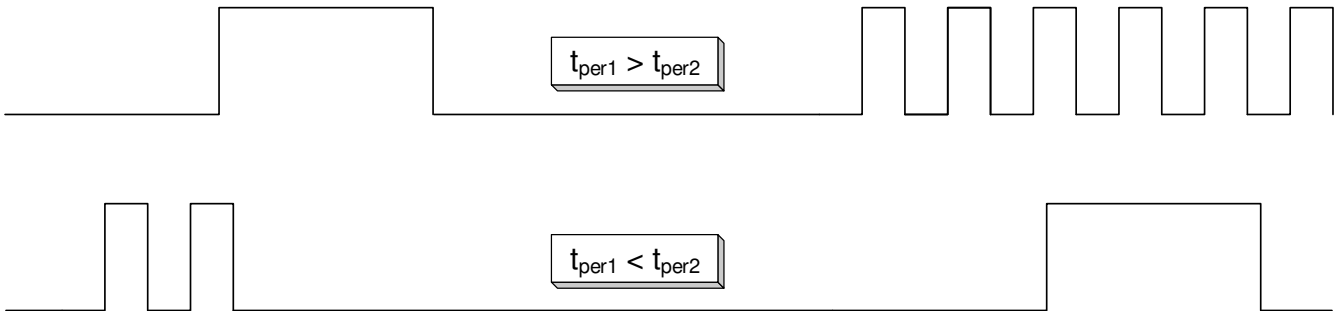

Figure 7-8. Glitchless Divider Update

7.3.3.2 Divider Synchronization

The output dividers can be reset in a deterministic way. This can be achieved using the sync bit or PDN pin. The level of the pin is qualified internally using the reference frequency at the PFD input. A low level on the SYNCN pin or sync bit mutes the outputs. A high level synchronously releases all output dividers to operation so that all outputs share a common rising edge. The first rising edge can be individually delayed in steps of the respective pre-scalar period, up to 32 cycles using `ch{x}_sync_delay`. This allows the user to compensate external delays like routing mismatch, cables, or inherent delays introduced by logic gates in an FPGA design. Each channel can be included or excluded from the SYNC process. Divider synchronization can be enabled individually by `ch{x}_sync_en`.

For a deterministic behavior over power-cycles seen from input to output, the reference divider must be set to 1. The reference divider must not divide the reference clock or use the reference doubler.

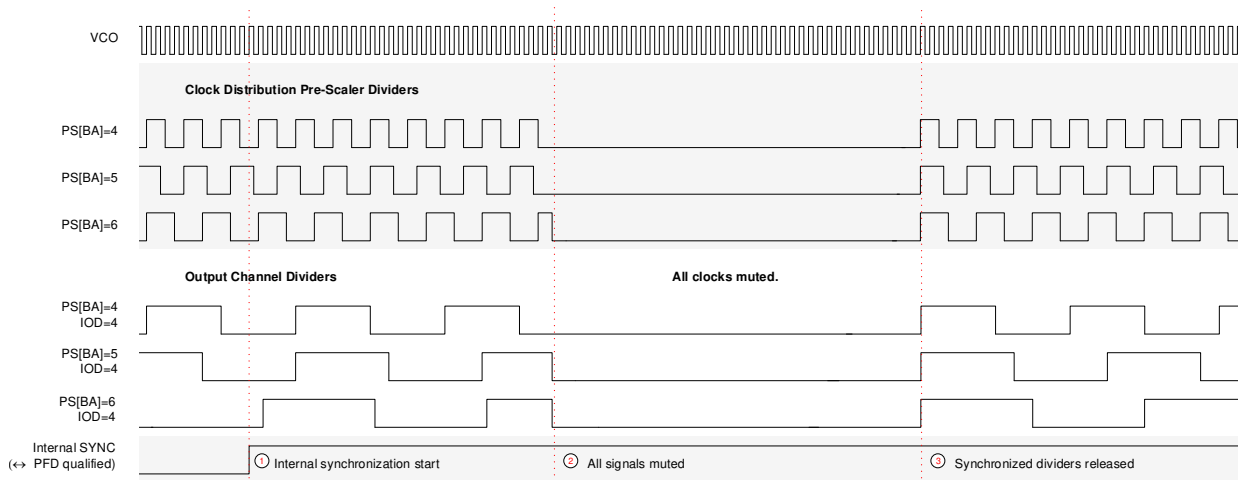

Figure 7-9. Output Divider Synchronization

7.3.3.3 Global and Individual Output Enable

The output enable functionality allows the user to enable or disable all or a specific output buffer. The bypass copy on OUT0 is excluded from the global output enable signal. When an output is disabled, the signal drives a configurable mute-state. When the serial interface is deactivated, one can use all individual output enable signals at the same time. The individual output enable signal controls the respective output channel integer divider to gate the clock, therefore each integer divider must be active.

The individual output enable signal enables and disables the respective output in a deterministic way. Therefore the high and low level of the signal is qualified by counting four cycles of the respective output clock.

1. The OE falling edge disables the output. The output is enabled for 4 cycles after asserting the Output Enable of a channel. This enables any further operation in the system after OE is asserted.
2. The OE rising edge enables the output. Outputs starts toggling after 4 internal clock cycles.

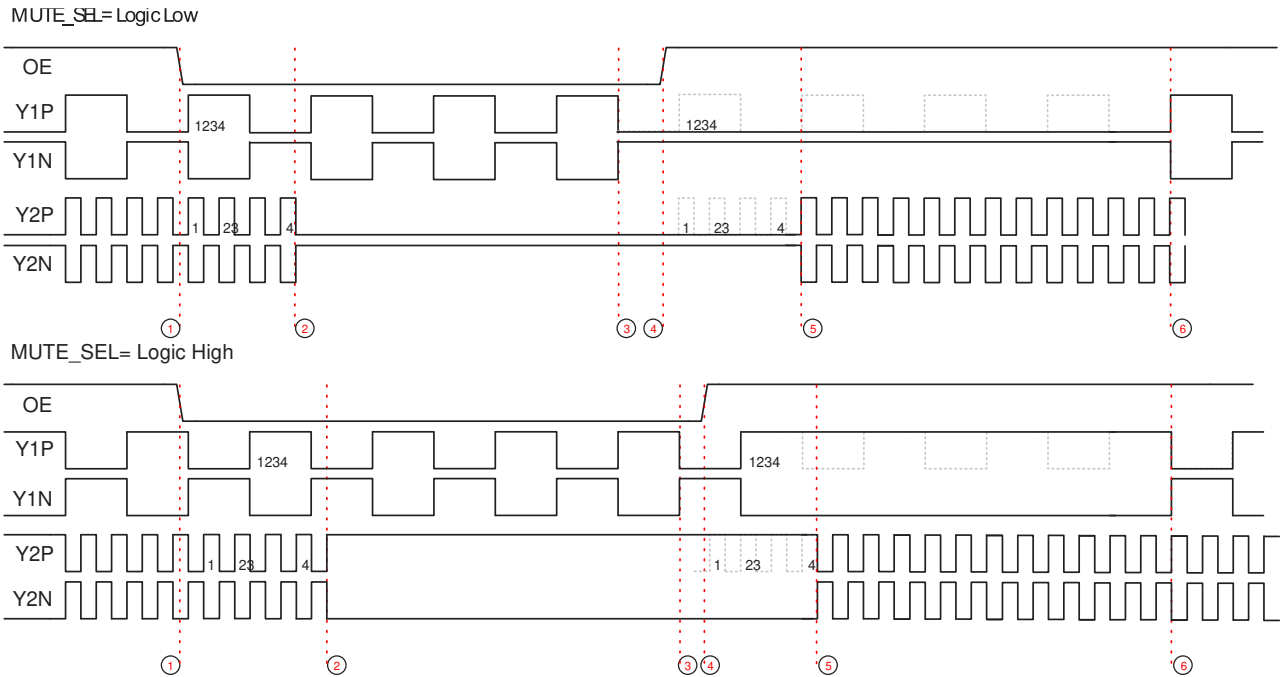

Figure 7-10. Individual Output Enable and Disable

Table 7-14. Glitchless Operation and Divider Synchronization

REGISTER BIT ADDRESS	REGISTER BIT FIELD NAME	DESCRIPTION
R0[14]	PDN_INPUT_SEL	Configures PDN pin as PDN or SYNCN
R0[5]	SYNC	Generates SYNC signal through serial interface
R57[9], R63[9], R68[9], R73[9]	CH1_GLITCHLESS_EN, CH2_GLITCHLESS_EN, CH3_GLITCHLESS_EN, CH4_GLITCHLESS_EN	Enables Glitchless switching for OUT1/OUT2/ OUT3/OUT4
R57[3], R63[3], R68[3], R73[3]	CH1_SYNC_EN, CH2_SYNC_EN, CH3_SYNC_EN, CH4_SYNC_EN	Enables SYNC for OUT1/OUT2/OUT3/OUT4
R57[1], R63[1], R68[1], R73[1]	CH1_MUTESEL, CH2_MUTESEL, CH3_MUTESEL, CH4_MUTESEL	Sets Output level when mute on OUT1/ OUT2/OUT3/OUT4
R57[0], R63[0], R68[0], R73[0]	CH1_MUTE, CH2_MUTE, CH3_MUTE, CH4_MUTE	Mutes output on OUT1/OUT2/OUT3/OUT4

7.3.4 Power Supplies and Power Management

The CDCE6214 provides multiple power supply pins. Each of the power supplies supports 1.8 V, 2.5 V, or 3.3 V individually. Internal low-dropout regulators (LDO) source the internal blocks and allow each pin to be supplied with an individual supply voltage. The VDDREF pin supplies the control pins and the serial interface, therefore any pullup resistors are connected to the same domain as VDDREF.

The device is very flexible with respect to internal power management. Each block offers a power-down bit and can be disabled to save power when the block is not required. [Table 7-15](#) shows the available bits. The bypass output Y0 is connected to the pdn_ch4 bit. Each output channel has a bit which must be adapted to the applied supply voltage, ch[4:1]_1p8vdet.

Table 7-15. Power Management

VDDREF	VDDVCO	VDDO_12	VDDO_34
R0[1] - POWERDOWN	R0[1] - POWERDOWN	R0[1] - POWERDOWN	R0[1] - POWERDOWN
	R5[8] - PLL_VCOBUFF_LDO_PD	R4[4] - CH1_PD	R4[6] - CH3_PD
	R5[7] - PLL_VCO_LDO_PD	R4[5] - CH2_PD	R4[7] - CH4_PD
	R5[6] - PLL_VCO_BUFF_PD		
	R5[5] - PLL_CP_LDO_PD		
	R5[4] - PLL_LOCKDET_PD		
	R5[3] - PLL_PSB_PD		
	R5[2] - PLL_PSA_PD		
	R5[1] - PLL_PFD_PD		
	R53[6] - PLL_NCTR_EN		
	R53[3] - PLL_CP_EN		

7.3.5 Control Pins

The ultra-low power clock generator is controlled by multiple LVCMOS input pins.

The HW_SW_CTRL pin acts as an EEPROM page select. The CDCE6214 clock generator contains two pages of configuration settings. The level of this pin is sampled after device power up. A low level selects page zero. A high level selects page one. The HW_SW_CTRL pin is a tri-level input pin. This third voltage level is automatically applied by an internal voltage divider. The mid-level is used to select an internal default where the serial interface is enabled.

The PDN/SYNCN (pin 8), SCL (pin 12), and SDA (pin 19) have a secondary functionality and can act as general-purpose inputs and outputs (GPIO). This means that either the serial interface or the GPIO functionality can be active.

The PDN/SYNCN resets the internal circuitry and is used in the initial power-up sequence. The pin can be reconfigured to act as synchronization input. The differential outputs are kept in mute while SYNCN is low. When SYNCN is high, outputs are active.

When the SSC_EN bit is set to 1, then SSC is enabled regardless of the pin state.

When the SSC_EN bit is set to 0, then the SSC functionality can be controlled by the GPIO pins. This is limited to starting up with SSC enabled (GPIOx = HIGH), then disabling by pulling the GPIOx pin low.

Table 7-16. Control and GPIO Pins

PIN NO.	NAME	TYPE	2-LEVEL INPUT	3-LEVEL INPUT	OUTPUT	TERMINATION
23	HW_SW_CTRL	Input	-	Yes	-	PUPD
20	GPIO1	Input/Output	Yes	-	Yes	-
19	GPIO2	Input/Output	Yes	-	Yes	Open-Drain I/O in I ² C mode, CMOS (Input)
12	GPIO3	Input	Yes	-	-	-

Table 7-16. Control and GPIO Pins (continued)

PIN NO.	NAME	TYPE	2-LEVEL INPUT	3-LEVEL INPUT	OUTPUT	TERMINATION
11	GPIO4	Input/Output	Yes	-	Yes	-
8	PDN	Input	Yes	-	-	PU (when Input)
4	REFSEL	Input	-	Yes	-	PUPD

Table 7-17. GPIO Input and Output Signal List

ABBREVIATION	TYPE	DESCRIPTION
FREQ_INC	Input	Frequency Increment; Increments the MASH numerator
FREQ_DEC	Input	Frequency Decrement; Decrements the MASH numerator
OE (global)	Input	Enables or disables all differential outputs Y[4:1] (bypass not affected)
SSC_EN	Input	Enables or disables SSC.
OE1	Input	Enables or disables OUT1
OE2	Input	Enables or disables OUT2
OE3	Input	Enables or disables OUT3
OE4	Input	Enables or disables OUT4
PLL_LOCK	Output	PLL Lock Status. 0 = PLL out of lock; 1 = indicates PLL in lock

7.4 Device Functional Modes

7.4.1 Operation Modes

The operating modes listed in [Table 7-18](#) can be set, and the GPIOs configured. An operating mode change only becomes effective when the change is loaded from the EEPROM after a power cycle.

Table 7-18. Modes of Operations

DESCRIPTION	MODE	REFSEL	HW_SW_CTRL	GPIO1	GPIO2	GPIO3	GPIO4
I ² C + GPIO	Fall-back	M	M	I/O	SDA	SCL	I/O
		M	L/H	I/O	SDA	SCL	I/O
		L/H	M	I/O	SDA	SCL	I/O
OE	Pin Mode	L/H	L/H	OE1	OE2	OE3	OE4
I ² C + GPIO	Serial Interface Mode	L/H	L/H	I/O	SDA	SCL	I/O

7.4.1.1 Fall-Back Mode

As the programming interface can be intentionally deactivated using the EEPROM, an accidental disabling of the I²C blocks further access to the device. The serial interface can be forced using the fall-back mode. To enter this mode, the user leaves pin 4 or pin 23 floating while the supply voltage is applied to VDDREF. In this mode, EEPROM Read at power up is bypassed and device boots in default mode. In this mode, pin 11 is pre-configured as an input and pin 20 is configured as an output. After powering up in fall-back mode, the device can be re-programmed through serial interface and be re-configured for normal operation. EEPROM can also be re-programmed. The PLL is not auto-calibrated, however, and the I²C interface is active. This mode allows the user to fully configure the device before re-locking the PLL.

7.4.1.2 Pin Mode

In pin mode, the pins 12 and 19 are input pins which act as individual output enable pins. Together with pins 11 and 20, this allows for one output enable pin per output channel.

7.4.1.3 Serial Interface Mode

In serial interface mode, pins 12 and 19 are configured as an I²C interface.

7.5 Programming

7.5.1 I²C Serial Interface

The CDCE6214 ultra-low power clock generator provides an I²C-compatible serial interface for register and EEPROM access. The device is compatible to standard-mode I²C at 100 kHz and the fast-mode I²C at 400-kHz clock frequency.

1. In fall-back mode with REFSEL floating, I²C target address = 67h.
2. In other modes, I²C target address = 68h when the interface is available. By default, the interface is not available.
3. The LSB bit of the device can be programmed in the EEPROM. For example, if I2C_A0 is programmed H in Page 0 of EEPROM, setting HW_SW_CTRL=0 sets the I²C address as 69h.
4. Two devices with EEPROM + 1 device in fall-back mode can be used on the same I²C bus with addresses 67h, 68h and 69h.

Table 7-19. I²C-Compatible Serial Interface, Target Address Byte (1) (2)

7	6	5	4	3	2	1	0
Target Address [6:0]							R/W# Bit

(1) The target address consists of two sections. The hardwired MSBs A[6:1] and the software-selectable LSBs A[0].

(2) The R/W# bit indicates a read (1) or a write (0) transfer.

Table 7-20. I²C-Compatible Serial Interface, Programmable Target Address (1) (2)

A6	A5	A4	A3	A2	A1	A0	HW_SW_SEL	REFSEL	DESCRIPTION
1	1	0	0	1	1	1	L/M/H	M	Fall-back Mode
1	1	0	1	0	0	0	M	L/H	Fall-back Mode
1	1	0	1	0	0	I2C_A0	L	L/H	EEPROM Page 0
1	1	0	1	0	0	I2C_A0	H	L/H	EEPROM Page 1

(1) In EEPROM Page 0, Serial Interface is not available. Device is configured in Pin Mode.

(2) In EEPROM Page 1, Serial Interface is not available. Device is configured in Pin Mode.

The serial interface uses the following protocol as shown in Figure 7-11. The target address is followed by a word-wide register offset and a word-wide register value.

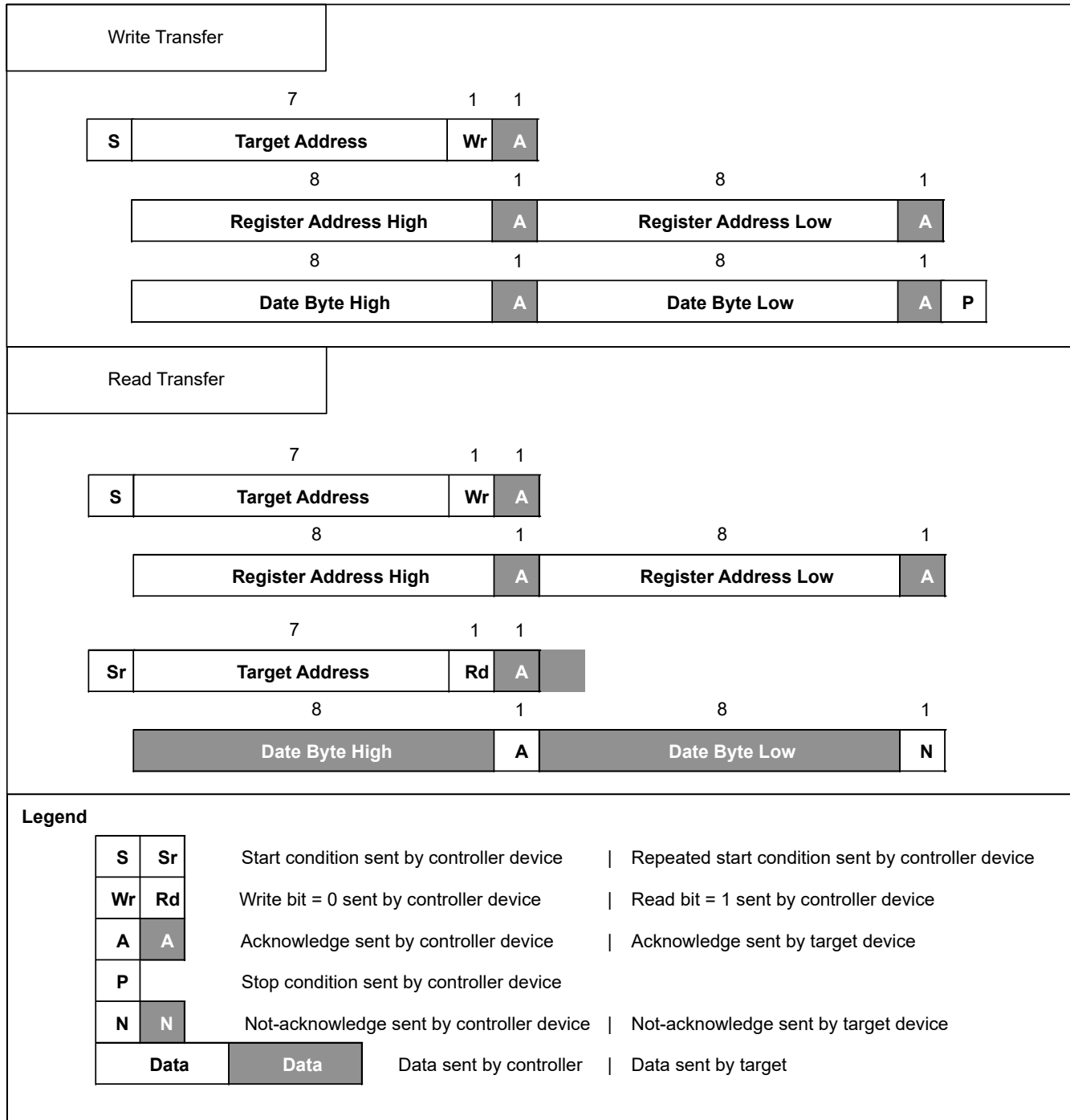

Figure 7-11. I²C-Compatible Serial Interface, Supported Protocol

7.5.2 EEPROM

7.5.2.1 EEPROM - Cyclic Redundancy Check

The device contains a cyclic redundancy check (CRC) function for reads from the EEPROM to the device registers. At start-up, the EEPROM is read internally and a CRC value calculated. One of the EEPROM words contains an earlier stored CRC value. The stored and the actual CRC value are compared and the result transferred to register. The CRC calculation can be triggered again by writing a 1 to the update_crc bit. A mismatch between stored and calculated CRC value is informational only and non-blocking to the device operation. Just reading back the CRC status bit and the live CRC value can speed up in-system EEPROM programming and avoid reading back each word of the EEPROM for known configurations.

The polynomial used is CCITT-CRC16: $x^{16} + x^{12} + x^5 + 1$.

7.5.2.2 Recommended Programming Procedure

TI recommends programming the registers of the device in the following way:

1. Read-back factory default EEPROM page configuration. Each device has different EEPROM base page configurations.
2. Modify register bits.
3. Verify that the ee_lock is set to 5h (unlock) when overwriting the EEPROM.
4. Program register addresses in descending order from 0x53 to 0x00 including all register addresses with reserved values.

7.5.2.3 EEPROM Access

Note

The EEPROM word write access time is typically 8 ms.

There are two methods to write into the internal EEPROM

1. Register Commit method.
2. EEPROM Direct Access Method

Use the following steps to bring the device into a good known configuration.

1. Power down all the supplies.
2. Apply PDN = LOW.
3. REFSEL and HW_SW_CTRL pins can be High, Low or High-Z. For factory programmed device, I²C interface is not available for any HW_SW_CTRL pin state. EEPROM can only be programmed in fall-back mode.
4. Apply power supplies to all VDD pins. When device operation is not required, apply power supply to VDDREF.
5. Apply PDN = HIGH.
6. Use the I²C interface to configure the device.

7.5.2.3.1 Register Commit Flow

In the Register Commit flow, all bits from the device registers are copied into the EEPROM. The recommended flow is:

1. Pre-configure the device as desired, except the serial interface using mode.
2. Write 1 to RECAL to calibrate the VCO in this operation mode.
3. Select the EEPROM page, to copy the register settings into, using REGCOMMIT_PAGE.
4. Unlock the EEPROM for write access with EE_LOCK = x5.
5. Start the register commit operation by writing 1 to REGCOMMIT.
6. Force a CRC update by writing a 1 to UPDATE_CRC.
7. Read back the calculated CRC in NVMLCRC.

- Store the read CRC value in the EEPROM by writing 0x3F to NVM_WR_ADDR and then the CRC value to NVM_WR_DATA.

7.5.2.3.2 Direct Access Flow

In the EEPROM direct access flow, the EEPROM words are directly accessed using the address and the data bit-fields. The recommended flow is:

- Prepare an EEPROM image consisting of 64 words of 16 bits each.
- Unlock the EEPROM for write access with EE_LOCK = 0x5.
- Write the initial address offset to the address bit-field. Write a 0x00 to NVM_WR_ADDR.
- Loop through the EEPROM image from address 0 to 63 by writing each word from the image to NVM_WR_DATA. The EEPROM word address is automatically incremented by every write access to NVM_WR_DATA.



Figure 7-12. EEPROM Direct Access Using I²C

7.5.2.4 Register Bits to EEPROM Mapping

Register bits settings are mapped into EEPROM. EEPROM is divided into three segments:

- EEPROM Base Page: Selectable by connecting HW_SW_CTRL pin either to Logic 0 to Logic 1.
- EEPROM Page 0: Selectable by connecting HW_SW_CTRL pin to Logic 0.
- EEPROM Page 1: Selectable by connecting HW_SW_CTRL pin to Logic 1.

Table 7-21. EEPROM Mapping (1) (2) (3) (4)

	15	14	13	12	11	10	9	8	7	6	5	4	3	2	1	0
0	0	1	1	1	R5[8]	R5[7]	R5[6]	R5[5]	R5[4]	R5[1]	R4[3]	R4[2]	R4[1]	R4[0]	R3[9]	R0[3]
1	0	1	0	0	1	0	0	0	0	1	1	1	1	1	R15[5]	1
2	0	0	0	1	1	0	1	1	0	0	0	1	0	0	1	0
3	0	0	0	0	0	0	0	0	0	0	0	0	0	0	0	0
4	R48[4]	R48[3]	R48[2]	R48[1]	R48[0]	R47[1]	R47[1]	R47[1]	R47[9]	R47[8]	R47[7]	0	0	0	0	0
5	0	R49[4]	R49[3]	R49[2]	R49[1]	R49[0]	R48[1]	R48[1]	R48[1]	R48[1]	R48[1]	R48[9]	R48[8]	R48[7]	R48[6]	R48[5]
6	0	0	0	R50[1]	R50[9]	R50[8]	1	1	0	0	0	0	0	0	0	0
7	R55[6]	R53[6]	1	R53[2]	R53[1]	R53[0]	1	0	1	0	0	0	0	0	0	0
8	1	0	0	0	0	0	1	R58[4]	R58[3]	R58[2]	R58[1]	R58[0]	0	R55[9]	R55[8]	R55[7]
9	0	1	R60[1]	R60[1]	R60[1]	R60[1]	R60[3]	R60[2]	R60[1]	R60[0]	R59[9]	R59[8]	R59[7]	R59[6]	R59[5]	R59[4]
10	R65[8]	R65[7]	R65[6]	R65[5]	R65[4]	1	0	0	0	0	R64[9]	R64[8]	R64[7]	R64[6]	R64[5]	0
11	0	0	0	R69[9]	R69[8]	R69[7]	R69[6]	R69[5]	0	0	1	R66[3]	R66[2]	R66[1]	R66[0]	R65[9]
12	R74[5]	0	0	1	R71[3]	R71[2]	R71[1]	R71[0]	R70[9]	R70[8]	R70[7]	R70[6]	R70[5]	R70[4]	1	0
13	R76[0]	R75[9]	R75[8]	R75[7]	R75[6]	R75[5]	R75[4]	1	0	0	0	0	R74[9]	R74[8]	R74[7]	R74[6]
14	0	0	0	0	0	R79[3]	R79[2]	R79[1]	R79[0]	R76[9]	R76[8]	R76[7]	R76[6]	R76[3]	R76[2]	R76[1]
15	0	0	0	0	0	0	R81[3]	1	0	0	0	0	0	0	R80[3]	0
16	R1[6]	R1[5]	R1[4]	R1[3]	R1[2]	R1[1]	R1[0]	R0[15]	R0[14]	R0[13]	R0[12]	0	R0[10]	0	R0[8]	R0[0]
17	R2[6]	R2[5]	R2[4]	R2[3]	R2[2]	R2[1]	R2[0]	R1[15]	R1[14]	R1[13]	R1[12]	R1[11]	R1[10]	R1[9]	R1[8]	R1[7]
18	0	R5[3]	R5[2]	R4[7]	R4[6]	R4[5]	R4[4]	R3[4]	R3[3]	R2[13]	R2[12]	R2[11]	R2[10]	R2[9]	R2[8]	R2[7]
19	R24[1]	R24[1]	R24[1]	R24[1]	R24[9]	R24[8]	0	0	R24[5]	R24[4]	R24[3]	R24[2]	R24[1]	R24[0]	0	0
20	R27[0]	0	R25[1]	R25[1]	R25[1]	R25[1]	R25[1]	R25[9]	R25[7]	R25[6]	R25[5]	R25[4]	R25[3]	R25[2]	R25[1]	R25[0]
21	R30[1]	R30[1]	R30[1]	R30[1]	R30[1]	R30[9]	R30[8]	R30[7]	R30[6]	R30[5]	R30[4]	R30[3]	R30[2]	R30[1]	R30[0]	R27[1]
22	R31[1]	R31[1]	R31[1]	R31[1]	R31[1]	R31[1]	R31[9]	R31[8]	R31[7]	R31[6]	R31[5]	R31[4]	R31[3]	R31[2]	R31[1]	R31[0]
23	R33[7]	R33[6]	R33[5]	R33[4]	R33[3]	R33[2]	R33[1]	R33[0]	R32[7]	R32[6]	R32[5]	R32[4]	R32[3]	R32[2]	R32[1]	R32[0]
24	R34[7]	R34[6]	R34[5]	R34[4]	R34[3]	R34[2]	R34[1]	R34[0]	R33[1]	R33[1]	R33[1]	R33[1]	R33[1]	R33[1]	R33[9]	R33[8]

Table 7-21. EEPROM Mapping (1) (2) (3) (4) (continued)

	15	14	13	12	11	10	9	8	7	6	5	4	3	2	1	0
25	R43[1 0]	R43[9]	R43[8]	R43[7]	R43[6]	R43[5]	R43[4]	R43[3]	R43[2]	R43[1]	R43[0]	R42[5]	R42[3]	R42[2]	R42[1]	R41[1 5]
26	R51[1 0]	0	0	1	R51[6]	0	0	R47[6]	R47[5]	R47[4]	R47[3]	R43[1 5]	R43[1 4]	R43[1 3]	R43[1 2]	R43[1 1]
27	R56[1 0]	R56[9]	R56[8]	R56[7]	R56[6]	R56[5]	R56[4]	R56[3]	R56[2]	R56[1]	R56[0]	R53[3]	1	0	0	0
28	R57[1 4]	R57[1 2]	R57[9]	R57[8]	R57[7]	R57[6]	R57[5]	R57[4]	R57[3]	R57[1]	R57[0]	R56[1 5]	R56[1 4]	R56[1 3]	R56[1 2]	R56[1 1]
29	R62[6]	R62[5]	R62[4]	R62[3]	R62[2]	R62[1]	R62[0]	R60[1 1]	R60[1 0]	R60[5]	R60[4]	R59[1 5]	R59[1 4]	R59[1 3]	R59[1 2]	R59[1 1]
30	R63[7]	R63[6]	R63[5]	R63[4]	R63[3]	R63[1]	R63[0]	R62[1 5]	R62[1 4]	R62[1 3]	R62[1 2]	R62[1 1]	R62[1 0]	R62[9]	R62[8]	R62[7]
31	R67[6]	R67[5]	R67[4]	R67[3]	R67[2]	R67[1]	R67[0]	R66[5]	R66[4]	R65[1 4]	R65[1 3]	R65[1 1]	R63[1 3]	R63[1 2]	R63[9]	R63[8]
32	R68[7]	R68[6]	R68[5]	R68[4]	R68[3]	R68[1]	R68[0]	R67[1 5]	R67[1 4]	R67[1 3]	R67[1 2]	R67[1 1]	R67[1 0]	R67[9]	R67[8]	R67[7]
33	R72[6]	R72[5]	R72[4]	R72[3]	R72[2]	R72[1]	R72[0]	R71[1 0]	R71[9]	R71[5]	R71[4]	R70[1 1]	R68[1 3]	R68[1 2]	R68[9]	R68[8]
34	R73[7]	R73[6]	R73[5]	R73[4]	R73[3]	R73[1]	R73[0]	R72[1 5]	R72[1 4]	R72[1 3]	R72[1 2]	R72[1 1]	R72[1 0]	R72[9]	R72[8]	R72[7]
35	0	0	0	R77[1]	R77[0]	R76[5]	R76[4]	R75[1 5]	R75[1 4]	R75[1 3]	R75[1 2]	R75[1 1]	R73[1 3]	R73[1 2]	R73[9]	R73[8]
36	0	0	0	0	0	0	0	0	0	R79[9]	R78[1 2]	0	0	0	0	0
37	0	0	0	0	0	0	0	0	0	0	0	0	0	0	0	0
38	0	0	0	0	0	0	0	0	0	0	0	0	0	0	0	0
39	0	0	0	1	0	0	0	0	0	0	0	0	0	0	0	0
40	R1[6]	R1[5]	R1[4]	R1[3]	R1[2]	R1[1]	R1[0]	R0[15]	R0[14]	R0[13]	R0[12]	0	R0[10]	0	R0[8]	R0[0]
41	R2[6]	R2[5]	R2[4]	R2[3]	R2[2]	R2[1]	R2[0]	R1[15]	R1[14]	R1[13]	R1[12]	R1[11]	R1[10]	R1[9]	R1[8]	R1[7]
42	0	R5[3]	R5[2]	R4[7]	R4[6]	R4[5]	R4[4]	R3[4]	R3[3]	R2[13]	R2[12]	R2[11]	R2[10]	R2[9]	R2[8]	R2[7]
43	R24[1 5]	R24[1 2]	R24[1 1]	R24[1 0]	R24[9]	R24[8]	0	0	R24[5]	R24[4]	R24[3]	R24[2]	R24[1]	R24[0]	0	0
44	R27[0]	0	R25[1 4]	R25[1 3]	R25[1 2]	R25[1 1]	R25[1 0]	R25[9]	R25[7]	R25[6]	R25[5]	R25[4]	R25[3]	R25[2]	R25[1]	R25[0]
45	R30[1 4]	R30[1 3]	R30[1 2]	R30[1 1]	R30[1 0]	R30[9]	R30[8]	R30[7]	R30[6]	R30[5]	R30[4]	R30[3]	R30[2]	R30[1]	R30[0]	R27[1]
46	R31[1 5]	R31[1 4]	R31[1 3]	R31[1 2]	R31[1 1]	R31[1 0]	R31[9]	R31[8]	R31[7]	R31[6]	R31[5]	R31[4]	R31[3]	R31[2]	R31[1]	R31[0]
47	R33[7]	R33[6]	R33[5]	R33[4]	R33[3]	R33[2]	R33[1]	R33[0]	R32[7]	R32[6]	R32[5]	R32[4]	R32[3]	R32[2]	R32[1]	R32[0]
48	R34[7]	R34[6]	R34[5]	R34[4]	R34[3]	R34[2]	R34[1]	R34[0]	R33[1 5]	R33[1 4]	R33[1 3]	R33[1 2]	R33[1 1]	R33[1 0]	R33[9]	R33[8]
49	R43[1 0]	R43[9]	R43[8]	R43[7]	R43[6]	R43[5]	R43[4]	R43[3]	R43[2]	R43[1]	R43[0]	R42[5]	R42[3]	R42[2]	R42[1]	R41[1 5]

Table 7-21. EEPROM Mapping (1) (2) (3) (4) (continued)

	15	14	13	12	11	10	9	8	7	6	5	4	3	2	1	0
50	R51[1 0]	0	0	1	R51[6]	0	0	R47[6]	R47[5]	R47[4]	R47[3]	R43[1 5]	R43[1 4]	R43[1 3]	R43[1 2]	R43[1 1]
51	R56[1 0]	R56[9]	R56[8]	R56[7]	R56[6]	R56[5]	R56[4]	R56[3]	R56[2]	R56[1]	R56[0]	R53[3]	1	0	0	0
52	R57[1 4]	R57[1 2]	R57[9]	R57[8]	R57[7]	R57[6]	R57[5]	R57[4]	R57[3]	R57[1]	R57[0]	R56[1 5]	R56[1 4]	R56[1 3]	R56[1 2]	R56[1 1]
53	R62[6]	R62[5]	R62[4]	R62[3]	R62[2]	R62[1]	R62[0]	R60[1 1]	R60[1 0]	R60[5]	R60[4]	R59[1 5]	R59[1 4]	R59[1 3]	R59[1 2]	R59[1 1]
54	R63[7]	R63[6]	R63[5]	R63[4]	R63[3]	R63[1]	R63[0]	R62[1 5]	R62[1 4]	R62[1 3]	R62[1 2]	R62[1 1]	R62[1 0]	R62[9]	R62[8]	R62[7]
55	R67[6]	R67[5]	R67[4]	R67[3]	R67[2]	R67[1]	R67[0]	R66[5]	R66[4]	R65[1 4]	R65[1 3]	R65[1 1]	R63[1 3]	R63[1 2]	R63[9]	R63[8]
56	R68[7]	R68[6]	R68[5]	R68[4]	R68[3]	R68[1]	R68[0]	R67[1 5]	R67[1 4]	R67[1 3]	R67[1 2]	R67[1 1]	R67[1 0]	R67[9]	R67[8]	R67[7]
57	R72[6]	R72[5]	R72[4]	R72[3]	R72[2]	R72[1]	R72[0]	R71[1 0]	R71[9]	R71[5]	R71[4]	R70[1 1]	R68[1 3]	R68[1 2]	R68[9]	R68[8]
58	R73[7]	R73[6]	R73[5]	R73[4]	R73[3]	R73[1]	R73[0]	R72[1 5]	R72[1 4]	R72[1 3]	R72[1 2]	R72[1 1]	R72[1 0]	R72[9]	R72[8]	R72[7]
59	0	0	0	R77[1]	R77[0]	R76[5]	R76[4]	R75[1 5]	R75[1 4]	R75[1 3]	R75[1 2]	R75[1 1]	R73[1 3]	R73[1 2]	R73[9]	R73[8]
60	0	0	0	0	0	0	0	0	0	R79[9]	R78[1 2]	0	0	0	0	0
61	0	0	0	0	0	0	0	0	0	0	0	0	0	0	0	0
62	0	0	0	0	0	0	0	0	0	0	0	0	0	0	0	0
63	SCR C[15]	SCR C[14]	SCR C[13]	SCR C[12]	SCR C[11]	SCR C[10]	SCR C[9]	SCR C[8]	SCR C[7]	SCR C[6]	SCR C[5]	SCR C[4]	SCR C[3]	SCR C[2]	SCR C[1]	SCR C[0]

- (1) Address Locations 0-15: EEPROM Base Page
- (2) Address Locations 16-39: EEPROM Page 0
- (3) Address Locations 40-63: EEPROM Page 1
- (4) Bit locations marked in Red can vary from device to device

8 Application and Implementation

Note

Information in the following applications sections is not part of the TI component specification, and TI does not warrant its accuracy or completeness. TI's customers are responsible for determining suitability of components for their purposes, as well as validating and testing their design implementation to confirm system functionality.

8.1 Application Information

A typical application using the I²C interface and a 25-MHz crystal input is shown in [Figure 8-1](#). The two ends of 25-MHz XTAL are connected to pin 1 and 2. The REFSEL pin is pulled down to select a secondary input. The HW_SW_CTRL can be pulled either low or high if EEPROM is used, or kept floating if EEPROM is unused. 1.8 V, 2.5 V, or 3.3 V can be supplied to the VDD_REF and VDD_VCO pins, as well as VDDO_12 and VDDO_34 pins with filtering. Data and clock lines of I2C must be pulled to VDD_REF using pullup resistors. The PDN can be connected to the MCU if a hardware reset is required, otherwise the PDN can be left floating. The GPIO1 and 4 pins can be connected to the MCU if needed, otherwise these pins can be left floating. Unused outputs can be left floating.

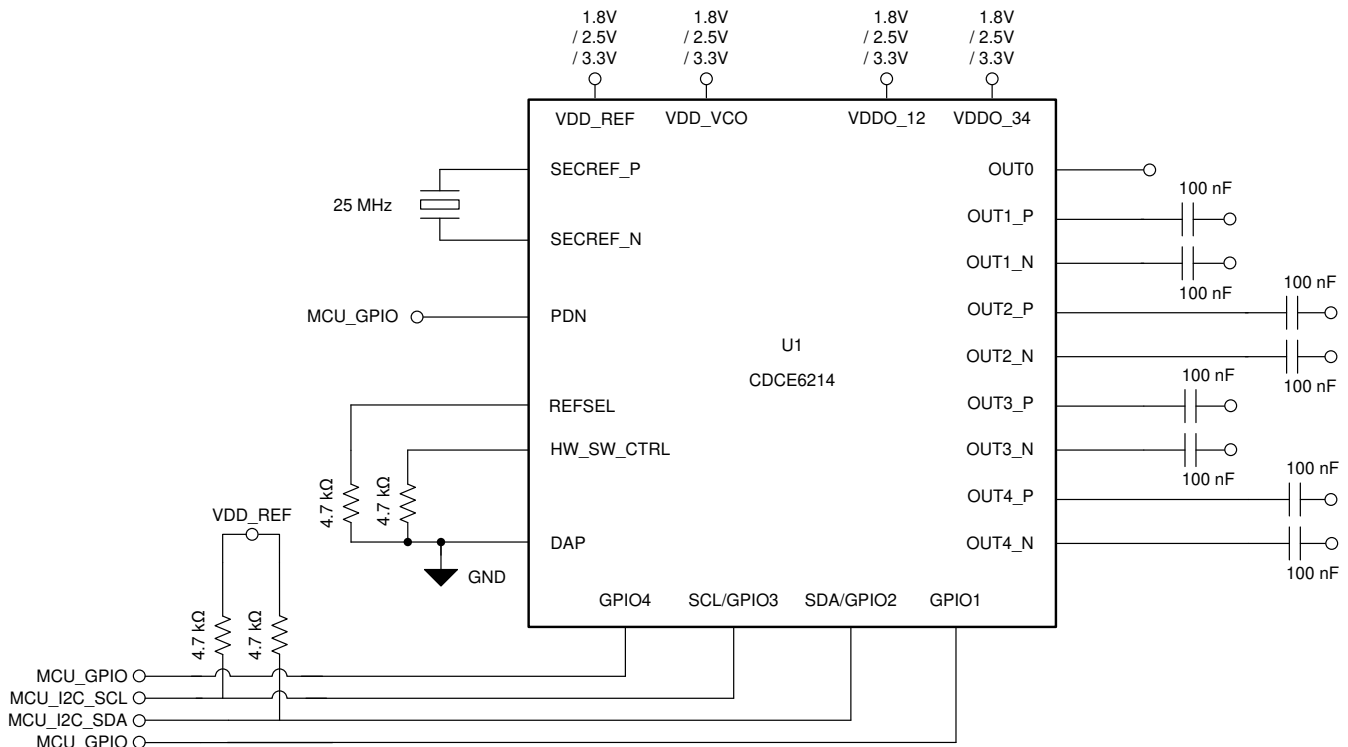

Figure 8-1. Typical Application Schematic With I²C Interface

8.2 Typical Application

Figure 8-2 shows typical block diagram for eAVB system using the CDCE6214.

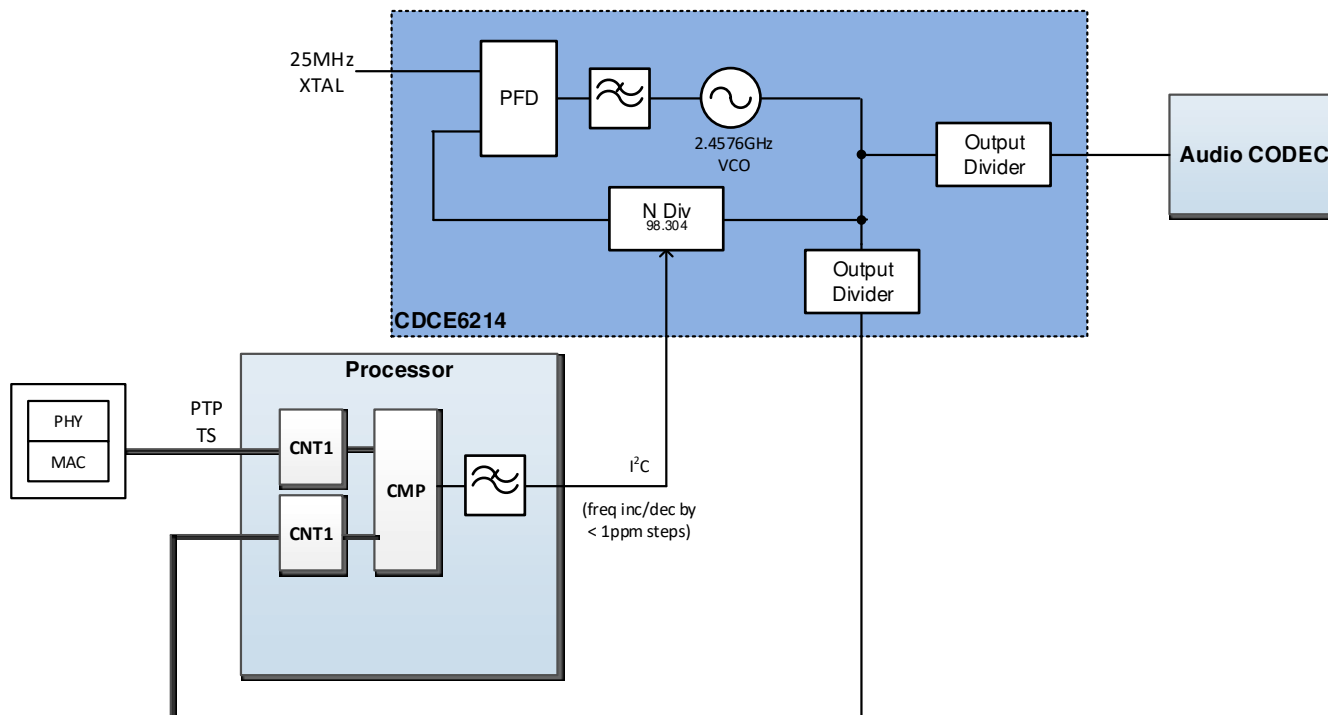

Figure 8-2. eAVB System Block Diagram Using CDCE6214

8.2.1 Design Requirements

For designs with the CDCE6214, the designer must select:

- a primary or secondary input
- an input type
- an input frequency
- a device communication mode (I²C and/or EEPROM)
- the required device operation modes to configure the connections of GPIO pins
- a supply voltage (1.8 V, 2.5 V, or 3.3 V)
- a digital reference (1.8 V, 2.5 V, or 3.3 V)
- an output reference (1.8 V, 2.5 V, or 3.3 V)
- an output format

8.2.2 Detailed Design Procedure

The CDCE6214 is designed for ease-of-use. To power up the device:

1. Either tie the power supply pin (VDD_REF, VDD_VCO, VDDO_12 and VDDO_34) together or independently connect the pins to the 1.8-V, 2.5-V, or 3.3-V power supply.
2. Solder the GND Pin (DAP) to the PCB Plane.
3. Verify that the REFSEL, HW_SW_CTRL, and PDN configuration pins are appropriately connected:
 - a. Internally connect the PDN pin to VDD_REF through a pullup resistor. When floating, the PDN pin automatically releases the device from PDN.
 - b. If the PDN pin is low, the device does not respond to I²C commands.
 - c. REFSEL and HW_SW_CTRL are tri-level pins. If left floating, the device starts in fall-back mode.

The device is factory-configured to provide:

- EEPROM Page 0: 100MHz LP-HCSL on all differential outputs using a 25MHz XTAL when HW_SW_CTRL = L. The 25MHz output on OUT0 is disabled. The device starts up in Pin Mode (no I²C access).
- EEPROM Page 1: 100MHz LVDS on all differential outputs using a 25MHz XTAL and HW_SW_CTRL = H. The 25MHz output on OUT0 is disabled. The device starts up in Serial Interface Mode.
- Fall-Back Mode: 100MHz LP-HCSL on all differential outputs using a 25MHz XTAL, REFSEL = High-Z, and HW_SW_CTRL = High-Z. The 25MHz output on OUT0 is enabled and the PLL is *not* locked. The PLL must be recalibrated to achieve lock. The device starts up in Fall-Back Mode.

Note

When selecting EEPROM Page 0 or 1, REF_SEL *must not* be left floating. REF_SEL must be pulled either High or Low for proper functionality.

8.2.3 Application Curves

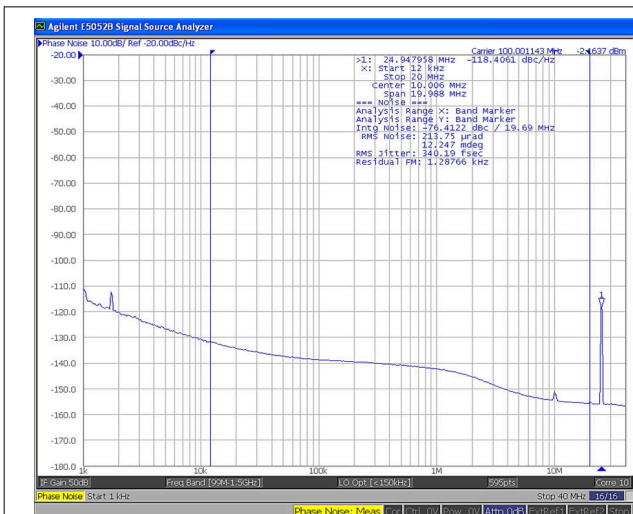

Reference: Crystal Closed-Loop Phase 100-MHz LP-HCSL
Input 25 MHz Noise from 2.4-GHz VCO

Figure 8-3. 100-MHz LP-HCSL Output for PCIe Application

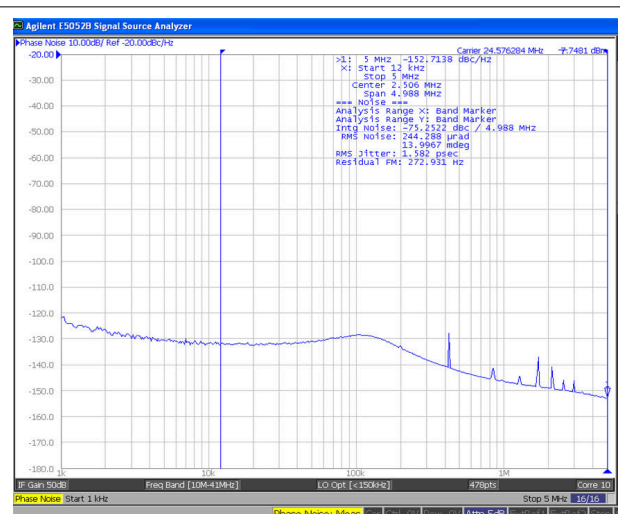

Reference: Crystal Closed-Loop Phase 24.576-MHz
Input 25 MHz Noise from 2.4576-GHz VCO

Figure 8-4. 24.576MHz LVCMOS Output for Audio Clocking

8.3 Power Supply Recommendations

The CDCE6214 provides multiple power supply pins. Each power supply supports 1.8 V, 2.5 V, or 3.3 V. Internal low-dropout regulators (LDO) source the internal blocks and allow each pin to be supplied with an individual supply voltage. The VDD_REF pin supplies the control pins and the serial interface. Therefore, any pullup resistors shall be connected to the same domain as VDD_REF. VDD_VCO powers all PLL blocks, VDDO_12 powers outputs OUT1 and OUT2, and VDDO_34 powers OUT0, OUT3, and OUT4.

VDD_REF and VDDO_34 can be used for level translation operation on OUT0.

8.3.1 Power-Up Sequence

There are no restrictions from the device for applying power to the supply pins. From an application perspective, TI recommends to either apply all the VDDs at the same time or apply the VDDREF first. The digital core is connected to VDDREF and thus the settings of the EEPROM are applied automatically.

8.3.2 Decoupling

TI recommends isolating all power supplies using a ferrite bead and provide decoupling for each of the supplies. TI also recommends optimizing the decoupling for the respective layout, and consider the power supply impedance to optimize for the individual frequency plan.

An example for a decoupling per supply pin: 1x 4.7 μ F, 1x 470 nF, and 1x 100 nF.

8.4 Layout

8.4.1 Layout Guidelines

For this example, follow these guidelines:

- Isolate inputs and outputs using a GND shield. [Figure 8-5](#) routes all inputs and outputs as differential pairs.
- Isolate outputs to adjacent outputs when generating multiple frequencies.
- Isolate the crystal area, connect the GND pads of the crystal package and flood the adjacent area. [Figure 8-6](#) shows a foot print which supports multiple crystal sizes.
- Try to avoid impedance jumps in the fan-in and fan-out areas when possible.
- Use five VIAs to connect the thermal pad to a solid GND plane. Full-through VIAs are preferred.
- Place decoupling capacitors with small capacitance values very close to the supply pins. Try to place the capacitors very close on the same layer or directly on the backside layer. Larger values can be placed more far away. [Figure 8-6](#) shows three decoupling capacitors close to the device. Ferrite beads are recommended to isolate the different frequency domains and the VDD_VCO domain.
- Preferably use multiple VIAs to connect wide supply traces to the respective power planes.

8.4.2 Layout Examples

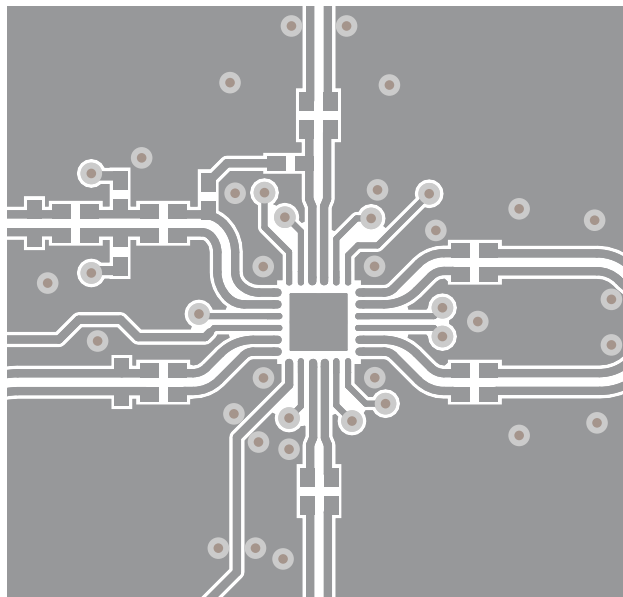

Figure 8-5. Layout Example, Top Layer

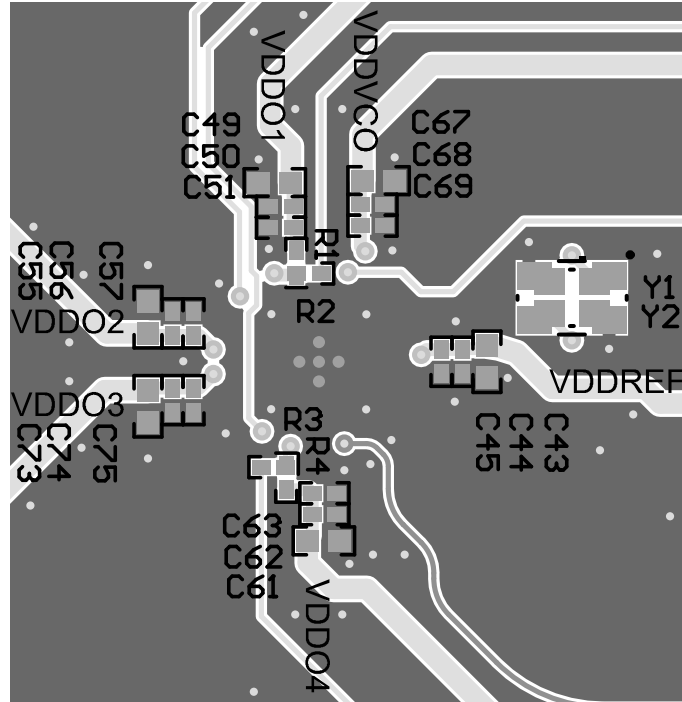

Figure 8-6. Layout Example, Bottom Layer

9 Device and Documentation Support

9.1 Device Support

9.1.1 Development Support

Contact your TI representative for more information.

9.1.2 Device Nomenclature

CDCE6214 – 62 = clock generator 1 = 1x PLL 4 = 4x outputs

9.2 Documentation Support

9.2.1 Related Documentation

For documentation related to the evaluation module, see also:

- Texas Instruments, [CDCE6214-Q1 EVM User's Guide](#).

For documentation related to the register map, see also:

- Texas Instruments, [CDCE6214-Q1 Register Map User's Guide](#).

9.3 Receiving Notification of Documentation Updates

To receive notification of documentation updates, navigate to the device product folder on [ti.com](#). Click on *Notifications* to register and receive a weekly digest of any product information that has changed. For change details, review the revision history included in any revised document.

9.4 Support Resources

[TI E2E™ support forums](#) are an engineer's go-to source for fast, verified answers and design help — straight from the experts. Search existing answers or ask your own question to get the quick design help you need.

Linked content is provided "AS IS" by the respective contributors. They do not constitute TI specifications and do not necessarily reflect TI's views; see TI's [Terms of Use](#).

9.5 Trademarks

TI E2E™ is a trademark of Texas Instruments.

All trademarks are the property of their respective owners.

9.6 Electrostatic Discharge Caution



This integrated circuit can be damaged by ESD. Texas Instruments recommends that all integrated circuits be handled with appropriate precautions. Failure to observe proper handling and installation procedures can cause damage.

ESD damage can range from subtle performance degradation to complete device failure. Precision integrated circuits may be more susceptible to damage because very small parametric changes could cause the device not to meet its published specifications.

9.7 Glossary

[TI Glossary](#) This glossary lists and explains terms, acronyms, and definitions.

10 Revision History

NOTE: Page numbers for previous revisions may differ from page numbers in the current version.

Changes from Revision * (July 2020) to Revision A (July 2025)	Page
• Updated the numbering format for tables, figures, and cross-references throughout the document.....	1
• Updated PCIe Generation compliance in the <i>Features</i> section.....	1
• Updated PCIe Generation compliance in the Applications section.....	1
• Deleted <i>Description (cont.)</i> section.....	1
• Updated Package Information table.....	1
• Updated the "Type" footnote for the <i>Pin Functions</i> table to consolidate information.....	4

• Updated capitalizations of letters throughout the Specifications section.....	7
• Updated to clarify footnote ⁽³⁾ of Timing Requirements, I²C-Compatible Serial Interface	13
• Updated SSC_EN capabilities in the <i>Control Pins</i> section.....	32
• Updated factory configurations in the <i>Detailed Design Procedure</i> section.....	42
• Updated <i>Layout Guidelines</i> to correct link to Figure 8-5	44
• Added references to EVM User's Guide and Register Map User Guide.....	46

11 Mechanical, Packaging, and Orderable Information

The following pages include mechanical, packaging, and orderable information. This information is the most current data available for the designated devices. This data is subject to change without notice and revision of this document. For browser-based versions of this data sheet, refer to the left-hand navigation.

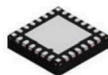

RGE0024P

PACKAGE OUTLINE

VQFN - 0.9 mm max height

PLASTIC QUAD FLATPACK - NO LEAD

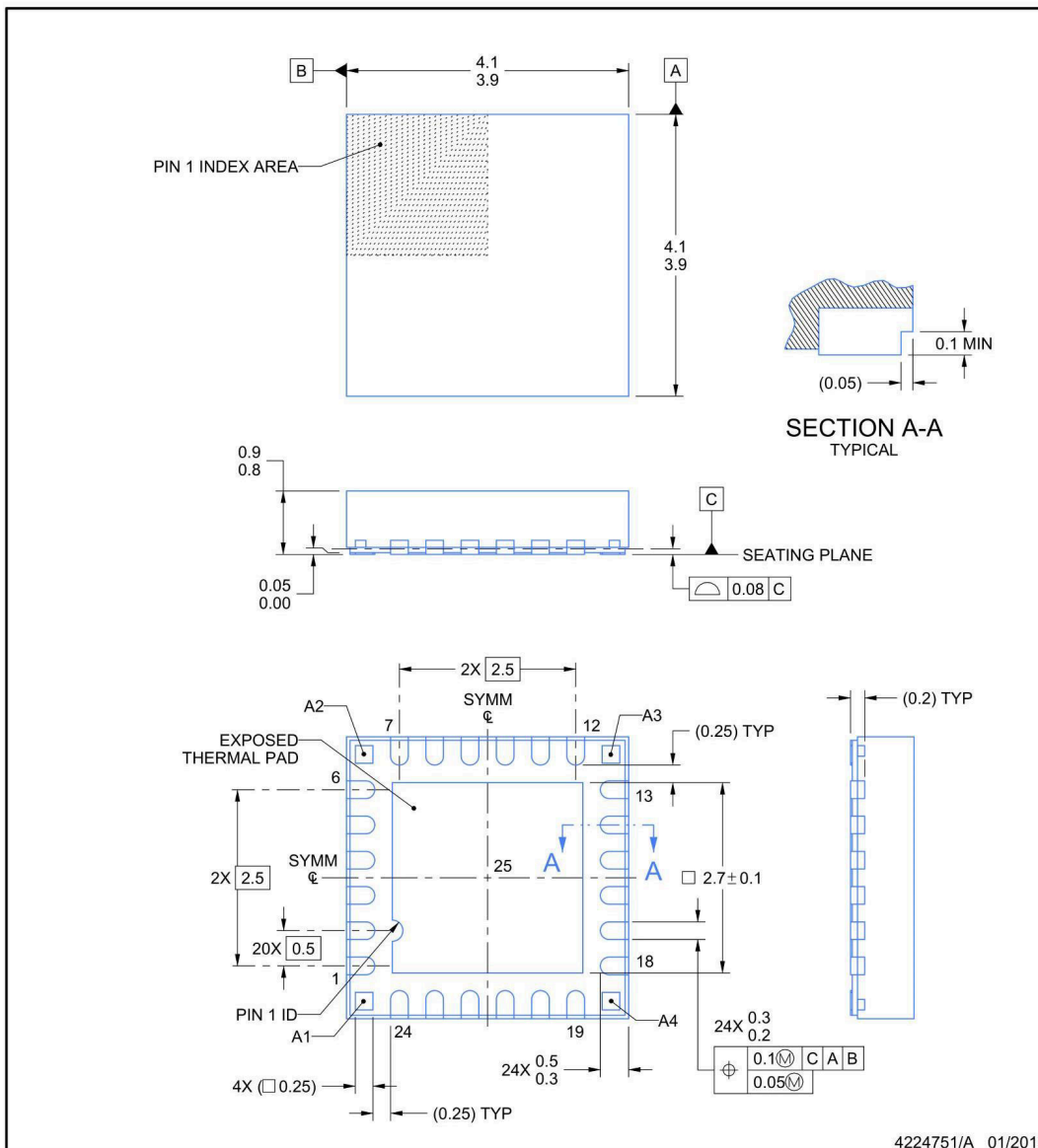

NOTES:

1. All linear dimensions are in millimeters. Any dimensions in parenthesis are for reference only. Dimensioning and tolerancing per ASME Y14.5M.
2. This drawing is subject to change without notice.
3. The package thermal pad must be soldered to the printed circuit board for thermal and mechanical performance.

EXAMPLE BOARD LAYOUT

RGE0024P

VQFN - 0.9 mm max height

PLASTIC QUAD FLATPACK - NO LEAD

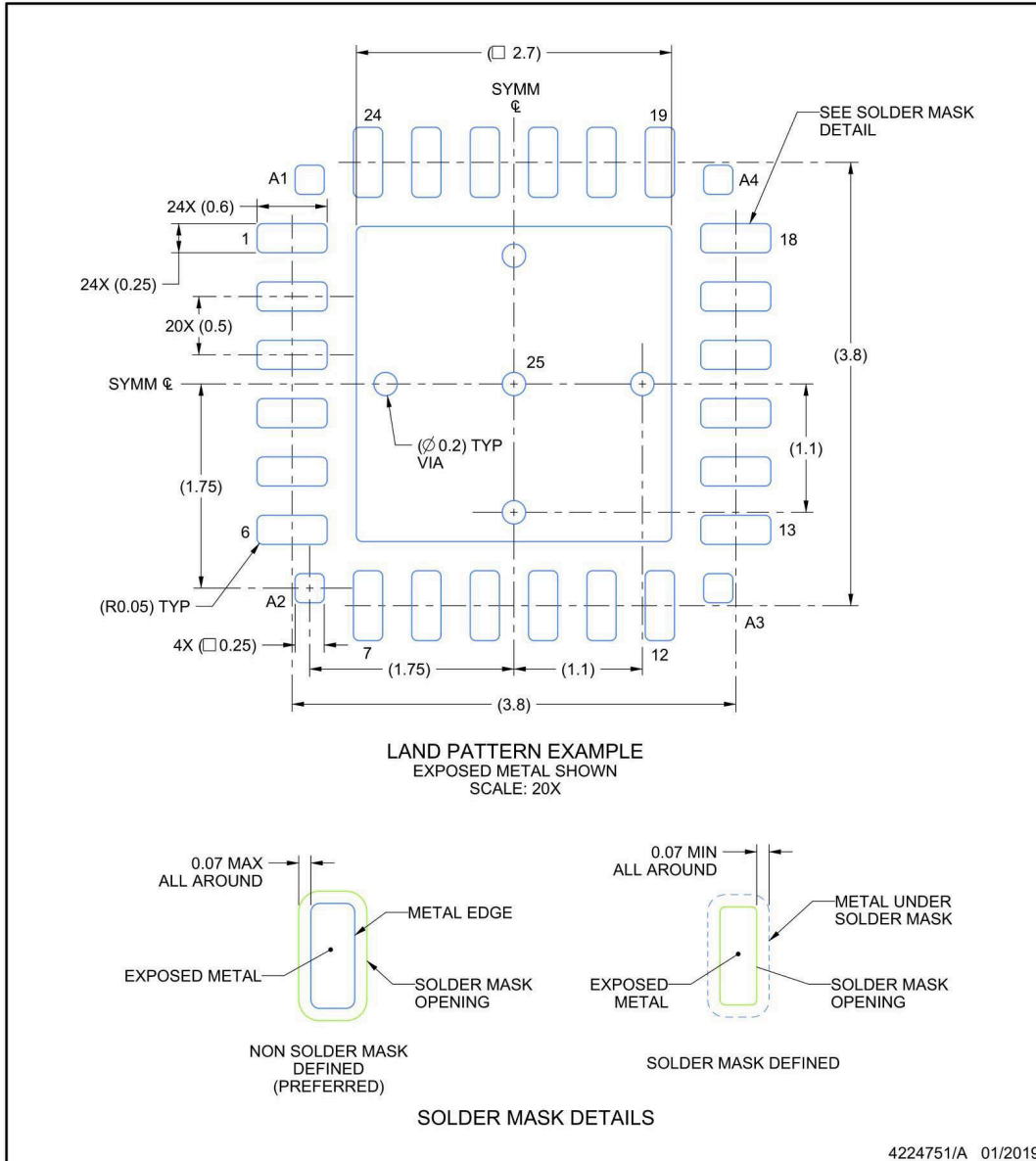

NOTES: (continued)

4. This package is designed to be soldered to a thermal pad on the board. For more information, see Texas Instruments literature number SLUA271 (www.ti.com/lit/slua271).
5. Vias are optional depending on application, refer to device data sheet. If any vias are implemented, refer to their locations shown on this view. It is recommended that vias under paste be filled, plugged or tented.

EXAMPLE STENCIL DESIGN

RGE0024P

VQFN - 0.9 mm max height

PLASTIC QUAD FLATPACK - NO LEAD

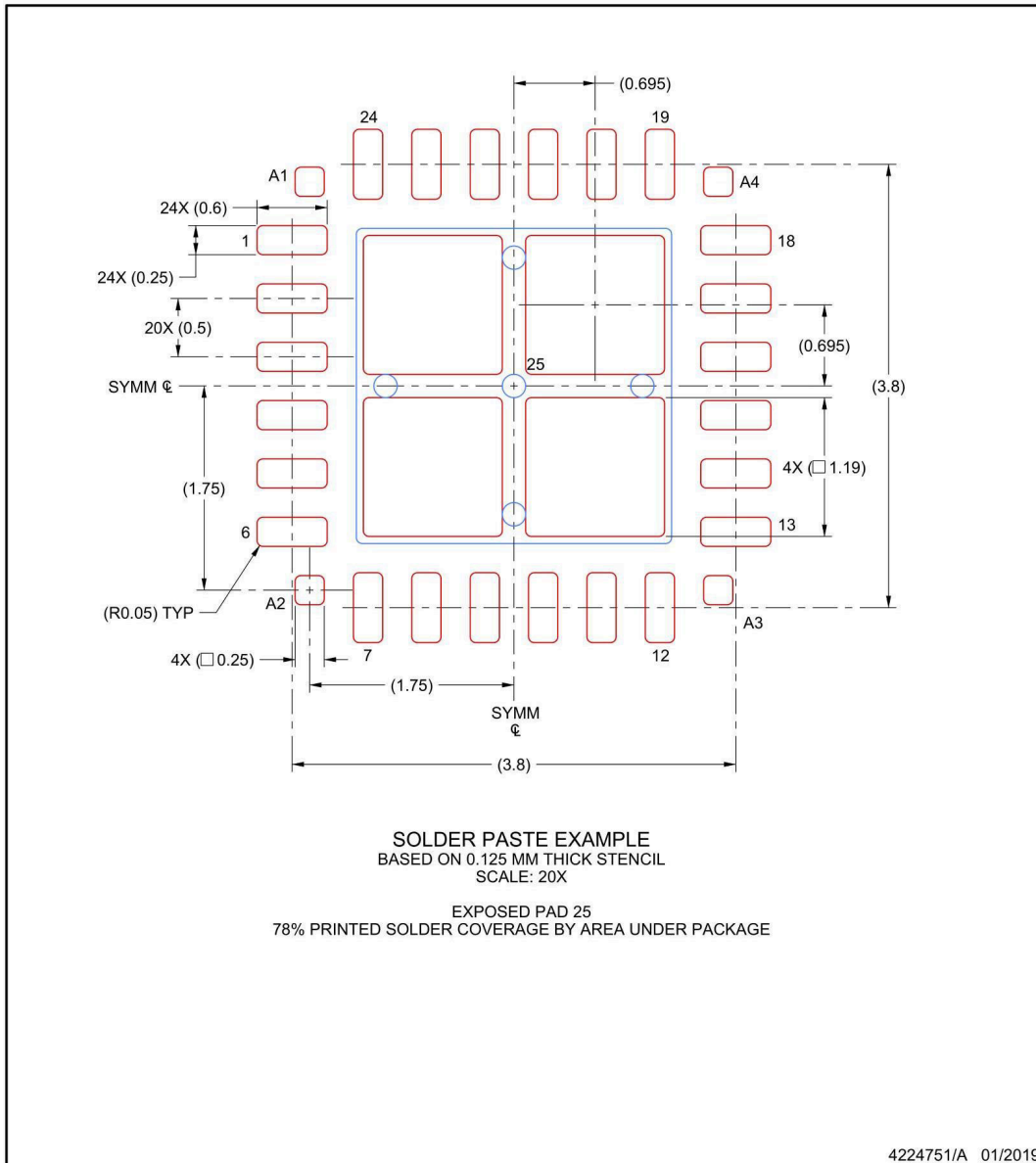

NOTES: (continued)

6. Laser cutting apertures with trapezoidal walls and rounded corners may offer better paste release. IPC-7525 may have alternate design recommendations.

PACKAGING INFORMATION

Orderable part number	Status (1)	Material type (2)	Package Pins	Package qty Carrier	RoHS (3)	Lead finish/ Ball material (4)	MSL rating/ Peak reflow (5)	Op temp (°C)	Part marking (6)
CDCE6214RGER	Active	Production	VQFN (RGE) 24	3000 LARGE T&R	Yes	Call TI Sn	Level-2-260C-1 YEAR	-40 to 105	6214A2
CDCE6214RGER.A	Active	Production	VQFN (RGE) 24	3000 LARGE T&R	Yes	Call TI	Level-2-260C-1 YEAR	-40 to 105	6214A2
CDCE6214RGET	Active	Production	VQFN (RGE) 24	250 SMALL T&R	Yes	SN	Level-2-260C-1 YEAR	-40 to 105	6214A2
CDCE6214RGET.A	Active	Production	VQFN (RGE) 24	250 SMALL T&R	Yes	SN	Level-2-260C-1 YEAR	-40 to 105	6214A2

(1) **Status:** For more details on status, see our [product life cycle](#).

(2) **Material type:** When designated, preproduction parts are prototypes/experimental devices, and are not yet approved or released for full production. Testing and final process, including without limitation quality assurance, reliability performance testing, and/or process qualification, may not yet be complete, and this item is subject to further changes or possible discontinuation. If available for ordering, purchases will be subject to an additional waiver at checkout, and are intended for early internal evaluation purposes only. These items are sold without warranties of any kind.

(3) **RoHS values:** Yes, No, RoHS Exempt. See the [TI RoHS Statement](#) for additional information and value definition.

(4) **Lead finish/Ball material:** Parts may have multiple material finish options. Finish options are separated by a vertical ruled line. Lead finish/Ball material values may wrap to two lines if the finish value exceeds the maximum column width.

(5) **MSL rating/Peak reflow:** The moisture sensitivity level ratings and peak solder (reflow) temperatures. In the event that a part has multiple moisture sensitivity ratings, only the lowest level per JEDEC standards is shown. Refer to the shipping label for the actual reflow temperature that will be used to mount the part to the printed circuit board.

(6) **Part marking:** There may be an additional marking, which relates to the logo, the lot trace code information, or the environmental category of the part.

Multiple part markings will be inside parentheses. Only one part marking contained in parentheses and separated by a "~" will appear on a part. If a line is indented then it is a continuation of the previous line and the two combined represent the entire part marking for that device.

Important Information and Disclaimer: The information provided on this page represents TI's knowledge and belief as of the date that it is provided. TI bases its knowledge and belief on information provided by third parties, and makes no representation or warranty as to the accuracy of such information. Efforts are underway to better integrate information from third parties. TI has taken and continues to take reasonable steps to provide representative and accurate information but may not have conducted destructive testing or chemical analysis on incoming materials and chemicals. TI and TI suppliers consider certain information to be proprietary, and thus CAS numbers and other limited information may not be available for release.

In no event shall TI's liability arising out of such information exceed the total purchase price of the TI part(s) at issue in this document sold by TI to Customer on an annual basis.

OTHER QUALIFIED VERSIONS OF CDCE6214 :

- Automotive : [CDCE6214-Q1](#)

NOTE: Qualified Version Definitions:

- Automotive - Q100 devices qualified for high-reliability automotive applications targeting zero defects

TAPE AND REEL INFORMATION

QUADRANT ASSIGNMENTS FOR PIN 1 ORIENTATION IN TAPE

*All dimensions are nominal

Device	Package Type	Package Drawing	Pins	SPQ	Reel Diameter (mm)	Reel Width W1 (mm)	A0 (mm)	B0 (mm)	K0 (mm)	P1 (mm)	W (mm)	Pin1 Quadrant
CDCE6214RGER	VQFN	RGE	24	3000	330.0	12.4	4.25	4.25	1.15	8.0	12.0	Q2
CDCE6214RGET	VQFN	RGE	24	250	180.0	12.4	4.25	4.25	1.15	8.0	12.0	Q2

TAPE AND REEL BOX DIMENSIONS



*All dimensions are nominal

Device	Package Type	Package Drawing	Pins	SPQ	Length (mm)	Width (mm)	Height (mm)
CDCE6214RGER	VQFN	RGE	24	3000	346.0	346.0	33.0
CDCE6214RGET	VQFN	RGE	24	250	210.0	185.0	35.0

GENERIC PACKAGE VIEW

RGE 24

VQFN - 1 mm max height

PLASTIC QUAD FLATPACK - NO LEAD



Images above are just a representation of the package family, actual package may vary.
Refer to the product data sheet for package details.

4204104/H

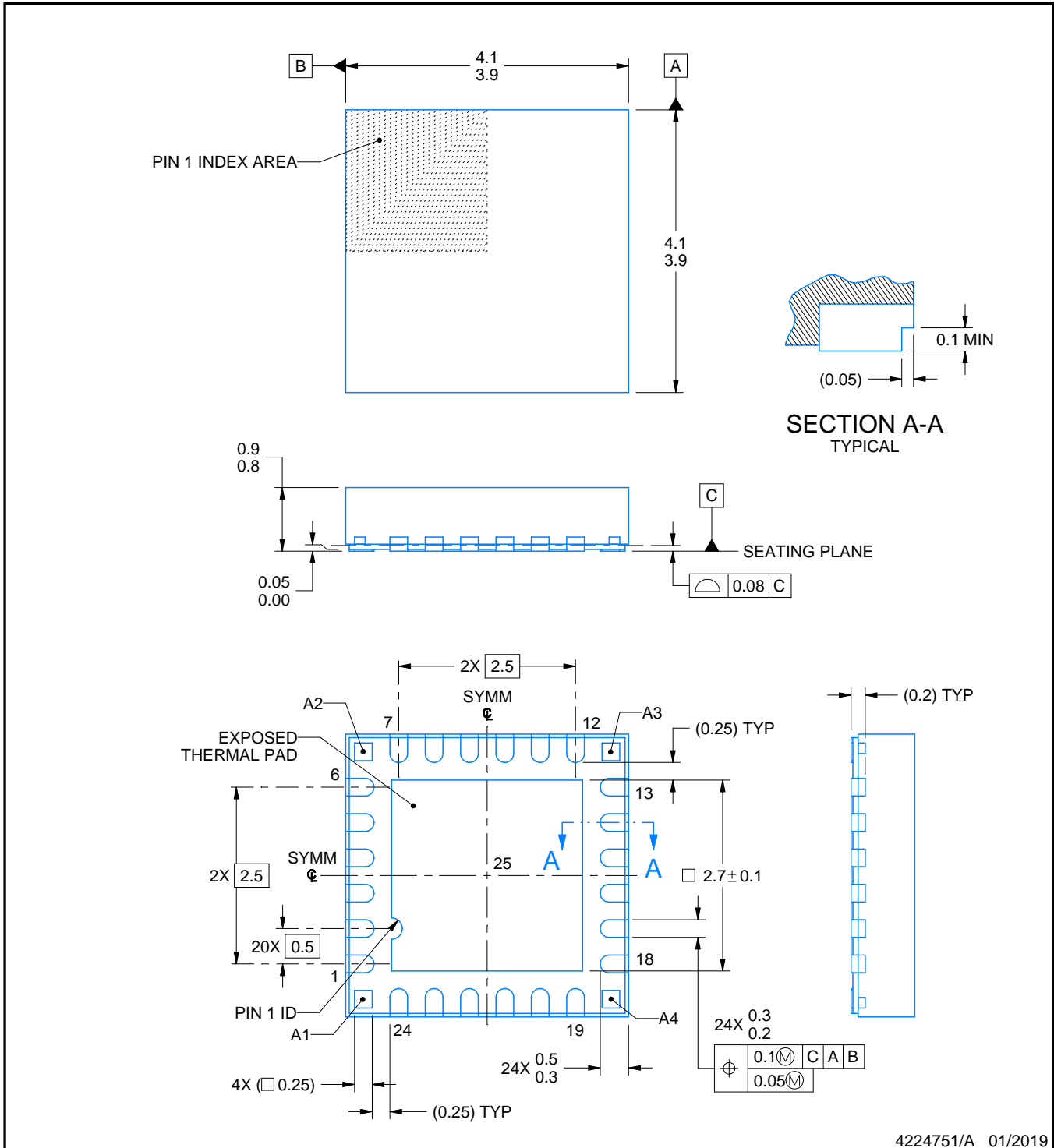
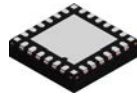

4224751/A 01/2019

NOTES:

1. All linear dimensions are in millimeters. Any dimensions in parenthesis are for reference only. Dimensioning and tolerancing per ASME Y14.5M.
2. This drawing is subject to change without notice.
3. The package thermal pad must be soldered to the printed circuit board for thermal and mechanical performance.

EXAMPLE BOARD LAYOUT

RGE0024P

VQFN - 0.9 mm max height

PLASTIC QUAD FLATPACK - NO LEAD

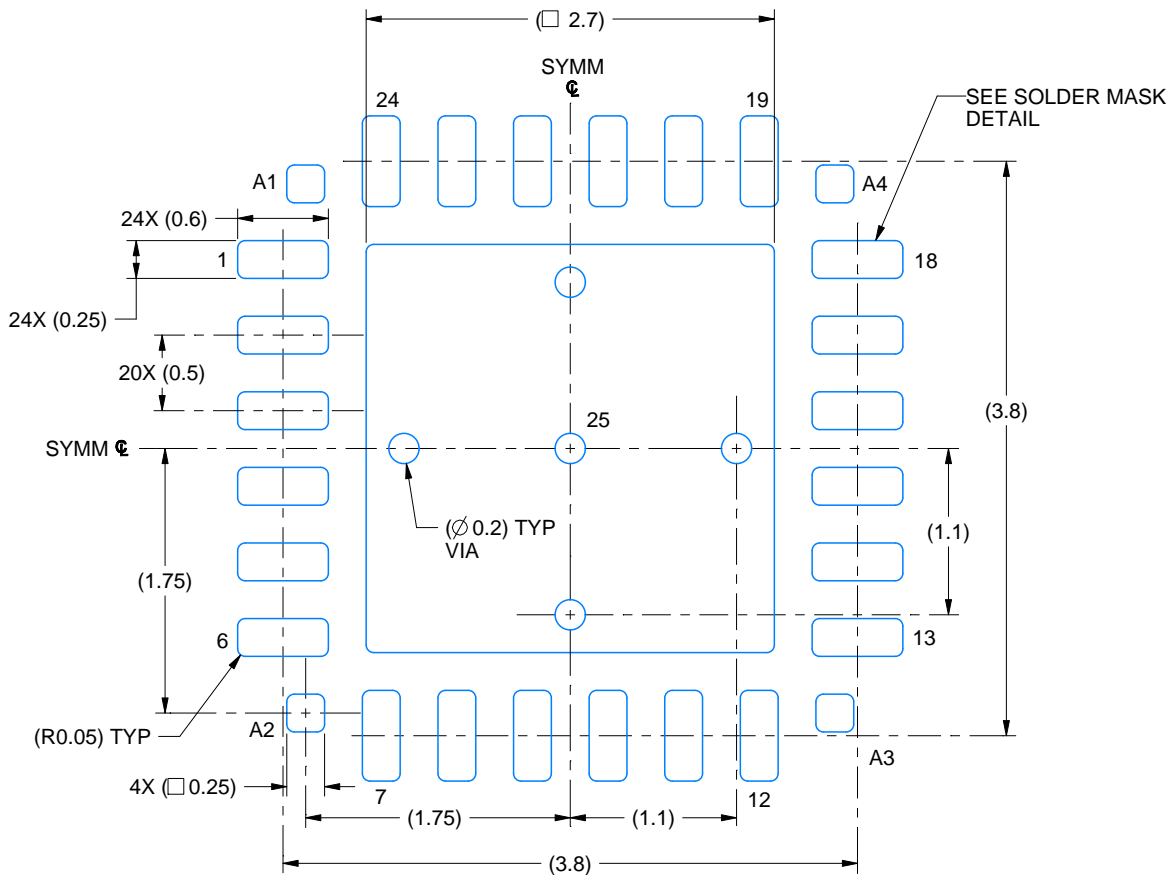

LAND PATTERN EXAMPLE
EXPOSED METAL SHOWN
SCALE: 20X

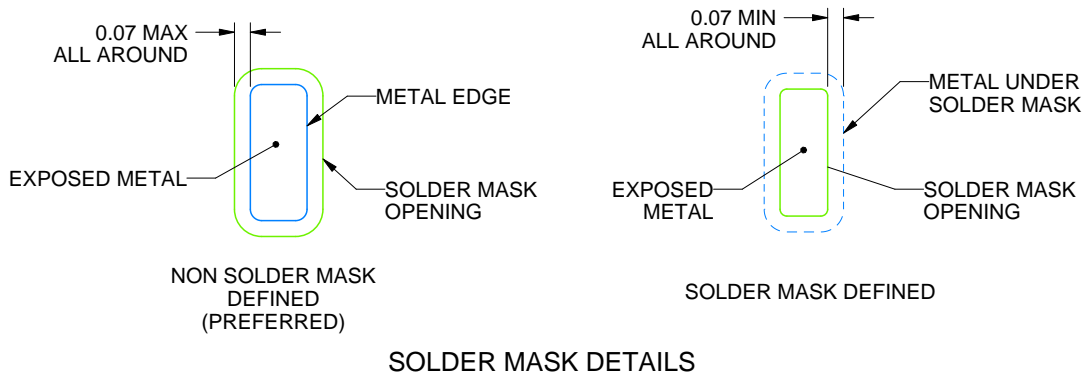

4224751/A 01/2019

NOTES: (continued)

- This package is designed to be soldered to a thermal pad on the board. For more information, see Texas Instruments literature number SLUA271 (www.ti.com/lit/slua271).
- Vias are optional depending on application, refer to device data sheet. If any vias are implemented, refer to their locations shown on this view. It is recommended that vias under paste be filled, plugged or tented.

IMPORTANT NOTICE AND DISCLAIMER

TI PROVIDES TECHNICAL AND RELIABILITY DATA (INCLUDING DATASHEETS), DESIGN RESOURCES (INCLUDING REFERENCE DESIGNS), APPLICATION OR OTHER DESIGN ADVICE, WEB TOOLS, SAFETY INFORMATION, AND OTHER RESOURCES "AS IS" AND WITH ALL FAULTS, AND DISCLAIMS ALL WARRANTIES, EXPRESS AND IMPLIED, INCLUDING WITHOUT LIMITATION ANY IMPLIED WARRANTIES OF MERCHANTABILITY, FITNESS FOR A PARTICULAR PURPOSE OR NON-INFRINGEMENT OF THIRD PARTY INTELLECTUAL PROPERTY RIGHTS.

These resources are intended for skilled developers designing with TI products. You are solely responsible for (1) selecting the appropriate TI products for your application, (2) designing, validating and testing your application, and (3) ensuring your application meets applicable standards, and any other safety, security, regulatory or other requirements.

These resources are subject to change without notice. TI grants you permission to use these resources only for development of an application that uses the TI products described in the resource. Other reproduction and display of these resources is prohibited. No license is granted to any other TI intellectual property right or to any third party intellectual property right. TI disclaims responsibility for, and you fully indemnify TI and its representatives against any claims, damages, costs, losses, and liabilities arising out of your use of these resources.

TI's products are provided subject to [TI's Terms of Sale](#), [TI's General Quality Guidelines](#), or other applicable terms available either on [ti.com](#) or provided in conjunction with such TI products. TI's provision of these resources does not expand or otherwise alter TI's applicable warranties or warranty disclaimers for TI products. Unless TI explicitly designates a product as custom or customer-specified, TI products are standard, catalog, general purpose devices.

TI objects to and rejects any additional or different terms you may propose.

Copyright © 2025, Texas Instruments Incorporated

Last updated 10/2025