



High Common-Mode Voltage Difference Amplifier

FEATURES

- **Common-Mode Voltage Range:** ± 275 V
- **Minimum CMRR:** 90 dB from -40°C to $+125^{\circ}\text{C}$
- **DC Specifications:**
 - **Maximum Offset Voltage:** 1100 μV
 - **Maximum Offset Voltage Drift:** 15 $\mu\text{V}/^{\circ}\text{C}$
 - **Maximum Gain Error:** 0.02%
 - **Maximum Gain Error Drift:** 10 ppm/ $^{\circ}\text{C}$
 - **Maximum Gain Nonlinearity:** 0.001% FSR
- **AC Performance:**
 - **Bandwidth:** 500 kHz
 - **Typical Slew Rate:** 5 V/ μs
- **Wide Supply Range:** ± 2.0 V to ± 18 V
 - **Maximum Quiescent Current:** 900 μA
 - **Output Swing on ± 15 -V Supplies:** ± 13.5 V
- **Input Protection:**
 - **Common-Mode:** ± 500 V
 - **Differential:** ± 500 V

APPLICATIONS

- High-Voltage Current Sensing
- Battery Cell Voltage Monitoring
- Power-Supply Current Monitoring
- Motor Controls
- Replacement for Isolation Circuits

DESCRIPTION

The INA149 is a precision unity-gain difference amplifier with a very high input common-mode voltage range. It is a single, monolithic device that consists of a precision op amp and an integrated thin-film resistor network. The INA149 can accurately measure small differential voltages in the presence of common-mode signals up to ± 275 V. The INA149 inputs are protected from momentary common-mode or differential overloads of up to 500 V.

In many applications, where galvanic isolation is not required, the INA149 can replace isolation amplifiers. This ability can eliminate costly isolated input side power supplies and the associated ripple, noise, and quiescent current. The excellent 0.0005% nonlinearity and 500-kHz bandwidth of the INA149 are superior to those of conventional isolation amplifiers.

The INA149 is pin-compatible with the [INA117](#) and [INA148](#) type high common-mode voltage amplifiers and offers improved performance over both devices. The INA149 is available in the SOIC-8 package with operation specified over the extended industrial temperature range of -40°C to $+125^{\circ}\text{C}$.

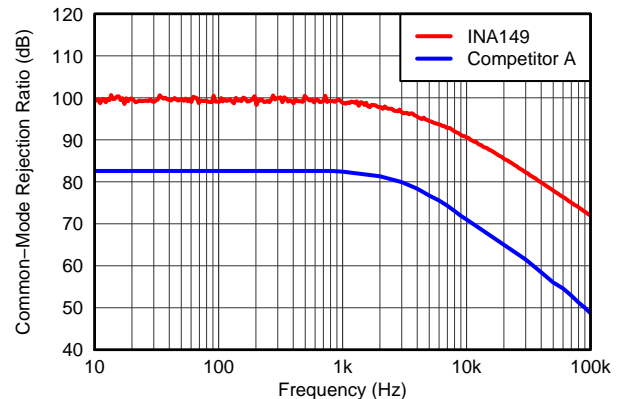

Please be aware that an important notice concerning availability, standard warranty, and use in critical applications of Texas Instruments semiconductor products and disclaimers thereto appears at the end of this data sheet.

All trademarks are the property of their respective owners.



This integrated circuit can be damaged by ESD. Texas Instruments recommends that all integrated circuits be handled with appropriate precautions. Failure to observe proper handling and installation procedures can cause damage.

ESD damage can range from subtle performance degradation to complete device failure. Precision integrated circuits may be more susceptible to damage because very small parametric changes could cause the device not to meet its published specifications.

PACKAGE/ORDERING INFORMATION⁽¹⁾

PRODUCT	PACKAGE-LEAD	PACKAGE DESIGNATOR	PACKAGE MARKING
INA149	SOIC-8	D	INA149A

- (1) For the most current package and ordering information, see the Package Option Addendum at the end of this document, or visit the device product folder at www.ti.com.

ABSOLUTE MAXIMUM RATINGS⁽¹⁾

Over operating free-air temperature range, unless otherwise noted.

		INA149	UNIT
Supply voltage	(V+) – (V–)	40	V
Input voltage range	Continuous	300	V
Common-mode and differential, 10 s		500	V
Maximum Voltage on REF _A and REF _B		(V–) – 0.3 to (V+) + 0.3	V
Input current on any input pin ⁽²⁾		10	mA
Output short-circuit current duration		Indefinite	
Operating temperature range		–55 to +150	°C
Storage temperature range		–65 to +150	°C
Junction temperature		+150	°C
ESD rating	Human body model (HBM)	1500	V
	Charged device model (CDM)	1000	V
	Machine model (MM)	100	V

- (1) Stresses above these ratings may cause permanent damage. Exposure to absolute maximum conditions for extended periods may degrade device reliability. These are stress ratings only, and functional operation of the device at these or any other conditions beyond those specified is not implied.
- (2) REF_A and REF_B are diode clamped to the power-supply rails. Signals applied to these pins that can swing more than 0.3 V beyond the supply rails should be limited to 10 mA or less.

ELECTRICAL CHARACTERISTICS: $V_+ = +15\text{ V}$ and $V_- = -15\text{ V}$

 At $T_A = +25^\circ\text{C}$, $R_L = 2\text{ k}\Omega$ connected to ground, and $V_{CM} = \text{REF}_A = \text{REF}_B = \text{GND}$, unless otherwise noted.

PARAMETER	TEST CONDITIONS	INA149			UNIT
		MIN	TYP	MAX	
GAIN					
Initial	$V_{OUT} = \pm 10.0\text{ V}$		1		V/V
Gain error	$V_{OUT} = \pm 10.0\text{ V}$		± 0.005	± 0.02	%FSR
Gain	vs temperature, $T_A = -40^\circ\text{C}$ to $+125^\circ\text{C}$		± 1.5	± 10	ppm/ $^\circ\text{C}$
Nonlinearity			± 0.0005	± 0.001	%FSR
OFFSET VOLTAGE					
Initial offset			350	1100	μV
	vs temperature, $T_A = -40^\circ\text{C}$ to $+125^\circ\text{C}$		3	15	$\mu\text{V}/^\circ\text{C}$
	vs supply (PSRR), $V_S = \pm 2\text{ V}$ to $\pm 18\text{ V}$	90	120		dB
INPUT					
Impedance	Differential		800		k Ω
	Common-mode		200		k Ω
Voltage range	Differential	-13.5		13.5	V
	Common-mode	-275		275	V
Common-mode rejection (CMRR)	At dc, $V_{CM} = \pm 275\text{ V}$	90	100		dB
	vs temperature, $T_A = -40^\circ\text{C}$ to $+125^\circ\text{C}$, at dc	90			dB
	At ac, 500 Hz, $V_{CM} = 500\text{ V}_{PP}$	90			dB
	At ac, 1 kHz, $V_{CM} = 500\text{ V}_{PP}$		90		dB
OUTPUT					
Voltage range		-13.5		13.5	V
Short-circuit current			± 25		mA
Capacitive load drive	No sustained oscillations		10		nF
OUTPUT NOISE VOLTAGE					
0.01 Hz to 10 Hz			20		μV_{PP}
10 kHz			550		$\text{nV}/\sqrt{\text{Hz}}$
DYNAMIC RESPONSE					
Small-signal bandwidth			500		kHz
Slew rate	$V_{OUT} = \pm 10\text{-V}$ step	1.7	5		V/ μs
Full-power bandwidth	$V_{OUT} = 20\text{ V}_{PP}$		32		kHz
Settling time	0.01%, $V_{OUT} = 10\text{-V}$ step		7		μs
POWER SUPPLY					
Voltage range		± 2		± 18	V
Quiescent current	$V_S = \pm 18\text{ V}$, $V_{OUT} = 0\text{ V}$		810	900	μA
	vs temperature, $T_A = -40^\circ\text{C}$ to $+125^\circ\text{C}$			1.1	mA
TEMPERATURE RANGE					
Specified		-40		+125	$^\circ\text{C}$
Operating		-55		+150	$^\circ\text{C}$
Storage		-65		+150	$^\circ\text{C}$

ELECTRICAL CHARACTERISTICS: $V_+ = 5\text{ V}$ and $V_- = 0\text{ V}$

At $T_A = +25^\circ\text{C}$, $R_L = 2\text{ k}\Omega$ connected to 2.5 V , and $V_{CM} = \text{REF}_A = \text{REF}_B = 2.5\text{ V}$, unless otherwise noted.

PARAMETER	TEST CONDITIONS	INA149			UNIT
		MIN	TYP	MAX	
GAIN					
Initial	$V_{OUT} = 1.5\text{ V to }3.5\text{ V}$		1		V/V
Gain error	$V_{OUT} = 1.5\text{ V to }3.5\text{ V}$		± 0.005		%FSR
Gain	vs temperature, $T_A = -40^\circ\text{C to }+125^\circ\text{C}$		± 1.5		ppm/ $^\circ\text{C}$
Nonlinearity			± 0.0005		%FSR
OFFSET VOLTAGE					
Initial offset			350		μV
	vs temperature, $T_A = -40^\circ\text{C to }+125^\circ\text{C}$		3		$\mu\text{V}/^\circ\text{C}$
	vs supply (PSRR), $V_S = 4\text{ V to }5\text{ V}$		120		dB
INPUT					
Impedance	Differential		800		k Ω
	Common-mode		200		k Ω
Voltage range	Differential	1.5		3.5	V
	Common-mode	-20		25	V
Common-mode rejection	At dc, $V_{CM} = -20\text{ V to }25\text{ V}$		100		dB
	vs temperature, $T_A = -40^\circ\text{C to }+125^\circ\text{C}$, at dc		100		dB
	At ac, 500 Hz, $V_{CM} = 49\text{ V}_{PP}$		100		dB
	At ac, 1 kHz, $V_{CM} = 49\text{ V}_{PP}$		90		dB
OUTPUT					
Voltage range		1.5		3.5	V
Short-circuit current			± 15		mA
Capacitive load drive	No sustained oscillations		10		nF
OUTPUT NOISE VOLTAGE					
0.01 Hz to 10 Hz			20		μV_{PP}
10 kHz			550		$\text{nV}/\sqrt{\text{Hz}}$
DYNAMIC RESPONSE					
Small-signal bandwidth			500		kHz
Slew rate	$V_{OUT} = 2\text{ V}_{PP}$ step		5		V/ μs
Full-power bandwidth	$V_{OUT} = 2\text{ V}_{PP}$		32		kHz
Settling time	0.01%, $V_{OUT} = 2\text{ V}_{PP}$ step		7		μs
POWER SUPPLY					
Voltage range			5		V
Quiescent current	$V_S = 5\text{ V}$		810		μA
	vs temperature, $T_A = -40^\circ\text{C to }+125^\circ\text{C}$		1		mA

THERMAL INFORMATION

THERMAL METRIC ⁽¹⁾		INA149	UNITS
		D (SOIC)	
		8 PINS	
θ_{JA}	Junction-to-ambient thermal resistance	110	°C/W
θ_{JCTop}	Junction-to-case (top) thermal resistance	57	
θ_{JB}	Junction-to-board thermal resistance	54	
ψ_{JT}	Junction-to-top characterization parameter	11	
ψ_{JB}	Junction-to-board characterization parameter	53	
θ_{JCbott}	Junction-to-case (bottom) thermal resistance	N/A	

(1) For more information about traditional and new thermal metrics, see the *IC Package Thermal Metrics* application report, [SPRA953](#).

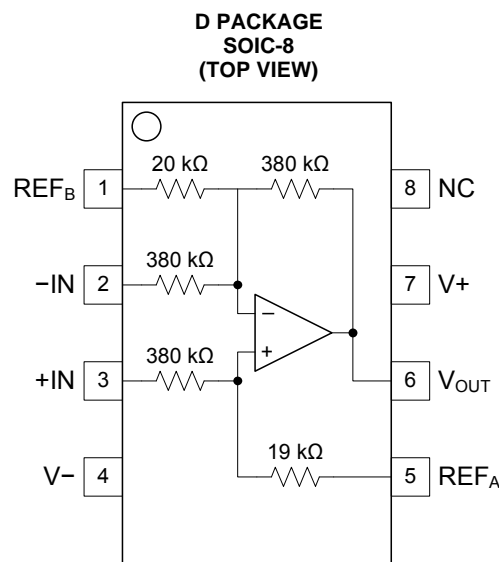
PIN CONFIGURATION

PIN DESCRIPTIONS

NAME	NO.	DESCRIPTION
-IN	2	Inverting input
+IN	3	Noninverting input
NC	8	No internal connection
REF _A	5	Reference input
REF _B	1	Reference input
V-	4	Negative power supply
V+	7	Positive power supply ⁽¹⁾
V _{OUT}	6	Output

(1) In this document, (V+) – (V-) is referred to as V_S .

TYPICAL CHARACTERISTICS

At $T_A = +25^\circ\text{C}$, $R_L = 2\text{ k}\Omega$ connected to ground, and $V_S = \pm 15\text{ V}$, unless otherwise noted.

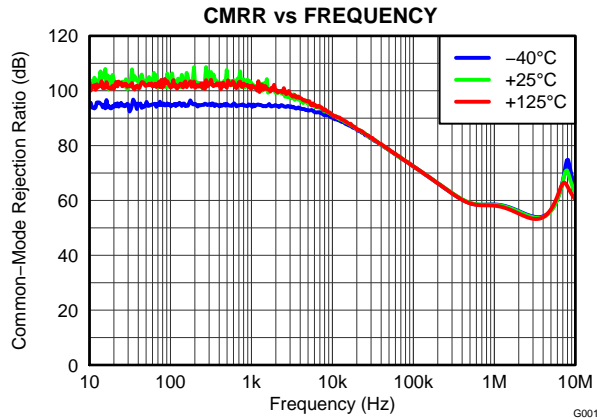

Figure 1.

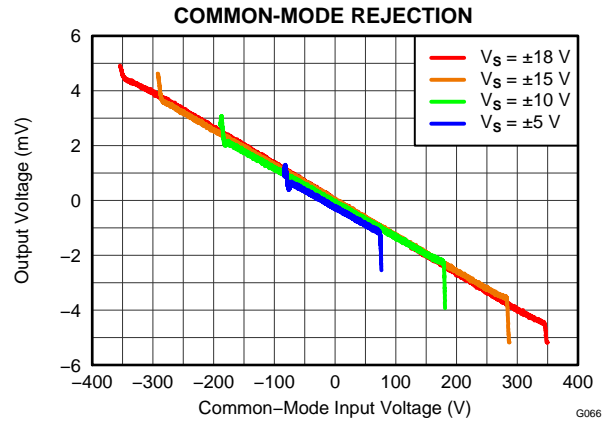

Figure 2.

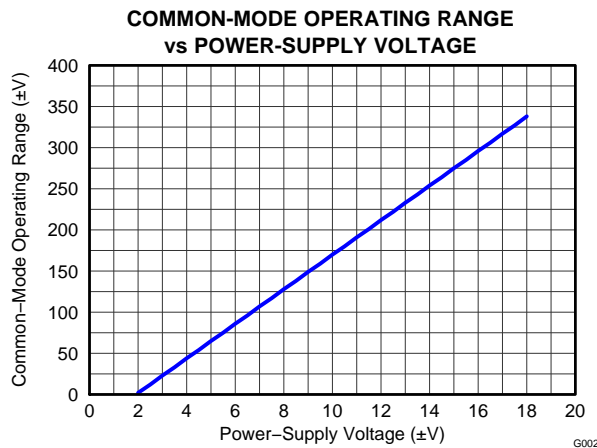

Figure 3.

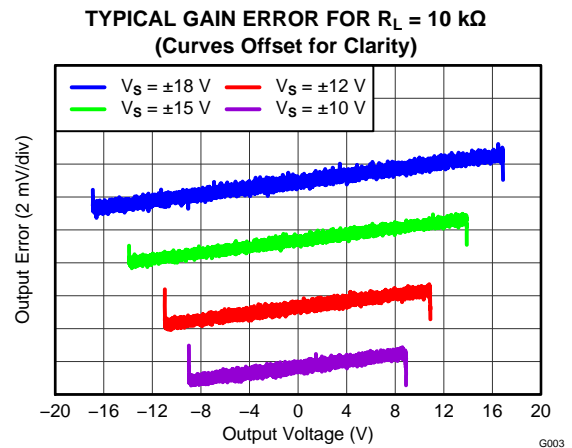

Figure 4.

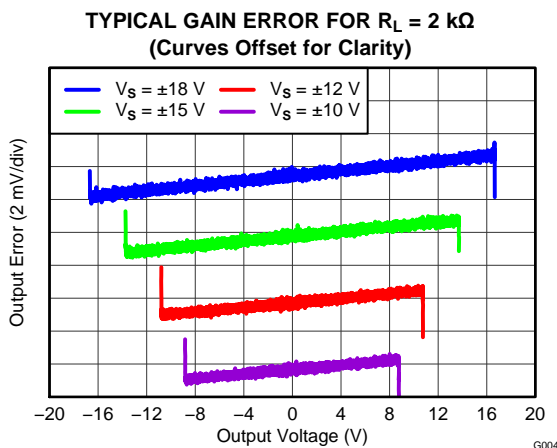

Figure 5.

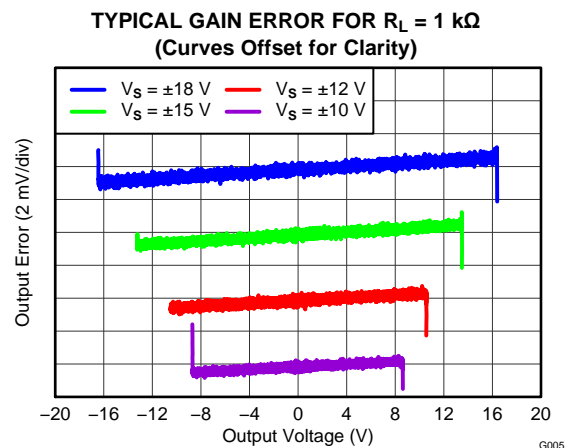

Figure 6.

TYPICAL CHARACTERISTICS (continued)

At $T_A = +25^\circ\text{C}$, $R_L = 2\text{ k}\Omega$ connected to ground, and $V_S = \pm 15\text{ V}$, unless otherwise noted.

**TYPICAL GAIN ERROR FOR LOW SUPPLY VOLTAGES
(Curves Offset for Clarity)**

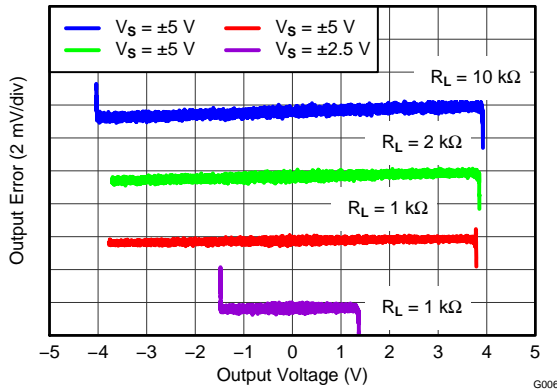

Figure 7.

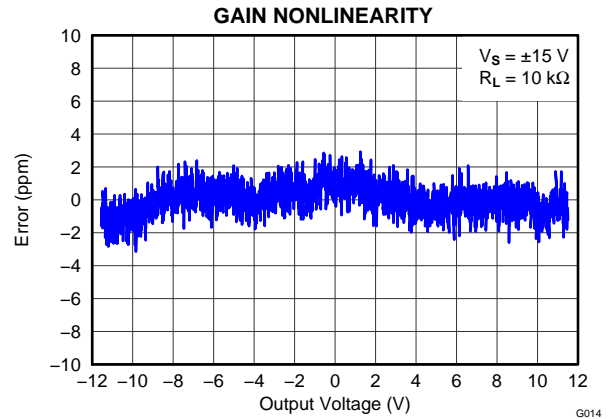

Figure 8.

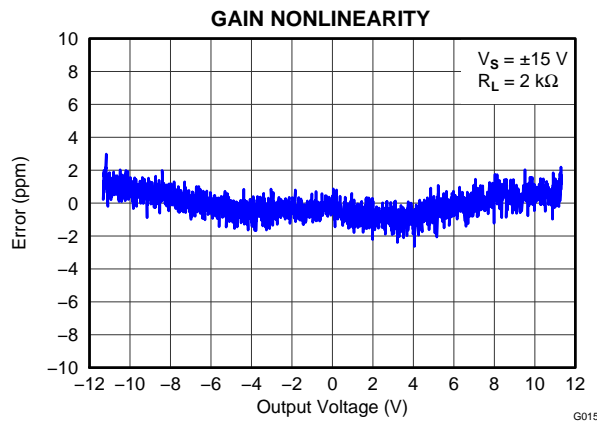

Figure 9.

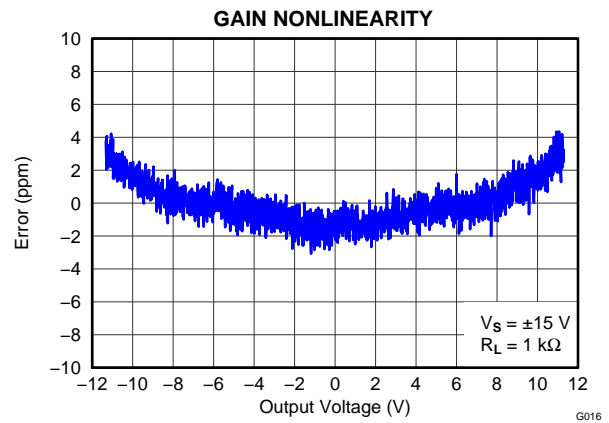

Figure 10.

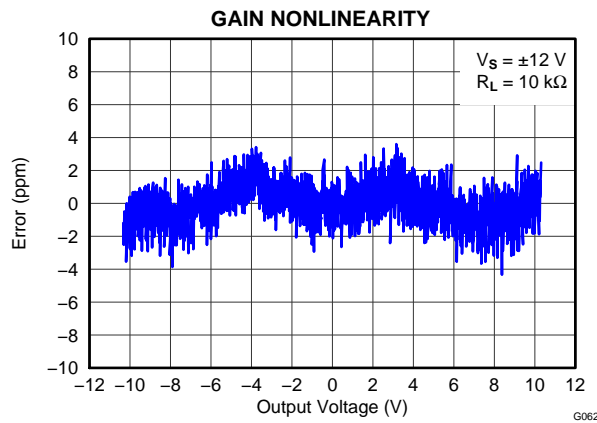

Figure 11.

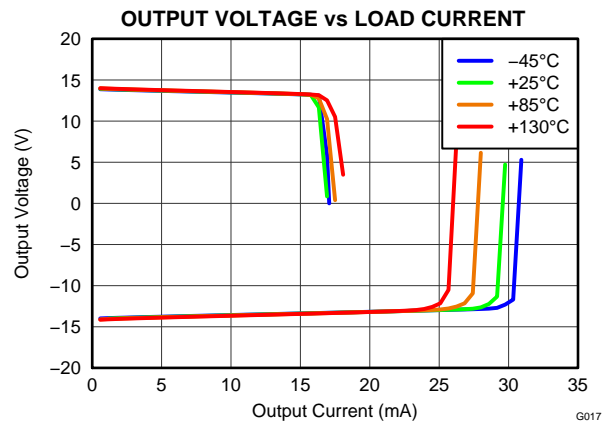

Figure 12.

TYPICAL CHARACTERISTICS (continued)

At $T_A = +25^\circ\text{C}$, $R_L = 2\text{ k}\Omega$ connected to ground, and $V_S = \pm 15\text{ V}$, unless otherwise noted.

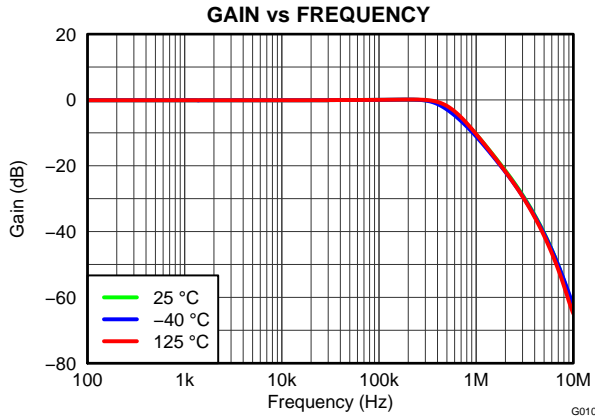

Figure 13.

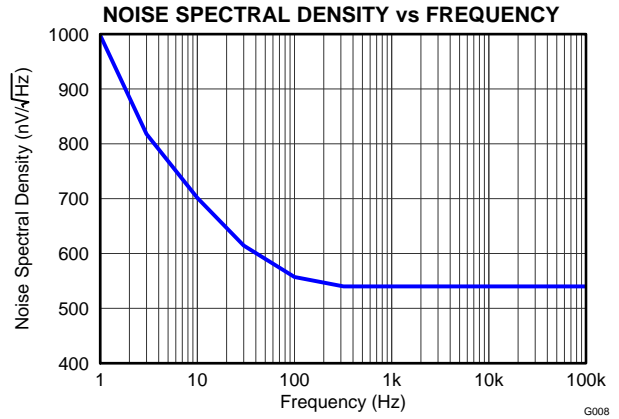

Figure 14.

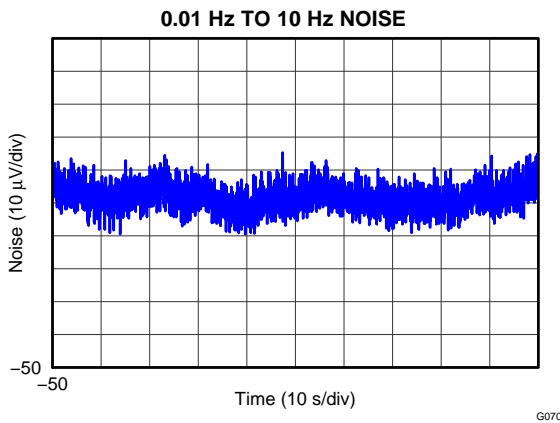

Figure 15.

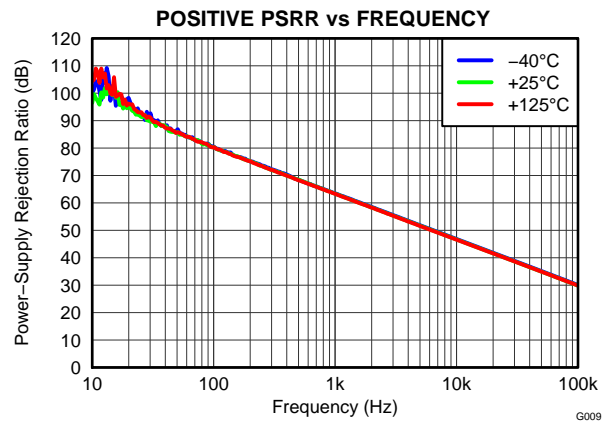

Figure 16.

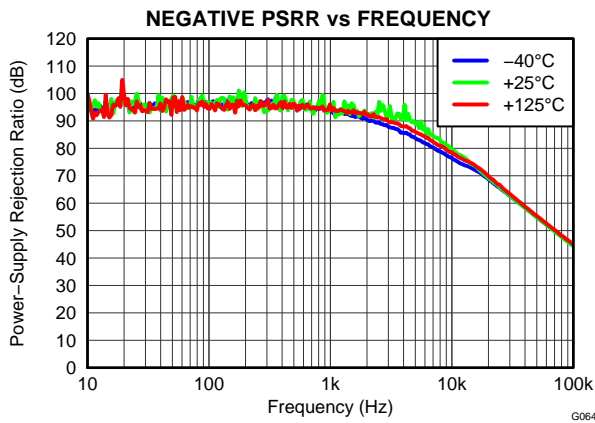

Figure 17.

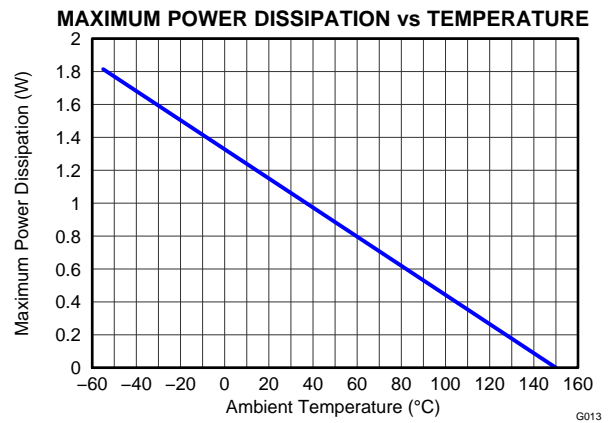

Figure 18.

TYPICAL CHARACTERISTICS (continued)

At $T_A = +25^\circ\text{C}$, $R_L = 2\text{ k}\Omega$ connected to ground, and $V_S = \pm 15\text{ V}$, unless otherwise noted.

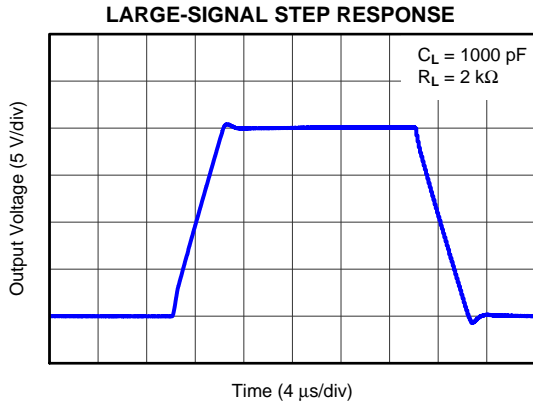

Figure 19.

G011

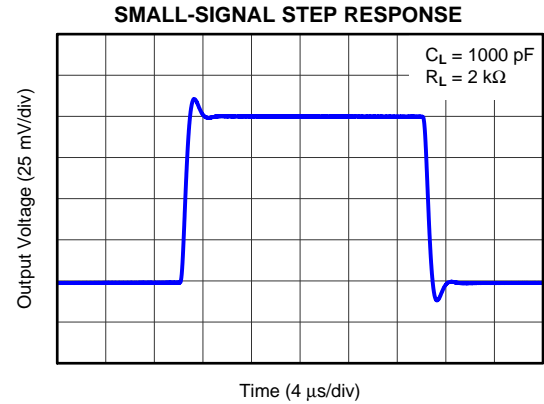

Figure 20.

G012

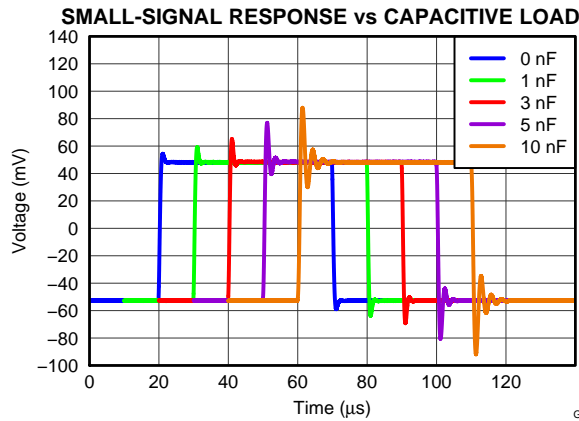

Figure 21.

G065

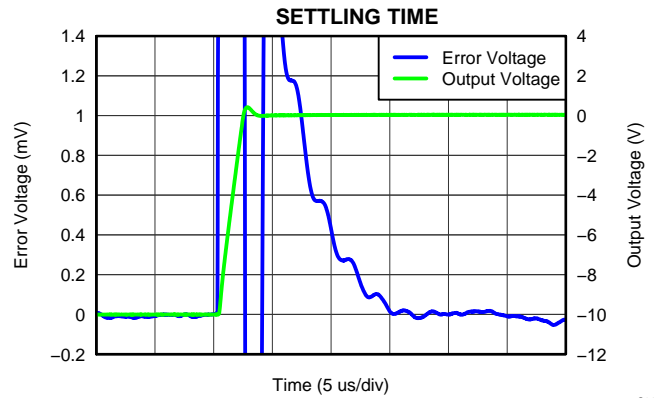

Figure 22.

G018

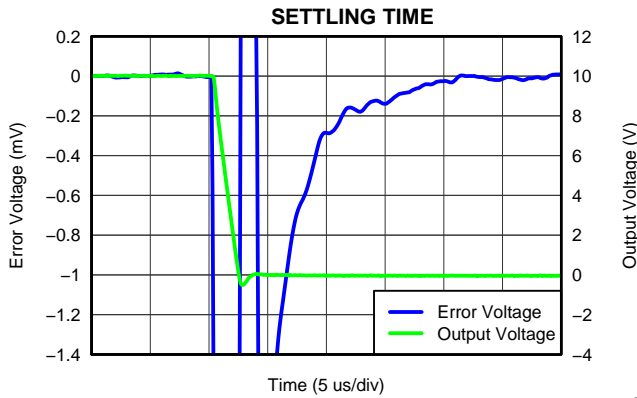

Figure 23.

G063

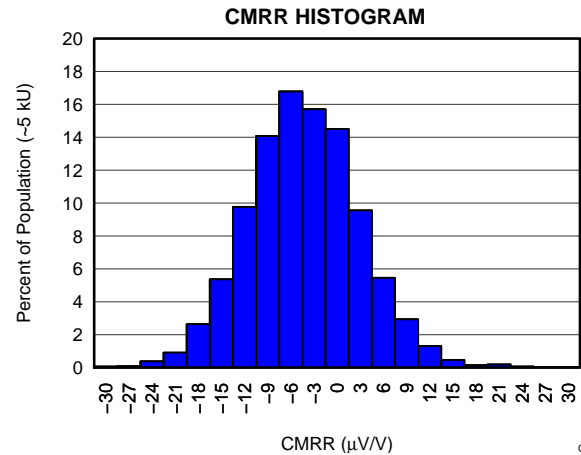

Figure 24.

G019

TYPICAL CHARACTERISTICS (continued)

At $T_A = +25^\circ\text{C}$, $R_L = 2\text{ k}\Omega$ connected to ground, and $V_S = \pm 15\text{ V}$, unless otherwise noted.

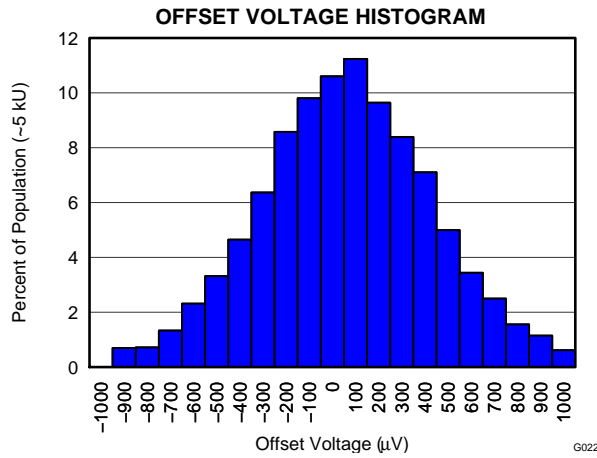

Figure 25.

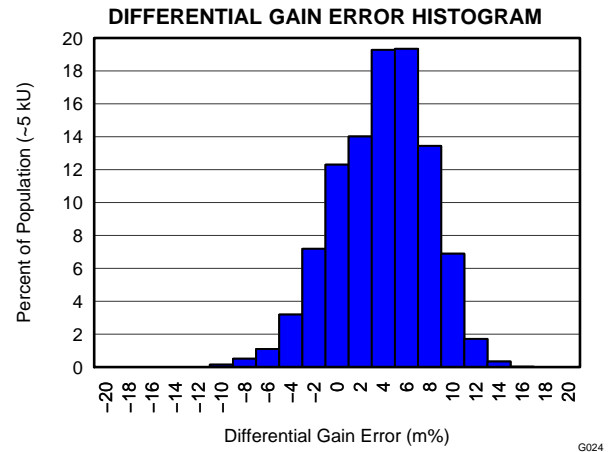

Figure 26.

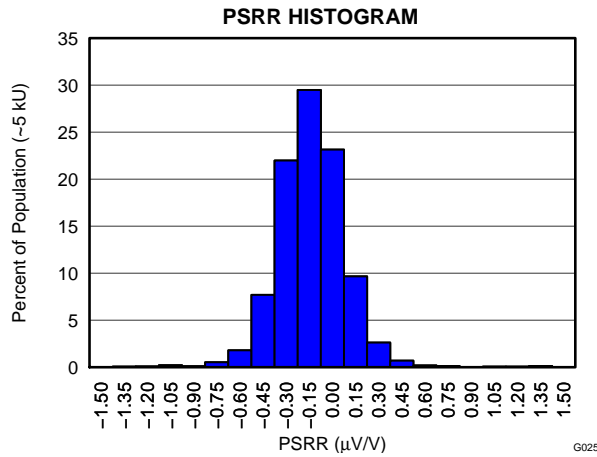

Figure 27.

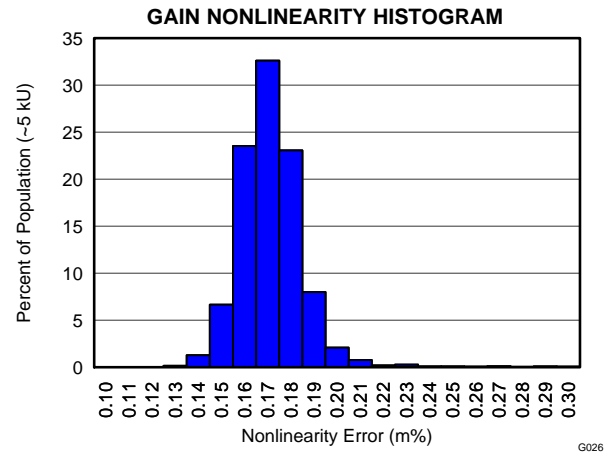

Figure 28.

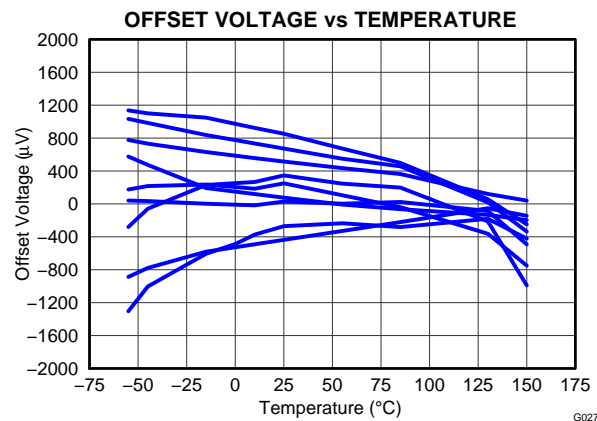

Figure 29.

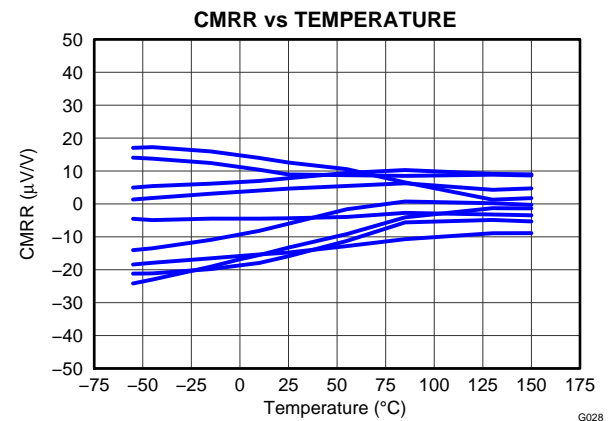

Figure 30.

TYPICAL CHARACTERISTICS (continued)

At $T_A = +25^\circ\text{C}$, $R_L = 2\text{ k}\Omega$ connected to ground, and $V_S = \pm 15\text{ V}$, unless otherwise noted.

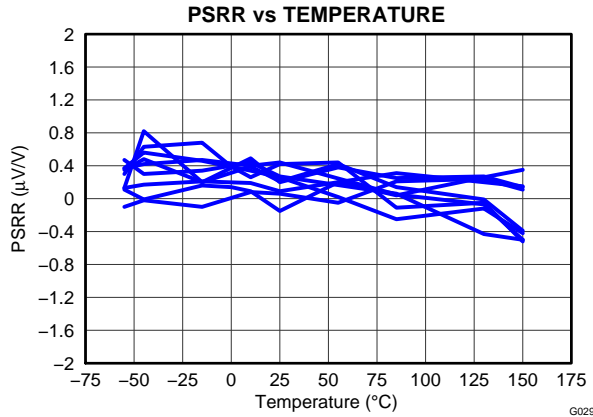

Figure 31.

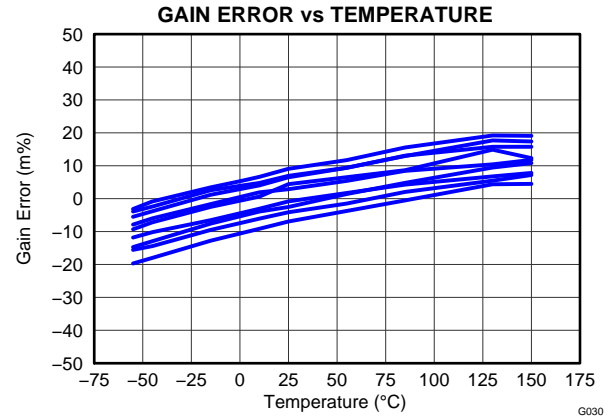

Figure 32.

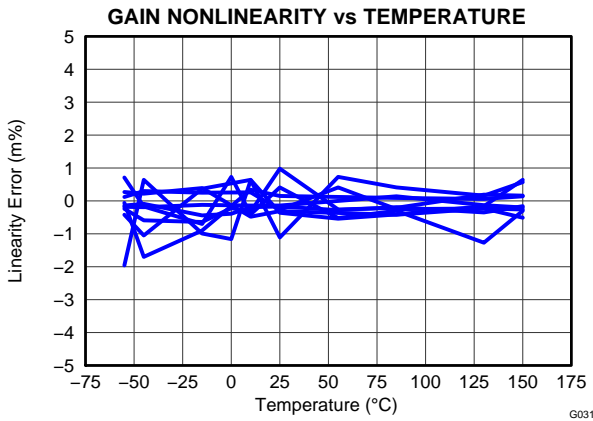

Figure 33.

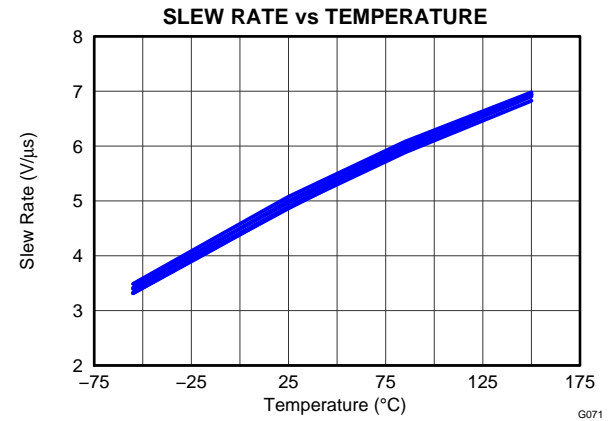

Figure 34.

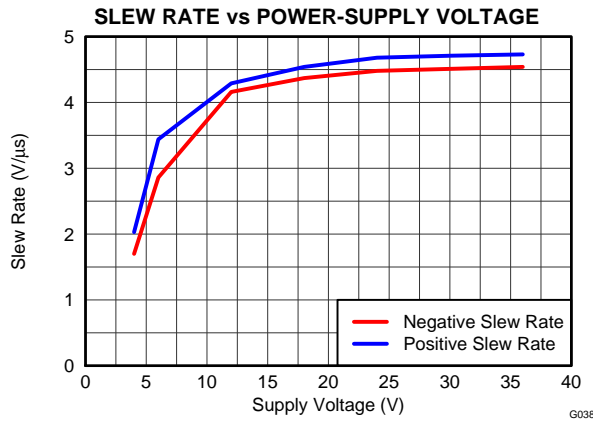

Figure 35.

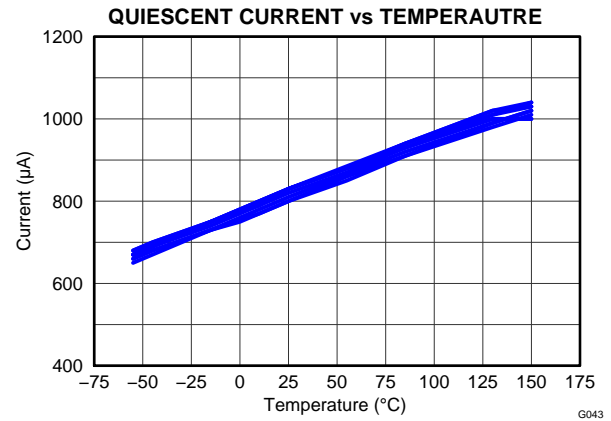

Figure 36.

TYPICAL CHARACTERISTICS (continued)

At $T_A = +25^\circ\text{C}$, $R_L = 2\text{ k}\Omega$ connected to ground, and $V_S = \pm 15\text{ V}$, unless otherwise noted.

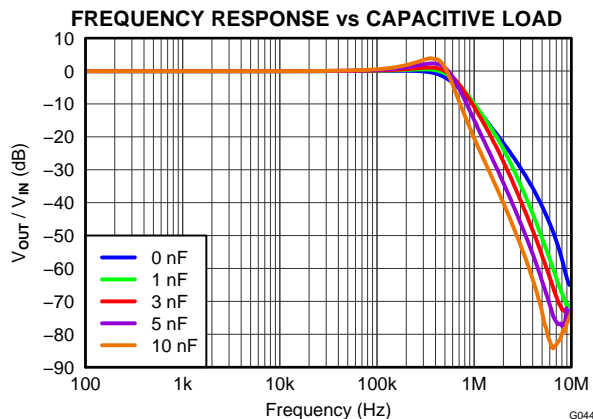

Figure 37.

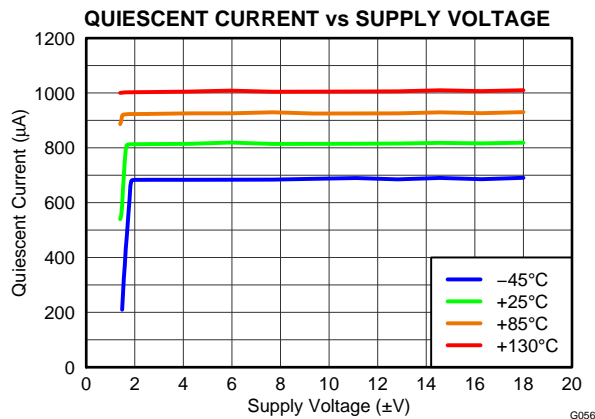

Figure 38.

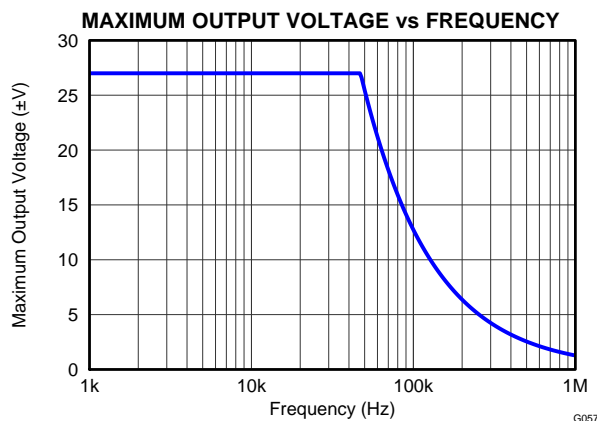

Figure 39.

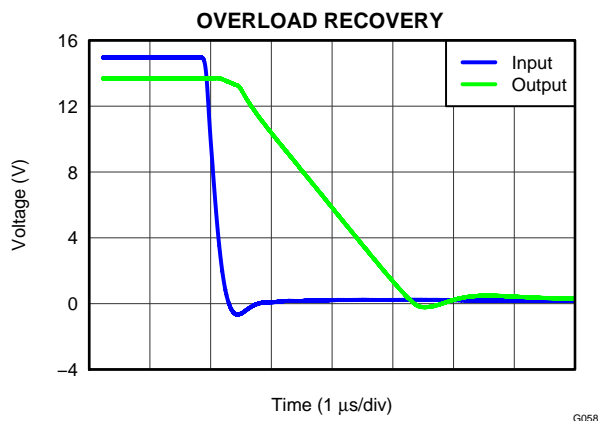

Figure 40.

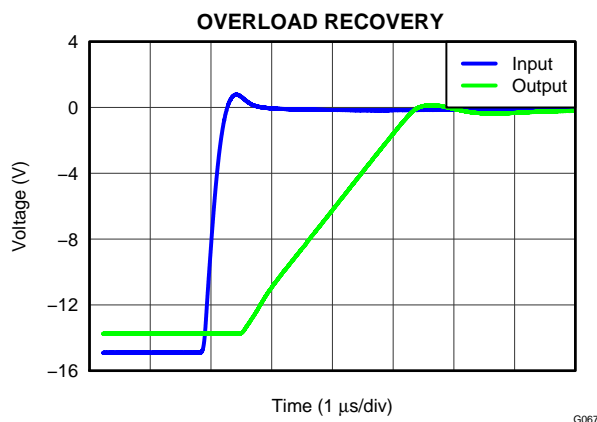

Figure 41.

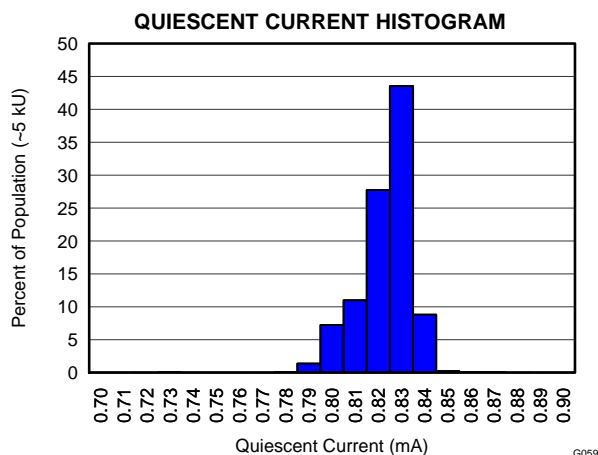

Figure 42.

APPLICATION INFORMATION

BASIC INFORMATION

Figure 43 shows the basic connections required for dual-supply operation. Applications with noisy or high-impedance power-supply lines may require decoupling capacitors placed close to the device pins. The output voltage is equal to the differential input voltage between pins 2 and 3. The common-mode input voltage is rejected. Figure 44 shows the basic connections required for single-supply operation.

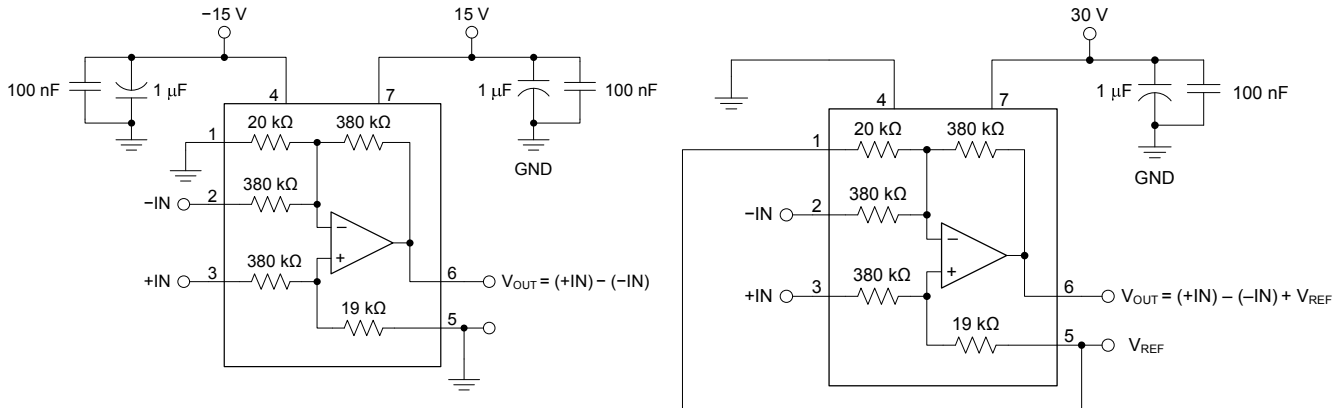

Figure 43. Basic Power and Signal Connections for Dual-Supply Operation

Figure 44. Basic Power and Signal Connections for Single-Supply Operation

TRANSFER FUNCTION

Most applications use the INA149 as a simple unity-gain difference amplifier. The transfer function is given in Equation 1:

$$V_{OUT} = (+IN) - (-IN) \quad (1)$$

Some applications, however, apply voltages to the reference terminals (REF_A and REF_B). The complete transfer function is given in Equation 2:

$$V_{OUT} = (+IN) - (-IN) + 20 \times REF_A - 19 \times REF_B \quad (2)$$

COMMON-MODE RANGE

The high common-mode range of the INA149 is achieved by dividing down the input signal with a high precision resistor divider. This resistor divider brings both the positive input and the negative input within the input range of the internal operational amplifier. This input range depends on the supply voltage of the INA149.

Both Figure 2 and Figure 3 can be used to determine the maximum common-mode range for a specific supply voltage. The maximum common-mode range can also be calculated by ensuring that both the positive and the negative input of the internal amplifier are within 1.5 V of the supply voltage.

In case the voltage at the inputs of the internal amplifier exceeds the supply voltage, the internal ESD diodes start conducting current. This current must be limited to 10 mA to make sure not to exceed the absolute maximum ratings for the device.

COMMON-MODE REJECTION

Common-mode rejection (CMR) of the INA149 depends on the input resistor network, which is laser-trimmed for accurate ratio matching. To maintain high CMR, it is important to have low source impedance driving the two inputs. A 75- Ω resistance in series with pins 2 or 3 decreases the common-mode rejection ratio (CMRR) from 100 dB (typical) to 74 dB.

Resistance in series with the reference pins also degrades CMR. A 4- Ω resistance in series with pins 1 or 5 decreases CMRR from 100 dB to 74 dB.

Most applications do not require trimming. [Figure 45](#) shows an optional circuit that may be used for trimming offset voltage and common-mode rejection.

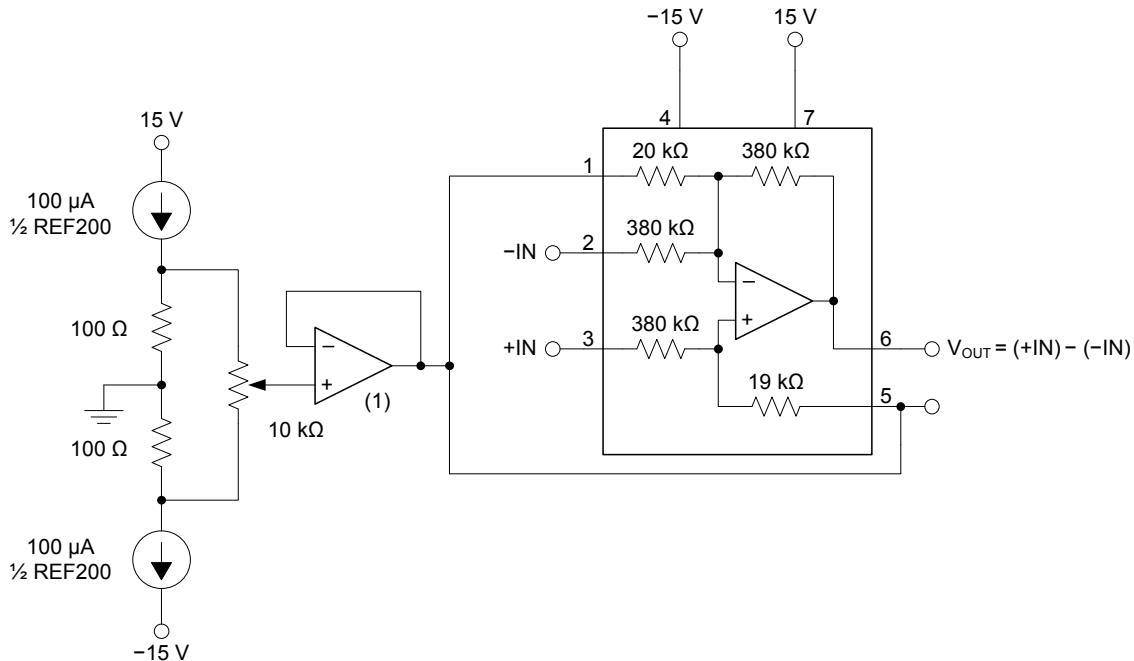

(1) The [OPA171](#) (a 36-V, low-power, RRO, general-purpose operational amplifier) can be used for this application.

Figure 45. Offset Voltage Trim Circuit

MEASURING CURRENT

The INA149 can be used to measure a current by sensing the voltage drop across a series resistor, R_S . Figure 46 shows the INA149 used to measure the supply currents of a device under test.

The sense resistor imbalances the input resistor matching of the INA149, thus degrading its CMR. Also, the input impedance of the INA149 loads R_S , causing gain error in the voltage-to-current conversion. Both of these errors can be easily corrected.

The CMR error can be corrected with the addition of a compensation resistor (R_C), equal to the value of R_S , as shown in Figure 46. If R_S is less than 5 Ω , degradation in the CMR is negligible and R_C can be omitted. If R_S is larger than approximately 1 k Ω , trimming R_C may be required to achieve greater than 90-dB CMR. This error is caused by the INA149 input impedance mismatch.

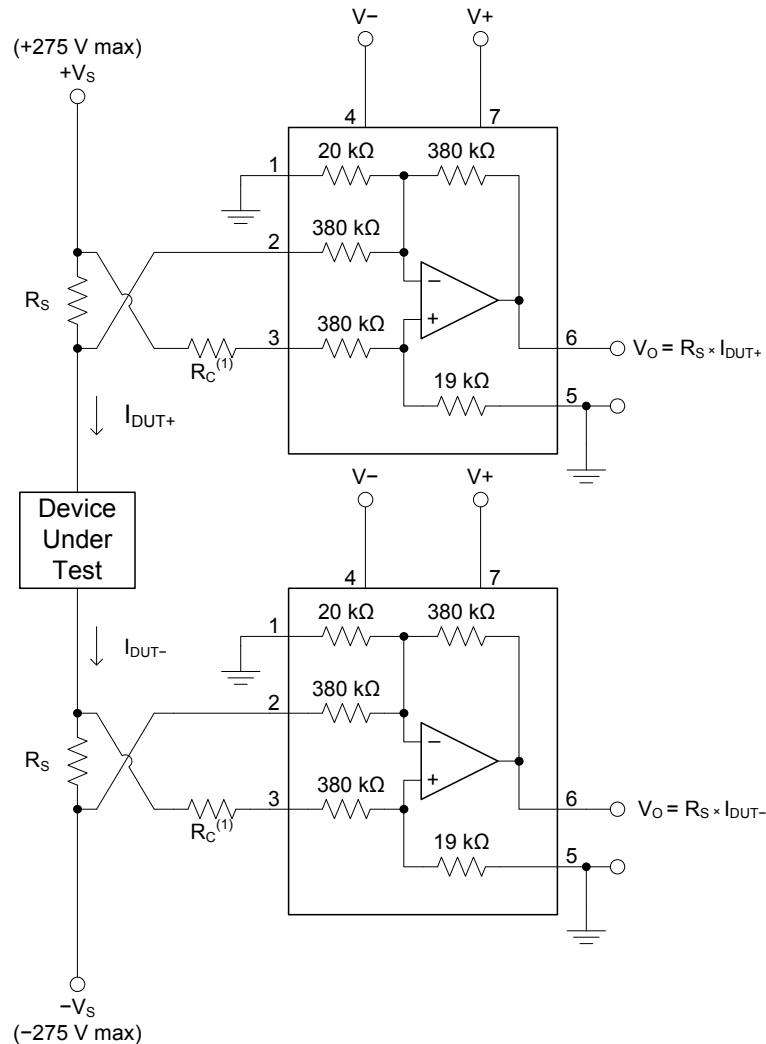

Figure 46. Measuring Supply Currents of a Device Under Test

If R_S is more than approximately 50 Ω , the gain error is greater than the 0.02% specification of the INA149. This gain error can be corrected by slightly increasing the value of R_S . The corrected value (R_S') can be calculated by $R_S' = R_S \times 380 \text{ k}\Omega / (380 \text{ k}\Omega - R_S)$ (3)

Example: For a 1-V/mA transfer function, the nominal, uncorrected value for R_S would be 1 k Ω . A slightly larger value ($R_S' = 1002.6 \Omega$), compensates for the gain error as a result of loading.

The 380-k Ω term in the equation for R_S' has a tolerance of 25%, thus sense resistors above approximately 400 Ω may require trimming to achieve gain accuracy better than 0.02%.

NOISE PERFORMANCE

The wideband noise performance of the INA149 is dominated by the internal resistor network. The thermal or *Johnson noise* of these resistors measures approximately 550 nV/√Hz. The internal op amp contributes virtually no excess noise at frequencies above 100 Hz.

Many applications may be satisfied with less than the full 500-kHz bandwidth of the INA149. In these cases, the noise can be reduced with a low-pass filter on the output. The two-pole filter shown in Figure 47 limits bandwidth and reduces noise. Because the INA149 has a 1/f noise corner frequency of approximately 100 Hz, a cutoff frequency below 100 Hz does not further reduce noise.

Component values for different filter frequencies are shown in Table 1.

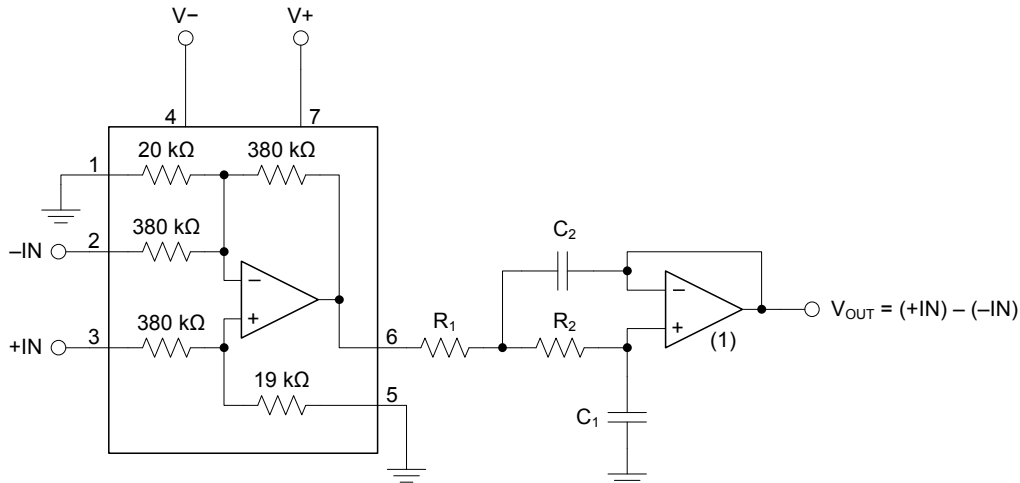

(1) For most applications, the OPA171 can be used as an operational amplifier. For directly driving successive-approximation register (SAR) data converters, the OPA140 is a good choice.

Figure 47. Output Filter for Noise Reduction

Table 1. Components Values for Different Filter Bandwidths

BUTTERWORTH LOW-PASS (f _{-3 dB})	OUTPUT NOISE (mV _{PP})	R ₁	R ₂	C ₁	C ₂
200 kHz	1.8	No filter			
100 kHz	1.1	11 kΩ	11.3 kΩ	100 pF	200 pF
10 kHz	0.35	11 kΩ	11.3 kΩ	1 nF	2 nF
1 kHz	0.11	11 kΩ	11.3 kΩ	10 nF	20 nF
100 Hz	0.05	11 kΩ	11.3 kΩ	0.1 μF	0.2 μF

ERROR BUDGET ANALYSIS

The following error budget analysis demonstrates the importance of a high common-mode rejection ratio when measuring small differential signals in the presence of high common-mode voltages. Figure 48 shows a typical current measurement application.

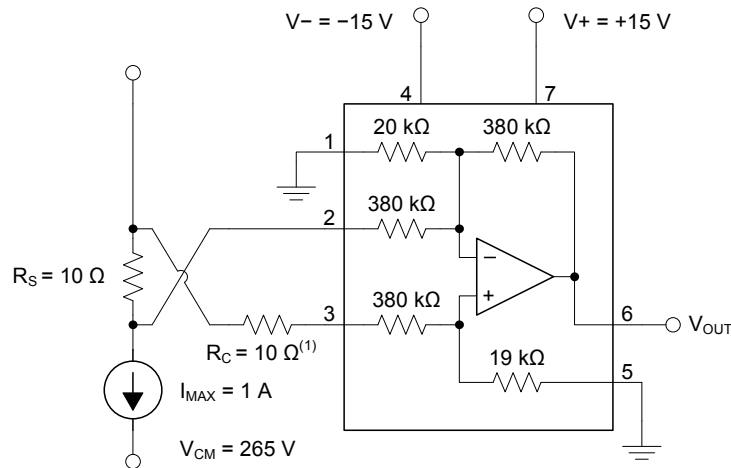

(1) See the [Measuring Current](#) section for details about R_C .

Figure 48. Typical Current Measurement Application

The maximum current through the shunt resistor (R_S) is 1 A and generates a full-scale voltage drop of 10 V. All error sources in this calculation are shown in relation to this full-scale voltage. The common-mode voltage in this scenario is 265 V and the temperature range is from room temperature (+25°C) to +85°C. Table 2 shows the dominant error sources for the INA149 and a competitor device.

Table 2. Error Budget Analysis

ERROR SOURCE	INA149	COMPETITOR A	ERROR (ppm of FS)	
			INA149	COMPETITOR A
Accuracy, $T_A = +25^\circ\text{C}$				
Initial gain error	0.02% FS	0.05% FS	200	500
Offset voltage	1100 μV	1000 μV	110	100
Common mode	265 V/90 dB = 8380 μV	265 V/77 dB = 37432 μV	838	3743
Total accuracy error			1148	4343
Temperature drift				
Gain	10 ppm/ $^\circ\text{C} \times 60^\circ\text{C}$	10 ppm/ $^\circ\text{C} \times 60^\circ\text{C}$	600	600
Offset voltage	10 $\mu\text{V}/^\circ\text{C} \times 60^\circ\text{C}$	20 $\mu\text{V}/^\circ\text{C} \times 60^\circ\text{C}$	60	120
Total drift error			660	720
Total error			1808	5063

If a smaller shunt resistor is used, the full-scale voltage drop is also smaller. A shunt resistor of 1 Ω causes a 1-V voltage drop with a current of 1 A flowing through it. The error of 1808 ppm for a full-scale voltage of 10 V becomes 18080 ppm (1.6%) for a full-scale voltage of only 1 V.

This example demonstrates that the dominate source of error, even over temperature, comes from the CMRR specification of the devices. The common-mode error is 46% of the total error for the INA149 and 74% of the total error for the competitor device.

BATTERY CELL VOLTAGE MONITOR

The INA149 can be used to measure the voltages of single cells in a stacked battery pack. Figure 49 shows an examples for such an application.

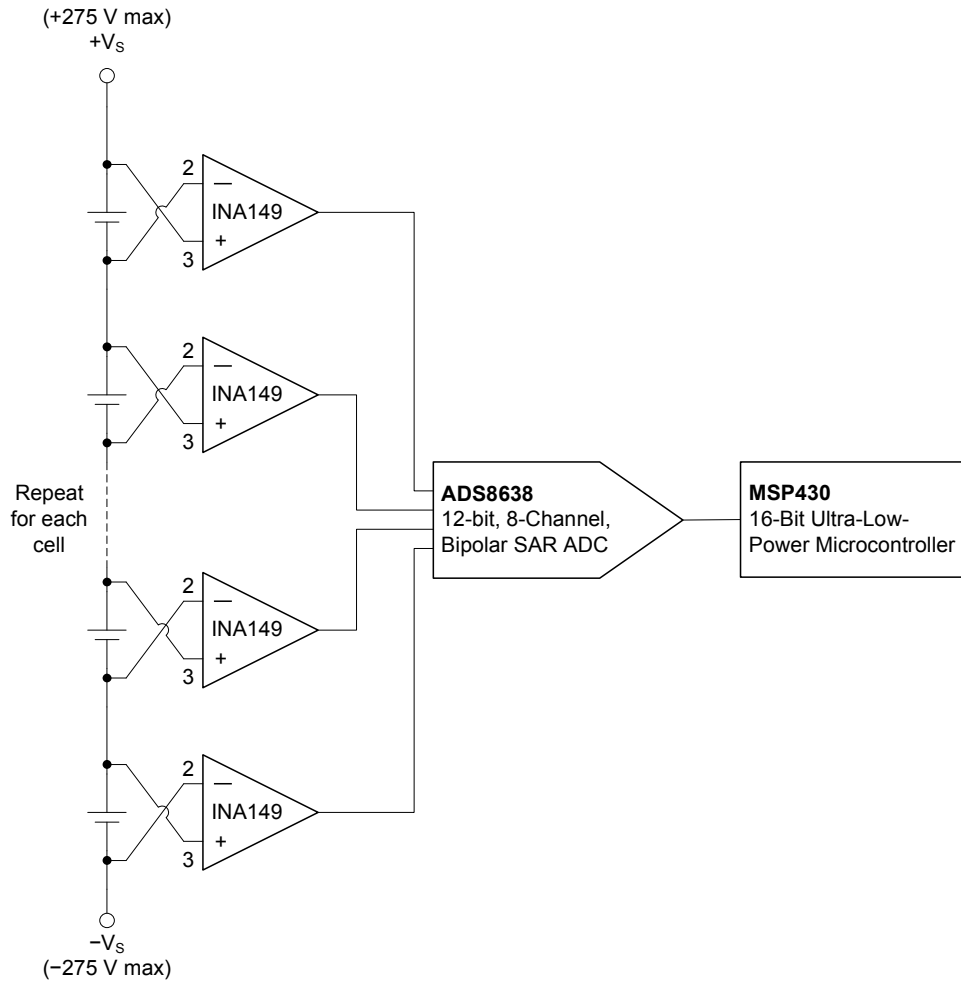

Figure 49. Battery Cell Voltage Monitor

REVISION HISTORY

NOTE: Page numbers for previous revisions may differ from page numbers in the current version.

Changes from Revision A (November 2011) to Revision B	Page
• Changed package marking data in Package/Ordering Information table	2

PACKAGING INFORMATION

Orderable part number	Status (1)	Material type (2)	Package Pins	Package qty Carrier	RoHS (3)	Lead finish/ Ball material (4)	MSL rating/ Peak reflow (5)	Op temp (°C)	Part marking (6)
INA149AID	Active	Production	SOIC (D) 8	75 TUBE	Yes	NIPDAU	Level-2-260C-1 YEAR	-40 to 125	INA 149A
INA149AID.B	Active	Production	SOIC (D) 8	75 TUBE	Yes	NIPDAU	Level-2-260C-1 YEAR	-40 to 125	INA 149A
INA149AIDR	Active	Production	SOIC (D) 8	2500 LARGE T&R	Yes	NIPDAU	Level-2-260C-1 YEAR	-40 to 125	INA 149A
INA149AIDR.B	Active	Production	SOIC (D) 8	2500 LARGE T&R	Yes	NIPDAU	Level-2-260C-1 YEAR	-40 to 125	INA 149A
INA149AIDRG4	Active	Production	SOIC (D) 8	2500 LARGE T&R	Yes	NIPDAU	Level-2-260C-1 YEAR	-40 to 125	INA 149A
INA149AIDRG4.B	Active	Production	SOIC (D) 8	2500 LARGE T&R	Yes	NIPDAU	Level-2-260C-1 YEAR	-40 to 125	INA 149A

(1) **Status:** For more details on status, see our [product life cycle](#).

(2) **Material type:** When designated, preproduction parts are prototypes/experimental devices, and are not yet approved or released for full production. Testing and final process, including without limitation quality assurance, reliability performance testing, and/or process qualification, may not yet be complete, and this item is subject to further changes or possible discontinuation. If available for ordering, purchases will be subject to an additional waiver at checkout, and are intended for early internal evaluation purposes only. These items are sold without warranties of any kind.

(3) **RoHS values:** Yes, No, RoHS Exempt. See the [TI RoHS Statement](#) for additional information and value definition.

(4) **Lead finish/Ball material:** Parts may have multiple material finish options. Finish options are separated by a vertical ruled line. Lead finish/Ball material values may wrap to two lines if the finish value exceeds the maximum column width.

(5) **MSL rating/Peak reflow:** The moisture sensitivity level ratings and peak solder (reflow) temperatures. In the event that a part has multiple moisture sensitivity ratings, only the lowest level per JEDEC standards is shown. Refer to the shipping label for the actual reflow temperature that will be used to mount the part to the printed circuit board.

(6) **Part marking:** There may be an additional marking, which relates to the logo, the lot trace code information, or the environmental category of the part.

Multiple part markings will be inside parentheses. Only one part marking contained in parentheses and separated by a "~" will appear on a part. If a line is indented then it is a continuation of the previous line and the two combined represent the entire part marking for that device.

Important Information and Disclaimer: The information provided on this page represents TI's knowledge and belief as of the date that it is provided. TI bases its knowledge and belief on information provided by third parties, and makes no representation or warranty as to the accuracy of such information. Efforts are underway to better integrate information from third parties. TI has taken and continues to take reasonable steps to provide representative and accurate information but may not have conducted destructive testing or chemical analysis on incoming materials and chemicals. TI and TI suppliers consider certain information to be proprietary, and thus CAS numbers and other limited information may not be available for release.

In no event shall TI's liability arising out of such information exceed the total purchase price of the TI part(s) at issue in this document sold by TI to Customer on an annual basis.

OTHER QUALIFIED VERSIONS OF INA149 :

- Enhanced Product : [INA149-EP](#)

NOTE: Qualified Version Definitions:

- Enhanced Product - Supports Defense, Aerospace and Medical Applications

TUBE

*All dimensions are nominal

Device	Package Name	Package Type	Pins	SPQ	L (mm)	W (mm)	T (μm)	B (mm)
INA149AID	D	SOIC	8	75	506.6	8	3940	4.32
INA149AID.B	D	SOIC	8	75	506.6	8	3940	4.32



D0008A

PACKAGE OUTLINE

SOIC - 1.75 mm max height

SMALL OUTLINE INTEGRATED CIRCUIT



4214825/C 02/2019

NOTES:

- Linear dimensions are in inches [millimeters]. Dimensions in parenthesis are for reference only. Controlling dimensions are in inches. Dimensioning and tolerancing per ASME Y14.5M.
- This drawing is subject to change without notice.
- This dimension does not include mold flash, protrusions, or gate burrs. Mold flash, protrusions, or gate burrs shall not exceed .006 [0.15] per side.
- This dimension does not include interlead flash.
- Reference JEDEC registration MS-012, variation AA.

EXAMPLE BOARD LAYOUT

D0008A

SOIC - 1.75 mm max height

SMALL OUTLINE INTEGRATED CIRCUIT



LAND PATTERN EXAMPLE
 EXPOSED METAL SHOWN
 SCALE:8X



SOLDER MASK DETAILS

4214825/C 02/2019

NOTES: (continued)

- 6. Publication IPC-7351 may have alternate designs.
- 7. Solder mask tolerances between and around signal pads can vary based on board fabrication site.

EXAMPLE STENCIL DESIGN

D0008A

SOIC - 1.75 mm max height

SMALL OUTLINE INTEGRATED CIRCUIT



SOLDER PASTE EXAMPLE
BASED ON .005 INCH [0.125 MM] THICK STENCIL
SCALE:8X

4214825/C 02/2019

NOTES: (continued)

8. Laser cutting apertures with trapezoidal walls and rounded corners may offer better paste release. IPC-7525 may have alternate design recommendations.
9. Board assembly site may have different recommendations for stencil design.

IMPORTANT NOTICE AND DISCLAIMER

TI PROVIDES TECHNICAL AND RELIABILITY DATA (INCLUDING DATASHEETS), DESIGN RESOURCES (INCLUDING REFERENCE DESIGNS), APPLICATION OR OTHER DESIGN ADVICE, WEB TOOLS, SAFETY INFORMATION, AND OTHER RESOURCES "AS IS" AND WITH ALL FAULTS, AND DISCLAIMS ALL WARRANTIES, EXPRESS AND IMPLIED, INCLUDING WITHOUT LIMITATION ANY IMPLIED WARRANTIES OF MERCHANTABILITY, FITNESS FOR A PARTICULAR PURPOSE OR NON-INFRINGEMENT OF THIRD PARTY INTELLECTUAL PROPERTY RIGHTS.

These resources are intended for skilled developers designing with TI products. You are solely responsible for (1) selecting the appropriate TI products for your application, (2) designing, validating and testing your application, and (3) ensuring your application meets applicable standards, and any other safety, security, regulatory or other requirements.

These resources are subject to change without notice. TI grants you permission to use these resources only for development of an application that uses the TI products described in the resource. Other reproduction and display of these resources is prohibited. No license is granted to any other TI intellectual property right or to any third party intellectual property right. TI disclaims responsibility for, and you fully indemnify TI and its representatives against any claims, damages, costs, losses, and liabilities arising out of your use of these resources.

TI's products are provided subject to [TI's Terms of Sale](#), [TI's General Quality Guidelines](#), or other applicable terms available either on [ti.com](#) or provided in conjunction with such TI products. TI's provision of these resources does not expand or otherwise alter TI's applicable warranties or warranty disclaimers for TI products. Unless TI explicitly designates a product as custom or customer-specified, TI products are standard, catalog, general purpose devices.

TI objects to and rejects any additional or different terms you may propose.

Copyright © 2025, Texas Instruments Incorporated

Last updated 10/2025