

# LM339B, LM2901B, LM339, LM239, LM139, LM2901 Quad Differential Comparators

## 1 Features

- NEW [LM339B](#) and [LM2901B](#)
- Improved specifications of B-version
  - Maximum rating: up to 38V
  - ESD rating (HBM): 2kV
  - Low input offset: 0.37mV
  - Low input bias current: 3.5nA
  - Low supply-current: 200µA per comparator
  - Faster response time of 1µsec
  - Extended temperature range for LM339B
- B-version is drop-in replacement for LM239, LM339 and LM2901, A and V versions
- Common-mode input voltage range includes ground
- Differential input voltage range equal to maximum-rated supply voltage: ±38V
- Low output saturation voltage
- Output compatible with TTL, MOS, and CMOS
- For single version, see the [TL331B](#)
- For dual version, see the [LM393B](#) or [LM2903B](#)

## 2 Applications

- [Vacuum robot](#)
- [Single phase UPS](#)
- [Server PSU](#)
- [Cordless power tool](#)
- [Wireless infrastructure](#)
- [Appliances](#)
- [Building automation](#)
- [Factory automation & control](#)
- [Motor drives](#)
- [Infotainment & cluster](#)

## 3 Description

The [LM339B](#) and [LM2901B](#) devices are the next generation versions of the industry-standard LM339 and LM2901 comparator family. These next generation B-version comparators feature lower offset voltage, higher supply voltage capability, lower supply current, lower input bias current, lower propagation delay, and improved 2 kV ESD performance and input ruggedness through dedicated ESD clamps. The LM339B and LM2901B can drop-in replace the LM239, LM339 and LM2901, for both "A" and "V" grades.

All devices consist of four independent voltage comparators that are designed to operate from a single power supply over a wide range of voltages. Quiescent current is independent of the supply voltage.

### Device Information

PART NUMBER	PACKAGE <sup>(1)</sup>	BODY SIZE (NOM)
LM139x, LM239x, LM339x, LM2901x, LM339B, LM2901B	SOIC (14)	8.70mm × 3.90mm
LM239, LM339x, LM2901	PDIP (14)	19.30mm × 6.40mm
LM239, LM2901, LM339B, LM2901B	TSSOP (14)	5.00mm × 4.40mm
LM339x, LM2901	SOP (14)	10.20mm × 5.30mm
LM339x, LM2901	SSOP (14)	6.50mm × 5.30mm
LM2901B	SOT-23 (14)	4.20mm × 2.00mm
LM339B, LM2901B	WQFN (16)	3.00mm × 3.00mm

(1) For all available packages, see the orderable addendum at the end of the data sheet.

### Family Comparison Table

Specification	<a href="#">LM339B</a>	<a href="#">LM2901B</a>	<a href="#">LM339 LM339A</a>	<a href="#">LM2901 LM2901A</a>	<a href="#">LM2901V LM2901AV</a>	<a href="#">LM139 LM139A</a>	<a href="#">LM239 LM239A</a>	Units
Supply Voltage	2 to 36	2 to 36	2 to 30	2 to 30	2 to 32	2 to 30	2 to 30	V
Total Supply Current (5V to 36V max)	0.8 to 1	0.8 to 1	1 to 2.5	1 to 2.5	1 to 2.5	1 to 2.5	1 to 2.5	mA
Temperature Range	-40 to 85	-40 to 125	0 to 70	-40 to 125	-40 to 125	-55 to 125	-25 to 85	°C
ESD (HBM)	2000	2000	2000	2000	2000	2000	2000	V
Offset Voltage (Max over temp)	± 5.5	± 5.5	± 9 ± 4	± 15 ± 4	± 15 ± 4	± 9 ± 4	± 9 ± 4	mV
Input Bias Current (typ / max)	3.5 / 25	3.5 / 25	25 / 250	25 / 250	25 / 250	25 / 100	25 / 250	nA
Response Time (typ)	1	1	1.3	1.3	1.3	1.3	1.3	µsec



## Table of Contents

<b>1 Features</b> .....	1	6.14 Switching Characteristics for LMx39 and LMx39A..	12
<b>2 Applications</b> .....	1	6.15 Switching Characteristics for LM2901.....	12
<b>3 Description</b> .....	1	6.16 Typical Characteristics.....	13
<b>4 Other Versions</b> .....	3	<b>7 Detailed Description</b> .....	19
<b>5 Pin Configuration and Functions</b> .....	4	7.1 Overview.....	19
<b>6 Specifications</b> .....	5	7.2 Functional Block Diagram.....	19
6.1 Absolute Maximum Ratings for LM339B and LM2901B .....	5	7.3 Feature Description.....	19
6.2 Absolute Maximum Ratings for Non-B Versions.....	5	7.4 Device Functional Modes.....	19
6.3 ESD Ratings.....	6	<b>8 Application and Implementation</b> .....	20
6.4 Recommended Operating Conditions for LM339B and LM2901B .....	6	8.1 Application Information.....	20
6.5 Recommended Operating Conditions, Non-B Versions.....	6	8.2 Typical Application.....	20
6.6 Thermal Information.....	6	8.3 Power Supply Recommendations.....	22
6.7 Electrical Characteristics for LM339B.....	7	8.4 Layout.....	22
6.8 Electrical Characteristics for LM2901B .....	8	<b>9 Device and Documentation Support</b> .....	23
6.9 Electrical Characteristics for LM139 and LM139A.....	9	9.1 Related Links.....	23
6.10 Electrical Characteristics for LMx39 and LMx39A..	10	9.2 Receiving Notification of Documentation Updates...	23
6.11 Electrical Characteristics for LM2901, LM2901V and LM2901AV.....	11	9.3 Support Resources.....	23
6.12 Switching Characteristics for LM139 and LM139A.....	12	9.4 Trademarks.....	23
6.13 Switching Characteristics for LM339B and LM2901B .....	12	9.5 Electrostatic Discharge Caution.....	23
		9.6 Glossary.....	23
		<b>10 Revision History</b> .....	24
		<b>11 Mechanical, Packaging, and Orderable Information</b> .....	26

## 4 Other Versions

### OTHER QUALIFIED VERSIONS OF LM139-SP, LM239A, LM2901, LM2901AV, LM2901V:

- Automotive Q100: [LM239A-Q1](#), [LM2901B-Q1](#), [LM2901-Q1](#), [LM2901AV-Q1](#), [LM2901V-Q1](#)
- Enhanced Product: [LM239A-EP](#)
- Space: [LM139-SP](#)

## 5 Pin Configuration and Functions

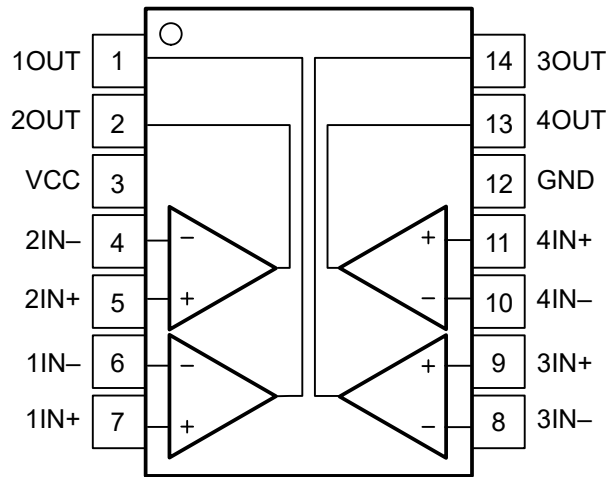

**Figure 5-1. D, DB, N, NS, PW Packages  
14-Pin SOIC, SSOP, PDIP, SOP, TSSOP  
Top View**

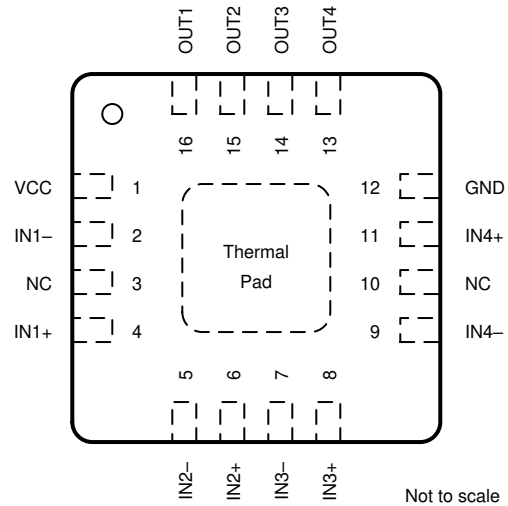

**Figure 5-2. RTE Package  
16-Pad WQFN With Exposed Thermal Pad  
Top View**

NOTE: Connect exposed thermal pad directly to GND pin.

**Table 5-1. Pin Functions**

NAME <sup>(1)</sup>	PIN		I/O	DESCRIPTION
	D, DB, N, NS, PW, DYY, J	WQFN		
OUT1 <sup>(1)</sup>	1	16	Output	Output pin of the comparator 2
OUT2 <sup>(1)</sup>	2	15	Output	Output pin of the comparator 1
V <sub>CC</sub>	3	1	—	Positive supply
IN2 <sup>−</sup> <sup>(1)</sup>	4	5	Input	Negative input pin of the comparator 1
IN2 <sup>+</sup> <sup>(1)</sup>	5	6	Input	Positive input pin of the comparator 1
IN1 <sup>−</sup> <sup>(1)</sup>	6	2	Input	Negative input pin of the comparator 2
IN1 <sup>+</sup> <sup>(1)</sup>	7	4	Input	Positive input pin of the comparator 2
IN3 <sup>−</sup>	8	7	Input	Negative input pin of the comparator 3
IN3 <sup>+</sup>	9	8	Input	Positive input pin of the comparator 3
IN4 <sup>−</sup>	10	9	Input	Negative input pin of the comparator 4
IN4 <sup>+</sup>	11	11	Input	Positive input pin of the comparator 4
GND	12	12	—	Negative supply
OUT4	13	13	Output	Output pin of the comparator 4
OUT3	14	14	Output	Output pin of the comparator 3
NC	—	3	—	No Internal Connection - Leave floating or GND
NC	—	10	—	No Internal Connection - Leave floating or GND
Thermal Pad	—	PAD	—	Connect directly to GND pin

(1) Some manufacturers transpose the names of channels 1 & 2. Electrically the pinouts are identical, just a difference in the channel naming convention.

## 6 Specifications

### 6.1 Absolute Maximum Ratings for LM339B and LM2901B

over operating free-air temperature range (unless otherwise noted)<sup>(1)</sup>

	MIN	MAX	UNIT
Supply voltage: $V_S = (V+) - (V-)$	-0.3	38	V
Differential input voltage: $V_{ID}$ <sup>(2)</sup>		±38	V
Input pins (IN+, IN-)	-0.3	38	V
Current into input pins (IN+, IN-)		-50	mA
Output pin (OUT)	-0.3	38	V
Output sink current		25	mA
Output short-circuit duration <sup>(3)</sup>		Unlimited	s
Junction temperature, $T_J$		150	°C
Storage temperature, $T_{stg}$	-65	150	°C

- (1) Stresses beyond those listed under *Absolute Maximum Ratings* can cause permanent damage to the device. These are stress ratings only, which do not imply functional operation of the device at these or any other conditions beyond those indicated under *Recommended Operating Conditions*. Exposure to absolute-maximum-rated conditions for extended periods can affect device reliability.
- (2) Differential voltages are at IN+ with respect to IN-
- (3) Short circuits from outputs to V+ can cause excessive heating and eventual destruction.

### 6.2 Absolute Maximum Ratings for Non-B Versions

over operating free-air temperature range (unless otherwise noted)<sup>(1)</sup>

	MIN	MAX	UNIT
$V_{CC}$ Supply voltage <sup>(2)</sup>		36	V
$V_{ID}$ Differential input voltage <sup>(3)</sup>		±36	V
$V_I$ Input voltage range (either input)	-0.3	36	V
$I_K$ Input current <sup>(5)</sup>		-50	mA
$V_O$ Output voltage		36	V
$I_O$ Output current		20	mA
Duration of output short circuit to ground <sup>(4)</sup>		Unlimited	
$T_J$ Operating virtual-junction temperature		150	°C
Case temperature for 60s		FK package	260 °C
Lead temperature 1.6mm (1/16in) from case for 60s		J package	300 °C
$T_{stg}$ Storage temperature	-65	150	°C

- (1) Stresses beyond those listed under *Absolute Maximum Ratings* can cause permanent damage to the device. These are stress ratings only, and functional operation of the device at these or any other conditions beyond those indicated under *Recommended Operating Conditions* is not implied. Exposure to absolute-maximum-rated conditions for extended periods can affect device reliability.
- (2) All voltage values, except differential voltages, are with respect to network ground.
- (3) Differential voltages are at xIN+ with respect to xIN-.
- (4) Short circuits from outputs to  $V_{CC}$  can cause excessive heating and eventual destruction.
- (5) Input current flows through parasitic diode to ground and can turn on parasitic transistors that can increase  $I_{CC}$  and can cause output to be incorrect. Normal operation resumes when the input is removed.

### 6.3 ESD Ratings

			VALUE	UNIT
V <sub>(ESD)</sub>	Electrostatic discharge	Human-body model (HBM), per ANSI/ESDA/JEDEC JS-001 <sup>(1)</sup>	±2000	V
		Human-body model (CDM), per ANSI/ESDA/JEDEC JS-002 <sup>(2)</sup>	±1000	

(1) JEDEC document JEP155 states that 500V HBM allows safe manufacturing with a standard ESD control process

(2) JEDEC document JEP157 states that 250V CDM allows safe manufacturing with a standard ESD control process

### 6.4 Recommended Operating Conditions for LM339B and LM2901B

over operating free-air temperature range (unless otherwise noted)

	MIN	MAX	UNIT
Supply voltage: V <sub>S</sub> = (V+) – (V–)	2	36	V
Ambient temperature, T <sub>A</sub> , LM339B	–40	85	°C
Ambient temperature, T <sub>A</sub> , LM2901B	–40	125	°C
Input Voltage Range, V <sub>IVR</sub>	(V–) – 0.1	(V+) – 2.0	V

### 6.5 Recommended Operating Conditions, Non-B Versions

over operating free-air temperature range (unless otherwise noted)

			MIN	MAX	UNIT
V <sub>CC</sub>	Supply voltage	Non-V devices	2	30	V
		V devices	2	32	V
T <sub>J</sub>	Junction temperature	LM139x	–55	125	°C
		LM239x	–25	85	
		LM339x	–0	70	
		LM2901x	–40	125	

### 6.6 Thermal Information

THERMAL METRIC <sup>(1)</sup>		All Devices						UNIT
		N (PDIP)	D (SOIC)	PW (TSSOP)	DB (SSOP)	NS (SOP)	RTE (QFN)	
		14 PINS	14 PINS	14 PINS	14 PINS	14 PINS	16 PINS	
R <sub>θJA</sub>	Junction-to-ambient thermal resistance	114.9	111.2	136.6	111.8	96.2	67.6	°C/W
R <sub>θJC(top)</sub>	Junction-to-case (top) thermal resistance	93.8	66.9	66.6	63.6	56.1	72.3	°C/W
R <sub>θJB</sub>	Junction-to-board thermal resistance	77.7	67.8	79.8	60.5	56.9	43.1	°C/W
ψ <sub>JT</sub>	Junction-to-top characterization parameter	60.4	28.0	17.8	26.2	24.8	6.3	°C/W
ψ <sub>JB</sub>	Junction-to-board characterization parameter	76.7	67.4	79.3	58.5	56.4	42.8	°C/W
R <sub>θJC(bot)</sub>	Junction-to-case (bottom) thermal resistance	-	-	-	-	-	26.4	°C/W

(1) For more information about traditional and new thermal metrics, see the Semiconductor and IC Package Thermal Metrics report, [SPRA953](#).

## 6.7 Electrical Characteristics for LM339B

$V_S = 5V$ ,  $V_{CM} = (V-)$ ;  $T_A = 25^\circ C$  (unless otherwise noted).

PARAMETER		TEST CONDITIONS	MIN	TYP	MAX	UNIT
$V_{IO}$	Input offset voltage	$V_S = 5$ to $36V$	-3.5	$\pm 0.37$	3.5	mV
		$V_S = 5$ to $36V$ , $T_A = -40^\circ C$ to $+85^\circ C$	-5.5		5.5	
$I_B$	Input bias current			-3.5	-25	nA
		$T_A = -40^\circ C$ to $+85^\circ C$			-50	nA
$I_{OS}$	Input offset current		-25	$\pm 0.5$	25	nA
		$T_A = -40^\circ C$ to $+85^\circ C$	-50		50	nA
$V_{CM}$	Common mode range <sup>(1)</sup>	$V_S = 3$ to $36V$	(V-)		(V+) - 1.5	V
		$V_S = 3$ to $36V$ , $T_A = -40^\circ C$ to $+85^\circ C$	(V-)		(V+) - 2.0	V
$A_{VD}$	Large signal differential voltage amplification	$V_S = 15V$ , $V_O = 1.4V$ to $11.4V$ ; $R_L \geq 15k$ to (V+)	50	200		V/mV
$V_{OL}$	Low level output Voltage {swing from (V-)}	$I_{SINK} \leq 4mA$ , $V_{ID} = -1V$		110	400	mV
		$I_{SINK} \leq 4mA$ , $V_{ID} = -1V$ $T_A = -40^\circ C$ to $+85^\circ C$			550	mV
$I_{OH-LKG}$	High-level output leakage current	(V+) = $V_O = 5V$ ; $V_{ID} = 1V$		0.1	50	nA
		(V+) = $V_O = 36V$ ; $V_{ID} = 1V$			100	nA
$I_{OL}$	Low level output current	$V_{OL} = 1.5V$ ; $V_{ID} = -1V$ ; $V_S = 5V$	6	21		mA
$I_Q$	Quiescent current (all comparators)	$V_S = 5V$ , no load		0.8	1.2	mA
		$V_S = 36V$ , no load, $T_A = -40^\circ C$ to $+85^\circ C$		1	1.6	mA

- (1) When the voltage at either input goes negative by more than 0.3V, the output can be incorrect and excessive input current can flow. The upper end of the common-mode voltage range is limited by  $V_{CC} - 2V$ . However only one input needs to be in the valid common mode range, the other input can go up the maximum  $V_{CC}$  level and the comparator provides a proper output state. Either or both inputs can go to maximum  $V_{CC}$  level without damage.

## 6.8 Electrical Characteristics for LM2901B

$V_S = 5V$ ,  $V_{CM} = (V-)$ ;  $T_A = 25^\circ C$  (unless otherwise noted).

PARAMETER		TEST CONDITIONS	MIN	TYP	MAX	UNIT
$V_{IO}$	Input offset voltage	$V_S = 5$ to $36V$	-3.5	$\pm 0.37$	3.5	mV
		$V_S = 5$ to $36V$ , $T_A = -40^\circ C$ to $+125^\circ C$	-5.5		5.5	
$I_B$	Input bias current			-3.5	-25	nA
		$T_A = -40^\circ C$ to $+125^\circ C$			-50	nA
$I_{OS}$	Input offset current		-25	$\pm 0.5$	25	nA
		$T_A = -40^\circ C$ to $+125^\circ C$	-50		50	nA
$V_{CM}$	Common mode range <sup>(1)</sup>	$V_S = 3$ to $36V$	(V-)		(V+) - 1.5	V
		$V_S = 3$ to $36V$ , $T_A = -40^\circ C$ to $+125^\circ C$	(V-)		(V+) - 2.0	V
$A_{VD}$	Large signal differential voltage amplification	$V_S = 15V$ , $V_O = 1.4V$ to $11.4V$ ; $R_L \geq 15k$ to (V+)	50	200		V/mV
$V_{OL}$	Low level output Voltage {swing from (V-)}	$I_{SINK} \leq 4mA$ , $V_{ID} = -1V$		110	400	mV
		$I_{SINK} \leq 4mA$ , $V_{ID} = -1V$ $T_A = -40^\circ C$ to $+125^\circ C$			550	mV
$I_{OH-LKG}$	High-level output leakage current	(V+) = $V_O = 5V$ ; $V_{ID} = 1V$		0.1	50	nA
		(V+) = $V_O = 36V$ ; $V_{ID} = 1V$			100	nA
$I_{OL}$	Low level output current	$V_{OL} = 1.5V$ ; $V_{ID} = -1V$ ; $V_S = 5V$	6	21		mA
$I_Q$	Quiescent current (all comparators)	$V_S = 5V$ , no load		0.8	1.2	mA
		$V_S = 36V$ , no load, $T_A = -40^\circ C$ to $+125^\circ C$		1	1.6	mA

- (1) When the voltage at either input goes negative by more than 0.3V, the output can be incorrect and excessive input current can flow. The upper end of the common-mode voltage range is limited by  $V_{CC} - 2V$ . However only one input needs to be in the valid common mode range, the other input can go up the maximum  $V_{CC}$  level and the comparator provides a proper output state. Either or both inputs can go to maximum  $V_{CC}$  level without damage.



## 6.9 Electrical Characteristics for LM139 and LM139A

at specified free-air temperature,  $V_{CC} = 5V$  (unless otherwise noted)

PARAMETER	TEST CONDITIONS <sup>(1)</sup>	$T_A$ <sup>(2)</sup>	LM139			LM139A			UNIT
			MIN	TYP	MAX	MIN	TYP	MAX	
$V_{IO}$ Input offset voltage	$V_{CC} = 5V$ to $30V$ , $V_{IC} = V_{ICR}$ min, $V_O = 1.4V$	25°C		2	5		1	2	mV
		Full range			9			4	
$I_{IO}$ Input offset current	$V_O = 1.4V$	25°C		3	25		3	25	nA
		Full range			100			100	
$I_{IB}$ Input bias current	$V_O = 1.4V$	25°C		-25	-100		-25	-100	nA
		Full range			-300			-300	
$V_{ICR}$ Common-mode input-voltage range <sup>(3)</sup>		25°C		0 to $V_{CC} - 1.5$			0 to $V_{CC} - 1.5$		V
		Full range		0 to $V_{CC} - 2$			0 to $V_{CC} - 2$		
$A_{VD}$ Large-signal differential-voltage amplification	$V_{CC+} = \pm 7.5V$ , $V_O = -5V$ to $5V$	25°C		200		50	200	V/mV	
$I_{OH}$ High-level output current	$V_{ID} = 1V$	$V_{OH} = 5V$	25°C		0.1		0.1	nA	
		$V_{OH} = 30V$	Full range		1		1	$\mu A$	
$V_{OL}$ Low-level output voltage	$V_{ID} = -1V$ , $I_{OL} = 4mA$	25°C		150	400		150	400	mV
		Full range			700			700	
$I_{OL}$ Low-level output current	$V_{ID} = -1V$ , $V_{OL} = 1.5V$	25°C		6	16		6	16	mA
$I_{CC}$ Supply current (four comparators)	$V_O = 2.5V$ , No load	25°C		0.8	2		0.8	2	mA

- (1) All characteristics are measured with zero common-mode input voltage, unless otherwise specified.
- (2) Full range (MIN to MAX) for LM139 and LM139A is  $-55^{\circ}C$  to  $+125^{\circ}C$ . All characteristics are measured with zero common-mode input voltage, unless otherwise specified.
- (3) The voltage at either input or common-mode must not be allowed to go negative by more than 0.3V. The upper end of the common-mode voltage range is  $V_{CC+} - 1.5V$ ; however, one input can exceed  $V_{CC}$ , and the comparator provides a proper output state as long as the other input remains in the common-mode range. Either or both inputs can go to 30V without damage.

## 6.10 Electrical Characteristics for LMx39 and LMx39A

at specified free-air temperature,  $V_{CC} = 5V$  (unless otherwise noted)

PARAMETER	TEST CONDITIONS <sup>(1)</sup>	$T_A$ <sup>(2)</sup>	LM239 LM339			LM239A LM339A			UNIT	
			MIN	TYP	MAX	MIN	TYP	MAX		
$V_{IO}$ Input offset voltage	$V_{CC} = 5V$ to $30V$ , $V_{IC} = V_{ICR}$ min, $V_O = 1.4V$	25°C		2	5		1	3	mV	
		Full range			9			4		
$I_{IO}$ Input offset current	$V_O = 1.4V$	25°C		5	50		5	50	nA	
		Full range			150			150		
$I_{IB}$ Input bias current	$V_O = 1.4V$	25°C		-25	-250		-25	-250	nA	
		Full range			-400			-400		
$V_{ICR}$ Common-mode input-voltage range <sup>(3)</sup>		25°C		0 to $V_{CC} - 1.5$			0 to $V_{CC} - 1.5$		V	
		Full range		0 to $V_{CC} - 2$			0 to $V_{CC} - 2$			
$A_{VD}$ Large-signal differential-voltage amplification	$V_{CC} = 15V$ , $V_O = 1.4V$ to $11.4V$ , $R_L \geq 15k\Omega$ to $V_{CC}$	25°C		50	200		50	200	V/mV	
$I_{OH}$ High-level output current	$V_{ID} = 1V$	$V_{OH} = 5V$	25°C		0.1	50		0.1	50	nA
		$V_{OH} = 30V$	Full range			1			1	$\mu A$
$V_{OL}$ Low-level output voltage	$V_{ID} = -1V$ , $I_{OL} = 4mA$	25°C		150	400		150	400	mV	
		Full range			700			700		
$I_{OL}$ Low-level output current	$V_{ID} = -1V$ , $V_{OL} = 1.5V$	25°C		6	16		6	16	mA	
$I_{CC}$ Supply current (four comparators)	$V_O = 2.5V$ , No load	25°C		0.8	2		0.8	2	mA	

- (1) All characteristics are measured with zero common-mode input voltage, unless otherwise specified.
- (2) Full range (MIN to MAX) for LM239/LM239A is  $-25^\circ C$  to  $+85^\circ C$ , and for LM339/LM339A is  $0^\circ C$  to  $70^\circ C$ . All characteristics are measured with zero common-mode input voltage, unless otherwise specified.
- (3) The voltage at either input or common-mode must not be allowed to go negative by more than 0.3V. The upper end of the common-mode voltage range is  $V_{CC+} - 1.5V$ ; however, one input can exceed  $V_{CC}$ , and the comparator provides a proper output state as long as the other input remains in the common-mode range. Either or both inputs can go to 30V without damage.

## 6.11 Electrical Characteristics for LM2901, LM2901V and LM2901AV

at specified free-air temperature,  $V_{CC} = 5V$  (unless otherwise noted)

PARAMETER	TEST CONDITIONS <sup>(1)</sup>		$T_A$ <sup>(2)</sup>	LM2901			UNIT
				MIN	TYP	MAX	
$V_{IO}$ Input offset voltage	$V_{IC} = V_{ICR} \text{ min,}$ $V_O = 1.4V,$ $V_{CC} = 5V \text{ to MAX}^{(3)}$	Non-A devices	25°C		2	7	mV
			Full range			15	
		A-suffix devices	25°C		1	2	
			Full range			4	
$I_{IO}$ Input offset current	$V_O = 1.4V$		25°C		5	50	nA
			Full range			200	
$I_{IB}$ Input bias current	$V_O = 1.4V$		25°C		-25	-250	nA
			Full range			-500	
$V_{ICR}$ Common-mode input-voltage range <sup>(4)</sup>			25°C	0 to $V_{CC} - 1.5$		V	
			Full range	0 to $V_{CC} - 2$			
$A_{VD}$ Large-signal differential-voltage amplification	$V_{CC} = 15V, V_O = 1.4V \text{ to } 11.4V,$ $R_L \geq 15k\Omega \text{ to } V_{CC}$		25°C	25	100	V/mV	
$I_{OH}$ High-level output current	$V_{ID} = 1V$		$V_{OH} = 5V$	25°C	0.1	50	nA
			$V_{OH} = V_{CC} \text{ MAX}^{(3)}$	Full range			1
$V_{OL}$ Low-level output voltage	$V_{ID} = -1V,$ $I_{OL} = 4mA$	Non-V devices	25°C		150	500	mV
		V-suffix devices			150	400	
		All devices	Full range			700	
$I_{OL}$ Low-level output current	$V_{ID} = -1V,$	$V_{OL} = 1.5V$	25°C	6	16	mA	
$I_{CC}$ Supply current (four comparators)	$V_O = 2.5V,$ No load		25°C	$V_{CC} = 5V$	0.8	2	mA
				$V_{CC} = \text{MAX}^{(3)}$	1	2.5	

- (1) All characteristics are measured with zero common-mode input voltage, unless otherwise specified.
- (2) Full range (MIN to MAX) for LM2901 is  $-40^\circ C$  to  $+125^\circ C$ . All characteristics are measured with zero common-mode input voltage, unless otherwise specified.
- (3)  $V_{CC} \text{ MAX} = 30V$  for non-V devices, and  $32V$  for V-suffix devices
- (4) The voltage at either input or common-mode must not be allowed to go negative by more than  $0.3V$ . The upper end of the common-mode voltage range is  $V_{CC+} - 1.5V$ ; however, one input can exceed  $V_{CC}$ , and the comparator provides a proper output state as long as the other input remains in the common-mode range. Either or both inputs can go to  $V_{CC} \text{ MAX}$  without damage.

## 6.12 Switching Characteristics for LM139 and LM139A

$$V_{CC} = 5V, T_A = 25^\circ C$$

PARAMETER	TEST CONDITIONS		LM139 LM139A	UNIT
			TYP	
Response time	R <sub>L</sub> connected to 5V through 5.1kΩ, C <sub>L</sub> = 15pF <sup>(1) (2)</sup>	100mV input step with 5mV overdrive	1.3	μs
		TTL-level input step	0.3	

(1) C<sub>L</sub> includes probe and jig capacitance.

(2) The response time specified is the interval between the input step function and the instant when the output crosses 1.4V.

## 6.13 Switching Characteristics for LM339B and LM2901B

$$V_S = 5V, V_{O\_PULLUP} = 5V, V_{CM} = V_S/2, C_L = 15pF, R_L = 5.1k\Omega, T_A = 25^\circ C \text{ (unless otherwise noted).}$$

PARAMETER	TEST CONDITIONS	MIN	TYP	MAX	UNIT
t <sub>response</sub>	Propagation delay time, high-to-low; Small scale input signal <sup>(1)</sup>		1000		ns
t <sub>response</sub>	Propagation delay time, high-to-low; TTL input signal <sup>(1)</sup>		300		ns

(1) High-to-low and low-to-high refers to the transition at the input.

## 6.14 Switching Characteristics for LMx39 and LMx39A

$$V_{CC} = 5V, T_A = 25^\circ C$$

PARAMETER	TEST CONDITIONS		LM239 LM239A LM339 LM339A	UNIT
			TYP	
Response time	R <sub>L</sub> connected to 5V through 5.1kΩ, C <sub>L</sub> = 15pF <sup>(1) (2)</sup>	100mV input step with 5mV overdrive	1.3	μs
		TTL-level input step	0.3	

(1) C<sub>L</sub> includes probe and jig capacitance.

(2) The response time specified is the interval between the input step function and the instant when the output crosses 1.4V.

## 6.15 Switching Characteristics for LM2901

$$V_{CC} = 5V, T_A = 25^\circ C$$

PARAMETER	TEST CONDITIONS		LM2901	UNIT
			TYP	
Response time	R <sub>L</sub> connected to 5V through 5.1kΩ, C <sub>L</sub> = 15pF <sup>(1) (2)</sup>	100mV input step with 5mV overdrive	1.3	μs
		TTL-level input step	0.3	

(1) C<sub>L</sub> includes probe and jig capacitance.

(2) The response time specified is the interval between the input step function and the instant when the output crosses 1.4V.

### 6.16 Typical Characteristics

$T_A = 25^\circ\text{C}$ ,  $V_S = 5\text{V}$ ,  $R_{\text{PULLUP}} = 5.1\text{k}$ ,  $C_L = 15\text{pF}$ ,  $V_{\text{CM}} = 0\text{V}$ ,  $V_{\text{UNDERDRIVE}} = 100\text{mV}$ ,  $V_{\text{OVERDRIVE}} = 100\text{mV}$  unless otherwise noted.

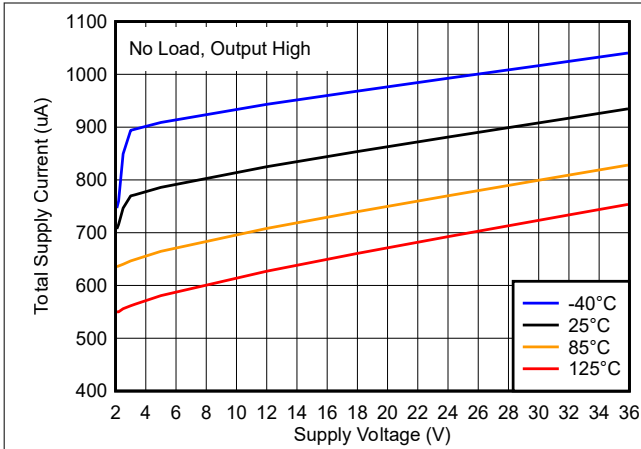

Figure 6-1. Total Supply Current vs. Supply Voltage

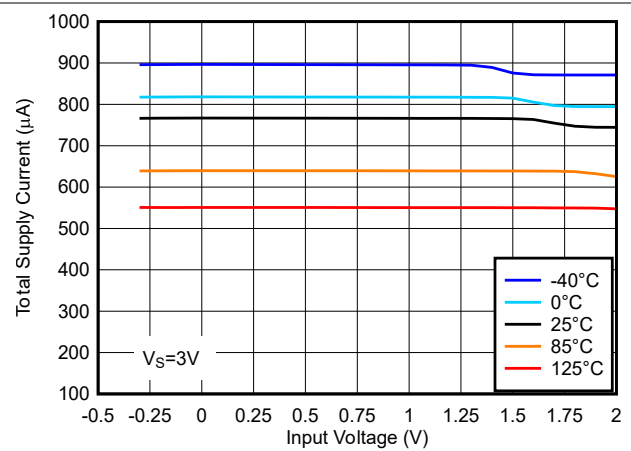

Figure 6-2. Total Supply Current vs. Input Voltage at 3V

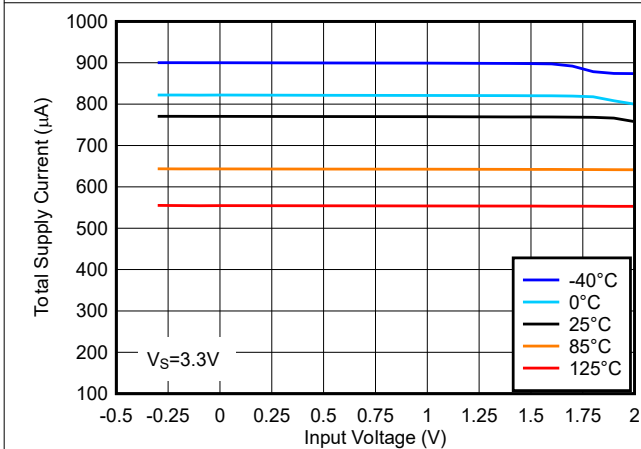

Figure 6-3. Total Supply Current vs. Input Voltage at 3.3V

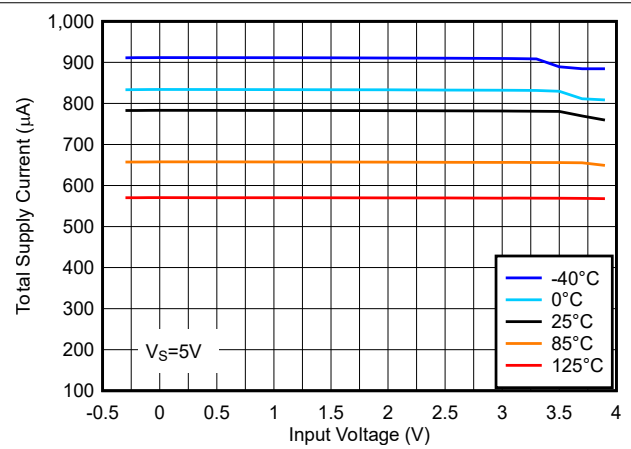

Figure 6-4. Total Supply Current vs. Input Voltage at 5V

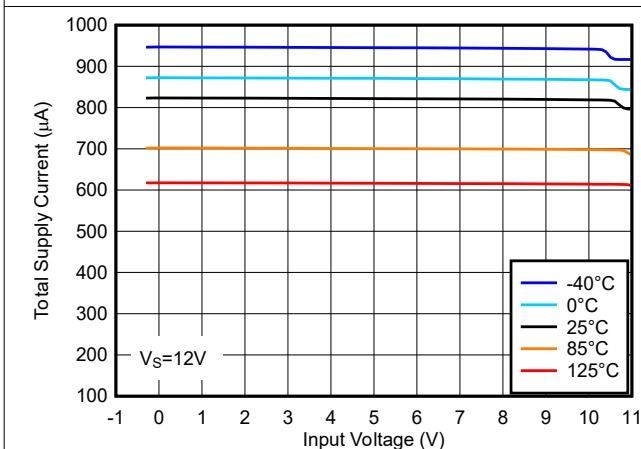

Figure 6-5. Total Supply Current vs. Input Voltage at 12V

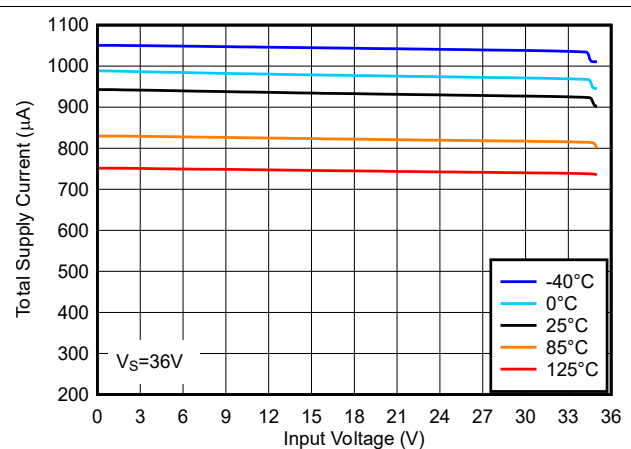

Figure 6-6. Total Supply Current vs. Input Voltage at 36V

## 6.16 Typical Characteristics (continued)

$T_A = 25^\circ\text{C}$ ,  $V_S = 5\text{V}$ ,  $R_{\text{PULLUP}} = 5.1\text{k}$ ,  $C_L = 15\text{pF}$ ,  $V_{\text{CM}} = 0\text{V}$ ,  $V_{\text{UNDERDRIVE}} = 100\text{mV}$ ,  $V_{\text{OVERDRIVE}} = 100\text{mV}$  unless otherwise noted.

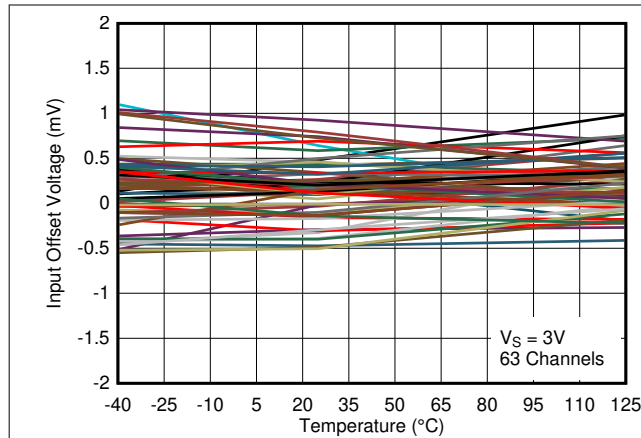

Figure 6-7. Input Offset Voltage vs. Temperature at 3V

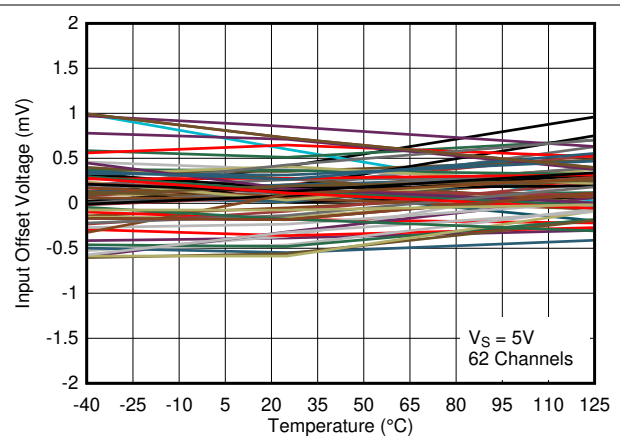

Figure 6-8. Input Offset Voltage vs. Temperature at 5V

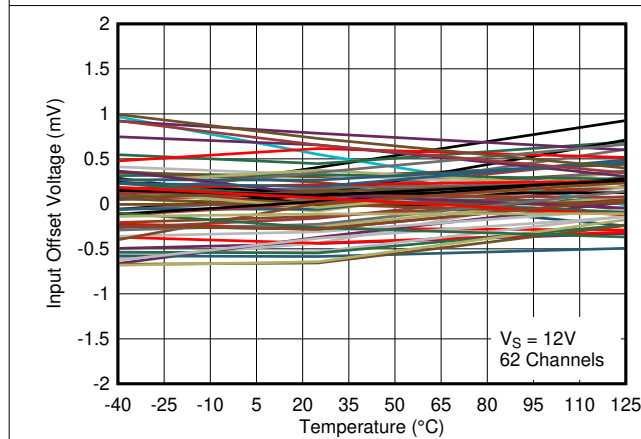

Figure 6-9. Input Offset Voltage vs. Temperature at 12V

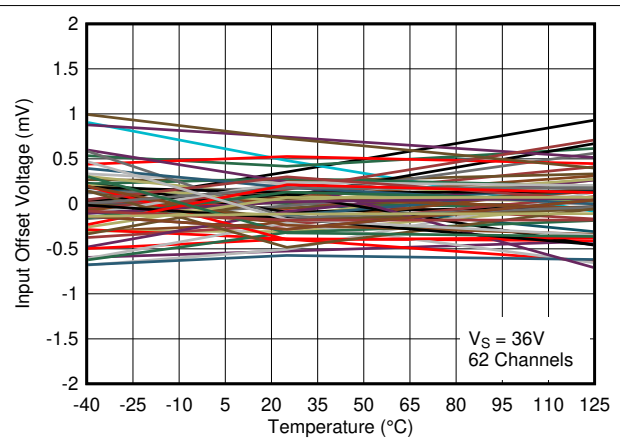

Figure 6-10. Input Offset Voltage vs. Temperature at 36V

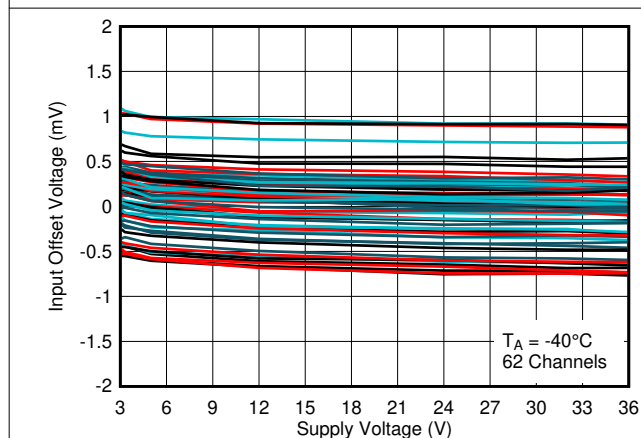

Figure 6-11. Input Offset Voltage vs. Supply Voltage at  $-40^\circ\text{C}$

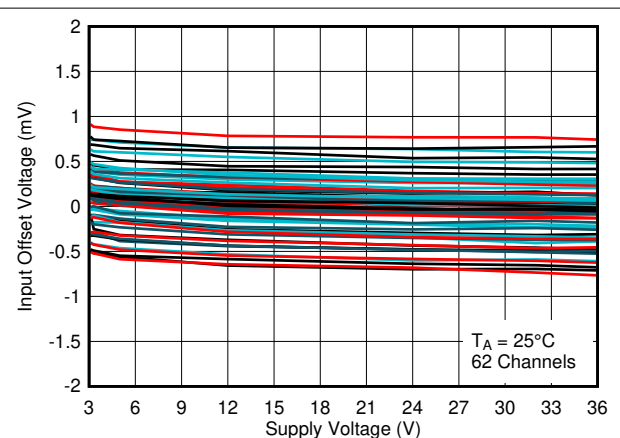

Figure 6-12. Input Offset Voltage vs. Supply Voltage at  $25^\circ\text{C}$

### 6.16 Typical Characteristics (continued)

$T_A = 25^\circ\text{C}$ ,  $V_S = 5\text{V}$ ,  $R_{\text{PULLUP}} = 5.1\text{k}$ ,  $C_L = 15\text{pF}$ ,  $V_{\text{CM}} = 0\text{V}$ ,  $V_{\text{UNDERDRIVE}} = 100\text{mV}$ ,  $V_{\text{OVERDRIVE}} = 100\text{mV}$  unless otherwise noted.

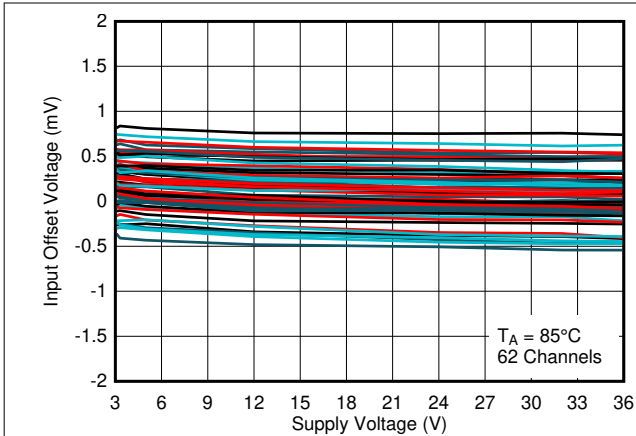

Figure 6-13. Input Offset Voltage vs. Supply Voltage at 85°C

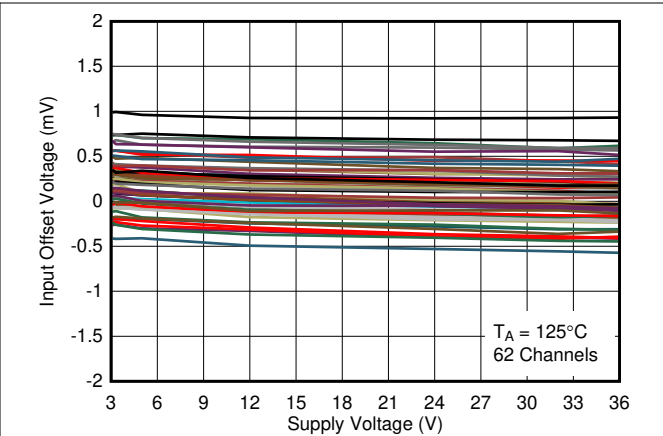

Figure 6-14. Input Offset Voltage vs. Supply Voltage at 125°C

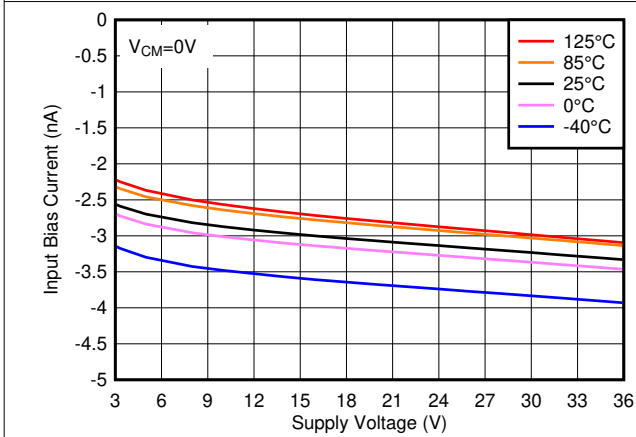

Figure 6-15. Input Bias Current vs. Supply Voltage

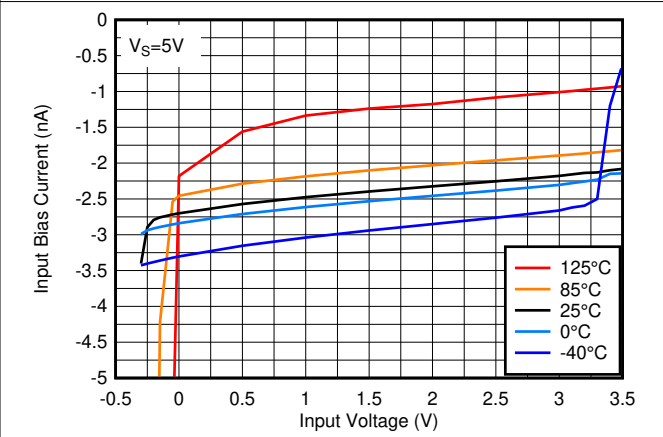

Figure 6-16. Input Bias Current vs. Input Voltage at 5V

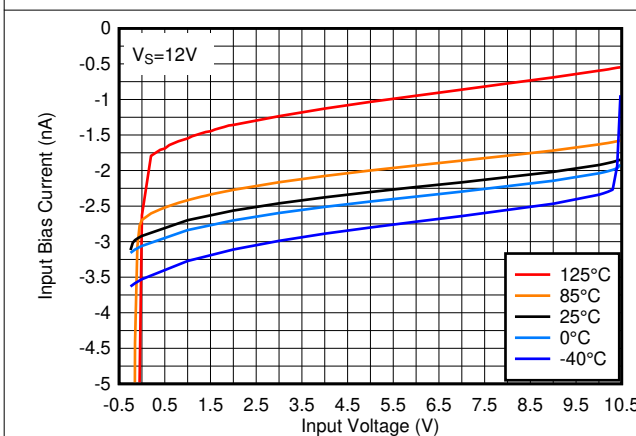

Figure 6-17. Input Bias Current vs. Input Voltage at 12V

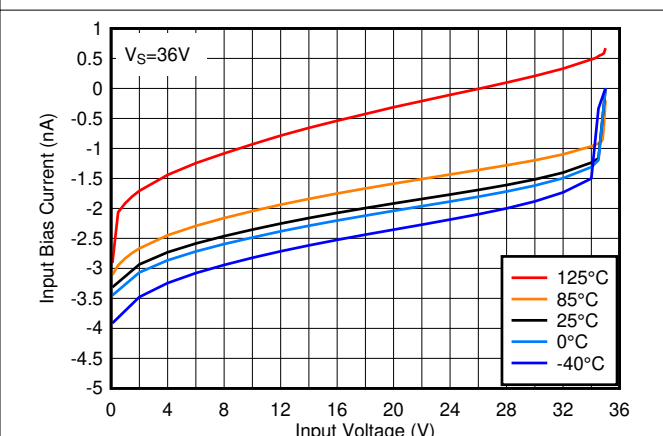
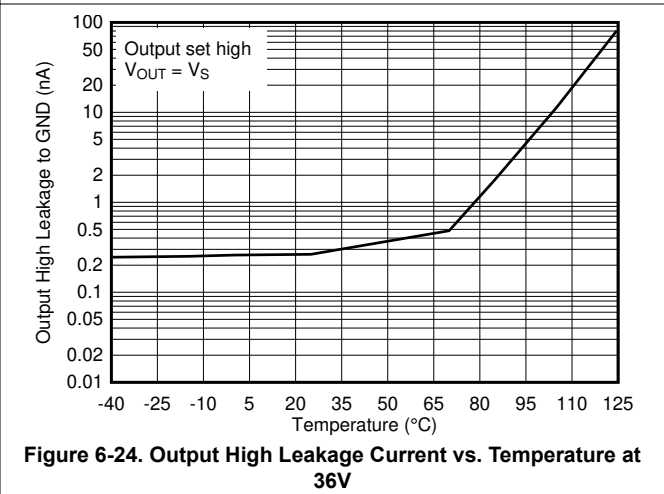
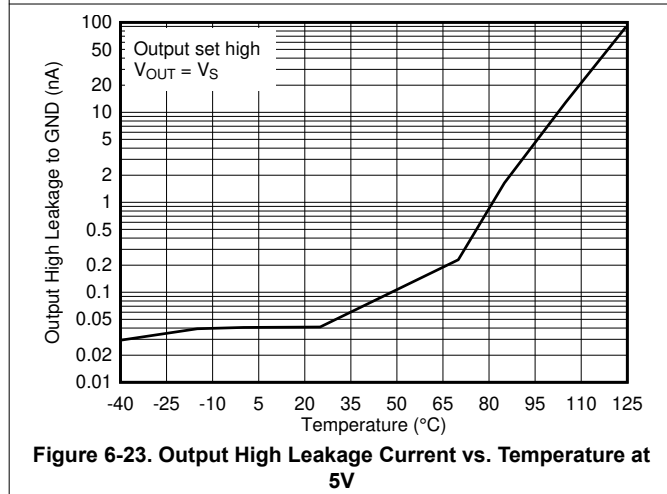
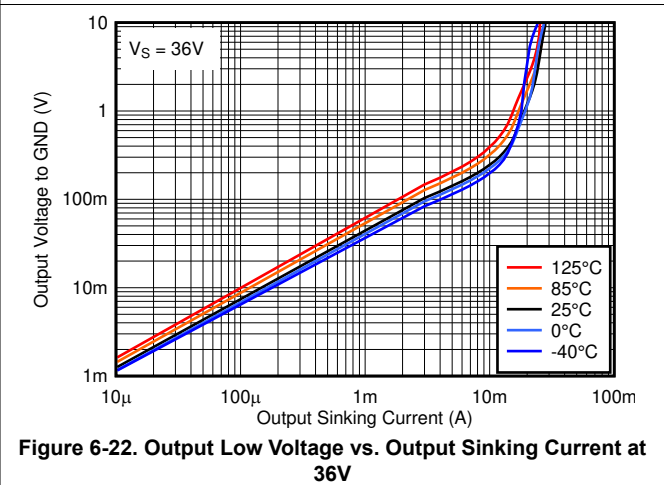
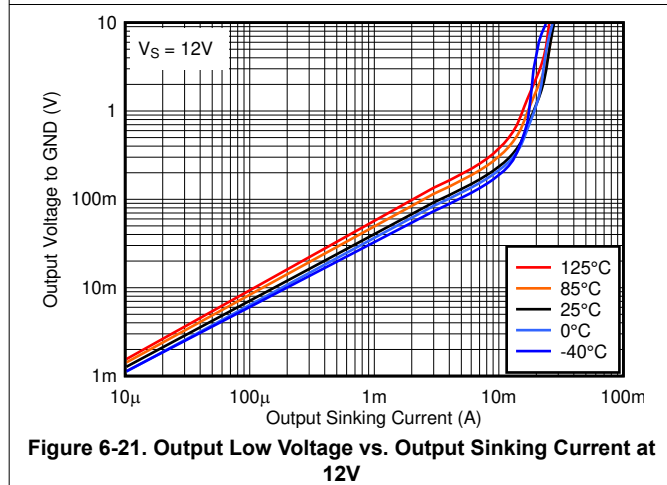
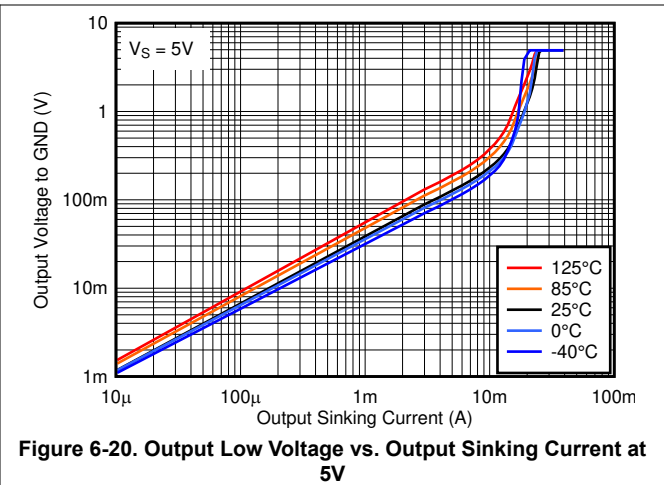
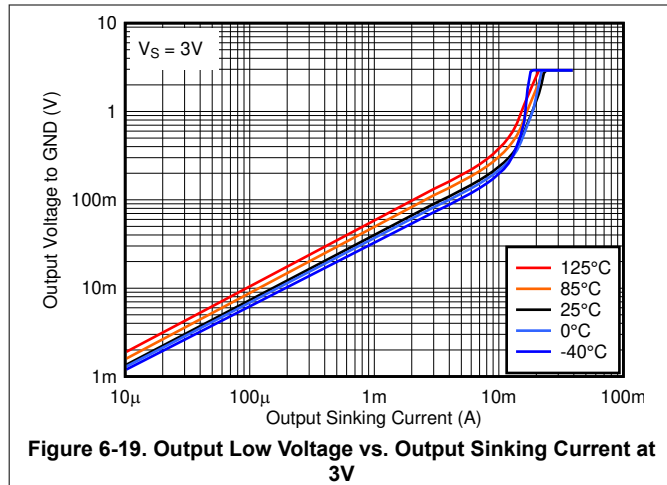

Figure 6-18. Input Bias Current vs. Input Voltage at 36V

## 6.16 Typical Characteristics (continued)

$T_A = 25^\circ\text{C}$ ,  $V_S = 5\text{V}$ ,  $R_{\text{PULLUP}} = 5.1\text{k}$ ,  $C_L = 15\text{pF}$ ,  $V_{\text{CM}} = 0\text{V}$ ,  $V_{\text{UNDERDRIVE}} = 100\text{mV}$ ,  $V_{\text{OVERDRIVE}} = 100\text{mV}$  unless otherwise noted.





### 6.16 Typical Characteristics (continued)

$T_A = 25^\circ\text{C}$ ,  $V_S = 5\text{V}$ ,  $R_{\text{PULLUP}} = 5.1\text{k}$ ,  $C_L = 15\text{pF}$ ,  $V_{\text{CM}} = 0\text{V}$ ,  $V_{\text{UNDERDRIVE}} = 100\text{mV}$ ,  $V_{\text{OVERDRIVE}} = 100\text{mV}$  unless otherwise noted.

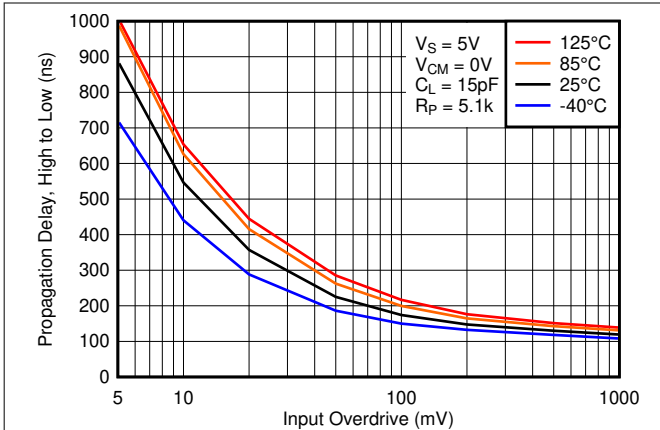

**Figure 6-25. High to Low Propagation Delay vs. Input Overdrive Voltage, 5V**

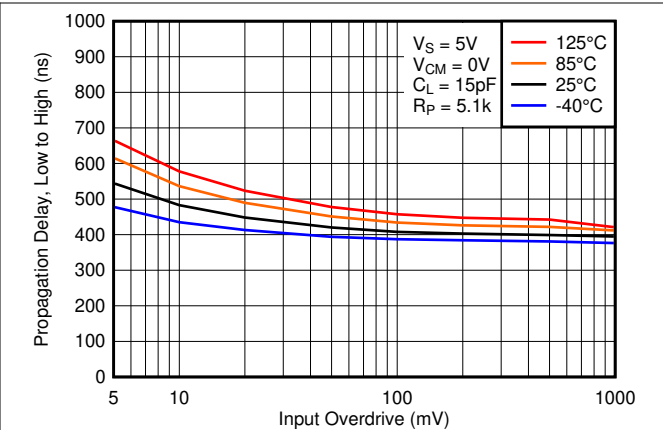

**Figure 6-26. Low to High Propagation Delay vs. Input Overdrive Voltage, 5V**

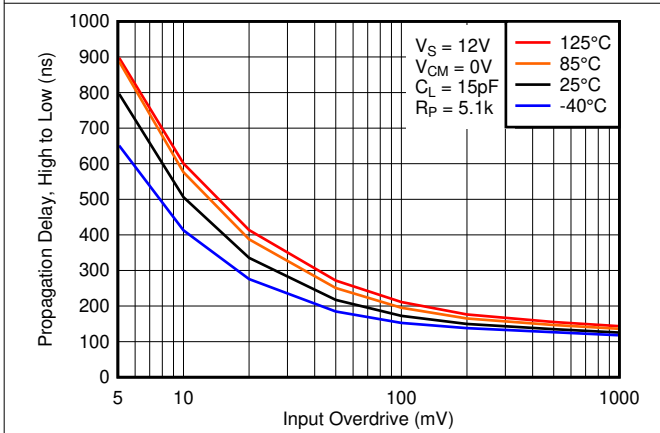

**Figure 6-27. High to Low Propagation Delay vs. Input Overdrive Voltage, 12V**

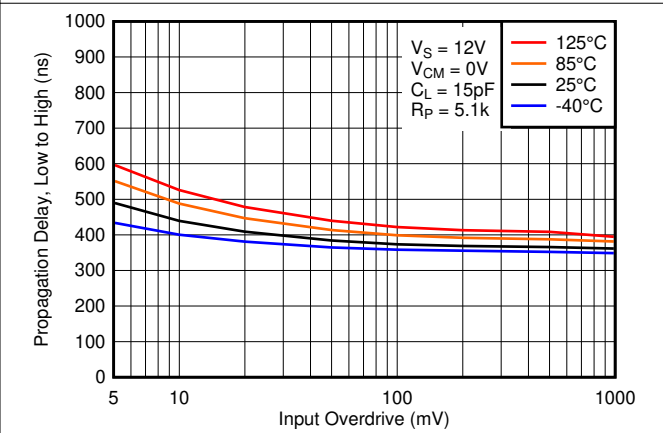

**Figure 6-28. Low to High Propagation Delay vs. Input Overdrive Voltage, 12V**

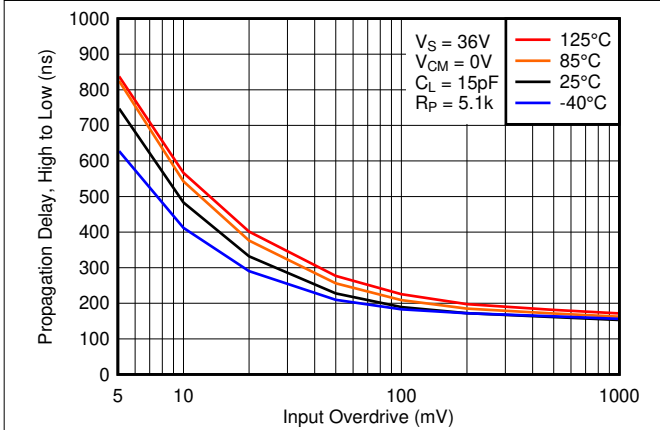

**Figure 6-29. High to Low Propagation Delay vs. Input Overdrive Voltage, 36V**

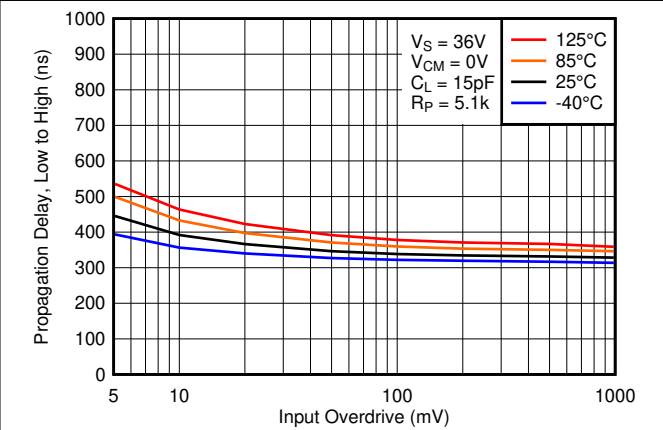

**Figure 6-30. Low to High Propagation Delay vs. Input Overdrive Voltage, 36V**

## 6.16 Typical Characteristics (continued)

$T_A = 25^\circ\text{C}$ ,  $V_S = 5\text{V}$ ,  $R_{\text{PULLUP}} = 5.1\text{k}$ ,  $C_L = 15\text{pF}$ ,  $V_{\text{CM}} = 0\text{V}$ ,  $V_{\text{UNDERDRIVE}} = 100\text{mV}$ ,  $V_{\text{OVERDRIVE}} = 100\text{mV}$  unless otherwise noted.

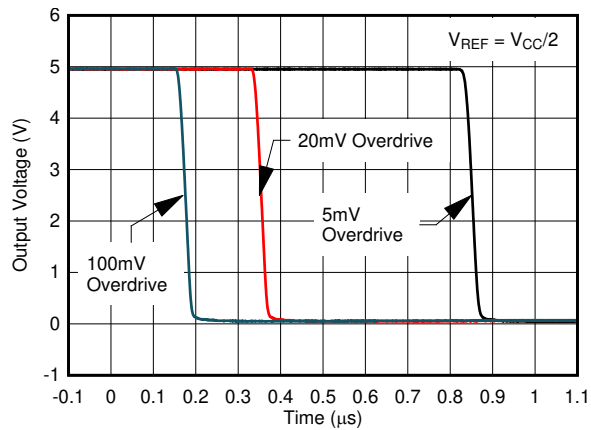

**Figure 6-31. Response Time for Various Overdrives, High-to-Low Transition**

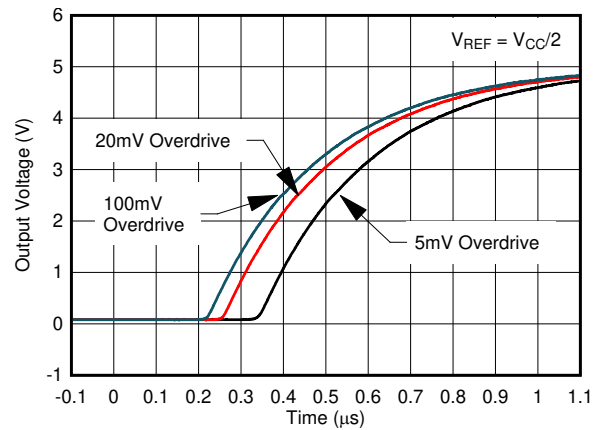

**Figure 6-32. Response Time for Various Overdrives, Low-to-High Transition**

## 7 Detailed Description

### 7.1 Overview

These dual comparators have the ability to operate up to absolute maximum of 36V (38V for the "B" version) on the supply pin. This device has proven ubiquity and versatility across a wide range of applications. This is due to very wide supply voltages range, low  $I_q$  and fast response of the devices.

The open-collector outputs allow the user to level shift to the desired logic level independent of  $V_{CC}$ , while also enabling AND functionality when multiple outputs are connected together.

### 7.2 Functional Block Diagram

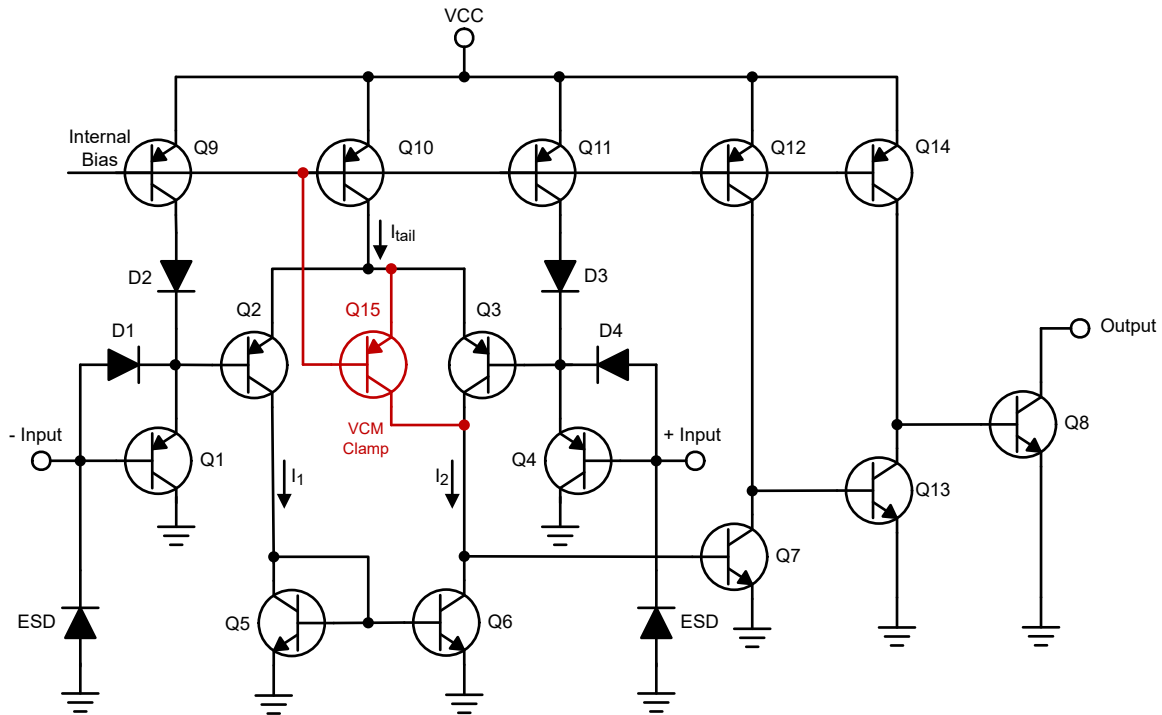

**Figure 7-1. Schematic (Each Comparator)**

### 7.3 Feature Description

The comparator consists of a PNP Darlington pair input, allowing the device to operate with very high gain and fast response with minimal input bias current. The input Darlington pair creates a limit on the input common mode voltage capability, allowing the comparator to accurately function from ground to  $V_{CC} - 2V$  over temperature. A clamp is added around Q3 to mimic the both inputs above input voltage range behavior of the original classic silicon.

The output consists of an open drain NPN (pull-down or low side) transistor. The output NPN sinks current when the negative input voltage is higher than the positive input voltage and the offset voltage. The  $V_{OL}$  is resistive and scales with the output current. Please see the "Output Low Voltage vs. Output Sinking Current" graphs for  $V_{OL}$  values with respect to the output current.

### 7.4 Device Functional Modes

#### 7.4.1 Voltage Comparison

The comparator operates solely as a voltage comparator, comparing the differential voltage between the positive and negative pins and outputting a logic low or high impedance (logic high with pullup) based on the input differential polarity.

## 8 Application and Implementation

### Note

Information in the following applications sections is not part of the TI component specification, and TI does not warrant its accuracy or completeness. TI's customers are responsible for determining suitability of components for their purposes, as well as validating and testing their design implementation to confirm system functionality.

### 8.1 Application Information

Typically, a comparator compares either a single signal to a reference, or to two different signals. Many users take advantage of the open-drain output to drive the comparison logic output to a logic voltage level to an MCU or logic device. The wide supply range and high voltage capability makes LMx39 or LM2901x an excellent choice for level shifting to a higher or lower voltage.

### 8.2 Typical Application

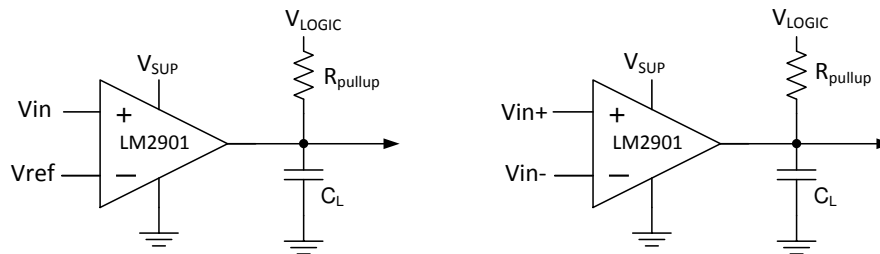

Figure 8-1. Single-ended and Differential Comparator Configurations

#### 8.2.1 Design Requirements

For this design example, use the parameters listed in [Table 8-1](#) as the input parameters.

Table 8-1. Design Parameters

DESIGN PARAMETER	EXAMPLE VALUE
Input Voltage Range	0V to $V_{sup}-2V$
Supply Voltage	4.5V to $V_{CC}$ maximum
Logic Supply Voltage	0V to $V_{CC}$ maximum
Output Current ( $R_{PULLUP}$ )	1 $\mu$ A to 4mA
Input Overdrive Voltage	100mV
Reference Voltage	2.5V
Load Capacitance ( $C_L$ )	15pF

#### 8.2.2 Detailed Design Procedure

When using the LMx39 in a general comparator application, determine the following:

- Input voltage range
- Minimum overdrive voltage
- Output and drive current
- Response time

##### 8.2.2.1 Input Voltage Range

When choosing the input voltage range, the input common mode voltage range ( $V_{ICR}$ ) must be taken in to account. If temperature operation is below 25°C the  $V_{ICR}$  can range from 0V to  $V_{CC}-2.0V$ . This limits the input voltage range to as high as  $V_{CC}-2.0V$  and as low as 0V. Operation outside of this range can yield incorrect comparisons.

The following is a list of input voltage situation and the outcomes:

1. When both IN- and IN+ are both within the common-mode range:
  - a. If IN- is higher than IN+ and the offset voltage, the output is low and the output transistor is sinking current
  - b. If IN- is lower than IN+ and the offset voltage, the output is high impedance and the output transistor is not conducting
2. When IN- is higher than common-mode and IN+ is within common-mode, the output is low and the output transistor is sinking current
3. When IN+ is higher than common-mode and IN- is within common-mode, the output is high impedance and the output transistor is not conducting
4. When IN- and IN+ are both higher than common-mode, see Section 2 of [Application Design Guidelines for LM339, LM393, TL331 Family Comparators Including the New B-versions](#).

#### 8.2.2.2 Minimum Overdrive Voltage

Overdrive voltage is the differential voltage produced between the positive and negative inputs of the comparator over the offset voltage ( $V_{IO}$ ). To make an accurate comparison, the overdrive voltage ( $V_{OD}$ ) must be higher than the input offset voltage ( $V_{IO}$ ). Overdrive voltage can also determine the response time of the comparator, with the response time decreasing with increasing overdrive. [Figure 8-2](#) and [Figure 8-3](#) show positive and negative response times with respect to overdrive voltage.

#### 8.2.2.3 Output and Drive Current

Output current is determined by the load and pullup resistance and logic and pullup voltage. The output current produces a low-level output voltage ( $V_{OL}$ ) from the comparator, where  $V_{OL}$  is proportional to the output current.

The output current can also effect the transient response.

#### 8.2.2.4 Response Time

Response time is a function of input over-drive. See the [Typical Characteristics](#) graphs for typical response times. The rise and fall times can be determined by the load capacitance ( $C_L$ ), load/pull-up resistance ( $R_{PULLUP}$ ) and equivalent collector-emitter resistance ( $R_{CE}$ ).

- The rise time ( $\tau_R$ ) is approximately  $\tau_R = R_{PULLUP} \times C_L$
- The fall time ( $\tau_F$ ) is approximately  $\tau_F = R_{CE} \times C_L$ 
  - $R_{CE}$  can be determined by taking the slope of [Figure 6-31](#) in the linear region at the desired temperature, or by dividing the  $V_{OL}$  by  $I_{OUT}$

### 8.2.3 Application Curves

Figure 8-2 and Figure 8-3 were generated with scope probe parasitic capacitance of 50pF.

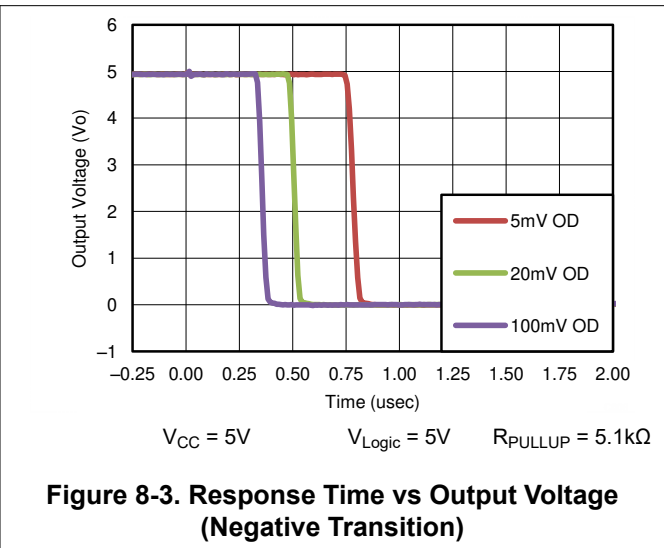
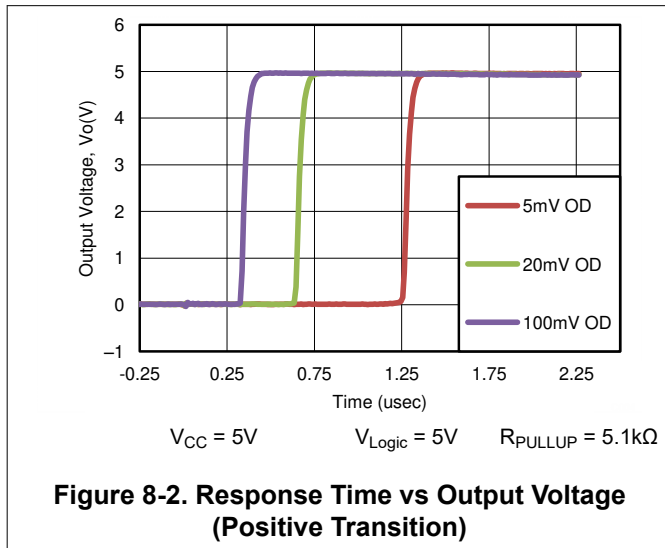

### 8.3 Power Supply Recommendations

For fast response and comparison applications with noisy or AC inputs, use a bypass capacitor on the supply pin to reject any variation on the supply voltage. This variation can affect the common-mode range of the comparator input and create an inaccurate comparison.

### 8.4 Layout

#### 8.4.1 Layout Guidelines

For accurate comparator applications without hysteresis maintaining a stable power supply with minimized noise and glitches is critical. Best practice is to add a bypass capacitor between the supply voltage and ground. This can be implemented on the positive power supply and negative supply (if available). If a negative supply is not being used, do not put a capacitor between the GND pin and system ground.

Minimize coupling between outputs and inverting inputs to prevent output oscillations. Do not run output and inverting input traces in parallel unless there is a  $V_{CC}$  or GND trace between output and inverting input traces to reduce coupling. When series resistance is added to inputs, place resistor close to the device.

#### 8.4.2 Layout Example

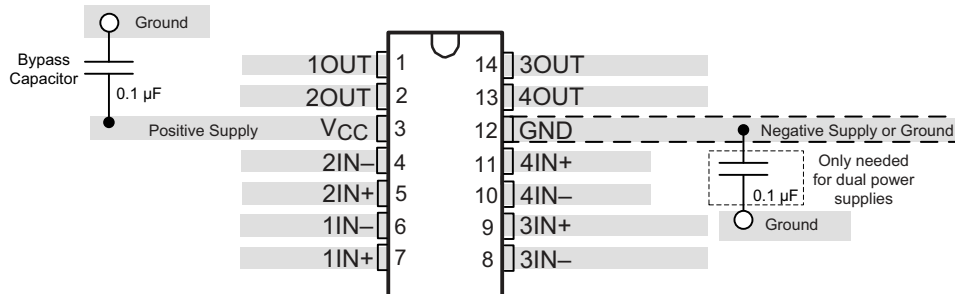

**Figure 8-4. LMx39 Layout Example**

## 9 Device and Documentation Support

### 9.1 Related Links

The table below lists quick access links. Categories include technical documents, support and community resources, tools and software, and quick access to sample or buy.

**Table 9-1. Related Links**

PARTS	PRODUCT FOLDER	SAMPLE & BUY	TECHNICAL DOCUMENTS	TOOLS & SOFTWARE	SUPPORT & COMMUNITY
LM139	<a href="#">Click here</a>	<a href="#">Click here</a>	<a href="#">Click here</a>	<a href="#">Click here</a>	<a href="#">Click here</a>
LM239	<a href="#">Click here</a>	<a href="#">Click here</a>	<a href="#">Click here</a>	<a href="#">Click here</a>	<a href="#">Click here</a>
LM339	<a href="#">Click here</a>	<a href="#">Click here</a>	<a href="#">Click here</a>	<a href="#">Click here</a>	<a href="#">Click here</a>
LM339B	<a href="#">Click here</a>	<a href="#">Click here</a>	<a href="#">Click here</a>	<a href="#">Click here</a>	<a href="#">Click here</a>
LM139A	<a href="#">Click here</a>	<a href="#">Click here</a>	<a href="#">Click here</a>	<a href="#">Click here</a>	<a href="#">Click here</a>
LM239A	<a href="#">Click here</a>	<a href="#">Click here</a>	<a href="#">Click here</a>	<a href="#">Click here</a>	<a href="#">Click here</a>
LM339A	<a href="#">Click here</a>	<a href="#">Click here</a>	<a href="#">Click here</a>	<a href="#">Click here</a>	<a href="#">Click here</a>
LM2901	<a href="#">Click here</a>	<a href="#">Click here</a>	<a href="#">Click here</a>	<a href="#">Click here</a>	<a href="#">Click here</a>
LM2901B	<a href="#">Click here</a>	<a href="#">Click here</a>	<a href="#">Click here</a>	<a href="#">Click here</a>	<a href="#">Click here</a>
LM2901AV	<a href="#">Click here</a>	<a href="#">Click here</a>	<a href="#">Click here</a>	<a href="#">Click here</a>	<a href="#">Click here</a>
LM2901V	<a href="#">Click here</a>	<a href="#">Click here</a>	<a href="#">Click here</a>	<a href="#">Click here</a>	<a href="#">Click here</a>

### 9.2 Receiving Notification of Documentation Updates

To receive notification of documentation updates, navigate to the device product folder on ti.com. In the upper right corner, click on *Alert me* to register and receive a weekly digest of any product information that has changed. For change details, review the revision history included in any revised document.

### 9.3 Support Resources

[TI E2E™ support forums](#) are an engineer's go-to source for fast, verified answers and design help — straight from the experts. Search existing answers or ask your own question to get the quick design help you need.

Linked content is provided "AS IS" by the respective contributors. They do not constitute TI specifications and do not necessarily reflect TI's views; see TI's [Terms of Use](#).

### 9.4 Trademarks

TI E2E™ is a trademark of Texas Instruments.  
All trademarks are the property of their respective owners.

### 9.5 Electrostatic Discharge Caution



This integrated circuit can be damaged by ESD. Texas Instruments recommends that all integrated circuits be handled with appropriate precautions. Failure to observe proper handling and installation procedures can cause damage.

ESD damage can range from subtle performance degradation to complete device failure. Precision integrated circuits may be more susceptible to damage because very small parametric changes could cause the device not to meet its published specifications.

### 9.6 Glossary

[TI Glossary](#) This glossary lists and explains terms, acronyms, and definitions.

## 10 Revision History

NOTE: Page numbers for previous revisions may differ from page numbers in the current version.

<b>Changes from Revision Y (March 2025) to Revision Z (May 2025)</b>	<b>Page</b>
• Added missing <i>Revision History</i> entry for "Updated Thermal Information" table in revision "Y" .....	5
• Fixed duplicated Fig 6-4 graph.....	5

---

<b>Changes from Revision X (October 2023) to Revision Y (March 2025)</b>	<b>Page</b>
• Removed legacy devices from <i>Device Information</i> table.....	1
• Updated front page ESD values in <i>Family Comparison Table</i> .....	1
• Updated <i>Thermal Information</i> table.....	5
• Removed legacy device graphs.....	13
• Updated internal schematic.....	19

---

<b>Changes from Revision W (October 2023) to Revision X (October 2023)</b>	<b>Page</b>
• Added LM339B and LM2901B to Device Information Table for SOT-23/QFN.....	1

---

<b>Changes from Revision V (December 2022) to Revision W (October 2023)</b>	<b>Page</b>
• Updated thermal tables for new package releases.....	5
• Changed Apps Input Voltage Range text to reference appnote.....	20

---

<b>Changes from Revision U (November 2018) to Revision V (December 2022)</b>	<b>Page</b>
• Updated the numbering format for tables, figures, and cross-references throughout the document. ....	1
• Added "B" version throughout. Added Device Family Table. ....	1

---

<b>Changes from Revision T (June 2015) to Revision U (November 2018)</b>	<b>Page</b>
• Changed LM239x temperature range from 125°C to 85°C in <i>Description</i> section.....	1
• Changed data sheet title .....	1
• Changed LM293AD to LM239AD in <i>Device Comparison Table</i> .....	3
• Added Input Current and related footnote in <i>Absolute Maximum Ratings</i> .....	5
• Changed layout of <i>Recommended Operating Conditions</i> temperatures to separate rows.....	6
• Added LM2901V and LMV2901AV to LM2901 Elect Char Table title to make more clear which devices are covered.....	11
• Changed "Dual" to "Quad" and removed "Absolute Maximum" wording and mention of Q100 in <i>Overview</i> section text.....	19
• Changed and corrected text in <i>Feature Description</i> section.....	19
• Changed Example Values in <i>Typical Application Design Parameters</i> table .....	20
• Added <i>Receiving Notification of Documentation Updates</i> section.....	23

---



---

<b>Changes from Revision S (August 2012) to Revision T (June 2015)</b>	<b>Page</b>
• Deleted <i>Ordering Information</i> table. ....	1
• Added Military Disclaimer to <i>Features</i> list.....	1
• Added <i>Applications</i> , <i>Device Information</i> table, <i>Pin Configuration and Functions</i> section, <i>ESD Ratings</i> table, <i>Thermal Information</i> table, <i>Feature Description</i> section, <i>Device Functional Modes</i> , <i>Application and Implementation</i> section, <i>Power Supply Recommendations</i> section, <i>Layout</i> section, <i>Device and Documentation Support</i> section, and <i>Mechanical, Packaging, and Orderable Information</i> section. No specification changes.....	1

## 11 Mechanical, Packaging, and Orderable Information

The following pages include mechanical packaging and orderable information. This information is the most current data available for the designated devices. This data is subject to change without notice and revision of this document. For browser based versions of this data sheet, refer to the left hand navigation.

**PACKAGING INFORMATION**

Orderable part number	Status (1)	Material type (2)	Package   Pins	Package qty   Carrier	RoHS (3)	Lead finish/ Ball material (4)	MSL rating/ Peak reflow (5)	Op temp (°C)	Part marking (6)
<a href="#">LM139AD</a>	Obsolete	Production	SOIC (D)   14	-	-	Call TI	Call TI	-55 to 125	LM139A
<a href="#">LM139ADG4</a>	Obsolete	Production	SOIC (D)   14	-	-	Call TI	Call TI	-55 to 125	LM139A
<a href="#">LM139ADR</a>	Active	Production	SOIC (D)   14	2500   LARGE T&R	Yes	NIPDAU	Level-1-260C-UNLIM	-55 to 125	LM139A
LM139ADR.A	Active	Production	SOIC (D)   14	2500   LARGE T&R	Yes	NIPDAU	Level-1-260C-UNLIM	-55 to 125	LM139A
<a href="#">LM139ADRG4</a>	Active	Production	SOIC (D)   14	2500   LARGE T&R	Yes	NIPDAU	Level-1-260C-UNLIM	-55 to 125	LM139A
LM139ADRG4.A	Active	Production	SOIC (D)   14	2500   LARGE T&R	Yes	NIPDAU	Level-1-260C-UNLIM	-55 to 125	LM139A
<a href="#">LM139D</a>	Obsolete	Production	SOIC (D)   14	-	-	Call TI	Call TI	-55 to 125	LM139
<a href="#">LM139DG4</a>	Obsolete	Production	SOIC (D)   14	-	-	Call TI	Call TI	-55 to 125	LM139
<a href="#">LM139DR</a>	Active	Production	SOIC (D)   14	2500   LARGE T&R	Yes	NIPDAU	Level-1-260C-UNLIM	-55 to 125	LM139
LM139DR.A	Active	Production	SOIC (D)   14	2500   LARGE T&R	Yes	NIPDAU	Level-1-260C-UNLIM	-55 to 125	LM139
<a href="#">LM139DRG4</a>	Active	Production	SOIC (D)   14	2500   LARGE T&R	Yes	NIPDAU	Level-1-260C-UNLIM	-55 to 125	LM139
LM139DRG4.A	Active	Production	SOIC (D)   14	2500   LARGE T&R	Yes	NIPDAU	Level-1-260C-UNLIM	-55 to 125	LM139
<a href="#">LM239AD</a>	Obsolete	Production	SOIC (D)   14	-	-	Call TI	Call TI	-25 to 85	LM239A
<a href="#">LM239ADR</a>	Active	Production	SOIC (D)   14	2500   LARGE T&R	Yes	NIPDAU	Level-1-260C-UNLIM	-25 to 85	LM239A
LM239ADR.A	Active	Production	SOIC (D)   14	2500   LARGE T&R	Yes	NIPDAU	Level-1-260C-UNLIM	-25 to 85	LM239A
LM239ADRE4	Active	Production	SOIC (D)   14	2500   LARGE T&R	-	Call TI	Call TI	-25 to 85	
LM239ADRG4	Active	Production	SOIC (D)   14	2500   LARGE T&R	-	Call TI	Call TI	-25 to 85	
<a href="#">LM239D</a>	Obsolete	Production	SOIC (D)   14	-	-	Call TI	Call TI	-25 to 85	LM239
<a href="#">LM239DR</a>	Active	Production	SOIC (D)   14	2500   LARGE T&R	Yes	NIPDAU	Level-1-260C-UNLIM	-25 to 85	LM239
LM239DR.A	Active	Production	SOIC (D)   14	2500   LARGE T&R	Yes	NIPDAU	Level-1-260C-UNLIM	-25 to 85	LM239
<a href="#">LM239N</a>	Active	Production	PDIP (N)   14	25   TUBE	Yes	NIPDAU   SN	N/A for Pkg Type	-25 to 85	LM239N
LM239N.A	Active	Production	PDIP (N)   14	25   TUBE	Yes	NIPDAU	N/A for Pkg Type	-25 to 85	LM239N
LM239NE4	Active	Production	PDIP (N)   14	25   TUBE	-	Call TI	Call TI	-25 to 85	
<a href="#">LM239PW</a>	Obsolete	Production	TSSOP (PW)   14	-	-	Call TI	Call TI	-25 to 85	L239
<a href="#">LM239PWR</a>	Active	Production	TSSOP (PW)   14	2000   LARGE T&R	Yes	NIPDAU   SN	Level-1-260C-UNLIM	-25 to 85	L239
LM239PWR.A	Active	Production	TSSOP (PW)   14	2000   LARGE T&R	Yes	NIPDAU	Level-1-260C-UNLIM	-25 to 85	L239
<a href="#">LM239PWRG4</a>	Obsolete	Production	TSSOP (PW)   14	-	-	Call TI	Call TI	-25 to 85	L239
<a href="#">LM2901AVQDR</a>	Active	Production	SOIC (D)   14	2500   LARGE T&R	Yes	NIPDAU	Level-1-260C-UNLIM	-40 to 125	(2901AV, L2901AV)
LM2901AVQDR.A	Active	Production	SOIC (D)   14	2500   LARGE T&R	Yes	NIPDAU	Level-1-260C-UNLIM	-40 to 125	(2901AV, L2901AV)

Orderable part number	Status (1)	Material type (2)	Package   Pins	Package qty   Carrier	RoHS (3)	Lead finish/ Ball material (4)	MSL rating/ Peak reflow (5)	Op temp (°C)	Part marking (6)
<a href="#">LM2901AVQDRG4</a>	Active	Production	SOIC (D)   14	2500   LARGE T&R	Yes	NIPDAU	Level-1-260C-UNLIM	-40 to 125	(2901AV, L2901AV)
LM2901AVQDRG4.A	Active	Production	SOIC (D)   14	2500   LARGE T&R	Yes	NIPDAU	Level-1-260C-UNLIM	-40 to 125	(2901AV, L2901AV)
<a href="#">LM2901AVQPWR</a>	Active	Production	TSSOP (PW)   14	2000   LARGE T&R	Yes	NIPDAU	Level-1-260C-UNLIM	-40 to 125	(2901AV, L2901AV)
LM2901AVQPWR.A	Active	Production	TSSOP (PW)   14	2000   LARGE T&R	Yes	NIPDAU	Level-1-260C-UNLIM	-40 to 125	(2901AV, L2901AV)
<a href="#">LM2901AVQPWRG4</a>	Active	Production	TSSOP (PW)   14	2000   LARGE T&R	Yes	NIPDAU	Level-1-260C-UNLIM	-40 to 125	(2901AV, L2901AV)
LM2901AVQPWRG4.A	Active	Production	TSSOP (PW)   14	2000   LARGE T&R	Yes	NIPDAU	Level-1-260C-UNLIM	-40 to 125	(2901AV, L2901AV)
<a href="#">LM2901BIDR</a>	Active	Production	SOIC (D)   14	3000   LARGE T&R	Yes	NIPDAU	Level-1-260C-UNLIM	-40 to 125	LM2901B
LM2901BIDR.A	Active	Production	SOIC (D)   14	3000   LARGE T&R	Yes	NIPDAU	Level-1-260C-UNLIM	-40 to 125	LM2901B
<a href="#">LM2901BIPWR</a>	Active	Production	TSSOP (PW)   14	3000   LARGE T&R	Yes	NIPDAU	Level-1-260C-UNLIM	-40 to 125	LM2901B
LM2901BIPWR.A	Active	Production	TSSOP (PW)   14	3000   LARGE T&R	Yes	NIPDAU	Level-1-260C-UNLIM	-40 to 125	LM2901B
<a href="#">LM2901BIRTER</a>	Active	Production	WQFN (RTE)   16	5000   LARGE T&R	Yes	SN	Level-1-260C-UNLIM	-40 to 125	M2901B
LM2901BIRTER.A	Active	Production	WQFN (RTE)   16	5000   LARGE T&R	Yes	SN	Level-1-260C-UNLIM	-40 to 125	M2901B
<a href="#">LM2901D</a>	Obsolete	Production	SOIC (D)   14	-	-	Call TI	Call TI	-40 to 125	LM2901
<a href="#">LM2901DR</a>	Active	Production	SOIC (D)   14	2500   LARGE T&R	Yes	NIPDAU	Level-1-260C-UNLIM	-40 to 125	LM2901
LM2901DR.A	Active	Production	SOIC (D)   14	2500   LARGE T&R	Yes	NIPDAU	Level-1-260C-UNLIM	-40 to 125	LM2901
LM2901DRE4	Active	Production	SOIC (D)   14	2500   LARGE T&R	Yes	NIPDAU	Level-1-260C-UNLIM	-40 to 125	LM2901
<a href="#">LM2901DRG3</a>	Active	Production	SOIC (D)   14	2500   LARGE T&R	Yes	SN	Level-1-260C-UNLIM	-40 to 125	LM2901
LM2901DRG3.A	Active	Production	SOIC (D)   14	2500   LARGE T&R	Yes	SN	Level-1-260C-UNLIM	-40 to 125	LM2901
<a href="#">LM2901DRG4</a>	Active	Production	SOIC (D)   14	2500   LARGE T&R	Yes	NIPDAU	Level-1-260C-UNLIM	-40 to 125	LM2901
LM2901DRG4.A	Active	Production	SOIC (D)   14	2500   LARGE T&R	Yes	NIPDAU	Level-1-260C-UNLIM	-40 to 125	LM2901
<a href="#">LM2901N</a>	Active	Production	PDIP (N)   14	25   TUBE	Yes	NIPDAU	N/A for Pkg Type	-40 to 125	LM2901N
LM2901N.A	Active	Production	PDIP (N)   14	25   TUBE	Yes	NIPDAU	N/A for Pkg Type	-40 to 125	LM2901N
<a href="#">LM2901NSR</a>	Active	Production	SOP (NS)   14	2000   LARGE T&R	Yes	NIPDAU	Level-1-260C-UNLIM	-40 to 125	LM2901
LM2901NSR.A	Active	Production	SOP (NS)   14	2000   LARGE T&R	Yes	NIPDAU	Level-1-260C-UNLIM	-40 to 125	LM2901
<a href="#">LM2901PW</a>	Obsolete	Production	TSSOP (PW)   14	-	-	Call TI	Call TI	-40 to 125	L2901
<a href="#">LM2901PWR</a>	Active	Production	TSSOP (PW)   14	2000   LARGE T&R	Yes	NIPDAU	Level-1-260C-UNLIM	-40 to 125	L2901
LM2901PWR.A	Active	Production	TSSOP (PW)   14	2000   LARGE T&R	Yes	NIPDAU	Level-1-260C-UNLIM	-40 to 125	L2901
<a href="#">LM2901PWRG3</a>	Active	Production	TSSOP (PW)   14	2000   LARGE T&R	Yes	SN	Level-1-260C-UNLIM	-40 to 125	L2901
LM2901PWRG3.A	Active	Production	TSSOP (PW)   14	2000   LARGE T&R	Yes	SN	Level-1-260C-UNLIM	-40 to 125	L2901
<a href="#">LM2901PWRG4</a>	Active	Production	TSSOP (PW)   14	2000   LARGE T&R	Yes	NIPDAU	Level-1-260C-UNLIM	-40 to 125	L2901
LM2901PWRG4.A	Active	Production	TSSOP (PW)   14	2000   LARGE T&R	Yes	NIPDAU	Level-1-260C-UNLIM	-40 to 125	L2901

Orderable part number	Status (1)	Material type (2)	Package   Pins	Package qty   Carrier	RoHS (3)	Lead finish/ Ball material (4)	MSL rating/ Peak reflow (5)	Op temp (°C)	Part marking (6)
<a href="#">LM2901VQDR</a>	Active	Production	SOIC (D)   14	2500   LARGE T&R	Yes	NIPDAU	Level-1-260C-UNLIM	-40 to 125	L2901V
LM2901VQDR.A	Active	Production	SOIC (D)   14	2500   LARGE T&R	Yes	NIPDAU	Level-1-260C-UNLIM	-40 to 125	L2901V
<a href="#">LM2901VQPWR</a>	Active	Production	TSSOP (PW)   14	2000   LARGE T&R	Yes	NIPDAU	Level-1-260C-UNLIM	-40 to 125	L2901V
LM2901VQPWR.A	Active	Production	TSSOP (PW)   14	2000   LARGE T&R	Yes	NIPDAU	Level-1-260C-UNLIM	-40 to 125	L2901V
<a href="#">LM2901VQPWRG4</a>	Active	Production	TSSOP (PW)   14	2000   LARGE T&R	Yes	NIPDAU	Level-1-260C-UNLIM	-40 to 125	L2901V
LM2901VQPWRG4.A	Active	Production	TSSOP (PW)   14	2000   LARGE T&R	Yes	NIPDAU	Level-1-260C-UNLIM	-40 to 125	L2901V
<a href="#">LM339AD</a>	Obsolete	Production	SOIC (D)   14	-	-	Call TI	Call TI	0 to 70	LM339A
<a href="#">LM339ADBR</a>	Active	Production	SSOP (DB)   14	2000   LARGE T&R	Yes	NIPDAU	Level-1-260C-UNLIM	0 to 70	L339A
LM339ADBR.A	Active	Production	SSOP (DB)   14	2000   LARGE T&R	Yes	NIPDAU	Level-1-260C-UNLIM	0 to 70	L339A
<a href="#">LM339ADR</a>	Active	Production	SOIC (D)   14	2500   LARGE T&R	Yes	NIPDAU   SN	Level-1-260C-UNLIM	0 to 70	LM339A
LM339ADR.A	Active	Production	SOIC (D)   14	2500   LARGE T&R	Yes	NIPDAU	Level-1-260C-UNLIM	0 to 70	LM339A
<a href="#">LM339ADRG4</a>	Obsolete	Production	SOIC (D)   14	-	-	Call TI	Call TI	0 to 70	LM339A
<a href="#">LM339AN</a>	Active	Production	PDIP (N)   14	25   TUBE	Yes	NIPDAU   SN	N/A for Pkg Type	0 to 70	LM339AN
LM339AN.A	Active	Production	PDIP (N)   14	25   TUBE	Yes	NIPDAU	N/A for Pkg Type	0 to 70	LM339AN
LM339ANE4	Active	Production	PDIP (N)   14	25   TUBE	-	Call TI	Call TI	0 to 70	
<a href="#">LM339ANSR</a>	Active	Production	SOP (NS)   14	2000   LARGE T&R	Yes	NIPDAU	Level-1-260C-UNLIM	0 to 70	LM339A
LM339ANSR.A	Active	Production	SOP (NS)   14	2000   LARGE T&R	Yes	NIPDAU	Level-1-260C-UNLIM	0 to 70	LM339A
<a href="#">LM339APW</a>	Obsolete	Production	TSSOP (PW)   14	-	-	Call TI	Call TI	0 to 70	L339A
<a href="#">LM339APWR</a>	Active	Production	TSSOP (PW)   14	2000   LARGE T&R	Yes	NIPDAU   SN	Level-1-260C-UNLIM	0 to 70	L339A
LM339APWR.A	Active	Production	TSSOP (PW)   14	2000   LARGE T&R	Yes	NIPDAU	Level-1-260C-UNLIM	0 to 70	L339A
<a href="#">LM339APWRG4</a>	Active	Production	TSSOP (PW)   14	2000   LARGE T&R	Yes	NIPDAU	Level-1-260C-UNLIM	0 to 70	L339A
LM339APWRG4.A	Active	Production	TSSOP (PW)   14	2000   LARGE T&R	Yes	NIPDAU	Level-1-260C-UNLIM	0 to 70	L339A
<a href="#">LM339BIDR</a>	Active	Production	SOIC (D)   14	3000   LARGE T&R	Yes	NIPDAU	Level-1-260C-UNLIM	-40 to 85	LM339B
LM339BIDR.A	Active	Production	SOIC (D)   14	3000   LARGE T&R	Yes	NIPDAU	Level-1-260C-UNLIM	-40 to 85	LM339B
<a href="#">LM339BIPWR</a>	Active	Production	TSSOP (PW)   14	3000   LARGE T&R	Yes	NIPDAU	Level-1-260C-UNLIM	-40 to 85	LM339B
LM339BIPWR.A	Active	Production	TSSOP (PW)   14	3000   LARGE T&R	Yes	NIPDAU	Level-1-260C-UNLIM	-40 to 85	LM339B
<a href="#">LM339BIRTER</a>	Active	Production	WQFN (RTE)   16	5000   LARGE T&R	Yes	SN	Level-1-260C-UNLIM	-40 to 85	LM339B
LM339BIRTER.A	Active	Production	WQFN (RTE)   16	5000   LARGE T&R	Yes	SN	Level-1-260C-UNLIM	-40 to 85	LM339B
<a href="#">LM339D</a>	Obsolete	Production	SOIC (D)   14	-	-	Call TI	Call TI	0 to 70	LM339
<a href="#">LM339DBR</a>	Active	Production	SSOP (DB)   14	2000   LARGE T&R	Yes	NIPDAU	Level-1-260C-UNLIM	0 to 70	LM339
LM339DBR.A	Active	Production	SSOP (DB)   14	2000   LARGE T&R	Yes	NIPDAU	Level-1-260C-UNLIM	0 to 70	LM339

Orderable part number	Status (1)	Material type (2)	Package   Pins	Package qty   Carrier	RoHS (3)	Lead finish/ Ball material (4)	MSL rating/ Peak reflow (5)	Op temp (°C)	Part marking (6)
<a href="#">LM339DR</a>	Active	Production	SOIC (D)   14	2500   LARGE T&R	Yes	NIPDAU   SN	Level-1-260C-UNLIM	0 to 70	LM339
LM339DR.A	Active	Production	SOIC (D)   14	2500   LARGE T&R	Yes	NIPDAU	Level-1-260C-UNLIM	0 to 70	LM339
LM339DRE4	Active	Production	SOIC (D)   14	2500   LARGE T&R	Yes	NIPDAU	Level-1-260C-UNLIM	0 to 70	LM339
<a href="#">LM339DRG4</a>	Active	Production	SOIC (D)   14	2500   LARGE T&R	Yes	NIPDAU	Level-1-260C-UNLIM	0 to 70	LM339
LM339DRG4.A	Active	Production	SOIC (D)   14	2500   LARGE T&R	Yes	NIPDAU	Level-1-260C-UNLIM	0 to 70	LM339
<a href="#">LM339N</a>	Active	Production	PDIP (N)   14	25   TUBE	Yes	NIPDAU   SN	N/A for Pkg Type	0 to 70	LM339N
LM339N.A	Active	Production	PDIP (N)   14	25   TUBE	Yes	NIPDAU	N/A for Pkg Type	0 to 70	LM339N
<a href="#">LM339NE3</a>	Active	Production	PDIP (N)   14	25   TUBE	Yes	SN	N/A for Pkg Type	0 to 70	LM339N
LM339NE3.A	Active	Production	PDIP (N)   14	25   TUBE	Yes	SN	N/A for Pkg Type	0 to 70	LM339N
<a href="#">LM339NE4</a>	Active	Production	PDIP (N)   14	25   TUBE	Yes	NIPDAU	N/A for Pkg Type	0 to 70	LM339N
LM339NE4.A	Active	Production	PDIP (N)   14	25   TUBE	Yes	NIPDAU	N/A for Pkg Type	0 to 70	LM339N
<a href="#">LM339NSR</a>	Active	Production	SOP (NS)   14	2000   LARGE T&R	Yes	NIPDAU	Level-1-260C-UNLIM	0 to 70	LM339
LM339NSR.A	Active	Production	SOP (NS)   14	2000   LARGE T&R	Yes	NIPDAU	Level-1-260C-UNLIM	0 to 70	LM339
<a href="#">LM339PW</a>	Obsolete	Production	TSSOP (PW)   14	-	-	Call TI	Call TI	0 to 70	L339
<a href="#">LM339PWR</a>	Active	Production	TSSOP (PW)   14	2000   LARGE T&R	Yes	NIPDAU	Level-1-260C-UNLIM	0 to 70	L339
LM339PWR.A	Active	Production	TSSOP (PW)   14	2000   LARGE T&R	Yes	NIPDAU	Level-1-260C-UNLIM	0 to 70	L339
LM339PWRE4	Active	Production	TSSOP (PW)   14	2000   LARGE T&R	Yes	NIPDAU	Level-1-260C-UNLIM	0 to 70	L339
<a href="#">LM339PWRG3</a>	Active	Production	TSSOP (PW)   14	2000   LARGE T&R	Yes	SN	Level-1-260C-UNLIM	0 to 70	L339
LM339PWRG3.A	Active	Production	TSSOP (PW)   14	2000   LARGE T&R	Yes	SN	Level-1-260C-UNLIM	0 to 70	L339
<a href="#">LM339PWRG4</a>	Active	Production	TSSOP (PW)   14	2000   LARGE T&R	Yes	NIPDAU	Level-1-260C-UNLIM	0 to 70	L339
LM339PWRG4.A	Active	Production	TSSOP (PW)   14	2000   LARGE T&R	Yes	NIPDAU	Level-1-260C-UNLIM	0 to 70	L339

(1) **Status:** For more details on status, see our [product life cycle](#).

(2) **Material type:** When designated, preproduction parts are prototypes/experimental devices, and are not yet approved or released for full production. Testing and final process, including without limitation quality assurance, reliability performance testing, and/or process qualification, may not yet be complete, and this item is subject to further changes or possible discontinuation. If available for ordering, purchases will be subject to an additional waiver at checkout, and are intended for early internal evaluation purposes only. These items are sold without warranties of any kind.

(3) **RoHS values:** Yes, No, RoHS Exempt. See the [TI RoHS Statement](#) for additional information and value definition.

(4) **Lead finish/Ball material:** Parts may have multiple material finish options. Finish options are separated by a vertical ruled line. Lead finish/Ball material values may wrap to two lines if the finish value exceeds the maximum column width.

<sup>(5)</sup> **MSL rating/Peak reflow:** The moisture sensitivity level ratings and peak solder (reflow) temperatures. In the event that a part has multiple moisture sensitivity ratings, only the lowest level per JEDEC standards is shown. Refer to the shipping label for the actual reflow temperature that will be used to mount the part to the printed circuit board.

<sup>(6)</sup> **Part marking:** There may be an additional marking, which relates to the logo, the lot trace code information, or the environmental category of the part.

Multiple part markings will be inside parentheses. Only one part marking contained in parentheses and separated by a "~" will appear on a part. If a line is indented then it is a continuation of the previous line and the two combined represent the entire part marking for that device.

**Important Information and Disclaimer:** The information provided on this page represents TI's knowledge and belief as of the date that it is provided. TI bases its knowledge and belief on information provided by third parties, and makes no representation or warranty as to the accuracy of such information. Efforts are underway to better integrate information from third parties. TI has taken and continues to take reasonable steps to provide representative and accurate information but may not have conducted destructive testing or chemical analysis on incoming materials and chemicals. TI and TI suppliers consider certain information to be proprietary, and thus CAS numbers and other limited information may not be available for release.

In no event shall TI's liability arising out of such information exceed the total purchase price of the TI part(s) at issue in this document sold by TI to Customer on an annual basis.

**OTHER QUALIFIED VERSIONS OF LM139, LM239A, LM2901, LM2901AV, LM2901B, LM2901V :**

- Automotive : [LM239A-Q1](#), [LM2901-Q1](#), [LM2901AV-Q1](#), [LM2901B-Q1](#), [LM2901V-Q1](#)
- Enhanced Product : [LM239A-EP](#)
- Space : [LM139-SP](#)

NOTE: Qualified Version Definitions:

- Automotive - Q100 devices qualified for high-reliability automotive applications targeting zero defects
- Enhanced Product - Supports Defense, Aerospace and Medical Applications
- Space - Radiation tolerant, ceramic packaging and qualified for use in Space-based application

**TAPE AND REEL INFORMATION**

**QUADRANT ASSIGNMENTS FOR PIN 1 ORIENTATION IN TAPE**

\*All dimensions are nominal

Device	Package Type	Package Drawing	Pins	SPQ	Reel Diameter (mm)	Reel Width W1 (mm)	A0 (mm)	B0 (mm)	K0 (mm)	P1 (mm)	W (mm)	Pin1 Quadrant
LM139ADR	SOIC	D	14	2500	330.0	16.4	6.5	9.0	2.1	8.0	16.0	Q1
LM139DRG4	SOIC	D	14	2500	330.0	16.4	6.5	9.0	2.1	8.0	16.0	Q1
LM139DR	SOIC	D	14	2500	330.0	16.4	6.5	9.0	2.1	8.0	16.0	Q1
LM139DRG4	SOIC	D	14	2500	330.0	16.4	6.5	9.0	2.1	8.0	16.0	Q1
LM239ADR	SOIC	D	14	2500	330.0	16.4	6.5	9.0	2.1	8.0	16.0	Q1
LM239DR	SOIC	D	14	2500	330.0	16.4	6.5	9.0	2.1	8.0	16.0	Q1
LM239DR	SOIC	D	14	2500	330.0	16.4	6.5	9.0	2.1	8.0	16.0	Q1
LM239PWR	TSSOP	PW	14	2000	330.0	12.4	6.9	5.6	1.6	8.0	12.0	Q1
LM239PWR	TSSOP	PW	14	2000	330.0	12.4	6.9	5.6	1.6	8.0	12.0	Q1
LM239PWR	TSSOP	PW	14	2000	330.0	12.4	6.9	5.6	1.6	8.0	12.0	Q1
LM2901AVQDR	SOIC	D	14	2500	330.0	16.4	6.5	9.0	2.1	8.0	16.0	Q1
LM2901AVQDRG4	SOIC	D	14	2500	330.0	16.4	6.5	9.0	2.1	8.0	16.0	Q1
LM2901AVQPWR	TSSOP	PW	14	2000	330.0	12.4	6.9	5.6	1.6	8.0	12.0	Q1
LM2901AVQPWR	TSSOP	PW	14	2000	330.0	12.4	6.9	5.6	1.6	8.0	12.0	Q1
LM2901AVQPWRG4	TSSOP	PW	14	2000	330.0	12.4	6.9	5.6	1.6	8.0	12.0	Q1
LM2901AVQPWRG4	TSSOP	PW	14	2000	330.0	12.4	6.9	5.6	1.6	8.0	12.0	Q1



Device	Package Type	Package Drawing	Pins	SPQ	Reel Diameter (mm)	Reel Width W1 (mm)	A0 (mm)	B0 (mm)	K0 (mm)	P1 (mm)	W (mm)	Pin1 Quadrant
LM2901BIDR	SOIC	D	14	3000	330.0	16.4	6.5	9.0	2.1	8.0	16.0	Q1
LM2901BIPWR	TSSOP	PW	14	3000	330.0	12.4	6.9	5.6	1.6	8.0	12.0	Q1
LM2901BIRTER	WQFN	RTE	16	5000	330.0	12.4	3.3	3.3	1.1	8.0	12.0	Q2
LM2901DR	SOIC	D	14	2500	330.0	16.4	6.5	9.0	2.1	8.0	16.0	Q1
LM2901DR	SOIC	D	14	2500	330.0	16.4	6.5	9.0	2.1	8.0	16.0	Q1
LM2901DRG3	SOIC	D	14	2500	330.0	16.8	6.5	9.5	2.1	8.0	16.0	Q1
LM2901DRG4	SOIC	D	14	2500	330.0	16.4	6.5	9.0	2.1	8.0	16.0	Q1
LM2901DRG4	SOIC	D	14	2500	330.0	16.4	6.5	9.0	2.1	8.0	16.0	Q1
LM2901NSR	SOP	NS	14	2000	330.0	16.4	8.1	10.4	2.5	12.0	16.0	Q1
LM2901PWR	TSSOP	PW	14	2000	330.0	12.4	6.9	5.6	1.6	8.0	12.0	Q1
LM2901PWR	TSSOP	PW	14	2000	330.0	12.4	6.9	5.6	1.6	8.0	12.0	Q1
LM2901PWRG3	TSSOP	PW	14	2000	330.0	12.4	6.9	5.6	1.6	8.0	12.0	Q1
LM2901PWRG4	TSSOP	PW	14	2000	330.0	12.4	6.9	5.6	1.6	8.0	12.0	Q1
LM2901PWRG4	TSSOP	PW	14	2000	330.0	12.4	6.9	5.6	1.6	8.0	12.0	Q1
LM2901VQDR	SOIC	D	14	2500	330.0	16.4	6.5	9.0	2.1	8.0	16.0	Q1
LM2901VQPWR	TSSOP	PW	14	2000	330.0	12.4	6.9	5.6	1.6	8.0	12.0	Q1
LM2901VQPWR	TSSOP	PW	14	2000	330.0	12.4	6.9	5.6	1.6	8.0	12.0	Q1
LM2901VQPWRG4	TSSOP	PW	14	2000	330.0	12.4	6.9	5.6	1.6	8.0	12.0	Q1
LM2901VQPWRG4	TSSOP	PW	14	2000	330.0	12.4	6.9	5.6	1.6	8.0	12.0	Q1
LM339ADBDR	SSOP	DB	14	2000	330.0	16.4	8.35	6.6	2.4	12.0	16.0	Q1
LM339ADR	SOIC	D	14	2500	330.0	16.4	6.5	9.0	2.1	8.0	16.0	Q1
LM339ANSR	SOP	NS	14	2000	330.0	16.4	8.1	10.4	2.5	12.0	16.0	Q1
LM339APWR	TSSOP	PW	14	2000	330.0	12.4	6.9	5.6	1.6	8.0	12.0	Q1
LM339APWR	TSSOP	PW	14	2000	330.0	12.4	6.9	5.6	1.6	8.0	12.0	Q1
LM339APWR	TSSOP	PW	14	2000	330.0	12.4	6.9	5.6	1.6	8.0	12.0	Q1
LM339APWRG4	TSSOP	PW	14	2000	330.0	12.4	6.9	5.6	1.6	8.0	12.0	Q1
LM339APWRG4	TSSOP	PW	14	2000	330.0	12.4	6.9	5.6	1.6	8.0	12.0	Q1
LM339BIDR	SOIC	D	14	3000	330.0	16.4	6.5	9.0	2.1	8.0	16.0	Q1
LM339BIPWR	TSSOP	PW	14	3000	330.0	12.4	6.9	5.6	1.6	8.0	12.0	Q1
LM339BIRTER	WQFN	RTE	16	5000	330.0	12.4	3.3	3.3	1.1	8.0	12.0	Q2
LM339DBDR	SSOP	DB	14	2000	330.0	16.4	8.35	6.6	2.4	12.0	16.0	Q1
LM339DR	SOIC	D	14	2500	330.0	16.4	6.5	9.0	2.1	8.0	16.0	Q1
LM339DR	SOIC	D	14	2500	330.0	16.4	6.5	9.0	2.1	8.0	16.0	Q1
LM339DRG4	SOIC	D	14	2500	330.0	16.4	6.5	9.0	2.1	8.0	16.0	Q1
LM339DRG4	SOIC	D	14	2500	330.0	16.4	6.5	9.0	2.1	8.0	16.0	Q1
LM339NSR	SOP	NS	14	2000	330.0	16.4	8.1	10.4	2.5	12.0	16.0	Q1
LM339PWR	TSSOP	PW	14	2000	330.0	12.4	6.9	5.6	1.6	8.0	12.0	Q1
LM339PWR	TSSOP	PW	14	2000	330.0	12.4	6.9	5.6	1.6	8.0	12.0	Q1
LM339PWRG3	TSSOP	PW	14	2000	330.0	12.4	6.9	5.6	1.6	8.0	12.0	Q1
LM339PWRG4	TSSOP	PW	14	2000	330.0	12.4	6.9	5.6	1.6	8.0	12.0	Q1

**TAPE AND REEL BOX DIMENSIONS**

\*All dimensions are nominal

Device	Package Type	Package Drawing	Pins	SPQ	Length (mm)	Width (mm)	Height (mm)
LM139ADR	SOIC	D	14	2500	353.0	353.0	32.0
LM139ADRG4	SOIC	D	14	2500	353.0	353.0	32.0
LM139DR	SOIC	D	14	2500	353.0	353.0	32.0
LM139DRG4	SOIC	D	14	2500	353.0	353.0	32.0
LM239ADR	SOIC	D	14	2500	353.0	353.0	32.0
LM239DR	SOIC	D	14	2500	353.0	353.0	32.0
LM239DR	SOIC	D	14	2500	353.0	353.0	32.0
LM239PWR	TSSOP	PW	14	2000	353.0	353.0	32.0
LM239PWR	TSSOP	PW	14	2000	353.0	353.0	32.0
LM239PWR	TSSOP	PW	14	2000	356.0	356.0	35.0
LM2901AVQDR	SOIC	D	14	2500	353.0	353.0	32.0
LM2901AVQDRG4	SOIC	D	14	2500	353.0	353.0	32.0
LM2901AVQPWR	TSSOP	PW	14	2000	353.0	353.0	32.0
LM2901AVQPWR	TSSOP	PW	14	2000	353.0	353.0	32.0
LM2901AVQPWRG4	TSSOP	PW	14	2000	353.0	353.0	32.0
LM2901AVQPWRG4	TSSOP	PW	14	2000	353.0	353.0	32.0
LM2901BIDR	SOIC	D	14	3000	353.0	353.0	32.0
LM2901BIPWR	TSSOP	PW	14	3000	353.0	353.0	32.0

Device	Package Type	Package Drawing	Pins	SPQ	Length (mm)	Width (mm)	Height (mm)
LM2901BIRTER	WQFN	RTE	16	5000	367.0	367.0	35.0
LM2901DR	SOIC	D	14	2500	353.0	353.0	32.0
LM2901DR	SOIC	D	14	2500	353.0	353.0	32.0
LM2901DRG3	SOIC	D	14	2500	364.0	364.0	27.0
LM2901DRG4	SOIC	D	14	2500	353.0	353.0	32.0
LM2901DRG4	SOIC	D	14	2500	353.0	353.0	32.0
LM2901NSR	SOP	NS	14	2000	353.0	353.0	32.0
LM2901PWR	TSSOP	PW	14	2000	353.0	353.0	32.0
LM2901PWR	TSSOP	PW	14	2000	353.0	353.0	32.0
LM2901PWRG3	TSSOP	PW	14	2000	364.0	364.0	27.0
LM2901PWRG4	TSSOP	PW	14	2000	353.0	353.0	32.0
LM2901PWRG4	TSSOP	PW	14	2000	353.0	353.0	32.0
LM2901VQDR	SOIC	D	14	2500	353.0	353.0	32.0
LM2901VQPWR	TSSOP	PW	14	2000	353.0	353.0	32.0
LM2901VQPWR	TSSOP	PW	14	2000	353.0	353.0	32.0
LM2901VQPWRG4	TSSOP	PW	14	2000	353.0	353.0	32.0
LM2901VQPWRG4	TSSOP	PW	14	2000	353.0	353.0	32.0
LM339ADBR	SSOP	DB	14	2000	353.0	353.0	32.0
LM339ADR	SOIC	D	14	2500	353.0	353.0	32.0
LM339ANSR	SOP	NS	14	2000	353.0	353.0	32.0
LM339APWR	TSSOP	PW	14	2000	353.0	353.0	32.0
LM339APWR	TSSOP	PW	14	2000	356.0	356.0	35.0
LM339APWR	TSSOP	PW	14	2000	353.0	353.0	32.0
LM339APWRG4	TSSOP	PW	14	2000	353.0	353.0	32.0
LM339APWRG4	TSSOP	PW	14	2000	353.0	353.0	32.0
LM339BIDR	SOIC	D	14	3000	353.0	353.0	32.0
LM339BIPWR	TSSOP	PW	14	3000	353.0	353.0	32.0
LM339BIRTER	WQFN	RTE	16	5000	367.0	367.0	35.0
LM339DBR	SSOP	DB	14	2000	353.0	353.0	32.0
LM339DR	SOIC	D	14	2500	353.0	353.0	32.0
LM339DR	SOIC	D	14	2500	353.0	353.0	32.0
LM339DRG4	SOIC	D	14	2500	353.0	353.0	32.0
LM339DRG4	SOIC	D	14	2500	353.0	353.0	32.0
LM339NSR	SOP	NS	14	2000	353.0	353.0	32.0
LM339PWR	TSSOP	PW	14	2000	353.0	353.0	32.0
LM339PWR	TSSOP	PW	14	2000	353.0	353.0	32.0
LM339PWRG3	TSSOP	PW	14	2000	364.0	364.0	27.0
LM339PWRG4	TSSOP	PW	14	2000	353.0	353.0	32.0

**TUBE**

\*All dimensions are nominal

Device	Package Name	Package Type	Pins	SPQ	L (mm)	W (mm)	T (µm)	B (mm)
LM239N	N	PDIP	14	25	506.1	9	600	5.4
LM239N	N	PDIP	14	25	506	13.97	11230	4.32
LM239N	N	PDIP	14	25	506	13.97	11230	4.32
LM239N.A	N	PDIP	14	25	506.1	9	600	5.4
LM239N.A	N	PDIP	14	25	506	13.97	11230	4.32
LM239N.A	N	PDIP	14	25	506	13.97	11230	4.32
LM2901N	N	PDIP	14	25	506	13.97	11230	4.32
LM2901N	N	PDIP	14	25	506	13.97	11230	4.32
LM2901N.A	N	PDIP	14	25	506	13.97	11230	4.32
LM2901N.A	N	PDIP	14	25	506	13.97	11230	4.32
LM2901N.A	N	PDIP	14	25	506	13.97	11230	4.32
LM339AN	N	PDIP	14	25	506	13.97	11230	4.32
LM339AN	N	PDIP	14	25	506.1	9	600	5.4
LM339AN	N	PDIP	14	25	506	13.97	11230	4.32
LM339AN.A	N	PDIP	14	25	506	13.97	11230	4.32
LM339AN.A	N	PDIP	14	25	506.1	9	600	5.4
LM339AN.A	N	PDIP	14	25	506	13.97	11230	4.32
LM339N	N	PDIP	14	25	506	13.97	11230	4.32
LM339N	N	PDIP	14	25	506	13.97	11230	4.32
LM339N	N	PDIP	14	25	506	13.97	11230	4.32
LM339N	N	PDIP	14	25	506.1	9	600	5.4
LM339N.A	N	PDIP	14	25	506	13.97	11230	4.32
LM339N.A	N	PDIP	14	25	506.1	9	600	5.4
LM339N.A	N	PDIP	14	25	506	13.97	11230	4.32
LM339N.A	N	PDIP	14	25	506	13.97	11230	4.32
LM339NE3	N	PDIP	14	25	506.1	9	600	5.4
LM339NE3.A	N	PDIP	14	25	506.1	9	600	5.4
LM339NE4	N	PDIP	14	25	506	13.97	11230	4.32
LM339NE4	N	PDIP	14	25	506	13.97	11230	4.32
LM339NE4.A	N	PDIP	14	25	506	13.97	11230	4.32

---

Device	Package Name	Package Type	Pins	SPQ	L (mm)	W (mm)	T (μm)	B (mm)
LM339NE4.A	N	PDIP	14	25	506	13.97	11230	4.32

## GENERIC PACKAGE VIEW

**RTE 16**

**WQFN - 0.8 mm max height**

3 x 3, 0.5 mm pitch

PLASTIC QUAD FLATPACK - NO LEAD

This image is a representation of the package family, actual package may vary.  
Refer to the product data sheet for package details.



4225944/A



SIDE WALL METAL THICKNESS DIM A	
OPTION 1	OPTION 2
0.1	0.2

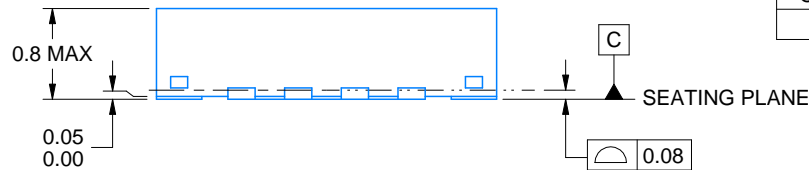

4219117/B 04/2022

NOTES:

1. All linear dimensions are in millimeters. Any dimensions in parenthesis are for reference only. Dimensioning and tolerancing per ASME Y14.5M.
2. This drawing is subject to change without notice.
3. The package thermal pad must be soldered to the printed circuit board for thermal and mechanical performance.

# EXAMPLE BOARD LAYOUT

RTE0016C

WQFN - 0.8 mm max height

PLASTIC QUAD FLATPACK - NO LEAD

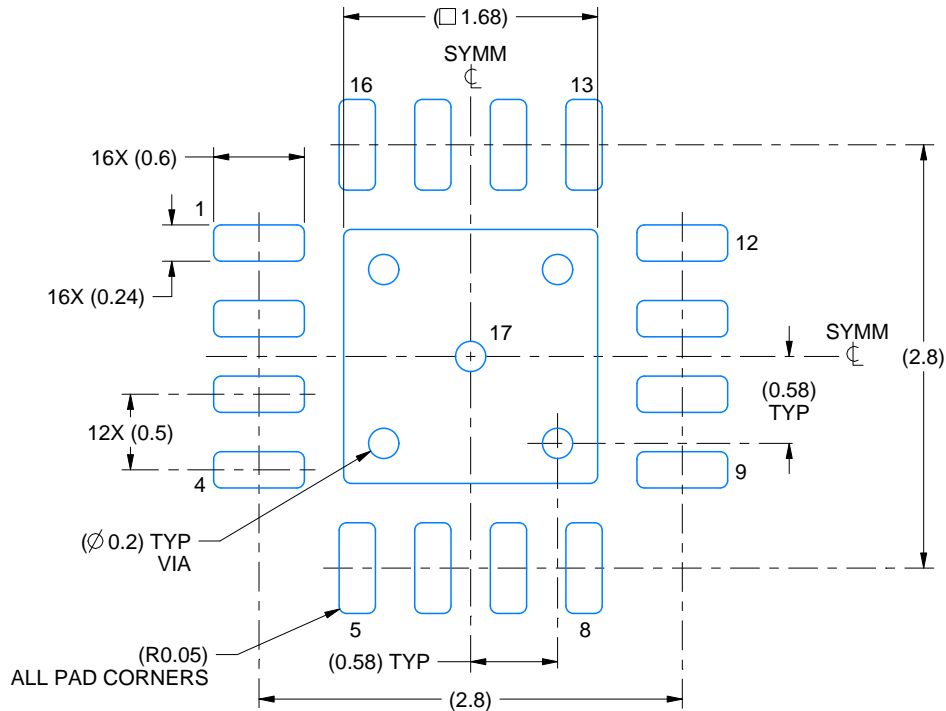

LAND PATTERN EXAMPLE  
EXPOSED METAL SHOWN  
SCALE:20X



SOLDER MASK DETAILS

4219117/B 04/2022

NOTES: (continued)

- This package is designed to be soldered to a thermal pad on the board. For more information, see Texas Instruments literature number SLUA271 ([www.ti.com/lit/slua271](http://www.ti.com/lit/slua271)).
- Vias are optional depending on application, refer to device data sheet. If any vias are implemented, refer to their locations shown on this view. It is recommended that vias under paste be filled, plugged or tented.



# EXAMPLE STENCIL DESIGN

RTE0016C

WQFN - 0.8 mm max height

PLASTIC QUAD FLATPACK - NO LEAD



**SOLDER PASTE EXAMPLE**  
BASED ON 0.125 mm THICK STENCIL

EXPOSED PAD 17:  
85% PRINTED SOLDER COVERAGE BY AREA UNDER PACKAGE  
SCALE:25X

4219117/B 04/2022

NOTES: (continued)

6. Laser cutting apertures with trapezoidal walls and rounded corners may offer better paste release. IPC-7525 may have alternate design recommendations.

D0014A



# PACKAGE OUTLINE

## SOIC - 1.75 mm max height

SMALL OUTLINE INTEGRATED CIRCUIT



4220718/A 09/2016

**NOTES:**

1. All linear dimensions are in millimeters. Dimensions in parenthesis are for reference only. Dimensioning and tolerancing per ASME Y14.5M.
2. This drawing is subject to change without notice.
3. This dimension does not include mold flash, protrusions, or gate burrs. Mold flash, protrusions, or gate burrs shall not exceed 0.15 mm, per side.
4. This dimension does not include interlead flash. Interlead flash shall not exceed 0.43 mm, per side.
5. Reference JEDEC registration MS-012, variation AB.

# EXAMPLE BOARD LAYOUT

D0014A

SOIC - 1.75 mm max height

SMALL OUTLINE INTEGRATED CIRCUIT



LAND PATTERN EXAMPLE  
SCALE:8X



SOLDER MASK DETAILS

4220718/A 09/2016

NOTES: (continued)

- 6. Publication IPC-7351 may have alternate designs.
- 7. Solder mask tolerances between and around signal pads can vary based on board fabrication site.

# EXAMPLE STENCIL DESIGN

D0014A

SOIC - 1.75 mm max height

SMALL OUTLINE INTEGRATED CIRCUIT



SOLDER PASTE EXAMPLE  
BASED ON 0.125 mm THICK STENCIL  
SCALE:8X

4220718/A 09/2016

NOTES: (continued)

8. Laser cutting apertures with trapezoidal walls and rounded corners may offer better paste release. IPC-7525 may have alternate design recommendations.
9. Board assembly site may have different recommendations for stencil design.

## MECHANICAL DATA

**NS (R-PDSO-G\*\*)**

**PLASTIC SMALL-OUTLINE PACKAGE**

**14-PINS SHOWN**



- NOTES:
- A. All linear dimensions are in millimeters.
  - B. This drawing is subject to change without notice.
  - C. Body dimensions do not include mold flash or protrusion, not to exceed 0,15.



# EXAMPLE BOARD LAYOUT

DB0014A

SSOP - 2 mm max height

SMALL OUTLINE PACKAGE



LAND PATTERN EXAMPLE  
EXPOSED METAL SHOWN  
SCALE: 10X



4220762/A 05/2024

NOTES: (continued)

- 5. Publication IPC-7351 may have alternate designs.
- 6. Solder mask tolerances between and around signal pads can vary based on board fabrication site.

# EXAMPLE STENCIL DESIGN

DB0014A

SSOP - 2 mm max height

SMALL OUTLINE PACKAGE



SOLDER PASTE EXAMPLE  
BASED ON 0.125 mm THICK STENCIL  
SCALE: 10X

4220762/A 05/2024

NOTES: (continued)

7. Laser cutting apertures with trapezoidal walls and rounded corners may offer better paste release. IPC-7525 may have alternate design recommendations.
8. Board assembly site may have different recommendations for stencil design.



N (R-PDIP-T\*\*)

PLASTIC DUAL-IN-LINE PACKAGE

16 PINS SHOWN



- NOTES:
- A. All linear dimensions are in inches (millimeters).
  - B. This drawing is subject to change without notice.
  - $\triangle C$  Falls within JEDEC MS-001, except 18 and 20 pin minimum body length (Dim A).
  - $\triangle D$  The 20 pin end lead shoulder width is a vendor option, either half or full width.

4040049/E 12/2002

PW0014A



PACKAGE OUTLINE

TSSOP - 1.2 mm max height

SMALL OUTLINE PACKAGE



4220202/B 12/2023

NOTES:

1. All linear dimensions are in millimeters. Any dimensions in parenthesis are for reference only. Dimensioning and tolerancing per ASME Y14.5M.
2. This drawing is subject to change without notice.
3. This dimension does not include mold flash, protrusions, or gate burrs. Mold flash, protrusions, or gate burrs shall not exceed 0.15 mm per side.
4. This dimension does not include interlead flash. Interlead flash shall not exceed 0.25 mm per side.
5. Reference JEDEC registration MO-153.

# EXAMPLE BOARD LAYOUT

PW0014A

TSSOP - 1.2 mm max height

SMALL OUTLINE PACKAGE

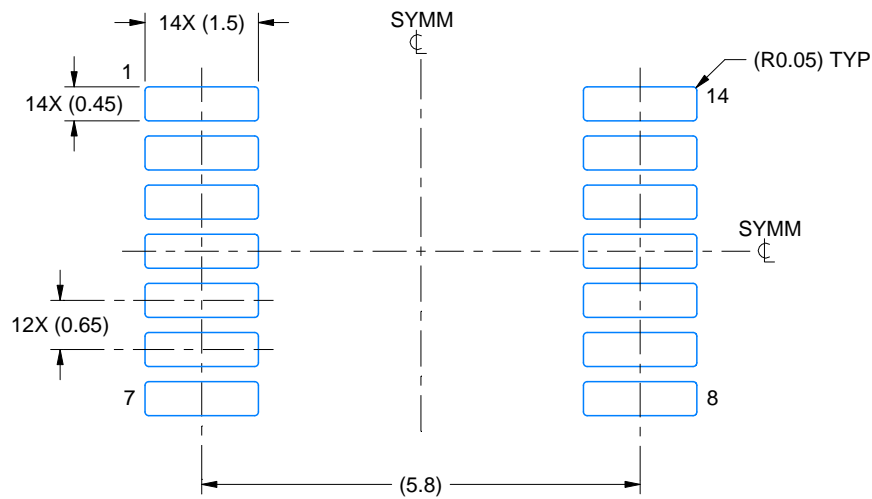

LAND PATTERN EXAMPLE  
EXPOSED METAL SHOWN  
SCALE: 10X

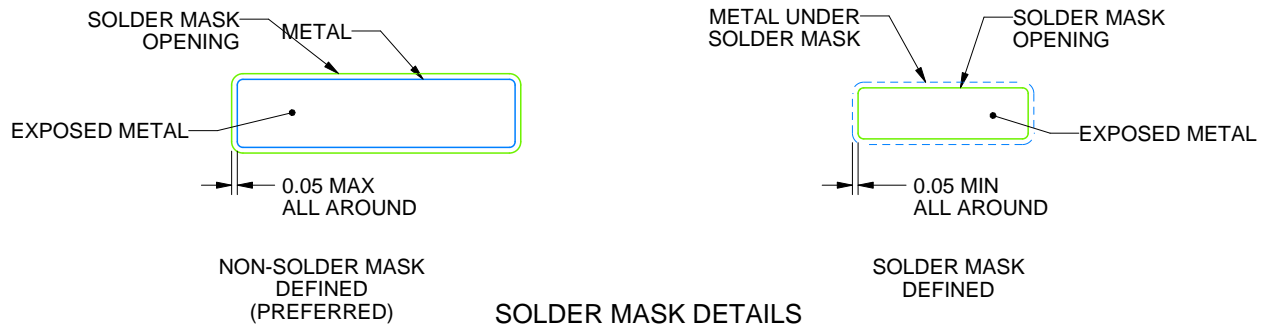

4220202/B 12/2023

NOTES: (continued)

- 6. Publication IPC-7351 may have alternate designs.
- 7. Solder mask tolerances between and around signal pads can vary based on board fabrication site.

# EXAMPLE STENCIL DESIGN

PW0014A

TSSOP - 1.2 mm max height

SMALL OUTLINE PACKAGE



SOLDER PASTE EXAMPLE  
BASED ON 0.125 mm THICK STENCIL  
SCALE: 10X

4220202/B 12/2023

NOTES: (continued)

8. Laser cutting apertures with trapezoidal walls and rounded corners may offer better paste release. IPC-7525 may have alternate design recommendations.
9. Board assembly site may have different recommendations for stencil design.

## IMPORTANT NOTICE AND DISCLAIMER

TI PROVIDES TECHNICAL AND RELIABILITY DATA (INCLUDING DATASHEETS), DESIGN RESOURCES (INCLUDING REFERENCE DESIGNS), APPLICATION OR OTHER DESIGN ADVICE, WEB TOOLS, SAFETY INFORMATION, AND OTHER RESOURCES "AS IS" AND WITH ALL FAULTS, AND DISCLAIMS ALL WARRANTIES, EXPRESS AND IMPLIED, INCLUDING WITHOUT LIMITATION ANY IMPLIED WARRANTIES OF MERCHANTABILITY, FITNESS FOR A PARTICULAR PURPOSE OR NON-INFRINGEMENT OF THIRD PARTY INTELLECTUAL PROPERTY RIGHTS.

These resources are intended for skilled developers designing with TI products. You are solely responsible for (1) selecting the appropriate TI products for your application, (2) designing, validating and testing your application, and (3) ensuring your application meets applicable standards, and any other safety, security, regulatory or other requirements.

These resources are subject to change without notice. TI grants you permission to use these resources only for development of an application that uses the TI products described in the resource. Other reproduction and display of these resources is prohibited. No license is granted to any other TI intellectual property right or to any third party intellectual property right. TI disclaims responsibility for, and you fully indemnify TI and its representatives against any claims, damages, costs, losses, and liabilities arising out of your use of these resources.

TI's products are provided subject to [TI's Terms of Sale](#), [TI's General Quality Guidelines](#), or other applicable terms available either on [ti.com](http://ti.com) or provided in conjunction with such TI products. TI's provision of these resources does not expand or otherwise alter TI's applicable warranties or warranty disclaimers for TI products. Unless TI explicitly designates a product as custom or customer-specified, TI products are standard, catalog, general purpose devices.

TI objects to and rejects any additional or different terms you may propose.

Copyright © 2026, Texas Instruments Incorporated

Last updated 10/2025