

LM3940 1-A Low-Dropout Regulator for 5-V to 3.3-V Conversion

1 Features

- Input Voltage Range: 4.5 V to 5.5 V
- Output Voltage Specified over Temperature
- Excellent Load Regulation
- Specified 1-A Output Current
- Requires only One External Component
- Built-in Protection against Excess Temperature
- Short-Circuit Protected

2 Applications

- Laptop and Desktop Computers
- Logic Systems

3 Description

The LM3940 is a 1-A low-dropout regulator designed to provide 3.3 V from a 5-V supply.

The LM3940 is ideally suited for systems which contain both 5-V and 3.3-V logic, with prime power provided from a 5-V bus.

Because the LM3940 is a true low dropout regulator, it can hold its 3.3-V output in regulation with input voltages as low as 4.5 V.

The TO-220 package of the LM3940 means that in most applications the full 1 A of load current can be delivered without using an additional heatsink.

The surface mount DDPAK/TO-263 package uses minimum board space, and gives excellent power dissipation capability when soldered to a copper plane on the PC board.

Device Information⁽¹⁾

PART NUMBER	PACKAGE	BODY SIZE (NOM)
LM3940	SOT-223 (4)	6.50 mm x 3.50 mm
	DDPAK/TO-263 (3)	10.18 mm x 8.41 mm
	TO-220 (3)	14.986 mm x 10.16 mm

(1) For all available packages, see the orderable addendum at the end of the datasheet.

Simplified Schematic

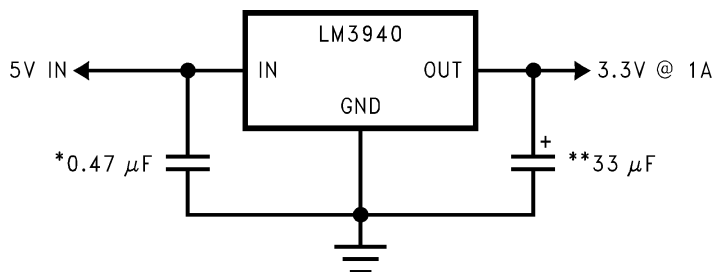

*Required if regulator is located more than 1 inch from the power supply filter capacitor or if battery power is used.

**See [Application and Implementation](#).



Table of Contents

<p>1 Features 1</p> <p>2 Applications 1</p> <p>3 Description 1</p> <p>4 Revision History..... 2</p> <p>5 Pin Configuration and Functions 3</p> <p>6 Specifications..... 4</p> <p> 6.1 Absolute Maximum Ratings 4</p> <p> 6.2 ESD Ratings..... 4</p> <p> 6.3 Recommended Operating Conditions..... 4</p> <p> 6.4 Thermal Information 4</p> <p> 6.5 Electrical Characteristics..... 5</p> <p> 6.6 Typical Characteristics 6</p> <p>7 Detailed Description 8</p> <p> 7.1 Overview 8</p> <p> 7.2 Functional Block Diagram 8</p> <p> 7.3 Feature Description..... 8</p> <p> 7.4 Device Functional Modes..... 8</p>	<p>8 Application and Implementation 9</p> <p> 8.1 Application Information..... 9</p> <p> 8.2 Typical Application 9</p> <p>9 Power Supply Recommendations 11</p> <p>10 Layout..... 11</p> <p> 10.1 Layout Guidelines 11</p> <p> 10.2 Layout Example 11</p> <p> 10.3 Heatsinking 11</p> <p>11 Device and Documentation Support 15</p> <p> 11.1 Documentation Support 15</p> <p> 11.2 Receiving Notification of Documentation Updates 15</p> <p> 11.3 Community Resources..... 15</p> <p> 11.4 Trademarks 15</p> <p> 11.5 Electrostatic Discharge Caution..... 15</p> <p> 11.6 Glossary 15</p> <p>12 Mechanical, Packaging, and Orderable Information 15</p>
--	---

4 Revision History

NOTE: Page numbers for previous revisions may differ from page numbers in the current version.

Changes from Revision F (November 2014) to Revision G	Page
• Changed pin names to TI nomenclature	1
• Deleted soldering information from Ab Max; this info is in POA	4
• Changed <i>Handling Ratings</i> table to <i>ESD Ratings</i> table; move storage temp to <i>Ab Max</i>	4
• Changed values in Input supply voltage row, ROC table	4
• Changed I_L to I_{OUT}	5

Changes from Revision E (March 2013) to Revision F	Page
• Added <i>Device Information</i> and <i>Handling Rating</i> tables, <i>Feature Description</i> , <i>Device Functional Modes</i> , <i>Application and Implementation</i> , <i>Power Supply Recommendations</i> , <i>Layout</i> , <i>Device and Documentation Support</i> , and <i>Mechanical, Packaging, and Orderable Information</i> sections; moved some curves to <i>Application Curves</i> section; update thermal values	1

Changes from Revision D (March 2013) to Revision E	Page
• Changed layout of National Data Sheet to TI format	14

5 Pin Configuration and Functions

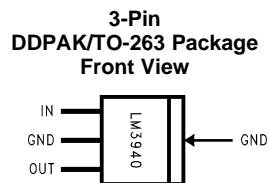
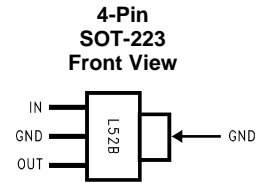
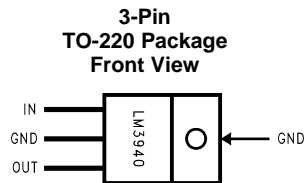

Pin Functions

NAME	PIN			I/O	DESCRIPTION
	TO-220	TO-263	SOT-223		
IN	1	1	1	I	Input voltage supply. A 0.47- μ F capacitor should be connected at this input.
GND	2	2	2, 4	—	Common ground
OUT	3	3	3	O	Output voltage. A 33- μ F low ESR capacitor should be connected to this pin.

6 Specifications

6.1 Absolute Maximum Ratings

over operating free-air temperature range (unless otherwise noted)⁽¹⁾

	MIN	MAX	UNIT
Power dissipation ⁽²⁾		Internally Limited	
Input supply voltage	-0.3	7.5	V
Storage temperature, T_{stg}	-65	150	°C

- (1) Stresses beyond those listed under *Absolute Maximum Ratings* may cause permanent damage to the device. These are stress ratings only, which do not imply functional operation of the device at these or any other conditions beyond those indicated under *Recommended Operating Conditions*. Exposure to absolute-maximum-rated conditions for extended periods may affect device reliability.
- (2) The maximum allowable power dissipation is a function of the maximum junction temperature, T_J , the junction-to-ambient thermal resistance, $R_{\theta JA}$, and the ambient temperature, T_A . Exceeding the maximum allowable power dissipation will cause excessive die temperature, and the regulator will go into thermal shutdown. The value of $R_{\theta JA}$ (for devices in still air with no heatsink) is 23.3°C/W for the TO-220 package, 40.9°C/W for the DPAK/TO-263 package, and 59.3°C/W for the SOT-223 package. The effective value of $R_{\theta JA}$ can be reduced by using a heatsink (see [Heatsinking](#) for specific information on heatsinking).

6.2 ESD Ratings

		VALUE	UNIT
$V_{(ESD)}$ Electrostatic discharge	Human-body model (HBM), per ANSI/ESDA/JEDEC JS-001 ⁽¹⁾	±2000	V
	Charged-device model (CDM), per JEDEC specification JESD22-C101 ⁽²⁾	±500	

- (1) JEDEC document JEP155 states that 500-V HBM allows safe manufacturing with a standard ESD control process.
- (2) JEDEC document JEP157 states that 250-V CDM allows safe manufacturing with a standard ESD control process.

6.3 Recommended Operating Conditions

over operating free-air temperature range (unless otherwise noted)

	MIN	MAX	UNIT
Junction temperature, T_J	-40	125	°C
Input supply voltage, V_{IN}	4.5	5.5	V

6.4 Thermal Information

THERMAL METRIC ⁽¹⁾	LM3940			UNIT
	SOT-223 (DCY)	TO-263 (KTT)	TO-220 (NDE)	
	4 PINS	3 PINS	3 PINS	
$R_{\theta JA}$ Junction-to-ambient thermal resistance, High-K	59.3	40.9	23.3	°C/W
$R_{\theta JC(top)}$ Junction-to-case (top) thermal resistance	38.9	43.5	16.1	°C/W
$R_{\theta JB}$ Junction-to-board thermal resistance	8.1	23.5	4.8	°C/W
ψ_{JT} Junction-to-top characterization parameter	1.7	10.3	2.7	°C/W
ψ_{JB} Junction-to-board characterization parameter	8.0	22.5	4.8	°C/W
$R_{\theta JC(bot)}$ Junction-to-case (bottom) thermal resistance	n/a	0.8	1.1	°C/W

- (1) For more information about traditional and new thermal metrics, see the *IC Package Thermal Metrics* application report, [SPRA953](#).

6.5 Electrical Characteristics

Over operating free-air temperature range, $V_{IN} = 5\text{ V}$, $I_{OUT} = 1\text{ A}$, $C_{OUT} = 33\text{ }\mu\text{F}$ (unless otherwise noted). Limits apply for $T_J = 25^\circ\text{C}$, unless otherwise specified in the Test Conditions column.⁽¹⁾

PARAMETER	TEST CONDITIONS	MIN	TYP	MAX	UNIT	
V_{OUT}	Output voltage	$5\text{ mA} \leq I_{OUT} \leq 1\text{ A}$, $T_J = 25^\circ\text{C}$	3.20	3.3	3.40	V
		$5\text{ mA} \leq I_{OUT} \leq 1\text{ A}$, $-40^\circ\text{C} \leq T_J \leq 125^\circ\text{C}$	3.13		3.47	
$\frac{\Delta V_{OUT}}{\Delta V_{IN}}$	Line regulation	$I_{OUT} = 5\text{ mA}$ $4.5\text{ V} \leq V_{IN} \leq 5.5\text{ V}$		20	40	mV
$\frac{\Delta V_{OUT}}{\Delta I_{OUT}}$	Load regulation	$50\text{ mA} \leq I_{OUT} \leq 1\text{ A}$, $T_J = 25^\circ\text{C}$		35	50	
		$50\text{ mA} \leq I_{OUT} \leq 1\text{ A}$, $-40^\circ\text{C} \leq T_J \leq 125^\circ\text{C}$		35	80	
Z_{OUT}	Output impedance	$I_{OUT}(\text{DC}) = 100\text{ mA}$ $I_{OUT}(\text{AC}) = 20\text{ mA (rms)}$ $f = 120\text{ Hz}$		35		m Ω
I_Q	Quiescent current	$4.5\text{ V} \leq V_{IN} \leq 5.5\text{ V}$, $I_{OUT} = 5\text{ mA}$, $T_J = 25^\circ\text{C}$		10	15	mA
		$4.5\text{ V} \leq V_{IN} \leq 5.5\text{ V}$, $I_{OUT} = 5\text{ mA}$, $-40^\circ\text{C} \leq T_J \leq 125^\circ\text{C}$		10	20	
		$V_{IN} = 5\text{ V}$, $I_{OUT} = 1\text{ A}$, $T_J = 25^\circ\text{C}$		110	200	
		$V_{IN} = 5\text{ V}$, $I_{OUT} = 1\text{ A}$, $-40^\circ\text{C} \leq T_J \leq 125^\circ\text{C}$		110	250	
e_n	Output noise voltage	$f_{BW} = 10\text{ Hz} - 100\text{ kHz}$ $I_{OUT} = 5\text{ mA}$		150		$\mu\text{V}_{(rms)}$
V_{DO}	Dropout voltage ⁽²⁾	$I_{OUT} = 1\text{ A}$, $T_J = 25^\circ\text{C}$		0.5	0.8	V
		$I_{OUT} = 1\text{ A}$, $-40^\circ\text{C} \leq T_J \leq 125^\circ\text{C}$		0.5	1	
		$I_{OUT} = 100\text{ mA}$, $T_J = 25^\circ\text{C}$		110	150	mV
		$I_{OUT} = 100\text{ mA}$, $-40^\circ\text{C} \leq T_J \leq 125^\circ\text{C}$		110	200	
$I_{OUT(SC)}$	Short-circuit current	$R_L = 0$	1.2	1.7		A

- (1) All limits specified for $T_J = 25^\circ\text{C}$ are 100% tested and are used to calculate Outgoing Quality Levels. All limits at temperature extremes are verified via correlation using standard Statistical Quality Control (SQC) methods.
- (2) Dropout voltage is defined as the input-output differential voltage where the regulator output drops to a value that is 100 mV below the value that is measured at $V_{IN} = 5\text{ V}$.

6.6 Typical Characteristics

At $T_J=25^\circ\text{C}$, unless otherwise noted.

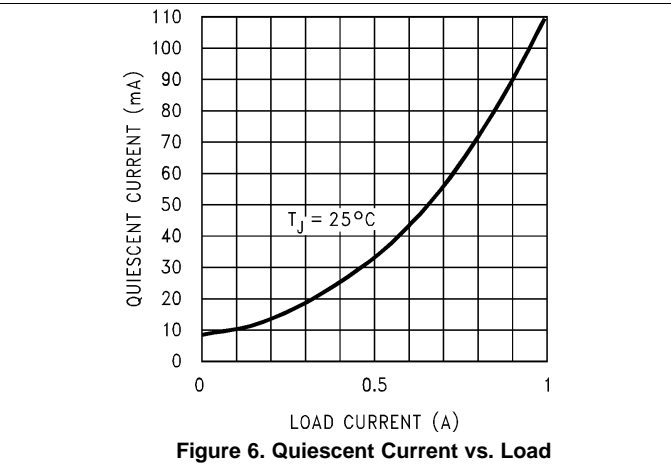
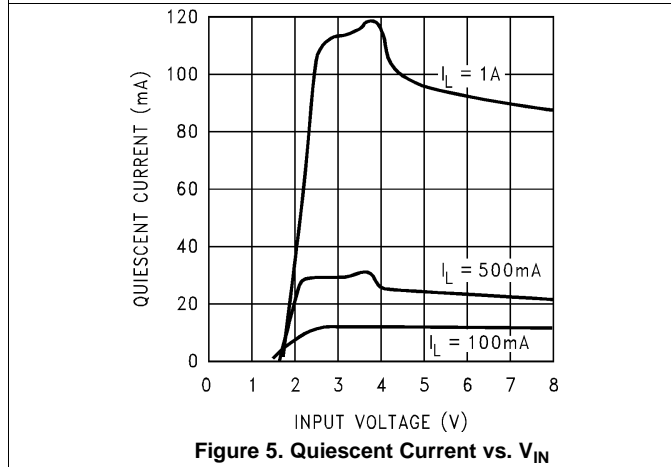
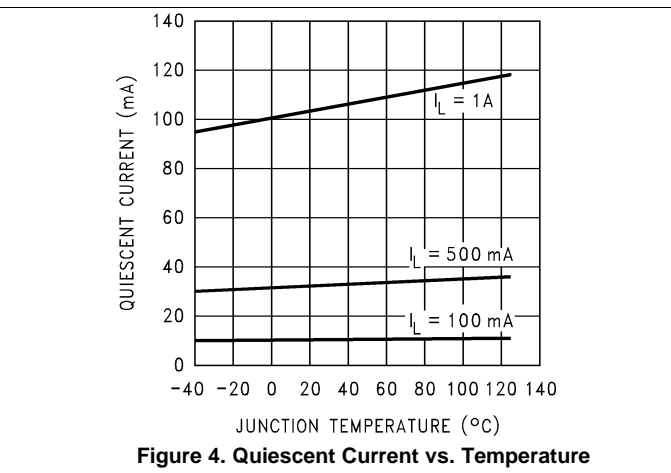
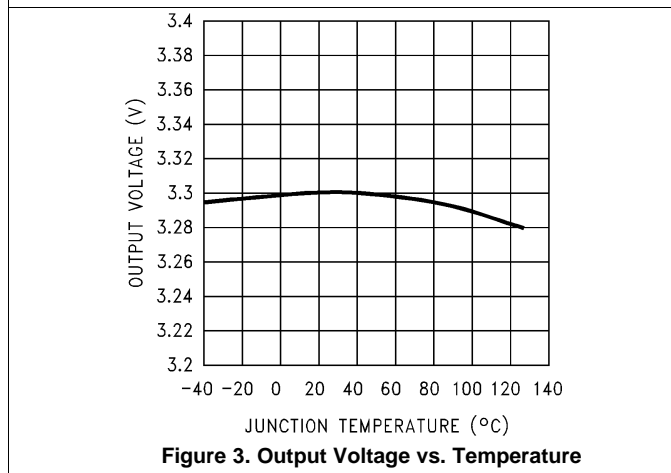
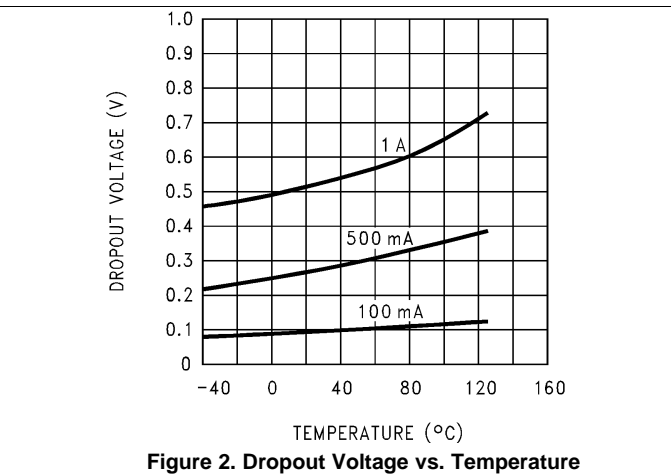
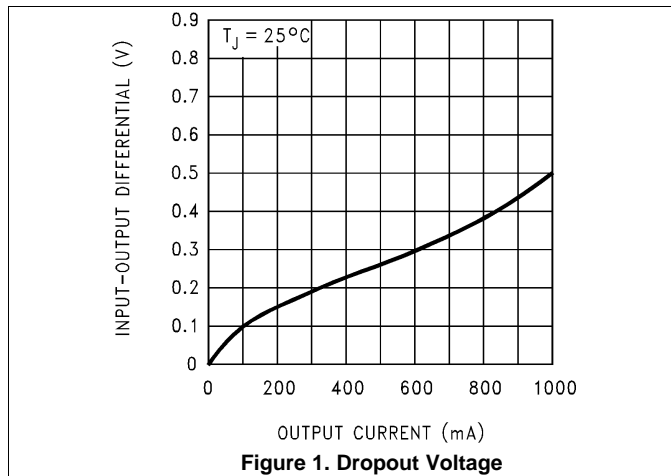

Typical Characteristics (continued)

At $T_j=25^\circ\text{C}$, unless otherwise noted.

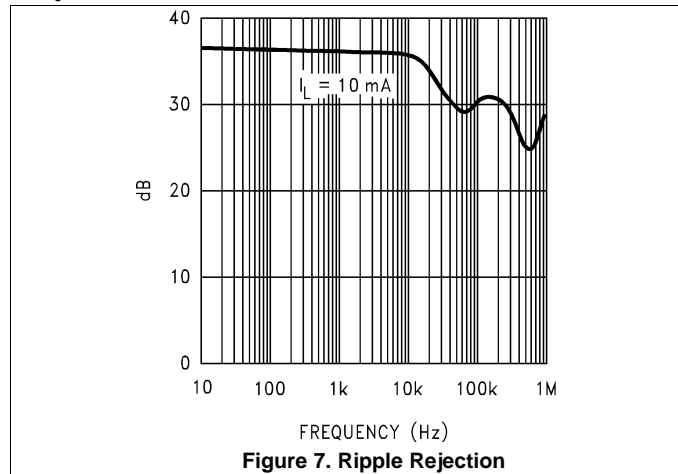

Figure 7. Ripple Rejection

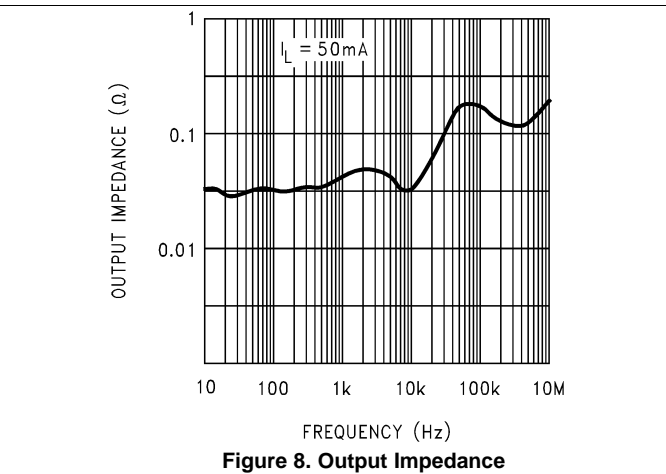

Figure 8. Output Impedance

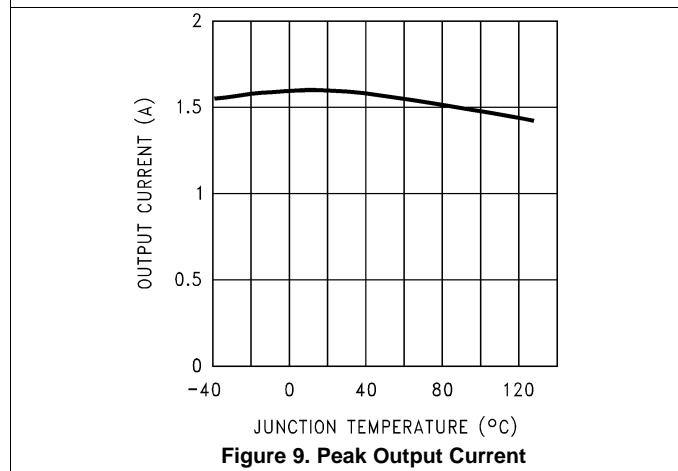

Figure 9. Peak Output Current

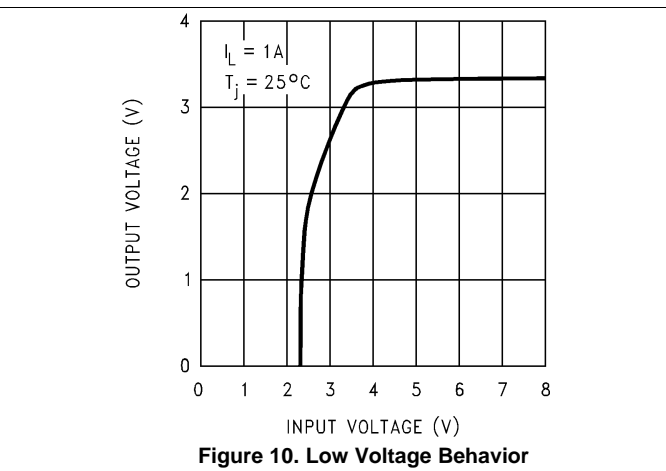

Figure 10. Low Voltage Behavior

7 Detailed Description

7.1 Overview

The LM3940 is a low dropout regulator capable of sourcing a 1-A load. The LM3940 provides 3.3 V from 5-V supply. LM3940 is ideally suited for system which contain both 5-V and 3.3-V logic, with prime power provided from a 5-V bus.

7.2 Functional Block Diagram

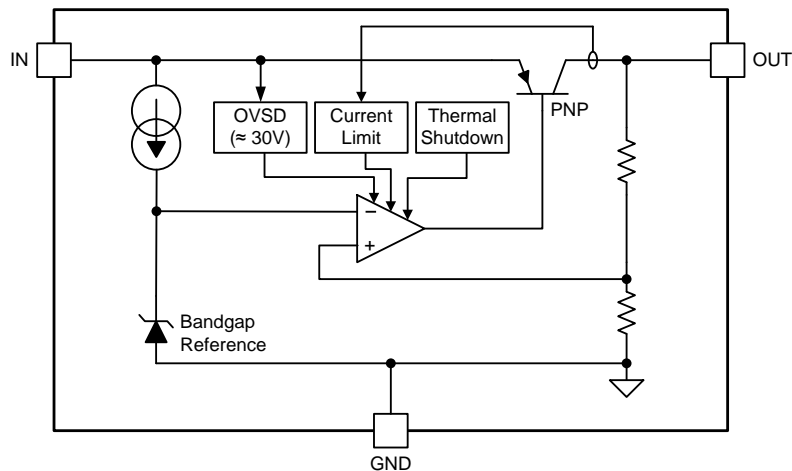

7.3 Feature Description

7.3.1 Output Voltage Accuracy

Output voltage accuracy specifies minimum and maximum output voltage error, relative to the expected nominal output voltage. This accuracy error includes the errors introduced by line and load regulation across the full range of rated load and line operating conditions, unless otherwise specified by the [Electrical Characteristics](#).

7.3.2 Short-Circuit Protection

The internal current limit circuit is used to protect the LDO against high-load current faults or shorting events. During a current-limit event, the LDO sources constant current. Therefore, the output voltage falls when load impedance decreases. Note also that if a current limit occurs and the resulting output voltage is low, excessive power may be dissipated across the LDO, resulting in a thermal shutdown of the output.

7.3.3 Thermal Protection

The LM3940 contains a thermal shutdown protection circuit to turn off the output current when excessive heat is dissipated in the LDO. The thermal time-constant of the semiconductor die is fairly short, and thus the output cycles on and off at a high rate when thermal shutdown is reached until the power dissipation is reduced.

The internal protection circuit of LM3940 is designed to protect against thermal overload conditions. The circuit is not intended to replace proper heat sinking. Continuously running the device into thermal shutdown degrades its reliability.

7.4 Device Functional Modes

7.4.1 Operation with $V_{IN} = 5\text{ V}$

The device operates at input voltage is 5 V and output voltage is 3.3 V. The LM3940 is a true low dropout regulator, it can hold its 3.3-V output in regulation with input voltages as low as 4.5 V.

8 Application and Implementation

NOTE

Information in the following applications sections is not part of the TI component specification, and TI does not warrant its accuracy or completeness. TI's customers are responsible for determining suitability of components for their purposes. Customers should validate and test their design implementation to confirm system functionality.

8.1 Application Information

The LM3940 is a linear voltage regulator operating from 5 V on the input and regulates voltage to 3.3V with 1-A maximum output current. This device is suited for system which contain both 5-V and 3.3-V logic, with prime power provided from a 5-V bus.

8.2 Typical Application

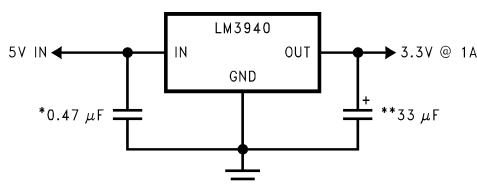

*Required if regulator is located more than 1" from the power supply filter capacitor or if battery power is used.

**See [Detailed Design Procedure](#).

Figure 11. Typical Application

8.2.1 Design Requirements

DESIGN PARAMETER	EXAMPLE VALUE
Input voltage	5 V, $\pm 10\%$
Output voltage	3.3 V, $\pm 3\%$
Output current	1 A

8.2.2 Detailed Design Procedure

8.2.2.1 External Capacitors

The output capacitor is critical to maintaining regulator stability, and must meet the required conditions for both equivalent series resistance (ESR) and minimum amount of capacitance.

8.2.2.1.1 Minimum Capacitance

The minimum output capacitance required to maintain stability is 33 μF (this value may be increased without limit). Larger values of output capacitance will give improved transient response.

8.2.2.1.2 ESR Limits

The ESR of the output capacitor will cause loop instability if it is too high or too low. The acceptable range of ESR plotted versus load current is shown in [Figure 12](#). *It is essential that the output capacitor meet these requirements, or oscillations can result.*

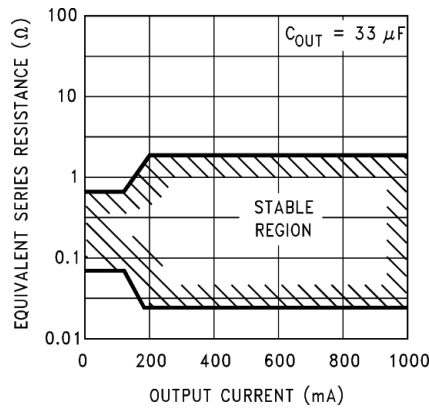

Figure 12. ESR Limits

It is important to note that for most capacitors, ESR is specified only at room temperature. However, the designer must ensure that the ESR will stay inside the limits shown over the entire operating temperature range for the design.

For aluminum electrolytic capacitors, ESR will increase by about 30X as the temperature is reduced from 25°C to -40°C. This type of capacitor is not well-suited for low temperature operation.

Solid tantalum capacitors have a more stable ESR over temperature, but are more expensive than aluminum electrolytics. A cost-effective approach sometimes used is to parallel an aluminum electrolytic with a solid tantalum, with the total capacitance split about 75/25% with the aluminum being the larger value.

If two capacitors are paralleled, the effective ESR is the parallel of the two individual values. The “flatter” ESR of the Tantalum will keep the effective ESR from rising as quickly at low temperatures.

8.2.3 Application Curves

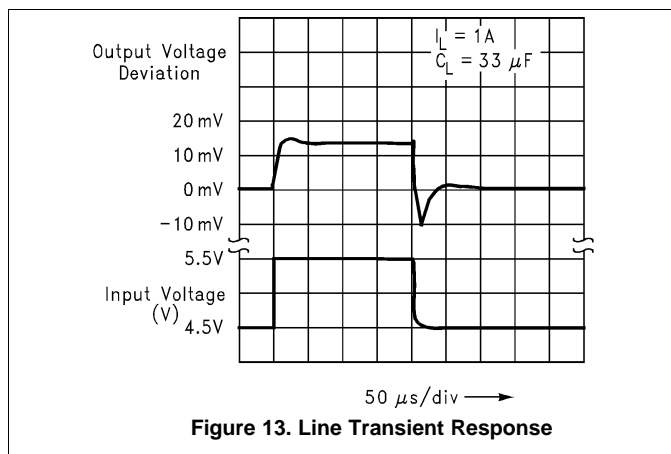

Figure 13. Line Transient Response

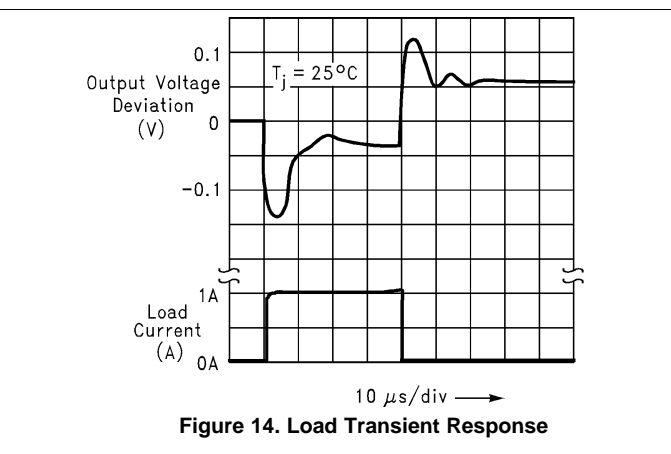

Figure 14. Load Transient Response

9 Power Supply Recommendations

The LM3940 is designed to operate from an 5-V input voltage supply. This input supply must be well regulated. If the input supply is noisy, additional input capacitors with low ESR can help improve the output noise performance.

10 Layout

10.1 Layout Guidelines

For best overall performance, place all the circuit components on the same side of the circuit board and as near as practical to the respective LDO pin connections. Place ground return connections to the input and output capacitor, and to the LDO ground pin as close to each other as possible, connected by a wide, component-side, copper surface. The use of vias and long traces to create LDO circuit connections is strongly discouraged and negatively affects system performance. This grounding and layout scheme minimizes inductive parasitic, and thereby reduces load-current transients, minimizes noise, and increases circuit stability.

A ground reference plane is also recommended and is either embedded in the PCB itself or located on the bottom side of the PCB opposite the components. This reference plane serves to assure accuracy of the output voltage, shield noise, and behaves similar to a thermal plane to spread heat from the LDO device. In most applications, this ground plane is necessary to meet thermal requirements.

10.2 Layout Example

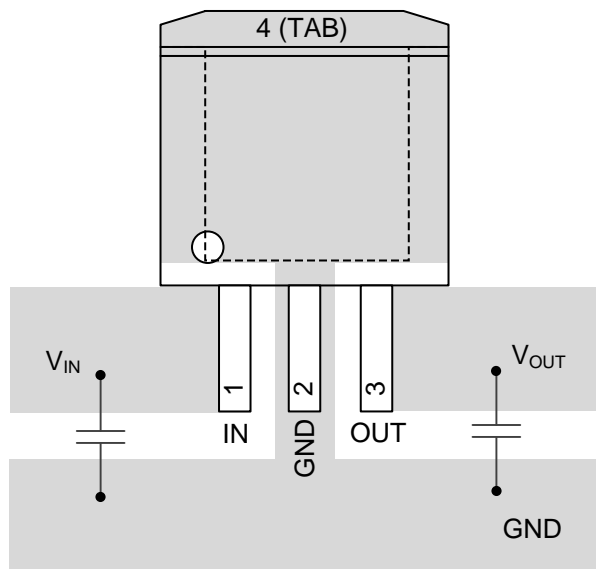

Figure 15. LM3940 Layout Example

10.3 Heatsinking

A heatsink may be required depending on the maximum power dissipation and maximum ambient temperature of the application. Under all possible operating conditions, the junction temperature must be within the range specified under [Absolute Maximum Ratings](#).

To determine if a heatsink is required, the power dissipated by the regulator, P_D , must be calculated.

Figure 16 shows the voltages and currents which are present in the circuit, as well as the formula for calculating the power dissipated in the regulator:

Heatsinking (continued)

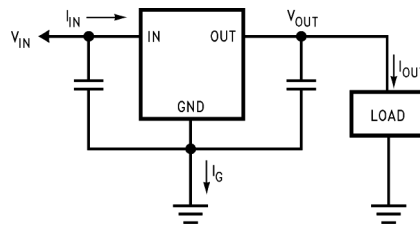

$$I_{IN} = I_{OUT} + I_G$$

$$P_D = (V_{IN} - V_{OUT}) I_{OUT} + (V_{IN}) I_G$$

Figure 16. Power Dissipation Diagram

The next parameter which must be calculated is the maximum allowable temperature rise, $T_R(\text{max})$. This is calculated by using the formula:

$$T_R(\text{max}) = T_J(\text{max}) - T_A(\text{max})$$

Where: $T_J(\text{max})$ is the maximum allowable junction temperature, which is 125°C for commercial grade parts.

$T_A(\text{max})$ is the maximum ambient temperature which will be encountered in the application.

Using the calculated values for $T_R(\text{max})$ and P_D , the maximum allowable value for the junction-to-ambient thermal resistance, $R_{\theta(JA)}$, can now be found:

$$R_{\theta(JA)} = T_R(\text{max})/P_D$$

IMPORTANT: If the maximum allowable value for $\theta_{(JA)}$ is found to be $\geq 23.3^\circ\text{C/W}$ for the TO-220 package, $\geq 40.9^\circ\text{C/W}$ for the DDPAK/TO-263 package, or $\geq 59.3^\circ\text{C/W}$ for the SOT-223 package, no heatsink is needed since the package alone will dissipate enough heat to satisfy these requirements.

If the calculated value for $\theta_{(JA)}$ falls below these limits, a heatsink is required.

10.3.1 Heatsinking TO-220 Package Parts

The TO-220 can be attached to a typical heatsink, or secured to a copper plane on a PC board. If a copper plane is to be used, the values of $R_{\theta(JA)}$ will be the same as shown in the [Heatsinking DDPAK/TO-263 and SOT-223 Package Parts](#) section for the DDPAK/TO-263.

If a manufactured heatsink is to be selected, the value of heatsink-to-ambient thermal resistance, $R_{\theta(H-A)}$, must first be calculated:

$$R_{\theta(H-A)} = R_{\theta(JA)} - R_{\theta(C-H)} - R_{\theta(J-C)}$$

Where: $R_{\theta(J-C)}$ is defined as the thermal resistance from the junction to the surface of the case. A value of 4°C/W can be assumed for $\theta_{(J-C)}$ for this calculation.

$R_{\theta(C-H)}$ is defined as the thermal resistance between the case and the surface of the heatsink. The value of $\theta_{(C-H)}$ will vary from about 1.5°C/W to about 2.5°C/W (depending on method of attachment, insulator, etc.). If the exact value is unknown, 2°C/W should be assumed for $\theta_{(C-H)}$.

When a value for $R_{\theta(H-A)}$ is found using the equation shown above, *a heatsink must be selected that has a value that is less than or equal to this number.*

$R_{\theta(H-A)}$ is specified numerically by the heatsink manufacturer in the catalog, or shown in a curve that plots temperature rise vs. power dissipation for the heatsink.

10.3.2 Heatsinking DDPAK/TO-263 and SOT-223 Package Parts

Both the DDPAK/TO-263 (KTT) and SOT-223 (DCY) packages use a copper plane on the PCB and the PCB itself as a heatsink. To optimize the heat sinking ability of the plane and PCB, solder the tab of the package to the plane.

Figure 17 shows for the DDPAK/TO-263 the measured values of $R_{\theta(JA)}$ for different copper area sizes using a typical PCB with 1 ounce copper and no solder mask over the copper area used for heatsinking.

Heatsinking (continued)

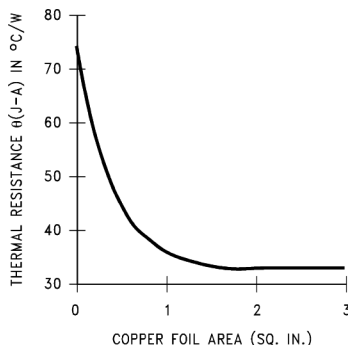

Figure 17. $R_{\theta(JA)}$ vs. Copper (1 ounce) Area for the DDPAK/TO-263 Package

As shown in Figure 17, increasing the copper area beyond 1 square inch produces very little improvement. It should also be observed that the minimum value of $R_{\theta(JA)}$ for the DDPAK/TO-263 package mounted to a PCB is 32°C/W.

As a design aid, Figure 18 shows the maximum allowable power dissipation compared to ambient temperature for the DDPAK/TO-263 device (assuming $R_{\theta(JA)}$ is 35°C/W and the maximum junction temperature is 125°C).

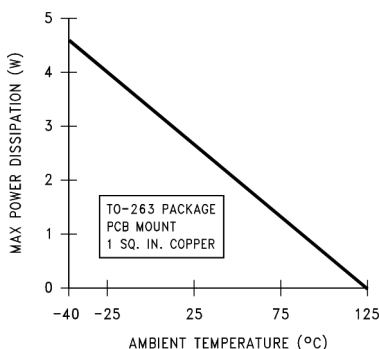

Figure 18. Maximum Power Dissipation vs. T_{AMB} for the DDPAK/TO-263 Package

Figure 19 and Figure 20 show the information for the SOT-223 package. Figure 20 assumes a $R_{\theta(JA)}$ of 74°C/W for 1 ounce copper and 51°C/W for 2 ounce copper and a maximum junction temperature of 125°C.

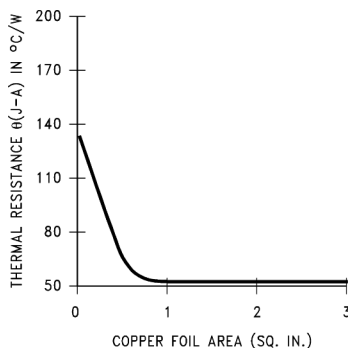

Figure 19. $R_{\theta(JA)}$ vs. Copper (2 ounce) Area for the SOT-223 Package

Heatsinking (continued)

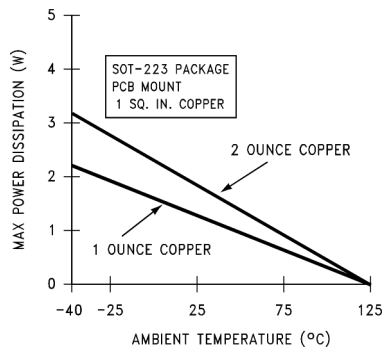

Figure 20. Maximum Power Dissipation vs. T_{AMB} for the SOT-223 Package

Please see *AN-1028 Maximum Power Enhancement Techniques for Power Packages*, [SNVA036](#) for power enhancement techniques to be used with the SOT-223 package.

11 Device and Documentation Support

11.1 Documentation Support

11.1.1 Related Documentation

For related documentation see the following:

AN-1028 Maximum Power Enhancement Techniques for Power Packages, [SNVA036](#)

11.2 Receiving Notification of Documentation Updates

To receive notification of documentation updates, navigate to the device product folder on ti.com. In the upper right corner, click on *Alert me* to register and receive a weekly digest of any product information that has changed. For change details, review the revision history included in any revised document.

11.3 Community Resources

The following links connect to TI community resources. Linked contents are provided "AS IS" by the respective contributors. They do not constitute TI specifications and do not necessarily reflect TI's views; see TI's [Terms of Use](#).

TI E2E™ Online Community *TI's Engineer-to-Engineer (E2E) Community*. Created to foster collaboration among engineers. At e2e.ti.com, you can ask questions, share knowledge, explore ideas and help solve problems with fellow engineers.

Design Support *TI's Design Support* Quickly find helpful E2E forums along with design support tools and contact information for technical support.

11.4 Trademarks

E2E is a trademark of Texas Instruments.

All other trademarks are the property of their respective owners.

11.5 Electrostatic Discharge Caution



These devices have limited built-in ESD protection. The leads should be shorted together or the device placed in conductive foam during storage or handling to prevent electrostatic damage to the MOS gates.

11.6 Glossary

[SLYZ022](#) — *TI Glossary*.

This glossary lists and explains terms, acronyms, and definitions.

12 Mechanical, Packaging, and Orderable Information

The following pages include mechanical, packaging, and orderable information. This information is the most current data available for the designated devices. This data is subject to change without notice and revision of this document. For browser-based versions of this data sheet, refer to the left-hand navigation.

PACKAGING INFORMATION

Orderable Device	Status (1)	Package Type	Package Drawing	Pins	Package Qty	Eco Plan (2)	Lead finish/ Ball material (6)	MSL Peak Temp (3)	Op Temp (°C)	Device Marking (4/5)	Samples
LM3940IMP-3.3/NOPB	ACTIVE	SOT-223	DCY	4	1000	RoHS & Green	SN	Level-1-260C-UNLIM	-40 to 125	L52B	Samples
LM3940IMPX-3.3/NOPB	ACTIVE	SOT-223	DCY	4	2000	RoHS & Green	SN	Level-1-260C-UNLIM	-40 to 125	L52B	Samples
LM3940IS-3.3/NOPB	ACTIVE	DDPAK/ TO-263	KTT	3	45	RoHS-Exempt & Green	SN	Level-3-245C-168 HR	-40 to 125	LM3940IS -3.3 P+	Samples
LM3940ISX-3.3/NOPB	ACTIVE	DDPAK/ TO-263	KTT	3	500	RoHS-Exempt & Green	SN	Level-3-245C-168 HR	-40 to 125	LM3940IS -3.3 P+	Samples
LM3940IT-3.3/NOPB	ACTIVE	TO-220	NDE	3	45	RoHS & Green	SN	Level-1-NA-UNLIM	-40 to 125	LM3940IT -3.3 P+	Samples

(1) The marketing status values are defined as follows:

ACTIVE: Product device recommended for new designs.

LIFEBUY: TI has announced that the device will be discontinued, and a lifetime-buy period is in effect.

NRND: Not recommended for new designs. Device is in production to support existing customers, but TI does not recommend using this part in a new design.

PREVIEW: Device has been announced but is not in production. Samples may or may not be available.

OBSELETE: TI has discontinued the production of the device.

(2) **RoHS:** TI defines "RoHS" to mean semiconductor products that are compliant with the current EU RoHS requirements for all 10 RoHS substances, including the requirement that RoHS substance do not exceed 0.1% by weight in homogeneous materials. Where designed to be soldered at high temperatures, "RoHS" products are suitable for use in specified lead-free processes. TI may reference these types of products as "Pb-Free".

RoHS Exempt: TI defines "RoHS Exempt" to mean products that contain lead but are compliant with EU RoHS pursuant to a specific EU RoHS exemption.

Green: TI defines "Green" to mean the content of Chlorine (Cl) and Bromine (Br) based flame retardants meet JS709B low halogen requirements of <=1000ppm threshold. Antimony trioxide based flame retardants must also meet the <=1000ppm threshold requirement.

(3) MSL, Peak Temp. - The Moisture Sensitivity Level rating according to the JEDEC industry standard classifications, and peak solder temperature.

(4) There may be additional marking, which relates to the logo, the lot trace code information, or the environmental category on the device.

(5) Multiple Device Markings will be inside parentheses. Only one Device Marking contained in parentheses and separated by a "-" will appear on a device. If a line is indented then it is a continuation of the previous line and the two combined represent the entire Device Marking for that device.

(6) Lead finish/Ball material - Orderable Devices may have multiple material finish options. Finish options are separated by a vertical ruled line. Lead finish/Ball material values may wrap to two lines if the finish value exceeds the maximum column width.

Important Information and Disclaimer: The information provided on this page represents TI's knowledge and belief as of the date that it is provided. TI bases its knowledge and belief on information provided by third parties, and makes no representation or warranty as to the accuracy of such information. Efforts are underway to better integrate information from third parties. TI has taken and continues to take reasonable steps to provide representative and accurate information but may not have conducted destructive testing or chemical analysis on incoming materials and chemicals. TI and TI suppliers consider certain information to be proprietary, and thus CAS numbers and other limited information may not be available for release.

In no event shall TI's liability arising out of such information exceed the total purchase price of the TI part(s) at issue in this document sold by TI to Customer on an annual basis.

TAPE AND REEL INFORMATION

QUADRANT ASSIGNMENTS FOR PIN 1 ORIENTATION IN TAPE

*All dimensions are nominal

Device	Package Type	Package Drawing	Pins	SPQ	Reel Diameter (mm)	Reel Width W1 (mm)	A0 (mm)	B0 (mm)	K0 (mm)	P1 (mm)	W (mm)	Pin1 Quadrant
LM3940IMP-3.3/NOPB	SOT-223	DCY	4	1000	330.0	16.4	7.0	7.5	2.2	12.0	16.0	Q3
LM3940IMPX-3.3/NOPB	SOT-223	DCY	4	2000	330.0	16.4	7.0	7.5	2.2	12.0	16.0	Q3
LM3940ISX-3.3/NOPB	DDPAK/ TO-263	KTT	3	500	330.0	24.4	10.75	14.85	5.0	16.0	24.0	Q2

TAPE AND REEL BOX DIMENSIONS



*All dimensions are nominal

Device	Package Type	Package Drawing	Pins	SPQ	Length (mm)	Width (mm)	Height (mm)
LM3940IMP-3.3/NOPB	SOT-223	DCY	4	1000	367.0	367.0	35.0
LM3940IMPX-3.3/NOPB	SOT-223	DCY	4	2000	367.0	367.0	35.0
LM3940ISX-3.3/NOPB	DDPAK/TO-263	KTT	3	500	356.0	356.0	45.0

TUBE

*All dimensions are nominal

Device	Package Name	Package Type	Pins	SPQ	L (mm)	W (mm)	T (μm)	B (mm)
LM3940IS-3.3/NOPB	KTT	TO-263	3	45	502	25	8204.2	9.19
LM3940IT-3.3/NOPB	NDE	TO-220	3	45	502	33	6985	4.06

NDE0003B

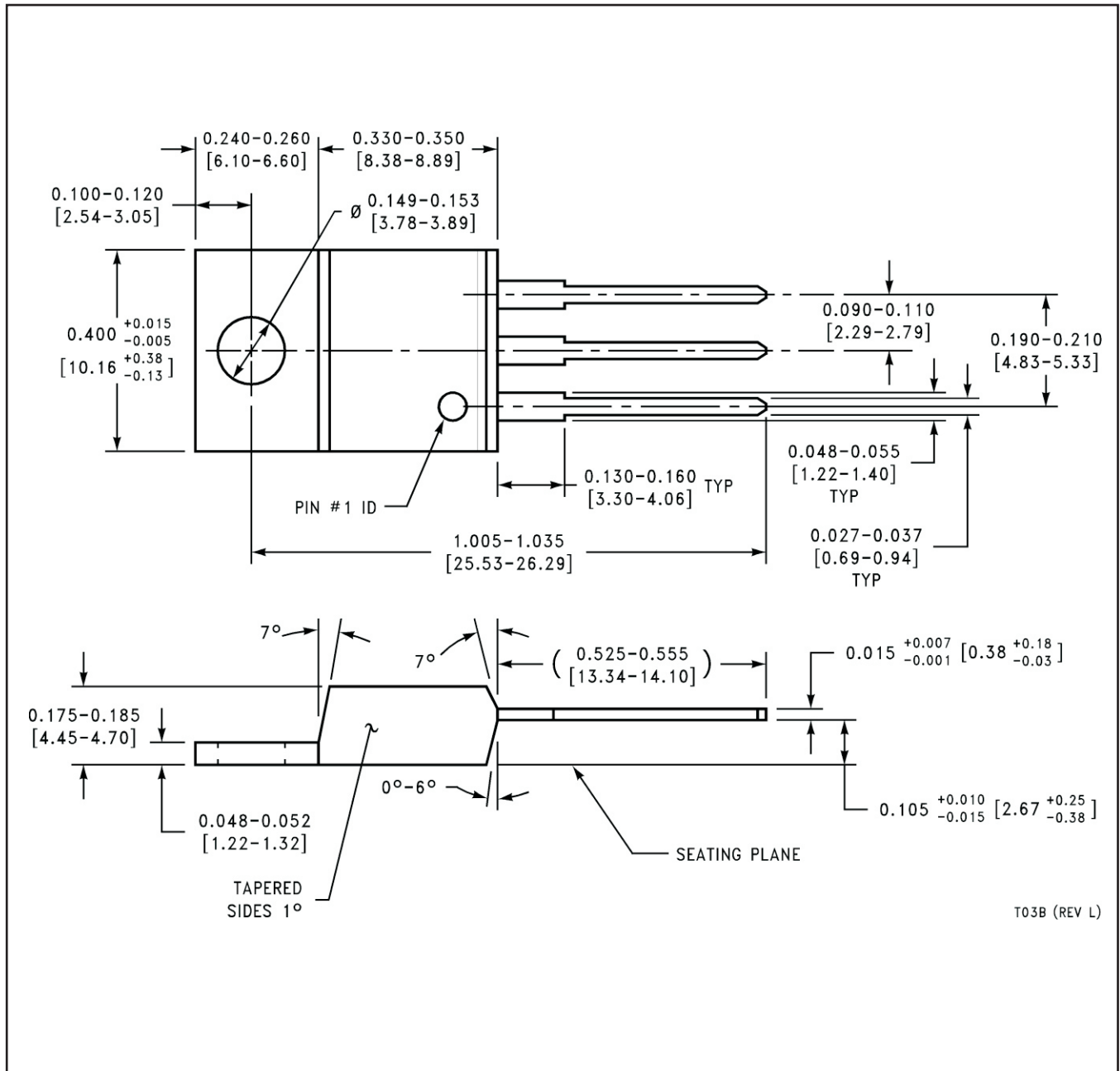

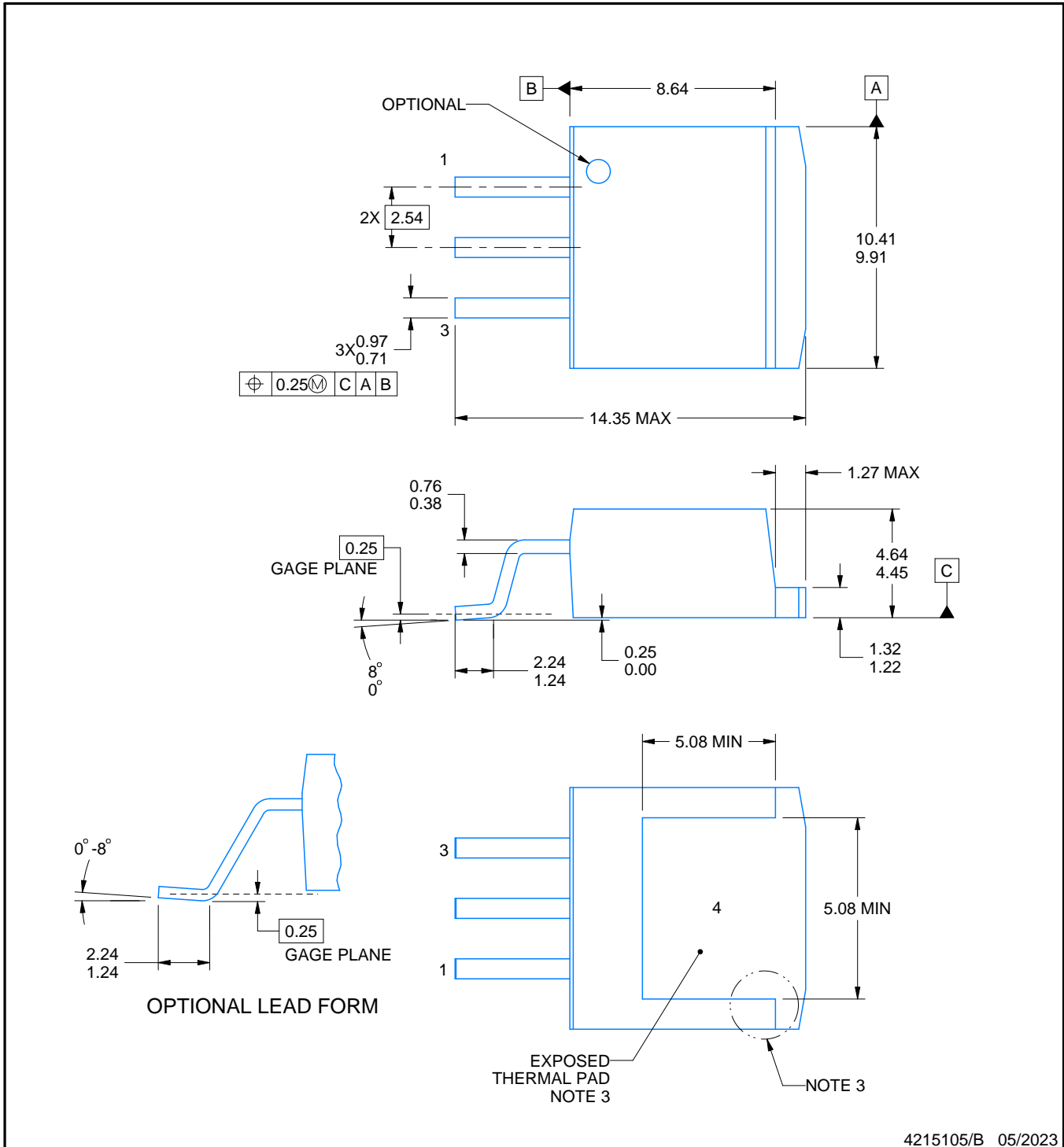

4215105/B 05/2023

NOTES:

1. All linear dimensions are in millimeters. Any dimensions in parenthesis are for reference only. Dimensioning and tolerancing per ASME Y14.5M.
2. This drawing is subject to change without notice.
3. Features may not exist and shape may vary per different assembly sites.
4. Reference JEDEC registration TO-263, except minimum lead thickness and minimum exposed pad length.

EXAMPLE STENCIL DESIGN

KTT0003B

TO-263 - 4.83 mm max height

TO-263

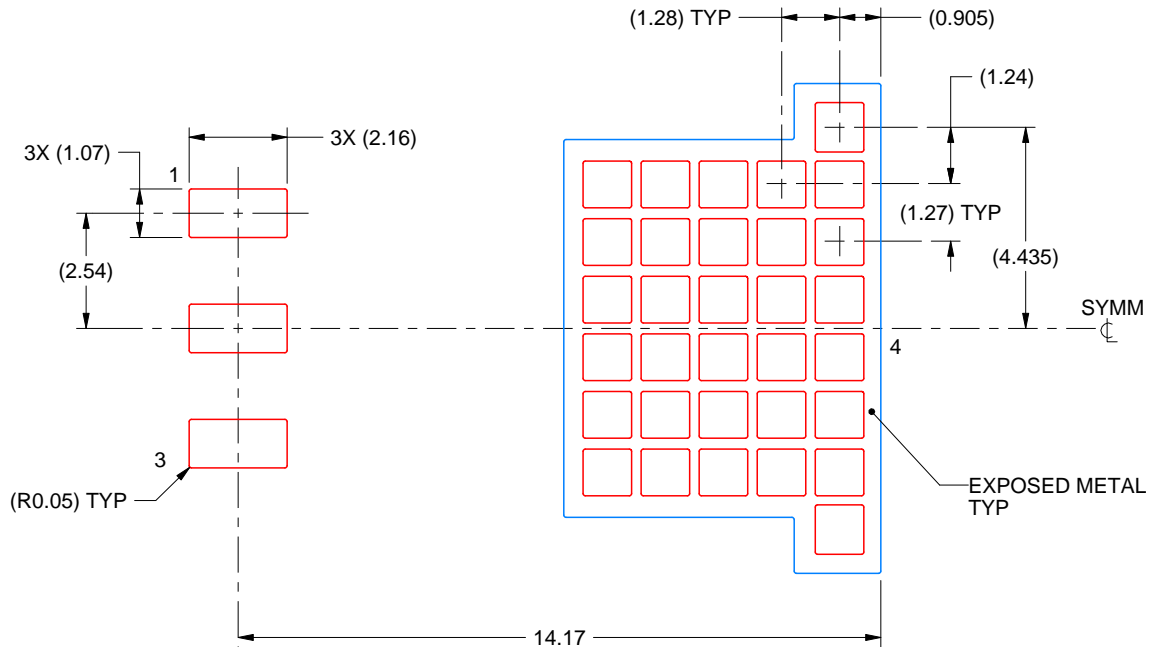

SOLDER PASTE EXAMPLE
BASED ON 0.125 mm THICK STENCIL
EXPOSED PAD
60% PRINTED SOLDER COVERAGE BY AREA
SCALE:6X

4215105/B 05/2023

NOTES: (continued)

7. Laser cutting apertures with trapezoidal walls and rounded corners may offer better paste release. IPC-7525 may have alternate design recommendations.
8. Board assembly site may have different recommendations for stencil design.

DCY (R-PDSO-G4)

PLASTIC SMALL-OUTLINE

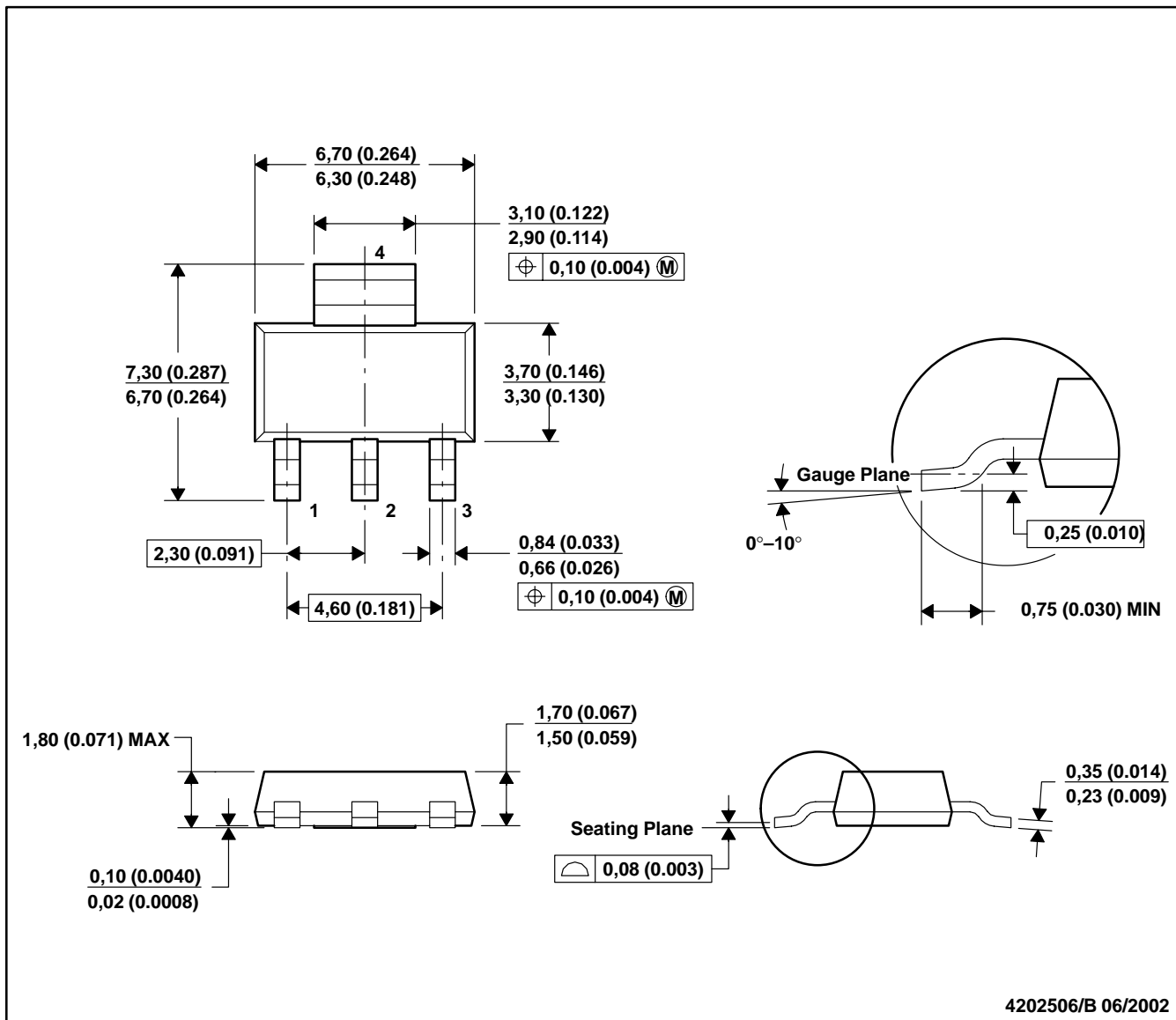

- NOTES: A. All linear dimensions are in millimeters (inches).
 B. This drawing is subject to change without notice.
 C. Body dimensions do not include mold flash or protrusion.
 D. Falls within JEDEC TO-261 Variation AA.

IMPORTANT NOTICE AND DISCLAIMER

TI PROVIDES TECHNICAL AND RELIABILITY DATA (INCLUDING DATA SHEETS), DESIGN RESOURCES (INCLUDING REFERENCE DESIGNS), APPLICATION OR OTHER DESIGN ADVICE, WEB TOOLS, SAFETY INFORMATION, AND OTHER RESOURCES "AS IS" AND WITH ALL FAULTS, AND DISCLAIMS ALL WARRANTIES, EXPRESS AND IMPLIED, INCLUDING WITHOUT LIMITATION ANY IMPLIED WARRANTIES OF MERCHANTABILITY, FITNESS FOR A PARTICULAR PURPOSE OR NON-INFRINGEMENT OF THIRD PARTY INTELLECTUAL PROPERTY RIGHTS.

These resources are intended for skilled developers designing with TI products. You are solely responsible for (1) selecting the appropriate TI products for your application, (2) designing, validating and testing your application, and (3) ensuring your application meets applicable standards, and any other safety, security, regulatory or other requirements.

These resources are subject to change without notice. TI grants you permission to use these resources only for development of an application that uses the TI products described in the resource. Other reproduction and display of these resources is prohibited. No license is granted to any other TI intellectual property right or to any third party intellectual property right. TI disclaims responsibility for, and you will fully indemnify TI and its representatives against, any claims, damages, costs, losses, and liabilities arising out of your use of these resources.

TI's products are provided subject to [TI's Terms of Sale](#) or other applicable terms available either on [ti.com](https://www.ti.com) or provided in conjunction with such TI products. TI's provision of these resources does not expand or otherwise alter TI's applicable warranties or warranty disclaimers for TI products.

TI objects to and rejects any additional or different terms you may have proposed.

Mailing Address: Texas Instruments, Post Office Box 655303, Dallas, Texas 75265
Copyright © 2024, Texas Instruments Incorporated