

LM8262 Dual RRIO, High Output Current and Unlimited Cap Load Op Amp in VSSOP

1 Features

($V_S = 5V$, $T_A = 25^\circ C$, Typical Values Unless Specified).

- GBWP 21MHz
- Wide Supply Voltage Range 2.5 V to 22 V
- Slew Rate 12V/ μs
- Supply Current/channel 1.15 mA
- Cap Load Limit Unlimited
- Output Short Circuit Current +53mA/-75 mA
- +/-5% Settling Time 400ns (500 pF, 100 mV_{PP} step)
- Input Common Mode Voltage 0.3 V Beyond Rails
- Input Voltage Noise 15nV/ \sqrt{Hz}
- Input Current Noise 1pA/ \sqrt{Hz}
- THD+N < 0.05%

2 Applications

- TFT-LCD Flat Panel V_{COM} driver
- A/D Converter Buffer
- High Side/low Side Sensing
- Headphone Amplifier

3 Description

The LM8262 is a Rail-to-Rail input and output Op Amp which can operate with a wide supply voltage range. This device has high output current drive, greater than Rail-to-Rail input common mode voltage range, unlimited capacitive load drive capability, and provides tested and ensured high speed and slew rate. It is specifically designed to handle the requirements of flat panel TFT panel V_{COM} driver applications as well as being suitable for other low power and medium speed applications which require ease of use and enhanced performance over existing devices.

Greater than Rail-to-Rail input common mode voltage range with 50 dB of Common Mode Rejection allows high side and low side sensing for many applications without concern for exceeding the range and with no compromise in accuracy. In addition, most device parameters are insensitive to power supply variations. This design enhancement is yet another step in simplifying its usage. The output stage has low distortion (0.05% THD+N) and can supply a respectable amount of current (15 mA) with minimal headroom from either rail (300 mV).

The LM8262 is offered in the space saving VSSOP package.

Device Information⁽¹⁾

PART NUMBER	PACKAGE	BODY SIZE (NOM)
LM8262	VSSOP (8)	3.00 mm x 3.00 mm

(1) For all available packages, see the orderable addendum at the end of the datasheet.

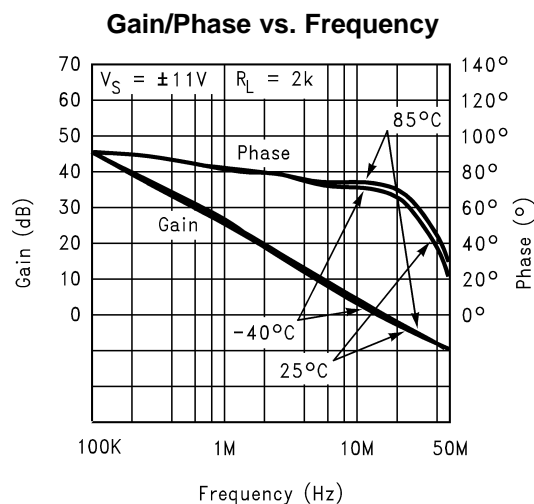

Output Response with Heavy Capacitive Load

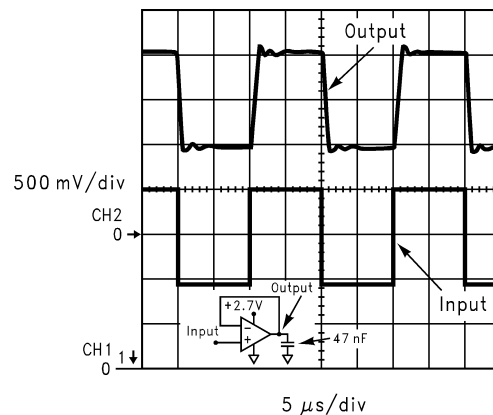

Table of Contents

1 Features	1	6.5 2.7V Electrical Characteristics	5
2 Applications	1	6.6 5V Electrical Characteristics	6
3 Description	1	6.7 +/-11V Electrical Characteristics	7
4 Revision History	2	6.8 Typical Performance Characteristics	9
5 Pin Configuration and Functions	3	7 Device and Documentation Support	12
6 Specifications	4	7.1 Community Resources.....	12
6.1 Absolute Maximum Ratings	4	7.2 Trademarks	12
6.2 ESD Ratings.....	4	7.3 Electrostatic Discharge Caution.....	12
6.3 Recommended Operating Conditions.....	4	7.4 Glossary	12
6.4 Thermal Information	4	8 Mechanical, Packaging, and Orderable Information	12

4 Revision History

NOTE: Page numbers for previous revisions may differ from page numbers in the current version.

Changes from Revision F (August 2014) to Revision G	Page
• Changed pin 5 From: -IN B To: +IN B Non-Inverting Input B in the <i>Pin Functions</i> table.....	3
• Changed pin 6 From: +IN B To: -IN B Inverting Input B in the <i>Pin Functions</i> table.....	3
• Moved "Storage temperature range" to the <i>Absolute Maximum Ratings</i> ⁽¹⁾⁽²⁾	4
• Changed <i>Handling Ratings</i> To: <i>ESD Ratings</i>	4

Changes from Revision E (April 2013) to Revision F	Page
• Changed data sheet structure and organization. Added, updated, or renamed the following sections: Device and Documentation Support; Mechanical, Packaging, and Ordering Information.....	1
• Changed from "Junction Temperature Range" to "Operating Temperature Range"	4
• Deleted T _J = 25°C,	5
• Deleted T _J = 25°C,	6
• Deleted T _J = 25°C.....	7

Changes from Revision D (April 2013) to Revision E	Page
• Changed layout of National Data Sheet to TI format	10

5 Pin Configuration and Functions

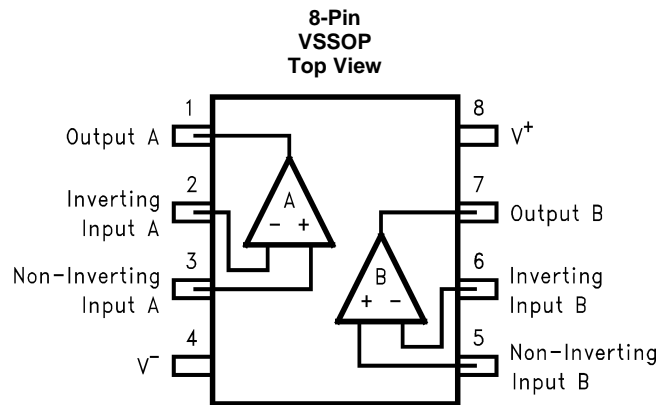

Pin Functions

PIN		I/O	DESCRIPTION
NUMBER	NAME		
1	OUT A	O	Output A
2	-IN A	I	Inverting Input A
3	+IN A	I	Non-Inverting Input A
4	V-	I	Negative Supply
5	+IN B	I	Non-Inverting Input B
6	-IN B	I	Inverting Input B
7	OUT B	O	Output B
8	V+	I	Positive Supply

6 Specifications

6.1 Absolute Maximum Ratings ⁽¹⁾⁽²⁾

 over operating free-air temperature range (unless otherwise noted) ⁽³⁾

	MIN	MAX	UNIT
V _{IN} Differential		+/-10	V
Output Short Circuit Duration		See ⁽⁴⁾ ⁽⁵⁾	
Supply Voltage (V ⁺ - V ⁻)		24	V
Voltage at Input/Output pins	V ⁺ +0.8, V ⁻ -0.8		V
Junction Temperature ⁽⁶⁾		+150	°C
Storage temperature range, T _{stg}	-65	+150	°C
Soldering Information:	Infrared or Convection (20 sec.)	235	°C
	Wave Soldering (10 sec.)	260	°C

- (1) Absolute Maximum Ratings indicate limits beyond which damage to the device may occur. Operating Rating indicate conditions for which the device is intended to be functional, but specific performance is not ensured. For ensured specifications and the test conditions, see the Electrical Characteristics.
- (2) If Military/Aerospace specified devices are required, please contact the TI Sales Office/ Distributors for availability and specifications.
- (3) Stresses beyond those listed under *Absolute Maximum Ratings* may cause permanent damage to the device. These are stress ratings only, which do not imply functional operation of the device at these or any other conditions beyond those indicated under *Recommended Operating Conditions*. Exposure to absolute-maximum-rated conditions for extended periods may affect device reliability.
- (4) Applies to both single-supply and split-supply operation. Continuous short circuit operation at elevated ambient temperature can result in exceeding the maximum allowed junction temperature of 150°C.
- (5) Output short circuit duration is infinite for V_S ≤ 6V at room temperature and below. For V_S > 6V, allowable short circuit duration is 1.5ms.
- (6) The maximum power dissipation is a function of T_J(max), R_{θJA}, and T_A. The maximum allowable power dissipation at any ambient temperature is P_D = (T_J(max) - T_A)/R_{θJA}. All numbers apply for packages soldered directly onto a PC board.

6.2 ESD Ratings

			VALUE	UNIT
V _(ESD)	Electrostatic discharge ⁽¹⁾	Human Body Model (HBM), per ANSI/ESDA/JEDEC JS-001, all pins ⁽²⁾	±2000	V
		Machine Model (MM) ⁽³⁾	±200	

- (1) Human Body Model, 1.5 kΩ in series with 100 pF. Machine Model, 0 Ω in series with 200 pF.
- (2) JEDEC document JEP155 states that 2000-V HBM allows safe manufacturing with a standard ESD control process.
- (3) JEDEC document JEP157 states that 200-V MM allows safe manufacturing with a standard ESD control process.

6.3 Recommended Operating Conditions

over operating free-air temperature range (unless otherwise noted)

	MIN	MAX	UNIT
Supply Voltage (V ⁺ - V ⁻)	2.5	22	V
Operating Temperature Range ⁽¹⁾	-40	+85	°C

- (1) The maximum power dissipation is a function of T_J(max), R_{θJA}, and T_A. The maximum allowable power dissipation at any ambient temperature is P_D = (T_J(max) - T_A)/R_{θJA}. All numbers apply for packages soldered directly onto a PC board.

6.4 Thermal Information

THERMAL METRIC ⁽¹⁾		DGK	UNIT
		8 PINS	
R _{θJA}	Junction-to-ambient thermal resistance ⁽²⁾	235	°C/W

- (1) For more information about traditional and new thermal metrics, see the *IC Package Thermal Metrics* application report, [SPRA953](#).
- (2) The maximum power dissipation is a function of T_J(max), R_{θJA}, and T_A. The maximum allowable power dissipation at any ambient temperature is P_D = (T_J(max) - T_A)/R_{θJA}. All numbers apply for packages soldered directly onto a PC board.

6.5 2.7V Electrical Characteristics

Unless otherwise specified, all limits ensured for $V^+ = 2.7V$, $V^- = 0V$, $V_{CM} = 0.5V$, $V_O = V^+/2$, and $R_L > 1M\Omega$ to V^- . **Boldface** limits apply at the temperature extremes.

PARAMETER		TEST CONDITIONS	MIN ⁽¹⁾	TYP ⁽²⁾	MAX ⁽¹⁾	UNIT
V_{OS}	Input Offset Voltage	$V_{CM} = 0.5V$ & $V_{CM} = 2.2V$	–	+/-0.7	+/-5 +/-7	mV
TC V_{OS}	Input Offset Average Drift	$V_{CM}^{(3)} = 0.5V$ & $V_{CM} = 2.2V$	–	+/-2	–	$\mu V/C$
I_B	Input Bias Current	$V_{CM}^{(4)} = 0.5V$	–	-1.20	-2.00 -2.70	μA
		$V_{CM}^{(4)} = 2.2V$	–	+0.49	+1.00 +1.60	
I_{OS}	Input Offset Current	$V_{CM} = 0.5V$ & $V_{CM} = 2.2V$	–	20	250 400	nA
CMRR	Common Mode Rejection Ratio	V_{CM} stepped from 0V to 1.0V	76 60	100	–	dB
		V_{CM} stepped from 1.7V to 2.7V	–	100	–	
		V_{CM} stepped from 0V to 2.7V	58 50	70	–	
+PSRR	Positive Power Supply Rejection Ratio	$V^+ = 2.7V$ to 5V	78 74	104	–	dB
CMVR	Input Common-Mode Voltage Range	CMRR > 50dB	–	-0.3	-0.1 0.0	V
			2.8 2.7	3.0	–	V
A_{VOL}	Large Signal Voltage Gain	$V_O = 0.5$ to 2.2V, $R_L = 10k$ to V^-	70 67	78	–	dB
		$V_O = 0.5$ to 2.2V, $R_L = 2k$ to V^-	67 63	73	–	dB
V_O	Output Swing High	$R_L = 10k$ to V^-	2.49 2.46	2.59	–	V
		$R_L = 2k$ to V^-	2.45 2.41	2.53	–	
I_{SC}	Output Short Circuit Current	Sourcing to V^- $V_{ID} = 200mV$ ⁽⁵⁾⁽⁶⁾	30 20	48	–	mA
		Sinking to V^+ $V_{ID} = -200mV$ ⁽⁵⁾⁽⁶⁾	50 30	65	–	
I_S	Supply Current (both amps)	No load, $V_{CM} = 0.5V$	–	2.0	2.5 3.0	mA
SR	Slew Rate ⁽⁷⁾	$A_V = +1, V_I = 2V_{PP}$	–	9	–	V/ μs
f_u	Unity Gain-Frequency	$V_I = 10mV, R_L = 2k\Omega$ to $V^+/2$	–	10	–	MHz
GBWP	Gain Bandwidth Product	$f = 50KHz$	15.5 14	21	–	MHz
Φ_{im}	Phase Margin	$V_I = 10mV$	–	50	–	Deg
e_n	Input-Referred Voltage Noise	$f = 2KHz, R_S = 50\Omega$	–	15	–	nV/\sqrt{Hz}
i_n	Input-Referred Current Noise	$f = 2KHz$	–	1	–	pA/\sqrt{Hz}
f_{max}	Full Power Bandwidth	$Z_L = (20pF \parallel 10k\Omega)$ to $V^+/2$	–	1	–	MHz

(1) All limits are ensured by testing or statistical analysis.

(2) Typical Values represent the most likely parametric norm.

(3) Offset voltage average drift determined by dividing the change in V_{OS} at temperature extremes into the total temperature change.

(4) Positive current corresponds to current flowing into the device.

(5) Short circuit test is a momentary test.

(6) Output short circuit duration is infinite for $V_S \leq 6V$ at room temperature and below. For $V_S > 6V$, allowable short circuit duration is 1.5ms.

(7) Slew rate is the slower of the rising and falling slew rates. Connected as a Voltage Follower.

6.6 5V Electrical Characteristics

Unless otherwise specified, all limits ensured for $V^+ = 5V$, $V^- = 0V$, $V_{CM} = 1V$, $V_O = V^+/2$, and $R_L > 1M\Omega$ to V^- . **Boldface** limits apply at the temperature extremes.

PARAMETER		TEST CONDITIONS	MIN ⁽¹⁾	TYP ⁽²⁾	MAX ⁽¹⁾	UNIT
V_{OS}	Input Offset Voltage	$V_{CM} = 1V$ & $V_{CM} = 4.5V$	–	+/-0.7	+/-5 +/- 7	mV
TC V_{OS}	Input Offset Average Drift	$V_{CM} = 1V$ & $V_{CM} = 4.5V$ (3)	–	+/-2	–	$\mu V/^\circ C$
I_B	Input Bias Current	$V_{CM} = 1V$ (4)	–	-1.18	-2.00 -2.70	μA
		$V_{CM} = 4.5V$ (4)	–	+0.49	+1.00 +1.60	
I_{OS}	Input Offset Current	$V_{CM} = 1V$ & $V_{CM} = 4.5V$	–	20	250 400	nA
CMRR	Common Mode Rejection Ratio	V_{CM} stepped from 0V to 3.3V	84 72	110	–	dB
		V_{CM} stepped from 4V to 5V	–	100	–	
		V_{CM} stepped from 0V to 5V	64 61	80	–	
+PSRR	Positive Power Supply Rejection Ratio	$V^+ = 2.7V$ to 5V, $V_{CM} = 0.5V$	78 74	104	–	dB
CMVR	Input Common-Mode Voltage Range	CMRR > 50dB	–	-0.3	-0.1 0.0	V
			5.1 5.0	5.3	–	V
A_{VOL}	Large Signal Voltage Gain	$V_O = 0.5$ to 4.5V, $R_L = 10k$ to V^-	74 70	84	–	dB
		$V_O = 0.5$ to 4.5V, $R_L = 2k$ to V^-	70 66	80	–	
V_O	Output Swing High	$R_L = 10k$ to V^-	4.75 4.72	4.87	–	V
		$R_L = 2k$ to V^-	4.70 4.66	4.81	–	
	Output Swing Low	$R_L = 10k$ to V^-	–	86	125 135	mV
I_{SC}	Output Short Circuit Current	Sourcing to V^- $V_{ID} = 200mV$ (5)(6)	35 20	53	–	mA
		Sinking to V^+ $V_{ID} = -200mV$ (5)(6)	60 50	75	–	
I_S	Supply Current (both amps)	No load, $V_{CM} = 1V$	–	2.3	2.8 3.5	mA
SR	Slew Rate (7)	$A_V = +1$, $V_I = 5V_{PP}$	10 7	12	–	V/ μs
f_u	Unity Gain Frequency	$V_I = 10mV$, $R_L = 2k\Omega$ to $V^+/2$	–	10.5	–	MHz
GBWP	Gain-Bandwidth Product	$f = 50KHz$	16 15	21	–	MHz
Φ_m	Phase Margin	$V_I = 10mV$	–	53	–	Deg
e_n	Input-Referred Voltage Noise	$f = 2KHz$, $R_S = 50\Omega$	–	15	–	nV/\sqrt{Hz}
i_n	Input-Referred Current Noise	$f = 2KHz$	–	1	–	pA/\sqrt{Hz}

(1) All limits are ensured by testing or statistical analysis.

(2) Typical Values represent the most likely parametric norm.

(3) Offset voltage average drift determined by dividing the change in V_{OS} at temperature extremes into the total temperature change.

(4) Positive current corresponds to current flowing into the device.

(5) Short circuit test is a momentary test.

(6) Output short circuit duration is infinite for $V_S \leq 6V$ at room temperature and below. For $V_S > 6V$, allowable short circuit duration is 1.5ms.

(7) Slew rate is the slower of the rising and falling slew rates. Connected as a Voltage Follower.

5V Electrical Characteristics (continued)

Unless otherwise specified, all limits ensured for $V^+ = 5V$, $V^- = 0V$, $V_{CM} = 1V$, $V_O = V^+/2$, and $R_L > 1M\Omega$ to V^- . **Boldface** limits apply at the temperature extremes.

PARAMETER	TEST CONDITIONS	MIN ⁽¹⁾	TYP ⁽²⁾	MAX ⁽¹⁾	UNIT	
f_{max}	Full Power Bandwidth	$Z_L = (20pF \parallel 10k\Omega)$ to $V^+/2$	–	900	–	KHz
t_s	Settling Time (+/-5%)	100mV _{PP} Step, 500pF load	–	400	–	ns
THD+N	Total Harmonic Distortion + Noise	$R_L = 1k\Omega$ to $V^+/2$ $f = 10kHz$ to $A_V = +2$, 4V _{PP} swing	–	0.05%	–	

6.7 +/-11V Electrical Characteristics

Unless otherwise specified, all limits ensured for $V^+ = 11V$, $V^- = -11V$, $V_{CM} = 0V$, $V_O = 0V$, and $R_L > 1M\Omega$ to $0V$. **Boldface** limits apply at the temperature extremes.

PARAMETER	TEST CONDITIONS	MIN ⁽¹⁾	TYP ⁽²⁾	MAX ⁽¹⁾	UNIT	
V_{OS}	Input Offset Voltage	$V_{CM} = -10.5V$ & $V_{CM} = 10.5V$	–	+/-0.7	+/-7 +/- 9	mV
TC V_{OS}	Input Offset Average Drift	$V_{CM} = -10.5V$ & $V_{CM} = 10.5V$	–	+/-2	–	$\mu V/^\circ C$
I_B	Input Bias Current	$V_{CM} = -10.5V$	–	-1.05	-2.00 -2.80	μA
		$V_{CM} = 10.5V$	–	+0.49	+1.00 +1.50	
I_{OS}	Input Offset Current	$V_{CM} = -10.5V$ & $V_{CM} = 10.5V$	–	30	275 550	nA
CMRR	Common Mode Rejection Ratio	V_{CM} stepped from -11V to 9V	84 80	100	–	dB
		V_{CM} stepped from 10V to 11V	–	100	–	
		V_{CM} stepped from -11V to 11V	74 72	88	–	
+PSRR	Positive Power Supply Rejection Ratio	$V^+ = 9V$ to 11V	70 66	100	–	dB
-PSRR	Negative Power Supply Rejection Ratio	$V^- = -9V$ to -11V	70 66	100	–	dB
CMVR	Input Common-Mode Voltage Range	CMRR > 50dB	–	-11.3	-11.1 -11.0	V
			11.1 11.0	11.3	–	V
A_{VOL}	Large Signal Voltage Gain	$V_O = 0V$ to +/-9V, $R_L = 10k\Omega$	78 74	85	–	dB
		$V_O = 0V$ to +/-9V, $R_L = 2k\Omega$	72 66	79	–	
V_O	Output Swing High	$R_L = 10k\Omega$	10.65 10.61	10.77	–	V
		$R_L = 2k\Omega$	10.6 10.55	10.69	–	
	Output Swing Low	$R_L = 10k\Omega$	–	-10.98	-10.75 -10.65	V
		$R_L = 2k\Omega$	–	-10.91	-10.65 -10.6	

(1) All limits are ensured by testing or statistical analysis.

(2) Typical Values represent the most likely parametric norm.

(3) Offset voltage average drift determined by dividing the change in V_{OS} at temperature extremes into the total temperature change.

(4) Positive current corresponds to current flowing into the device.

+/-11V Electrical Characteristics (continued)

Unless otherwise specified, all limits ensured for $V^+ = 11V$, $V^- = -11V$, $V_{CM} = 0V$, $V_O = 0V$, and $R_L > 1M\Omega$ to $0V$. **Boldface** limits apply at the temperature extremes.

PARAMETER		TEST CONDITIONS	MIN ⁽¹⁾	TYP ⁽²⁾	MAX ⁽¹⁾	UNIT
I_{SC}	Output Short Circuit Current	Sourcing to ground $V_{ID} = 200mV$ ⁽⁵⁾⁽⁶⁾	40 25	60	–	mA
		Sinking to ground $V_{ID} = 200mV$ ⁽⁵⁾⁽⁶⁾	65 55	100	–	
I_S	Supply Current	No load, $V_{CM} = 0V$	–	2.5	4 5	mA
SR	Slew Rate ⁽⁷⁾	$A_V = +1$, $V_I = 16V_{PP}$	10 8	15	–	V/ μ s
f_U	Unity Gain Frequency	$V_I = 10mV$, $R_L = 2k\Omega$	–	13	–	MHz
GBWP	Gain-Bandwidth Product	$f = 50KHz$	18 16	24	–	MHz
Φ_{im}	Phase Margin	$V_I = 10mV$	–	58	–	Deg
e_n	Input-Referred Voltage Noise	$f = 2KHz$, $R_S = 50\Omega$	–	15	–	nV/ \sqrt{Hz}
i_n	Input-Referred Current Noise	$f = 2KHz$	–	1	–	pA/ \sqrt{Hz}
t_S	Settling Time (+/-1%, $A_V = +1$)	Positive Step, $5V_{PP}$	–	320	–	ns
		Negative Step, $5V_{PP}$	–	600	–	
THD+N	Total Harmonic Distortion +Noise	$R_L = 1k\Omega$, $f = 10KHz$, $A_V = +2$, $15V_{PP}$ swing	–	0.01%	–	
CT_{REJ}	Cross-Talk Rejection	$f = 5MHz$, Driver $R_L = 10k\Omega$	–	68	–	dB

(5) Short circuit test is a momentary test.

(6) Output short circuit duration is infinite for $V_S \leq 6V$ at room temperature and below. For $V_S > 6V$, allowable short circuit duration is 1.5ms.

(7) Slew rate is the slower of the rising and falling slew rates. Connected as a Voltage Follower.

6.8 Typical Performance Characteristics

$T_A = 25^\circ\text{C}$, Unless Otherwise Noted

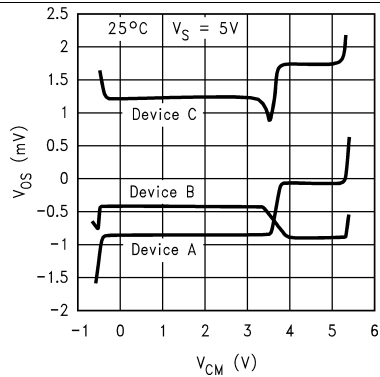

Figure 1. V_{OS} vs. V_{CM} for 3 Representative Units

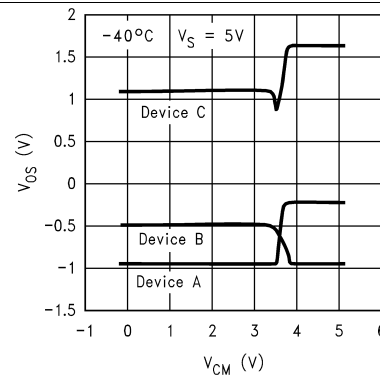

Figure 2. V_{OS} vs. V_{CM} for 3 Representative Units

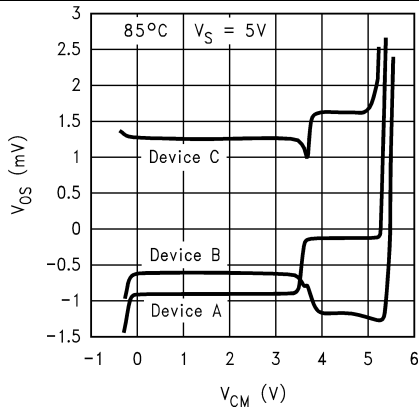

Figure 3. V_{OS} vs. V_{CM} for 3 Representative Units

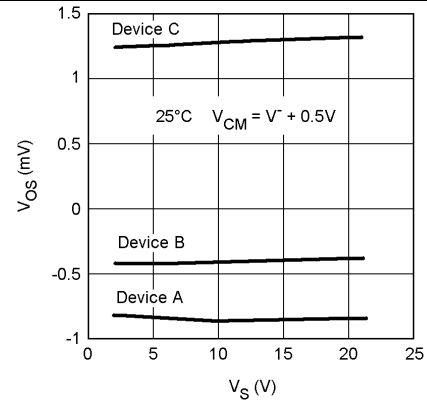

Figure 4. V_{OS} vs. V_S for 3 Representative Units

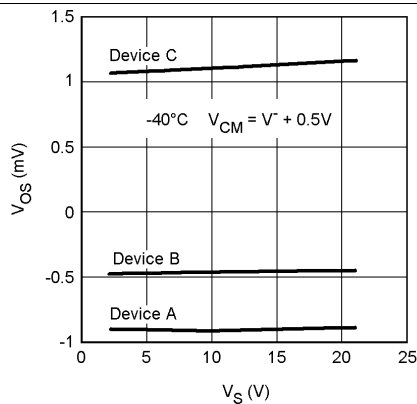

Figure 5. V_{OS} vs. V_S for 3 Representative Units

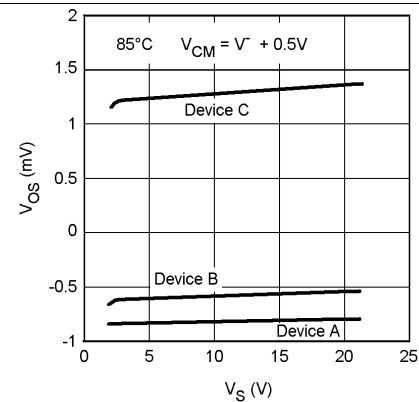

Figure 6. V_{OS} vs. V_S for 3 Representative Units

Typical Performance Characteristics (continued)

T_A = 25°C, Unless Otherwise Noted

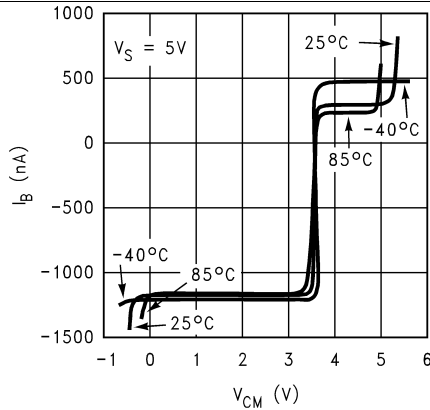

Figure 7. I_B vs. V_{CM}

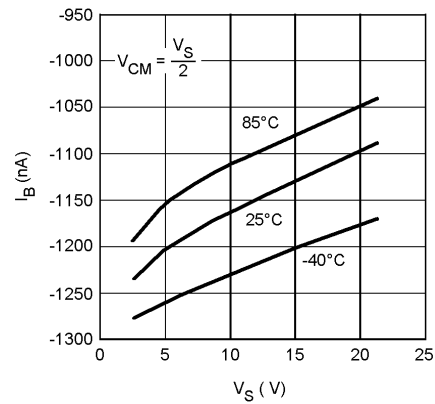

Figure 8. I_B vs. V_S

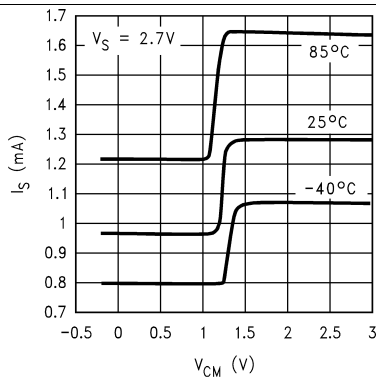

Figure 9. I_S vs. V_{CM}

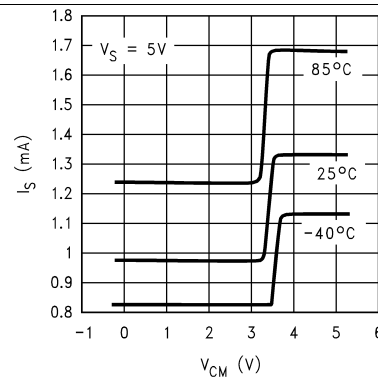

Figure 10. I_S vs. V_{CM}

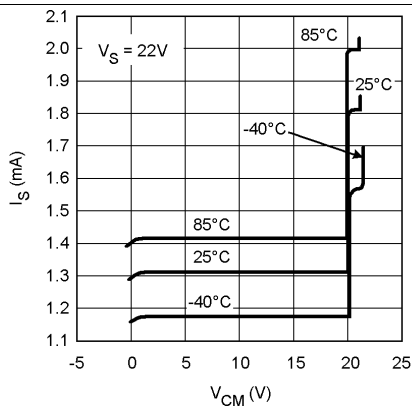

Figure 11. I_S vs. V_{CM}

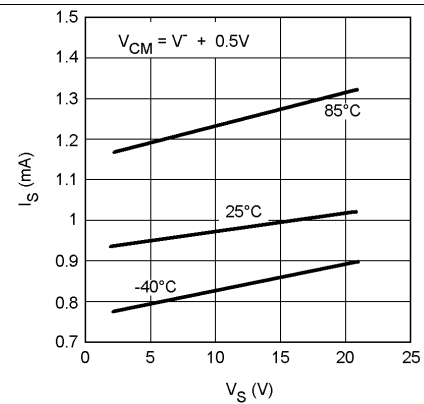

Figure 12. I_S vs. V_S (PNP side)

Typical Performance Characteristics (continued)

T_A = 25°C, Unless Otherwise Noted

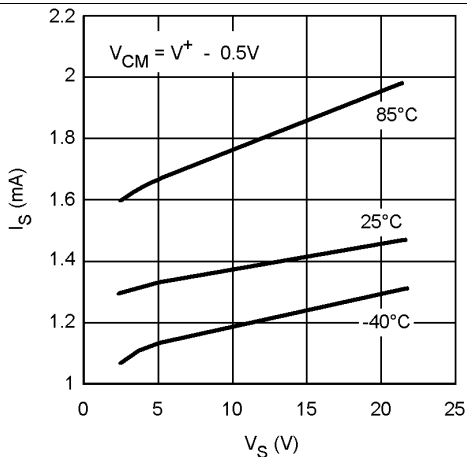

Figure 13. I_S vs. V_S (NPN side)

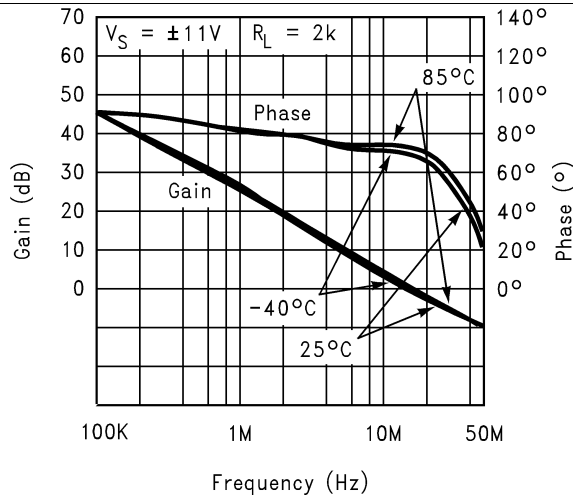

Figure 14. Gain/Phase vs. Frequency

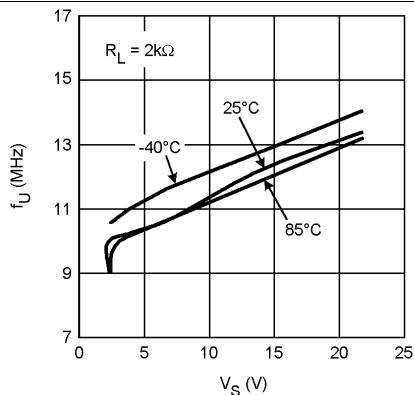

Figure 15. Unity Gain Frequency vs. V_S

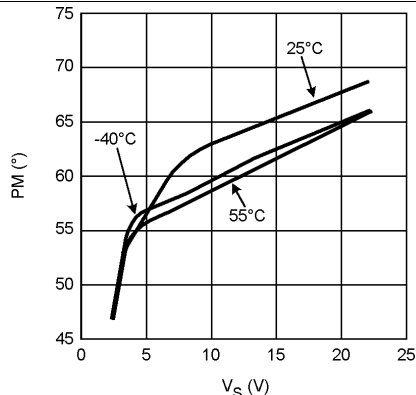

Figure 16. Phase Margin vs. V_S

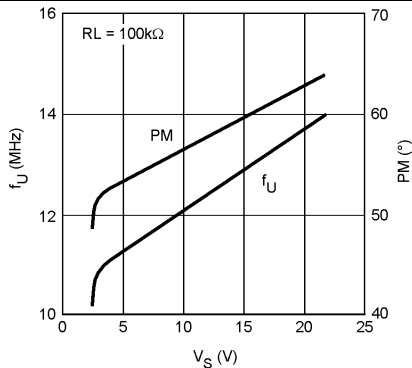

Figure 17. Unity Gain Freq. and Phase Margin vs. V_S

7 Device and Documentation Support

7.1 Community Resources

The following links connect to TI community resources. Linked contents are provided "AS IS" by the respective contributors. They do not constitute TI specifications and do not necessarily reflect TI's views; see TI's [Terms of Use](#).

TI E2E™ Online Community *TI's Engineer-to-Engineer (E2E) Community*. Created to foster collaboration among engineers. At e2e.ti.com, you can ask questions, share knowledge, explore ideas and help solve problems with fellow engineers.

Design Support *TI's Design Support* Quickly find helpful E2E forums along with design support tools and contact information for technical support.

7.2 Trademarks

E2E is a trademark of Texas Instruments.
All other trademarks are the property of their respective owners.

7.3 Electrostatic Discharge Caution



These devices have limited built-in ESD protection. The leads should be shorted together or the device placed in conductive foam during storage or handling to prevent electrostatic damage to the MOS gates.

7.4 Glossary

[SLYZ022](#) — *TI Glossary*.

This glossary lists and explains terms, acronyms, and definitions.

8 Mechanical, Packaging, and Orderable Information

The following pages include mechanical, packaging, and orderable information. This information is the most current data available for the designated devices. This data is subject to change without notice and revision of this document. For browser-based versions of this data sheet, refer to the left-hand navigation.

PACKAGING INFORMATION

Orderable part number	Status (1)	Material type (2)	Package Pins	Package qty Carrier	RoHS (3)	Lead finish/ Ball material (4)	MSL rating/ Peak reflow (5)	Op temp (°C)	Part marking (6)
LM8262MM/NOPB	Obsolete	Production	VSSOP (DGK) 8	-	-	Call TI	Call TI	-40 to 85	A46
LM8262MMX/NOPB	Active	Production	VSSOP (DGK) 8	3500 LARGE T&R	Yes	SN	Level-1-260C-UNLIM	-40 to 85	A46
LM8262MMX/NOPB.B	Active	Production	VSSOP (DGK) 8	3500 LARGE T&R	Yes	SN	Level-1-260C-UNLIM	-40 to 85	A46

(1) **Status:** For more details on status, see our [product life cycle](#).

(2) **Material type:** When designated, preproduction parts are prototypes/experimental devices, and are not yet approved or released for full production. Testing and final process, including without limitation quality assurance, reliability performance testing, and/or process qualification, may not yet be complete, and this item is subject to further changes or possible discontinuation. If available for ordering, purchases will be subject to an additional waiver at checkout, and are intended for early internal evaluation purposes only. These items are sold without warranties of any kind.

(3) **RoHS values:** Yes, No, RoHS Exempt. See the [TI RoHS Statement](#) for additional information and value definition.

(4) **Lead finish/Ball material:** Parts may have multiple material finish options. Finish options are separated by a vertical ruled line. Lead finish/Ball material values may wrap to two lines if the finish value exceeds the maximum column width.

(5) **MSL rating/Peak reflow:** The moisture sensitivity level ratings and peak solder (reflow) temperatures. In the event that a part has multiple moisture sensitivity ratings, only the lowest level per JEDEC standards is shown. Refer to the shipping label for the actual reflow temperature that will be used to mount the part to the printed circuit board.

(6) **Part marking:** There may be an additional marking, which relates to the logo, the lot trace code information, or the environmental category of the part.

Multiple part markings will be inside parentheses. Only one part marking contained in parentheses and separated by a "-" will appear on a part. If a line is indented then it is a continuation of the previous line and the two combined represent the entire part marking for that device.

Important Information and Disclaimer: The information provided on this page represents TI's knowledge and belief as of the date that it is provided. TI bases its knowledge and belief on information provided by third parties, and makes no representation or warranty as to the accuracy of such information. Efforts are underway to better integrate information from third parties. TI has taken and continues to take reasonable steps to provide representative and accurate information but may not have conducted destructive testing or chemical analysis on incoming materials and chemicals. TI and TI suppliers consider certain information to be proprietary, and thus CAS numbers and other limited information may not be available for release.

In no event shall TI's liability arising out of such information exceed the total purchase price of the TI part(s) at issue in this document sold by TI to Customer on an annual basis.

TAPE AND REEL INFORMATION

QUADRANT ASSIGNMENTS FOR PIN 1 ORIENTATION IN TAPE

*All dimensions are nominal

Device	Package Type	Package Drawing	Pins	SPQ	Reel Diameter (mm)	Reel Width W1 (mm)	A0 (mm)	B0 (mm)	K0 (mm)	P1 (mm)	W (mm)	Pin1 Quadrant
LM8262MMX/NOPB	VSSOP	DGK	8	3500	330.0	12.4	5.25	3.35	1.25	8.0	12.0	Q1
LM8262MMX/NOPB	VSSOP	DGK	8	3500	330.0	12.4	5.3	3.4	1.4	8.0	12.0	Q1

TAPE AND REEL BOX DIMENSIONS

*All dimensions are nominal

Device	Package Type	Package Drawing	Pins	SPQ	Length (mm)	Width (mm)	Height (mm)
LM8262MMX/NOPB	VSSOP	DGK	8	3500	366.0	364.0	50.0
LM8262MMX/NOPB	VSSOP	DGK	8	3500	367.0	367.0	35.0

DGK0008A



PACKAGE OUTLINE

VSSOP - 1.1 mm max height

SMALL OUTLINE PACKAGE

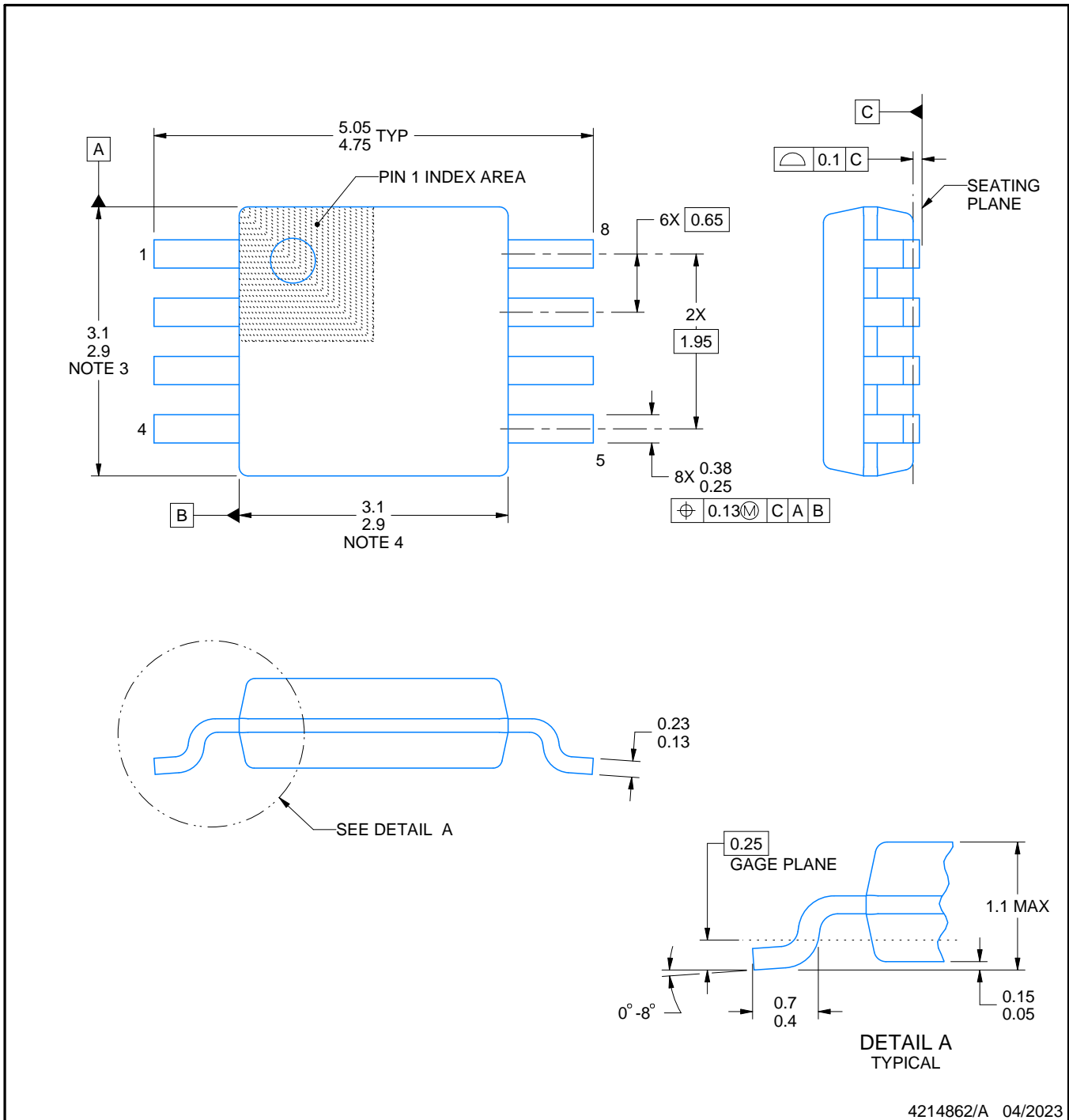

4214862/A 04/2023

NOTES:

PowerPAD is a trademark of Texas Instruments.

1. All linear dimensions are in millimeters. Any dimensions in parenthesis are for reference only. Dimensioning and tolerancing per ASME Y14.5M.
2. This drawing is subject to change without notice.
3. This dimension does not include mold flash, protrusions, or gate burrs. Mold flash, protrusions, or gate burrs shall not exceed 0.15 mm per side.
4. This dimension does not include interlead flash. Interlead flash shall not exceed 0.25 mm per side.
5. Reference JEDEC registration MO-187.

EXAMPLE BOARD LAYOUT

DGK0008A

™ VSSOP - 1.1 mm max height

SMALL OUTLINE PACKAGE



LAND PATTERN EXAMPLE
EXPOSED METAL SHOWN
SCALE: 15X



SOLDER MASK DETAILS

4214862/A 04/2023

NOTES: (continued)

6. Publication IPC-7351 may have alternate designs.
7. Solder mask tolerances between and around signal pads can vary based on board fabrication site.
8. Vias are optional depending on application, refer to device data sheet. If any vias are implemented, refer to their locations shown on this view. It is recommended that vias under paste be filled, plugged or tented.
9. Size of metal pad may vary due to creepage requirement.

EXAMPLE STENCIL DESIGN

DGK0008A

TM VSSOP - 1.1 mm max height

SMALL OUTLINE PACKAGE



SOLDER PASTE EXAMPLE
SCALE: 15X

4214862/A 04/2023

NOTES: (continued)

11. Laser cutting apertures with trapezoidal walls and rounded corners may offer better paste release. IPC-7525 may have alternate design recommendations.
12. Board assembly site may have different recommendations for stencil design.

IMPORTANT NOTICE AND DISCLAIMER

TI PROVIDES TECHNICAL AND RELIABILITY DATA (INCLUDING DATASHEETS), DESIGN RESOURCES (INCLUDING REFERENCE DESIGNS), APPLICATION OR OTHER DESIGN ADVICE, WEB TOOLS, SAFETY INFORMATION, AND OTHER RESOURCES "AS IS" AND WITH ALL FAULTS, AND DISCLAIMS ALL WARRANTIES, EXPRESS AND IMPLIED, INCLUDING WITHOUT LIMITATION ANY IMPLIED WARRANTIES OF MERCHANTABILITY, FITNESS FOR A PARTICULAR PURPOSE OR NON-INFRINGEMENT OF THIRD PARTY INTELLECTUAL PROPERTY RIGHTS.

These resources are intended for skilled developers designing with TI products. You are solely responsible for (1) selecting the appropriate TI products for your application, (2) designing, validating and testing your application, and (3) ensuring your application meets applicable standards, and any other safety, security, regulatory or other requirements.

These resources are subject to change without notice. TI grants you permission to use these resources only for development of an application that uses the TI products described in the resource. Other reproduction and display of these resources is prohibited. No license is granted to any other TI intellectual property right or to any third party intellectual property right. TI disclaims responsibility for, and you fully indemnify TI and its representatives against any claims, damages, costs, losses, and liabilities arising out of your use of these resources.

TI's products are provided subject to [TI's Terms of Sale](#), [TI's General Quality Guidelines](#), or other applicable terms available either on [ti.com](#) or provided in conjunction with such TI products. TI's provision of these resources does not expand or otherwise alter TI's applicable warranties or warranty disclaimers for TI products. Unless TI explicitly designates a product as custom or customer-specified, TI products are standard, catalog, general purpose devices.

TI objects to and rejects any additional or different terms you may propose.

Copyright © 2025, Texas Instruments Incorporated

Last updated 10/2025