

OPAx30x Low-Noise, Fast-Settling, 150MHz CMOS Operational Amplifiers

1 Features

- High bandwidth: 150MHz
- 16-bit settling in 150ns
- Low noise: 3nV/√Hz
- Low distortion: 0.003%
- Low power: 9.5mA (typical) on 5.5V
- Shutdown to 5μA
- Unity-gain stable
- Excellent output swing:
 - (V+) – 100mV to (V-) + 100mV
- Single supply: +2.7V to +5.5V
- Tiny packages: VSSOP and SOT23

2 Applications

- 16-bit ADC input driver
- Low-noise preamplifier
- IF/RF amplifier
- Active filtering

3 Description

The OPA300, OPA301, OPA2300, and OPA2301 (OPAx30x) series high-speed, voltage-feedback, CMOS operational amplifiers are designed for 16-bit resolution systems. The OPAx30x series are unity-gain stable and feature excellent settling and harmonic distortion specifications. Low power applications benefit from low quiescent current. The OPA300 and OPA2300 feature a digital shutdown

(enable) function to provide additional power savings during idle periods. Optimized for single-supply operation, the OPA30x series offer high output swing and excellent common-mode range.

The OPAx30x series op amps have 150MHz of unity-gain bandwidth, low 3nV/√Hz voltage noise, and 0.1% settling within 30ns. Single-supply operation from 2.7V (±1.35V) to 5.5V (±2.75V) and an available shutdown function that reduces supply current to 5μA are useful for portable low-power applications. The OPAx30x are available in SO-8 and SOT-23 packages. The OPA2300 is available in VSSOP-10, and the OPA2301 is available in SO-8 and VSSOP-8. All versions are specified over the industrial temperature range of –40°C to +125°C.

Package Information

PART NUMBER	CHANNEL COUNT	PACKAGE ⁽¹⁾
OPA2300	Dual	DGS (VSSOP, 10)
OPA300	Single	D (SOIC, 8)
		DBV (SOT23, 6)
OPA301	Single	D (SOIC, 8)
		DBV (SOT23, 5)
OPA2301	Dual	D (SOIC, 8)
		DGK (VSSOP, 8)

(1) For all available packages, see [Section 10](#).

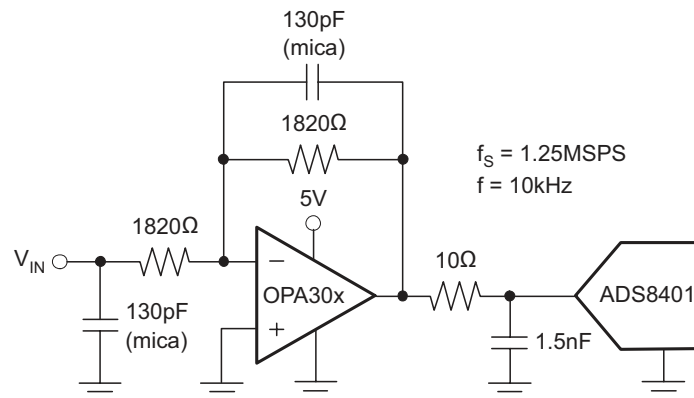

Typical Application

$f_s = 1.25\text{MSPS}$
 $f = 10\text{kHz}$



Table of Contents

1 Features	1	6.5 Input and ESD Protection.....	12
2 Applications	1	6.6 Enable Function.....	13
3 Description	1	7 Application and Implementation	14
4 Pin Configuration and Functions	3	7.1 Application Information.....	14
5 Specifications	4	7.2 Typical Application.....	14
5.1 Absolute Maximum Ratings.....	4	7.3 Layout.....	15
5.2 ESD Ratings.....	4	8 Device and Documentation Support	16
5.3 Recommended Operating Conditions.....	4	8.1 Receiving Notification of Documentation Updates... 16	
5.4 Electrical Characteristics.....	4	8.2 Support Resources.....	16
5.5 Typical Characteristics.....	6	8.3 Trademarks.....	16
6 Detailed Description	12	8.4 Electrostatic Discharge Caution.....	16
6.1 Overview.....	12	8.5 Glossary.....	16
6.2 Functional Block Diagram.....	12	9 Revision History	16
6.3 Feature Description.....	12	10 Mechanical, Packaging, and Orderable Information	17
6.4 Operating Voltage.....	12		

4 Pin Configuration and Functions

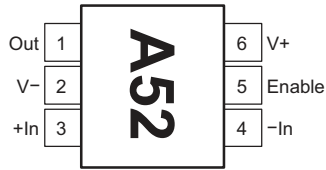

Figure 4-1. OPA300, SOT- 23 Package, 6-pin (Top View)

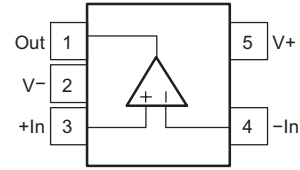

Figure 4-2. OPA301, SOT23-5 Package, 5-pin (Top View)

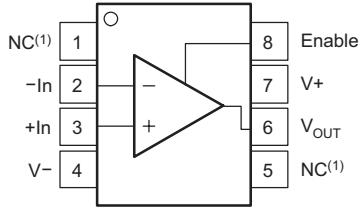

Figure 4-3. OPA300, SO- 8 Package, 8-pin (Top View)

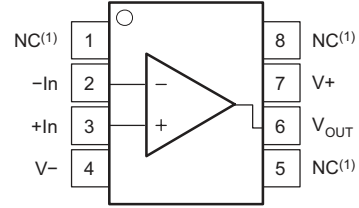

Figure 4-4. OPA301, SO-8 Package, 8-pin (Top View)

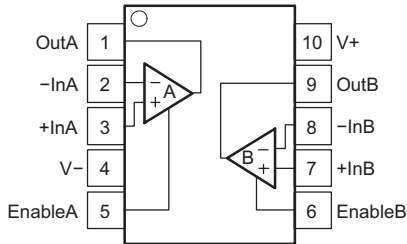

Figure 4-5. OPA2300, VSSOP-10 Package, 10-pin (Top View)

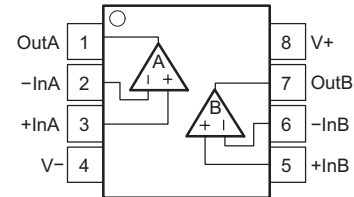

Figure 4-6. OPA2301, SO- 8, VSSOP- 8 Package, 8-pin (Top View)

Table 4-1. Pin Functions

PIN		TYPE ⁽¹⁾	DESCRIPTION
NAME	NO.		
+In	3	I	Positive input voltage
Enable	8	I	Enable pin
-In	2	I	Negative input voltage
NC	1,5	-	No connection
V-	4	P	Negative supply voltage
V+	7	P	Positive supply voltage
V _{OUT}	6	O	Output voltage

(1) I = input, O = output, P = power

5 Specifications

5.1 Absolute Maximum Ratings

over operating free-air temperature range (unless otherwise noted)⁽¹⁾

		MIN	MAX	UNIT
	Power supply		7	V
V _S	Operating voltage range	2.7	5.5	V
	Signal input terminals, voltage ⁽²⁾	0.5	(V _S) + 0.5	V
	Signal input terminals, current		±10	mA
	Open short circuit current ⁽³⁾		Continuous	
	Operating temperature range	–55	125	°C
T _J	Junction temperature		150	°C
T _{stg}	Storage temperature	–60	150	°C

- (1) Operation outside the *Absolute Maximum Ratings* may cause permanent device damage. *Absolute Maximum Ratings* do not imply functional operation of the device at these or any other conditions beyond those listed under *Recommended Operating Conditions*. If used outside the *Recommended Operating Conditions* but within the *Absolute Maximum Ratings*, the device may not be fully functional, and this may affect device reliability, functionality, performance, and shorten the device lifetime.
- (2) Input terminals are diode clamped to the power-supply rails. Input signals that can swing more than 0.5V beyond the supply rails should be current limited to 10mA or less.
- (3) Short-circuit to ground; one amplifier per package.

5.2 ESD Ratings

			VALUE	UNIT
V _(ESD)	Electrostatic discharge	Human-body model (HBM), per ANSI/ESDA/JEDEC JS-001 ⁽¹⁾	4000	V
		Charged device model (CDM), per ANSI/ESDA/JEDEC JS-002 ⁽²⁾	500	

- (1) JEDEC document JEP155 states that 500V HBM allows safe manufacturing with a standard ESD control process.
- (2) JEDEC document JEP157 states that 250V CDM allows safe manufacturing with a standard ESD control process.

5.3 Recommended Operating Conditions

over operating free-air temperature range (unless otherwise noted)

		MIN	NOM	MAX	UNIT
	Power supply voltage	2.7		5.5	V
T _A	Ambient temperature	–40	25	125	°C

5.4 Electrical Characteristics

at T_A = 25°C, R_L = 2kΩ connected to V_S/2, V_{OUT} = V_S/2, and V_{CM} = V_S/2 (unless otherwise noted)

PARAMETER	TEST CONDITIONS		MIN	TYP	MAX	UNIT
OFFSET VOLTAGE						
V _{OS}	Input offset voltage	V _S = 5V		1	5	mV
					7	
dV _{OS} /dT	Drift offset voltage			2.5		μV/°C
PSRR	Offset voltage vs power supply	V _S = 2.7V to 5.5V, V _{CM} < (V+) – 0.9V		50	200	μV/V
	Channel separation, dc	f = 5MHz		140		dB
				100		dB
INPUT VOLTAGE RANGE						
V _{CM}	Common-mode voltage		(V–) – 0.2		(V+) – 0.9	V
CMRR	Common-mode rejection ratio	(V–) – 0.2V < V _{CM} < (V+) – 0.9V	66	80		dB

5.4 Electrical Characteristics (continued)

at $T_A = 25^\circ\text{C}$, $R_L = 2\text{k}\Omega$ connected to $V_S/2$, $V_{OUT} = V_S/2$, and $V_{CM} = V_S/2$ (unless otherwise noted)

PARAMETER		TEST CONDITIONS	MIN	TYP	MAX	UNIT
INPUT BIAS CURRENT						
I_B	Input bias current			± 0.1	± 5	pA
I_{OS}	Input offset current			± 0.5	± 5	pA
INPUT IMPEDANCE						
	Differential			$10^{13} \parallel 3$		$\Omega \parallel \text{pF}$
	Common-mode			$10^{13} \parallel 3$		$\Omega \parallel \text{pF}$
NOISE						
	Input voltage noise	$f = 0.1\text{Hz to } 1\text{MHz}$		40		μV_{PP}
e_n	Input voltage noise density	$f > 1\text{MHz}$		3		$\text{nV}/\sqrt{\text{Hz}}$
i_n	Input current noise density	$f < 1\text{kHz}$		1.5		$\text{fA}/\sqrt{\text{Hz}}$
	Differential gain error	NTSC, $R_L = 150\Omega$		0.01		%
	Differential phase error	NTSC, $R_L = 150\Omega$		0.1		°
OPEN-LOOP GAIN						
A_{OL}	Open-loop voltage gain	$V_S = 5\text{V}, R_L = 2\text{k}\Omega,$ $0.1\text{V} < V_O < 4.9\text{V}$		95	106	dB
			$T_A = -40^\circ\text{C to } +125^\circ\text{C}$	90		
		$V_S = 5\text{V}, R_L = 100\Omega,$ $0.5\text{V} < V_O < 4.5\text{V}$		95	106	
			$T_A = -40^\circ\text{C to } +125^\circ\text{C}$	90		
OUTPUT						
	Voltage output swing from rail	$R_L = 2\text{k}\Omega, A_{OL} > 95\text{dB}$		75	100	mV
		$R_L = 100\Omega, A_{OL} > 95\text{dB}$		300	500	
I_{SC}	Short-circuit current			70		mA
R_O	Open-loop output impedance	$I_O = 0, f = 1\text{MHz}$		20		Ω
C_{LOAD}	Capacitive load drive			See Typical Characteristics		
FREQUENCY RESPONSE						
GBW	Gain-bandwidth product			150		MHz
SR	Slew rate	$G = +1$		80		$\text{V}/\mu\text{s}$
t_s	Settling time	$V_S = 5\text{V}, 2\text{V step}, G = +1, 0.01\%$		90		ns
		$V_S = 5\text{V}, 2\text{V step}, G = +1, 0.1\%$		30		
	Overload recovery time	Gain = -1		30		ns
THD+N	Total harmonic distortion + noise	$V_S = 5\text{V}, V_O = 3\text{V}_{PP}, G = +1, f = 1\text{kHz}$		0.003		%
POWER SUPPLY						
V_S	Specified voltage range		2.7		5.5	V
I_Q	Quiescent current (per amplifier)	$I_O = 0\text{mA}$		9.5	12	mA
			$T_A = -40^\circ\text{C to } +125^\circ\text{C}$		13	
SHUTDOWN						
t_{OFF}	Turn-off time			40		ns
t_{ON}	Turn-on time			5		μs
		V_L (Shutdown)	$(V-) - 0.2$		$(V-) + 0.8$	V
	V_H (amplifier is active)		$(V-) + 2.5$		$(V+) + 0.2$	V
	I_{QSD} (per amplifier)			3	10	μA

5.5 Typical Characteristics

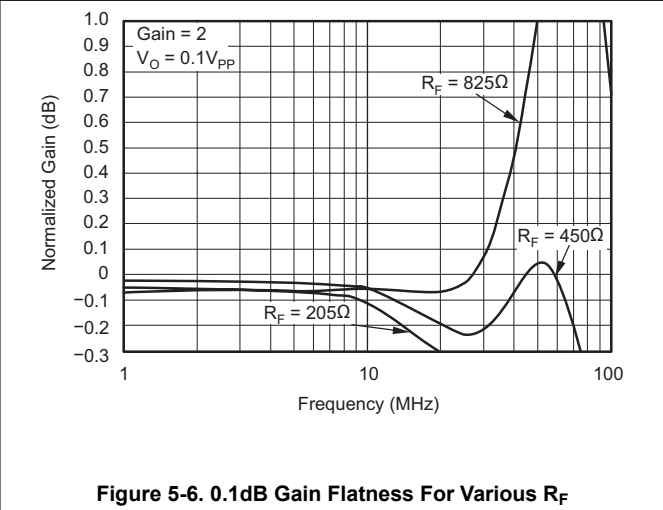
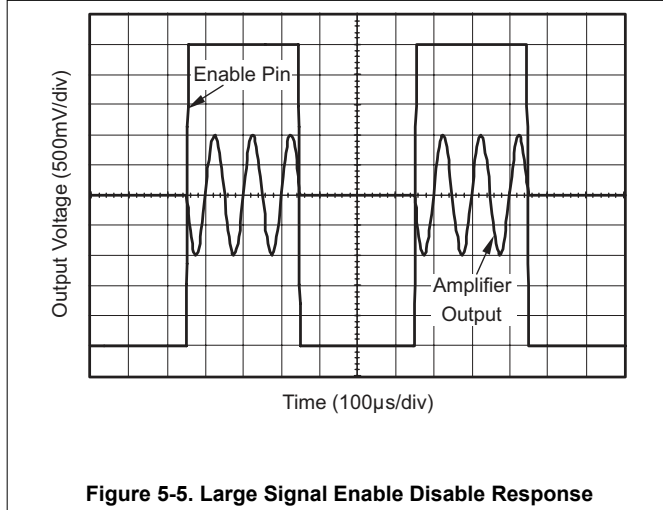
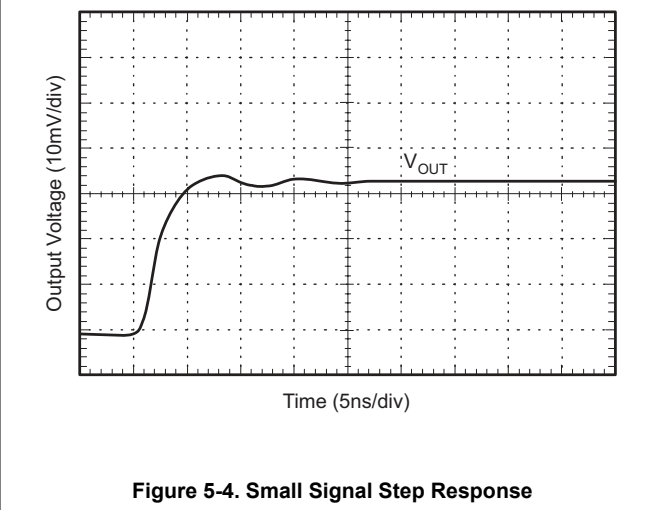
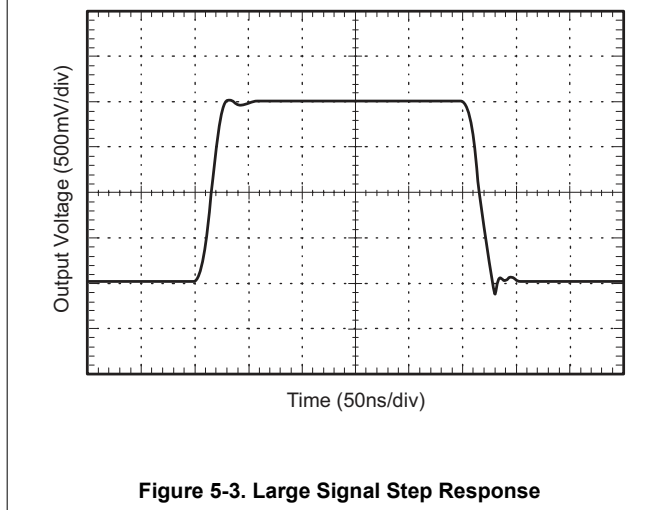
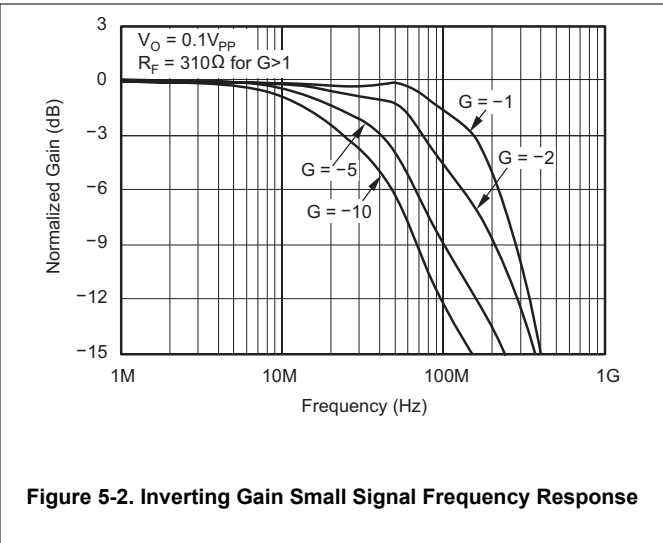
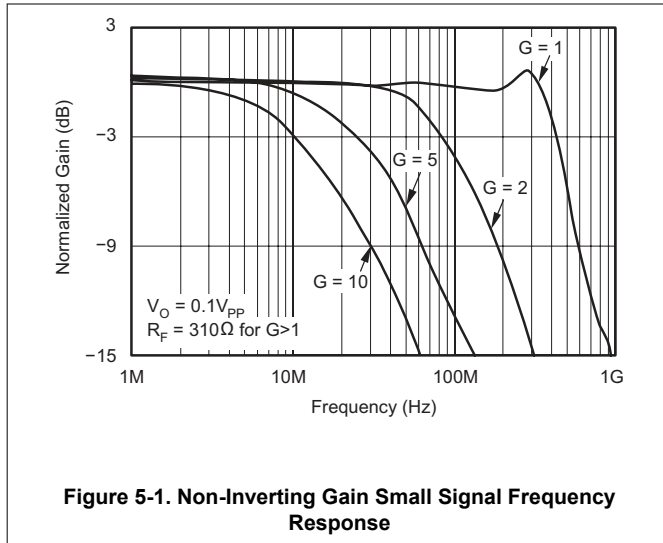

5.5 Typical Characteristics (continued)

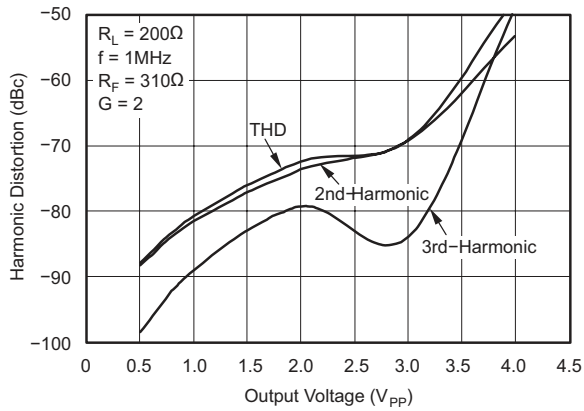

Figure 5-7. Harmonic Distortion vs Output Voltage

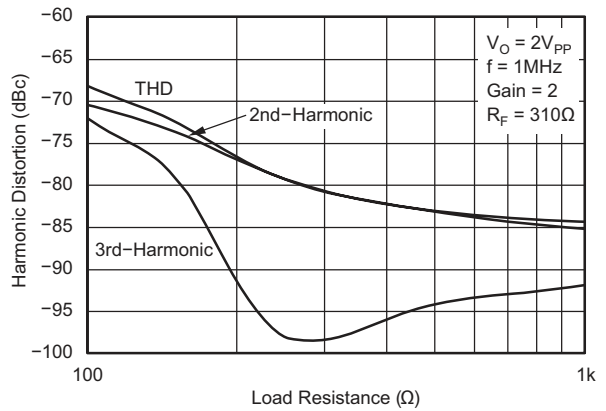

Figure 5-8. Harmonic Distortion vs Load Resistance

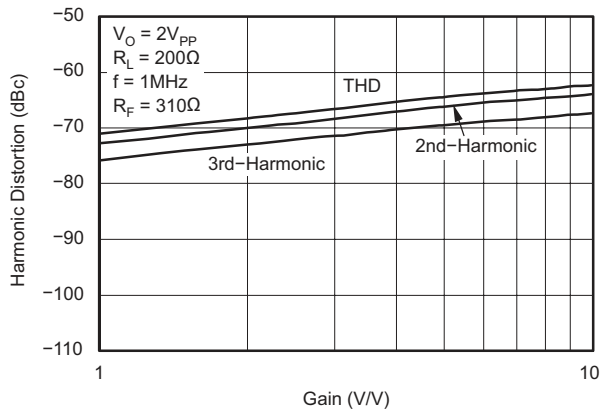

Figure 5-9. Harmonic Distortion vs Inverting Gain

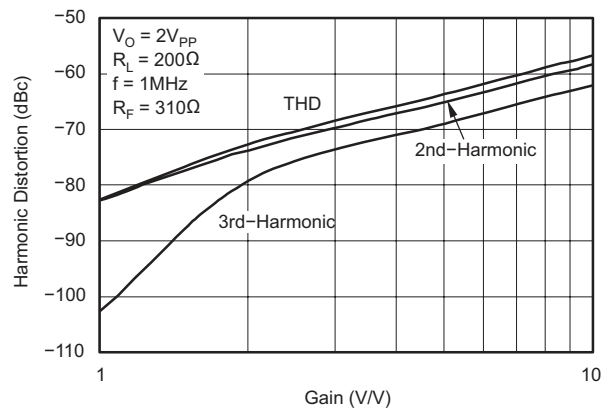

Figure 5-10. Harmonic Distortion vs Non-Inverting Gain

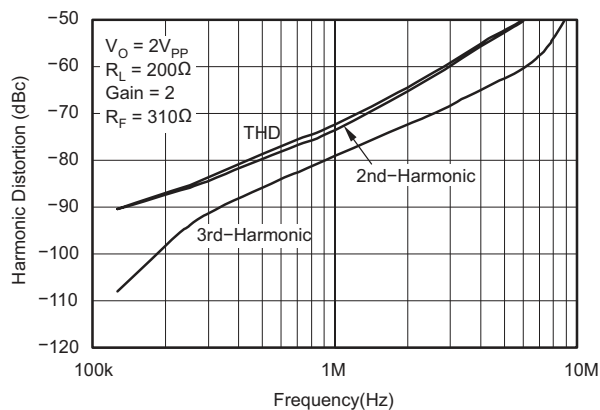

Figure 5-11. Harmonic Distortion vs Frequency

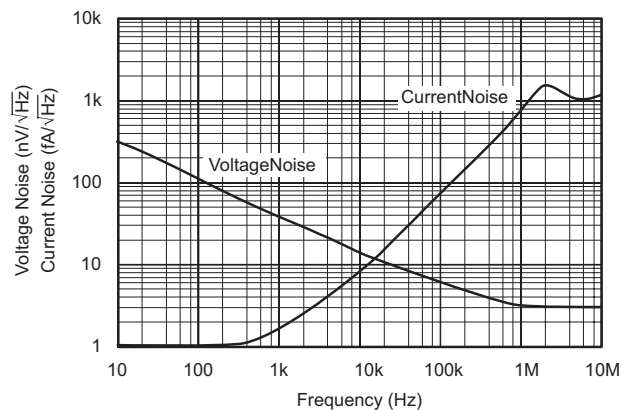
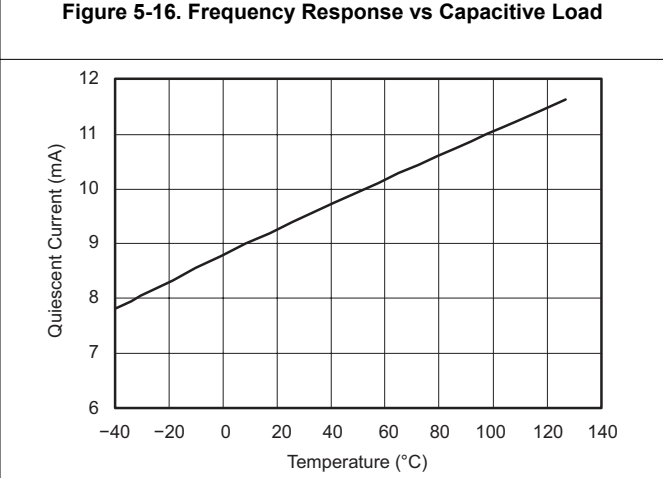
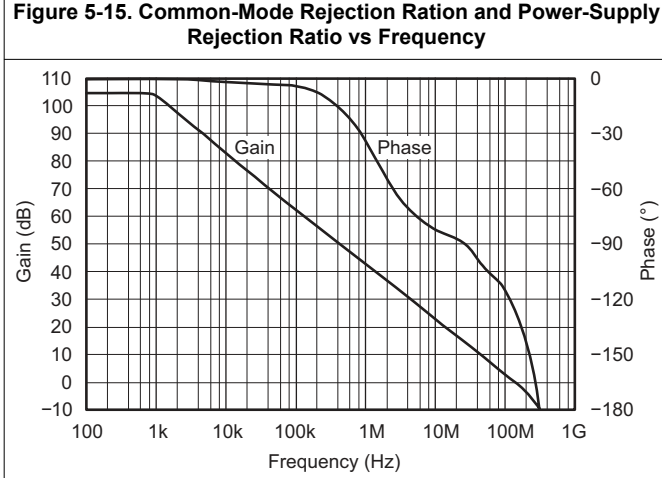
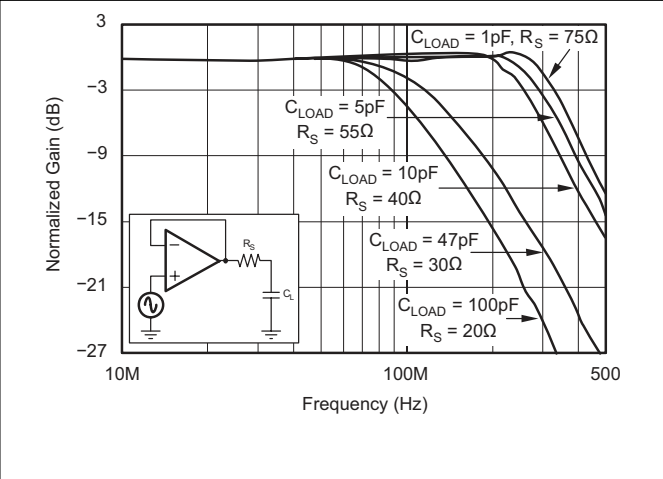
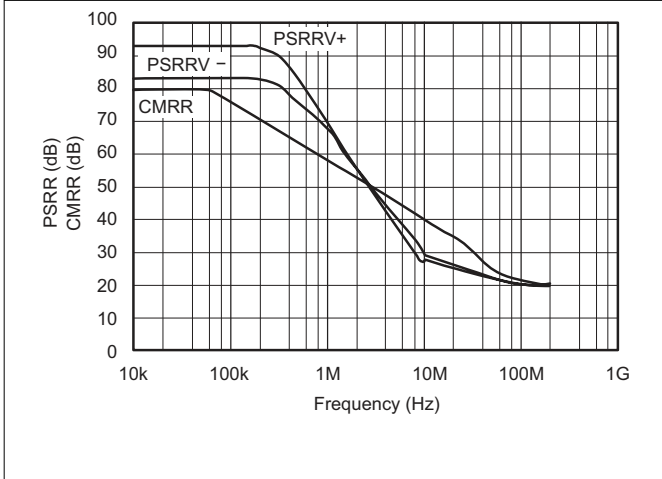
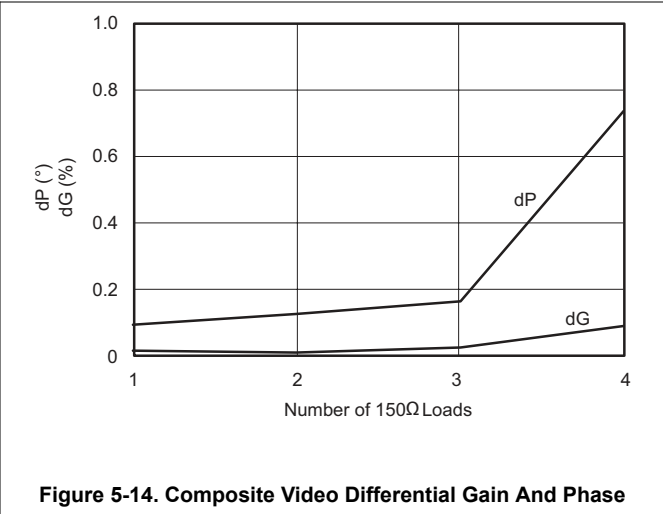
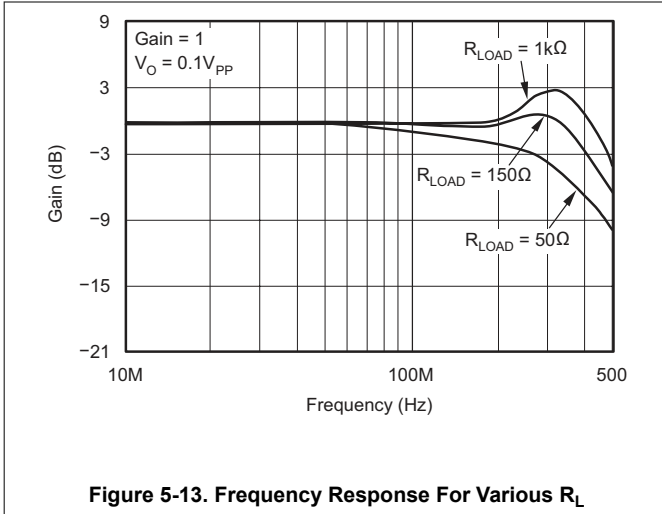

Figure 5-12. Input Voltage And Current Noise Spectral Density vs Frequency

5.5 Typical Characteristics (continued)



5.5 Typical Characteristics (continued)

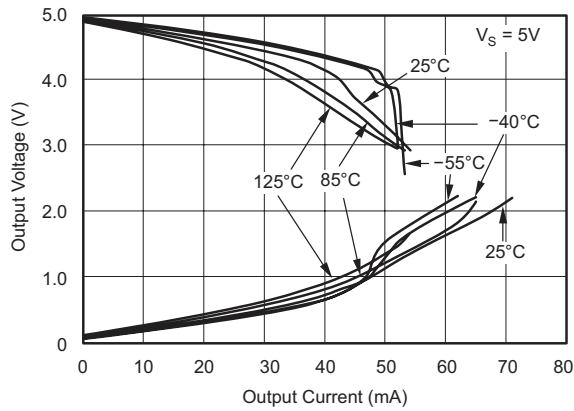

Figure 5-19. Output Voltage Swing vs Output Current

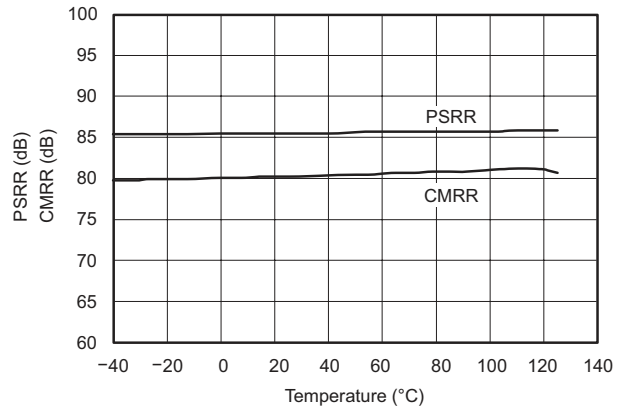

Figure 5-20. Open-loop Gain and Phase vs Frequency

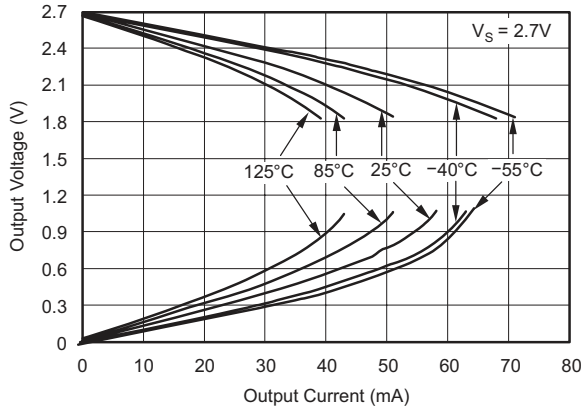

Figure 5-21. Output Voltage Swing vs Output Current

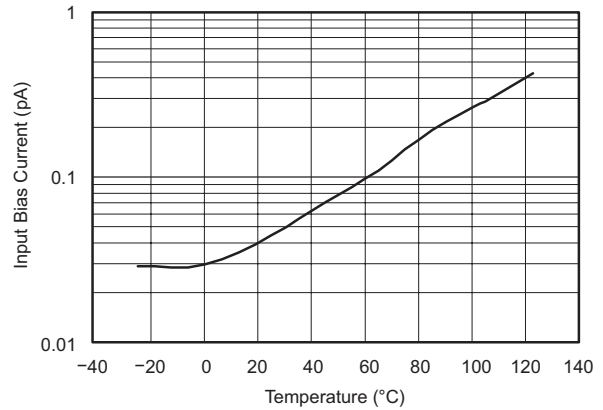

Figure 5-22. Input Bias Current vs Temperature

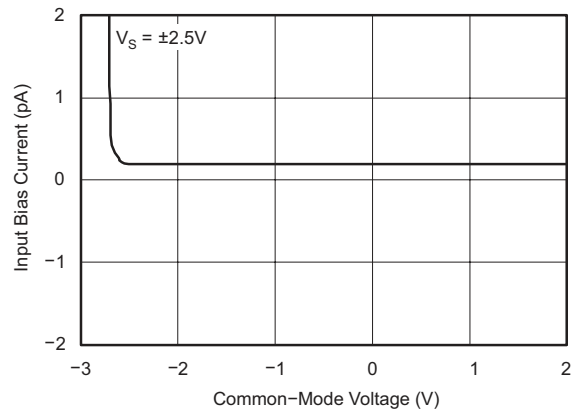

Figure 5-23. Input Bias Current vs Common-Mode Voltage

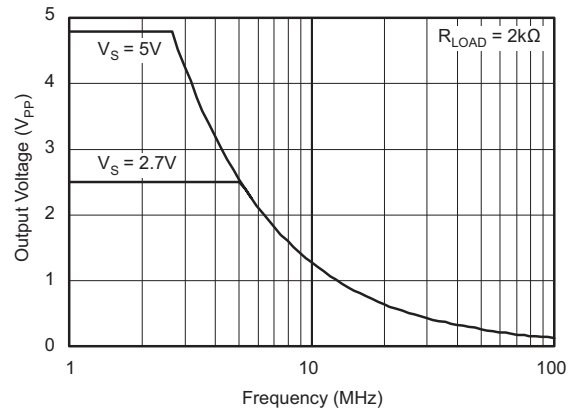

Figure 5-24. Maximum Output Voltage vs Frequency

5.5 Typical Characteristics (continued)

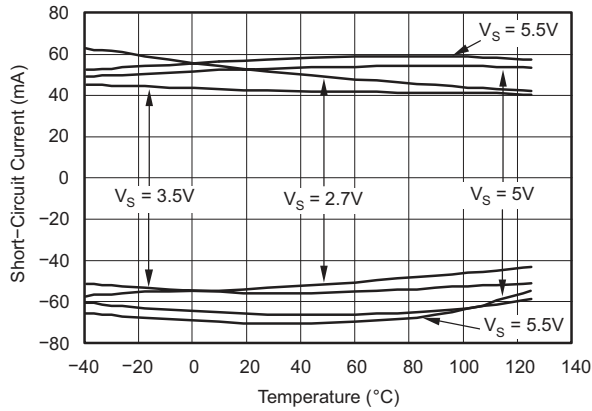

Figure 5-25. Short Circuit Current vs Temperature

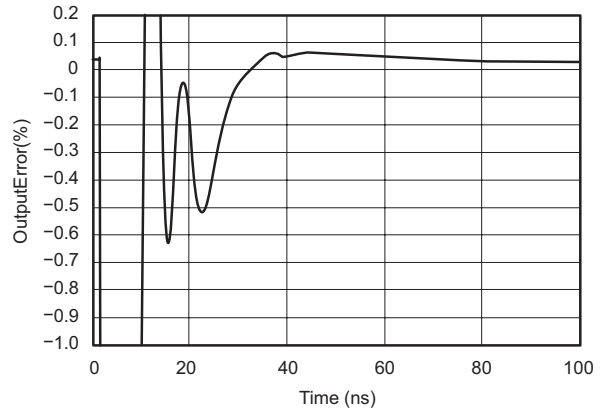

Figure 5-26. Output Settling Time 0.1%

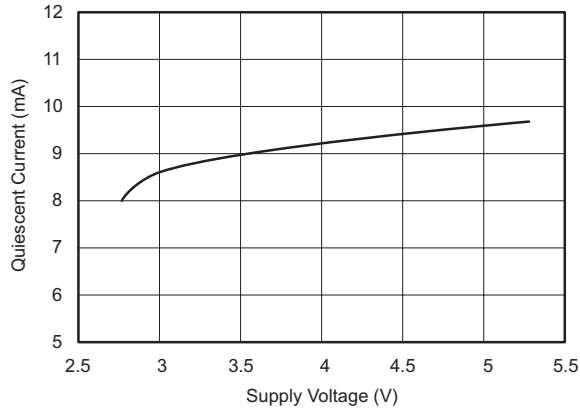

Figure 5-27. Quiescent Current vs Supply Voltage

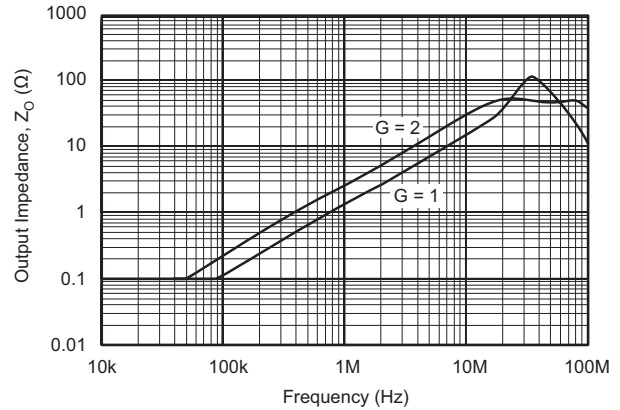

Figure 5-28. Output Impedance vs Frequency

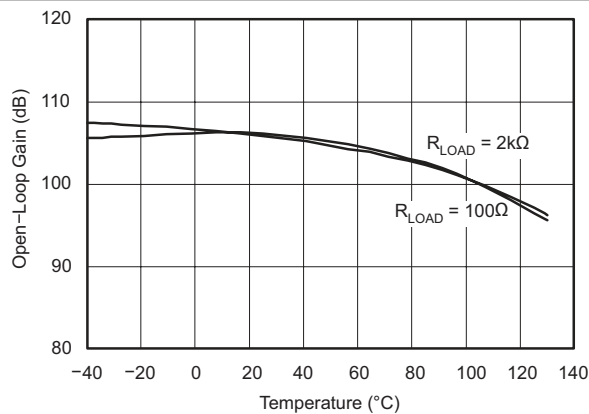

Figure 5-29. Open Gain Loop vs Temperature

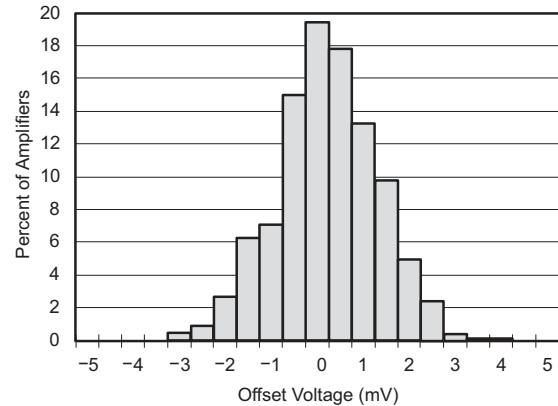

Figure 5-30. Offset Voltage Production Distribution

5.5 Typical Characteristics (continued)

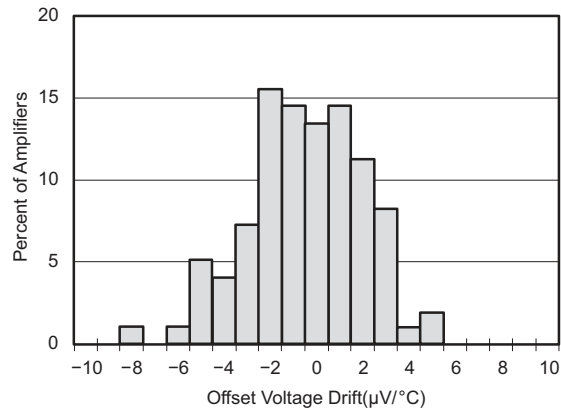

Figure 5-31. Offset Voltage Drift Production Distribution

6 Detailed Description

6.1 Overview

The OPAx30x series op amps use a classic two-stage topology, shown in [Figure 6-1](#). The differential input pair is biased to maximize slew rate without compromising stability or bandwidth. The folded cascode adds the signal from the input pair and presents a differential signal to the class AB output stage. The class AB output stage allows rail-to-rail output swing, with high-impedance loads ($> 2\text{k}\Omega$), typically 100mV from the supply rails. With 10Ω loads, a useful output swing is achieved and still maintains high open-loop gain. See the typical characteristics in [Section 5.5](#).

6.2 Functional Block Diagram

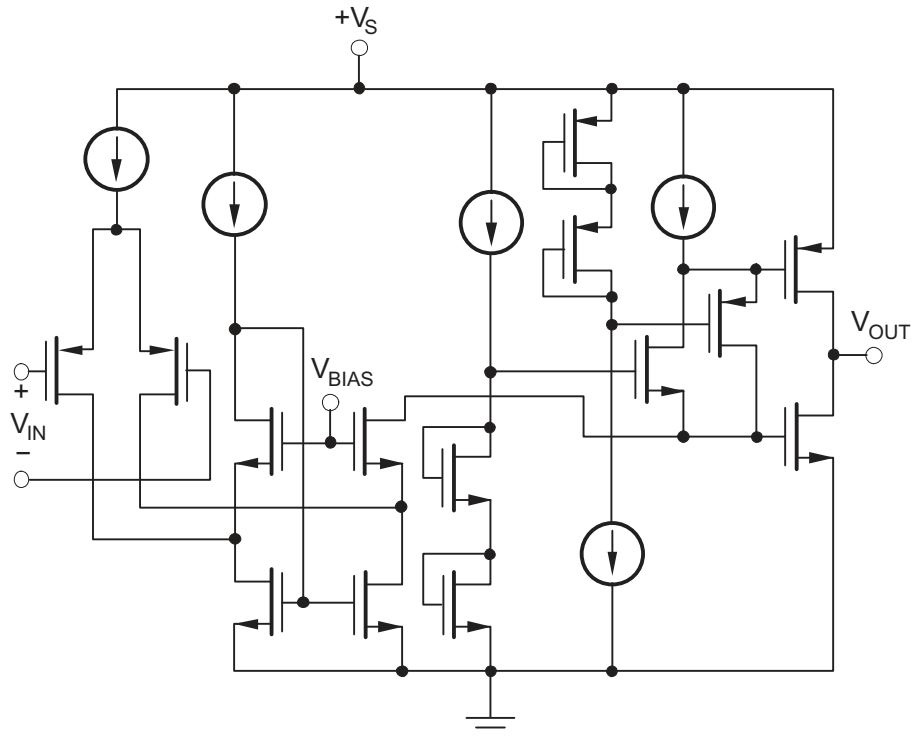

Figure 6-1. OPA30x Classic Two-Stage Topology

6.3 Feature Description

6.4 Operating Voltage

The OPAx30x series op amp parameters are fully specified from +2.7V to +5.5V. Supply voltages higher than 5.5V (absolute maximum) are able to cause permanent damage to the amplifier. Many specifications apply from -40°C to $+125^{\circ}\text{C}$. Parameters that vary significantly with operating voltages or temperature are shown in the [Typical Characteristics](#).

6.5 Input and ESD Protection

All OPAx30x series op amps pins are static protected with internal ESD protection diodes tied to the supplies; see [Figure 6-2](#). These diodes provide overdrive protection if the current is externally limited to 10mA, as stated in the [Section 5.1](#). Any input current beyond the *Absolute Maximum Ratings*, or long-term operation at maximum ratings, shortens the lifespan of the amplifier.

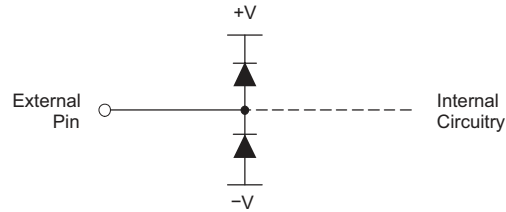

Figure 6-2. ESD Protection Diodes

6.6 Enable Function

The shutdown function of the OPA300 and OPA2300 is referenced to the negative supply voltage of the operational amplifier. A logic level high enables the op amp. A valid logic high is defined as 2.5V greater than the negative supply applied to the enable pin. A valid logic low is defined as < 0.8V greater than the negative supply pin. If dual or split power supplies are used, establish that logic input signals are properly referred to the negative supply voltage. If this pin is not connected to a valid high or low voltage, the internal circuitry pulls the node high and enables the device to function.

The logic input is a high-impedance CMOS input. For battery-operated applications, this feature is used to greatly reduce the average current and extend battery life. The enable time is 10 μ s, and the disable time is 1 μ s. When disabled, the output assumes a high-impedance state. This state allows the OPA300 to be operated as a gated amplifier, or to have the output multiplexed onto a common analog output bus.

7 Application and Implementation

Note

Information in the following applications sections is not part of the TI component specification, and TI does not warrant its accuracy or completeness. TI's customers are responsible for determining suitability of components for their purposes, as well as validating and testing their design implementation to confirm system functionality.

7.1 Application Information

The OPA300 and OPA301 series of single-supply CMOS op amps are designed to interface with high-speed 16-bit analog-to-digital converters (ADCs). Featuring wide 150MHz bandwidth, fast 150ns settling time to 16 bits, and high open loop gain, this series offers excellent performance in a small SO-8 and tiny SOT23 packages.

7.2 Typical Application

7.2.1 Driving Capacitive Loads

When using high-speed operational amplifiers, it is extremely important to consider the effects of capacitive loading on amplifier stability. Capacitive loading will interact with the output impedance of the operational amplifier, and depending on the capacitor value, can significantly decrease the gain bandwidth, as well as introduce peaking. To reduce the effects of capacitive loading and allow for additional capacitive load drive, place a series resistor between the output and the load. This will reduce available bandwidth, but permit stable operation with capacitive loading. [Figure 7-1](#) illustrates the recommended relationship between the resistor and capacitor values.

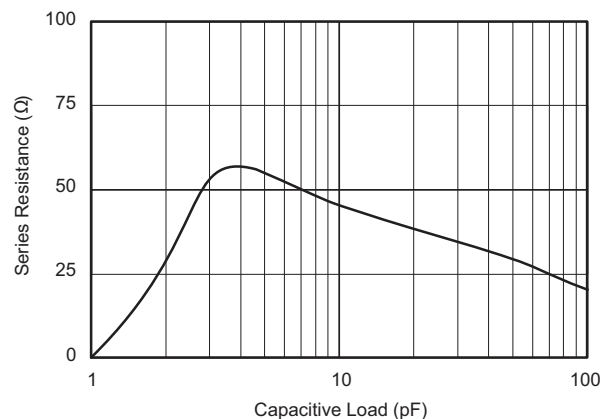

Figure 7-1. Recommended RS and CL Combinations

Amplifiers configured in unity gain are most susceptible to stability issues. The typical characteristic, [Figure 5-16](#) describes the relationship between capacitive load and stability for the OPA300/OPA301 series. In unity gain, the OPA300/OPA301 series is capable of driving a few picofarads of capacitive load without compromising stability. Board level parasitic capacitance can often fall into the range of a picofarad or more, and must be minimized through good circuit-board layout practices to avoid compromising the stability of the OPA300/OPA301. For more information on detecting parasitics during testing, see the Application Note [Measuring Board Parasitics in High-Speed Analog Design](#), available at the TI web site www.ti.com.

7.2.2 Driving 16 Bit ADC

The OPA300/OPA301 series feature excellent THD+noise, even at frequencies greater than 1MHz, with a 16-bit settling time of 150ns. [Figure 7-2](#) shows a total single supply option for high-speed data acquisition. The OPA300/OPA301 directly drives the ADS8401, a 1.25 mega sample per second (MSPS) 16-bit data converter. The OPA300/OPA301 is configured in an inverting gain of 1, with a 5V single supply. Results of the OPA300/OPA301 performance are summarized in [Table 7-1](#)

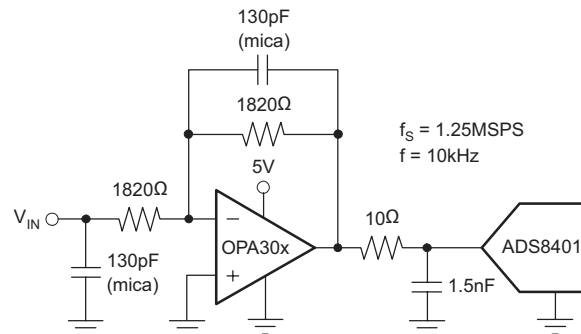

Figure 7-2. The OPA30x Drives the 16-Bit ADS8401

Table 7-1. OPA30x Performance Results Driving a 1.25MSPS ADS8401

PARAMETER	RESULTS $f = 10\text{kHz}$
THD	-99.3dB
SFDR	101.2dB
THS+N	84.2dB
SNR	84.3dB

7.3 Layout

7.3.1 Layout Guidelines

As with most high-speed operational amplifiers, board layout requires special attention to maximize AC and DC performance. Extensive use of ground planes, short lead lengths, and high-quality bypass capacitors will minimize leakage that can compromise signal quality. Guard rings applied with potential as near to the input pins as possible help minimize board leakage.

8 Device and Documentation Support

TI offers an extensive line of development tools. Tools and software to evaluate the performance of the device, generate code, and develop solutions are listed below.

8.1 Receiving Notification of Documentation Updates

To receive notification of documentation updates, navigate to the device product folder on ti.com. Click on *Notifications* to register and receive a weekly digest of any product information that has changed. For change details, review the revision history included in any revised document.

8.2 Support Resources

TI E2E™ [support forums](#) are an engineer's go-to source for fast, verified answers and design help — straight from the experts. Search existing answers or ask your own question to get the quick design help you need.

Linked content is provided "AS IS" by the respective contributors. They do not constitute TI specifications and do not necessarily reflect TI's views; see TI's [Terms of Use](#).

8.3 Trademarks

TI E2E™ is a trademark of Texas Instruments.
All trademarks are the property of their respective owners.

8.4 Electrostatic Discharge Caution



This integrated circuit can be damaged by ESD. Texas Instruments recommends that all integrated circuits be handled with appropriate precautions. Failure to observe proper handling and installation procedures can cause damage.

ESD damage can range from subtle performance degradation to complete device failure. Precision integrated circuits may be more susceptible to damage because very small parametric changes could cause the device not to meet its published specifications.

8.5 Glossary

[TI Glossary](#) This glossary lists and explains terms, acronyms, and definitions.

9 Revision History

NOTE: Page numbers for previous revisions may differ from page numbers in the current version.

Changes from Revision E (January 2026) to Revision F (February 2026)	Page
• Updated Figure 4-5 and Figure 4-6	3

Changes from Revision D (June 2007) to Revision E (January 2026)	Page
• Updated data sheet to new format.....	1

10 Mechanical, Packaging, and Orderable Information

The following pages include mechanical, packaging, and orderable information. This information is the most current data available for the designated devices. This data is subject to change without notice and revision of this document. For browser-based versions of this data sheet, refer to the left-hand navigation.

PACKAGING INFORMATION

Orderable part number	Status (1)	Material type (2)	Package Pins	Package qty Carrier	RoHS (3)	Lead finish/ Ball material (4)	MSL rating/ Peak reflow (5)	Op temp (°C)	Part marking (6)
OPA2300AIDGSR	Active	Production	VSSOP (DGS) 10	2500 LARGE T&R	Yes	NIPDAUAG	Level-2-260C-1 YEAR	-40 to 125	C01
OPA2300AIDGSR.A	Active	Production	VSSOP (DGS) 10	2500 LARGE T&R	Yes	NIPDAUAG	Level-2-260C-1 YEAR	-40 to 125	C01
OPA2300AIDGST	Active	Production	VSSOP (DGS) 10	250 SMALL T&R	Yes	NIPDAUAG	Level-2-260C-1 YEAR	-40 to 125	C01
OPA2300AIDGST.A	Active	Production	VSSOP (DGS) 10	250 SMALL T&R	Yes	NIPDAUAG	Level-2-260C-1 YEAR	-40 to 125	C01
OPA2301AID	Active	Production	SOIC (D) 8	75 TUBE	Yes	NIPDAU	Level-2-260C-1 YEAR	-40 to 125	OPA 2301A
OPA2301AID.A	Active	Production	SOIC (D) 8	75 TUBE	Yes	NIPDAU	Level-2-260C-1 YEAR	-40 to 125	OPA 2301A
OPA2301AIDGKR	Active	Production	VSSOP (DGK) 8	2500 LARGE T&R	Yes	Call TI Nipdauag Nipdau	Level-2-260C-1 YEAR	-40 to 125	OAWM
OPA2301AIDGKR.A	Active	Production	VSSOP (DGK) 8	2500 LARGE T&R	Yes	NIPDAU	Level-2-260C-1 YEAR	-40 to 125	OAWM
OPA2301AIDGKT	Active	Production	VSSOP (DGK) 8	250 SMALL T&R	Yes	Call TI Nipdauag Nipdau	Level-2-260C-1 YEAR	-40 to 125	OAWM
OPA2301AIDGKT.A	Active	Production	VSSOP (DGK) 8	250 SMALL T&R	Yes	NIPDAU	Level-2-260C-1 YEAR	-40 to 125	OAWM
OPA2301AIDR	Active	Production	SOIC (D) 8	2500 LARGE T&R	Yes	NIPDAU	Level-2-260C-1 YEAR	-40 to 125	OPA 2301A
OPA2301AIDR.A	Active	Production	SOIC (D) 8	2500 LARGE T&R	Yes	NIPDAU	Level-2-260C-1 YEAR	-40 to 125	OPA 2301A
OPA300AID	Active	Production	SOIC (D) 8	75 TUBE	Yes	NIPDAU	Level-2-260C-1 YEAR	-40 to 125	OPA 300A
OPA300AID.A	Active	Production	SOIC (D) 8	75 TUBE	Yes	NIPDAU	Level-2-260C-1 YEAR	-40 to 125	OPA 300A
OPA300AIDBVR	Active	Production	SOT-23 (DBV) 6	3000 LARGE T&R	Yes	NIPDAU	Level-2-260C-1 YEAR	-40 to 125	A52
OPA300AIDBVR.A	Active	Production	SOT-23 (DBV) 6	3000 LARGE T&R	Yes	NIPDAU	Level-2-260C-1 YEAR	-40 to 125	A52
OPA300AIDBVT	Active	Production	SOT-23 (DBV) 6	250 SMALL T&R	Yes	NIPDAU	Level-2-260C-1 YEAR	-40 to 125	A52
OPA300AIDBVT.A	Active	Production	SOT-23 (DBV) 6	250 SMALL T&R	Yes	NIPDAU	Level-2-260C-1 YEAR	-40 to 125	A52
OPA301AID	Active	Production	SOIC (D) 8	75 TUBE	Yes	NIPDAU	Level-2-260C-1 YEAR	-40 to 125	OPA 301A
OPA301AID.A	Active	Production	SOIC (D) 8	75 TUBE	Yes	NIPDAU	Level-2-260C-1 YEAR	-40 to 125	OPA 301A
OPA301AIDBVR	Active	Production	SOT-23 (DBV) 5	3000 LARGE T&R	Yes	NIPDAU	Level-2-260C-1 YEAR	-40 to 125	AUP
OPA301AIDBVR.A	Active	Production	SOT-23 (DBV) 5	3000 LARGE T&R	Yes	NIPDAU	Level-2-260C-1 YEAR	-40 to 125	AUP

Orderable part number	Status (1)	Material type (2)	Package Pins	Package qty Carrier	RoHS (3)	Lead finish/ Ball material (4)	MSL rating/ Peak reflow (5)	Op temp (°C)	Part marking (6)
OPA301AIDBVRG4	Active	Production	SOT-23 (DBV) 5	3000 LARGE T&R	Yes	NIPDAU	Level-2-260C-1 YEAR	-40 to 125	AUP
OPA301AIDBVRG4.A	Active	Production	SOT-23 (DBV) 5	3000 LARGE T&R	Yes	NIPDAU	Level-2-260C-1 YEAR	-40 to 125	AUP
OPA301AIDBVT	Active	Production	SOT-23 (DBV) 5	250 SMALL T&R	Yes	NIPDAU	Level-2-260C-1 YEAR	-40 to 125	AUP
OPA301AIDBVT.A	Active	Production	SOT-23 (DBV) 5	250 SMALL T&R	Yes	NIPDAU	Level-2-260C-1 YEAR	-40 to 125	AUP
OPA301AIDR	Active	Production	SOIC (D) 8	2500 LARGE T&R	Yes	NIPDAU	Level-2-260C-1 YEAR	-40 to 125	OPA 301A
OPA301AIDR.A	Active	Production	SOIC (D) 8	2500 LARGE T&R	Yes	NIPDAU	Level-2-260C-1 YEAR	-40 to 125	OPA 301A

(1) **Status:** For more details on status, see our [product life cycle](#).

(2) **Material type:** When designated, preproduction parts are prototypes/experimental devices, and are not yet approved or released for full production. Testing and final process, including without limitation quality assurance, reliability performance testing, and/or process qualification, may not yet be complete, and this item is subject to further changes or possible discontinuation. If available for ordering, purchases will be subject to an additional waiver at checkout, and are intended for early internal evaluation purposes only. These items are sold without warranties of any kind.

(3) **RoHS values:** Yes, No, RoHS Exempt. See the [TI RoHS Statement](#) for additional information and value definition.

(4) **Lead finish/Ball material:** Parts may have multiple material finish options. Finish options are separated by a vertical ruled line. Lead finish/Ball material values may wrap to two lines if the finish value exceeds the maximum column width.

(5) **MSL rating/Peak reflow:** The moisture sensitivity level ratings and peak solder (reflow) temperatures. In the event that a part has multiple moisture sensitivity ratings, only the lowest level per JEDEC standards is shown. Refer to the shipping label for the actual reflow temperature that will be used to mount the part to the printed circuit board.

(6) **Part marking:** There may be an additional marking, which relates to the logo, the lot trace code information, or the environmental category of the part.

Multiple part markings will be inside parentheses. Only one part marking contained in parentheses and separated by a "-" will appear on a part. If a line is indented then it is a continuation of the previous line and the two combined represent the entire part marking for that device.

Important Information and Disclaimer: The information provided on this page represents TI's knowledge and belief as of the date that it is provided. TI bases its knowledge and belief on information provided by third parties, and makes no representation or warranty as to the accuracy of such information. Efforts are underway to better integrate information from third parties. TI has taken and continues to take reasonable steps to provide representative and accurate information but may not have conducted destructive testing or chemical analysis on incoming materials and chemicals. TI and TI suppliers consider certain information to be proprietary, and thus CAS numbers and other limited information may not be available for release.

In no event shall TI's liability arising out of such information exceed the total purchase price of the TI part(s) at issue in this document sold by TI to Customer on an annual basis.

TAPE AND REEL INFORMATION

QUADRANT ASSIGNMENTS FOR PIN 1 ORIENTATION IN TAPE

*All dimensions are nominal

Device	Package Type	Package Drawing	Pins	SPQ	Reel Diameter (mm)	Reel Width W1 (mm)	A0 (mm)	B0 (mm)	K0 (mm)	P1 (mm)	W (mm)	Pin1 Quadrant
OPA2300AIDGSR	VSSOP	DGS	10	2500	330.0	12.4	5.3	3.4	1.4	8.0	12.0	Q1
OPA2300AIDGST	VSSOP	DGS	10	250	180.0	12.4	5.3	3.4	1.4	8.0	12.0	Q1
OPA2301AIDGKR	VSSOP	DGK	8	2500	330.0	12.4	5.3	3.4	1.4	8.0	12.0	Q1
OPA2301AIDGKT	VSSOP	DGK	8	250	180.0	12.4	5.3	3.4	1.4	8.0	12.0	Q1
OPA2301AIDR	SOIC	D	8	2500	330.0	12.4	6.4	5.2	2.1	8.0	12.0	Q1
OPA300AIDBVR	SOT-23	DBV	6	3000	178.0	9.0	3.23	3.17	1.37	4.0	8.0	Q3
OPA300AIDBVT	SOT-23	DBV	6	250	178.0	9.0	3.23	3.17	1.37	4.0	8.0	Q3
OPA301AIDBVR	SOT-23	DBV	5	3000	178.0	9.0	3.3	3.2	1.4	4.0	8.0	Q3
OPA301AIDBVRG4	SOT-23	DBV	5	3000	178.0	9.0	3.3	3.2	1.4	4.0	8.0	Q3
OPA301AIDBVT	SOT-23	DBV	5	250	178.0	9.0	3.3	3.2	1.4	4.0	8.0	Q3
OPA301AIDR	SOIC	D	8	2500	330.0	12.4	6.4	5.2	2.1	8.0	12.0	Q1

TAPE AND REEL BOX DIMENSIONS

*All dimensions are nominal

Device	Package Type	Package Drawing	Pins	SPQ	Length (mm)	Width (mm)	Height (mm)
OPA2300AIDGSR	VSSOP	DGS	10	2500	353.0	353.0	32.0
OPA2300AIDGST	VSSOP	DGS	10	250	213.0	191.0	35.0
OPA2301AIDGKR	VSSOP	DGK	8	2500	353.0	353.0	32.0
OPA2301AIDGKT	VSSOP	DGK	8	250	213.0	191.0	35.0
OPA2301AIDR	SOIC	D	8	2500	353.0	353.0	32.0
OPA300AIDBVR	SOT-23	DBV	6	3000	445.0	220.0	345.0
OPA300AIDBVT	SOT-23	DBV	6	250	445.0	220.0	345.0
OPA301AIDBVR	SOT-23	DBV	5	3000	180.0	180.0	18.0
OPA301AIDBVRG4	SOT-23	DBV	5	3000	180.0	180.0	18.0
OPA301AIDBVT	SOT-23	DBV	5	250	180.0	180.0	18.0
OPA301AIDR	SOIC	D	8	2500	353.0	353.0	32.0

TUBE

*All dimensions are nominal

Device	Package Name	Package Type	Pins	SPQ	L (mm)	W (mm)	T (μm)	B (mm)
OPA2301AID	D	SOIC	8	75	506.6	8	3940	4.32
OPA2301AID.A	D	SOIC	8	75	506.6	8	3940	4.32
OPA300AID	D	SOIC	8	75	506.6	8	3940	4.32
OPA300AID.A	D	SOIC	8	75	506.6	8	3940	4.32
OPA301AID	D	SOIC	8	75	506.6	8	3940	4.32
OPA301AID.A	D	SOIC	8	75	506.6	8	3940	4.32



DBV0005A

PACKAGE OUTLINE

SOT-23 - 1.45 mm max height

SMALL OUTLINE TRANSISTOR

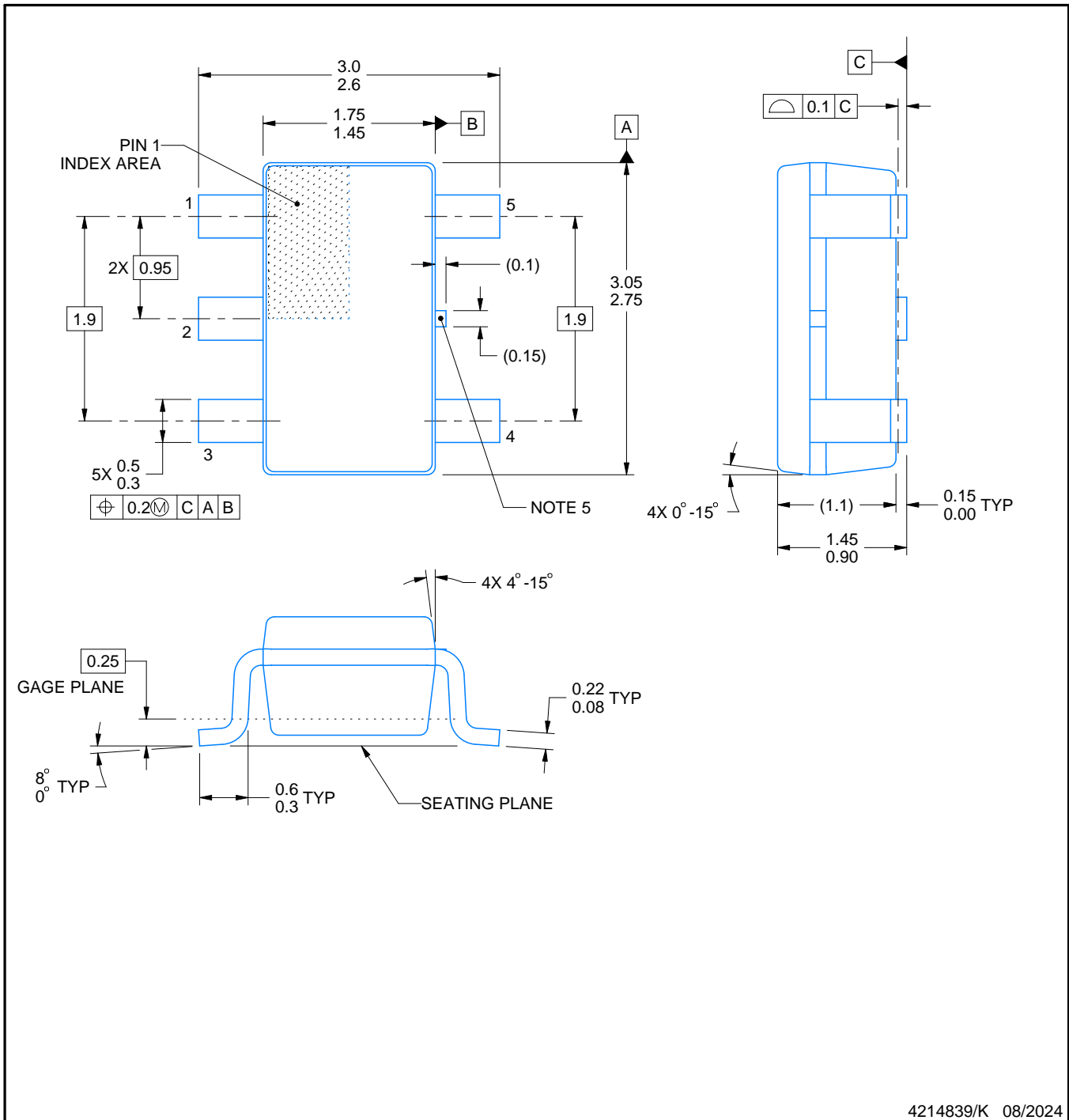

NOTES:

1. All linear dimensions are in millimeters. Any dimensions in parenthesis are for reference only. Dimensioning and tolerancing per ASME Y14.5M.
2. This drawing is subject to change without notice.
3. Reference JEDEC MO-178.
4. Body dimensions do not include mold flash, protrusions, or gate burrs. Mold flash, protrusions, or gate burrs shall not exceed 0.25 mm per side.
5. Support pin may differ or may not be present.

EXAMPLE BOARD LAYOUT

DBV0005A

SOT-23 - 1.45 mm max height

SMALL OUTLINE TRANSISTOR



LAND PATTERN EXAMPLE
EXPOSED METAL SHOWN
SCALE:15X



SOLDER MASK DETAILS

4214839/K 08/2024

NOTES: (continued)

- 6. Publication IPC-7351 may have alternate designs.
- 7. Solder mask tolerances between and around signal pads can vary based on board fabrication site.

EXAMPLE STENCIL DESIGN

DBV0005A

SOT-23 - 1.45 mm max height

SMALL OUTLINE TRANSISTOR



SOLDER PASTE EXAMPLE
BASED ON 0.125 mm THICK STENCIL
SCALE:15X

4214839/K 08/2024

NOTES: (continued)

8. Laser cutting apertures with trapezoidal walls and rounded corners may offer better paste release. IPC-7525 may have alternate design recommendations.
9. Board assembly site may have different recommendations for stencil design.

DGK0008A



PACKAGE OUTLINE

VSSOP - 1.1 mm max height

SMALL OUTLINE PACKAGE



4214862/A 04/2023

NOTES:

PowerPAD is a trademark of Texas Instruments.

1. All linear dimensions are in millimeters. Any dimensions in parenthesis are for reference only. Dimensioning and tolerancing per ASME Y14.5M.
2. This drawing is subject to change without notice.
3. This dimension does not include mold flash, protrusions, or gate burrs. Mold flash, protrusions, or gate burrs shall not exceed 0.15 mm per side.
4. This dimension does not include interlead flash. Interlead flash shall not exceed 0.25 mm per side.
5. Reference JEDEC registration MO-187.

EXAMPLE BOARD LAYOUT

DGK0008A

™ VSSOP - 1.1 mm max height

SMALL OUTLINE PACKAGE



LAND PATTERN EXAMPLE
EXPOSED METAL SHOWN
SCALE: 15X



SOLDER MASK DETAILS

4214862/A 04/2023

NOTES: (continued)

6. Publication IPC-7351 may have alternate designs.
7. Solder mask tolerances between and around signal pads can vary based on board fabrication site.
8. Vias are optional depending on application, refer to device data sheet. If any vias are implemented, refer to their locations shown on this view. It is recommended that vias under paste be filled, plugged or tented.
9. Size of metal pad may vary due to creepage requirement.

EXAMPLE STENCIL DESIGN

DGK0008A

TM VSSOP - 1.1 mm max height

SMALL OUTLINE PACKAGE



SOLDER PASTE EXAMPLE
SCALE: 15X

4214862/A 04/2023

NOTES: (continued)

11. Laser cutting apertures with trapezoidal walls and rounded corners may offer better paste release. IPC-7525 may have alternate design recommendations.
12. Board assembly site may have different recommendations for stencil design.

DGS0010A



PACKAGE OUTLINE

VSSOP - 1.1 mm max height

SMALL OUTLINE PACKAGE



4221984/A 05/2015

NOTES:

1. All linear dimensions are in millimeters. Any dimensions in parenthesis are for reference only. Dimensioning and tolerancing per ASME Y14.5M.
2. This drawing is subject to change without notice.
3. This dimension does not include mold flash, protrusions, or gate burrs. Mold flash, protrusions, or gate burrs shall not exceed 0.15 mm per side.
4. This dimension does not include interlead flash. Interlead flash shall not exceed 0.25 mm per side.
5. Reference JEDEC registration MO-187, variation BA.

EXAMPLE BOARD LAYOUT

DGS0010A

VSSOP - 1.1 mm max height

SMALL OUTLINE PACKAGE



LAND PATTERN EXAMPLE
SCALE:10X



SOLDER MASK DETAILS
NOT TO SCALE

4221984/A 05/2015

NOTES: (continued)

- 6. Publication IPC-7351 may have alternate designs.
- 7. Solder mask tolerances between and around signal pads can vary based on board fabrication site.

EXAMPLE STENCIL DESIGN

DGS0010A

VSSOP - 1.1 mm max height

SMALL OUTLINE PACKAGE



SOLDER PASTE EXAMPLE
BASED ON 0.125 mm THICK STENCIL
SCALE:10X

4221984/A 05/2015

NOTES: (continued)

8. Laser cutting apertures with trapezoidal walls and rounded corners may offer better paste release. IPC-7525 may have alternate design recommendations.
9. Board assembly site may have different recommendations for stencil design.



D0008A

PACKAGE OUTLINE

SOIC - 1.75 mm max height

SMALL OUTLINE INTEGRATED CIRCUIT



4214825/C 02/2019

NOTES:

1. Linear dimensions are in inches [millimeters]. Dimensions in parenthesis are for reference only. Controlling dimensions are in inches. Dimensioning and tolerancing per ASME Y14.5M.
2. This drawing is subject to change without notice.
3. This dimension does not include mold flash, protrusions, or gate burrs. Mold flash, protrusions, or gate burrs shall not exceed .006 [0.15] per side.
4. This dimension does not include interlead flash.
5. Reference JEDEC registration MS-012, variation AA.

EXAMPLE BOARD LAYOUT

D0008A

SOIC - 1.75 mm max height

SMALL OUTLINE INTEGRATED CIRCUIT



LAND PATTERN EXAMPLE
 EXPOSED METAL SHOWN
 SCALE:8X



SOLDER MASK DETAILS

4214825/C 02/2019

NOTES: (continued)

- 6. Publication IPC-7351 may have alternate designs.
- 7. Solder mask tolerances between and around signal pads can vary based on board fabrication site.

EXAMPLE STENCIL DESIGN

D0008A

SOIC - 1.75 mm max height

SMALL OUTLINE INTEGRATED CIRCUIT



SOLDER PASTE EXAMPLE
BASED ON .005 INCH [0.125 MM] THICK STENCIL
SCALE:8X

4214825/C 02/2019

NOTES: (continued)

8. Laser cutting apertures with trapezoidal walls and rounded corners may offer better paste release. IPC-7525 may have alternate design recommendations.
9. Board assembly site may have different recommendations for stencil design.

DBV0006A



PACKAGE OUTLINE

SOT-23 - 1.45 mm max height

SMALL OUTLINE TRANSISTOR

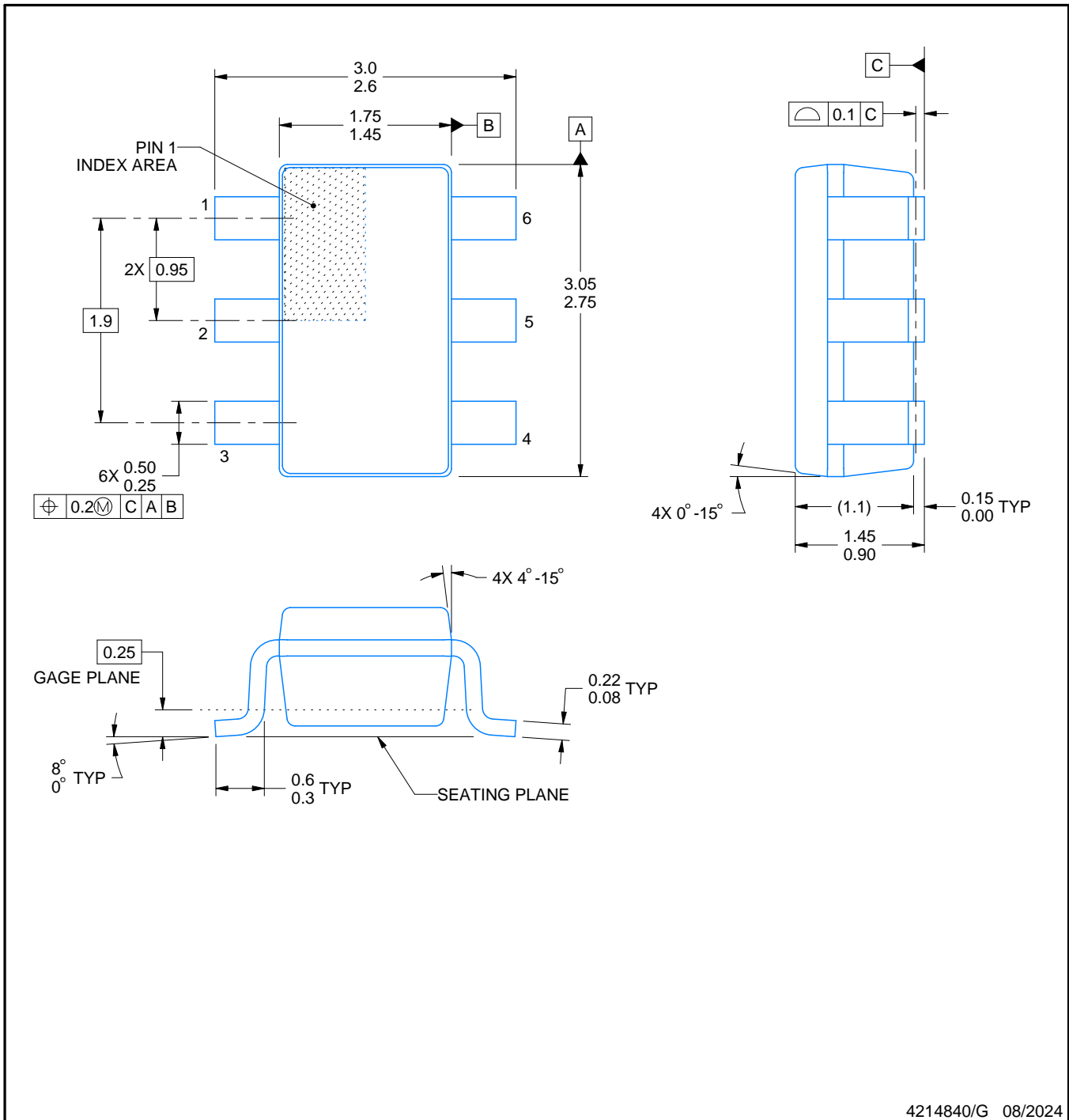

4214840/G 08/2024

NOTES:

1. All linear dimensions are in millimeters. Any dimensions in parenthesis are for reference only. Dimensioning and tolerancing per ASME Y14.5M.
2. This drawing is subject to change without notice.
3. Body dimensions do not include mold flash or protrusion. Mold flash and protrusion shall not exceed 0.25 per side.
4. Leads 1,2,3 may be wider than leads 4,5,6 for package orientation.
5. Reference JEDEC MO-178.

EXAMPLE BOARD LAYOUT

DBV0006A

SOT-23 - 1.45 mm max height

SMALL OUTLINE TRANSISTOR



LAND PATTERN EXAMPLE
EXPOSED METAL SHOWN
SCALE:15X

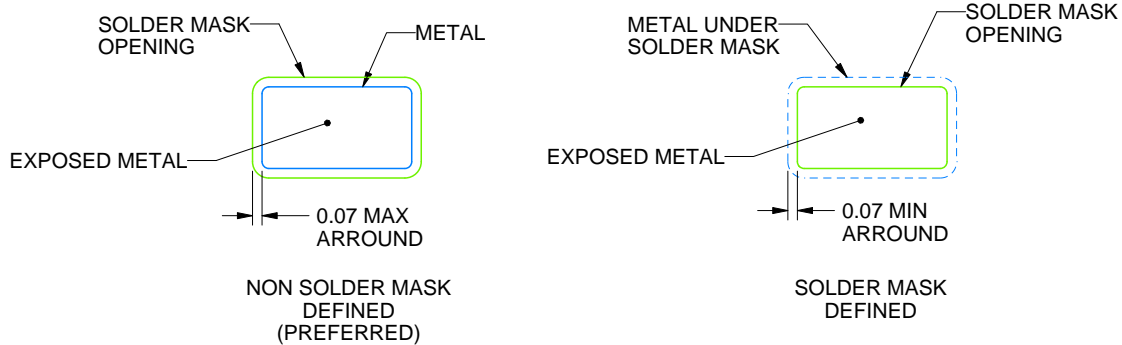

SOLDER MASK DETAILS

4214840/G 08/2024

NOTES: (continued)

6. Publication IPC-7351 may have alternate designs.
7. Solder mask tolerances between and around signal pads can vary based on board fabrication site.

EXAMPLE STENCIL DESIGN

DBV0006A

SOT-23 - 1.45 mm max height

SMALL OUTLINE TRANSISTOR



SOLDER PASTE EXAMPLE
BASED ON 0.125 mm THICK STENCIL
SCALE:15X

4214840/G 08/2024

NOTES: (continued)

8. Laser cutting apertures with trapezoidal walls and rounded corners may offer better paste release. IPC-7525 may have alternate design recommendations.
9. Board assembly site may have different recommendations for stencil design.

IMPORTANT NOTICE AND DISCLAIMER

TI PROVIDES TECHNICAL AND RELIABILITY DATA (INCLUDING DATASHEETS), DESIGN RESOURCES (INCLUDING REFERENCE DESIGNS), APPLICATION OR OTHER DESIGN ADVICE, WEB TOOLS, SAFETY INFORMATION, AND OTHER RESOURCES "AS IS" AND WITH ALL FAULTS, AND DISCLAIMS ALL WARRANTIES, EXPRESS AND IMPLIED, INCLUDING WITHOUT LIMITATION ANY IMPLIED WARRANTIES OF MERCHANTABILITY, FITNESS FOR A PARTICULAR PURPOSE OR NON-INFRINGEMENT OF THIRD PARTY INTELLECTUAL PROPERTY RIGHTS.

These resources are intended for skilled developers designing with TI products. You are solely responsible for (1) selecting the appropriate TI products for your application, (2) designing, validating and testing your application, and (3) ensuring your application meets applicable standards, and any other safety, security, regulatory or other requirements.

These resources are subject to change without notice. TI grants you permission to use these resources only for development of an application that uses the TI products described in the resource. Other reproduction and display of these resources is prohibited. No license is granted to any other TI intellectual property right or to any third party intellectual property right. TI disclaims responsibility for, and you fully indemnify TI and its representatives against any claims, damages, costs, losses, and liabilities arising out of your use of these resources.

TI's products are provided subject to [TI's Terms of Sale](#), [TI's General Quality Guidelines](#), or other applicable terms available either on ti.com or provided in conjunction with such TI products. TI's provision of these resources does not expand or otherwise alter TI's applicable warranties or warranty disclaimers for TI products. Unless TI explicitly designates a product as custom or customer-specified, TI products are standard, catalog, general purpose devices.

TI objects to and rejects any additional or different terms you may propose.

Copyright © 2026, Texas Instruments Incorporated

Last updated 10/2025