

# TLV906xS 10MHz, RRIO, CMOS Operational Amplifiers for Cost-Sensitive Systems

## 1 Features

- Rail-to-rail input and output
- Low input offset voltage:  $\pm 0.3\text{mV}$
- Unity-gain bandwidth: 10MHz
- Low broadband noise:  $10\text{nV}/\sqrt{\text{Hz}}$
- Low input bias current: 0.5pA
- Low quiescent current: 538 $\mu\text{A}$
- Unity-gain stable
- Internal RFI and EMI filter
- Operational at supply voltages as low as 1.8V
- Easier to stabilize with higher capacitive load due to resistive open-loop output impedance
- Shutdown version: TLV906xS
- Extended temperature range:  $-40^{\circ}\text{C}$  to  $125^{\circ}\text{C}$

## 2 Applications

- [E-bikes](#)
- [Smoke detectors](#)
- [HVAC: heating, ventilating, and air conditioning](#)
- [Motor control: AC induction](#)
- [Refrigerators](#)
- [Wearable devices](#)
- [Laptop computers](#)
- [Washing machines](#)
- [Sensor signal conditioning](#)
- [Power modules](#)
- [Barcode scanners](#)
- [Active Filters](#)
- [Low-side current sensing](#)

## 3 Description

The TLV9061 (single), TLV9062 (dual), and TLV9064 (quad) are single-, dual-, and quad- low-voltage, 1.8V to 5.5V operational amplifiers, op amps) with rail-to-rail input and output swing capabilities.

These devices are highly cost-effective options for applications where low-voltage operation, a small footprint, and high capacitive load drive are required.

Although the capacitive load drive of the TLV906x is 100pF, the resistive open-loop output impedance makes stabilizing with higher capacitive loads simpler. These op amps are designed specifically for low-voltage operation (1.8V to 5.5V), with performance specifications similar to the OPAx316 and TLVx316 devices.

The TLV906xS devices include a shutdown mode that allow the amplifiers to switch into standby mode with typical current consumption less than 1 $\mu\text{A}$ .

The TLV906xS family helps simplify system design, because the family is unity-gain stable, integrates the RFI and EMI rejection filter, and provides no phase reversal in overdrive condition.

*Micro* size packages, such as X2SON and X2QFN, are offered for all the channel variants (single, dual and quad), along with industry-standard packages, such as SOIC, MSOP, SOT-23, and TSSOP.

### Device Information

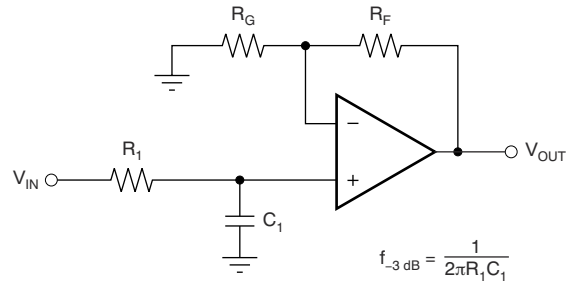
PART NUMBER <sup>(3)</sup>	PACKAGE <sup>(1)</sup>	BODY SIZE (NOM) <sup>(4)</sup>
TLV9061	DBV (SOT-23, 5)	2.90mm × 1.60 mm
	DCK (SC70, 5)	2.00mm × 1.25 mm
	DRL (SOT-553, 5) <sup>(2)</sup>	1.60mm × 1.20 mm
	DPW (X2SON, 5)	0.80mm × 0.80mm
TLV9061S	DBV (SOT-23, 6)	2.90mm × 1.60 mm
	DRY (USON, 6)	1.45mm × 1.00 mm
TLV9062	D (SOIC, 8)	4.90mm × 3.90 mm
	PW (TSSOP, 8)	3.00mm × 4.40 mm
	DGK (VSSOP, 8)	3.00mm × 3.00 mm
	DDF (SOT-23, 8)	2.90mm × 1.60 mm
	DSG (WSON, 8)	2.00mm × 2.00 mm
TLV9062S	DGS (VSSOP, 10)	3.00mm × 3.00 mm
	RUG (X2QFN, 10)	2.00mm × 1.50mm
	YCK (DSBGA, 9)	1.00mm × 1.00mm
TLV9064	D (SOIC, 14)	8.65mm × 3.90 mm
	PW (TSSOP, 14)	5.00mm × 4.40 mm
	RTE (WQFN, 16)	3.00mm × 3.00mm
	RUC (X2QFN, 14)	2.00mm × 2.00mm
TLV9064S	RTE (WQFN, 16)	3.00mm × 3.00mm

- (1) For all available packages, see [Section 10](#).
- (2) Package is preview only.
- (3) See [Device Comparison](#).
- (4) The body size (length × width) is a nominal value and does not include pins.



**TLV9061, TLV9062, TLV9064**

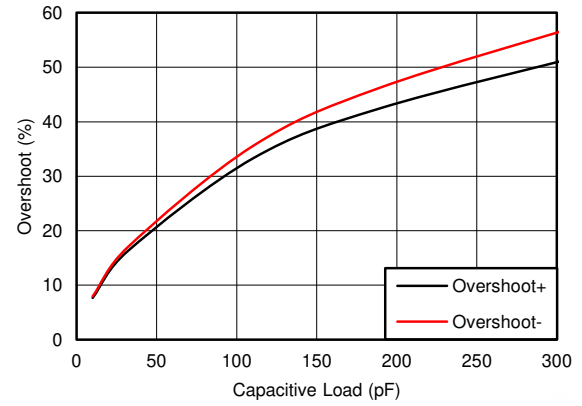
SBOS839M – MARCH 2017 – REVISED DECEMBER 2024



$$f_{-3\text{ dB}} = \frac{1}{2\pi R_1 C_1}$$

$$\frac{V_{\text{OUT}}}{V_{\text{IN}}} = \left(1 + \frac{R_F}{R_G}\right) \left(\frac{1}{1 + sR_1 C_1}\right)$$

**Single-Pole, Low-Pass Filter**



**Small-Signal Overshoot vs Load Capacitance**

## Table of Contents

<b>1 Features</b> .....	<b>1</b>	6.2 Functional Block Diagram.....	<b>20</b>
<b>2 Applications</b> .....	<b>1</b>	6.3 Feature Description.....	<b>21</b>
<b>3 Description</b> .....	<b>1</b>	6.4 Device Functional Modes.....	<b>22</b>
<b>4 Pin Configuration and Functions</b> .....	<b>4</b>	<b>7 Application and Implementation</b> .....	<b>23</b>
<b>5 Specifications</b> .....	<b>9</b>	7.1 Application Information.....	<b>23</b>
5.1 Absolute Maximum Ratings.....	<b>9</b>	7.2 Typical Applications.....	<b>23</b>
5.2 ESD Ratings.....	<b>9</b>	7.3 Power Supply Recommendations.....	<b>24</b>
5.3 Recommended Operating Conditions.....	<b>9</b>	7.4 Layout.....	<b>26</b>
5.4 Thermal Information: TLV9061.....	<b>10</b>	<b>8 Device and Documentation Support</b> .....	<b>28</b>
5.5 Thermal Information: TLV9061S.....	<b>10</b>	8.1 Documentation Support.....	<b>28</b>
5.6 Thermal Information: TLV9062.....	<b>10</b>	8.2 Receiving Notification of Documentation Updates.....	<b>28</b>
5.7 Thermal Information: TLV9062S.....	<b>11</b>	8.3 Support Resources.....	<b>28</b>
5.8 Thermal Information: TLV9064.....	<b>11</b>	8.4 Trademarks.....	<b>28</b>
5.9 Thermal Information: TLV9064S.....	<b>11</b>	8.5 Electrostatic Discharge Caution.....	<b>28</b>
5.10 Electrical Characteristics.....	<b>12</b>	8.6 Glossary.....	<b>28</b>
5.11 Typical Characteristics.....	<b>14</b>	<b>9 Revision History</b> .....	<b>28</b>
<b>6 Detailed Description</b> .....	<b>20</b>	<b>10 Mechanical, Packaging, and Orderable Information</b> .....	<b>31</b>
6.1 Overview.....	<b>20</b>		

## Device Comparison Table

DEVICE	NO. OF CHANNELS	PACKAGE LEADS														
		SOIC D	USON DRY	SOT-23 DBV	SC-70 DCK	VSSOP DGK	VSSOP DGS	DSBGA YCK	X2SON DPW	SOT-55 3 DRL	WSON DSG	TSSOP PW	SOT-23 DDF	WQFN RTE	X2QFN RUC	X2QFN RUG
TLV9061	1	8	—	5	5	—	—	—	5	5	—	—	—	—	—	—
TLV9061S		—	6	6	—	—	—	—	—	—	—	—	—	—	—	—
TLV9062	2	8	—	—	—	8	10	—	—	—	8	8	8	—	—	—
TLV9062S		—	—	—	—	—	10	9	—	—	—	—	—	—	—	10
TLV9064	4	14	—	—	—	—	—	—	—	—	14	—	16	14	—	
TLV9064S		—	—	—	—	—	—	—	—	—	—	—	16	—	—	

## 4 Pin Configuration and Functions

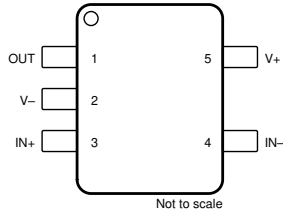


Figure 4-1. TLV9061 DBV or DRL Package, 5-Pin SOT-23 or SOT-553 (Top View)

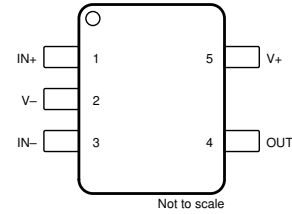


Figure 4-2. TLV9061 DCK Package, 5-Pin SC70 (Top View)

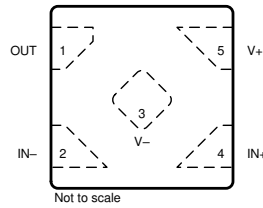


Figure 4-3. TLV9061 DPW Package, 5-Pin X2SON (Top View)

Table 4-1. Pin Functions: TLV9061

NAME	PIN			TYPE <sup>(1)</sup>	DESCRIPTION
	SOT-23, SOT-553	SC70	X2SON		
IN-	4	3	2	I	Inverting input
IN+	3	1	4	I	Noninverting input
OUT	1	4	1	O	Output
V-	2	2	3	I or —	Negative (low) supply or ground (for single-supply operation)
V+	5	5	5	I	Positive (high) supply

(1) I = input, O = output



**Figure 4-4. TLV9061S DBV Package, 6-Pin SOT-23 (Top View)**

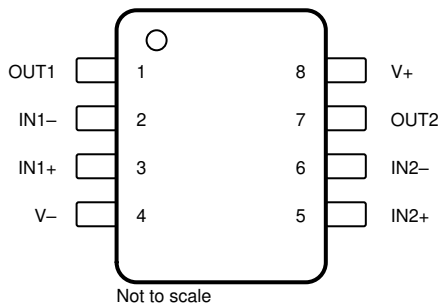


**Figure 4-5. TLV9061S DRY Package, 6-Pin USON (Top View)**

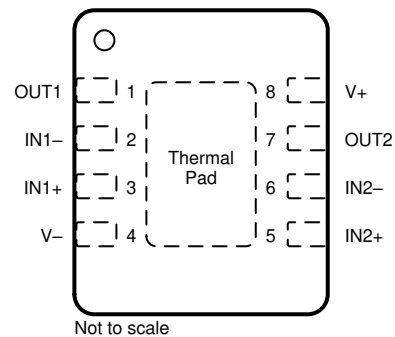
**Table 4-2. Pin Functions: TLV9061S**

NAME	PIN		TYPE <sup>(1)</sup>	DESCRIPTION
	SOT-23	USON		
IN-	4	3	I	Inverting input
IN+	3	1	I	Noninverting input
OUT	1	4	O	Output
SHDN	5	5	I	Shutdown: low = amp disabled, high = amp enabled. See <a href="#">Shutdown Function</a> section for more information.
V-	2	2	I or —	Negative (low) supply or ground (for single-supply operation)
V+	6	6	I	Positive (high) supply

(1) I = input, O = output



**Figure 4-6. TLV9062 D, DGK, PW, or DDF Package, 8-Pin SOIC, VSSOP, TSSOP, or SOT-23 (Top View)**

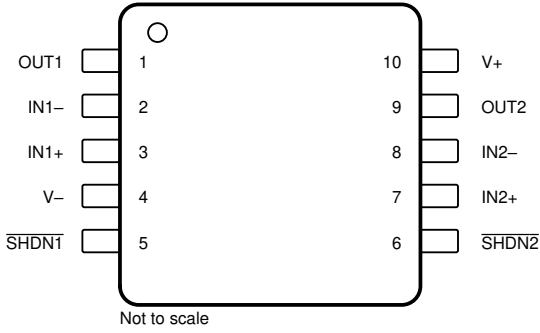


**Figure 4-7. TLV9062 DSG Package, 8-Pin WSON With Exposed Thermal Pad (Top View)**  
A. Connect thermal pad to V-

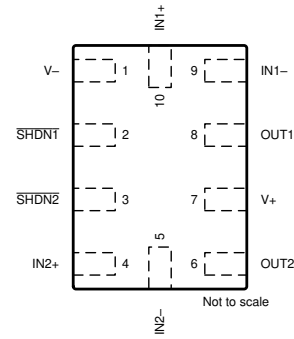
**Table 4-3. Pin Functions: TLV9062**

NAME	PIN		TYPE <sup>(1)</sup>	DESCRIPTION
	NO.			
IN1-	2		I	Inverting input, channel 1
IN1+	3		I	Noninverting input, channel 1
IN2-	6		I	Inverting input, channel 2
IN2+	5		I	Noninverting input, channel 2
OUT1	1		O	Output, channel 1
OUT2	7		O	Output, channel 2
V-	4		—	Negative (lowest) supply or ground (for single-supply operation)
V+	8		—	Positive (highest) supply

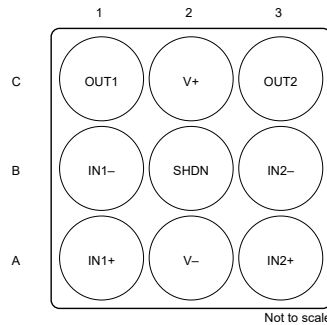
(1) I = input, O = output



**Figure 4-8. TLV9062S DGS Package, 10-Pin VSSOP (Top View)**



**Figure 4-9. TLV9062S RUG Package, 10-Pin X2QFN (Top View)**



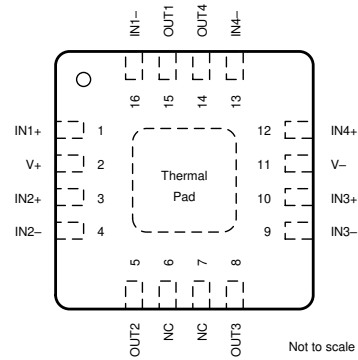
**Figure 4-10. TLV9062S YCK Package 9-Pin DSBGA (WCSP) Bottom View**

**Table 4-4. Pin Functions: TLV9062S**

NAME	PIN			I/O	DESCRIPTION
	VSSOP	X2QFN	DSBGA (WCSP)		
IN1-	2	9	B1	I	Inverting input, channel 1
IN1+	3	10	A1	I	Noninverting input, channel 1
IN2-	8	5	B3	I	Inverting input, channel 2
IN2+	7	4	A3	I	Noninverting input, channel 2
OUT1	1	8	C1	O	Output, channel 1
OUT2	9	6	C3	O	Output, channel 2
SHDN1	5	2	—	I	Shutdown: low = amp disabled, high = amp enabled, channel 1. See <a href="#">Shutdown Function</a> for more information.
SHDN2	6	3	—	I	Shutdown: low = amp disabled, high = amp enabled, channel 1. See <a href="#">Shutdown Function</a> for more information.
SHDN	—	—	B2		Shutdown: low = both amplifiers disabled, high = both amplifiers enabled
V-	4	1	A2	I or —	Negative (low) supply or ground (for single-supply operation)
V+	10	7	C2	I	Positive (high) supply



**Figure 4-11. TLV9064 RUC Package, 14-Pin X2QFN (Top View)**



**Figure 4-12. TLV9064 RTE Package, 16-Pin WQFN With Exposed Thermal Pad (Top View)**  
A. Connect thermal pad to V-



**Figure 4-13. TLV9064 D or PW Package, 14-Pin SOIC or TSSOP (Top View)**

**Table 4-5. Pin Functions: TLV9064**

NAME	PIN			TYPE <sup>(1)</sup>	DESCRIPTION
	SOIC, TSSOP	WQFN	X2QFN		
IN1-	2	16	1	I	Inverting input, channel 1
IN1+	3	1	2	I	Noninverting input, channel 1
IN2-	6	4	5	I	Inverting input, channel 2
IN2+	5	3	4	I	Noninverting input, channel 2
IN3-	9	9	8	I	Inverting input, channel 3
IN3+	10	10	9	I	Noninverting input, channel 3
IN4-	13	13	12	I	Inverting input, channel 4
IN4+	12	12	11	I	Noninverting input, channel 4
NC	—	6, 7	—	—	No internal connection
OUT1	1	15	14	O	Output, channel 1
OUT2	7	5	6	O	Output, channel 2
OUT3	8	8	7	O	Output, channel 3
OUT4	14	14	13	O	Output, channel 4
V-	11	11	10	I or —	Negative (low) supply or ground (for single-supply operation)
V+	4	2	3	I	Positive (high) supply

(1) I = input, O = output



A. Connect thermal pad to V-

**Figure 4-14. TLV9064S RTE Package, 16-Pin WQFN With Exposed Thermal Pad (Top View)**

**Table 4-6. Pin Functions: TLV9064S**

PIN		TYPE <sup>(1)</sup>	DESCRIPTION
NAME	NO.		
IN1-	16	I	Inverting input, channel 1
IN1+	1	I	Noninverting input, channel 1
IN2-	4	I	Inverting input, channel 2
IN2+	3	I	Noninverting input, channel 2
IN3-	9	I	Inverting input, channel 3
IN3+	10	I	Noninverting input, channel 3
IN4-	13	I	Inverting input, channel 4
IN4+	12	I	Noninverting input, channel 4
OUT1	15	O	Output, channel 1
OUT2	5	O	Output, channel 2
OUT3	8	O	Output, channel 3
OUT4	14	O	Output, channel 4
SHDN12	6	I	Shutdown: low = amp disabled, high = amp enabled. Channel 1. See <a href="#">Shutdown Function</a> section for more information.
SHDN34	7	I	Shutdown: low = amp disabled, high = amp enabled. Channel 1. See <a href="#">Shutdown Function</a> section for more information.
V-	11	I or —	Negative (low) supply or ground (for single-supply operation)
V+	2	I	Positive (high) supply

(1) I = input, O = output

## 5 Specifications

### 5.1 Absolute Maximum Ratings

over operating ambient temperature (unless otherwise noted)<sup>(1)</sup>

		MIN	MAX	UNIT	
Supply voltage [(V+) – (V–)]		0	6	V	
Signal input pins	Voltage <sup>(2)</sup>	Common-mode	(V–) – 0.5	(V+) + 0.5	V
		Differential	(V+) – (V–) + 0.2		V
	Current <sup>(2)</sup>	–10	10	mA	
Output short-circuit <sup>(3)</sup>		Continuous		mA	
Temperature	Specified, T <sub>A</sub>	–40	125	°C	
	Junction, T <sub>J</sub>		150		
	Storage, T <sub>stg</sub>	–65	150		

- (1) Stresses beyond those listed under *Absolute Maximum Ratings* may cause permanent damage to the device. These are stress ratings only, and functional operation of the device at these or any other conditions beyond those indicated under *Recommended Operating Conditions* is not implied. Exposure to absolute-maximum-rated conditions for extended periods may affect device reliability.
- (2) Input pins are diode-clamped to the power-supply rails. Current limit input signals that can swing more than 0.5V beyond the supply rails to 10mA or less.
- (3) Short-circuit to ground, one amplifier per package.

### 5.2 ESD Ratings

		VALUE	UNIT
TLV9061 PACKAGES			
V <sub>(ESD)</sub> Electrostatic discharge	Human-body model (HBM), per ANSI/ESDA/JEDEC JS-001 <sup>(1)</sup>	±2500	V
	Charged-device model (CDM), per JEDEC specification JESD22-C101 <sup>(2)</sup>	±1500	
ALL OTHER PACKAGES			
V <sub>(ESD)</sub> Electrostatic discharge	Human-body model (HBM), per ANSI/ESDA/JEDEC JS-001 <sup>(1)</sup>	±4000	V
	Charged-device model (CDM), per JEDEC specification JESD22-C101 <sup>(2)</sup>	±1500	

- (1) JEDEC document JEP155 states that 500V HBM allows safe manufacturing with a standard ESD control process.
- (2) JEDEC document JEP157 states that 250V CDM allows safe manufacturing with a standard ESD control process.

### 5.3 Recommended Operating Conditions

over operating ambient temperature range (unless otherwise noted)

		MIN	MAX	UNIT
V <sub>S</sub>	Supply voltage (V <sub>S</sub> = [V+] – [V–])	1.8	5.5	V
V <sub>I</sub>	Input voltage range	(V–) – 0.1	(V+) + 0.1	V
V <sub>O</sub>	Output voltage range	V–	V+	V
V <sub>SHDN_IH</sub>	High level input voltage at shutdown pin (amplifier enabled)	1.1	V+	V
V <sub>SHDN_IL</sub>	Low level input voltage at shutdown pin (amplifier disabled)	V–	0.2	V
T <sub>A</sub>	Specified temperature	–40	125	°C

## 5.4 Thermal Information: TLV9061

THERMAL METRIC <sup>(1)</sup>	TLV9061			UNIT	
	DBV (SOT-23)	DCK (SC70)	DPW (X2SON)		
	5 PINS	5 PINS	5 PINS		
$R_{\theta JA}$	Junction-to-ambient thermal resistance	221.7	263.3	467	°C/W
$R_{\theta JC(top)}$	Junction-to-case (top) thermal resistance	144.7	75.5	211.6	°C/W
$R_{\theta JB}$	Junction-to-board thermal resistance	49.7	51	332.2	°C/W
$\Psi_{JT}$	Junction-to-top characterization parameter	26.1	1	29.3	°C/W
$\Psi_{JB}$	Junction-to-board characterization parameter	49	50.3	330.6	°C/W
$R_{\theta JC(bot)}$	Junction-to-case (bottom) thermal resistance	N/A	N/A	125	°C/W

(1) For more information about traditional and new thermal metrics, see [Semiconductor and IC Package Thermal Metrics](#).

## 5.5 Thermal Information: TLV9061S

THERMAL METRIC <sup>(1)</sup>	TLV9061S		UNIT	
	DBV (SOT-23)	DRY (USON)		
	6 PINS	6 PINS		
$R_{\theta JA}$	Junction-to-ambient thermal resistance	216.5	TBD	°C/W
$R_{\theta JC(top)}$	Junction-to-case (top) thermal resistance	155.1	TBD	°C/W
$R_{\theta JB}$	Junction-to-board thermal resistance	96.2	TBD	°C/W
$\Psi_{JT}$	Junction-to-top characterization parameter	80.3	TBD	°C/W
$\Psi_{JB}$	Junction-to-board characterization parameter	95.9	TBD	°C/W
$R_{\theta JC(bot)}$	Junction-to-case (bottom) thermal resistance	N/A	N/A	°C/W

(1) For more information about traditional and new thermal metrics, see the [Semiconductor and IC Package Thermal Metrics](#).

## 5.6 Thermal Information: TLV9062

THERMAL METRIC <sup>(1)</sup>	TLV9062					UNIT	
	D (SOIC)	DGK (VSSOP)	DSG (WSON)	PW (TSSOP)	DDF (SOT-23)		
	8 PINS	8 PINS	8 PINS	8 PINS	8 PINS		
$R_{\theta JA}$	Junction-to-ambient thermal resistance	157.6	201.2	94.4	205.1	184.4	°C/W
$R_{\theta JC(top)}$	Junction-to-case (top) thermal resistance	104.6	85.7	116.5	93.7	112.8	°C/W
$R_{\theta JB}$	Junction-to-board thermal resistance	99.7	122.9	61.3	135.7	99.9	°C/W
$\Psi_{JT}$	Junction-to-top characterization parameter	55.6	21.2	13	25.0	18.7	°C/W
$\Psi_{JB}$	Junction-to-board characterization parameter	99.2	121.4	61.7	134.0	99.3	°C/W
$R_{\theta JC(bot)}$	Junction-to-case (bottom) thermal resistance	N/A	N/A	34.4	N/A	N/A	°C/W

(1) For more information about traditional and new thermal metrics, see [Semiconductor and IC Package Thermal Metrics](#).

### 5.7 Thermal Information: TLV9062S

THERMAL METRIC <sup>(1)</sup>		TLV9002S			UNIT
		YCK (DSBGA)	RUG (X2QFN)	DGS (VSSOP)	
		9 PINS	10 PINS	10 PINS	
$R_{\theta JA}$	Junction-to-ambient thermal resistance	129.8	197.2	170.4	°C/W
$R_{\theta JC(top)}$	Junction-to-case (top) thermal resistance	0.9	93.3	84.9	°C/W
$R_{\theta JB}$	Junction-to-board thermal resistance	37.5	123.8	113.5	°C/W
$\Psi_{JT}$	Junction-to-top characterization parameter	0.5	3.7	16.4	°C/W
$\Psi_{JB}$	Junction-to-board characterization parameter	37.1	120.2	112.3	°C/W
$R_{\theta JC(bot)}$	Junction-to-case (bottom) thermal resistance	N/A	N/A	N/A	°C/W

(1) For more information about traditional and new thermal metrics, see the [Semiconductor and IC Package Thermal Metrics](#) application report.

### 5.8 Thermal Information: TLV9064

THERMAL METRIC <sup>(1)</sup>		TLV9064				UNIT
		PW (TSSOP)	D (SOIC)	RTE (WQFN)	RUC (X2QFN)	
		14 PINS	14 PINS	16 PINS	14 PINS	
$R_{\theta JA}$	Junction-to-ambient thermal resistance	135.8	106.9	65.1	205.5	°C/W
$R_{\theta JC(top)}$	Junction-to-case (top) thermal resistance	64	64	67.9	72.5	°C/W
$R_{\theta JB}$	Junction-to-board thermal resistance	79	63	40.4	150.2	°C/W
$\Psi_{JT}$	Junction-to-top characterization parameter	15.7	25.9	5.5	3.0	°C/W
$\Psi_{JB}$	Junction-to-board characterization parameter	78.4	62.7	40.2	149.6	°C/W
$R_{\theta JC(bot)}$	Junction-to-case (bottom) thermal resistance	N/A	N/A	23.8	N/A	°C/W

(1) For more information about traditional and new thermal metrics, see [Semiconductor and IC Package Thermal Metrics](#).

### 5.9 Thermal Information: TLV9064S

THERMAL METRIC <sup>(1)</sup>		TLV9064S	UNIT
		RTE (WQFN)	
		16 PINS	
$R_{\theta JA}$	Junction-to-ambient thermal resistance	65.1	°C/W
$R_{\theta JC(top)}$	Junction-to-case(top) thermal resistance	67.9	°C/W
$R_{\theta JB}$	Junction-to-board thermal resistance	40.4	°C/W
$\Psi_{JT}$	Junction-to-top characterization parameter	5.5	°C/W
$\Psi_{JB}$	Junction-to-board characterization parameter	40.2	°C/W
$R_{\theta JC(bot)}$	Junction-to-case(bottom) thermal resistance	23.8	°C/W

(1) For more information about traditional and new thermal metrics, see [Semiconductor and IC Package Thermal Metrics](#).

### 5.10 Electrical Characteristics

For  $V_S$  (Total Supply Voltage) =  $(V+) - (V-) = 1.8V$  to  $5.5V$  at  $T_A = 25^\circ C$ ,  $R_L = 10\text{ k}\Omega$  connected to  $V_S / 2$ ,  $V_{CM} = V_S / 2$ , and  $V_{OUT} = V_S / 2$  (unless otherwise noted)

PARAMETER		TEST CONDITIONS	MIN	TYP	MAX	UNIT
<b>OFFSET VOLTAGE</b>						
$V_{OS}$	Input offset voltage	$V_S = 5V$		$\pm 0.3$	$\pm 1.6$	mV
		$V_S = 5V, T_A = -40^\circ C$ to $125^\circ C$			$\pm 2$	
$dV_{OS}/dT$	Drift	$V_S = 5V, T_A = -40^\circ C$ to $125^\circ C$		$\pm 0.53$		$\mu V/^\circ C$
PSRR	Power-supply rejection ratio	$V_S = 1.8V - 5.5V, V_{CM} = (V-)$		$\pm 7$	$\pm 80$	$\mu V/V$
	Channel separation, DC	At DC		100		dB
<b>INPUT VOLTAGE RANGE</b>						
$V_{CM}$	Common-mode voltage range	$V_S = 1.8V$ to $5.5V$	$(V-) - 0.1$		$(V+) + 0.1$	V
CMRR	Common-mode rejection ratio	$V_S = 5.5V, (V-) - 0.1V < V_{CM} < (V+) - 1.4V, T_A = -40^\circ C$ to $125^\circ C$	80	103		dB
		$V_S = 5.5V, V_{CM} = -0.1V$ to $5.6V, T_A = -40^\circ C$ to $125^\circ C$	57	87		
		$V_S = 1.8V, (V-) - 0.1V < V_{CM} < (V+) - 1.4V, T_A = -40^\circ C$ to $125^\circ C$		88		
		$V_S = 1.8V, V_{CM} = -0.1V$ to $1.9V, T_A = -40^\circ C$ to $125^\circ C$		81		
<b>INPUT BIAS CURRENT</b>						
$I_B$	Input bias current			$\pm 0.5$		pA
$I_{OS}$	Input offset current			$\pm 0.05$		pA
<b>NOISE</b>						
$E_n$	Input voltage noise (peak-to-peak)	$V_S = 5V, f = 0.1\text{ Hz}$ to $10\text{ Hz}$		4.77		$\mu V_{PP}$
$e_n$	Input voltage noise density	$V_S = 5V, f = 10\text{ kHz}$		10		$nV/\sqrt{\text{Hz}}$
		$V_S = 5V, f = 1\text{ kHz}$		16		
$i_n$	Input current noise density	$f = 1\text{ kHz}$		23		$fA/\sqrt{\text{Hz}}$
<b>INPUT CAPACITANCE</b>						
$C_{ID}$	Differential			2		pF
$C_{IC}$	Common-mode			4		pF
<b>OPEN-LOOP GAIN</b>						
$A_{OL}$	Open-loop voltage gain	$V_S = 1.8V, (V-) + 0.04V < V_O < (V+) - 0.04V, R_L = 10\text{ k}\Omega$		100		dB
		$V_S = 5.5V, (V-) + 0.05V < V_O < (V+) - 0.05V, R_L = 10\text{ k}\Omega$	104	130		
		$V_S = 1.8V, (V-) + 0.06V < V_O < (V+) - 0.06V, R_L = 2\text{ k}\Omega$		100		
		$V_S = 5.5V, (V-) + 0.15V < V_O < (V+) - 0.15V, R_L = 2\text{ k}\Omega$		130		
<b>FREQUENCY RESPONSE</b>						
GBP	Gain bandwidth product	$V_S = 5V, G = +1$		10		MHz
$\phi_m$	Phase margin	$V_S = 5V, G = +1$		55		°
SR	Slew rate	$V_S = 5V, G = +1$		6.5		V/ $\mu s$
$t_s$	Settling time	To 0.1%, $V_S = 5V, 2V$ step, $G = +1, C_L = 100\text{ pF}$		0.5		$\mu s$
		To 0.01%, $V_S = 5V, 2V$ step, $G = +1, C_L = 100\text{ pF}$		1		
$t_{OR}$	Overload recovery time	$V_S = 5V, V_{IN} \times \text{gain} > V_S$		0.2		$\mu s$
THD + N	Total harmonic distortion + noise <sup>(1)</sup>	$V_S = 5.5V, V_{CM} = 2.5V, V_O = 1V_{RMS}, G = +1, f = 1\text{ kHz}$		0.0008%		
<b>OUTPUT</b>						
$V_O$	Voltage output swing from supply rails	$V_S = 5.5V, R_L = 10\text{ k}\Omega$			20	mV
		$V_S = 5.5V, R_L = 2\text{ k}\Omega$			60	
$I_{SC}$	Short-circuit current	$V_S = 5V$		$\pm 50$		mA

## 5.10 Electrical Characteristics (continued)

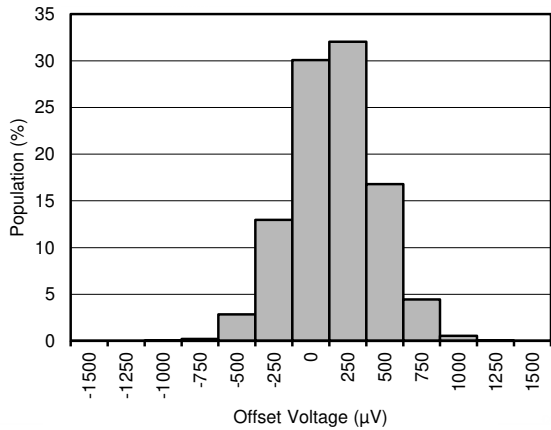
For  $V_S$  (Total Supply Voltage) =  $(V+) - (V-) = 1.8V$  to  $5.5V$  at  $T_A = 25^\circ C$ ,  $R_L = 10\text{ k}\Omega$  connected to  $V_S / 2$ ,  $V_{CM} = V_S / 2$ , and  $V_{OUT} = V_S / 2$  (unless otherwise noted)

PARAMETER	TEST CONDITIONS	MIN	TYP	MAX	UNIT
$Z_O$ Open-loop output impedance	$V_S = 5V$ , $f = 10\text{MHz}$		100		$\Omega$
<b>POWER SUPPLY</b>					
$I_Q$ Quiescent current per amplifier	$V_S = 5.5V$ , $I_O = 0\text{mA}$		538	750	$\mu A$
	$V_S = 5.5V$ , $I_O = 0\text{mA}$ , $T_A = -40^\circ C$ to $125^\circ C$			800	
<b>SHUTDOWN</b>					
$I_{QSD}$ Quiescent current per amplifier	$V_S = 1.8V$ to $5.5V$ , all amplifiers disabled, $\overline{\text{SHDN}} = \text{Low}$		0.5	1.5	$\mu A$
$Z_{\text{SHDN}}$ Output impedance during shutdown	$V_S = 1.8V$ to $5.5V$ , amplifier disabled		10    8		$G\Omega$    $pF$
$V_{\text{SHDN\_THR\_HI}}$ High level voltage shutdown threshold (amplifier enabled)	$V_S = 1.8V$ to $5.5V$		$(V-) + 0.9V$	$(V-) + 1.1V$	V
$V_{\text{SHDN\_THR\_LO}}$ Low level voltage shutdown threshold (amplifier disabled)	$V_S = 1.8V$ to $5.5V$		$(V-) + 0.2V$	$(V-) + 0.7V$	V
$t_{\text{ON}}$ Amplifier enable time (shutdown) <sup>(2)</sup>	$V_S = 1.8V$ to $5.5V$ , full shutdown; $G = 1$ , $V_{\text{OUT}} = 0.9 \times V_S / 2$ , $R_L$ connected to $V-$		10		$\mu s$
$t_{\text{OFF}}$ Amplifier disable time <sup>(2)</sup>	$V_S = 1.8V$ to $5.5V$ , $G = 1$ , $V_{\text{OUT}} = 0.1 \times V_S / 2$ , $R_L$ connected to $V-$		0.6		$\mu s$
$\overline{\text{SHDN}}$ pin input bias current (per pin)	$V_S = 1.8V$ to $5.5V$ , $V+ \geq \overline{\text{SHDN}} \geq (V+) - 0.8V$		130		$pA$
	$V_S = 1.8V$ to $5.5V$ , $V- \leq \overline{\text{SHDN}} \leq V- + 0.8V$		40		

- Third-order filter; bandwidth = 80kHz at -3dB.
- Disable time ( $t_{\text{OFF}}$ ) and enable time ( $t_{\text{ON}}$ ) are defined as the time interval between the 50% point of the signal applied to the  $\overline{\text{SHDN}}$  pin and the point at which the output voltage reaches the 10% (disable) or 90% (enable) level.

### 5.11 Typical Characteristics

at  $T_A = 25^\circ\text{C}$ ,  $V_S = 5.5\text{V}$ ,  $R_L = 10\text{k}\Omega$  connected to  $V_S / 2$ ,  $V_{CM} = V_S / 2$ , and  $V_{OUT} = V_S / 2$  (unless otherwise noted)

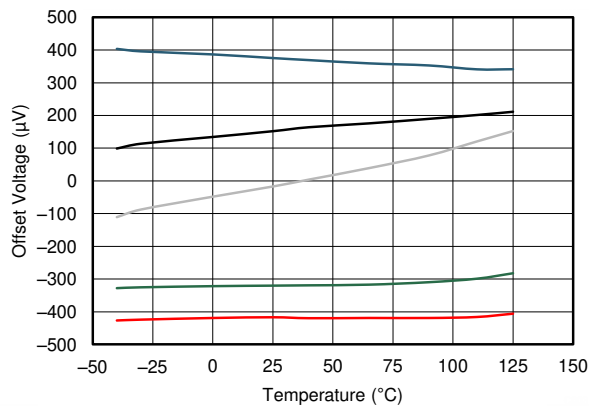


**Figure 5-1. Offset Voltage Production Distribution**

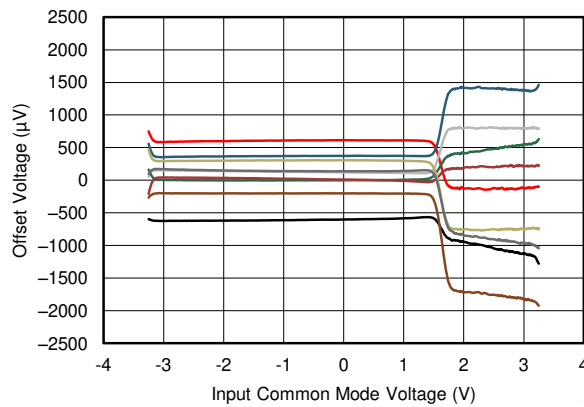


$T_A = -40^\circ\text{C}$  to  $125^\circ\text{C}$

**Figure 5-2. Offset Voltage Drift Distribution**

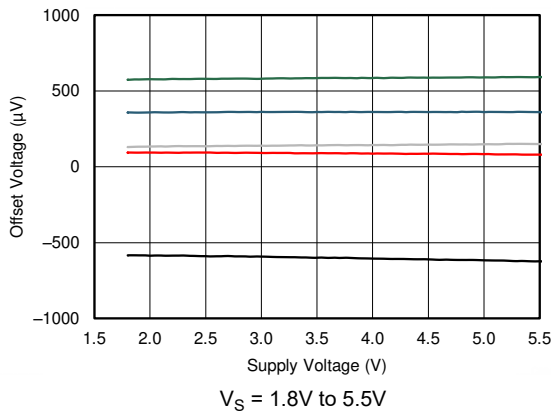


**Figure 5-3. Offset Voltage vs Temperature**



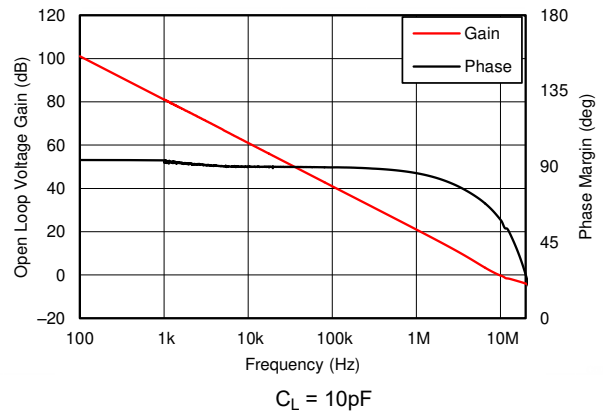
$V_+ = 2.75\text{V}$        $V_- = -2.75\text{V}$

**Figure 5-4. Offset Voltage vs Common-Mode Voltage**



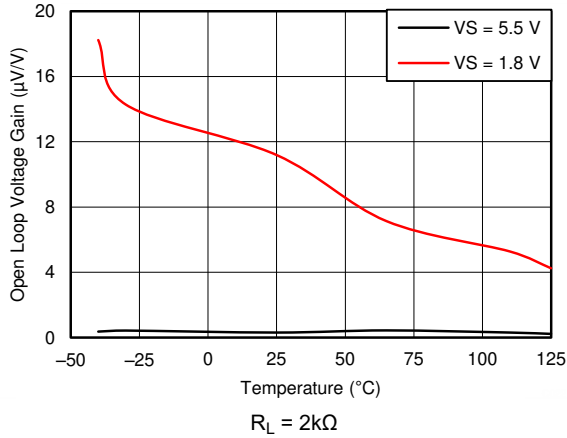
$V_S = 1.8\text{V}$  to  $5.5\text{V}$

**Figure 5-5. Offset Voltage vs Power Supply**

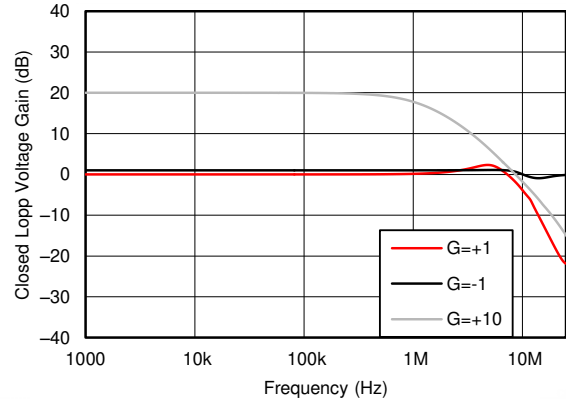


$C_L = 10\text{pF}$

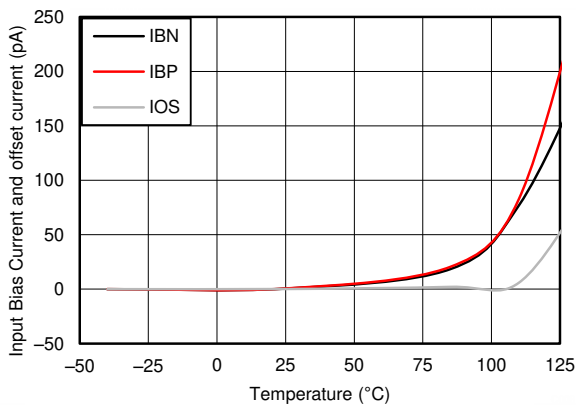
**Figure 5-6. Open-Loop Gain and Phase vs Frequency**



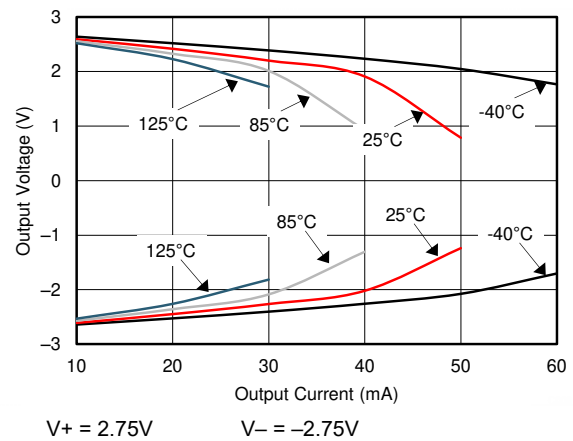
**Figure 5-7. Open-Loop Gain vs Temperature**



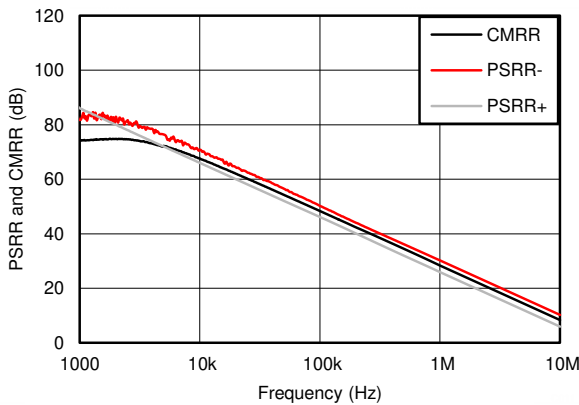
**Figure 5-8. Closed-Loop Gain vs Frequency**



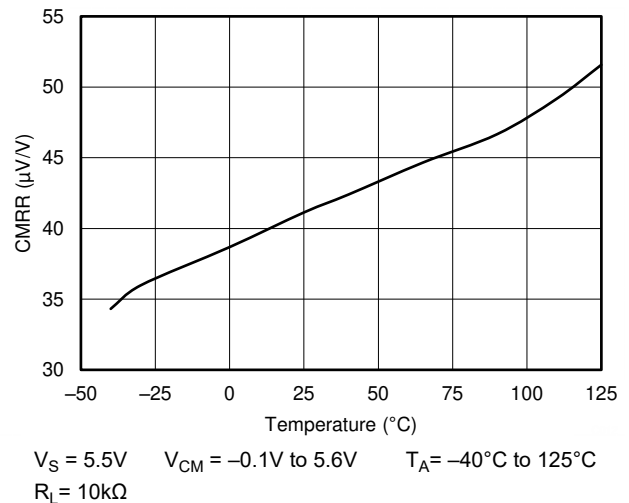
**Figure 5-9. Input Bias Current vs Temperature**



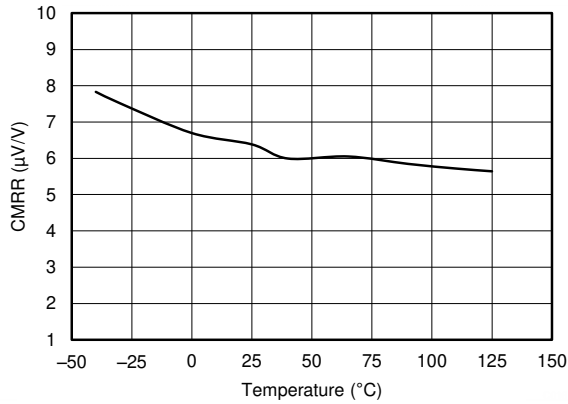
**Figure 5-10. Output Voltage Swing vs Output Current**



**Figure 5-11. CMRR and PSRR vs Frequency (Referred to Input)**

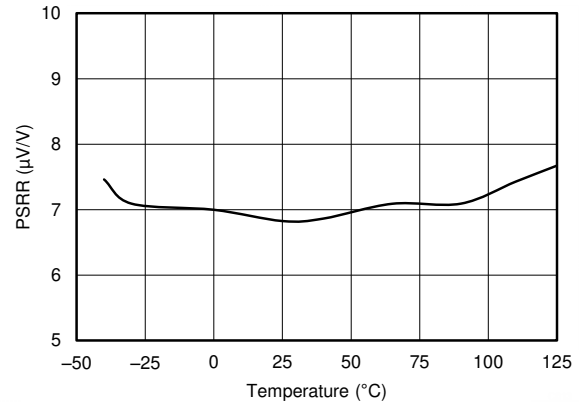


**Figure 5-12. CMRR vs Temperature**



$V_{CM} = (V-) - 0.1V$  to  $(V+) - 1.4V$   
 $T_A = -40^{\circ}C$  to  $125^{\circ}C$       $R_L = 10k\Omega$       $V_S = 5.5V$

**Figure 5-13. CMRR vs Temperature**



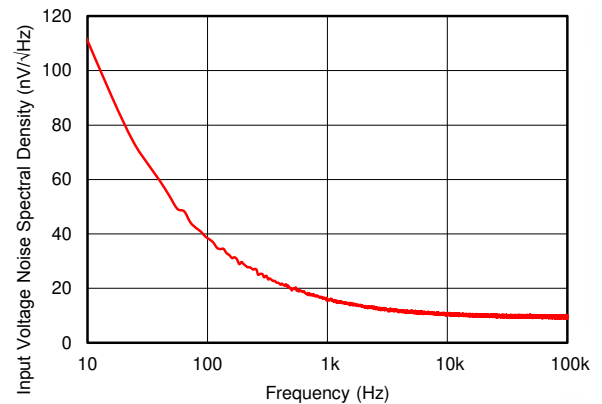
$V_S = 1.8V$  to  $5.5V$

**Figure 5-14. PSRR vs Temperature**



$V_S = 1.8V$  to  $5.5V$

**Figure 5-15. 0.1Hz to 10Hz Input Voltage Noise**



**Figure 5-16. Input Voltage Noise Spectral Density vs Frequency**



$V_S = 5.5V$       $V_{CM} = 2.5V$       $R_L = 2k\Omega$   
 $V_{OUT} = 0.5V_{RMS}$       $BW = 80kHz$       $G = +1$

**Figure 5-17. THD + N vs Frequency**



$V_S = 5.5V$       $R_L = 2k\Omega$       $G = +1$   
 $V_{CM} = 2.5V$       $BW = 80kHz$       $f = 1kHz$

**Figure 5-18. THD + N vs Amplitude**



Figure 5-19. THD + N vs Amplitude

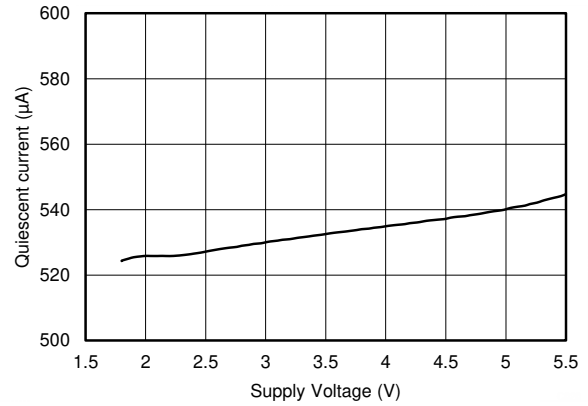


Figure 5-20. Quiescent Current vs Supply Voltage



Figure 5-21. Quiescent Current vs Temperature

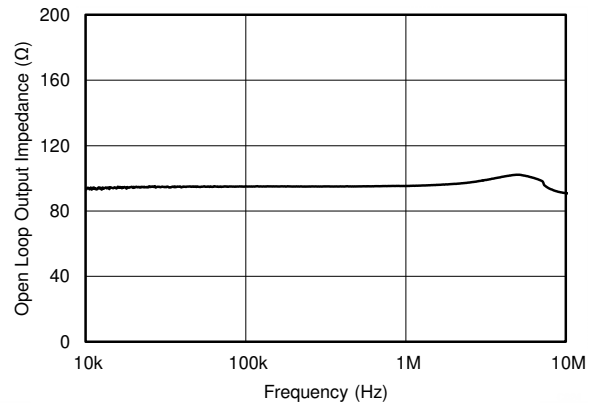


Figure 5-22. Open-Loop Output Impedance vs Frequency

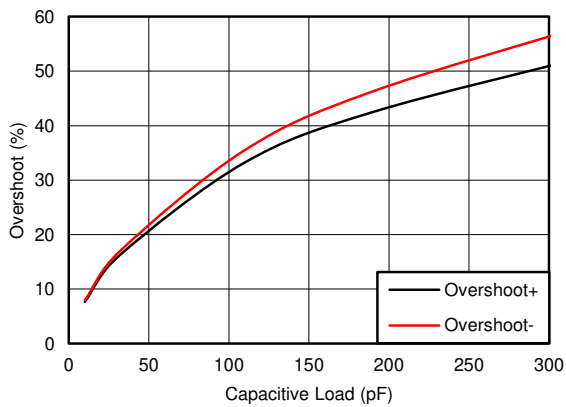


Figure 5-23. Small-Signal Overshoot vs Load Capacitance

$V_+ = 2.75V$        $V_- = -2.75V$        $G = +1V/V$   
 $V_{OUT\ step} = 100mV_{p-p}$        $R_L = 10k\Omega$

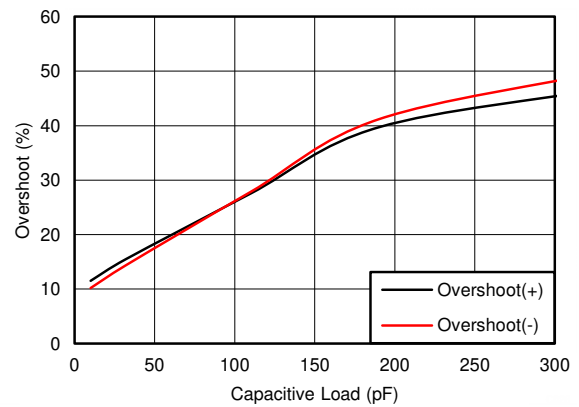
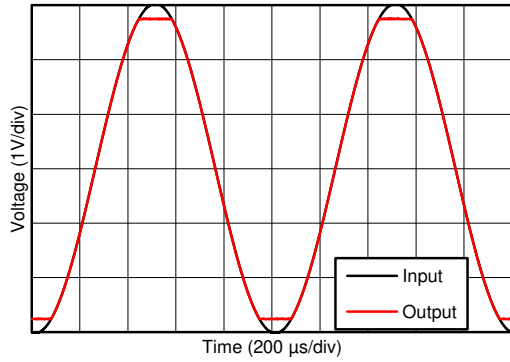


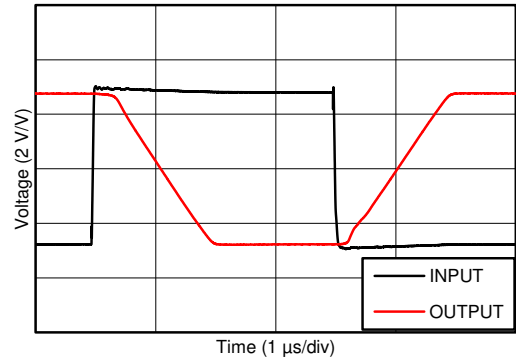
Figure 5-24. Small-Signal Overshoot vs Load Capacitance

$V_+ = 2.75V$        $V_- = -2.75V$        $G = -1V/V$   
 $V_{OUT\ step} = 100mV_{p-p}$        $R_L = 10k\Omega$



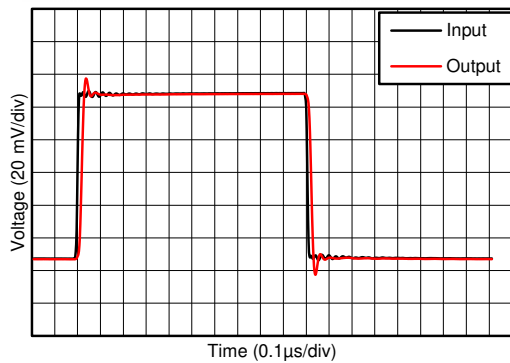
V+ = 2.75V      V- = -2.75V

**Figure 5-25. No Phase Reversal**



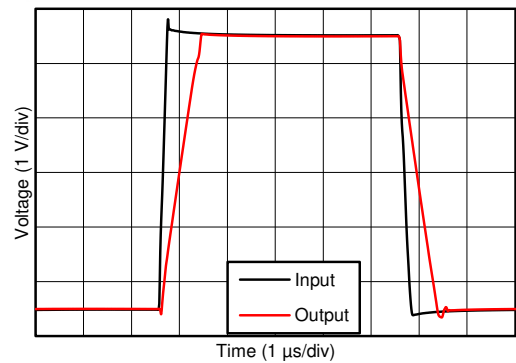
V+ = 2.75V      V- = -2.75V      G = -10V/V

**Figure 5-26. Overload Recovery**



V+ = 2.75V      V- = -2.75V      G = 1V/V

**Figure 5-27. Small-Signal Step Response**



V+ = 2.75V      V- = -2.75V      C<sub>L</sub> = 100pF  
G = 1V/V

**Figure 5-28. Large-Signal Step Response**



**Figure 5-29. Short-Circuit Current vs Temperature**



R<sub>L</sub> = 10 kΩ      C<sub>L</sub> = 10pF

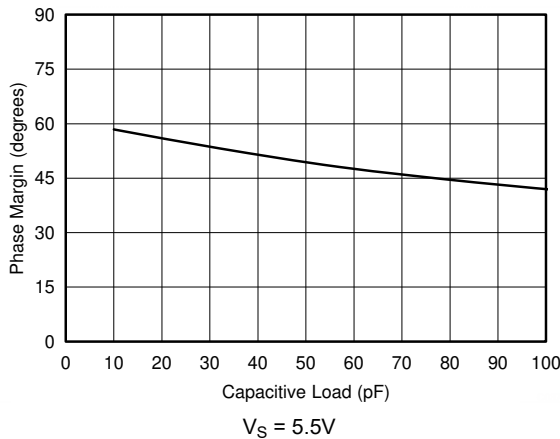
**Figure 5-30. Maximum Output Voltage vs Frequency and Supply Voltage**



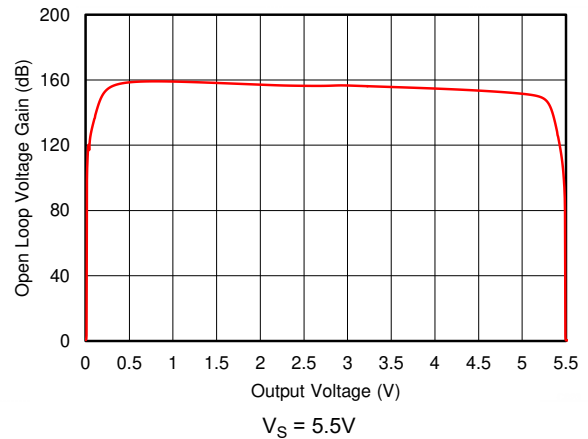
**Figure 5-31. Electromagnetic Interference Rejection Ratio Referred to Noninverting Input (EMIRR+) vs Frequency**



**Figure 5-32. Channel Separation vs Frequency**



**Figure 5-33. Phase Margin vs Capacitive Load**



**Figure 5-34. Open Loop Voltage Gain vs Output Voltage**



**Figure 5-35. Large Signal Settling Time (Positive)**



**Figure 5-36. Large Signal Settling Time (Negative)**

## 6 Detailed Description

### 6.1 Overview

The TLV906x devices are a family of low-power, rail-to-rail input and output op amps. These devices operate from 1.8V to 5.5V, are unity-gain stable, and are designed for a wide range of general-purpose applications. The input common-mode voltage range includes both rails and allows the TLV906x series to be used in virtually any single-supply application. Rail-to-rail input and output swing significantly increases dynamic range, especially in low-supply applications. The high bandwidth enables this family to drive the sample-and-hold circuitry of analog-to-digital converters (ADCs).

### 6.2 Functional Block Diagram



## 6.3 Feature Description

### 6.3.1 Rail-to-Rail Input

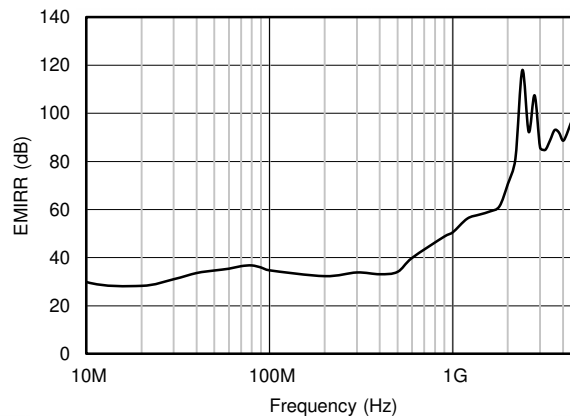
The input common-mode voltage range of the TLV906x family extends 100mV beyond the supply rails for the full supply voltage range of 1.8V to 5.5V. This performance is achieved with a complementary input stage: an N-channel input differential pair in parallel with a P-channel differential pair, as shown in the [Functional Block Diagram](#). The N-channel pair is active for input voltages close to the positive rail, typically  $(V+) - 1.4V$  to 200mV above the positive supply, whereas the P-channel pair is active for inputs from 200mV below the negative supply to approximately  $(V+) - 1.4V$ . There is a small transition region, typically  $(V+) - 1.2V$  to  $(V+) - 1V$ , in which both pairs are on. This 200-mV transition region can vary up to 200mV with process variation. Thus, the transition region (with both stages on) can range from  $(V+) - 1.4V$  to  $(V+) - 1.2V$  on the low end, and up to  $(V+) - 1V$  to  $(V+) - 0.8V$  on the high end. Within this transition region, PSRR, CMRR, offset voltage, offset drift, and THD can degrade compared to device operation outside this region.

### 6.3.2 Rail-to-Rail Output

Designed as a low-power, low-voltage operational amplifier, the TLV906x series delivers a robust output drive capability. A class AB output stage with common-source transistors achieves full rail-to-rail output swing capability. For resistive loads of 10kΩ, the output swings to within 15mV of either supply rail, regardless of the applied power-supply voltage. Different load conditions change the ability of the amplifier to swing close to the rails.

### 6.3.3 EMI Rejection

The TLV906x uses integrated electromagnetic interference (EMI) filtering to reduce the effects of EMI from sources such as wireless communications and densely-populated boards with a mix of analog signal chain and digital components. EMI immunity can be improved with circuit design techniques; the TLV906x benefits from these design improvements. Texas Instruments has developed the ability to accurately measure and quantify the immunity of an operational amplifier over a broad frequency spectrum extending from 10MHz to 6GHz. [Figure 6-1](#) shows the results of this testing on the TLV906x. [Table 6-1](#) lists the EMIRR IN+ values for the TLV906x at particular frequencies commonly encountered in real-world applications. See [EMI Rejection Ratio of Operational Amplifiers application note](#) for more information.



**Figure 6-1. EMIRR Testing**

**Table 6-1. TLV906x EMIRR IN+ For Frequencies of Interest**

FREQUENCY	APPLICATION or ALLOCATION	EMIRR IN+
400MHz	Mobile radio, mobile satellite, space operation, weather, radar, ultra-high frequency (UHF) applications	59.5dB
900MHz	Global system for mobile communications (GSM) applications, radio communication, navigation, GPS (to 1.6GHz), GSM, aeronautical mobile, UHF applications	68.9dB
1.8 GHz	GSM applications, mobile personal communications, broadband, satellite, L-band (1GHz to 2GHz)	77.8dB
2.4GHz	802.11b, 802.11g, 802.11n, Bluetooth®, mobile personal communications, industrial, scientific and medical (ISM) radio band, amateur radio and satellite, S-band (2GHz to 4GHz)	78.0dB

**Table 6-1. TLV906x EMIRR IN+ For Frequencies of Interest (continued)**

FREQUENCY	APPLICATION or ALLOCATION	EMIRR IN+
3.6GHz	Radiolocation, aero communication and navigation, satellite, mobile, S-band	88.8dB
5GHz	802.11a, 802.11n, aero communication and navigation, mobile communication, space and satellite operation, C-band (4GHz to 8GHz)	87.6dB

### 6.3.4 Overload Recovery

Overload recovery is defined as the time required for the operational amplifier output to recover from a saturated state to a linear state. The output devices of the operational amplifier enter a saturation region when the output voltage exceeds the rated operating voltage, because of the high input voltage or the high gain. After the device enters the saturation region, the charge carriers in the output devices require time to return to the linear state. After the charge carriers return to the linear state, the device begins to slew at the specified slew rate. Therefore, the propagation delay (in case of an overload condition) is the sum of the overload recovery time and the slew time. The overload recovery time for the TLV906x family is approximately 200ns.

### 6.3.5 Shutdown Function

The TLV906xS devices feature  $\overline{\text{SHDN}}$  pins that disable the op amp, placing the op amp into a low-power standby mode. In this mode, the op amp typically consumes less than 1 $\mu\text{A}$ . The  $\overline{\text{SHDN}}$  pins are active-low, meaning that shutdown mode is enabled when the input to the  $\overline{\text{SHDN}}$  pin is a valid logic low.

The  $\overline{\text{SHDN}}$  pins are referenced to the negative supply voltage of the op amp. The threshold of the shutdown feature lies around 800mV (typical) and does not change with respect to the supply voltage. Hysteresis has been included in the switching threshold to ensure smooth switching characteristics. To ensure optimal shutdown behavior, the  $\overline{\text{SHDN}}$  pins should be driven with valid logic signals. A valid logic low is defined as a voltage between  $V_-$  and  $V_- + 0.2\text{V}$ . A valid logic high is defined as a voltage between  $V_- + 1.2\text{V}$  and  $V_+$ . The shutdown pin must either be connected to a valid high or a low voltage or driven, and not left as an open circuit. There is **no** internal pull-up to enable the amplifier.

The  $\overline{\text{SHDN}}$  pins are high-impedance CMOS inputs. Dual op amp versions are independently controlled, and quad op amp versions are controlled in pairs with logic inputs. For battery-operated applications, this feature may be used to greatly reduce the average current and extend battery life. The enable time is 10 $\mu\text{s}$  for full shutdown of all channels; disable time is 6 $\mu\text{s}$ . When disabled, the output assumes a high-impedance state. This architecture allows the TLV906xS to operate as a gated amplifier (or to have the device output multiplexed onto a common analog output bus). Shutdown time ( $t_{\text{OFF}}$ ) depends on loading conditions and increases as load resistance increases. To ensure shutdown (disable) within a specific shutdown time, the specified 10k $\Omega$  load to midsupply ( $V_S / 2$ ) is required. If using the TLV906xS without a load, the resulting turnoff time is significantly increased.

## 6.4 Device Functional Modes

The TLV906x family are operational when the power-supply voltage is between 1.8V ( $\pm 0.9\text{V}$ ) and 5.5V ( $\pm 2.75\text{V}$ ). The TLV906xS devices feature a shutdown mode and are shut down when a valid logic low is applied to the shutdown pin.

## 7 Application and Implementation

### Note

Information in the following applications sections is not part of the TI component specification, and TI does not warrant its accuracy or completeness. TI's customers are responsible for determining suitability of components for their purposes, as well as validating and testing their design implementation to confirm system functionality.

### 7.1 Application Information

The TLV906x family features 10MHz bandwidth and 6.5V/ $\mu$ s slew rate with only 538 $\mu$ A of supply current per channel, providing good AC-performance at very low power consumption. DC applications are well served with a very low input noise voltage of 10nV/ $\sqrt{\text{Hz}}$  at 10kHz, low input bias current, and a typical input offset voltage of 0.3mV.

### 7.2 Typical Applications

#### 7.2.1 Typical Low-Side Current Sense Application

Figure 7-1 shows the TLV906x configured in a low-side current-sensing application.



Figure 7-1. TLV906x in a Low-Side, Current-Sensing Application

#### 7.2.2 Design Requirements

The design requirements for this design are:

- Load current: 0A to 1A
- Output voltage: 4.95V
- Maximum shunt voltage: 100mV

### 7.2.3 Detailed Design Procedure

The transfer function of the circuit in [Figure 7-1](#) is given in [Equation 1](#).

$$V_{OUT} = I_{LOAD} \times R_{SHUNT} \times GAIN \quad (1)$$

The load current ( $I_{LOAD}$ ) produces a voltage drop across the shunt resistor ( $R_{SHUNT}$ ). The load current is set from 0A to 1A. To keep the shunt voltage below 100mV at maximum load current, the largest shunt resistor is defined using [Equation 2](#).

$$R_{SHUNT} = \frac{V_{SHUNT\_MAX}}{I_{LOAD\_MAX}} = \frac{100mV}{1A} = 100m\Omega \quad (2)$$

Using [Equation 2](#),  $R_{SHUNT}$  equals 100m $\Omega$ . The voltage drop produced by  $I_{LOAD}$  and  $R_{SHUNT}$  is amplified by the TLV906x to produce an output voltage of approximately 0V to 4.95V. [Equation 3](#) calculates the gain required for the TLV906x to produce the required output voltage.

$$Gain = \frac{(V_{OUT\_MAX} - V_{OUT\_MIN})}{(V_{IN\_MAX} - V_{IN\_MIN})} \quad (3)$$

Using [Equation 3](#), the required gain equals 49.5V/V, which is set with the  $R_F$  and  $R_G$  resistors. [Equation 4](#) sizes the  $R_F$  and  $R_G$ , resistors to set the gain of the TLV906x to 49.5V/V.

$$Gain = 1 + \frac{(R_F)}{(R_G)} \quad (4)$$

Selecting  $R_F$  to equal 165k $\Omega$  and  $R_G$  to equal 3.4k $\Omega$  provides a combination that equals approximately 49.5V/V. [Figure 7-2](#) shows the measured transfer function of the circuit shown in [Figure 7-1](#). Notice that the gain is only a function of the feedback and gain resistors. This gain is adjusted by varying the ratio of the resistors and the actual resistor values are determined by the impedance levels that the designer wants to establish. The impedance level determines the current drain, the effect that stray capacitance has, and a few other behaviors. There is no optimal impedance selection that works for every system, you must choose an impedance that is ideal for your system parameters.

### 7.2.4 Application Curve



**Figure 7-2. Low-Side, Current-Sense, Transfer Function**

## 7.3 Power Supply Recommendations

The TLV906x series is specified for operation from 1.8V to 5.5V ( $\pm 0.9V$  to  $\pm 2.75V$ ); many specifications apply from  $-40^{\circ}C$  to  $125^{\circ}C$ . The [Typical Characteristics](#) section presents parameters that can exhibit significant variance with regard to operating voltage or temperature.

**CAUTION**

Supply voltages larger than 6V can permanently damage the device; see the [Absolute Maximum Ratings](#) table.

Place 0.1µF bypass capacitors close to the power-supply pins to reduce errors coupling in from noisy or high-impedance power supplies. For more detailed information on bypass capacitor placement, see the [Layout](#) section.

**7.3.1 Input and ESD Protection**

The TLV906x series incorporates internal ESD protection circuits on all pins. For input and output pins, this protection primarily consists of current-steering diodes connected between the input and power-supply pins. These ESD protection diodes provide in-circuit, input overdrive protection, as long as the current is limited to 10mA, as shown in the [Absolute Maximum Ratings](#) table. [Figure 7-3](#) shows how a series input resistor can be added to the driven input to limit the input current. The added resistor contributes thermal noise at the amplifier input and the value must be kept to a minimum in noise-sensitive applications.



**Figure 7-3. Input Current Protection**

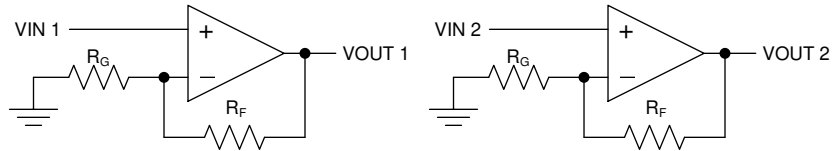
## 7.4 Layout

### 7.4.1 Layout Guidelines

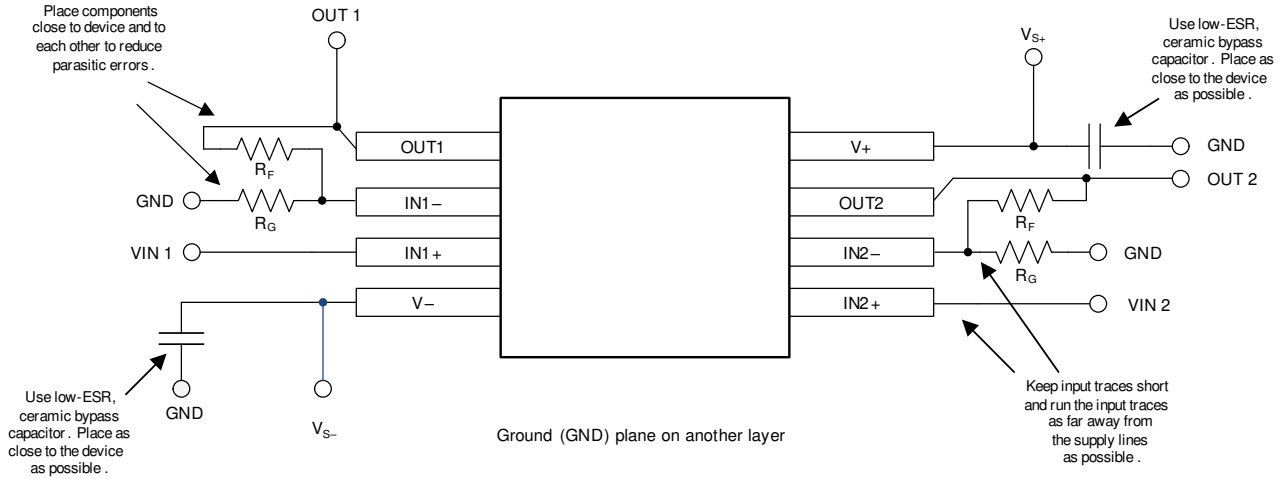
For best operational performance of the device, use good printed circuit board (PCB) layout practices, including:

- Noise can propagate into analog circuitry through the power pins of the circuit as a whole and of the op amp itself. Bypass capacitors are used to reduce the coupled noise by providing low-impedance power sources local to the analog circuitry.
  - Connect low-ESR, 0.1  $\mu$ F ceramic bypass capacitors between each supply pin and ground, placed as close to the device as possible. A single bypass capacitor from V+ to ground is adequate for single-supply applications.
- Separate grounding for analog and digital portions of circuitry is one of the simplest and most-effective methods of noise suppression. One or more layers on multilayer PCBs are usually devoted to ground planes. A ground plane helps distribute heat and reduces electromagnetic interference (EMI) noise pickup. Take care to physically separate digital and analog grounds, paying attention to the flow of the ground current. For more detailed information, see [Circuit Board Layout Techniques](#).
- To reduce parasitic coupling, run the input traces as far away from the supply or output traces as possible. If these traces cannot be kept separate, crossing the sensitive trace at a 90 degree angle is much better as opposed to running the traces in parallel with the noisy trace.
- Place the external components as close to the device as possible. As illustrated in [Figure 7-5](#), keeping R<sub>F</sub> and R<sub>G</sub> close to the inverting input minimizes parasitic capacitance on the inverting input.
- Keep the length of input traces as short as possible. Always remember that the input traces are the most sensitive part of the circuit.
- Consider a driven, low-impedance guard ring around the critical traces. A guard ring can significantly reduce leakage currents from nearby traces that are at different potentials.
- Cleaning the PCB following board assembly is recommended for best performance.
- Any precision integrated circuit can experience performance shifts resulting from moisture ingress into the plastic package. Following any aqueous PCB cleaning process, baking the PCB assembly is recommended to remove moisture introduced into the device packaging during the cleaning process. A low-temperature, post-cleaning bake at 85°C for 30 minutes is sufficient for most circumstances.

### 7.4.2 Layout Example



**Figure 7-4. Schematic Representation for the Layout Example**



**Figure 7-5. Layout Example**

## 8 Device and Documentation Support

### 8.1 Documentation Support

#### 8.1.1 Related Documentation

For related documentation, see the following:

- Texas Instruments, [Circuit Board Layout Techniques](#)
- Texas Instruments, [EMI Rejection Ratio of Operational Amplifiers application note](#)
- Texas Instruments, [QFN/SON PCB Attachment application note](#)
- Texas Instruments, [Quad Flatpack No-Lead Logic Packages application note](#)
- Texas Instruments, [Single-Ended Input to Differential Output Conversion Circuit design guide](#)
- Texas Instruments, [TLVx313 Low-Power, Rail-to-Rail In/Out, 500- \$\mu\$ V Typical Offset, 1MHz Operational Amplifier for Cost-Sensitive Systems data sheet](#)
- Texas Instruments, [TLVx314 3MHz, Low-Power, Internal EMI Filter, RRIO, Operational Amplifier data sheet](#)

### 8.2 Receiving Notification of Documentation Updates

To receive notification of documentation updates, navigate to the device product folder on [ti.com](http://ti.com). Click on *Notifications* to register and receive a weekly digest of any product information that has changed. For change details, review the revision history included in any revised document.

### 8.3 Support Resources

[TI E2E™ support forums](#) are an engineer's go-to source for fast, verified answers and design help — straight from the experts. Search existing answers or ask your own question to get the quick design help you need.

Linked content is provided "AS IS" by the respective contributors. They do not constitute TI specifications and do not necessarily reflect TI's views; see TI's [Terms of Use](#).

### 8.4 Trademarks

TI E2E™ is a trademark of Texas Instruments.

Bluetooth® is a registered trademark of Bluetooth SIG, Inc.

All trademarks are the property of their respective owners.

### 8.5 Electrostatic Discharge Caution



This integrated circuit can be damaged by ESD. Texas Instruments recommends that all integrated circuits be handled with appropriate precautions. Failure to observe proper handling and installation procedures can cause damage.

ESD damage can range from subtle performance degradation to complete device failure. Precision integrated circuits may be more susceptible to damage because very small parametric changes could cause the device not to meet its published specifications.

### 8.6 Glossary

[TI Glossary](#) This glossary lists and explains terms, acronyms, and definitions.

## 9 Revision History

NOTE: Page numbers for previous revisions may differ from page numbers in the current version.

#### Changes from Revision L (September 2024) to Revision M (December 2024) Page

- |   |   |
|---|---|
| • Changed TLV9061S DBV (SOT-23) pinout drawing to match the <i>Pin Functions</i> table..... | 4 |
|---|---|

#### Changes from Revision K (July 2024) to Revision L (September 2024) Page

- |  |   |
|--|---|
| • Deleted package preview note from TLV9062S (YCK, DSBGA) package in <i>Device Information</i> table ..... | 1 |
|--|---|

**Changes from Revision J (September 2019) to Revision K (July 2024) Page**

- Updated the numbering format for tables, figures, and cross-references throughout the document..... 1
- Updated the *Device Information* table..... 1
- Added package preview note for TLV9062S (YCK, DSBGA) package in *Device Information* table ..... 1
- Added YCK packages to the *Device Comparison* table..... 3
- Added TLV9062S YCK (DSBGA) pinout drawing to *Pin Configuration and Functions* section..... 4

**Changes from Revision I (May 2019) to Revision J (September 2019) Page**

- Deleted TLV9062IDDFR (SOT-23, 8) package preview notations throughout data sheet..... 1
- Added industry standard package names to *Device Comparison Table* ..... 3
- Added note to packages with thermal pads, specifying that the thermal pads need to be connected to V-..... 4
- Added link to *Shutdown Function* section in  $\overline{\text{SHDN}}$  pin function rows..... 4
- Added *EMI Rejection* section to the *Feature Description* section..... 21
- Changed *Shutdown Function* section to add more clarification ..... 22

**Changes from Revision H (April 2019) to Revision I (May 2019) Page**

- Added DDF (SOT-23) thermal information to replace TBDs..... 10

**Changes from Revision G (December 2018) to Revision H (April 2019) Page**

- Added (SOT-23, 8) information to *Device Information* ..... 1
- Added DDF package column to *Device Comparison Table* ..... 3
- Added DDF (SOT-23) package, to *Pin Functions* ..... 4
- Added DDF (SOT-23) package to *Thermal Information* ..... 10

**Changes from Revision F (September 2018) to Revision G (December 2018) Page**

- Changed TLV9064 RUC package name from: (WQFN, 14) to: (X2QFN, 14) in *Device Information* table..... 1
- Added RUC (X2QFN) package, pinout information to Pin Functions: TLV9064 table..... 4
- Added TLV9064 RUC (X2QFN) pinout drawing to *Pin Configuration and Functions* section..... 4
- Added RUC (X2QFN) to Thermal Information: TLV9064 table..... 11

**Changes from Revision E (July 2018) to Revision F (September 2018) Page**

- Deleted Shutdown part numbers from data sheet header ..... 1
- Deleted (X2QFN, 10) package from TLV9062 *Device Information* table..... 1
- Added references to shutdown part numbers in Description section ..... 1
- Changed TLV906xS series to TLV906xS family throughout data sheet..... 1
- Added Shutdown devices to Device Comparison Table ..... 3
- Changed pin namings for all pinout drawings to reflect updated nomenclature ..... 4
- Added TLV9061S Thermal Information Table..... 10
- Added TLV9064S Thermal Information Table..... 11
- Deleted Partial Shutdown Amplifier Enable Time..... 12
- Added clarification on selecting resistors for a current sensing application in the Typical Applications Section ..... 24
- Changed wording of third bullet in Layout Guidelines..... 26

<b>Changes from Revision D (June 2018) to Revision E (July 2018)</b>	<b>Page</b>
• Added TLV9061S device to <i>Device Information</i> table.....	1
• Added TLV9064S device to <i>Device Information</i> table.....	1
• Added RUC and RUG packages to the <i>Device Comparison</i> table.....	3
• Added TLV9061S DBV (SOT-23) pinout drawing to <i>Pin Configuration and Functions</i> section.....	4
• Added TLV9061S DBV (SOT-23) package, pinout information to <i>Pin Functions: TLV9061S</i> table.....	4
• Added TLV9062S RUG (VSSOP) package, pinout drawing to <i>Pin Configuration and Functions</i> section.....	4
• Added TLV9064 RTE pinout information to <i>Pin Functions: TLV9064</i> table.....	4
• Added TLV9064S RTE (WQFN) pinout drawing to <i>Pin Configuration and Functions</i> section .....	4
• Added TLV9062S RUG (VSSOP) package, pinout information to <i>Pin Functions: TLV9062S</i> table.....	4
• Added TLV9064 RTE (WQFN) pinout drawing to <i>Pin Configuration and Functions</i> section .....	4

<b>Changes from Revision C (March 2018) to Revision D (June 2018)</b>	<b>Page</b>
• Added shutdown suffix to "TLV906x" to document title.....	1
• Added "Shutdown Version" bullet to <i>Features</i> list .....	1
• Added TLV9062S device to <i>Device Information</i> table.....	1
• Added shutdown text to <i>Description (continued)</i> section.....	1
• Added "(V <sub>S</sub> = [V+] – [V–])" supply voltage parameter in <i>Absolute Maximum Ratings</i> table.....	9
• Added "input voltage range" and "output voltage range" parameters and values to <i>Recommended Operating Conditions</i> table.....	9
• Added shutdown pin recommended operating conditions in <i>Recommended Operating Conditions</i> table.....	9
• Added "T <sub>A</sub> " symbol to "specified temperature" parameter to <i>Recommended Operating Conditions</i> table .....	9
• Added <i>Thermal Information: TLV9062S</i> thermal table data.....	11
• Added shutdown section to <i>Electrical Characteristics: V<sub>S</sub> (Total Supply Voltage) = (V+) – (V–) = 1.8V to 5.5V</i> table.....	12
• Added <i>Shutdown Function</i> section .....	22

<b>Changes from Revision B (October 2017) to Revision C (March 2018)</b>	<b>Page</b>
• Changed device status from Production Data/Mixed Status to Production Data .....	1
• Deleted package preview note from TLV9061 (DPW, X2SON) package in <i>Device Information</i> table .....	1
• Deleted package, preview note from TLV9061 DPW (X2SON) package, pinout drawing .....	4
• Changed formatting of <i>ESD Ratings</i> table to show different results for all packages .....	9
• Deleted package preview note from DPW (X2SON) package in <i>Thermal Information: TLV9061</i> table .....	10
• Deleted package preview note from DPW (X2SON) package in <i>Thermal Information: TLV9061</i> table .....	10

<b>Changes from Revision A (June 2017) to Revision B (October 2017)</b>	<b>Page</b>
• Added 8-pin PW package, to <i>Pin Configuration and Functions</i> section .....	4
• Added DSG (WSOP) package to <i>Thermal Information</i> table.....	10
• Added PW (TSSOP) to TLV9062 <i>Thermal Information</i> table .....	10
• Changed maximum input offset voltage value from ±1.6mV to 2mV.....	12
• Changed maximum input offset voltage value from ±1.5 to ±1.6mV.....	12
• Changed minimum common-mode rejection ratio input voltage range from 86dB to 80dB .....	12
• Changed typical input current noise density value from 10 to 23fA/√ Hz .....	12
• Changed THD + N test conditions from V <sub>S</sub> = 5V to V <sub>S</sub> = 5.5V.....	12
• Added V <sub>CM</sub> = 2.5V test condition to THD + N parameter in <i>Electrical Characteristics</i> table .....	12
• Added maximum output voltage swing value from 25mV to 60mV.....	12
• Changed maximum output voltage swing value from 15mV to 20mV .....	12

---

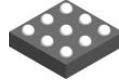
<b>Changes from Revision * (March 2017) to Revision A (June 2017)</b>	<b>Page</b>
• Changed device status from Advance Information to Production Data .....	1

---

## **10 Mechanical, Packaging, and Orderable Information**

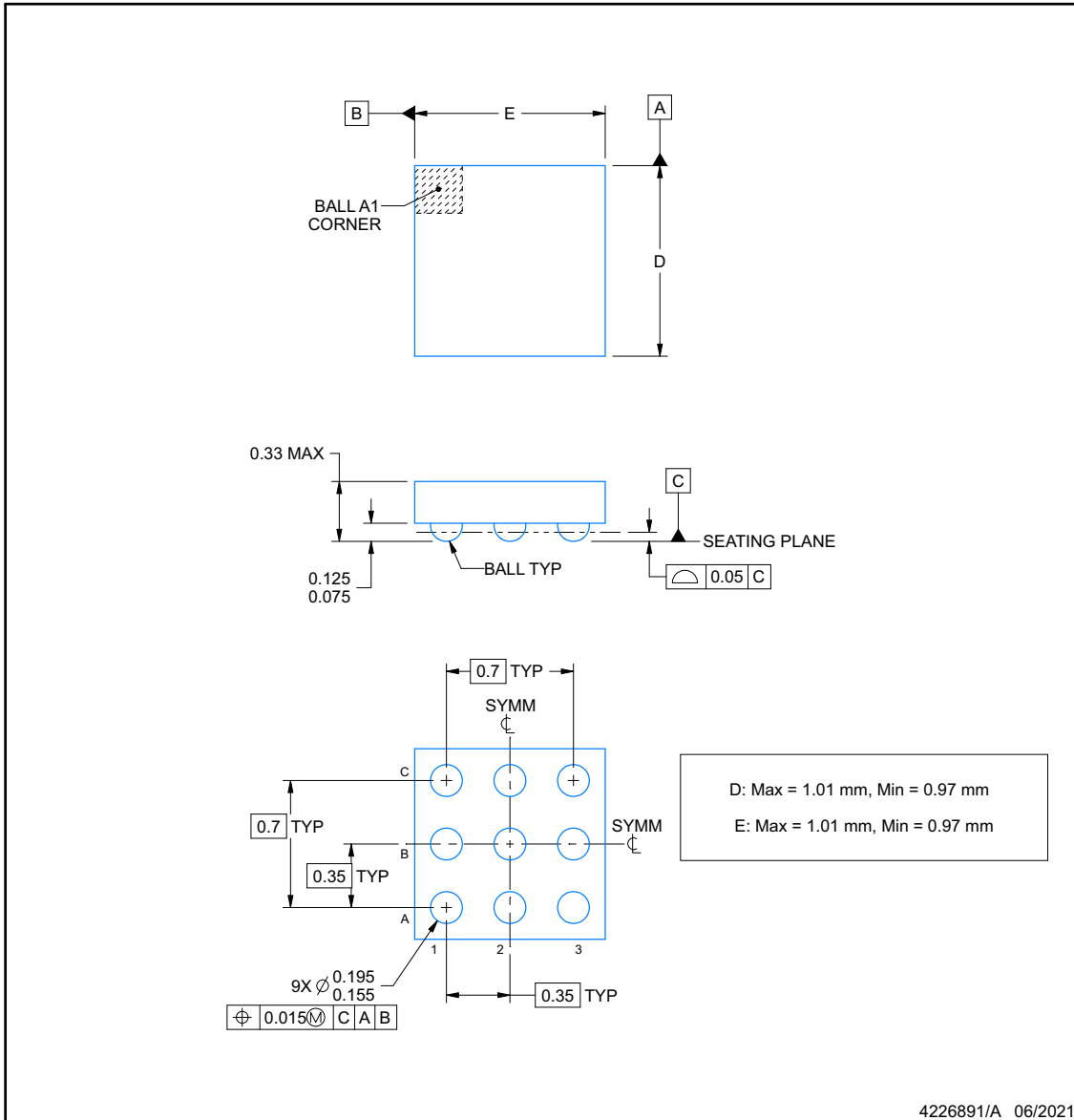
The following pages include mechanical, packaging, and orderable information. This information is the most-current data available for the designated devices. This data is subject to change without notice and without revision of this document. For browser-based versions of this data sheet, see the left-hand navigation pane.

**YCK0009-C01**



**PACKAGE OUTLINE**  
**DSBGA - 0.33 mm max height**

DIE SIZE BALL GRID ARRAY



**NOTES:**

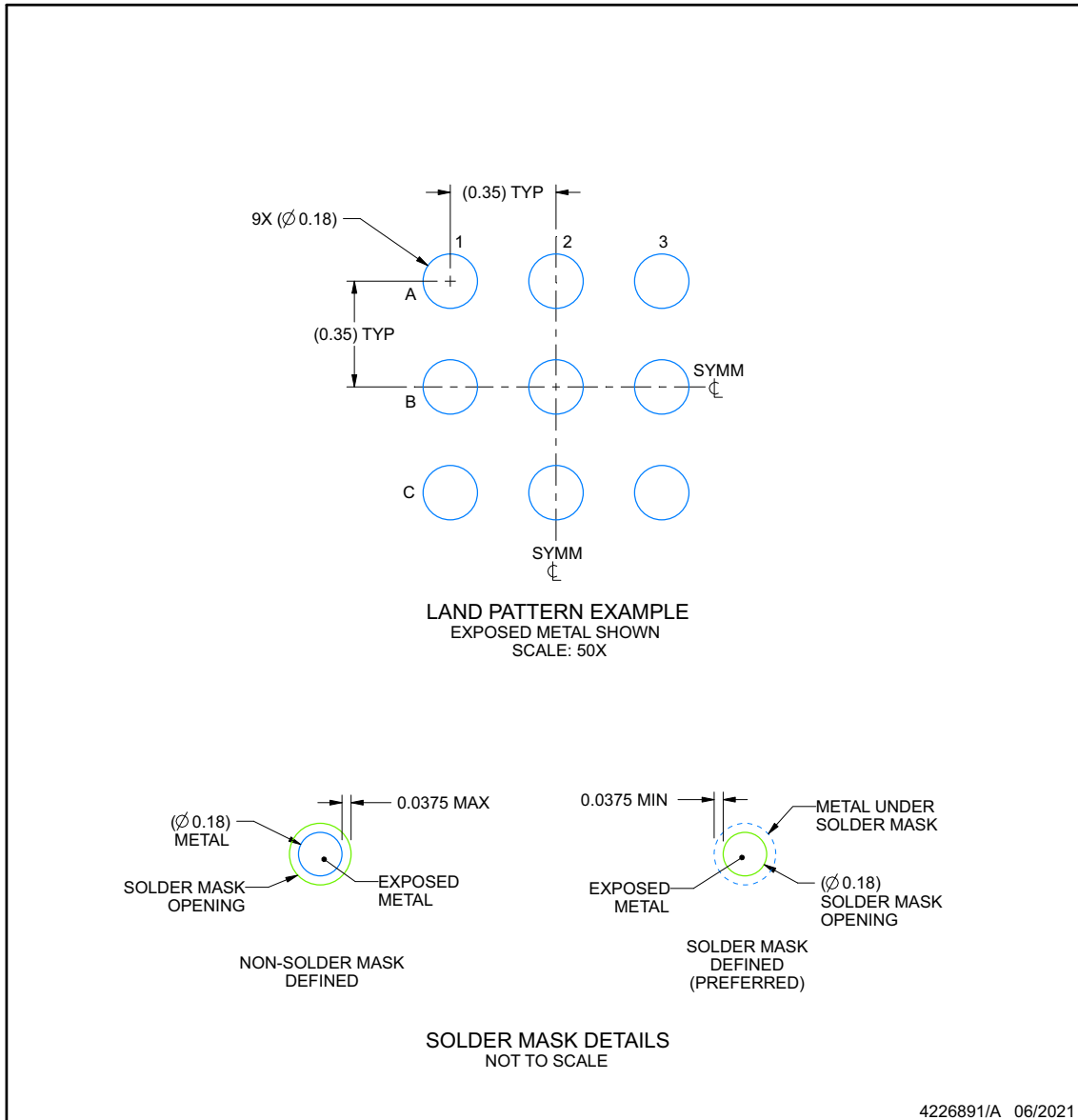
1. All linear dimensions are in millimeters. Any dimensions in parenthesis are for reference only. Dimensioning and tolerancing per ASME Y14.5M.
2. This drawing is subject to change without notice.

## EXAMPLE BOARD LAYOUT

**YCK0009-C01**

**DSBGA - 0.33 mm max height**

DIE SIZE BALL GRID ARRAY



NOTES: (continued)

- Final dimensions may vary due to manufacturing tolerance considerations and also routing constraints. See Texas Instruments Literature No. SNVA009 ([www.ti.com/lit/snva009](http://www.ti.com/lit/snva009)).

## EXAMPLE STENCIL DESIGN

**YCK0009-C01**

**DSBGA - 0.33 mm max height**

DIE SIZE BALL GRID ARRAY



NOTES: (continued)

4. Laser cutting apertures with trapezoidal walls and rounded corners may offer better paste release.

**PACKAGING INFORMATION**

Orderable part number	Status (1)	Material type (2)	Package   Pins	Package qty   Carrier	RoHS (3)	Lead finish/ Ball material (4)	MSL rating/ Peak reflow (5)	Op temp (°C)	Part marking (6)
<a href="#">TLV9061IDBVR</a>	Active	Production	SOT-23 (DBV)   5	3000   LARGE T&R	Yes	NIPDAU   SN	Level-1-260C-UNLIM	-40 to 125	1OAF
TLV9061IDBVR.A	Active	Production	SOT-23 (DBV)   5	3000   LARGE T&R	Yes	NIPDAU	Level-1-260C-UNLIM	-40 to 125	1OAF
TLV9061IDBVRG4	Active	Production	SOT-23 (DBV)   5	3000   LARGE T&R	Yes	NIPDAU	Level-1-260C-UNLIM	-40 to 125	1OAF
TLV9061IDBVRG4.A	Active	Production	SOT-23 (DBV)   5	3000   LARGE T&R	Yes	NIPDAU	Level-1-260C-UNLIM	-40 to 125	1OAF
<a href="#">TLV9061IDCKR</a>	Active	Production	SC70 (DCK)   5	3000   LARGE T&R	Yes	SN	Level-2-260C-1 YEAR	-40 to 125	1CA
TLV9061IDCKR.A	Active	Production	SC70 (DCK)   5	3000   LARGE T&R	Yes	SN	Level-2-260C-1 YEAR	-40 to 125	1CA
<a href="#">TLV9061IDPWR</a>	Active	Production	X2SON (DPW)   5	3000   LARGE T&R	Yes	NIPDAU   NIPDAUAG	Level-2-260C-1 YEAR	-40 to 125	(C, CG)
TLV9061IDPWR.A	Active	Production	X2SON (DPW)   5	3000   LARGE T&R	Yes	NIPDAUAG	Level-2-260C-1 YEAR	-40 to 125	(C, CG)
<a href="#">TLV9061SIDBVR</a>	Active	Production	SOT-23 (DBV)   6	3000   LARGE T&R	Yes	NIPDAU   SN	Level-1-260C-UNLIM	-40 to 125	1OEF
TLV9061SIDBVR.A	Active	Production	SOT-23 (DBV)   6	3000   LARGE T&R	Yes	NIPDAU	Level-1-260C-UNLIM	-40 to 125	1OEF
TLV9061SIDBVRG4	Active	Production	SOT-23 (DBV)   6	3000   LARGE T&R	Yes	NIPDAU	Level-1-260C-UNLIM	-40 to 125	1OEF
TLV9061SIDBVRG4.A	Active	Production	SOT-23 (DBV)   6	3000   LARGE T&R	Yes	NIPDAU	Level-1-260C-UNLIM	-40 to 125	1OEF
<a href="#">TLV9062IDDFR</a>	Active	Production	SOT-23-THIN (DDF)   8	3000   LARGE T&R	Yes	NIPDAU	Level-1-260C-UNLIM	-40 to 125	T062
TLV9062IDDFR.A	Active	Production	SOT-23-THIN (DDF)   8	3000   LARGE T&R	Yes	NIPDAU	Level-1-260C-UNLIM	-40 to 125	T062
<a href="#">TLV9062IDGKR</a>	Active	Production	VSSOP (DGK)   8	2500   LARGE T&R	Yes	NIPDAU   SN   NIPDAUAG	Level-2-260C-1 YEAR	-40 to 125	T062
TLV9062IDGKR.A	Active	Production	VSSOP (DGK)   8	2500   LARGE T&R	Yes	SN	Level-2-260C-1 YEAR	-40 to 125	T062
TLV9062IDGKRG4	Active	Production	VSSOP (DGK)   8	2500   LARGE T&R	Yes	NIPDAU	Level-1-260C-UNLIM	-40 to 125	T062
TLV9062IDGKRG4.A	Active	Production	VSSOP (DGK)   8	2500   LARGE T&R	Yes	NIPDAU	Level-1-260C-UNLIM	-40 to 125	T062
<a href="#">TLV9062IDGKT</a>	Active	Production	VSSOP (DGK)   8	250   SMALL T&R	Yes	NIPDAU   SN   NIPDAUAG	Level-2-260C-1 YEAR	-40 to 125	T062
TLV9062IDGKT.A	Active	Production	VSSOP (DGK)   8	250   SMALL T&R	Yes	NIPDAU	Level-2-260C-1 YEAR	-40 to 125	T062
<a href="#">TLV9062IDR</a>	Active	Production	SOIC (D)   8	2500   LARGE T&R	Yes	NIPDAU	Level-1-260C-UNLIM	-40 to 125	TL9062
TLV9062IDR.A	Active	Production	SOIC (D)   8	2500   LARGE T&R	Yes	NIPDAU	Level-1-260C-UNLIM	-40 to 125	TL9062
TLV9062IDRG4	Active	Production	SOIC (D)   8	2500   LARGE T&R	Yes	NIPDAU	Level-1-260C-UNLIM	-40 to 125	TL9062
TLV9062IDRG4.A	Active	Production	SOIC (D)   8	2500   LARGE T&R	Yes	NIPDAU	Level-1-260C-UNLIM	-40 to 125	TL9062
<a href="#">TLV9062IDSGR</a>	Active	Production	WSON (DSG)   8	3000   LARGE T&R	Yes	NIPDAU	Level-1-260C-UNLIM	-40 to 125	T062
TLV9062IDSGR.A	Active	Production	WSON (DSG)   8	3000   LARGE T&R	Yes	NIPDAU	Level-1-260C-UNLIM	-40 to 125	T062
TLV9062IDSGRG4	Active	Production	WSON (DSG)   8	3000   LARGE T&R	Yes	NIPDAU	Level-1-260C-UNLIM	-40 to 125	T062
TLV9062IDSGRG4.A	Active	Production	WSON (DSG)   8	3000   LARGE T&R	Yes	NIPDAU	Level-1-260C-UNLIM	-40 to 125	T062

Orderable part number	Status (1)	Material type (2)	Package   Pins	Package qty   Carrier	RoHS (3)	Lead finish/ Ball material (4)	MSL rating/ Peak reflow (5)	Op temp (°C)	Part marking (6)
<a href="#">TLV9062IDSGT</a>	Active	Production	WSON (DSG)   8	250   SMALL T&R	Yes	SN	Level-1-260C-UNLIM	-40 to 125	T062
TLV9062IDSGT.A	Active	Production	WSON (DSG)   8	250   SMALL T&R	Yes	SN	Level-1-260C-UNLIM	-40 to 125	T062
<a href="#">TLV9062IPWR</a>	Active	Production	TSSOP (PW)   8	2000   LARGE T&R	Yes	NIPDAU   SN	Level-2-260C-1 YEAR	-40 to 125	TL9062
TLV9062IPWR.A	Active	Production	TSSOP (PW)   8	2000   LARGE T&R	Yes	SN	Level-2-260C-1 YEAR	-40 to 125	TL9062
<a href="#">TLV9062SIDGSR</a>	Active	Production	VSSOP (DGS)   10	2500   LARGE T&R	Yes	NIPDAUAG	Level-2-260C-1 YEAR	-40 to 125	1TDX
TLV9062SIDGSR.A	Active	Production	VSSOP (DGS)   10	2500   LARGE T&R	Yes	NIPDAUAG	Level-2-260C-1 YEAR	-40 to 125	1TDX
<a href="#">TLV9062SIRUGR</a>	Active	Production	X2QFN (RUG)   10	3000   LARGE T&R	Yes	NIPDAUAG	Level-2-260C-1 YEAR	-40 to 125	EOF
TLV9062SIRUGR.A	Active	Production	X2QFN (RUG)   10	3000   LARGE T&R	Yes	NIPDAUAG	Level-2-260C-1 YEAR	-40 to 125	EOF
<a href="#">TLV9062SIYCKR</a>	Active	Production	DSBGA (YCK)   9	3000   LARGE T&R	Yes	SNAGCU	Level-1-260C-UNLIM	-40 to 125	EH
TLV9062SIYCKR.A	Active	Production	DSBGA (YCK)   9	3000   LARGE T&R	Yes	SNAGCU	Level-1-260C-UNLIM	-40 to 125	EH
<a href="#">TLV9064IDR</a>	Active	Production	SOIC (D)   14	2500   LARGE T&R	Yes	NIPDAU	Level-1-260C-UNLIM	-40 to 125	TLV9064D
TLV9064IDR.A	Active	Production	SOIC (D)   14	2500   LARGE T&R	Yes	NIPDAU	Level-1-260C-UNLIM	-40 to 125	TLV9064D
<a href="#">TLV9064IPWR</a>	Active	Production	TSSOP (PW)   14	2000   LARGE T&R	Yes	NIPDAU   SN	Level-2-260C-1 YEAR	-40 to 125	TLV9064
TLV9064IPWR.A	Active	Production	TSSOP (PW)   14	2000   LARGE T&R	Yes	SN	Level-2-260C-1 YEAR	-40 to 125	TLV9064
<a href="#">TLV9064IPWT</a>	Active	Production	TSSOP (PW)   14	250   SMALL T&R	Yes	NIPDAU   SN	Level-2-260C-1 YEAR	-40 to 125	TLV9064
TLV9064IPWT.A	Active	Production	TSSOP (PW)   14	250   SMALL T&R	Yes	SN	Level-2-260C-1 YEAR	-40 to 125	TLV9064
<a href="#">TLV9064IRTER</a>	Active	Production	WQFN (RTE)   16	3000   LARGE T&R	Yes	NIPDAU	Level-1-260C-UNLIM	-40 to 125	T9064
TLV9064IRTER.A	Active	Production	WQFN (RTE)   16	3000   LARGE T&R	Yes	NIPDAU	Level-1-260C-UNLIM	-40 to 125	T9064
<a href="#">TLV9064IRUCR</a>	Active	Production	QFN (RUC)   14	3000   LARGE T&R	Yes	NIPDAU	Level-2-260C-1 YEAR	-40 to 125	1DD
TLV9064IRUCR.A	Active	Production	QFN (RUC)   14	3000   LARGE T&R	Yes	NIPDAU	Level-2-260C-1 YEAR	-40 to 125	1DD
TLV9064IRUCRG4	Active	Production	QFN (RUC)   14	3000   LARGE T&R	Yes	NIPDAU	Level-2-260C-1 YEAR	-40 to 125	1DD
TLV9064IRUCRG4.A	Active	Production	QFN (RUC)   14	3000   LARGE T&R	Yes	NIPDAU	Level-2-260C-1 YEAR	-40 to 125	1DD
<a href="#">TLV9064SIRTER</a>	Active	Production	WQFN (RTE)   16	3000   LARGE T&R	Yes	NIPDAU	Level-1-260C-UNLIM	-40 to 125	T9064S
TLV9064SIRTER.A	Active	Production	WQFN (RTE)   16	3000   LARGE T&R	Yes	NIPDAU	Level-1-260C-UNLIM	-40 to 125	T9064S

(1) **Status:** For more details on status, see our [product life cycle](#).

(2) **Material type:** When designated, preproduction parts are prototypes/experimental devices, and are not yet approved or released for full production. Testing and final process, including without limitation quality assurance, reliability performance testing, and/or process qualification, may not yet be complete, and this item is subject to further changes or possible discontinuation. If available for ordering, purchases will be subject to an additional waiver at checkout, and are intended for early internal evaluation purposes only. These items are sold without warranties of any kind.

(3) **RoHS values:** Yes, No, RoHS Exempt. See the [TI RoHS Statement](#) for additional information and value definition.

(4) **Lead finish/Ball material:** Parts may have multiple material finish options. Finish options are separated by a vertical ruled line. Lead finish/Ball material values may wrap to two lines if the finish value exceeds the maximum column width.

(5) **MSL rating/Peak reflow:** The moisture sensitivity level ratings and peak solder (reflow) temperatures. In the event that a part has multiple moisture sensitivity ratings, only the lowest level per JEDEC standards is shown. Refer to the shipping label for the actual reflow temperature that will be used to mount the part to the printed circuit board.

(6) **Part marking:** There may be an additional marking, which relates to the logo, the lot trace code information, or the environmental category of the part.

Multiple part markings will be inside parentheses. Only one part marking contained in parentheses and separated by a "~" will appear on a part. If a line is indented then it is a continuation of the previous line and the two combined represent the entire part marking for that device.

**Important Information and Disclaimer:** The information provided on this page represents TI's knowledge and belief as of the date that it is provided. TI bases its knowledge and belief on information provided by third parties, and makes no representation or warranty as to the accuracy of such information. Efforts are underway to better integrate information from third parties. TI has taken and continues to take reasonable steps to provide representative and accurate information but may not have conducted destructive testing or chemical analysis on incoming materials and chemicals. TI and TI suppliers consider certain information to be proprietary, and thus CAS numbers and other limited information may not be available for release.

In no event shall TI's liability arising out of such information exceed the total purchase price of the TI part(s) at issue in this document sold by TI to Customer on an annual basis.

**OTHER QUALIFIED VERSIONS OF TLV9061, TLV9062, TLV9064 :**

- Automotive : [TLV9061-Q1](#), [TLV9062-Q1](#), [TLV9064-Q1](#)

NOTE: Qualified Version Definitions:

- Automotive - Q100 devices qualified for high-reliability automotive applications targeting zero defects

**TAPE AND REEL INFORMATION**

**QUADRANT ASSIGNMENTS FOR PIN 1 ORIENTATION IN TAPE**


\*All dimensions are nominal

Device	Package Type	Package Drawing	Pins	SPQ	Reel Diameter (mm)	Reel Width W1 (mm)	A0 (mm)	B0 (mm)	K0 (mm)	P1 (mm)	W (mm)	Pin1 Quadrant
TLV9061IDBVR	SOT-23	DBV	5	3000	178.0	8.4	3.2	3.2	1.4	4.0	8.0	Q3
TLV9061IDBVRG4	SOT-23	DBV	5	3000	180.0	8.4	3.2	3.2	1.4	4.0	8.0	Q3
TLV9061IDBVRG4	SOT-23	DBV	5	3000	180.0	8.4	3.2	3.2	1.4	4.0	8.0	Q3
TLV9061IDCKR	SC70	DCK	5	3000	178.0	8.4	2.25	2.45	1.2	4.0	8.0	Q3
TLV9061IDPWR	X2SON	DPW	5	3000	180.0	8.4	0.91	0.91	0.5	2.0	8.0	Q2
TLV9061SIDBVR	SOT-23	DBV	6	3000	178.0	8.4	3.2	3.2	1.4	4.0	8.0	Q3
TLV9061SIDBVRG4	SOT-23	DBV	6	3000	180.0	8.4	3.2	3.2	1.4	4.0	8.0	Q3
TLV9062IDDFR	SOT-23-THIN	DDF	8	3000	180.0	8.4	3.2	3.2	1.4	4.0	8.0	Q3
TLV9062IDGKR	VSSOP	DGK	8	2500	330.0	12.4	5.3	3.4	1.4	8.0	12.0	Q1
TLV9062IDGKR4	VSSOP	DGK	8	2500	330.0	12.4	6.4	5.2	2.1	8.0	12.0	Q1
TLV9062IDGKT	VSSOP	DGK	8	250	330.0	12.4	6.4	5.2	2.1	8.0	12.0	Q1
TLV9062IDR	SOIC	D	8	2500	330.0	12.4	6.5	5.4	2.0	8.0	12.0	Q1
TLV9062IDR	SOIC	D	8	2500	330.0	12.4	6.4	5.2	2.1	8.0	12.0	Q1
TLV9062IDRG4	SOIC	D	8	2500	330.0	12.4	6.4	5.2	2.1	8.0	12.0	Q1
TLV9062IDSGR	WSON	DSG	8	3000	180.0	8.4	2.3	2.3	1.15	4.0	8.0	Q2

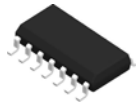
Device	Package Type	Package Drawing	Pins	SPQ	Reel Diameter (mm)	Reel Width W1 (mm)	A0 (mm)	B0 (mm)	K0 (mm)	P1 (mm)	W (mm)	Pin1 Quadrant
TLV9062IDSGRG4	WSON	DSG	8	3000	180.0	8.4	2.3	2.3	1.15	4.0	8.0	Q2
TLV9062IDSGT	WSON	DSG	8	250	180.0	8.4	2.3	2.3	1.15	4.0	8.0	Q2
TLV9062IPWR	TSSOP	PW	8	2000	330.0	12.4	7.0	3.6	1.6	8.0	12.0	Q1
TLV9062SIDGSR	VSSOP	DGS	10	2500	330.0	12.4	5.3	3.4	1.4	8.0	12.0	Q1
TLV9062SIRUGR	X2QFN	RUG	10	3000	178.0	8.4	1.75	2.25	0.56	4.0	8.0	Q1
TLV9062SIYCKR	DSBGA	YCK	9	3000	180.0	8.4	1.1	1.1	0.4	2.0	8.0	Q1
TLV9064IDR	SOIC	D	14	2500	330.0	16.4	6.5	9.0	2.1	8.0	16.0	Q1
TLV9064IPWR	TSSOP	PW	14	2000	330.0	12.4	6.9	5.6	1.6	8.0	12.0	Q1
TLV9064IPWR	TSSOP	PW	14	2000	330.0	12.4	6.9	5.6	1.6	8.0	12.0	Q1
TLV9064IPWT	TSSOP	PW	14	250	330.0	12.4	6.9	5.6	1.6	8.0	12.0	Q1
TLV9064IRTER	WQFN	RTE	16	3000	330.0	12.4	3.3	3.3	1.1	8.0	12.0	Q2
TLV9064IRUCR	QFN	RUC	14	3000	180.0	9.5	2.16	2.16	0.5	4.0	8.0	Q2
TLV9064IRUCRG4	QFN	RUC	14	3000	180.0	9.5	2.16	2.16	0.5	4.0	8.0	Q2
TLV9064SIRTER	WQFN	RTE	16	3000	330.0	12.4	3.3	3.3	1.1	8.0	12.0	Q2

**TAPE AND REEL BOX DIMENSIONS**


\*All dimensions are nominal

Device	Package Type	Package Drawing	Pins	SPQ	Length (mm)	Width (mm)	Height (mm)
TLV9061IDBVR	SOT-23	DBV	5	3000	208.0	191.0	35.0
TLV9061IDBVRG4	SOT-23	DBV	5	3000	210.0	185.0	35.0
TLV9061IDBVRG4	SOT-23	DBV	5	3000	210.0	185.0	35.0
TLV9061IDCKR	SC70	DCK	5	3000	208.0	191.0	35.0
TLV9061IDPWR	X2SON	DPW	5	3000	210.0	185.0	35.0
TLV9061SIDBVR	SOT-23	DBV	6	3000	208.0	191.0	35.0
TLV9061SIDBVRG4	SOT-23	DBV	6	3000	210.0	185.0	35.0
TLV9062IDDFR	SOT-23-THIN	DDF	8	3000	210.0	185.0	35.0
TLV9062IDGKR	VSSOP	DGK	8	2500	356.0	356.0	36.0
TLV9062IDGKRG4	VSSOP	DGK	8	2500	353.0	353.0	32.0
TLV9062IDGKT	VSSOP	DGK	8	250	353.0	353.0	32.0
TLV9062IDR	SOIC	D	8	2500	367.0	367.0	35.0
TLV9062IDR	SOIC	D	8	2500	353.0	353.0	32.0
TLV9062IDRG4	SOIC	D	8	2500	353.0	353.0	32.0
TLV9062IDSGR	WSON	DSG	8	3000	210.0	185.0	35.0
TLV9062IDSGRG4	WSON	DSG	8	3000	210.0	185.0	35.0
TLV9062IDSGT	WSON	DSG	8	250	210.0	185.0	35.0
TLV9062IPWR	TSSOP	PW	8	2000	353.0	353.0	32.0

Device	Package Type	Package Drawing	Pins	SPQ	Length (mm)	Width (mm)	Height (mm)
TLV9062SIDGSR	VSSOP	DGS	10	2500	366.0	364.0	50.0
TLV9062SIRUGR	X2QFN	RUG	10	3000	205.0	200.0	33.0
TLV9062SIYCKR	DSBGA	YCK	9	3000	182.0	182.0	20.0
TLV9064IDR	SOIC	D	14	2500	353.0	353.0	32.0
TLV9064IPWR	TSSOP	PW	14	2000	356.0	356.0	35.0
TLV9064IPWR	TSSOP	PW	14	2000	353.0	353.0	32.0
TLV9064IPWT	TSSOP	PW	14	250	353.0	353.0	32.0
TLV9064IRTER	WQFN	RTE	16	3000	367.0	367.0	35.0
TLV9064IRUCR	QFN	RUC	14	3000	205.0	200.0	30.0
TLV9064IRUCRG4	QFN	RUC	14	3000	205.0	200.0	30.0
TLV9064SIRTER	WQFN	RTE	16	3000	367.0	367.0	35.0



# D0014A

# PACKAGE OUTLINE

## SOIC - 1.75 mm max height

SMALL OUTLINE INTEGRATED CIRCUIT



4220718/A 09/2016

### NOTES:

1. All linear dimensions are in millimeters. Dimensions in parenthesis are for reference only. Dimensioning and tolerancing per ASME Y14.5M.
2. This drawing is subject to change without notice.
3. This dimension does not include mold flash, protrusions, or gate burrs. Mold flash, protrusions, or gate burrs shall not exceed 0.15 mm, per side.
4. This dimension does not include interlead flash. Interlead flash shall not exceed 0.43 mm, per side.
5. Reference JEDEC registration MS-012, variation AB.

# EXAMPLE BOARD LAYOUT

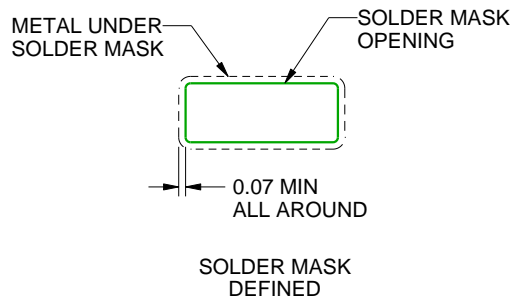
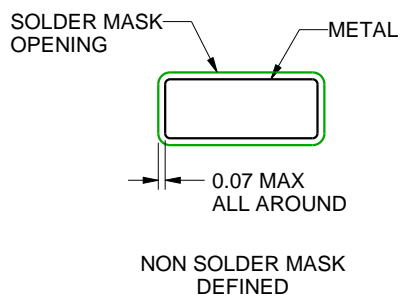
D0014A

SOIC - 1.75 mm max height

SMALL OUTLINE INTEGRATED CIRCUIT



LAND PATTERN EXAMPLE  
SCALE:8X



SOLDER MASK DETAILS

4220718/A 09/2016

NOTES: (continued)

6. Publication IPC-7351 may have alternate designs.
7. Solder mask tolerances between and around signal pads can vary based on board fabrication site.

# EXAMPLE STENCIL DESIGN

D0014A

SOIC - 1.75 mm max height

SMALL OUTLINE INTEGRATED CIRCUIT



SOLDER PASTE EXAMPLE  
BASED ON 0.125 mm THICK STENCIL  
SCALE:8X

4220718/A 09/2016

NOTES: (continued)

8. Laser cutting apertures with trapezoidal walls and rounded corners may offer better paste release. IPC-7525 may have alternate design recommendations.
9. Board assembly site may have different recommendations for stencil design.

## GENERIC PACKAGE VIEW

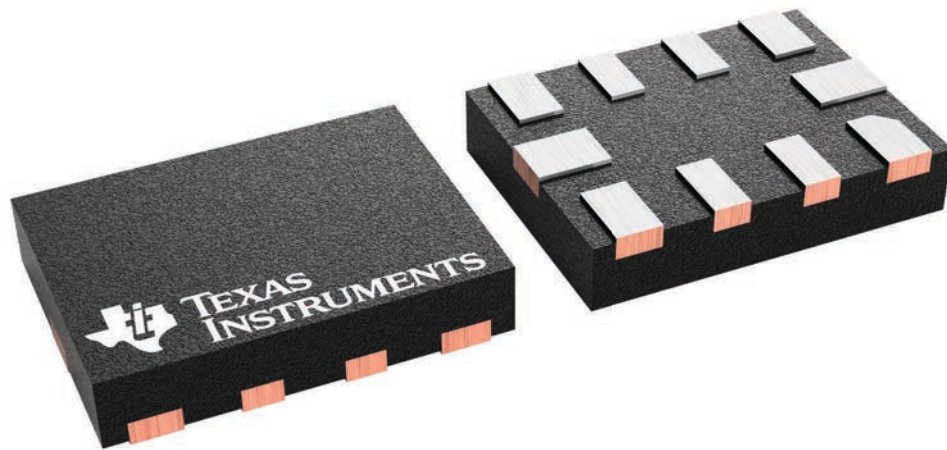
**RUG 10**

**X2QFN - 0.4 mm max height**

1.5 x 2, 0.5 mm pitch

PLASTIC QUAD FLATPACK - NO LEAD

This image is a representation of the package family, actual package may vary.  
Refer to the product data sheet for package details.



4231768/A

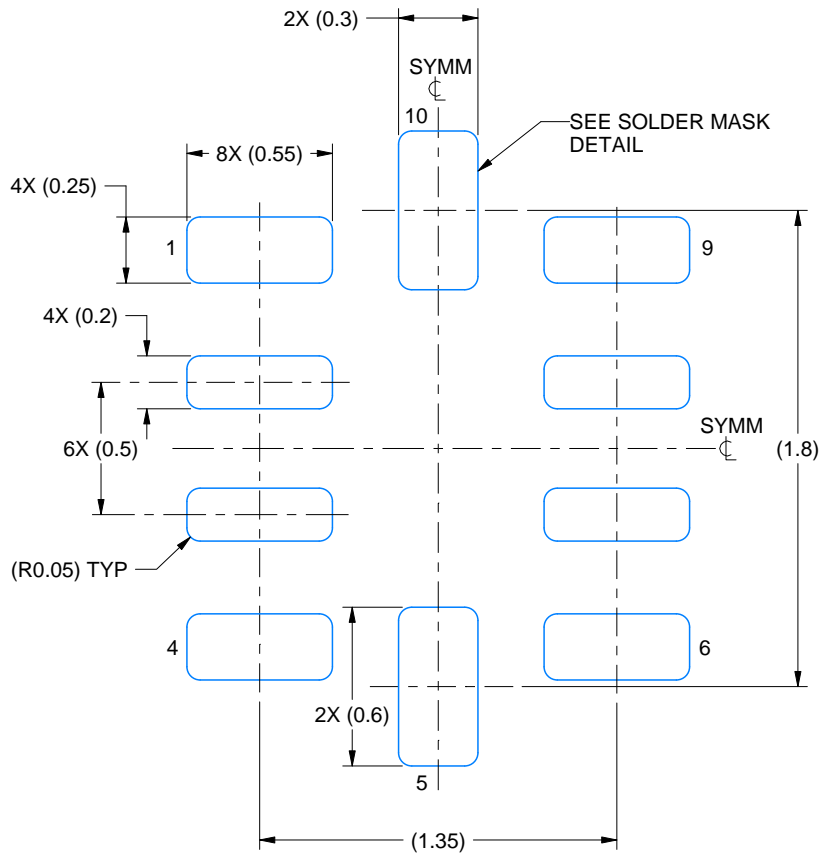


# EXAMPLE BOARD LAYOUT

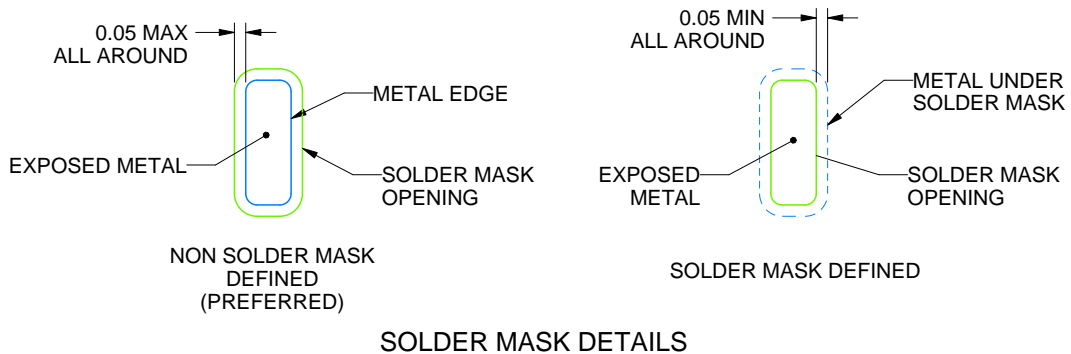
RUG0010A

X2QFN - 0.4 mm max height

PLASTIC QUAD FLATPACK - NO LEAD



LAND PATTERN EXAMPLE  
EXPOSED METAL SHOWN  
SCALE: 35X



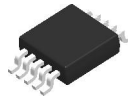
4231745/B 03/2026

NOTES: (continued)

3. For more information, see Texas Instruments literature number SLUA271 ([www.ti.com/lit/sluea271](http://www.ti.com/lit/sluea271)).



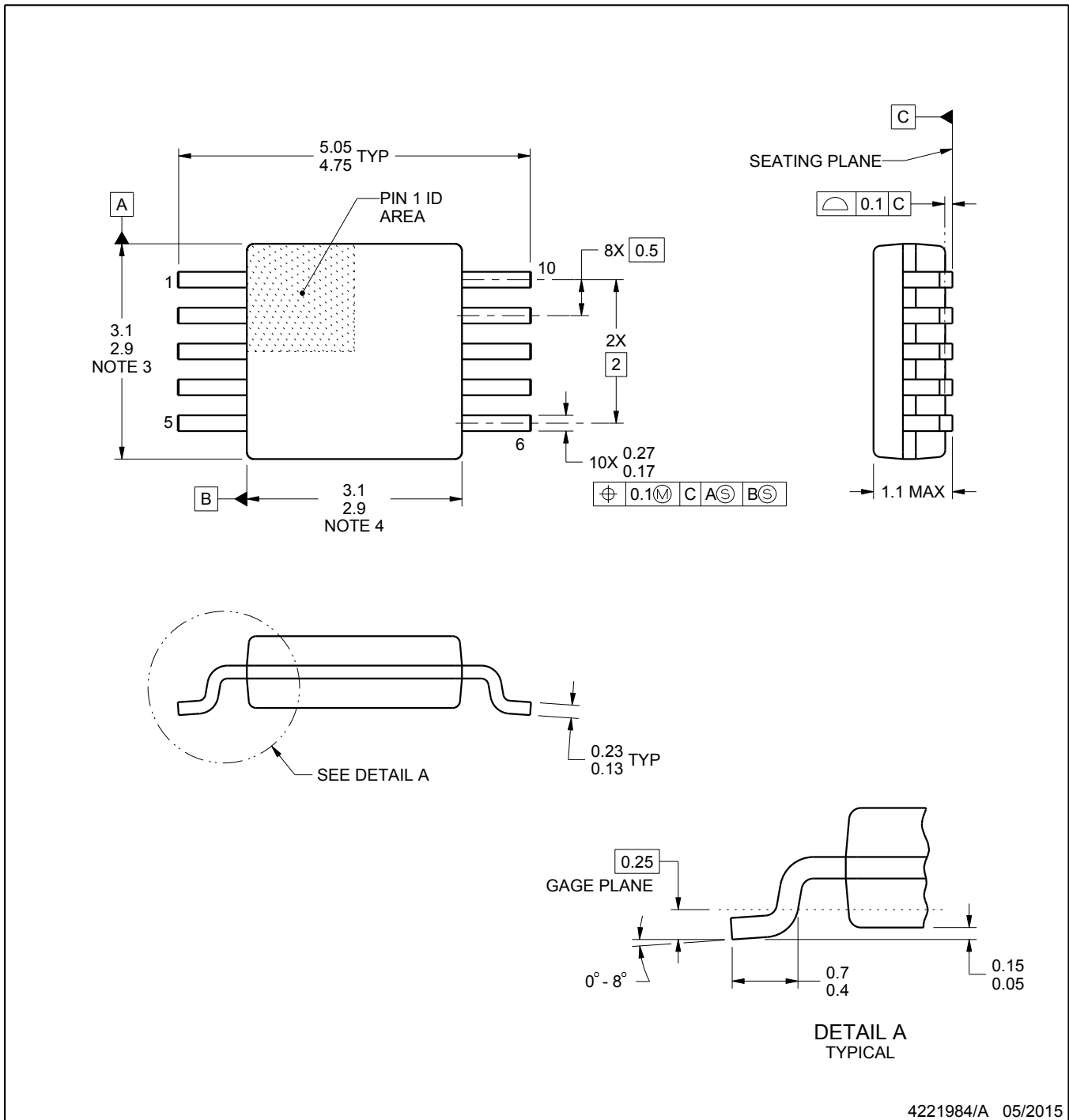
# DGS0010A



# PACKAGE OUTLINE

## VSSOP - 1.1 mm max height

SMALL OUTLINE PACKAGE



4221984/A 05/2015

### NOTES:

1. All linear dimensions are in millimeters. Any dimensions in parenthesis are for reference only. Dimensioning and tolerancing per ASME Y14.5M.
2. This drawing is subject to change without notice.
3. This dimension does not include mold flash, protrusions, or gate burrs. Mold flash, protrusions, or gate burrs shall not exceed 0.15 mm per side.
4. This dimension does not include interlead flash. Interlead flash shall not exceed 0.25 mm per side.
5. Reference JEDEC registration MO-187, variation BA.

# EXAMPLE BOARD LAYOUT

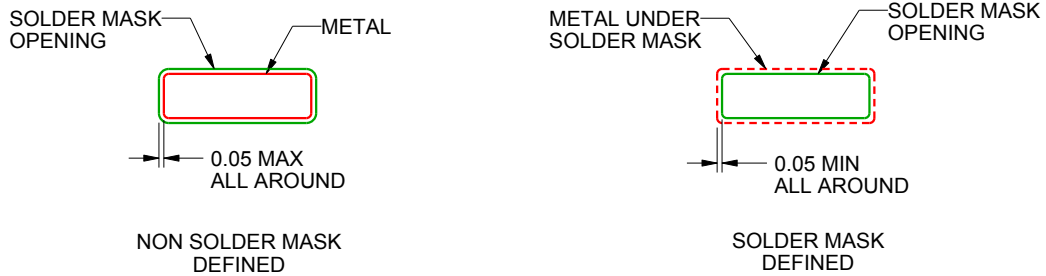
DGS0010A

VSSOP - 1.1 mm max height

SMALL OUTLINE PACKAGE



LAND PATTERN EXAMPLE  
SCALE:10X



SOLDER MASK DETAILS  
NOT TO SCALE

4221984/A 05/2015

NOTES: (continued)

- 6. Publication IPC-7351 may have alternate designs.
- 7. Solder mask tolerances between and around signal pads can vary based on board fabrication site.

# EXAMPLE STENCIL DESIGN

DGS0010A

VSSOP - 1.1 mm max height

SMALL OUTLINE PACKAGE



SOLDER PASTE EXAMPLE  
BASED ON 0.125 mm THICK STENCIL  
SCALE:10X

4221984/A 05/2015

NOTES: (continued)

8. Laser cutting apertures with trapezoidal walls and rounded corners may offer better paste release. IPC-7525 may have alternate design recommendations.
9. Board assembly site may have different recommendations for stencil design.

## GENERIC PACKAGE VIEW

DPW 5

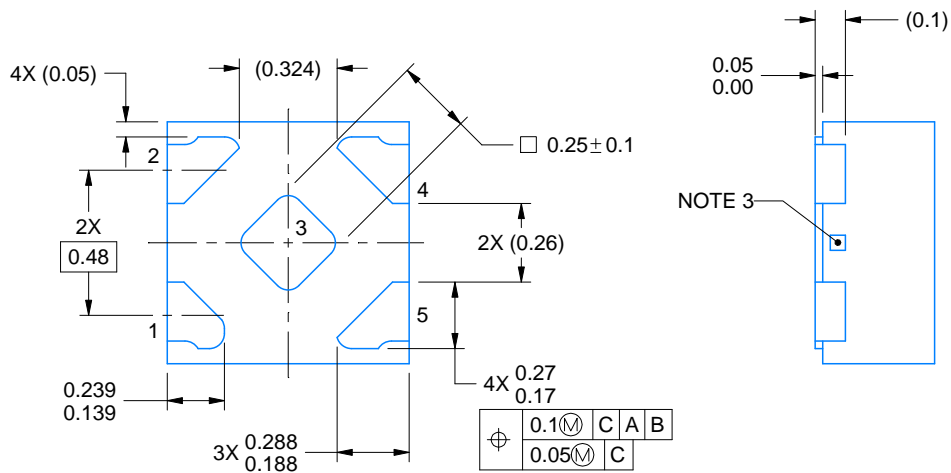
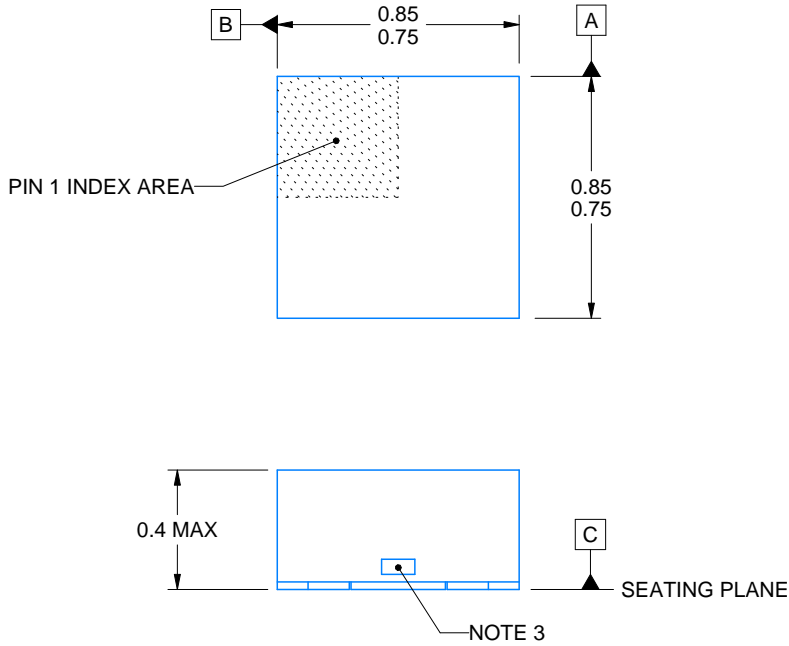
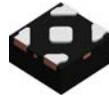
X2SON - 0.4 mm max height

PLASTIC SMALL OUTLINE - NO LEAD



Images above are just a representation of the package family, actual package may vary.  
Refer to the product data sheet for package details.

4211218-3/D



4223102/D 03/2022

NOTES:

1. All linear dimensions are in millimeters. Any dimensions in parenthesis are for reference only. Dimensioning and tolerancing per ASME Y14.5M.
2. This drawing is subject to change without notice.
3. The size and shape of this feature may vary.

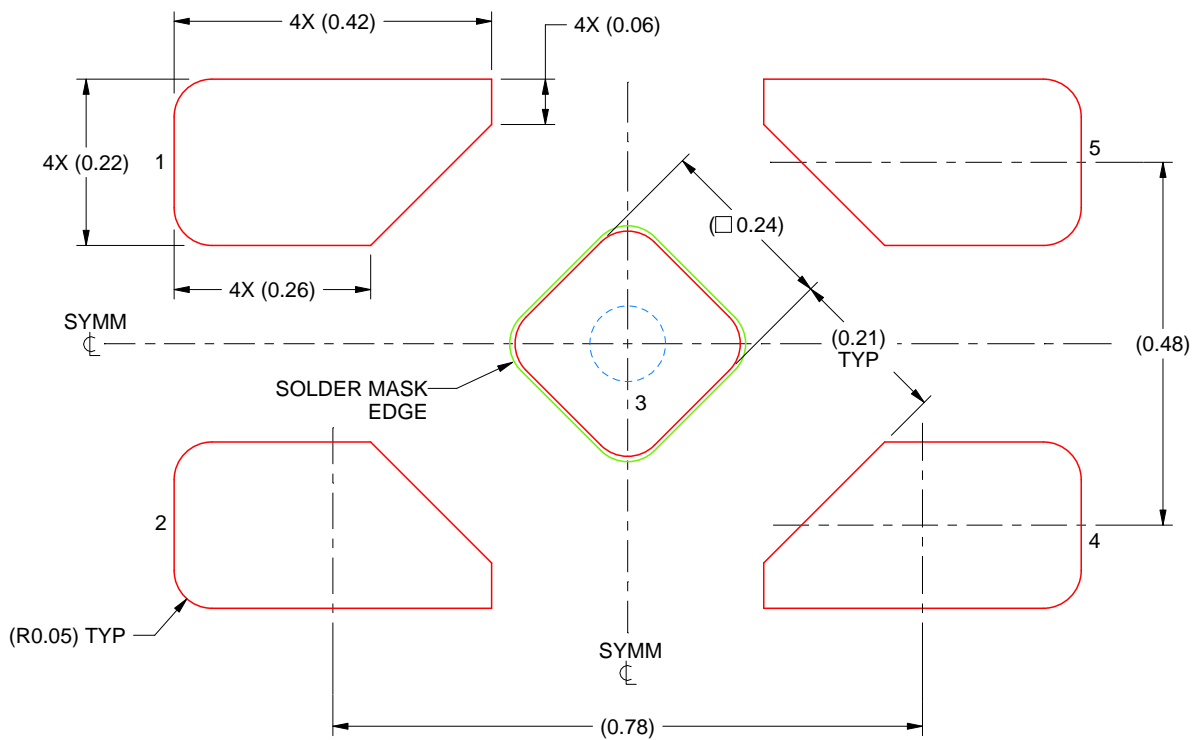


# EXAMPLE STENCIL DESIGN

DPW0005A

X2SON - 0.4 mm max height

PLASTIC SMALL OUTLINE - NO LEAD



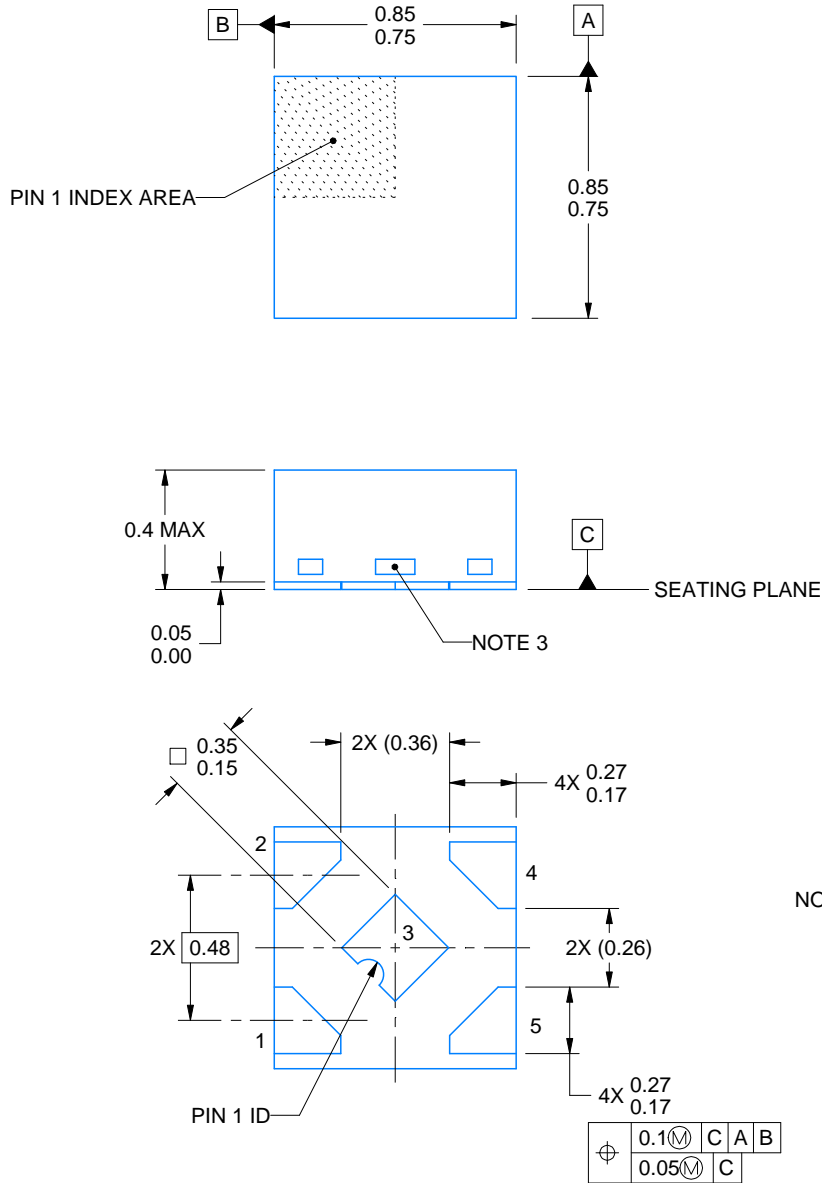
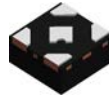
SOLDER PASTE EXAMPLE  
BASED ON 0.1 mm THICK STENCIL

EXPOSED PAD 3  
92% PRINTED SOLDER COVERAGE BY AREA UNDER PACKAGE  
SCALE:100X

4223102/D 03/2022

NOTES: (continued)

5. Laser cutting apertures with trapezoidal walls and rounded corners may offer better paste release. IPC-7525 may have alternate design recommendations.



4228233/D 09/2023

NOTES:

1. All linear dimensions are in millimeters. Any dimensions in parenthesis are for reference only. Dimensioning and tolerancing per ASME Y14.5M.
2. This drawing is subject to change without notice.
3. The size and shape of this feature may vary.

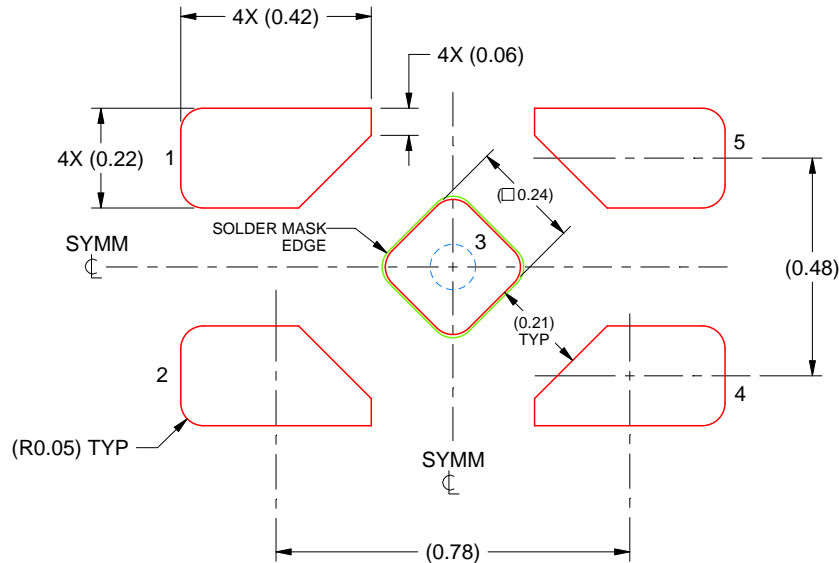


# EXAMPLE STENCIL DESIGN

DPW0005B

X2SON - 0.4 mm max height

PLASTIC SMALL OUTLINE - NO LEAD



SOLDER PASTE EXAMPLE  
BASED ON 0.1 mm THICK STENCIL

EXPOSED PAD 5  
92% PRINTED SOLDER COVERAGE BY AREA UNDER PACKAGE  
SCALE:60X

4228233/D 09/2023

NOTES: (continued)

5. Laser cutting apertures with trapezoidal walls and rounded corners may offer better paste release. IPC-7525 may have alternate design recommendations.



# EXAMPLE BOARD LAYOUT

DCK0005A

SOT - 1.1 max height

SMALL OUTLINE TRANSISTOR



LAND PATTERN EXAMPLE  
EXPOSED METAL SHOWN  
SCALE:18X



SOLDER MASK DETAILS

4214834/G 11/2024

NOTES: (continued)

- 7. Publication IPC-7351 may have alternate designs.
- 8. Solder mask tolerances between and around signal pads can vary based on board fabrication site.

# EXAMPLE STENCIL DESIGN

DCK0005A

SOT - 1.1 max height

SMALL OUTLINE TRANSISTOR



SOLDER PASTE EXAMPLE  
BASED ON 0.125 THICK STENCIL  
SCALE:18X

4214834/G 11/2024

NOTES: (continued)

9. Laser cutting apertures with trapezoidal walls and rounded corners may offer better paste release. IPC-7525 may have alternate design recommendations.
10. Board assembly site may have different recommendations for stencil design.

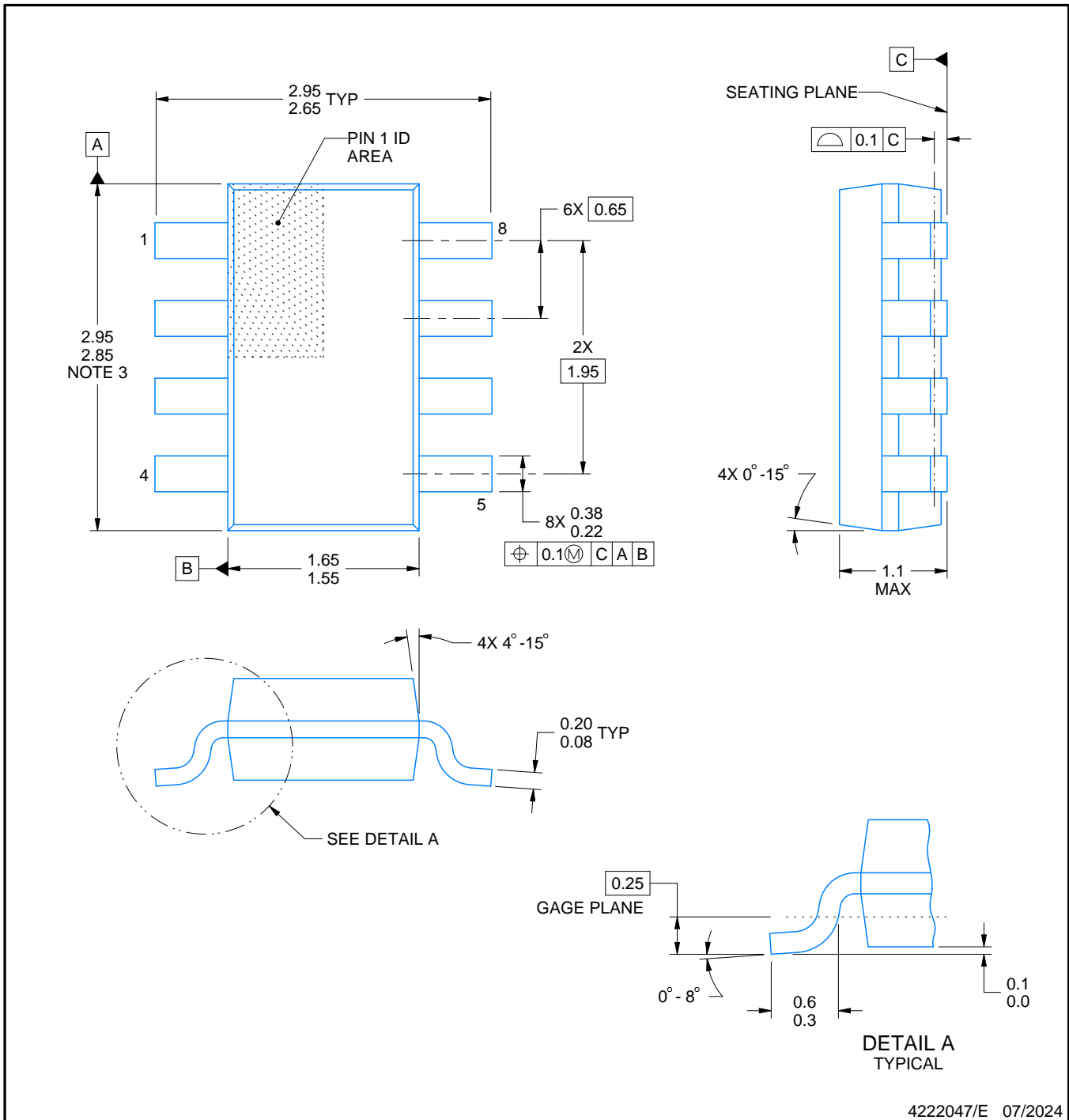
# DDF0008A



# PACKAGE OUTLINE

## SOT-23-THIN - 1.1 mm max height

PLASTIC SMALL OUTLINE



4222047/E 07/2024

**NOTES:**

1. All linear dimensions are in millimeters. Any dimensions in parenthesis are for reference only. Dimensioning and tolerancing per ASME Y14.5M.
2. This drawing is subject to change without notice.
3. This dimension does not include mold flash, protrusions, or gate burrs. Mold flash, protrusions, or gate burrs shall not exceed 0.15 mm per side.

# EXAMPLE BOARD LAYOUT

DDF0008A

SOT-23-THIN - 1.1 mm max height

PLASTIC SMALL OUTLINE



LAND PATTERN EXAMPLE  
EXPOSED METAL SHOWN  
SCALE:15X



SOLDER MASK DETAILS

4222047/E 07/2024

NOTES: (continued)

- 4. Publication IPC-7351 may have alternate designs.
- 5. Solder mask tolerances between and around signal pads can vary based on board fabrication site.

# EXAMPLE STENCIL DESIGN

DDF0008A

SOT-23-THIN - 1.1 mm max height

PLASTIC SMALL OUTLINE



SOLDER PASTE EXAMPLE  
BASED ON 0.125 mm THICK STENCIL  
SCALE:15X

4222047/E 07/2024

NOTES: (continued)

6. Laser cutting apertures with trapezoidal walls and rounded corners may offer better paste release. IPC-7525 may have alternate design recommendations.
7. Board assembly site may have different recommendations for stencil design.



D0008A

# PACKAGE OUTLINE

SOIC - 1.75 mm max height

SMALL OUTLINE INTEGRATED CIRCUIT



4214825/C 02/2019

NOTES:

- Linear dimensions are in inches [millimeters]. Dimensions in parenthesis are for reference only. Controlling dimensions are in inches. Dimensioning and tolerancing per ASME Y14.5M.
- This drawing is subject to change without notice.
- This dimension does not include mold flash, protrusions, or gate burrs. Mold flash, protrusions, or gate burrs shall not exceed .006 [0.15] per side.
- This dimension does not include interlead flash.
- Reference JEDEC registration MS-012, variation AA.

# EXAMPLE BOARD LAYOUT

D0008A

SOIC - 1.75 mm max height

SMALL OUTLINE INTEGRATED CIRCUIT



LAND PATTERN EXAMPLE  
EXPOSED METAL SHOWN  
SCALE:8X



SOLDER MASK DETAILS

4214825/C 02/2019

NOTES: (continued)

- 6. Publication IPC-7351 may have alternate designs.
- 7. Solder mask tolerances between and around signal pads can vary based on board fabrication site.

# EXAMPLE STENCIL DESIGN

D0008A

SOIC - 1.75 mm max height

SMALL OUTLINE INTEGRATED CIRCUIT



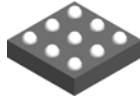
SOLDER PASTE EXAMPLE  
BASED ON .005 INCH [0.125 MM] THICK STENCIL  
SCALE:8X

4214825/C 02/2019

NOTES: (continued)

8. Laser cutting apertures with trapezoidal walls and rounded corners may offer better paste release. IPC-7525 may have alternate design recommendations.
9. Board assembly site may have different recommendations for stencil design.

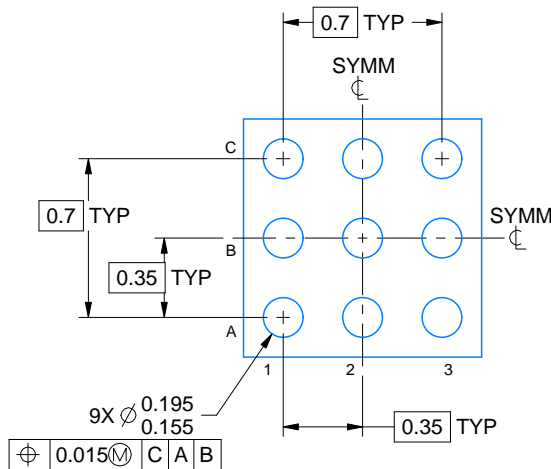
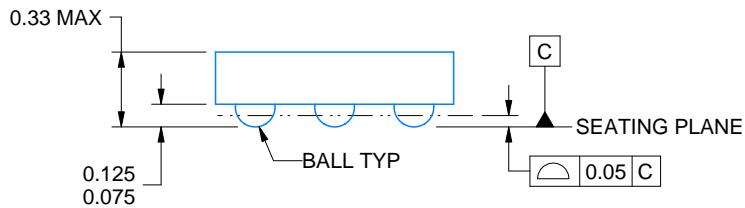
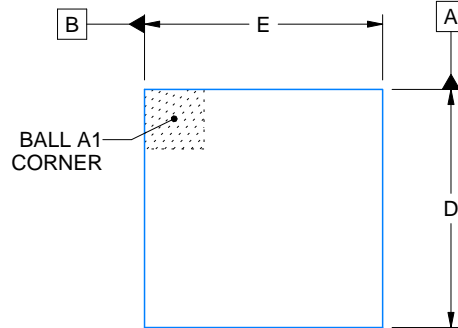
YCK0009



# PACKAGE OUTLINE

DSBGA - 0.33 mm max height

DIE SIZE BALL GRID ARRAY



D: Max = 0.98 mm, Min = 0.92 mm  
E: Max = 0.98 mm, Min = 0.92 mm

4225837/A 04/2020

NOTES:

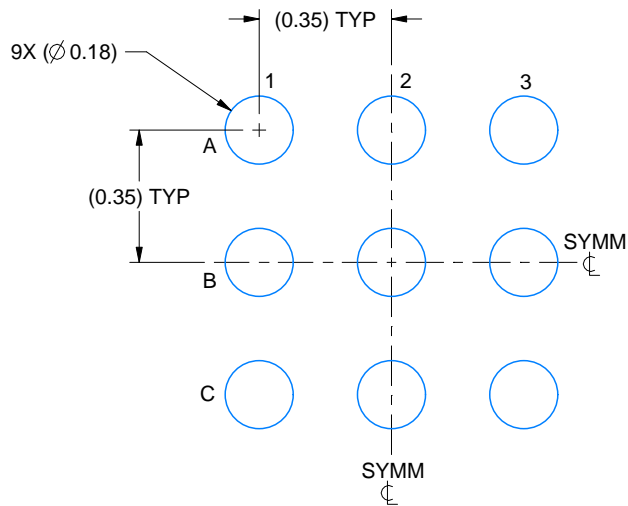
- 1. All linear dimensions are in millimeters. Any dimensions in parenthesis are for reference only. Dimensioning and tolerancing per ASME Y14.5M.
- 2. This drawing is subject to change without notice.

# EXAMPLE BOARD LAYOUT

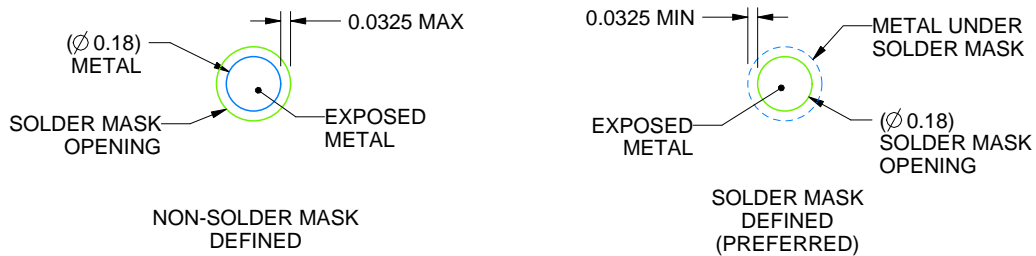
YCK0009

DSBGA - 0.33 mm max height

DIE SIZE BALL GRID ARRAY



LAND PATTERN EXAMPLE  
EXPOSED METAL SHOWN  
SCALE: 50X



SOLDER MASK DETAILS  
NOT TO SCALE

4225837/A 04/2020

NOTES: (continued)

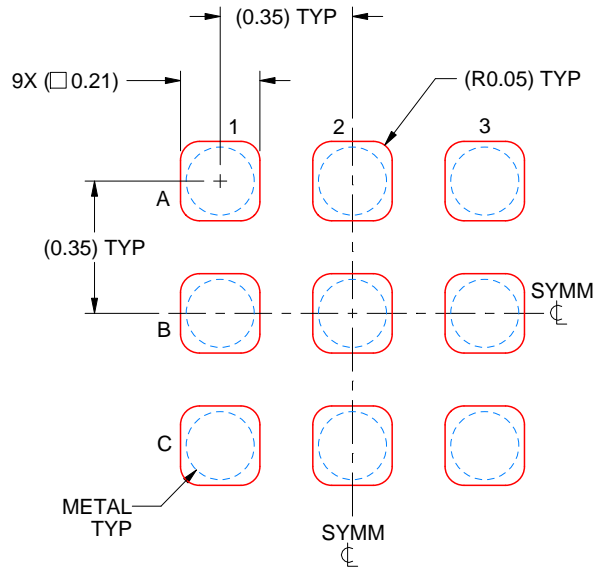
- Final dimensions may vary due to manufacturing tolerance considerations and also routing constraints. See Texas Instruments Literature No. SNVA009 ([www.ti.com/lit/snva009](http://www.ti.com/lit/snva009)).

# EXAMPLE STENCIL DESIGN

YCK0009

DSBGA - 0.33 mm max height

DIE SIZE BALL GRID ARRAY



SOLDER PASTE EXAMPLE  
BASED ON 0.075 mm THICK STENCIL  
SCALE: 50X

4225837/A 04/2020

NOTES: (continued)

4. Laser cutting apertures with trapezoidal walls and rounded corners may offer better paste release.



# EXAMPLE BOARD LAYOUT

DBV0006A

SOT-23 - 1.45 mm max height

SMALL OUTLINE TRANSISTOR



LAND PATTERN EXAMPLE  
EXPOSED METAL SHOWN  
SCALE:15X



SOLDER MASK DETAILS

4214840/G 08/2024

NOTES: (continued)

- 6. Publication IPC-7351 may have alternate designs.
- 7. Solder mask tolerances between and around signal pads can vary based on board fabrication site.

# EXAMPLE STENCIL DESIGN

DBV0006A

SOT-23 - 1.45 mm max height

SMALL OUTLINE TRANSISTOR



SOLDER PASTE EXAMPLE  
BASED ON 0.125 mm THICK STENCIL  
SCALE:15X

4214840/G 08/2024

NOTES: (continued)

8. Laser cutting apertures with trapezoidal walls and rounded corners may offer better paste release. IPC-7525 may have alternate design recommendations.
9. Board assembly site may have different recommendations for stencil design.

## GENERIC PACKAGE VIEW

**DSG 8**

**WSON - 0.8 mm max height**

2 x 2, 0.5 mm pitch

PLASTIC SMALL OUTLINE - NO LEAD

This image is a representation of the package family, actual package may vary.  
Refer to the product data sheet for package details.



4224783/A

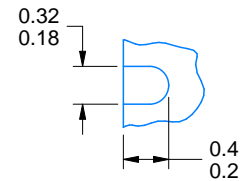
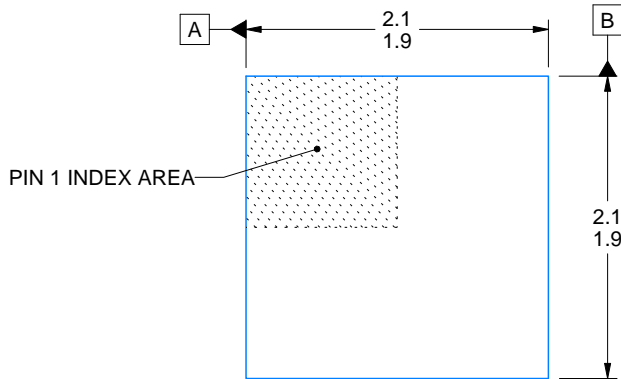
# DSG0008A



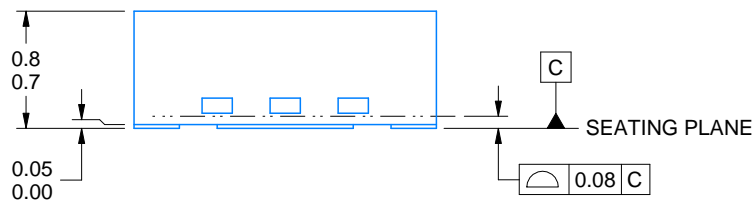
# PACKAGE OUTLINE

## WSON - 0.8 mm max height

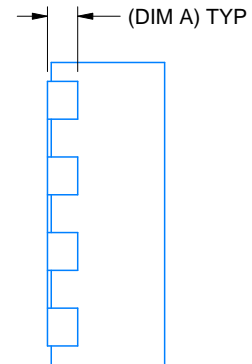
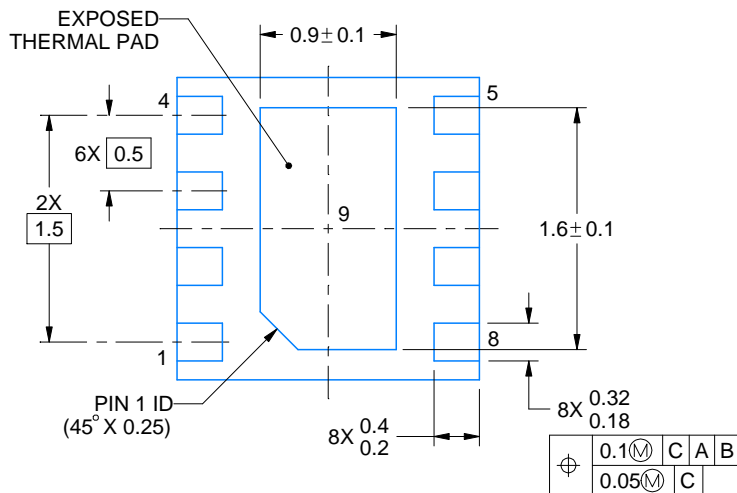
PLASTIC SMALL OUTLINE - NO LEAD



ALTERNATIVE TERMINAL SHAPE TYPICAL



SIDE WALL METAL THICKNESS DIM A	
OPTION 1	OPTION 2
0.1	0.2



4218900/E 08/2022

### NOTES:

1. All linear dimensions are in millimeters. Any dimensions in parenthesis are for reference only. Dimensioning and tolerancing per ASME Y14.5M.
2. This drawing is subject to change without notice.
3. The package thermal pad must be soldered to the printed circuit board for thermal and mechanical performance.

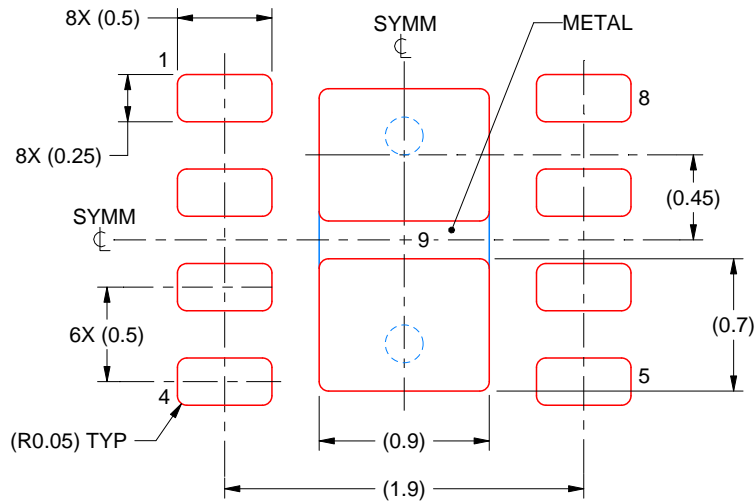


# EXAMPLE STENCIL DESIGN

DSG0008A

WSON - 0.8 mm max height

PLASTIC SMALL OUTLINE - NO LEAD



SOLDER PASTE EXAMPLE  
BASED ON 0.125 mm THICK STENCIL

EXPOSED PAD 9:  
87% PRINTED SOLDER COVERAGE BY AREA UNDER PACKAGE  
SCALE:25X

4218900/E 08/2022

NOTES: (continued)

6. Laser cutting apertures with trapezoidal walls and rounded corners may offer better paste release. IPC-7525 may have alternate design recommendations.

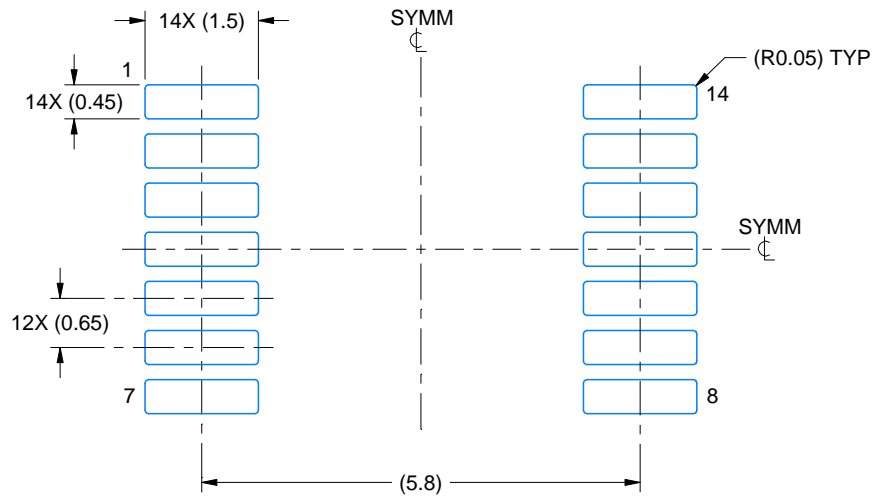


# EXAMPLE BOARD LAYOUT

PW0014A

TSSOP - 1.2 mm max height

SMALL OUTLINE PACKAGE



LAND PATTERN EXAMPLE  
EXPOSED METAL SHOWN  
SCALE: 10X



4220202/B 12/2023

NOTES: (continued)

- 6. Publication IPC-7351 may have alternate designs.
- 7. Solder mask tolerances between and around signal pads can vary based on board fabrication site.

# EXAMPLE STENCIL DESIGN

PW0014A

TSSOP - 1.2 mm max height

SMALL OUTLINE PACKAGE



SOLDER PASTE EXAMPLE  
BASED ON 0.125 mm THICK STENCIL  
SCALE: 10X

4220202/B 12/2023

NOTES: (continued)

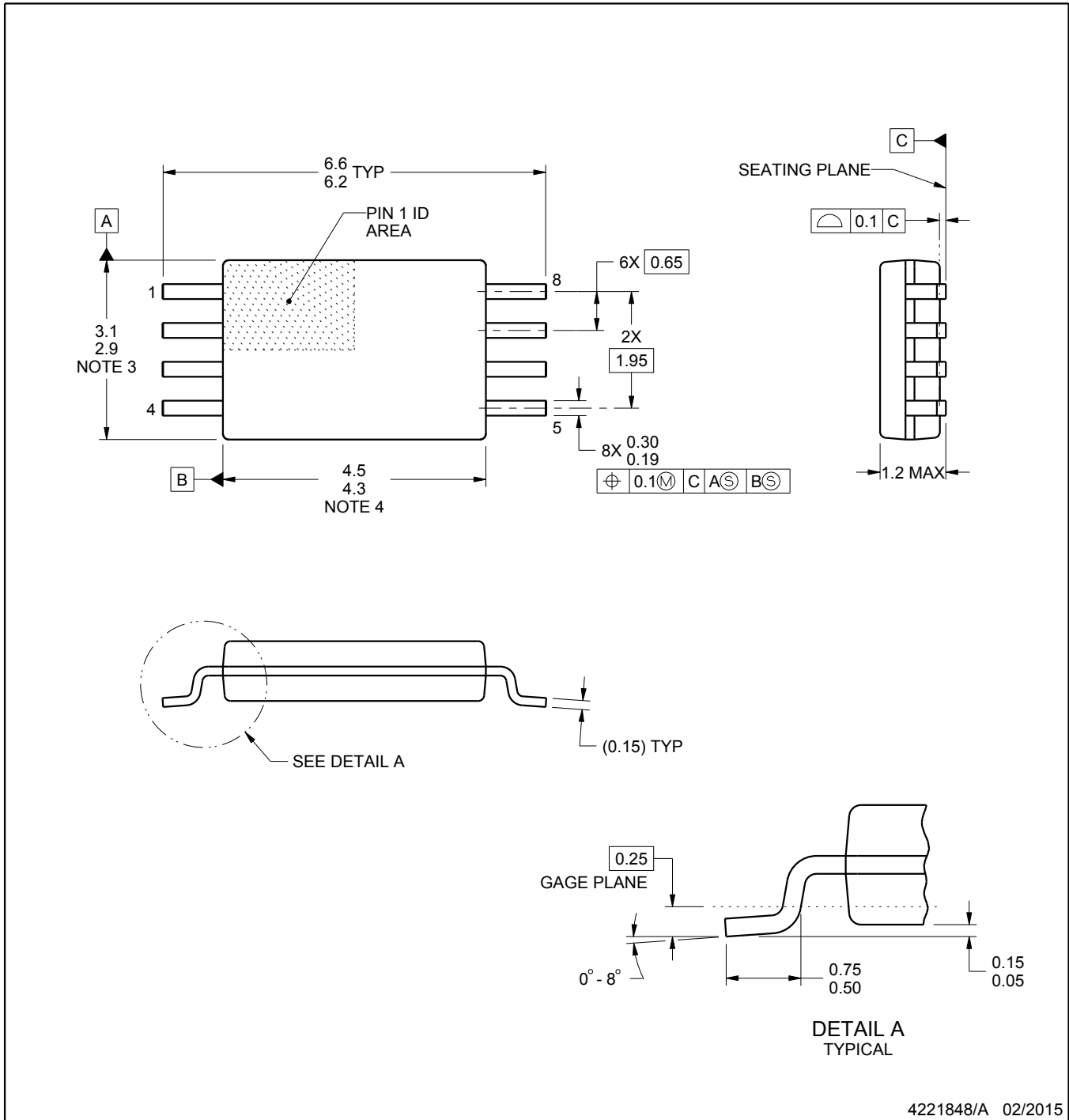
8. Laser cutting apertures with trapezoidal walls and rounded corners may offer better paste release. IPC-7525 may have alternate design recommendations.
9. Board assembly site may have different recommendations for stencil design.

PW0008A



**PACKAGE OUTLINE**  
**TSSOP - 1.2 mm max height**

SMALL OUTLINE PACKAGE



4221848/A 02/2015

NOTES:

1. All linear dimensions are in millimeters. Any dimensions in parenthesis are for reference only. Dimensioning and tolerancing per ASME Y14.5M.
2. This drawing is subject to change without notice.
3. This dimension does not include mold flash, protrusions, or gate burrs. Mold flash, protrusions, or gate burrs shall not exceed 0.15 mm per side.
4. This dimension does not include interlead flash. Interlead flash shall not exceed 0.25 mm per side.
5. Reference JEDEC registration MO-153, variation AA.

# EXAMPLE BOARD LAYOUT

PW0008A

TSSOP - 1.2 mm max height

SMALL OUTLINE PACKAGE



LAND PATTERN EXAMPLE  
SCALE:10X



SOLDER MASK DETAILS  
NOT TO SCALE

4221848/A 02/2015

NOTES: (continued)

- 6. Publication IPC-7351 may have alternate designs.
- 7. Solder mask tolerances between and around signal pads can vary based on board fabrication site.

# EXAMPLE STENCIL DESIGN

PW0008A

TSSOP - 1.2 mm max height

SMALL OUTLINE PACKAGE



SOLDER PASTE EXAMPLE  
BASED ON 0.125 mm THICK STENCIL  
SCALE:10X

4221848/A 02/2015

NOTES: (continued)

8. Laser cutting apertures with trapezoidal walls and rounded corners may offer better paste release. IPC-7525 may have alternate design recommendations.
9. Board assembly site may have different recommendations for stencil design.

## GENERIC PACKAGE VIEW

**RUC 14**

**X2QFN - 0.4 mm max height**

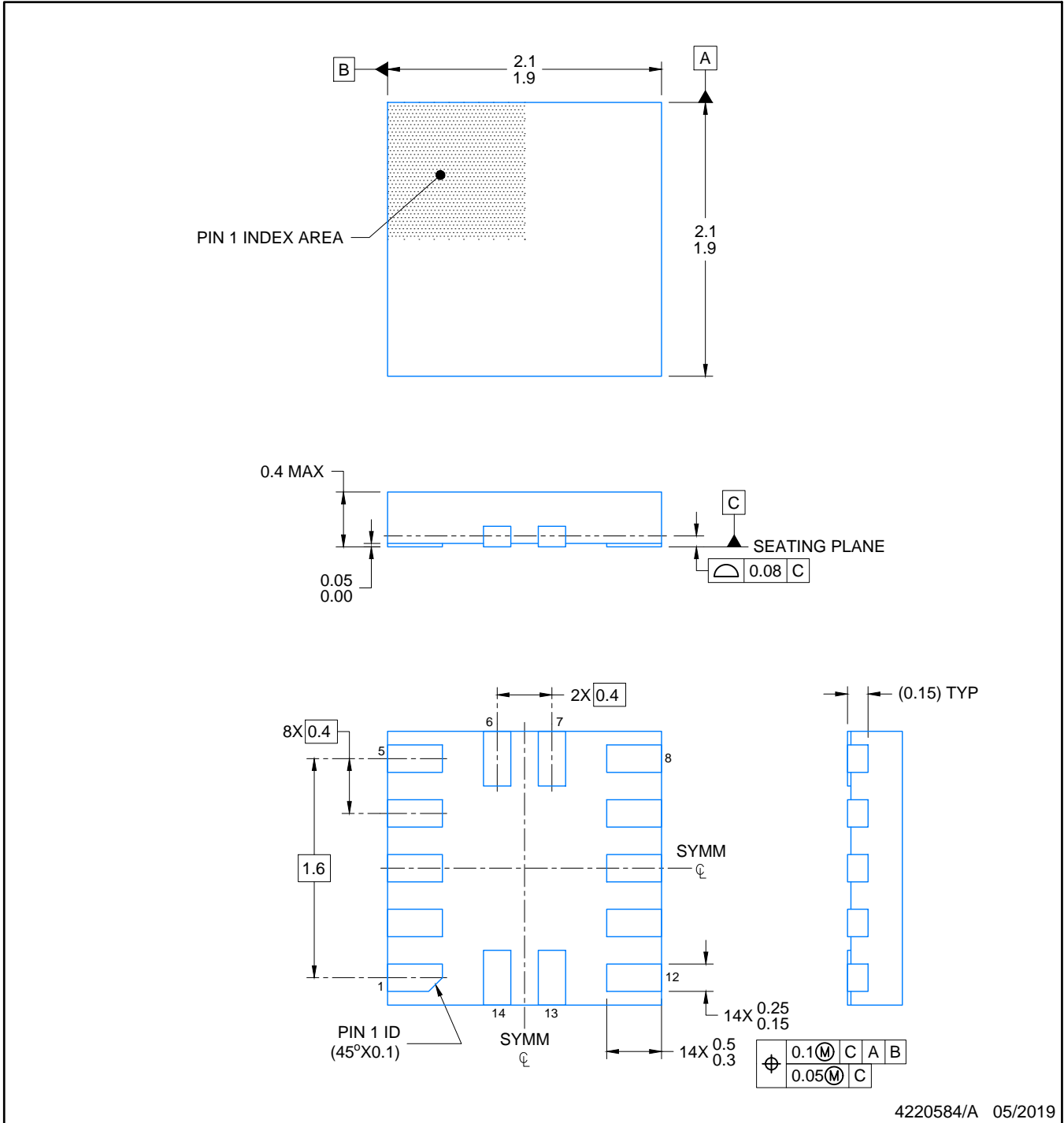
2 x 2, 0.4 mm pitch

PLASTIC QUAD FLATPACK - NO LEAD

This image is a representation of the package family, actual package may vary.  
Refer to the product data sheet for package details.

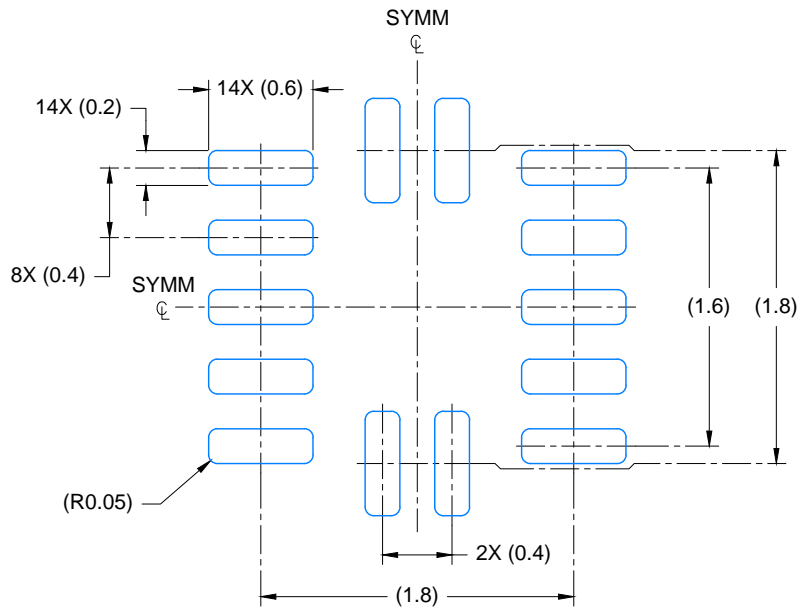


4229871/A

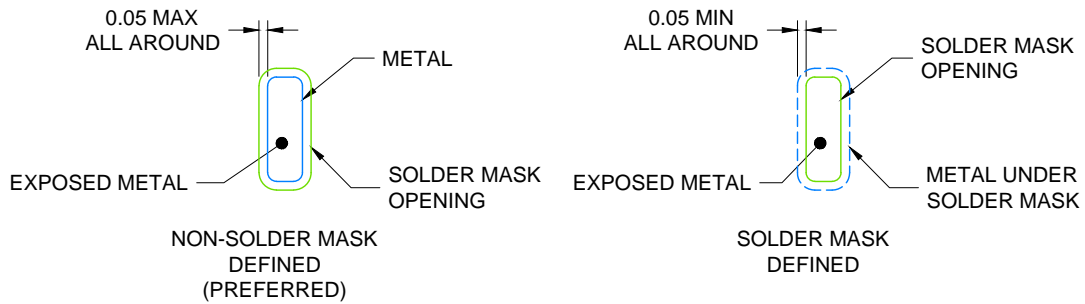


NOTES:

1. All linear dimensions are in millimeters. Any dimensions in parenthesis are for reference only. Dimensioning and tolerancing per ASME Y14.5M.
2. This drawing is subject to change without notice.



LAND PATTERN EXAMPLE  
EXPOSED METAL SHOWN  
SCALE: 23X



SOLDER MASK DETAILS

4220584/A 05/2019

NOTES: (continued)

- For more information, see Texas Instruments literature number SLUA271 ([www.ti.com/lit/slua271](http://www.ti.com/lit/slua271)).

# EXAMPLE STENCIL DESIGN

RUC0014A

X2QFN - 0.4 mm max height

PLASTIC QUAD FLAT PACK- NO LEAD



SOLDER PASTE EXAMPLE  
BASED ON 0.100mm THICK STENCIL  
SCALE: 23X

4220584/A 05/2019

NOTES: (continued)

4. Laser cutting apertures with trapezoidal walls and rounded corners may offer better paste release. IPC-7525 may have alternate design recommendations.

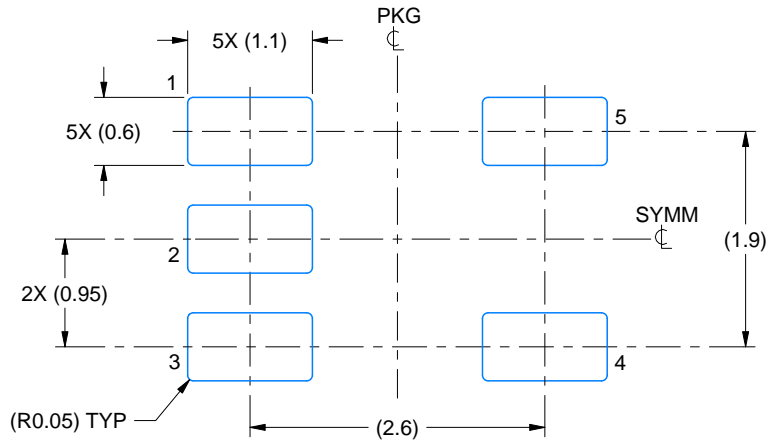


# EXAMPLE BOARD LAYOUT

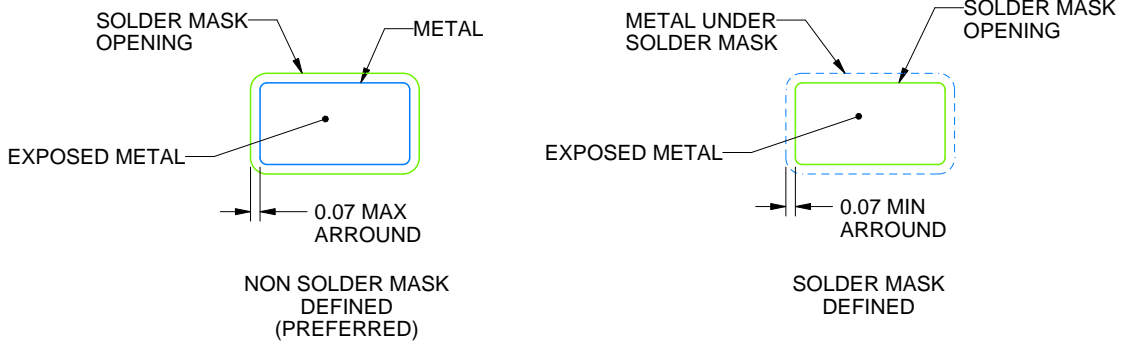
DBV0005A

SOT-23 - 1.45 mm max height

SMALL OUTLINE TRANSISTOR



LAND PATTERN EXAMPLE  
EXPOSED METAL SHOWN  
SCALE:15X



SOLDER MASK DETAILS

4214839/K 08/2024

NOTES: (continued)

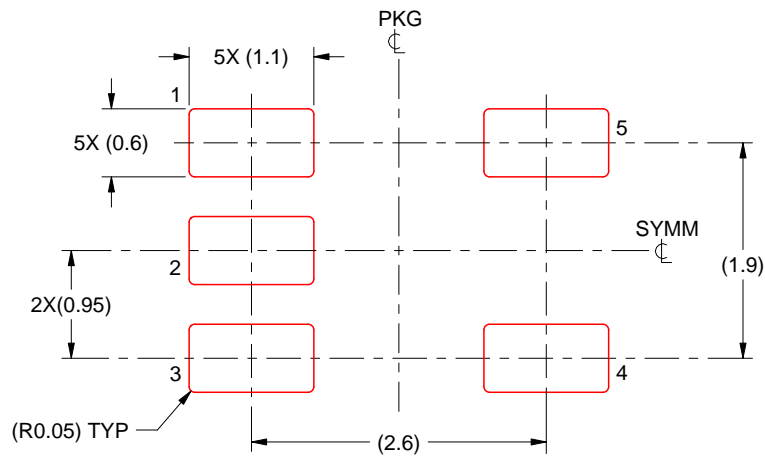
- 6. Publication IPC-7351 may have alternate designs.
- 7. Solder mask tolerances between and around signal pads can vary based on board fabrication site.

# EXAMPLE STENCIL DESIGN

DBV0005A

SOT-23 - 1.45 mm max height

SMALL OUTLINE TRANSISTOR



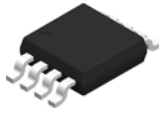
SOLDER PASTE EXAMPLE  
BASED ON 0.125 mm THICK STENCIL  
SCALE:15X

4214839/K 08/2024

NOTES: (continued)

8. Laser cutting apertures with trapezoidal walls and rounded corners may offer better paste release. IPC-7525 may have alternate design recommendations.
9. Board assembly site may have different recommendations for stencil design.

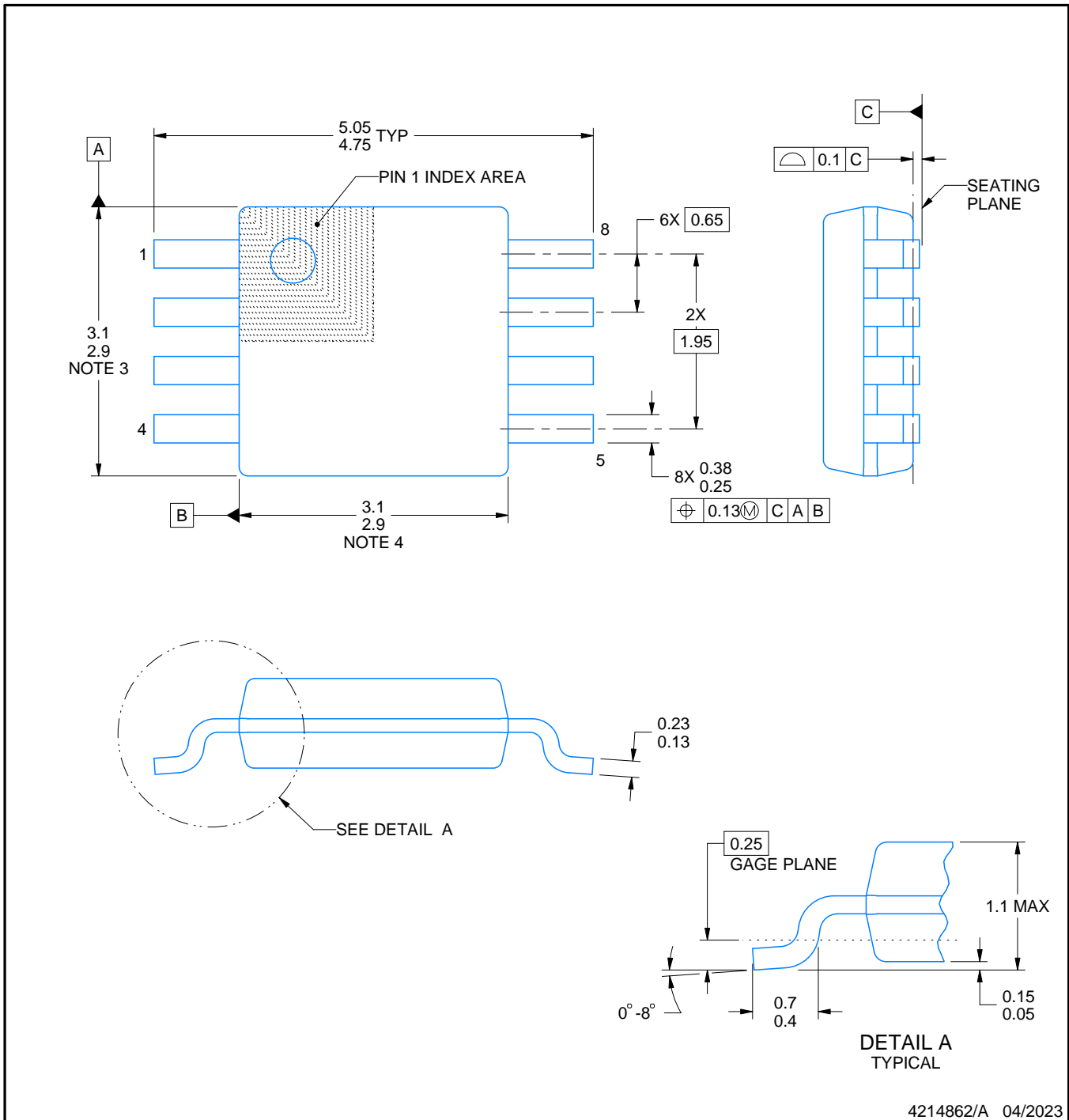
# DGK0008A



# PACKAGE OUTLINE

VSSOP - 1.1 mm max height

SMALL OUTLINE PACKAGE



4214862/A 04/2023

**NOTES:**

PowerPAD is a trademark of Texas Instruments.

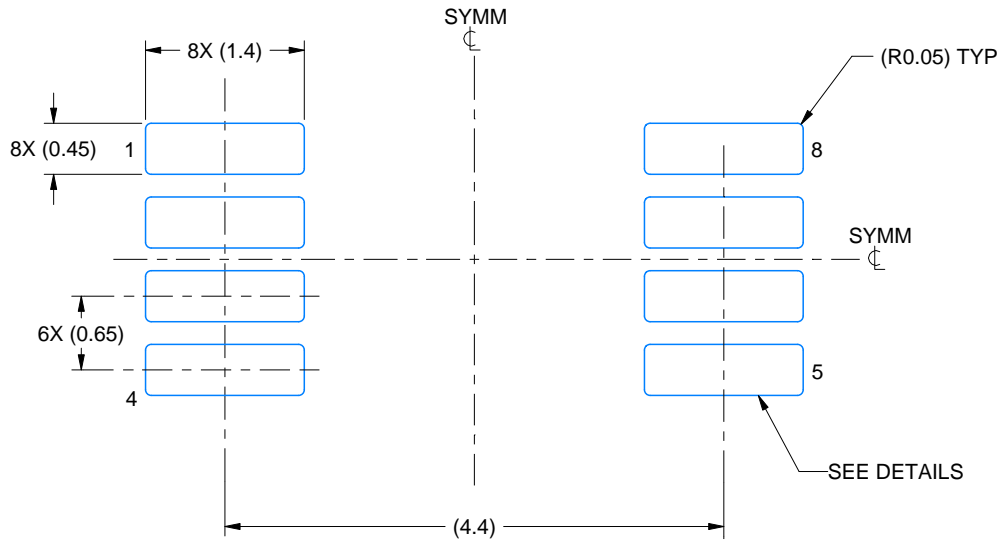
1. All linear dimensions are in millimeters. Any dimensions in parenthesis are for reference only. Dimensioning and tolerancing per ASME Y14.5M.
2. This drawing is subject to change without notice.
3. This dimension does not include mold flash, protrusions, or gate burrs. Mold flash, protrusions, or gate burrs shall not exceed 0.15 mm per side.
4. This dimension does not include interlead flash. Interlead flash shall not exceed 0.25 mm per side.
5. Reference JEDEC registration MO-187.

# EXAMPLE BOARD LAYOUT

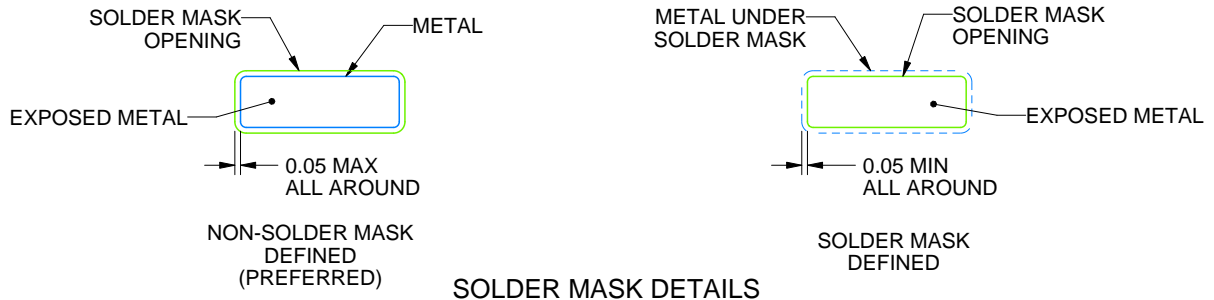
DGK0008A

™ VSSOP - 1.1 mm max height

SMALL OUTLINE PACKAGE



LAND PATTERN EXAMPLE  
EXPOSED METAL SHOWN  
SCALE: 15X



4214862/A 04/2023

NOTES: (continued)

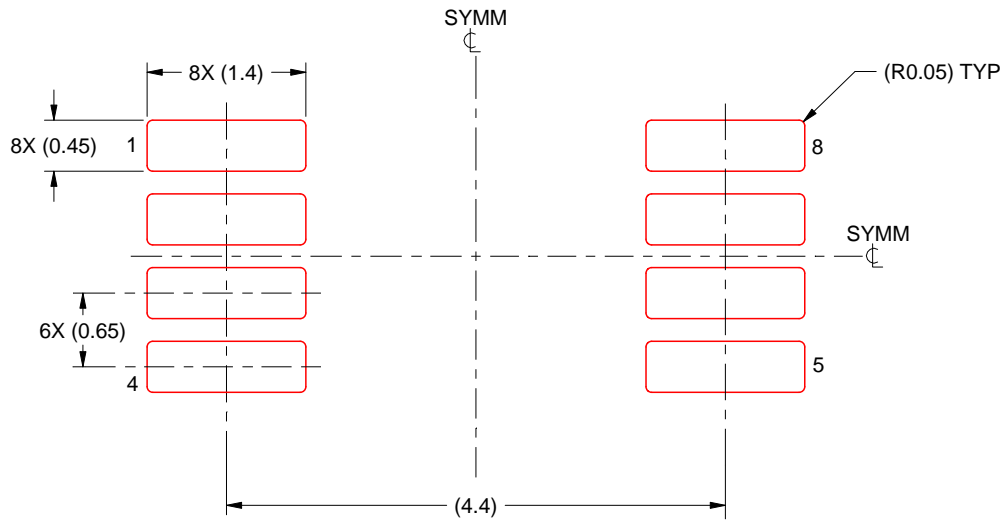
6. Publication IPC-7351 may have alternate designs.
7. Solder mask tolerances between and around signal pads can vary based on board fabrication site.
8. Vias are optional depending on application, refer to device data sheet. If any vias are implemented, refer to their locations shown on this view. It is recommended that vias under paste be filled, plugged or tented.
9. Size of metal pad may vary due to creepage requirement.

# EXAMPLE STENCIL DESIGN

DGK0008A

<sup>TM</sup> VSSOP - 1.1 mm max height

SMALL OUTLINE PACKAGE



SOLDER PASTE EXAMPLE  
SCALE: 15X

4214862/A 04/2023

NOTES: (continued)

11. Laser cutting apertures with trapezoidal walls and rounded corners may offer better paste release. IPC-7525 may have alternate design recommendations.
12. Board assembly site may have different recommendations for stencil design.

## GENERIC PACKAGE VIEW

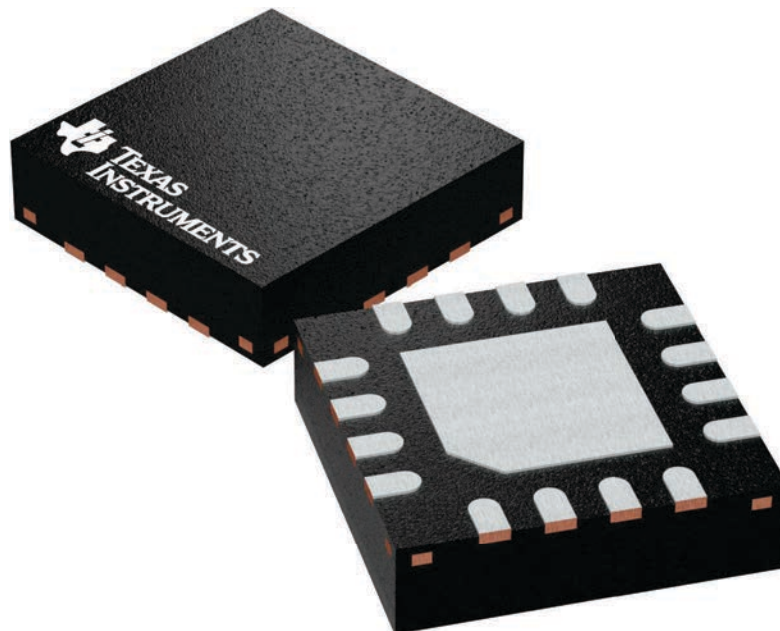
**RTE 16**

**WQFN - 0.8 mm max height**

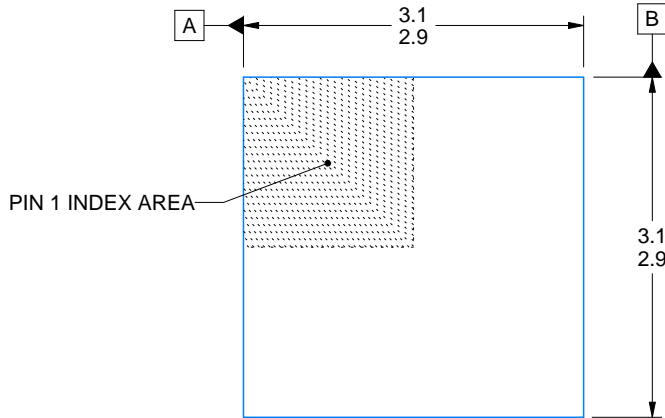
3 x 3, 0.5 mm pitch

PLASTIC QUAD FLATPACK - NO LEAD

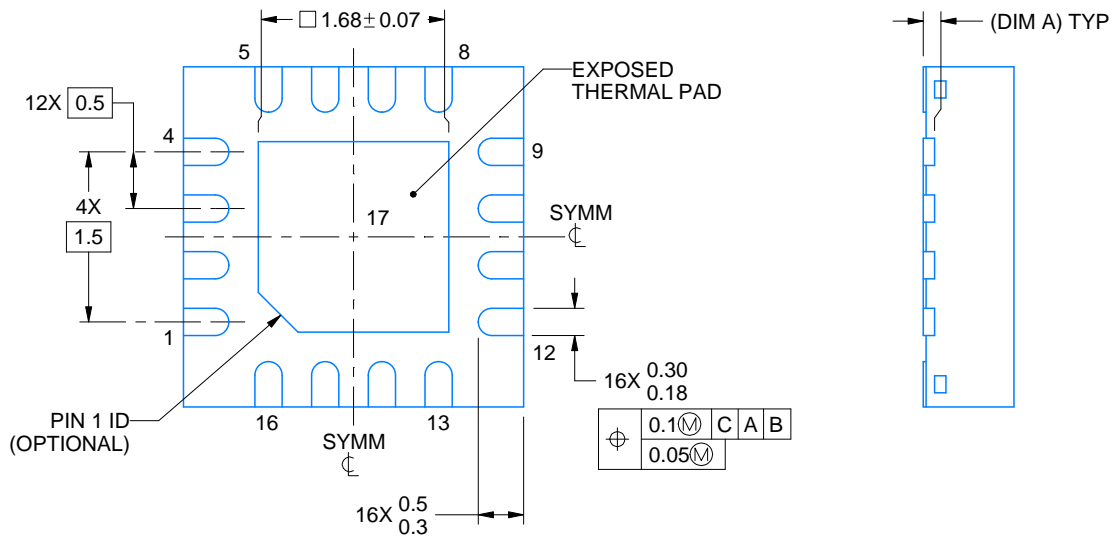
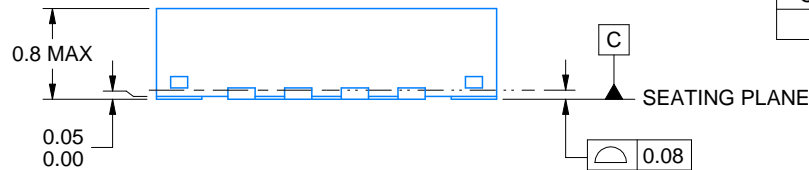
This image is a representation of the package family, actual package may vary.  
Refer to the product data sheet for package details.



4225944/A



SIDE WALL METAL THICKNESS DIM A	
OPTION 1	OPTION 2
0.1	0.2



4219117/B 04/2022

NOTES:

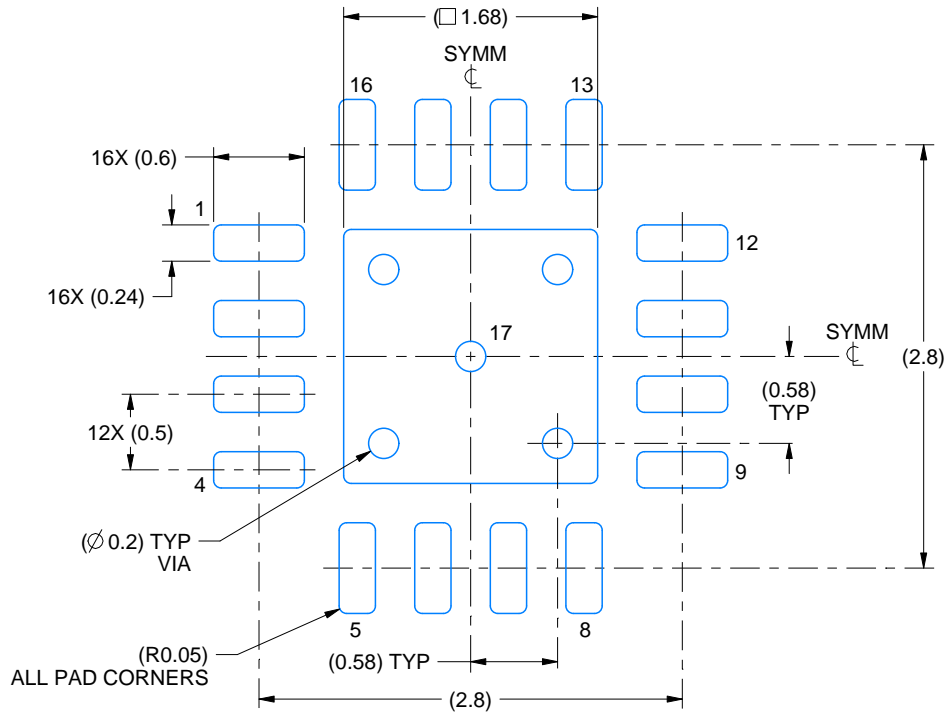
1. All linear dimensions are in millimeters. Any dimensions in parenthesis are for reference only. Dimensioning and tolerancing per ASME Y14.5M.
2. This drawing is subject to change without notice.
3. The package thermal pad must be soldered to the printed circuit board for thermal and mechanical performance.

# EXAMPLE BOARD LAYOUT

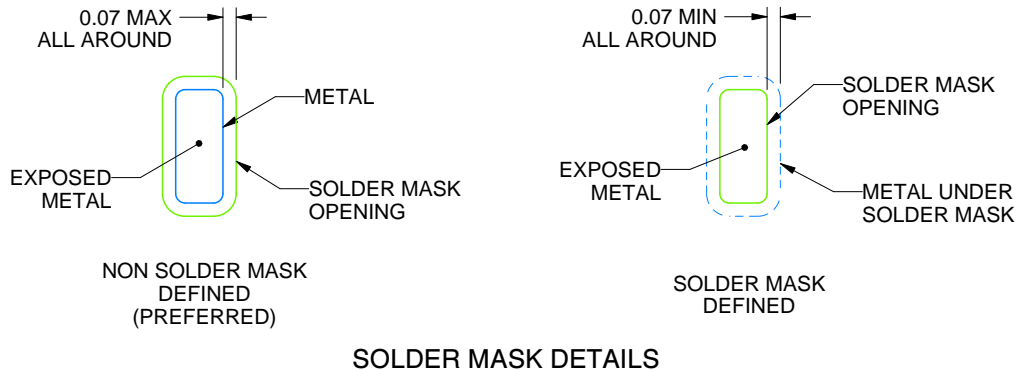
RTE0016C

WQFN - 0.8 mm max height

PLASTIC QUAD FLATPACK - NO LEAD



LAND PATTERN EXAMPLE  
EXPOSED METAL SHOWN  
SCALE:20X



4219117/B 04/2022

NOTES: (continued)

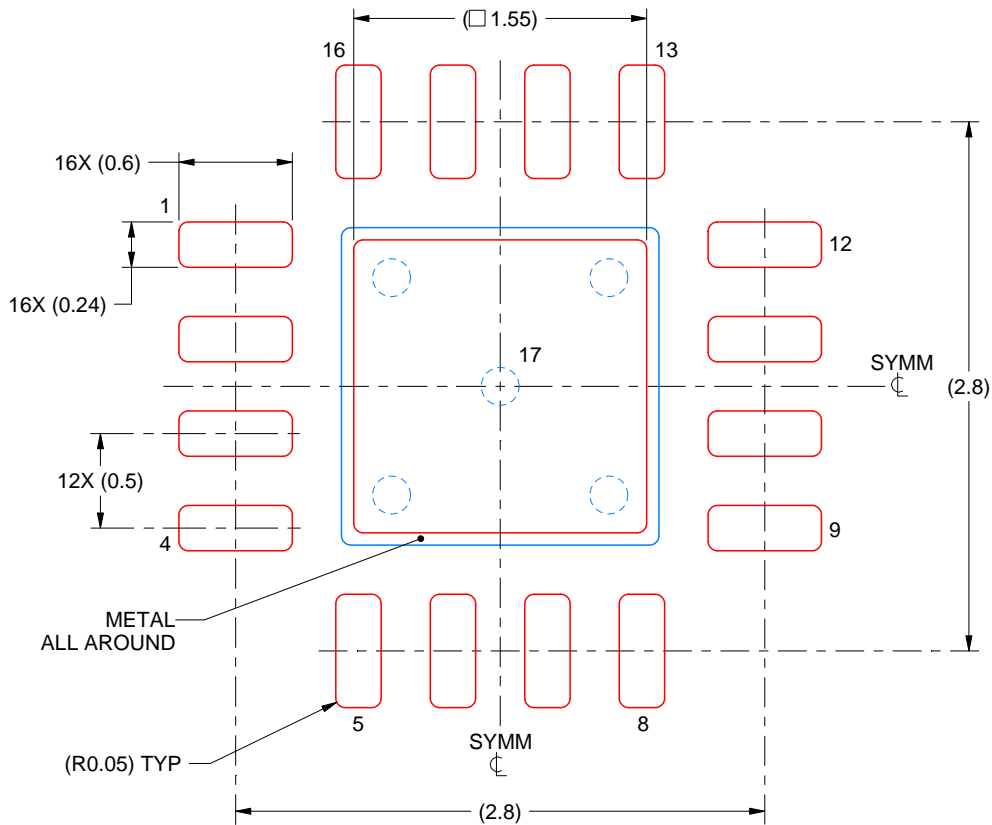
- This package is designed to be soldered to a thermal pad on the board. For more information, see Texas Instruments literature number SLUA271 ([www.ti.com/lit/sl原因271](http://www.ti.com/lit/sl原因271)).
- Vias are optional depending on application, refer to device data sheet. If any vias are implemented, refer to their locations shown on this view. It is recommended that vias under paste be filled, plugged or tented.

# EXAMPLE STENCIL DESIGN

RTE0016C

WQFN - 0.8 mm max height

PLASTIC QUAD FLATPACK - NO LEAD



**SOLDER PASTE EXAMPLE**  
BASED ON 0.125 mm THICK STENCIL

EXPOSED PAD 17:  
85% PRINTED SOLDER COVERAGE BY AREA UNDER PACKAGE  
SCALE:25X

4219117/B 04/2022

NOTES: (continued)

6. Laser cutting apertures with trapezoidal walls and rounded corners may offer better paste release. IPC-7525 may have alternate design recommendations.

## IMPORTANT NOTICE AND DISCLAIMER

TI PROVIDES TECHNICAL AND RELIABILITY DATA (INCLUDING DATASHEETS), DESIGN RESOURCES (INCLUDING REFERENCE DESIGNS), APPLICATION OR OTHER DESIGN ADVICE, WEB TOOLS, SAFETY INFORMATION, AND OTHER RESOURCES "AS IS" AND WITH ALL FAULTS, AND DISCLAIMS ALL WARRANTIES, EXPRESS AND IMPLIED, INCLUDING WITHOUT LIMITATION ANY IMPLIED WARRANTIES OF MERCHANTABILITY, FITNESS FOR A PARTICULAR PURPOSE OR NON-INFRINGEMENT OF THIRD PARTY INTELLECTUAL PROPERTY RIGHTS.

These resources are intended for skilled developers designing with TI products. You are solely responsible for (1) selecting the appropriate TI products for your application, (2) designing, validating and testing your application, and (3) ensuring your application meets applicable standards, and any other safety, security, regulatory or other requirements.

These resources are subject to change without notice. TI grants you permission to use these resources only for development of an application that uses the TI products described in the resource. Other reproduction and display of these resources is prohibited. No license is granted to any other TI intellectual property right or to any third party intellectual property right. TI disclaims responsibility for, and you fully indemnify TI and its representatives against any claims, damages, costs, losses, and liabilities arising out of your use of these resources.

TI's products are provided subject to [TI's Terms of Sale](#), [TI's General Quality Guidelines](#), or other applicable terms available either on [ti.com](http://ti.com) or provided in conjunction with such TI products. TI's provision of these resources does not expand or otherwise alter TI's applicable warranties or warranty disclaimers for TI products. Unless TI explicitly designates a product as custom or customer-specified, TI products are standard, catalog, general purpose devices.

TI objects to and rejects any additional or different terms you may propose.

Copyright © 2026, Texas Instruments Incorporated

Last updated 10/2025