

## TPS53515 1.5-V to 18-V (4.5-V to 25-V Bias) Input, 12-A Single Synchronous Step-Down SWIFT™ Converter

### 1 Features

- Integrated 13.8-mΩ and 5.9-mΩ MOSFETs With 12-A Continuous Output Current
- Supports All Ceramic Output Capacitors
- Reference Voltage 600 mV ±0.5% Tolerance
- Output Voltage Range: 0.6 V to 5.5 V
- D-CAP3™ Control Mode With Fast Load-Step Response
- Auto-Skipping Eco-mode™ for High Light-Load Efficiency
- FCCM for Tight Output Ripple and Voltage Requirements
- Eight Selectable Frequency Settings from 250 kHz to 1 MHz
- Precharged Startup Capability
- Built-in Output Discharge Circuit
- Open-Drain Power-Good Output
- 3.5 mm × 4.5 mm, 28-Pin, VQFN-CLIP Package

### 2 Applications

- Server and Cloud-Computing POLs
- Broadband, Networking, and Optical Communications Infrastructure
- I/O Supplies
- Supported at the [WEBENCH® Design Center](#)

### 3 Description

The TPS53515 device is a small-sized, synchronous buck converter with an adaptive on-time D-CAP3 control mode. The device offers ease-of-use and low external-component count for space-conscious power systems.

This device features high-performance integrated MOSFETs, accurate 0.5% 0.6-V reference, and an integrated boost switch. Competitive features include very low external-component count, fast load-transient response, auto-skip mode operation, internal soft-start control, and no requirement for compensation.

A forced continuous conduction mode helps meet tight voltage regulation accuracy requirements for performance DSPs and FPGAs. The TPS53515 device is available in a 28-pin VQFN-CLIP package and is specified from –40°C to 85°C ambient temperature.

#### Device Information (1)

PART NUMBER	PACKAGE	BODY SIZE (NOM)
TPS53515	VQFN-CLIP (28)	4.50 mm × 3.50 mm

(1) For all available packages, see the orderable addendum at the end of the datasheet.

#### Simplified Schematic

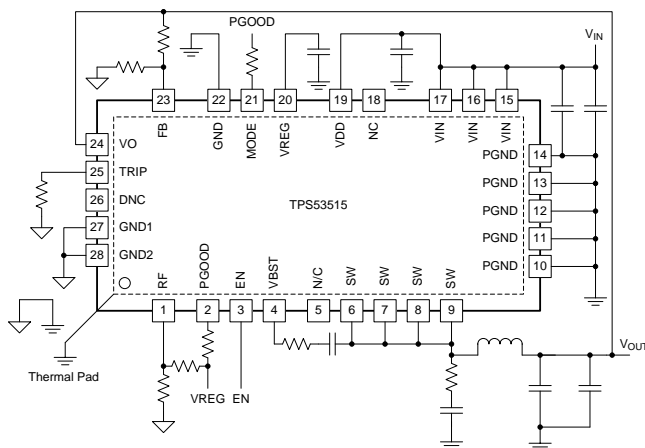

#### Efficiency

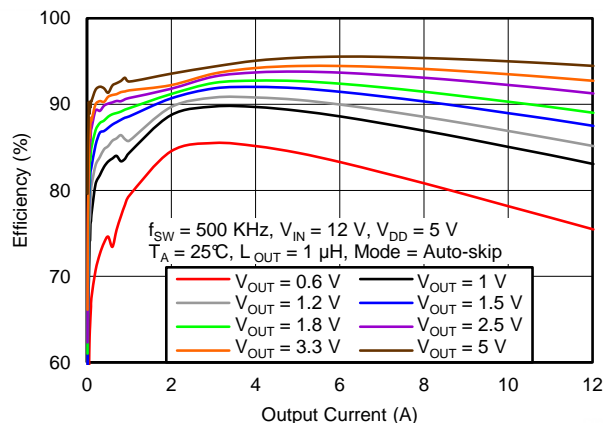

## Table of Contents

<b>1 Features</b> .....	<b>1</b>	7.4 Device Functional Modes.....	<b>22</b>
<b>2 Applications</b> .....	<b>1</b>	<b>8 Application and Implementation</b> .....	<b>23</b>
<b>3 Description</b> .....	<b>1</b>	8.1 Application Information.....	<b>23</b>
<b>4 Revision History</b> .....	<b>2</b>	8.2 Typical Application .....	<b>23</b>
<b>5 Pin Configuration and Functions</b> .....	<b>3</b>	<b>9 Power Supply Recommendations</b> .....	<b>28</b>
<b>6 Specifications</b> .....	<b>4</b>	<b>10 Layout</b> .....	<b>28</b>
6.1 Absolute Maximum Ratings .....	<b>4</b>	10.1 Layout Guidelines .....	<b>28</b>
6.2 ESD Ratings.....	<b>4</b>	10.2 Layout Example .....	<b>29</b>
6.3 Recommended Operating Conditions.....	<b>5</b>	10.3 Thermal Performance .....	<b>30</b>
6.4 Thermal Information .....	<b>5</b>	<b>11 Device and Documentation Support</b> .....	<b>31</b>
6.5 Electrical Characteristics.....	<b>6</b>	11.1 Documentation Support .....	<b>31</b>
6.6 Typical Characteristics.....	<b>8</b>	11.2 Community Resources.....	<b>31</b>
<b>7 Detailed Description</b> .....	<b>14</b>	11.3 Trademarks .....	<b>31</b>
7.1 Overview .....	<b>14</b>	11.4 Electrostatic Discharge Caution.....	<b>31</b>
7.2 Functional Block Diagram .....	<b>14</b>	11.5 Glossary .....	<b>31</b>
7.3 Feature Description.....	<b>15</b>	<b>12 Mechanical, Packaging, and Orderable Information</b> .....	<b>31</b>

## 4 Revision History

NOTE: Page numbers for previous revisions may differ from page numbers in the current version.

<b>Changes from Revision A (December 2013) to Revision B</b>	<b>Page</b>
<ul style="list-style-type: none"> <li>Added <i>Pin Configuration and Functions</i> section, <i>Handling Rating</i> table, <i>Feature Description</i> section, <i>Device Functional Modes</i>, <i>Application and Implementation</i> section, <i>Power Supply Recommendations</i> section, <i>Layout</i> section, <i>Device and Documentation Support</i> section, and <i>Mechanical, Packaging, and Orderable Information</i> section .....</li> </ul>	<b>1</b>

<b>Changes from Original (August 2013) to Revision A</b>	<b>Page</b>
<ul style="list-style-type: none"> <li>Added updates to front page graphics .....</li> </ul>	<b>1</b>
<ul style="list-style-type: none"> <li>Added updates to <i>Electrical Specifications</i> section .....</li> </ul>	<b>6</b>

## 5 Pin Configuration and Functions

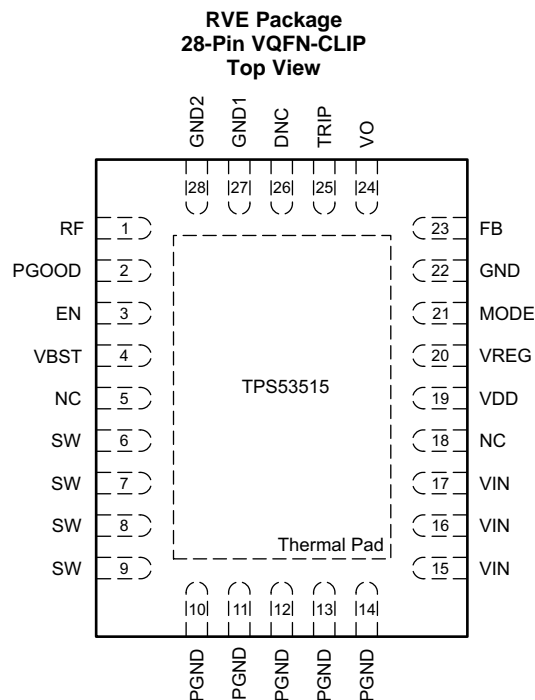

### Pin Functions

PIN		I/O <sup>(1)</sup>	DESCRIPTION
NAME	NO.		
DNC	26	O	Do not connect. This pin is the output of unused internal circuitry and must be floating.
EN	3	I	The enable pin turns on the DC-DC switching converter.
FB	23	I	$V_{OUT}$ feedback input. Connect this pin to a resistor divider between the VOUT pin and GND.
GND	22	G	This pin is the ground of internal analog circuitry and driver circuitry. Connect GND to the PGND plane with a short trace (For example, connect this pin to the thermal pad with a single trace and connect the thermal pad to PGND pins and PGND plane).
GND1	27	I	Connect this pin to ground. GND1 is the input of unused internal circuitry and must connect to ground.
GND2	28	I	Connect this pin to ground. GND2 is the input of unused internal circuitry and must connect to ground.
MODE	21	I	The MODE pin sets the forced continuous-conduction mode (FCCM) or Skip-mode operation. It also selects the ramp coefficient of D-CAP3 mode.
NC	5 18	—	Not connected. These pins are floating internally.
PGND	10 11 12 13 14	G	These ground pins are connected to the return of the internal low-side MOSFET.
PGOOD	2	O	Open-drain power-good status signal which provides startup delay after the FB voltage falls within the specified limits. After the FB voltage moves outside the specified limits, PGOOD goes low within 2 $\mu$ s.
RF	1	I	RF is the SW-frequency configuration pin. Connect this pin to a resistor divider between VREG and GND to program different SW frequency settings.

(1) I = Input, O = Output, P = Supply, G = Ground

**Pin Functions (continued)**

PIN		I/O <sup>(1)</sup>	DESCRIPTION
NAME	NO.		
SW	6	I/O	SW is the output switching terminal of the power converter. Connect this pin to the output inductor.
	7		
	8		
	9		
TRIP	25	I/O	TRIP is the OCL detection threshold setting pin. $I_{TRIP} = 10 \mu A$ at room temp, 3000 ppm/°C current is sourced and sets the OCL trip voltage. See the <a href="#">Current Sense and Overcurrent Protection</a> section for detailed OCP setting.
VBST	4	P	VBST is the supply rail for the high-side gate driver (boost terminal). Connect the bootstrap capacitor from this pin to the SW node. Internally connected to VREG via bootstrap PMOS switch.
VDD	19	P	Power-supply input pin for controller. Input of the VREG LDO. The input range is from 4.5 to 25 V.
VIN	15	P	VIN is the conversion power-supply input pins.
	16		
	17		
VREG	20	O	VREG is the 5-V LDO output. This voltage supplies the internal circuitry and gate driver.
VO	24	I	VO is the VOUT voltage input to the controller.

## 6 Specifications

### 6.1 Absolute Maximum Ratings<sup>(1)</sup>

over operating free-air temperature range (unless otherwise noted)

			MIN	MAX	UNIT
Input voltage range <sup>(2)</sup>	EN		-0.3	7.7	V
	SW	DC	-3	30	
		Transient < 10 ns	-5	32	
	VBST		-0.3	36	
	VBST <sup>(3)</sup>		-0.3	6	
	VBST when transient < 10 ns			38	
	VDD		-0.3	28	
	VIN		-0.3	30	
VO, FB, MODE, RF		-0.3	6		
Output voltage range	PGOOD		-0.3	7.7	V
	VREG, TRIP		-0.3	6	
Junction temperature, $T_J$			-40	150	°C
Storage temperature, $T_{stg}$			-55	150	°C

(1) Stresses beyond those listed under *Absolute Maximum Ratings* may cause permanent damage to the device. These are stress ratings only, which do not imply functional operation of the device at these or any other conditions beyond those indicated under [Recommended Operating Conditions](#). Exposure to absolute-maximum-rated conditions for extended periods may affect device reliability.

(2) All voltages are with respect to network ground terminal.

(3) Voltage values are with respect to the SW terminal.

### 6.2 ESD Ratings

			VALUE	UNIT
$V_{(ESD)}$	Electrostatic discharge	Human-body model (HBM), per ANSI/ESDA/JEDEC JS-001 <sup>(1)</sup>	±2500	V
		Charged-device model (CDM), per JEDEC specification JESD22-C101 <sup>(2)</sup>	±1500	

(1) JEDEC document JEP155 states that 500-V HBM allows safe manufacturing with a standard ESD control process.

(2) JEDEC document JEP157 states that 250-V CDM allows safe manufacturing with a standard ESD control process.

### 6.3 Recommended Operating Conditions

over operating free-air temperature range (unless otherwise noted)

		MIN	MAX	UNIT
Input voltage	EN	-0.1	7	V
	SW	-3	27	
	VBST	-0.1	28	
	VBST <sup>(1)</sup>	-0.1	5.5	
	VDD	4.5	25	
	VIN	1.5	18	
	VO, FB, MODE, RF	-0.1	5.5	
Output voltage	PGOOD	-0.1	7	V
	VREG, TRIP	-0.1	5.5	
Operating free-air temperature, T <sub>A</sub>		-40	85	°C

(1) Voltage values are with respect to the SW pin.

### 6.4 Thermal Information

THERMAL METRIC <sup>(1)</sup>		TPS53515		UNIT
		RVE (VQFN-CLIP)		
		28 PINS		
R <sub>θJA</sub>	Junction-to-ambient thermal resistance	37.5		°C/W
R <sub>θJC(top)</sub>	Junction-to-case (top) thermal resistance	34.1		°C/W
R <sub>θJB</sub>	Junction-to-board thermal resistance	18.1		°C/W
ψ <sub>JT</sub>	Junction-to-top characterization parameter	1.8		°C/W
ψ <sub>JB</sub>	Junction-to-board characterization parameter	18.1		°C/W
R <sub>θJC(bot)</sub>	Junction-to-case (bottom) thermal resistance	2.2		°C/W

(1) For more information about traditional and new thermal metrics, see the *Semiconductor and IC Package Thermal Metrics* application report, [SPRA953](#).

## 6.5 Electrical Characteristics

over operating free-air temperature range, VREG = 5 V, EN = 5 V (unless otherwise noted)

PARAMETER		TEST CONDITIONS	MIN	TYP	MAX	UNIT
<b>SUPPLY CURRENT</b>						
I <sub>VDD</sub>	VDD bias current	T <sub>A</sub> = 25°C, No load Power conversion enabled (no switching)		1350	1850	μA
I <sub>VDDSTBY</sub>	VDD standby current	T <sub>A</sub> = 25°C, No load Power conversion disabled		850	1150	μA
I <sub>VIN(leak)</sub>	VIN leakage current	V <sub>EN</sub> = 0 V			0.5	μA
<b>VREF OUTPUT</b>						
V <sub>VREF</sub>	Reference voltage	FB w/r/t GND, T <sub>A</sub> = 25°C	597	600	603	mV
V <sub>VREFTOL</sub>	Reference voltage tolerance	FB w/r/t GND, 0°C ≤ T <sub>J</sub> ≤ 85°C	-0.6%		0.5%	
		FB w/r/t GND, -40°C ≤ T <sub>J</sub> ≤ 85°C	-0.7%		0.5%	
<b>OUTPUT VOLTAGE</b>						
I <sub>FB</sub>	FB input current	V <sub>FB</sub> = 600 mV		50	100	nA
I <sub>VODIS</sub>	VO discharge current	V <sub>VO</sub> = 0.5 V, Power Conversion Disabled	10	12	15	mA
<b>SMPS FREQUENCY</b>						
f <sub>SW</sub>	VO switching frequency <sup>(1)</sup>	V <sub>IN</sub> = 12 V, V <sub>VO</sub> = 3.3 V, R <sub>DR</sub> < 0.041		250		kHz
		V <sub>IN</sub> = 12 V, V <sub>VO</sub> = 3.3 V, R <sub>DR</sub> = 0.096		300		
		V <sub>IN</sub> = 12 V, V <sub>VO</sub> = 3.3 V, R <sub>DR</sub> = 0.16		400		
		V <sub>IN</sub> = 12 V, V <sub>VO</sub> = 3.3 V, R <sub>DR</sub> = 0.229		500		
		V <sub>IN</sub> = 12 V, V <sub>VO</sub> = 3.3 V, R <sub>DR</sub> = 0.297		600		
		V <sub>IN</sub> = 12 V, V <sub>VO</sub> = 3.3 V, R <sub>DR</sub> = 0.375		750		
		V <sub>IN</sub> = 12 V, V <sub>VO</sub> = 3.3 V, R <sub>DR</sub> = 0.461		850		
		V <sub>IN</sub> = 12 V, V <sub>VO</sub> = 3.3 V, R <sub>DR</sub> > 0.557		1000		
t <sub>ON(min)</sub>	Minimum on-time	T <sub>A</sub> = 25°C <sup>(2)</sup>		60		ns
t <sub>OFF(min)</sub>	Minimum off-time	T <sub>A</sub> = 25°C	175	240	310	ns
<b>INTERNAL BOOTSTRAP SW</b>						
V <sub>F</sub>	Forward Voltage	V <sub>VREG-VBST</sub> , T <sub>A</sub> = 25°C, I <sub>F</sub> = 10 mA		0.15	0.25	V
I <sub>VBST</sub>	VBST leakage current	T <sub>A</sub> = 25°C, V <sub>VBST</sub> = 33 V, V <sub>SW</sub> = 28 V		0.01	1.5	μA
<b>LOGIC THRESHOLD</b>						
V <sub>ENH</sub>	EN enable threshold voltage		1.3	1.4	1.5	V
V <sub>ENL</sub>	EN disable threshold voltage		1.1	1.2	1.3	V
V <sub>ENHYST</sub>	EN hysteresis voltage			0.22		V
V <sub>ENLEAK</sub>	EN input leakage current		-1	0	1	μA
<b>SOFT START</b>						
t <sub>SS</sub>	Soft-start time			1		ms
<b>PGOOD COMPARATOR</b>						
V <sub>PGTH</sub>	VDDQ PGOOD threshold	PGOOD in from higher	104%	108%	111%	
		PGOOD in from lower	89%	92%	96%	
		PGOOD out to higher	113%	116%	120%	
		PGOOD out to lower	80%	84%	87%	
I <sub>PG</sub>	PGOOD sink current	V <sub>PGOOD</sub> = 0.5 V	4	6		mA
t <sub>PGDLY</sub>	PGOOD delay time	Delay for PGOOD going in	0.8	1.0	1.2	ms
		Delay for PGOOD coming out		2		μs
I <sub>PGLK</sub>	PGOOD leakage current	V <sub>PGOOD</sub> = 5 V	-1	0	1	μA

 (1) Resistor divider ratio (R<sub>DR</sub>) is described in [Equation 1](#).

(2) Specified by design. Not production tested.

**Electrical Characteristics (continued)**

over operating free-air temperature range, VREG = 5 V, EN = 5 V (unless otherwise noted)

PARAMETER		TEST CONDITIONS	MIN	TYP	MAX	UNIT
<b>CURRENT DETECTION</b>						
R <sub>TRIP</sub>	TRIP pin resistance range		20		70	kΩ
I <sub>OCL</sub>	Current limit threshold, valley	R <sub>TRIP</sub> = 52.3 kΩ	10.1	12	13.9	A
		R <sub>TRIP</sub> = 38 kΩ	7.2	9.1	11.0	
I <sub>OCLN</sub>	Negative current limit threshold, valley	R <sub>TRIP</sub> = 52.3 kΩ	-15.3	-11.9	-8.5	A
		R <sub>TRIP</sub> = 38 kΩ	-12	-9	-6	
V <sub>ZC</sub>	Zero cross detection offset			0		mV
<b>PROTECTIONS</b>						
V <sub>VREGUVLO</sub>	VREG undervoltage-lockout (UVLO) threshold voltage	Wake-up	3.25	3.34	3.41	V
		Shutdown	3.00	3.12	3.19	
V <sub>VDDUVLO</sub>	VDD UVLO threshold voltage	Wake-up (default)	4.15	4.25	4.35	V
		Shutdown	3.95	4.05	4.15	
V <sub>OVP</sub>	Overvoltage-protection (OVP) threshold voltage	OVP detect voltage	116%	120%	124%	
t <sub>OVPDLY</sub>	OVP propagation delay	With 100-mV overdrive		300		ns
V <sub>UVP</sub>	Undervoltage-protection (UVP) threshold voltage	UVP detect voltage	64%	68%	71%	
t <sub>UVPDLY</sub>	UVP delay	UVP filter delay		1		ms
<b>THERMAL SHUTDOWN</b>						
T <sub>SDN</sub>	Thermal shutdown threshold <sup>(2)</sup>	Shutdown temperature		140		°C
		Hysteresis		40		
<b>LDO VOLTAGE</b>						
V <sub>REG</sub>	LDO output voltage	V <sub>IN</sub> = 12 V, I <sub>LOAD</sub> = 10 mA	4.65	5	5.45	V
V <sub>DOVREG</sub>	LDO low droop drop-out voltage	V <sub>IN</sub> = 4.5 V, I <sub>LOAD</sub> = 30 mA, T <sub>A</sub> = 25°C			365	mV
I <sub>LDOMAX</sub>	LDO overcurrent limit	V <sub>IN</sub> = 12 V, T <sub>A</sub> = 25°C	170	200		mA
<b>INTERNAL MOSFETS</b>						
R <sub>DS(on)H</sub>	High-side MOSFET on-resistance	T <sub>A</sub> = 25°C		13.8	15.5	mΩ
R <sub>DS(on)L</sub>	Low-side MOSFET on-resistance	T <sub>A</sub> = 25°C		5.9	7.0	mΩ

## 6.6 Typical Characteristics

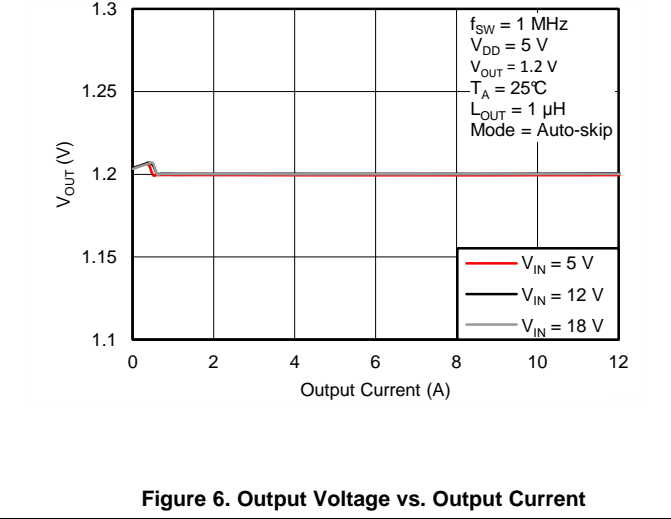
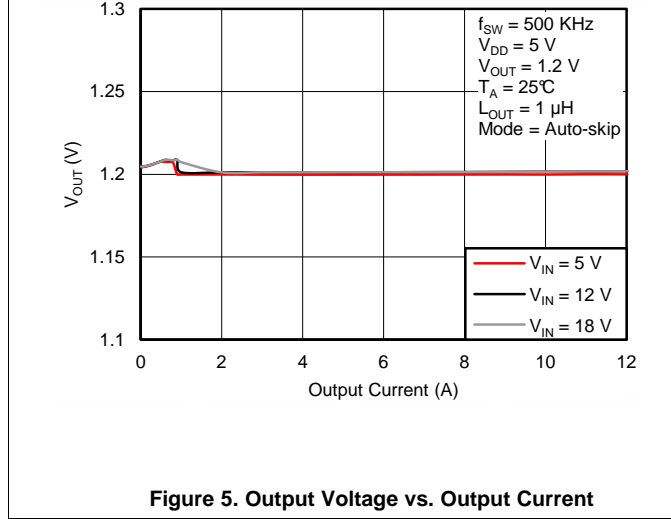
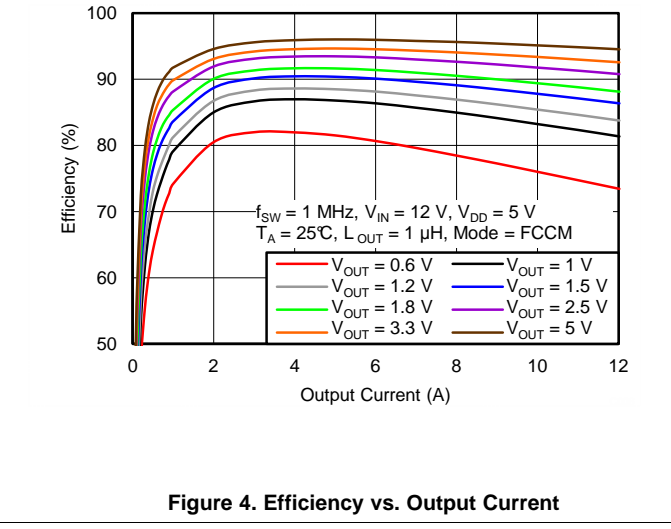
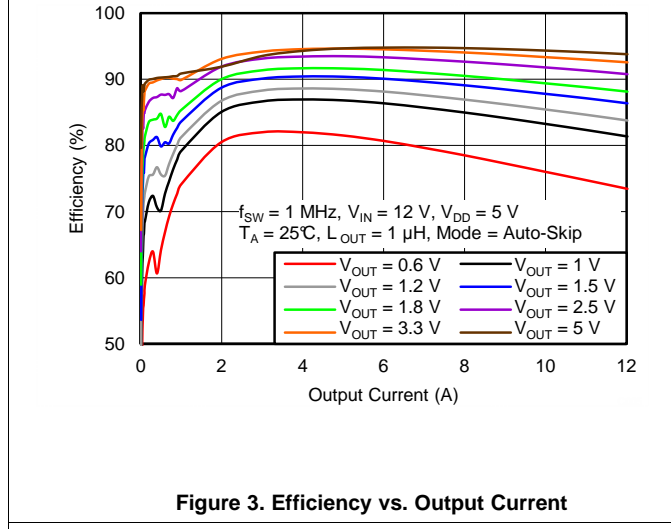
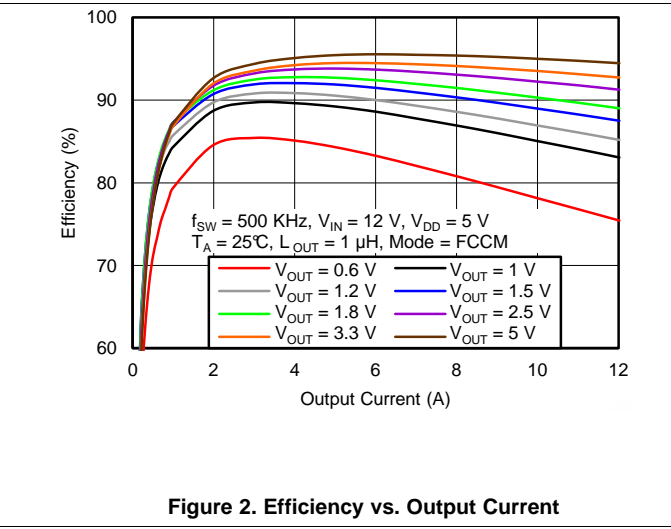
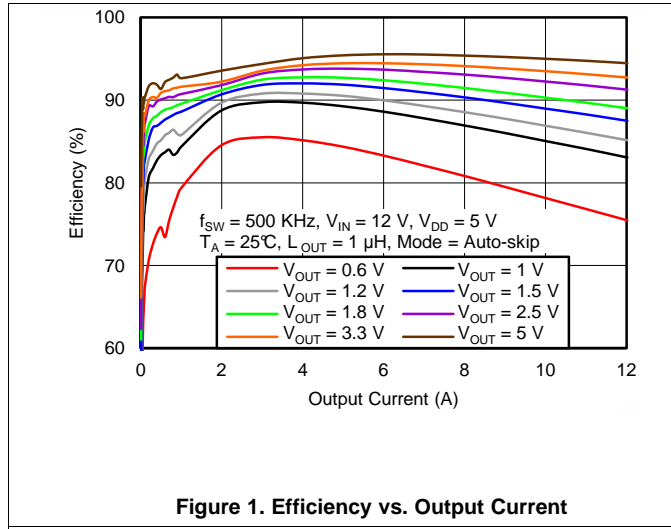



Typical Characteristics (continued)

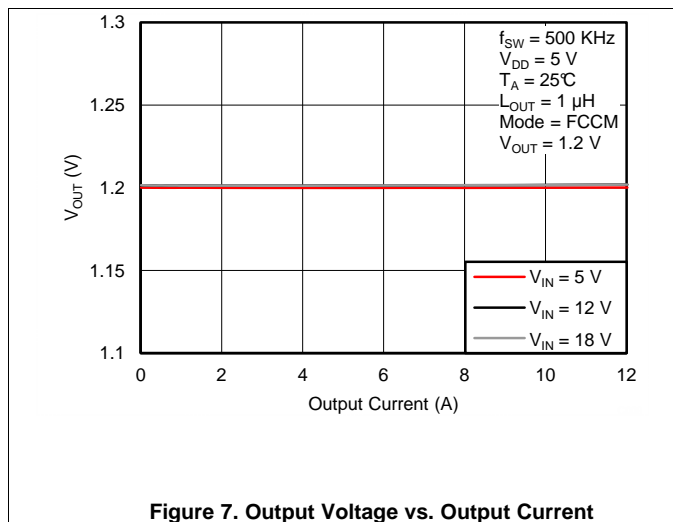

Figure 7. Output Voltage vs. Output Current

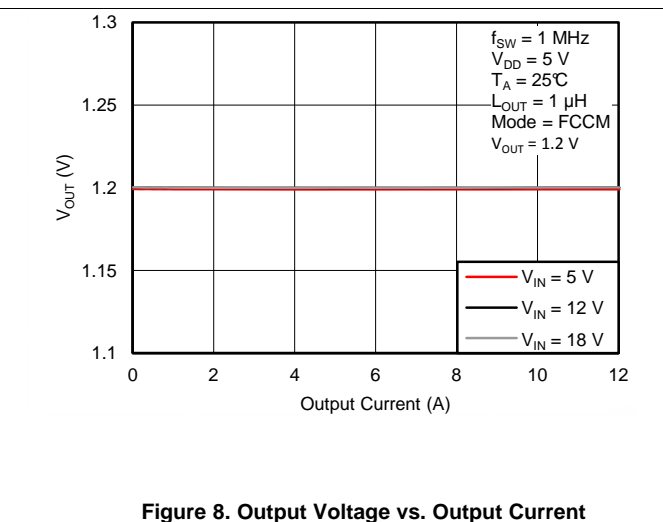

Figure 8. Output Voltage vs. Output Current

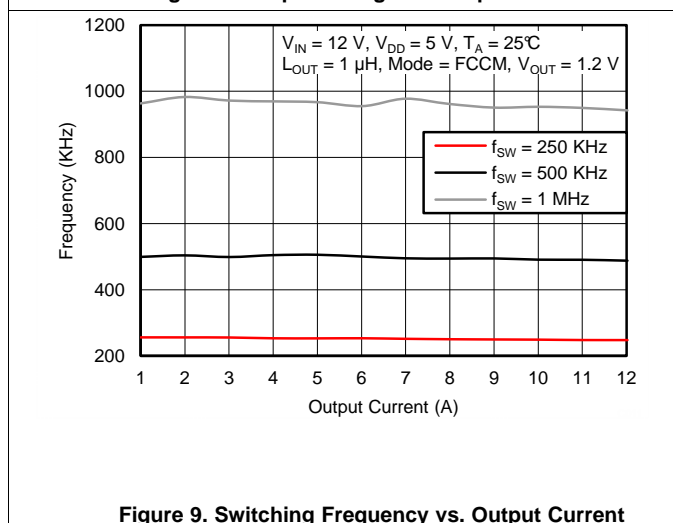

Figure 9. Switching Frequency vs. Output Current

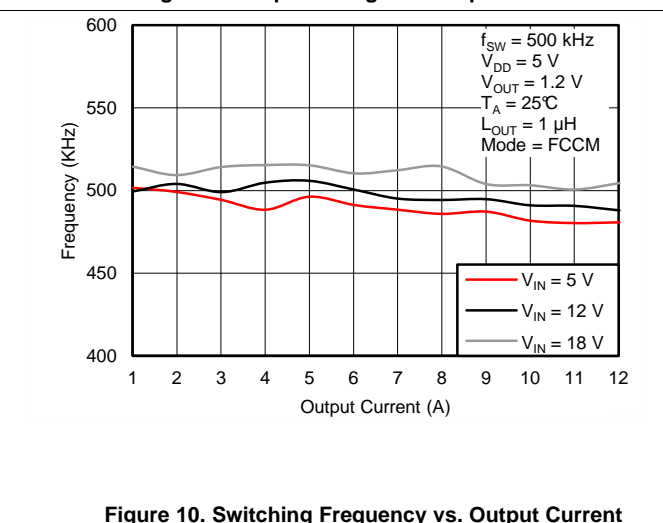

Figure 10. Switching Frequency vs. Output Current

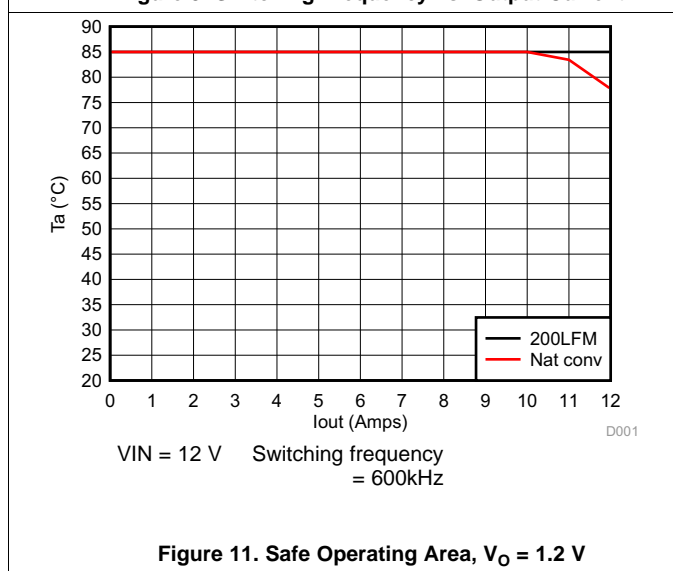

Figure 11. Safe Operating Area,  $V_0 = 1.2 V$

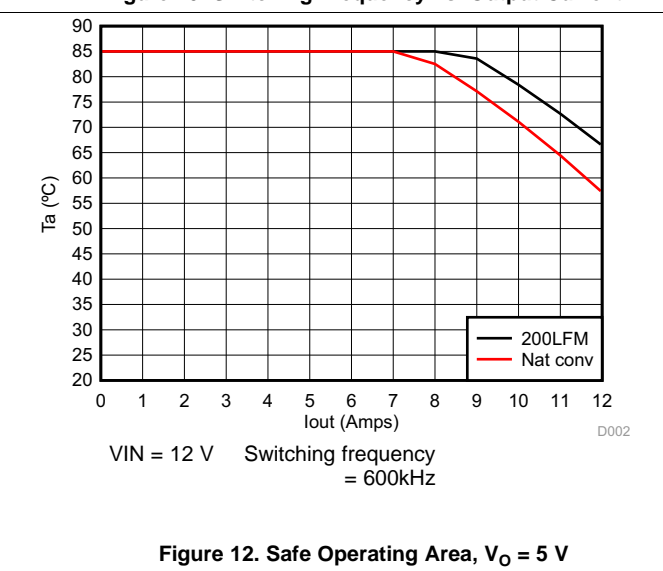

Figure 12. Safe Operating Area,  $V_0 = 5 V$

Typical Characteristics (continued)

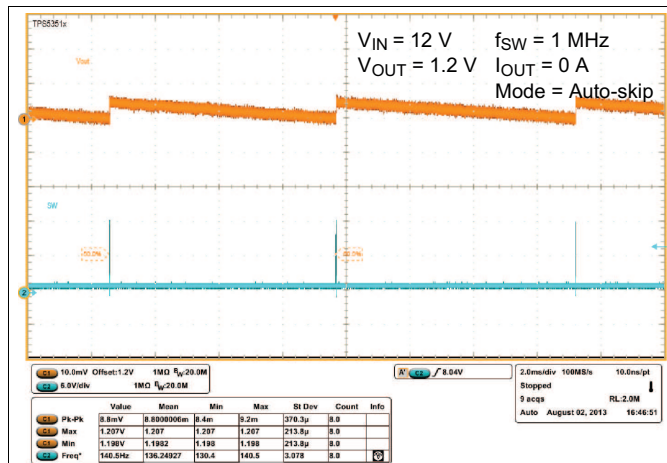

Figure 13. Auto-Skip Mode Steady-State Operation

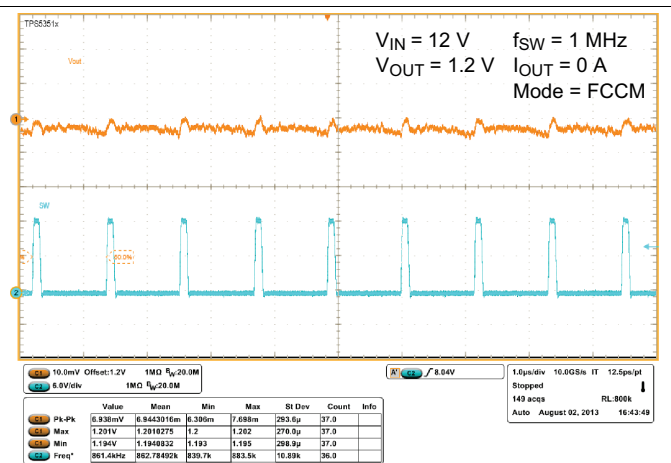

Figure 14. FCCM Steady-State Operation

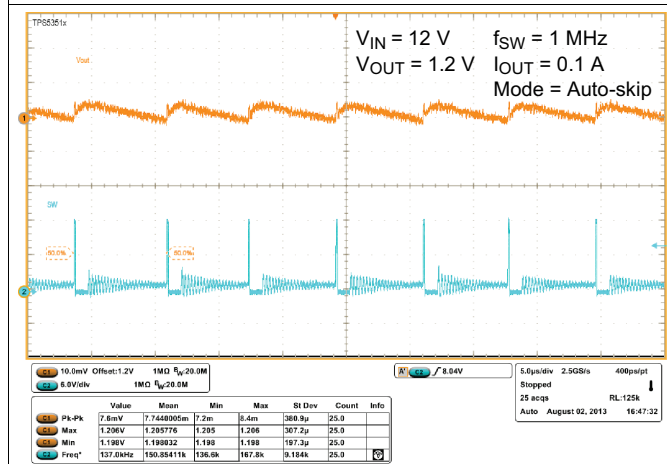

Figure 15. Auto-Skip Mode Steady-State Operation

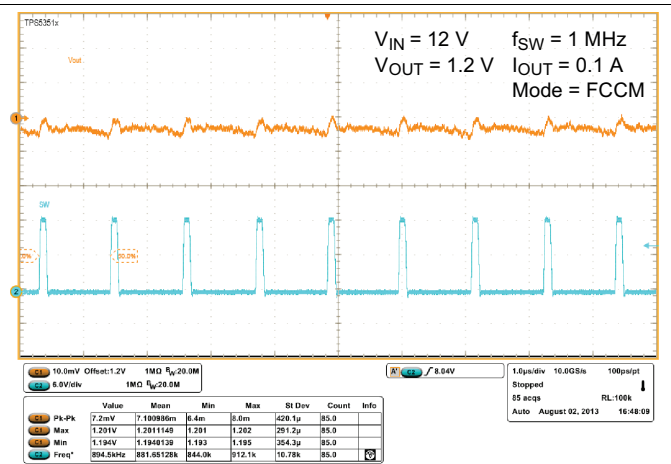

Figure 16. FCCM Steady-State Operation

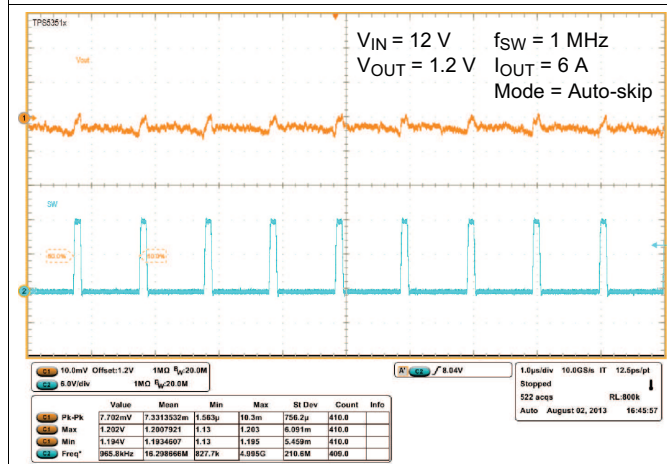

Figure 17. Auto-Skip Mode Steady-State Operation

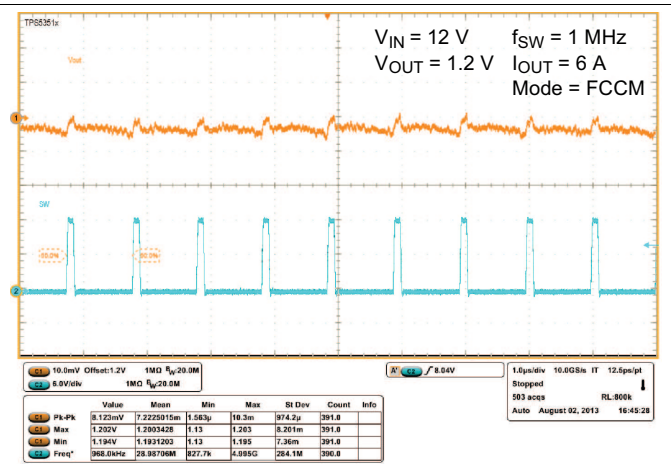

Figure 18. FCCM Steady-State Operation

Typical Characteristics (continued)

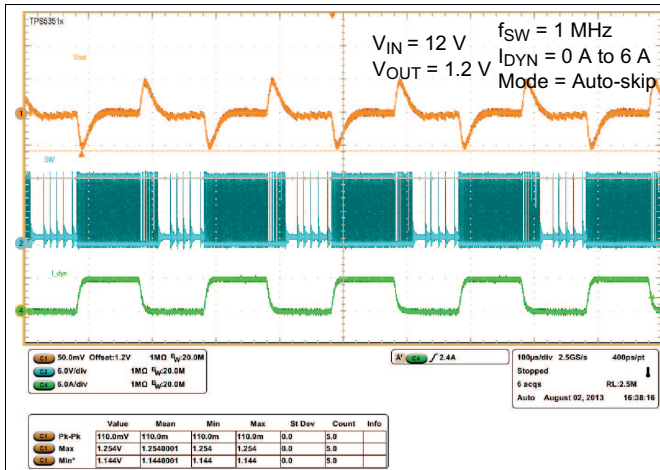

Figure 19. Auto-Skip Mode Load Transient

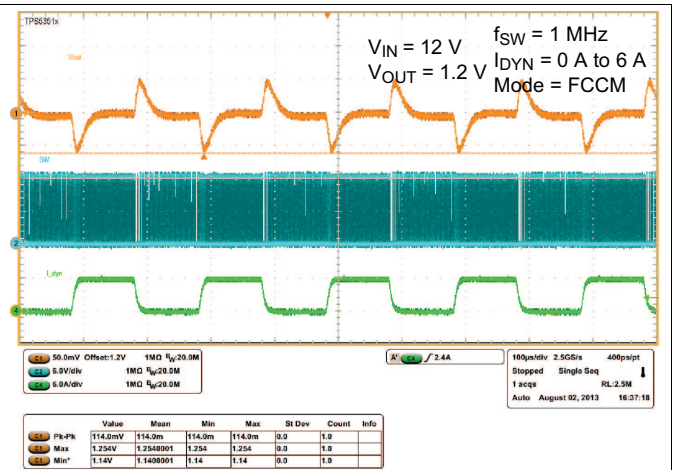

Figure 20. FCCM Load Transient



Figure 21. Auto-Skip Mode Start-Up

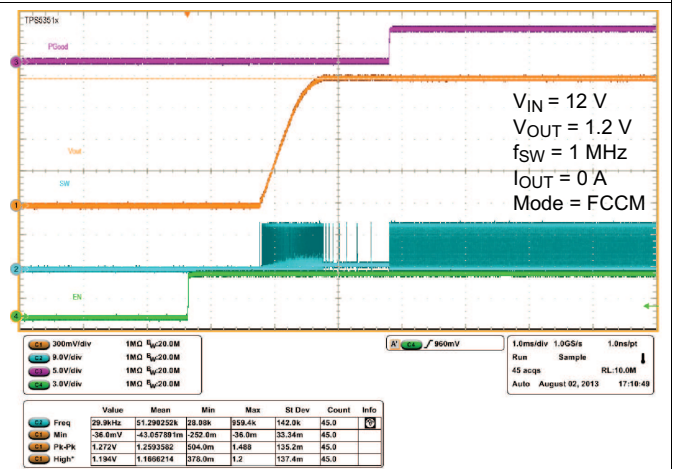

Figure 22. FCCM Start-Up

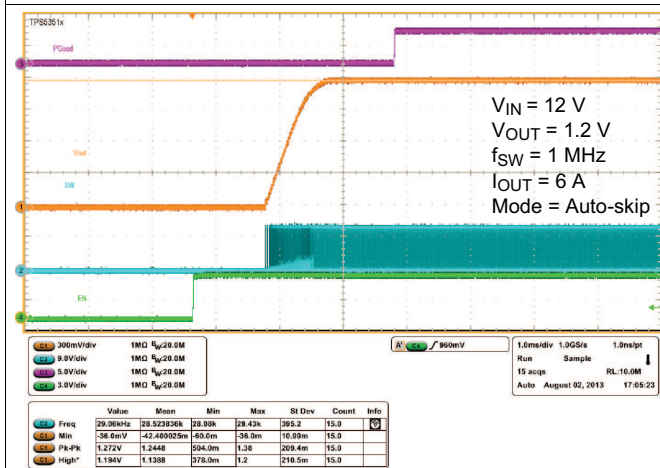

Figure 23. Auto-Skip Mode Start-Up

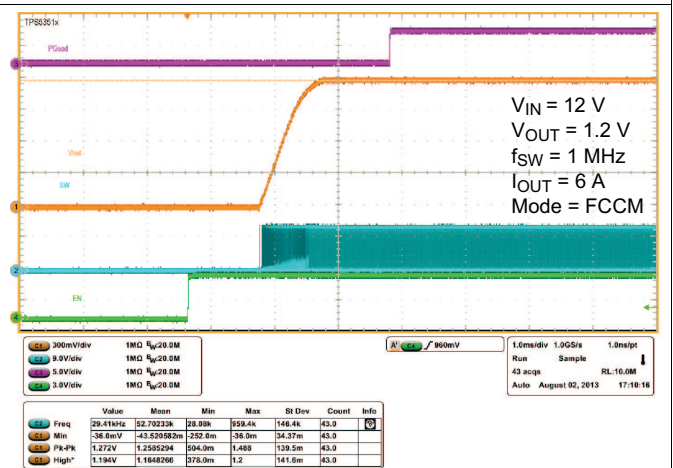

Figure 24. FCCM Start-Up

Typical Characteristics (continued)

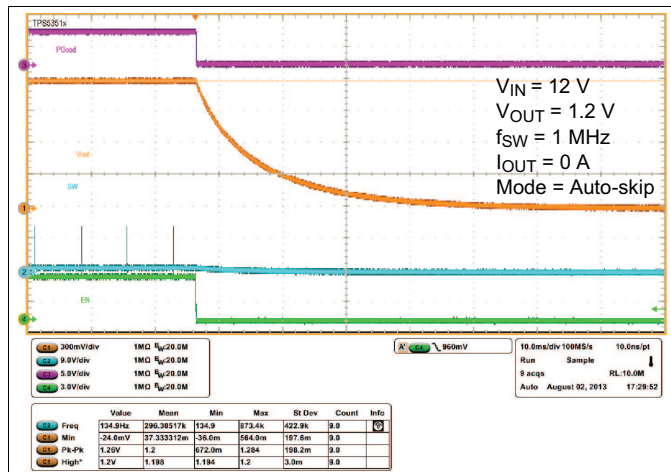

Figure 25. Auto-Skip Mode Shutdown Operation

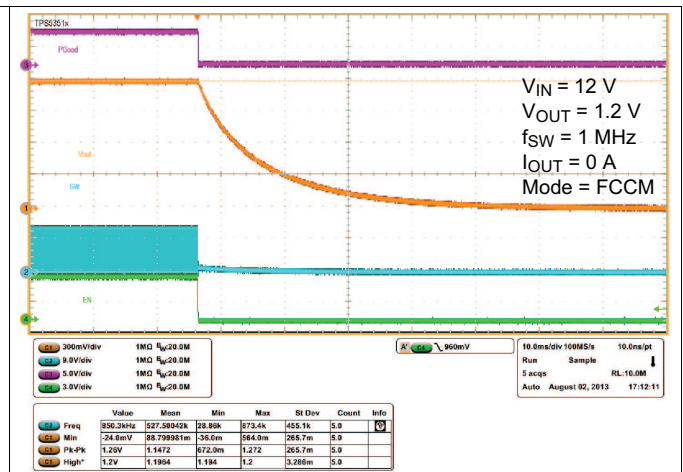

Figure 26. FCCM Shutdown Operation

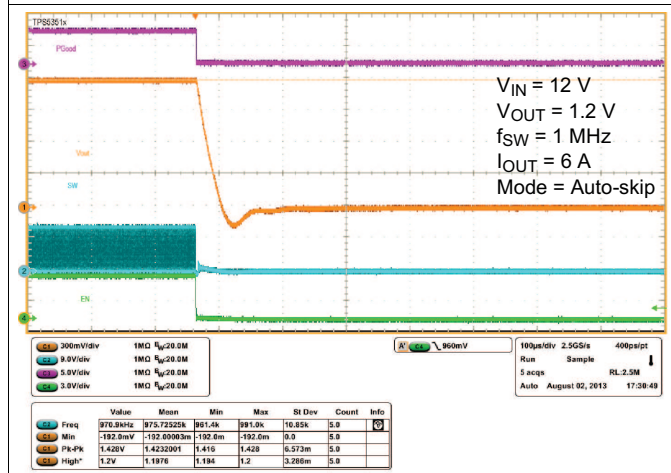

Figure 27. Auto-Skip Mode Shutdown Operation

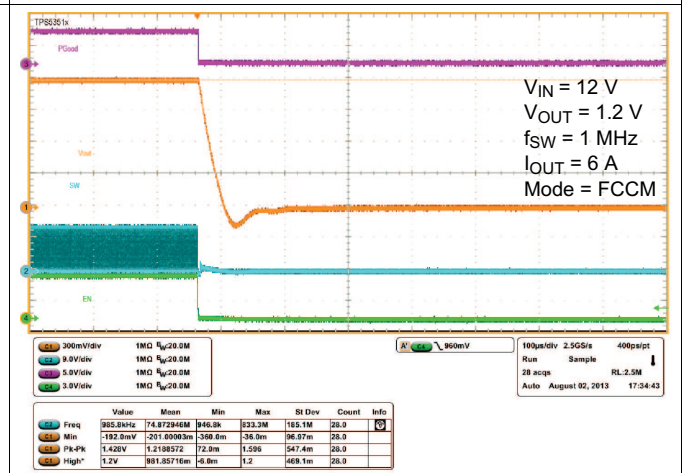

Figure 28. FCCM Shutdown Operation

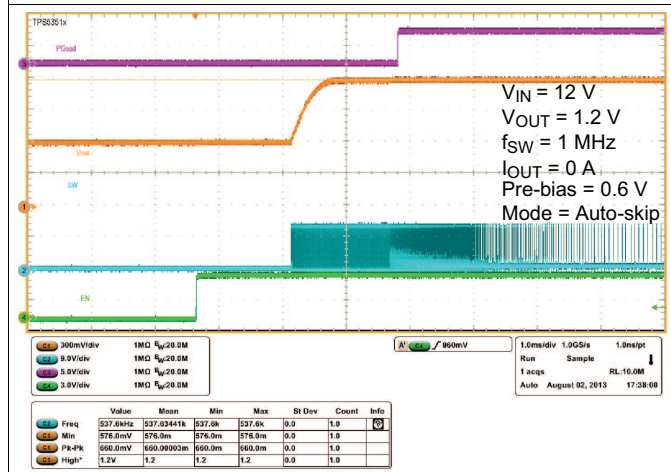

Figure 29. Prebias Operation

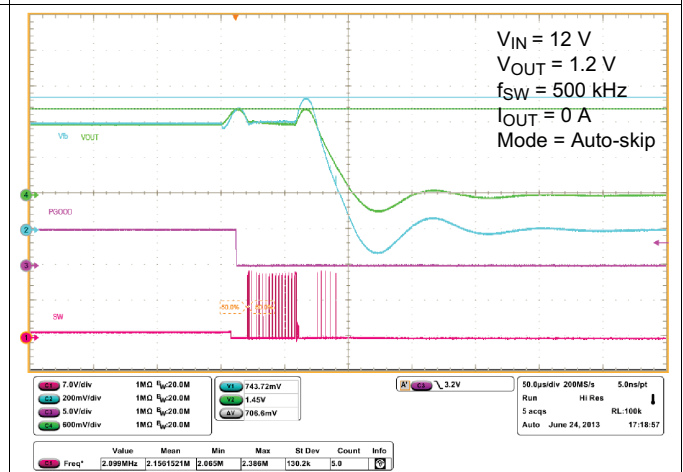
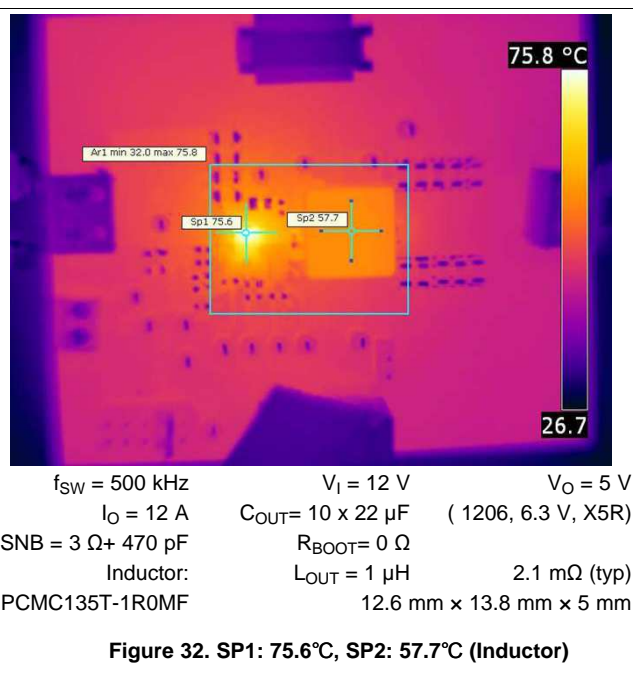
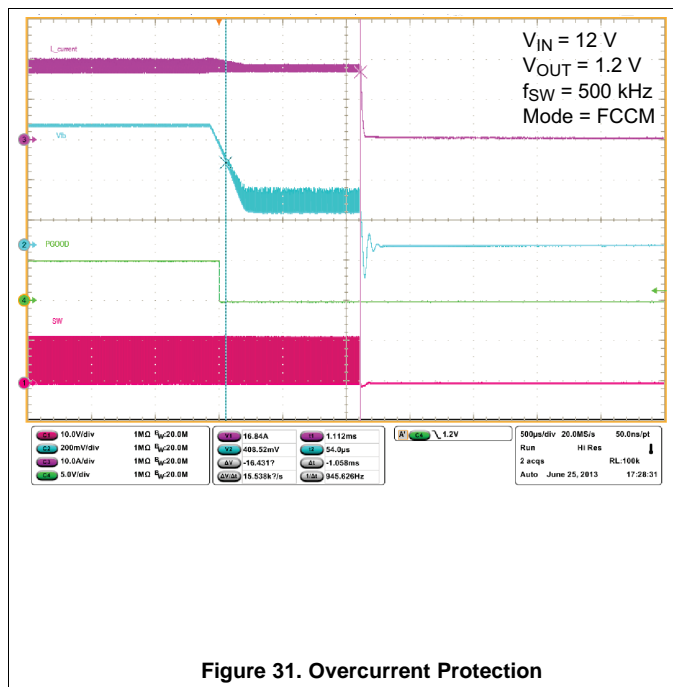

Figure 30. Overtoltage Protection

Typical Characteristics (continued)



## 7 Detailed Description

### 7.1 Overview

The TPS53515 device is a high-efficiency, single-channel, synchronous-buck converter. The device suits low-output voltage point-of-load applications with 12-A or lower output current in computing and similar digital consumer applications. The TPS53515 device features proprietary D-CAP3 mode control combined with adaptive on-time architecture. This combination builds modern low-duty-ratio and ultra-fast load-step-response DC-DC converters in an ideal fashion. The output voltage ranges from 0.6 V to 5.5 V. The conversion input voltage ranges from 1.5 V to 18 V and the VDD input voltage ranges from 4.5 V to 25 V. The D-CAP3 mode uses emulated current information to control the modulation. An advantage of this control scheme is that it does not require a phase-compensation network outside which makes the device easy-to-use and also allows low-external component count. Adaptive on-time control tracks the preset switching frequency over a wide range of input and output voltage while increasing switching frequency as needed during load-step transient.

### 7.2 Functional Block Diagram

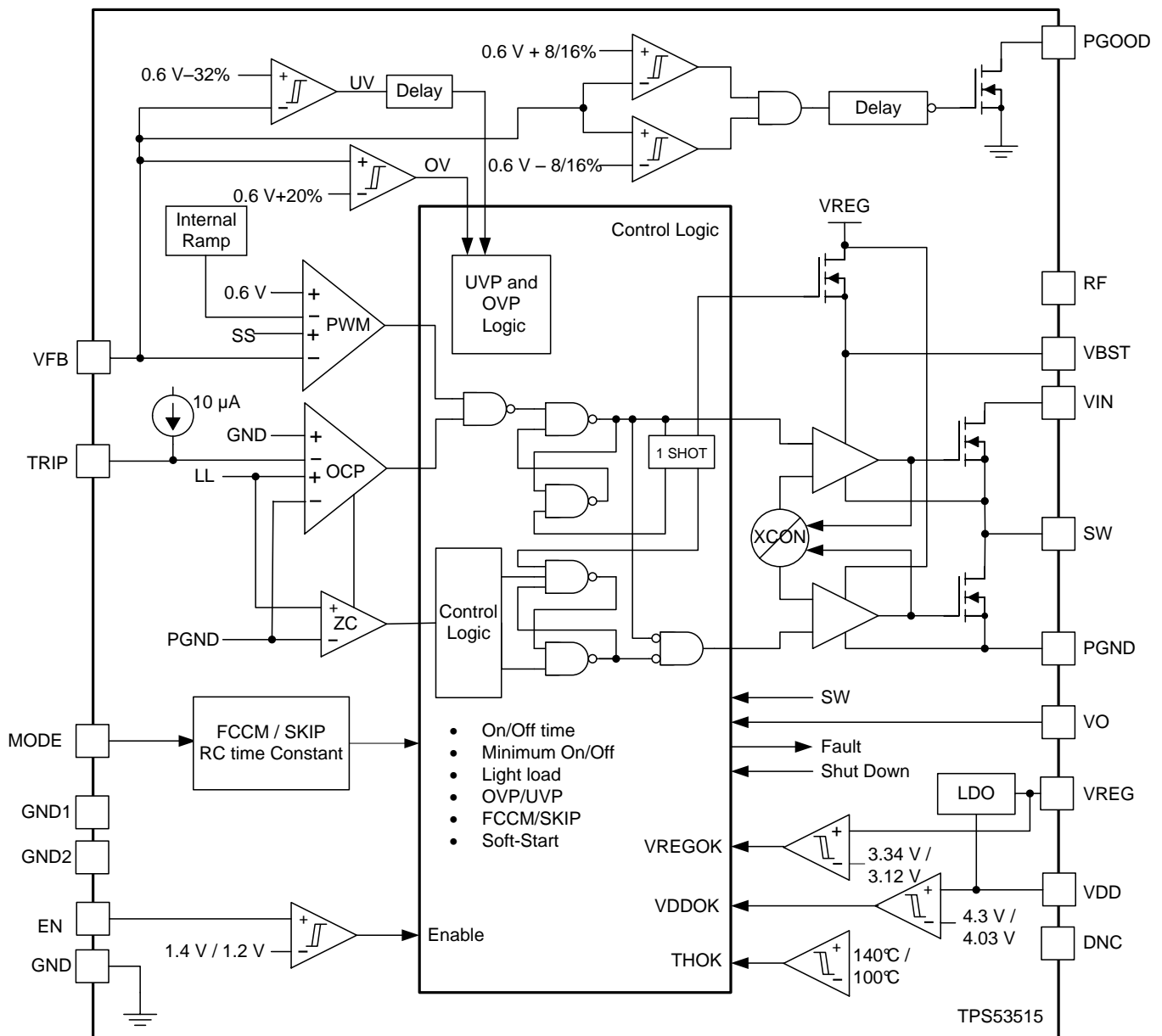

## 7.3 Feature Description

### 7.3.1 5-V LDO and VREG Start-Up

The TPS53515 device has an internal 5-V LDO feature using input from VDD and output to VREG. When the VDD voltage rises above 2.8 V, the internal LDO is enabled and outputs voltage to the VREG pin. The VREG voltage provides the bias voltage for the internal analog circuitry. The VREG voltage also provides the supply voltage for the gate drives.

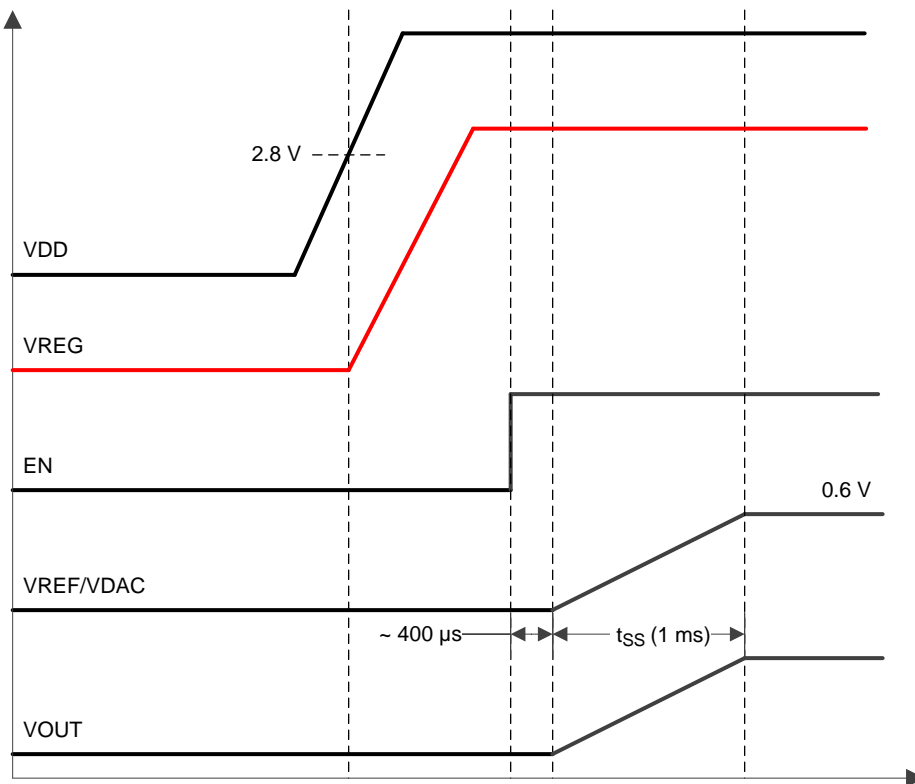

Figure 33. Power-up Sequence Waveforms

### 7.3.2 Enable, Soft Start, and Mode Selection

The internal LDO regulator starts immediately and regulates to 5 V at the VREG pin.

When the EN pin voltage rises above the enable threshold voltage (typically 1.4 V), the controller enters its start-up sequence. The controller then uses the first 400  $\mu$ s to calibrate the switching frequency setting resistance attached to the RF pin and stores the switching frequency code in internal registers. During this period, the MODE pin also senses the resistance attached to this pin to determine the operation mode. In the second phase, an internal DAC starts ramping up the reference voltage from 0 V to 0.6 V. the ramping up time is 1 ms. The device maintains smooth and constant ramp-up of the output voltage during start-up regardless of load current.

### 7.3.3 Frequency Selection

TPS53515 device lets users select the switching frequency by using the RF pin. Table 1 lists the divider ratio and some example resistor values for the switching frequency selection. The 1% tolerance resistors with a typical temperature coefficient of  $\pm 100$  ppm/ $^{\circ}$ C are recommended. If the design requires a tighter noise margin for more reliable SW-frequency detection, use higher performance resistors.

**Table 1. Switching Frequency Selection**

SWITCHING FREQUENCY ( $f_{sw}$ ) (kHz)	RESISTOR DIVIDER RATIO <sup>(1)</sup> ( $R_{DR}$ )	EXAMPLE RF FREQUENCY COMBINATIONS	
		$R_{RF\_H}$ (k $\Omega$ )	$R_{RF\_L}$ (k $\Omega$ )
1000	> 0.557	1	300
850	0.461	180	154
750	0.375	200	120
600	0.297	249	105
500	0.229	240	71.5
400	0.16	249	47.5
300	0.096	255	27
250	< 0.041	270	11.5

(1) Resistor divider ratio ( $R_{DR}$ ) is described in [Equation 1](#).

$$R_{DR} = \frac{R_{RF\_L}}{(R_{RF\_L} + R_{RF\_H})}$$

where

- $R_{RF\_L}$  is the low-side resistance of the RF pin resistor divider
- $R_{RF\_H}$  is the high-side resistance of the RF pin resistor divider

(1)

### 7.3.4 D-CAP3 Control and Mode Selection

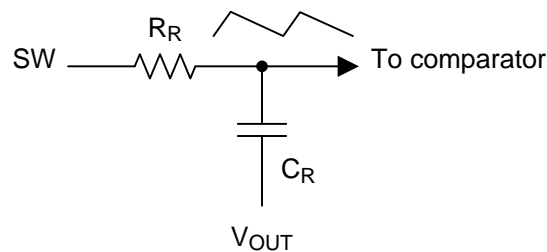

**Figure 34. Internal RAMP Generation Circuit**

The TPS53515 device uses D-CAP3 mode control to achieve fast load transient while maintaining the ease-of-use feature. An internal RAMP is generated and fed to the VFB pin to reduce jitter and maintain stability. The amplitude of the ramp is determined by the R-C time-constant as shown in [Figure 34](#). At different switching frequencies, ( $f_{sw}$ ) the R-C time-constant varies to maintain relatively constant RAMP amplitude.



7.3.4.1 D-CAP3 Mode

From small-signal loop analysis, a buck converter using the D-CAP3 mode control architecture can be simplified as shown in Figure 35.

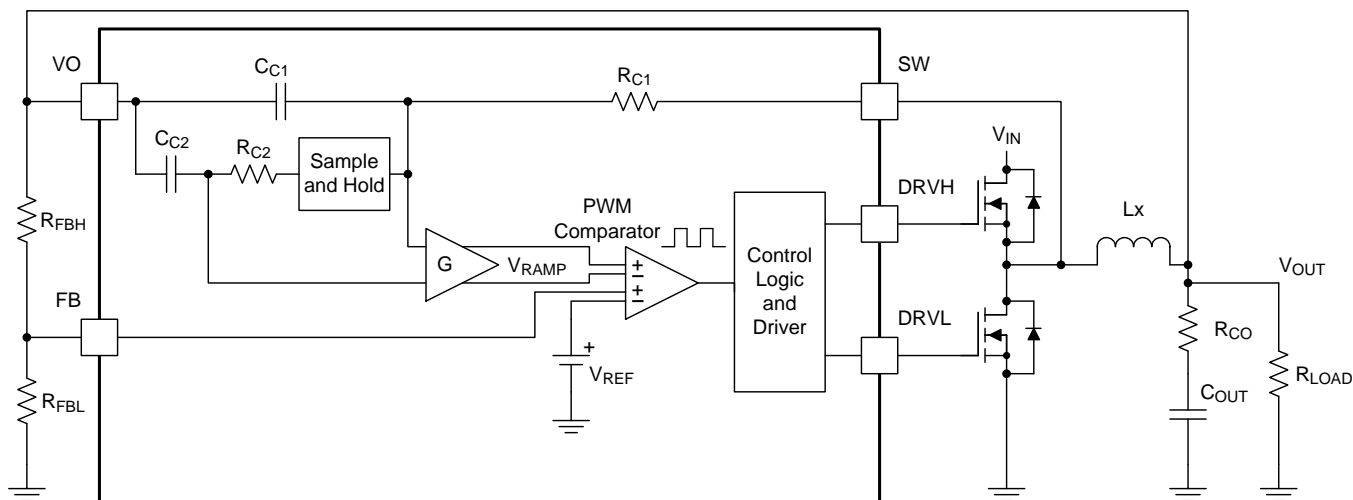

Figure 35. D-CAP3 Mode

The D-CAP3 control architecture includes an internal ripple generation network enabling the use of very low-ESR output capacitors such as multilayered ceramic capacitors (MLCC). No external current sensing network or voltage compensators are required with D-CAP3 control architecture. The role of the internal ripple generation network is to emulate the ripple component of the inductor current information and then combine it with the voltage feedback signal to regulate the loop operation. For any control topologies supporting no external compensation design, there is a minimum and/or maximum range of the output filter it can support. The output filter used with the TPS53515 device is a lowpass L-C circuit. This L-C filter has double pole that is described in Equation 2.

$$f_p = \frac{1}{2 \times \pi \times \sqrt{L_{OUT} \times C_{OUT}}} \tag{2}$$

At low frequencies, the overall loop gain is set by the output set-point resistor divider network and the internal gain of the TPS53515 device. The low frequency L-C double pole has a 180 degree in phase. At the output filter frequency, the gain rolls off at a -40dB per decade rate and the phase drops rapidly. The internal ripple generation network introduces a high-frequency zero that reduces the gain roll off from -40 dB to -20 dB per decade and increases the phase to 90 degree one decade above the zero frequency.

The inductor and capacitor selected for the output filter must be such that the double pole of Equation 2 is located close enough to the high-frequency zero so that the phase boost provided by the high-frequency zero provides adequate phase margin for the stability requirement.

Table 2. Locating the Zero

SWITCHING FREQUENCIES (f <sub>sw</sub> ) (kHz)	ZERO (f <sub>z</sub> ) LOCATION (kHz)
250 and 300	6
400 and 500	7
600 and 750	9
850 and 1000	12

After identifying the application requirements, the output inductance should be designed so that the inductor peak-to-peak ripple current is approximately between 25% and 35% of the  $I_{CC(max)}$  (peak current in the application). Use [Table 2](#) to help locate the internal zero based on the selected switching frequency. In general, where reasonable (or smaller) output capacitance is desired, [Equation 3](#) can be used to determine the necessary output capacitance for stable operation.

$$f_p = \frac{1}{2 \times \pi \times \sqrt{L_{OUT} \times C_{OUT}}} = f_z \quad (3)$$

If MLCC is used, consider the derating characteristics to determine the final output capacitance for the design. For example, when using an MLCC with specifications of 10- $\mu$ F, X5R and 6.3 V, the deratings by DC bias and AC bias are 80% and 50%, respectively. The effective derating is the product of these two factors, which in this case is 40% and 4- $\mu$ F. Consult with capacitor manufacturers for specific characteristics of the capacitors to be used in the system/applications.

[Table 3](#) shows the recommended output filter range for an application design with the following specifications:

- Input voltage,  $V_{IN} = 12$  V
- Switching frequency,  $f_{SW} = 600$  kHz
- Output current,  $I_{OUT} = 8$  A

The minimum output capacitance is verified by the small-signal measurement conducted on the EVM using the following two criteria:

- Loop crossover frequency is less than one-half the switching frequency (300 kHz)
- Phase margin at the loop crossover is greater than 50 degrees

For the maximum output capacitance recommendation, simplify the procedure to adopt an unrealistically high output capacitance for this type of converter design, then verify the small-signal response on the EVM using the following one criteria:

- Phase margin at the loop crossover is greater than 50 degrees

As indicated by the phase margin, the actual maximum output capacitance ( $C_{OUT(max)}$ ) can continue to go higher. However, small-signal measurement (bode plot) should be done to confirm the design.

Select a MODE pin configuration as shown in [Table 4](#) to in double the R-C time-constant option for the maximum output capacitance design and application. Select a MODE pin configuration to use single R-C time constant option for the normal (or smaller) output capacitance design and application.

The MODE pin also selects skip-mode or FCCM-mode operation.

**Table 3. Recommended Component Values**

$V_{OUT}$ (V)	$R_{LOWER}$ (k $\Omega$ )	$R_{UPPER}$ (k $\Omega$ )	$L_{OUT}$ ( $\mu$ H)	$C_{OUT(min)}$ ( $\mu$ F) <sup>(1)</sup>	CROSS-OVER (kHz)	PHASE MARGIN (°)	$C_{OUT(max)}$ ( $\mu$ F) <sup>(1)</sup>	INTERNAL RC SETTING ( $\mu$ s)	INDUCTOR $\Delta I/I_{CC(max)}$	$I_{CC(max)}$ (A)
0.6	10	0	0.36 PIMB065T-R36MS	3 x 100	247	70		40	33%	8
					48	62	30 x 100	80		
1.2		10	0.68 PIMB065T-R68MS	9 x 22	207	53		40	33%	
					25	84	30 x 100	80		
2.5		31.6	1.2 PIMB065T-1R2MS	4 x 22	185	57		40	34%	
					11	63	30 x 100	80		
3.3		45.3	1.5 PIMB065T-1R5MS	3 x 22	185	57		40	33%	
					9	59	30 x 100	80		
5.5		82.5	2.2 PIMB065T-2R2MS	2 x 22	185	51		40	28%	
					7	58	30 x 100	80		

(1) All  $C_{OUT(min)}$  and  $C_{OUT(max)}$  capacitor specifications are 1206, X5R, 10 V.

For higher output voltage at or above 2.0 V, additional phase boost might be required to secure sufficient phase margin due to phase delay/loss for higher output voltage (large on-time ( $t_{ON}$ )) setting in a fixed on time topology based operation.

A feedforward capacitor placing in parallel with  $R_{UPPER}$  is found to be very effective to boost the phase margin at loop crossover. Refer to TI application note [SLVA289](#) for details.

**Table 4. Mode Selection and Internal RAMP R-C Time Constant**

MODE SELECTION	ACTION	$R_{MODE}$ (k $\Omega$ )	R-C TIME CONSTANT ( $\mu$ s)	SWITCHING FREQUENCIES $f_{sw}$ (kHz)
Skip Mode	Pull down to GND	0	60	250 and 300
			50	400 and 500
			40	600 and 750
			30	850 and 1000
		150	120	250 and 300
			100	400 and 500
			80	600 and 750
			60	850 and 1000
FCCM <sup>(1)</sup>	Connect to PGOOD	20	60	250 and 300
			50	400 and 500
			40	600 and 750
			30	850 and 1000
		150	120	250 and 300
			100	400 and 500
			80	600 and 750
			60	850 and 1000
FCCM	Connect to VREG	0	120	250 and 300
			100	400 and 500
			80	600 and 750
			60	850 and 1000

(1) Device goes into Forced CCM (FCCM) after PGOOD becomes high.

**7.3.4.2 Sample and Hold Circuitry**

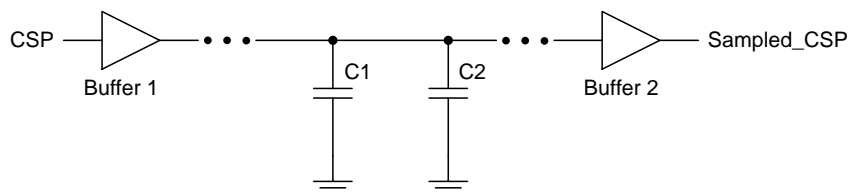

**Figure 36. Sample and Hold Logic Circuitry**

The sample and hold circuitry is the difference between D-CAP3 and D-CAP2. The sample and hold circuitry, which is an advance control scheme to boost output voltage accuracy higher on the device, is one of features of the device. The sample and hold circuitry generates a new DC voltage of CSN instead of the voltage which is produced by  $R_{C2}$  and  $C_{C2}$  which allows for tight output-voltage accuracy and makes the device more competitive.

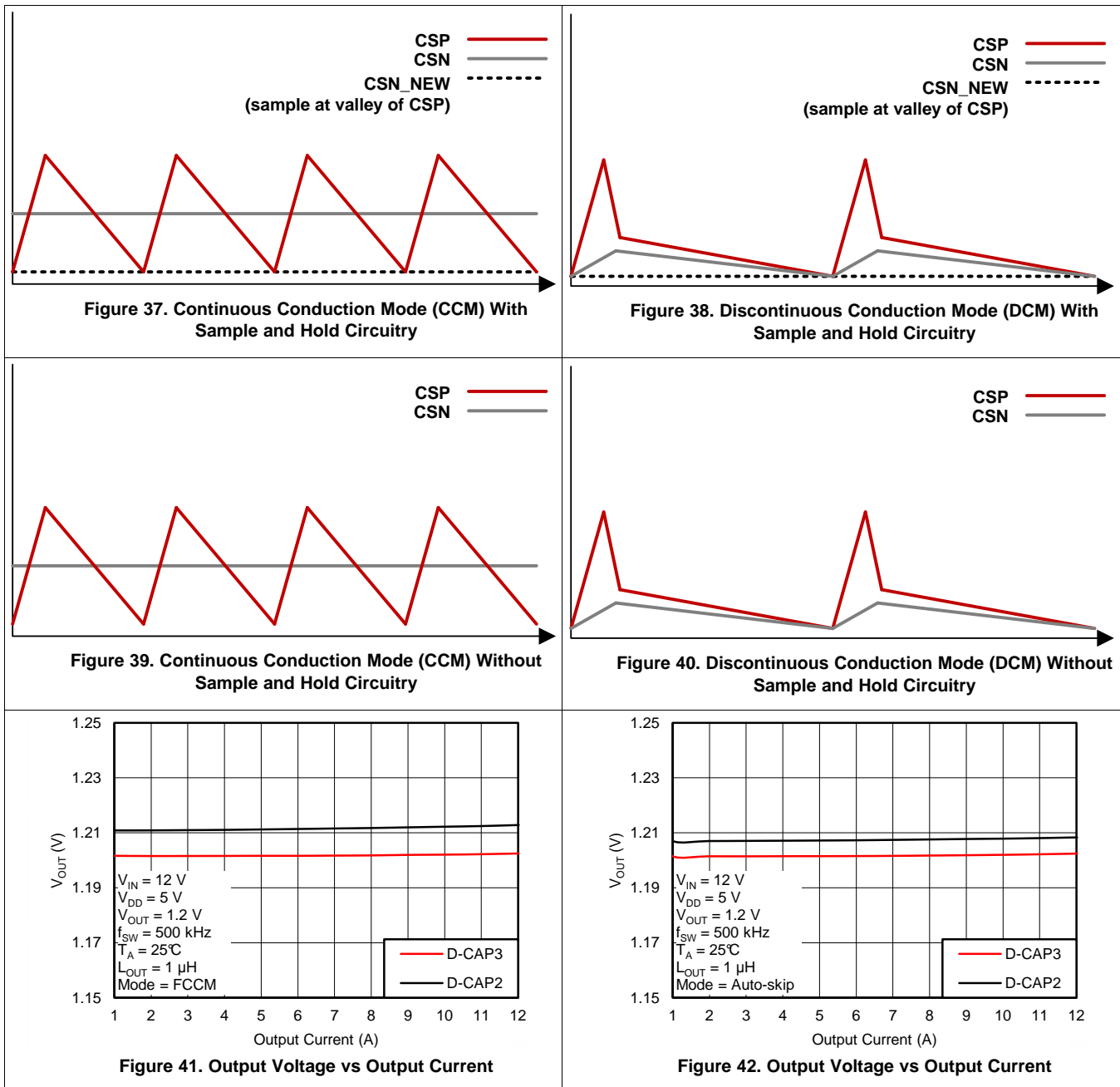

### 7.3.4.3 Adaptive Zero-Crossing

The TPS53515 device uses an adaptive zero-crossing circuit to perform optimization of the zero inductor-current detection during skip-mode operation. This function allows ideal low-side MOSFET turn-off timing. The function also compensates the inherent offset voltage of the Z-C comparator and delay time of the Z-C detection circuit. Adaptive zero-crossing prevents SW-node swing-up caused by too-late detection and minimizes diode conduction period caused by too-early detection. As a result, the device delivers better light-load efficiency.

### 7.3.5 Power-Good

The TPS53515 device has power-good output that indicates high when switcher output is within the target. The power-good function is activated after the soft-start operation is complete. If the output voltage becomes within  $\pm 8\%$  of the target value, internal comparators detect the power-good state and the power-good signal becomes high after a 1-ms internal delay. If the output voltage goes outside of  $\pm 16\%$  of the target value, the power-good signal becomes low after a 2- $\mu$ s internal delay. The power-good output is an open-drain output and must be pulled-up externally.

### 7.3.6 Current Sense and Overcurrent Protection

The TPS53515 device has cycle-by-cycle overcurrent limiting control. The inductor current is monitored during the OFF state and the controller maintains the OFF state during the period that the inductor current is larger than the overcurrent trip level. To provide good accuracy and a cost-effective solution, the TPS53515 device supports temperature compensated MOSFET  $R_{DS(on)}$  sensing. Connect the TRIP pin to GND through the trip-voltage setting resistor,  $R_{TRIP}$ . The TRIP pin sources  $I_{TRIP}$  current, which is 10  $\mu$ A typically at room temperature, and the trip level is set to the OCL trip voltage  $V_{TRIP}$  as shown in [Equation 4](#).

$$V_{TRIP} = R_{TRIP} \times I_{TRIP}$$

where

- $V_{TRIP}$  is in mV
  - $R_{TRIP}$  is in k $\Omega$
  - $I_{TRIP}$  is in  $\mu$ A
- (4)

The inductor current is monitored by the voltage between the GND pin and SW pin so that the SW pin is properly connected to the drain pin of the low-side MOSFET.  $I_{TRIP}$  has a 3000-ppm/ $^{\circ}$ C temperature slope to compensate the temperature dependency of  $R_{DS(on)}$ . The GND pin acts as the positive current-sensing node. Connect the GND pin to the proper current sensing device, (for example, the source pin of the low-side MOSFET.)

Because the comparison occurs during the OFF state,  $V_{TRIP}$  sets the valley level of the inductor current. Thus, the load current at the overcurrent threshold,  $I_{OCP}$ , is calculated as shown in [Equation 5](#).

$$I_{OCP} = \frac{V_{TRIP}}{(8 \times R_{DS(on)})} + \frac{I_{IND(ripple)}}{2} = \frac{V_{TRIP}}{(8 \times R_{DS(on)L})} + \frac{1}{2 \times L \times f_{SW}} \times \frac{(V_{IN} - V_{OUT}) \times V_{OUT}}{V_{IN}}$$

where

- $R_{DS(on)L}$  is the on-resistance of the low-side MOSFET
  - $R_{TRIP}$  is in k $\Omega$
- (5)

[Equation 5](#) calculates the typical DC OCP level (typical low-side on-resistance [ $R_{DS(on)}$ ] of 5.9 m $\Omega$  should be used); to design for worst case minimum OCP, maximum low-side on-resistance value of 8 m $\Omega$  should be used.

During an overcurrent condition, the current to the load exceeds the current to the output capacitor thus the output voltage tends to decrease. Eventually, the output voltage crosses the undervoltage-protection threshold and shuts down.

For the TPS53515 device, the overcurrent protection maximum is recommended up to 14 A only.

### 7.3.7 Overvoltage and Undervoltage Protection

The TPS53515 device monitors a resistor-divided feedback voltage to detect overvoltage and undervoltage. When the feedback voltage becomes lower than 68% of the target voltage, the UVP comparator output goes high and an internal UVP delay counter begins counting. After 1 ms, the TPS53515 device latches OFF both high-side and low-side MOSFETs drivers. The UVP function enables after soft-start is complete.

When the feedback voltage becomes higher than 120% of the target voltage, the OVP comparator output goes high and the circuit latches OFF the high-side MOSFET driver and turns on the low-side MOSFET until reaching a negative current limit. Upon reaching the negative current limit, the low-side FET is turned off and the high-side FET is turned on again for a minimum on-time. The TPS53515 device operates in this cycle until the output voltage is pulled down under the UVP threshold voltage for 1 ms. After the 1-ms UVP delay time, the high-side FET is latched off and low-side FET is latched on. The fault is cleared with a reset of VDD or by retoggling the EN pin.

### 7.3.8 Out-of-Bounds Operation

The device has an out-of-bounds (OOB) overvoltage protection that protects the output load at a much lower overvoltage threshold of 8% above the target voltage. OOB protection does not trigger an overvoltage fault, so the device is not latched off after an OOB event. OOB protection operates as an early no-fault overvoltage-protection mechanism. During the OOB operation, the controller operates in forced PWM mode only by turning on the low-side FET. Turning on the low-side FET beyond the zero inductor current quickly discharges the output capacitor thus causing the output voltage to fall quickly toward the setpoint. During the operation, the cycle-by-cycle negative current limit is also activated to ensure the safe operation of the internal FETs.

### 7.3.9 UVLO Protection

The TPS53515 device monitors the voltage on the VDD pin. If the VDD pin voltage is lower than the UVLO off-threshold voltage, the switch mode power supply shuts off. If the VDD voltage increases beyond the UVLO on-threshold voltage, the controller turns back on. UVLO is a nonlatch protection.

### 7.3.10 Thermal Shutdown

The TPS53515 device monitors internal temperature. If the temperature exceeds the threshold value (typically 140°C), TPS53515 device shuts off. When the temperature falls approximately 40°C below the threshold value, the device turns on. Thermal shutdown is a nonlatch protection.

## 7.4 Device Functional Modes

### 7.4.1 Auto-Skip Eco-mode Light Load Operation

While the MODE pin is pulled to GND directly or through 150-kΩ resistor, the TPS53515 device automatically reduces the switching frequency at light-load conditions to maintain high efficiency. This section describes the operation in detail.

As the output current decreases from heavy load condition, the inductor current also decreases until the rippled valley of the inductor current touches zero level. Zero level is the boundary between the continuous-conduction and discontinuous-conduction modes. The synchronous MOSFET turns off when this zero inductor current is detected. As the load current decreases further, the converter runs into discontinuous-conduction mode (DCM). The on-time is maintained to a level approximately the same as during continuous-conduction mode operation so that discharging the output capacitor with a smaller load current to the level of the reference voltage requires more time. The transition point to the light-load operation  $I_{O(LL)}$  (for example: the threshold between continuous- and discontinuous-conduction mode) is calculated as shown in [Equation 6](#).

$$I_{OUT(LL)} = \frac{1}{2 \times L \times f_{SW}} \times \frac{(V_{IN} - V_{OUT}) \times V_{OUT}}{V_{IN}}$$

where

- $f_{SW}$  is the PWM switching frequency (6)

Using only ceramic capacitors is recommended for Auto-skip mode.

### 7.4.2 Forced Continuous-Conduction Mode

When the MODE pin is tied to the PGOOD pin through a resistor, the controller operates in continuous conduction mode (CCM) during light-load conditions. During CCM, the switching frequency maintained to an almost constant level over the entire load range which is suitable for applications requiring tight control of the switching frequency at the cost of lower efficiency.

## 8 Application and Implementation

### NOTE

Information in the following applications sections is not part of the TI component specification, and TI does not warrant its accuracy or completeness. TI's customers are responsible for determining suitability of components for their purposes. Customers should validate and test their design implementation to confirm system functionality.

### 8.1 Application Information

The TPS53515 device is a high-efficiency, single-channel, synchronous-buck converter. The device suits low-output voltage point-of-load applications with 12-A or lower output current in computing and similar digital consumer applications.

### 8.2 Typical Application

This design example describes a D-CAP3-mode, 8-A synchronous buck converter with integrated MOSFETs. The device provides a fixed 1.2-V output at up to 8 A from a 12-V input bus.

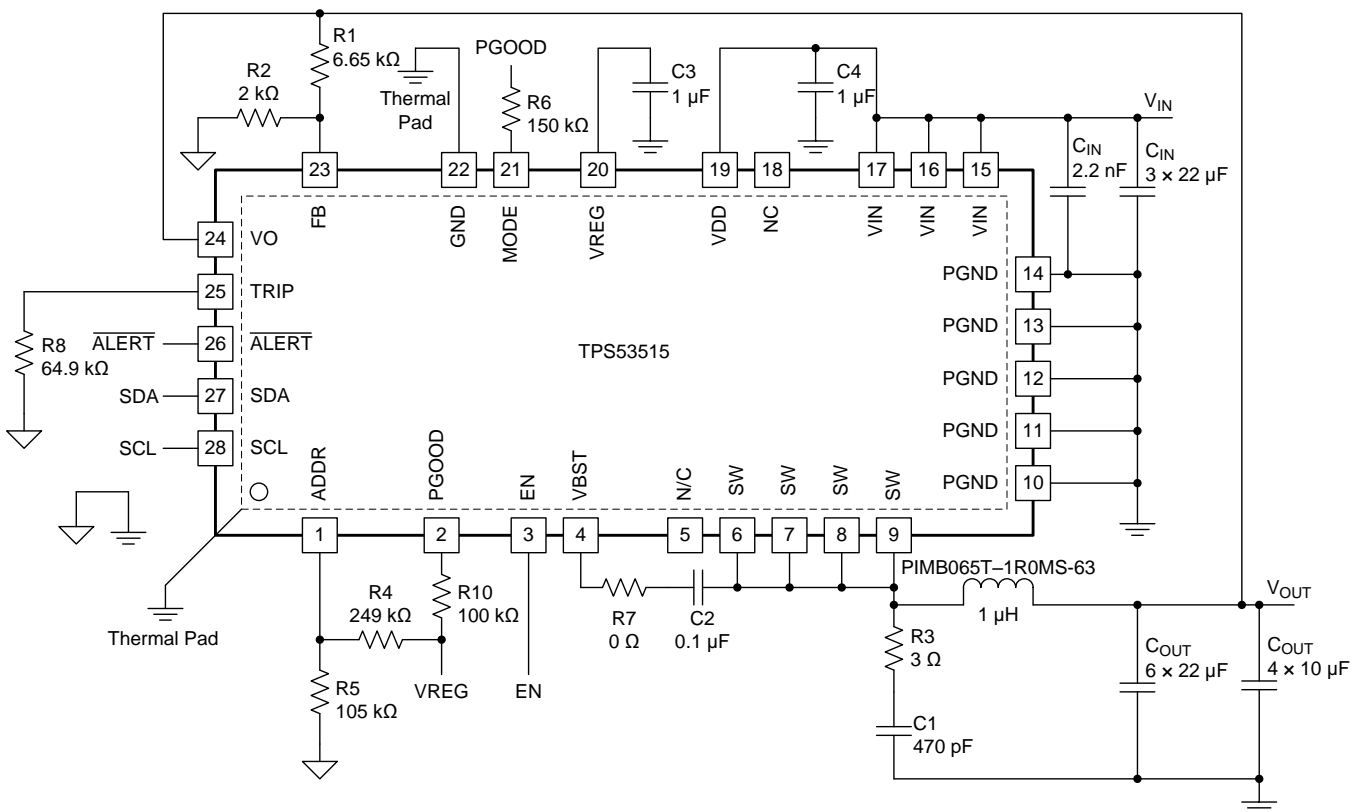

Figure 43. Application Circuit Diagram

## Typical Application (continued)

### 8.2.1 Design Requirements

This design uses the parameters listed in [Table 5](#).

**Table 5. Design Example Specifications**

PARAMETER	TEST CONDITIONS	MIN	TYP	MAX	UNIT
<b>INPUT CHARACTERISTIC</b>					
V <sub>IN</sub>	Voltage range	5	12	18	V
I <sub>MAX</sub>	Maximum input current	V <sub>IN</sub> = 5 V, I <sub>OUT</sub> = 8 A		2.5	A
	No load input current	V <sub>IN</sub> = 12 V, I <sub>OUT</sub> = 0 A with auto skip mode		1	mA
<b>OUTPUT CHARACTERISTICS</b>					
V <sub>OUT</sub>	Output voltage			1.2	V
	Output voltage regulation	Line regulation, 5 V ≤ V <sub>IN</sub> ≤ 14 V with FCCM		0.2%	
		Load regulation, V <sub>IN</sub> = 12 V, 0 A ≤ I <sub>OUT</sub> ≤ 8 A with FCCM		0.5%	
V <sub>RIPPLE</sub>	Output voltage ripple	V <sub>IN</sub> = 12 V, I <sub>OUT</sub> = 8 A with FCCM		10	mV <sub>PP</sub>
I <sub>LOAD</sub>	Output load current	0		12	A
I <sub>OVER</sub>	Output over current			11	
t <sub>SS</sub>	Soft-start time			1	ms
<b>SYSTEMS CHARACTERISTICS</b>					
f <sub>SW</sub>	Switching frequency			1	MHz
η	Peak efficiency	V <sub>IN</sub> = 12 V, V <sub>OUT</sub> = 1.2 V, I <sub>OUT</sub> = 4 A		88.5%	
η	Full load efficiency	V <sub>IN</sub> = 12 V, V <sub>OUT</sub> = 1.2 V, I <sub>OUT</sub> = 8 A		86.9%	
T <sub>A</sub>	Operating temperature			25	°C

### 8.2.2 Detailed Design Procedure

The external components selection is a simple process using D-CAP3 mode. Select the external components using the following steps

#### 8.2.2.1 Choose the Switching Frequency

The switching frequency is configured by the resistor divider on the RF pin. Select one of eight switching frequencies from 250 kHz to 1 MHz. Refer to [Table 1](#) for the relationship between the switching frequency and resistor-divider configuration.

#### 8.2.2.2 Choose the Operation Mode

Select the operation mode using [Table 4](#).

#### 8.2.2.3 Choose the Inductor

Determine the inductance value to set the ripple current at approximately ¼ to ½ of the maximum output current. Larger ripple current increases output ripple voltage, improves signal-to-noise ratio, and helps to stabilize operation.

$$\begin{aligned}
 L &= \frac{1}{I_{\text{IND(ripple)}} \times f_{\text{SW}}} \times \frac{(V_{\text{IN(max)}} - V_{\text{OUT}}) \times V_{\text{OUT}}}{V_{\text{IN(max)}}} = \frac{3}{I_{\text{OUT(max)}} \times f_{\text{SW}}} \times \frac{(V_{\text{IN(max)}} - V_{\text{OUT}}) \times V_{\text{OUT}}}{V_{\text{IN(max)}}} \\
 &= \frac{3}{6 \times 500 \text{ kHz}} \times \frac{(12 \text{ V} - 1.2 \text{ V}) \times 1.2 \text{ V}}{12 \text{ V}} = 1.08 \mu\text{H}
 \end{aligned} \tag{7}$$

The inductor requires a low DCR to achieve good efficiency. The inductor also requires enough room above peak inductor current before saturation. The peak inductor current is estimated using [Equation 8](#).



$$I_{IND(peak)} = \frac{V_{TRIP}}{8 \times R_{DS(on)}} + \frac{1}{L \times f_{SW}} \times \frac{(V_{IN(max)} - V_{OUT}) \times V_{OUT}}{V_{IN(max)}} = \frac{10 \mu A \times R_{TRIP}}{8 \times 5.9 m\Omega} + \frac{1}{1 \mu H \times 500 kHz} \times \frac{(12 V - 1.2 V) \times 1.2 V}{12 V} \quad (8)$$

### 8.2.2.4 Choose the Output Capacitor

The output capacitor selection is determined by output ripple and transient requirement. When operating in CCM, the output ripple has two components as shown in Equation 9. Equation 10 and Equation 11 define these components.

$$V_{RIPPLE} = V_{RIPPLE(C)} + V_{RIPPLE(ESR)} \quad (9)$$

$$V_{RIPPLE(C)} = \frac{I_{L(ripple)}}{8 \times C_{OUT} \times f_{SW}} \quad (10)$$

$$V_{RIPPLE(ESR)} = I_{L(ripple)} \times ESR \quad (11)$$

### 8.2.2.5 Determine the Value of R1 and R2

The output voltage is programmed by the voltage-divider resistors, R1 and R2, shown in Equation 12. Connect R1 between the VFB pin and the output, and connect R2 between the VFB pin and GND. The recommended R2 value is from 1 kΩ to 20 kΩ. Determine R1 using Equation 12.

$$R1 = \frac{V_{OUT} - 0.6}{0.6} \times R2 = \frac{1.2 V - 0.6}{0.6} \times 10 k\Omega = 10 k\Omega \quad (12)$$

## 8.2.3 Application Curves

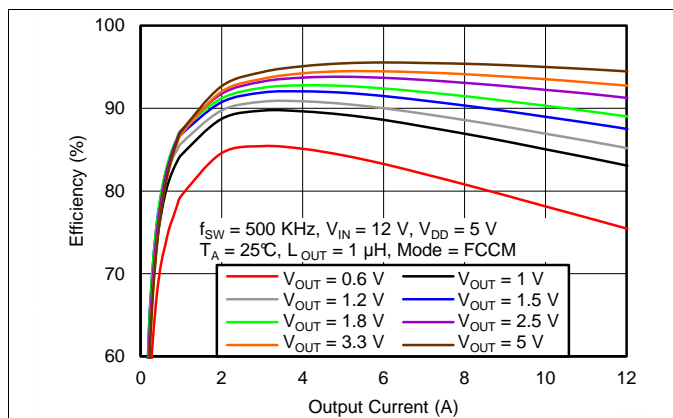

Figure 44. Efficiency vs. Output Current

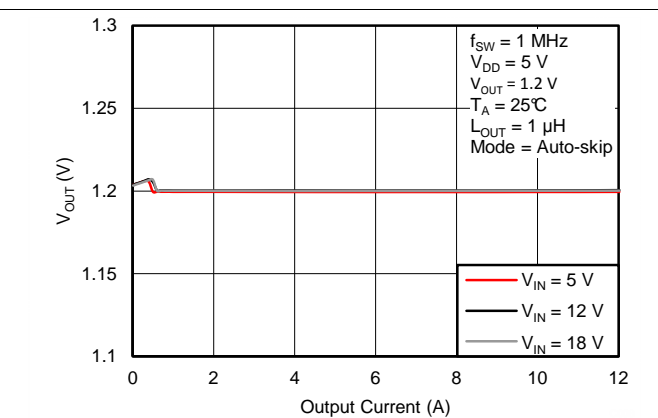

Figure 45. Output Voltage vs. Output Current

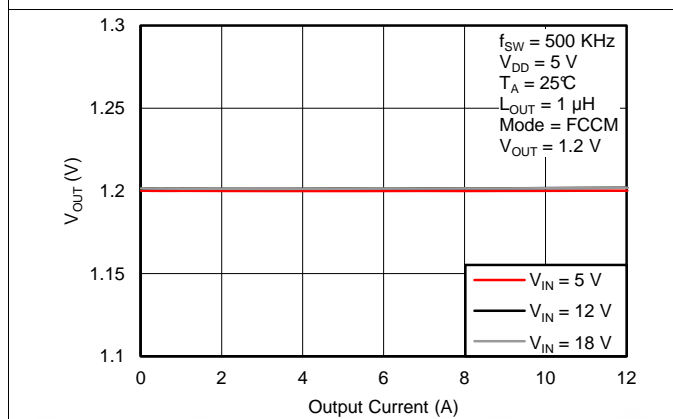

Figure 46. Output Voltage vs. Output Current

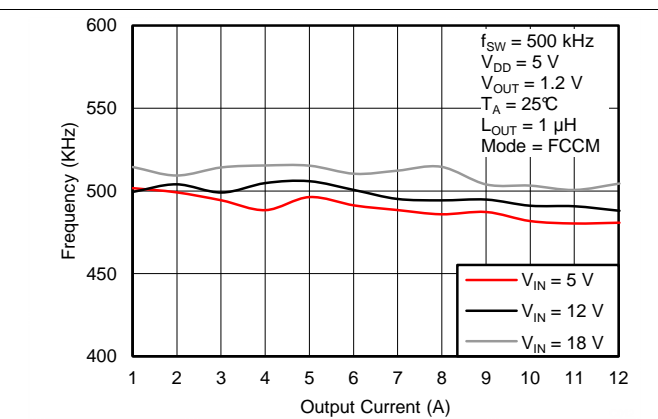
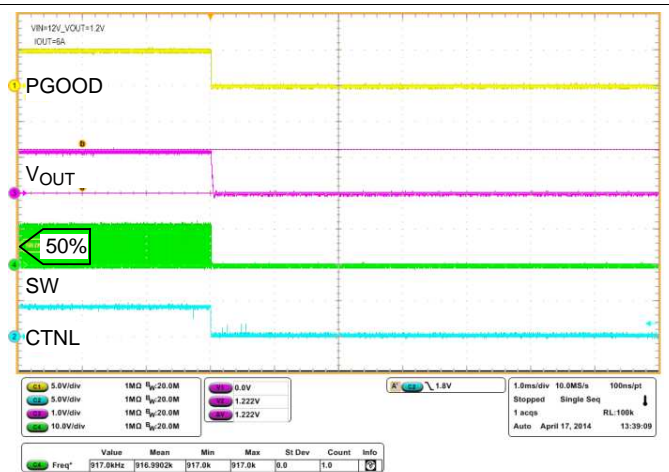

Figure 47. Switching Frequency vs. Output Current



$I_{LOAD} = 6\text{ A}$

Figure 48. Start-Up Sequence



$I_{LOAD} = 6\text{ A}$

Figure 49. Shutdown Sequence

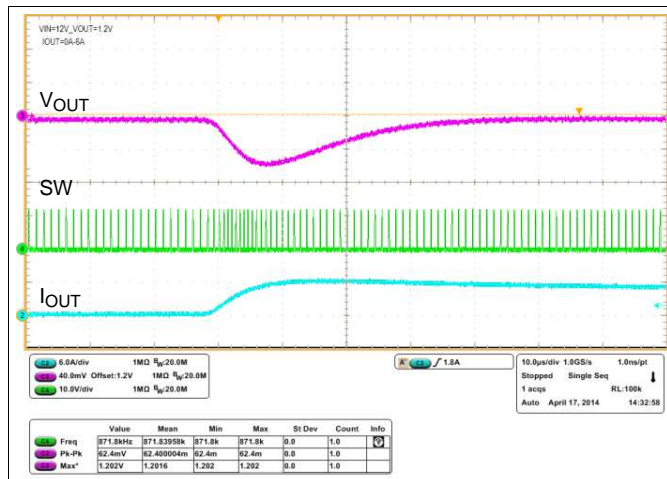

$I_{LOAD}$  from 0 A to 6 A

Figure 50. Load Transient

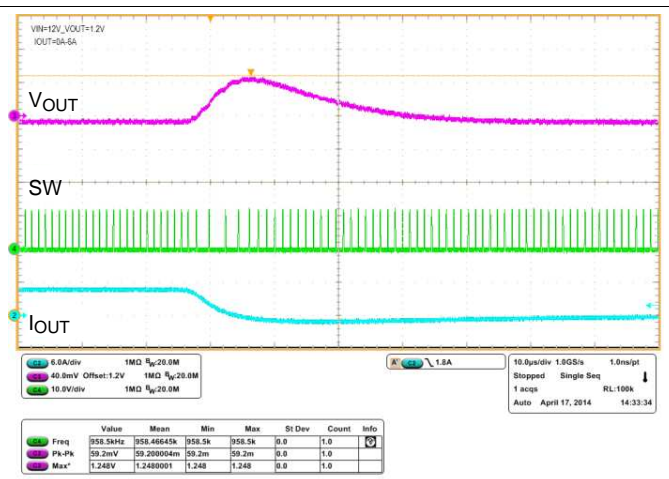

$I_{LOAD}$  from 6 A to 0 A

Figure 51. Load Transient

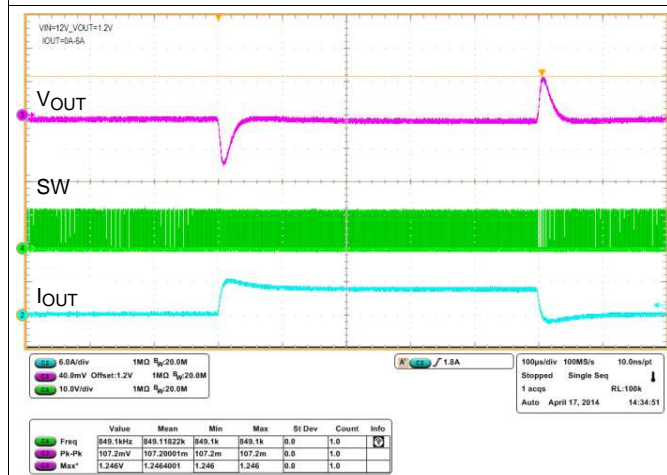

$I_{LOAD}$  from 0 A to 6 A to 0 A

Figure 52. Full Cycle Load Transient

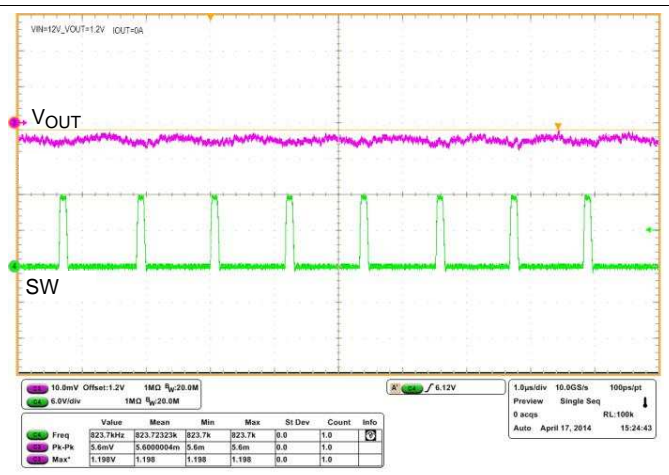

$I_{LOAD} = 0\text{ A}$

Figure 53. Output Voltage Ripple

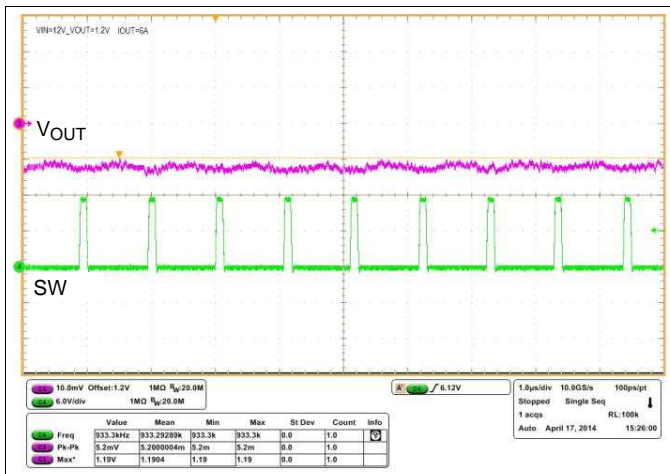

$I_{LOAD} = 6 A$

Figure 54. Output Voltage Ripple

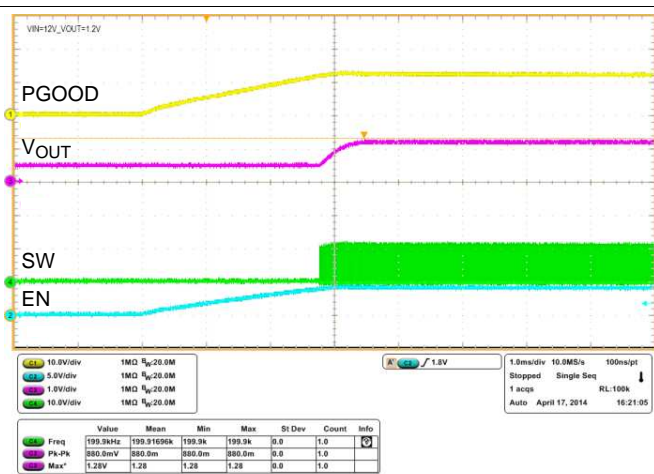

Preset  $V_{OUT} = 0.5 V$

Figure 55. Prebias Start-Up

## 9 Power Supply Recommendations

The devices are designed to operate from an input voltage supply range between 1.5 V and 18 V (4.5 V to 25 V biased). This input supply must be well regulated. Proper bypassing of input supplies and internal regulators is also critical for noise performance, as is PCB layout and grounding scheme. See the recommendations in the [Layout](#) section.

## 10 Layout

### 10.1 Layout Guidelines

Before beginning a design using the TPS53515 device, consider the following:

- Place the power components (including input and output capacitors, the inductor, and the DPA02259 device) on the solder side of the PCB. To shield and isolate the small signal traces from noisy power lines, insert and connect at least one inner plane to ground.
- All sensitive analog traces and components such as VFB, PGOOD, TRIP, MODE, and RF must be placed away from high-voltage switching nodes such as SW and VBST to avoid coupling. Use internal layers as ground planes and shield the feedback trace from power traces and components.
- GND (pin 22) must be connected directly to the thermal pad. Connect the thermal pad to the PGND terminals and then to the GND plane.
- The GND1 terminal (pin 27) and the GND2 terminal (pin 28) are not actual GND terminals and neither of these terminals should be used for dedicated ground connection. The recommendation is to connect GND1 terminal (pin 27) and the GND2 terminal (pin 28) to the nearby ground.
- Place the VIN decoupling capacitors as close to the VIN and PGND terminals as possible to minimize the input AC-current loop.
- Place the feedback resistor near the device to minimize the VFB trace distance.
- Place the frequency-setting resistor ( $R_{RF}$ ), OCP-setting resistor ( $R_{TRIP}$ ) and mode-setting resistor ( $R_{MODE}$ ) close to the device. Use the common GND via to connect the resistors to the GND plane if applicable.
- Place the VDD and VREG decoupling capacitors as close to the device as possible. Provide GND vias for each decoupling capacitor and ensure the loop is as small as possible.
- This design defines the PCB trace as a switch node, which connects the SW terminals and high-voltage side of the inductor. The switch node should be as short and wide as possible.
- Use separated vias or trace to connect SW node to the snubber, bootstrap capacitor, and ripple-injection resistor. Do not combine these connections.
- Place one more small capacitor (2.2-nF, 0402 size) between the VIN and PGND terminals. This capacitor must be placed as close to the device as possible.
- TI recommends placing a snubber between the SW shape and GND shape for effective ringing reduction. The value of snubber design starts at  $3\ \Omega + 470\ \text{pF}$ .
- Consider R-C- $C_C$  network (ripple injection network) component placement and place the AC coupling capacitor,  $C_C$ , close to the device, and R and C close to the power stage. (Application designs with output capacitance lower than the minimum may require only an R-C-C network. In this case, Bode plot verification is needed to validate the design).
- See [Figure 56](#) for the layout recommendation.

## 10.2 Layout Example

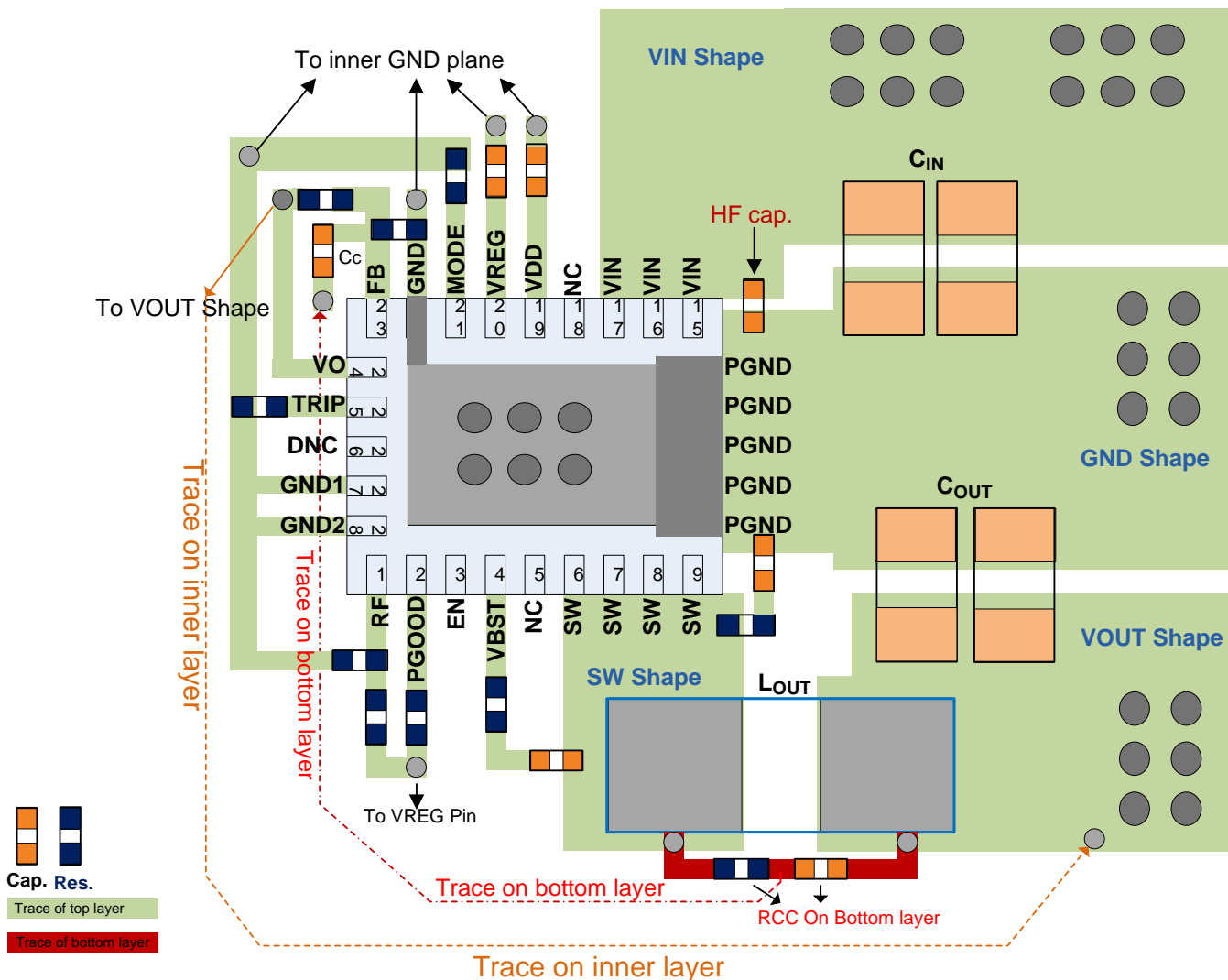

Figure 56. Layout Recommendation

### 10.3 Thermal Performance



$T_A = 23^\circ\text{C}$ ,  $f_{\text{SW}} = 500 \text{ kHz}$ ,  $V_{\text{IN}} = 12 \text{ V}$ ,  $V_{\text{OUT}} = 1.24 \text{ V}$ ,  $I_{\text{OUT}} = 8 \text{ A}$ ,  $R_{\text{BOOT}} = 0 \ \Omega$ ,  $\text{SNB} = 3 \ \Omega + 470 \text{ pF}$   
 Inductor:  $L_{\text{OUT}} = 1 \ \mu\text{H}$ , PIMB103T-1R0MS-63, 10 mm × 11.2 mm × 3 mm, 5.3 m $\Omega$

**Figure 57. SP1: 43°C (TPS53515), SP2: 35.1°C (Inductor)**

## 11 Device and Documentation Support

### 11.1 Documentation Support

#### 11.1.1 Related Documentation

*Optimizing Transient Response of Internally Compensated dc-dc Converters With Feedforward Capacitor*,  
[SLVA289](#)

### 11.2 Community Resources

The following links connect to TI community resources. Linked contents are provided "AS IS" by the respective contributors. They do not constitute TI specifications and do not necessarily reflect TI's views; see TI's [Terms of Use](#).

**TI E2E™ Online Community** *TI's Engineer-to-Engineer (E2E) Community*. Created to foster collaboration among engineers. At [e2e.ti.com](#), you can ask questions, share knowledge, explore ideas and help solve problems with fellow engineers.

**Design Support** *TI's Design Support* Quickly find helpful E2E forums along with design support tools and contact information for technical support.

### 11.3 Trademarks

D-CAP3, SWIFT, Eco-mode, E2E are trademarks of Texas Instruments.  
WEBENCH is a registered trademark of Texas Instruments.  
All other trademarks are the property of their respective owners.

### 11.4 Electrostatic Discharge Caution



These devices have limited built-in ESD protection. The leads should be shorted together or the device placed in conductive foam during storage or handling to prevent electrostatic damage to the MOS gates.

### 11.5 Glossary



[SLYZ022](#) — *TI Glossary*.

This glossary lists and explains terms, acronyms, and definitions.

## 12 Mechanical, Packaging, and Orderable Information

The following pages include mechanical, packaging, and orderable information. This information is the most current data available for the designated devices. This data is subject to change without notice and revision of this document. For browser-based versions of this data sheet, refer to the left-hand navigation.

**PACKAGING INFORMATION**

Orderable Device	Status (1)	Package Type	Package Drawing	Pins	Package Qty	Eco Plan (2)	Lead finish/ Ball material (6)	MSL Peak Temp (3)	Op Temp (°C)	Device Marking (4/5)	Samples
TPS53515RVER	ACTIVE	VQFN-CLIP	RVE	28	3000	RoHS-Exempt & Green	NIPDAU   SN	Level-2-260C-1 YEAR	-40 to 85	TPS53515	
TPS53515RVET	ACTIVE	VQFN-CLIP	RVE	28	250	RoHS-Exempt & Green	NIPDAU   SN	Level-2-260C-1 YEAR	-40 to 85	TPS53515	

(1) The marketing status values are defined as follows:

**ACTIVE:** Product device recommended for new designs.

**LIFEBUY:** TI has announced that the device will be discontinued, and a lifetime-buy period is in effect.

**NRND:** Not recommended for new designs. Device is in production to support existing customers, but TI does not recommend using this part in a new design.

**PREVIEW:** Device has been announced but is not in production. Samples may or may not be available.

**OBSOLETE:** TI has discontinued the production of the device.

(2) **RoHS:** TI defines "RoHS" to mean semiconductor products that are compliant with the current EU RoHS requirements for all 10 RoHS substances, including the requirement that RoHS substance do not exceed 0.1% by weight in homogeneous materials. Where designed to be soldered at high temperatures, "RoHS" products are suitable for use in specified lead-free processes. TI may reference these types of products as "Pb-Free".

**RoHS Exempt:** TI defines "RoHS Exempt" to mean products that contain lead but are compliant with EU RoHS pursuant to a specific EU RoHS exemption.

**Green:** TI defines "Green" to mean the content of Chlorine (Cl) and Bromine (Br) based flame retardants meet JS709B low halogen requirements of <=1000ppm threshold. Antimony trioxide based flame retardants must also meet the <=1000ppm threshold requirement.

(3) MSL, Peak Temp. - The Moisture Sensitivity Level rating according to the JEDEC industry standard classifications, and peak solder temperature.

(4) There may be additional marking, which relates to the logo, the lot trace code information, or the environmental category on the device.

(5) Multiple Device Markings will be inside parentheses. Only one Device Marking contained in parentheses and separated by a "~" will appear on a device. If a line is indented then it is a continuation of the previous line and the two combined represent the entire Device Marking for that device.

(6) Lead finish/Ball material - Orderable Devices may have multiple material finish options. Finish options are separated by a vertical ruled line. Lead finish/Ball material values may wrap to two lines if the finish value exceeds the maximum column width.

**Important Information and Disclaimer:**The information provided on this page represents TI's knowledge and belief as of the date that it is provided. TI bases its knowledge and belief on information provided by third parties, and makes no representation or warranty as to the accuracy of such information. Efforts are underway to better integrate information from third parties. TI has taken and continues to take reasonable steps to provide representative and accurate information but may not have conducted destructive testing or chemical analysis on incoming materials and chemicals. TI and TI suppliers consider certain information to be proprietary, and thus CAS numbers and other limited information may not be available for release.

In no event shall TI's liability arising out of such information exceed the total purchase price of the TI part(s) at issue in this document sold by TI to Customer on an annual basis.





**TAPE AND REEL INFORMATION**

**QUADRANT ASSIGNMENTS FOR PIN 1 ORIENTATION IN TAPE**



\*All dimensions are nominal

Device	Package Type	Package Drawing	Pins	SPQ	Reel Diameter (mm)	Reel Width W1 (mm)	A0 (mm)	B0 (mm)	K0 (mm)	P1 (mm)	W (mm)	Pin1 Quadrant
TPS53515RVER	VQFN-CLIP	RVE	28	3000	330.0	12.4	3.71	4.71	1.1	8.0	12.0	Q1
TPS53515RVET	VQFN-CLIP	RVE	28	250	180.0	12.4	3.71	4.71	1.1	8.0	12.0	Q1

**TAPE AND REEL BOX DIMENSIONS**

\*All dimensions are nominal

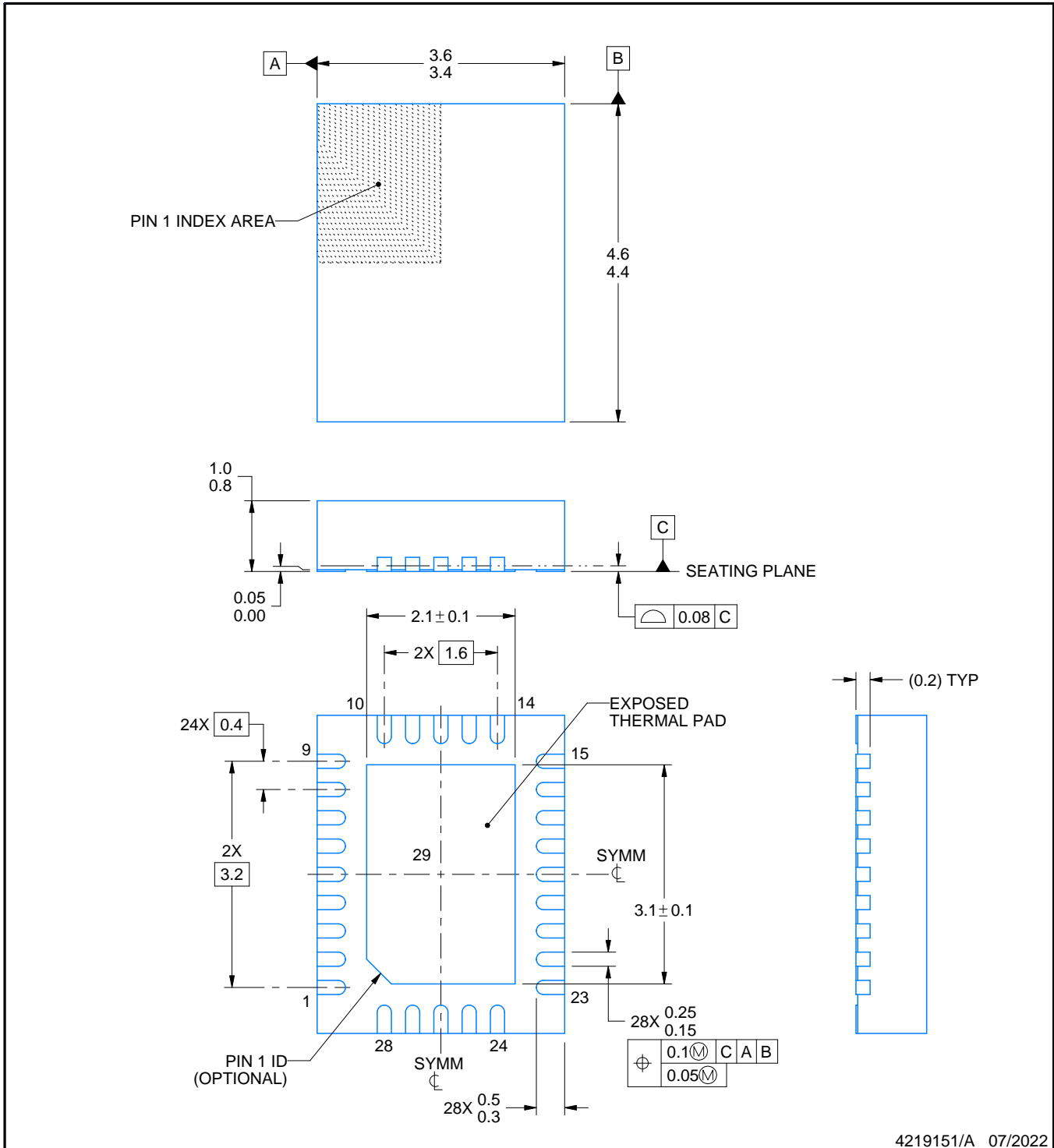
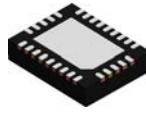
Device	Package Type	Package Drawing	Pins	SPQ	Length (mm)	Width (mm)	Height (mm)
TPS53515RVER	VQFN-CLIP	RVE	28	3000	346.0	346.0	33.0
TPS53515RVET	VQFN-CLIP	RVE	28	250	210.0	185.0	35.0



4219151/A 07/2022

NOTES:

1. All linear dimensions are in millimeters. Any dimensions in parenthesis are for reference only. Dimensioning and tolerancing per ASME Y14.5M.
2. This drawing is subject to change without notice.
3. The package thermal pad must be soldered to the printed circuit board for thermal and mechanical performance.



# EXAMPLE STENCIL DESIGN

RVE0028A

VQFN - 1 mm max height

PLASTIC QUAD FLATPACK - NO LEAD

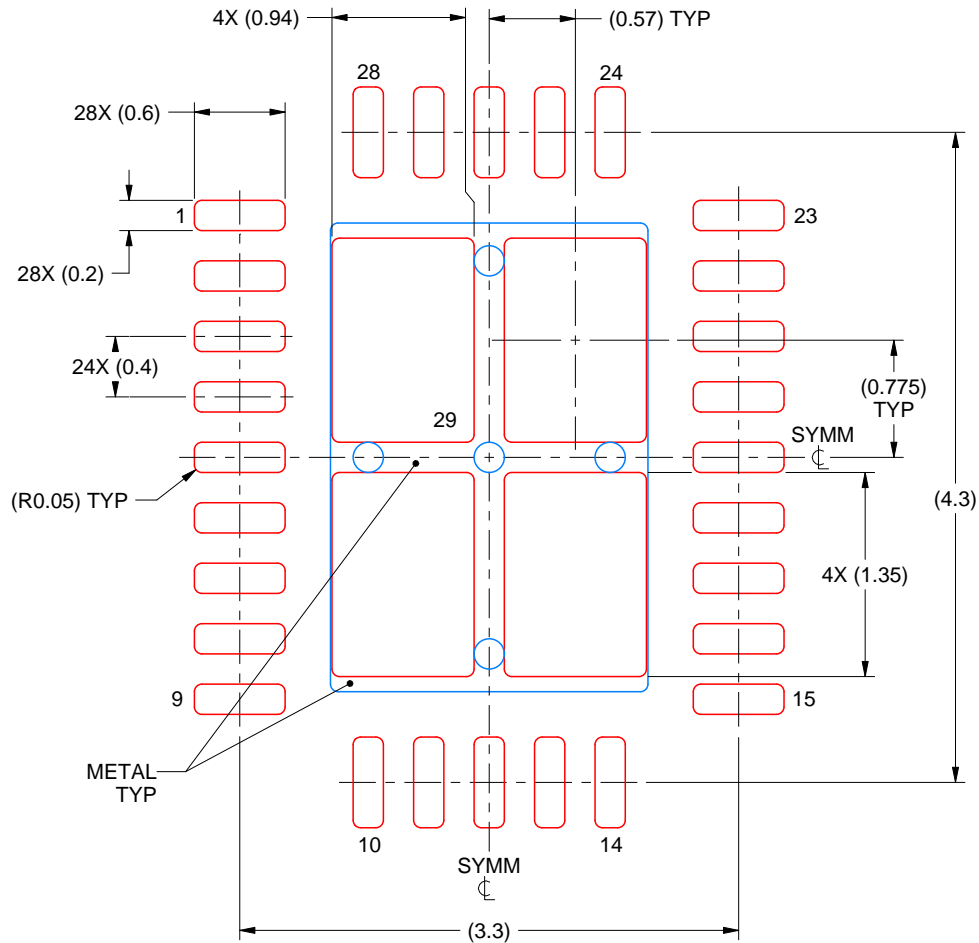

**SOLDER PASTE EXAMPLE**  
BASED ON 0.125 mm THICK STENCIL

EXPOSED PAD 29  
78% PRINTED SOLDER COVERAGE BY AREA UNDER PACKAGE  
SCALE:20X

4219151/A 07/2022

NOTES: (continued)

6. Laser cutting apertures with trapezoidal walls and rounded corners may offer better paste release. IPC-7525 may have alternate design recommendations.

## THERMAL PAD MECHANICAL DATA

RVE (R-PVQFN-N28)

PLASTIC QUAD FLATPACK NO-LEAD

### THERMAL INFORMATION

This package incorporates an exposed thermal pad that is designed to be attached directly to an external heatsink. The thermal pad must be soldered directly to the printed circuit board (PCB). After soldering, the PCB can be used as a heatsink. In addition, through the use of thermal vias, the thermal pad can be attached directly to the appropriate copper plane shown in the electrical schematic for the device, or alternatively, can be attached to a special heatsink structure designed into the PCB. This design optimizes the heat transfer from the integrated circuit (IC).

For information on the Quad Flatpack No-Lead (QFN) package and its advantages, refer to Application Report, QFN/SON PCB Attachment, Texas Instruments Literature No. SLUA271. This document is available at [www.ti.com](http://www.ti.com).

The exposed thermal pad dimensions for this package are shown in the following illustration.

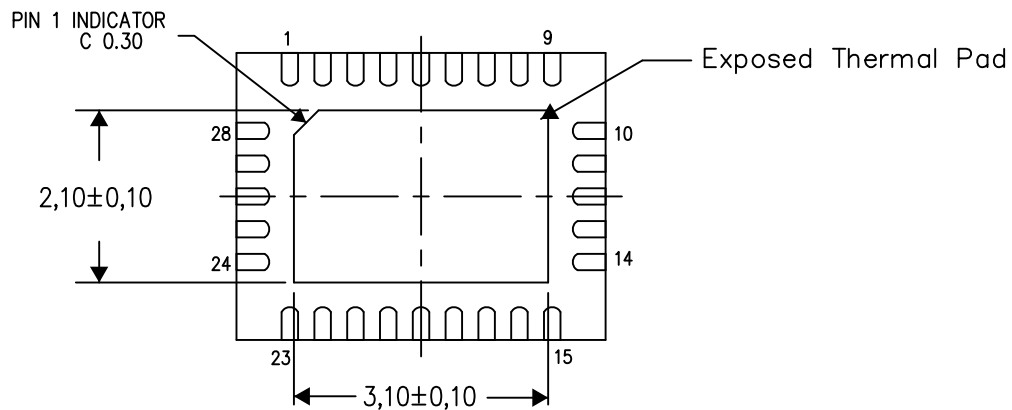

Bottom View

Exposed Thermal Pad Dimensions

4211776/E 04/15

NOTE: All linear dimensions are in millimeters

RVE (R-PWQFN-N28)

PLASTIC QUAD FLATPACK NO-LEAD

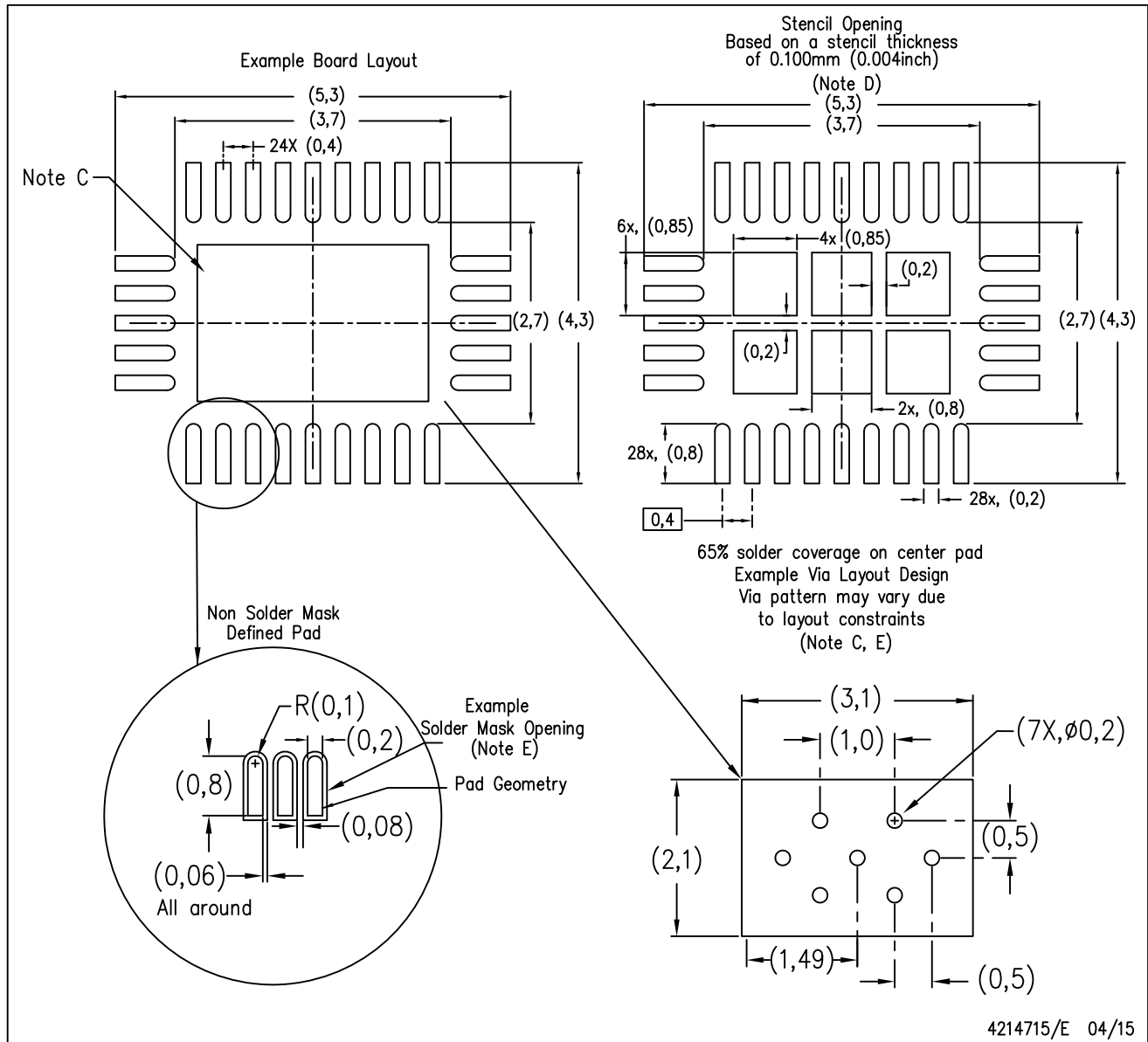

- NOTES:
- All linear dimensions are in millimeters.
  - This drawing is subject to change without notice.
  - This package is designed to be soldered to a thermal pad on the board. Refer to Application Note, Quad Flat-Pack Packages, Texas Instruments Literature No. SLUA271, and also the Product Data Sheets for specific thermal information, via requirements, and recommended board layout. These documents are available at [www.ti.com](http://www.ti.com) <<http://www.ti.com>>.
  - Laser cutting apertures with trapezoidal walls and also rounding corners will offer better paste release. Electroformed stencils offer adequate release at thicker values/lower Area Ratios. Customers should contact their board assembly site for stencil design recommendations. Refer to IPC 7525 for stencil design considerations.
  - Customers should contact their board fabrication site for minimum solder mask web tolerances between signal pads.



## IMPORTANT NOTICE AND DISCLAIMER

TI PROVIDES TECHNICAL AND RELIABILITY DATA (INCLUDING DATA SHEETS), DESIGN RESOURCES (INCLUDING REFERENCE DESIGNS), APPLICATION OR OTHER DESIGN ADVICE, WEB TOOLS, SAFETY INFORMATION, AND OTHER RESOURCES "AS IS" AND WITH ALL FAULTS, AND DISCLAIMS ALL WARRANTIES, EXPRESS AND IMPLIED, INCLUDING WITHOUT LIMITATION ANY IMPLIED WARRANTIES OF MERCHANTABILITY, FITNESS FOR A PARTICULAR PURPOSE OR NON-INFRINGEMENT OF THIRD PARTY INTELLECTUAL PROPERTY RIGHTS.

These resources are intended for skilled developers designing with TI products. You are solely responsible for (1) selecting the appropriate TI products for your application, (2) designing, validating and testing your application, and (3) ensuring your application meets applicable standards, and any other safety, security, regulatory or other requirements.

These resources are subject to change without notice. TI grants you permission to use these resources only for development of an application that uses the TI products described in the resource. Other reproduction and display of these resources is prohibited. No license is granted to any other TI intellectual property right or to any third party intellectual property right. TI disclaims responsibility for, and you will fully indemnify TI and its representatives against, any claims, damages, costs, losses, and liabilities arising out of your use of these resources.

TI's products are provided subject to [TI's Terms of Sale](#) or other applicable terms available either on [ti.com](https://www.ti.com) or provided in conjunction with such TI products. TI's provision of these resources does not expand or otherwise alter TI's applicable warranties or warranty disclaimers for TI products.

TI objects to and rejects any additional or different terms you may have proposed.

Mailing Address: Texas Instruments, Post Office Box 655303, Dallas, Texas 75265  
Copyright © 2023, Texas Instruments Incorporated