

TPS54061 Wide Input 60-V, 200-mA Synchronous Step-Down DC-DC Converter With Low IQ

1 Features

- Integrated High-Side and Low-Side MOSFET
- Diode Emulation for Improved Light Load Efficiency
- Peak Current Mode Control
- 90- μ A Operating Quiescent Current
- 1.4- μ A Shutdown Supply Current
- 50-kHz to 1100-kHz Adjustable Switching Frequency
- Synchronizes to External Clock
- Internal Slow-Start
- 0.8 V \pm 1% Voltage Reference
- Stable With Ceramic Output Capacitors or Low-Cost Aluminum Electrolytic
- Cycle-by-Cycle Current Limit, Thermal, OVP and Frequency Foldback Protection
- VSON-8 Package, 3 mm \times 3 mm With Thermal Pad
- -40°C to 150°C Operating Junction Temperature

2 Applications

- 4 to 20-mA Current-Loop Powered Sensors
- Low Power Standby or Bias Voltage Supplies
- Industrial Process Control, Metering, and Security Systems
- High Efficiency Replacement for High Voltage Linear Regulators

3 Description

The TPS54061 device is a 60-V, 200-mA, synchronous step-down DC-DC converter with integrated high-side and low-side MOSFETs. Current mode control provides simple external compensation and flexible component selection. The non-switching supply current is 90 μ A. Using the enable pin, shutdown supply current is reduced to 1.4 μ A.

To increase light load efficiency the low-side MOSFET emulates a diode when the inductor current reaches zero.

Under voltage lockout is internally set at 4.5 V, but can be increased using two resistors on the enable pin. The output voltage startup ramp is controlled by the internal slow-start time.

The adjustable switching frequency range allows efficiency and external component size to be optimized. Frequency foldback and thermal shutdown protects the part during an overload condition.

The TPS54061 enables small designs by integrating the MOSFETs, boot recharge diode, and minimizing the IC footprint with a small 3.00 mm \times 3.00 mm thermally enhanced VSON package

The TPS54061 is supported in the WEBENCH™ Designer at www.ti.com.

Device Information⁽¹⁾

PART NUMBER	PACKAGE	BODY SIZE (NOM)
TPS54061	VSON (8)	3.00 mm \times 3.00 mm

(1) For all available packages, see the orderable addendum at the end of the datasheet.

Simplified Schematic

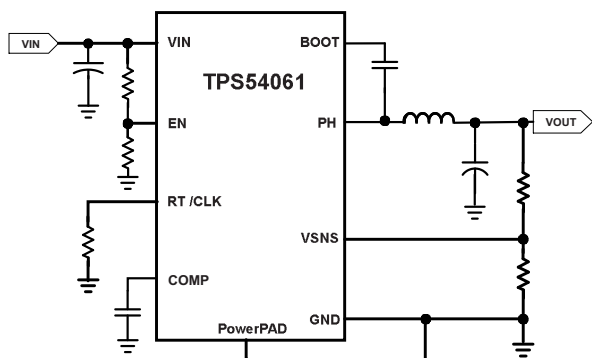

Efficiency vs Load Current

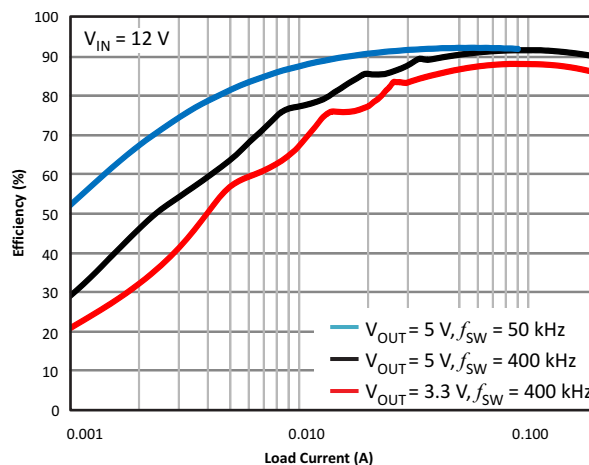

Table of Contents

1 Features 1 2 Applications 1 3 Description 1 4 Revision History 2 5 Pin Configuration and Functions 3 6 Specifications 4 6.1 Absolute Maximum Ratings 4 6.2 ESD Ratings..... 4 6.3 Recommended Operating Conditions 4 6.4 Thermal Information 4 6.5 Electrical Characteristics 5 6.6 Typical Characteristics 7 7 Detailed Description 10 7.1 Overview 10 7.2 Functional Block Diagram 11	7.3 Feature Description..... 11 7.4 Device Functional Modes..... 15 8 Application and Implementation 16 8.1 Application Information..... 16 8.2 Typical Applications 16 9 Power Supply Recommendations 30 10 Layout 30 10.1 Layout Guidelines 30 10.2 Layout Example 30 11 Device and Documentation Support 31 11.1 Trademarks 31 11.2 Electrostatic Discharge Caution..... 31 11.3 Glossary 31 12 Mechanical, Packaging, and Orderable Information 31
--------------------------------------------------------------------------------------------------------------------------------------------------------------------------------------------------------------------------------------------------------------------------------------------------------------------------------------------------------------------------------------------------------------------------------------------------------------------------------------------------------------------------------------------------------------------------	----------------------------------------------------------------------------------------------------------------------------------------------------------------------------------------------------------------------------------------------------------------------------------------------------------------------------------------------------------------------------------------------------------------------------------------------------------------------------------------------------------------------------------------------------------------------------------------------

4 Revision History

NOTE: Page numbers for previous revisions may differ from page numbers in the current version.

Changes from Revision D (December 2014) to Revision E	Page
• Changed PH, 10ns Transient MIN value in the <i>Absolute Maximum Ratings</i> From: –2 V To: –4 V 4	4
• Moved Storage temperature, T _{stg} From: <i>ESD Ratings</i> To: <i>Absolute Maximum Ratings</i> 4	4
• Changed <i>Handling Ratings</i> table To: <i>ESD Ratings</i> table 4	4

Changes from Revision C (September 2013) to Revision D	Page
• Added <i>Pin Configuration and Functions</i> section, <i>Handling Rating</i> table, <i>Feature Description</i> section, <i>Device Functional Modes</i> , <i>Application and Implementation</i> section, <i>Power Supply Recommendations</i> section, <i>Layout</i> section, <i>Device and Documentation Support</i> section, and <i>Mechanical, Packaging, and Orderable Information</i> section 1	1
• Changed Y-axis value $\mu\text{A/V}$ to μS 8	8

Changes from Revision B (January 2013) to Revision C	Page
• Changed RT/CLK falling edge to PH rising edge delay From: 130 ns To: 60 ns..... 5	5

Changes from Revision A (May 2012) to Revision B	Page
• Changed the Efficiency vs Load Current graph..... 1	1
• Changed Pin Configuration graphic for clarification of thermal pad 3	3

Changes from Original (May 2012) to Revision A	Page
• Changed title from "4.7V to 60V Input...." to "Wide Input...." and removed "Product Preview" banner 1	1

5 Pin Configuration and Functions

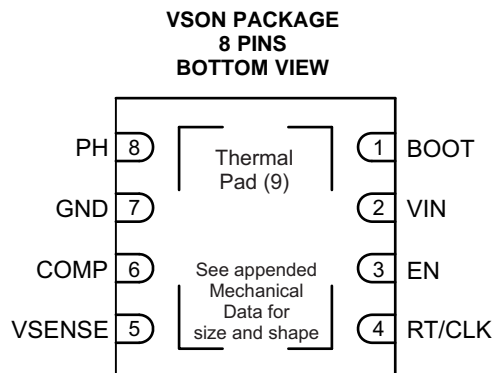

Pin Functions

PIN		I/O	DESCRIPTION
NAME	NUMBER		
BOOT	1	O	A bootstrap capacitor is required between BOOT and PH. If the voltage on this capacitor is below the minimum required by the output device, the output is forced to switch off until the capacitor is refreshed.
VIN	2	I	Input supply voltage, 4.7 V to 60 V.
EN	3	I	Enable pin with internal pull-up current source. Pull below 1.18 V to disable. Float to enable. Adjust the input undervoltage lockout (UVLO) with two resistors, see the Enable and Adjusting Undervoltage Lockout section.
RT/CLK	4	I	Resistor Timing and External Clock. An internal amplifier holds this pin at a fixed voltage when using an external resistor to ground to set the switching frequency. If the pin is pulled above the PLL upper threshold, a mode change occurs and the pin becomes a synchronization input. The internal amplifier is disabled and the pin is a high impedance clock input to the internal PLL. If clocking edges stop, the internal amplifier is re-enabled and the mode returns to a resistor frequency programming.
VSENSE	5	I	Inverting input of the transconductance (gm) error amplifier.
COMP	6	O	Error amplifier output and input to the output switch current comparator. Connect frequency compensation components to this pin.
GND	7	–	Ground
PH	8	O	The source of the internal high-side power MOSFET and drain of the internal low-side MOSFET
Thermal Pad	9	–	GND pin must be electrically connected to the exposed pad on the printed circuit board for proper operation.

6 Specifications

6.1 Absolute Maximum Ratings

 over operating free-air temperature (unless otherwise noted)⁽¹⁾

		MIN	MAX	UNIT
Voltage	VIN	-0.3	62	V
	EN ⁽²⁾	-0.3	8	V
	BOOT-PH	-0.3	8	V
	VSENSE	-0.3	6	V
	COMP	-0.3	3	V
	PH	-0.6	62	V
	PH, 10ns Transient	-4	62	V
	RT/CLK	-0.3	6	V
Current	VIN	Internally Limited		A
	BOOT	100		mA
	PH	Internally Limited		A
Operating junction temperature		-40	150	°C
Storage temperature, T _{stg}		-65	150	°C

- (1) Stresses beyond those listed under *Absolute Maximum Ratings* may cause permanent damage to the device. These are stress ratings only, which do not imply functional operation of the device at these or any other conditions beyond those indicated under *Recommended Operating Conditions*. Exposure to absolute-maximum-rated conditions for extended periods may affect device reliability.
- (2) See [Enable and Adjusting UVLO](#) section

6.2 ESD Ratings

			VALUE	UNIT
V _(ESD)	Electrostatic discharge	Human body model (HBM), per ANSI/ESDA/JEDEC JS-001, all pins ⁽¹⁾	±2000	V
		Charged device model (CDM), per JEDEC specification JESD22-C101, all pins ⁽²⁾	±500	

- (1) JEDEC document JEP155 states that 500-V HBM allows safe manufacturing with a standard ESD control process.
- (2) JEDEC document JEP157 states that 250-V CDM allows safe manufacturing with a standard ESD control process.

6.3 Recommended Operating Conditions

over operating free-air temperature range (unless otherwise noted)

	MIN	MAX	UNIT
Input voltage	4.7	60	V
Output current		200	mA
Switching frequency set by RT/CLK resistor	50	1100	kHz
Switching frequency synchronized to external clock	300	1100	kHz

6.4 Thermal Information

THERMAL METRIC ⁽¹⁾		TPS54061	UNIT
		DRB	
		8 PINS	
R _{θJA}	Junction-to-ambient thermal resistance	42.9	°C/W
R _{θJC(top)}	Junction-to-case (top) thermal resistance	46.0	
R _{θJB}	Junction-to-board thermal resistance	18.1	
Ψ _{JT}	Junction-to-top characterization parameter	0.5	
Ψ _{JB}	Junction-to-board characterization parameter	18.3	
R _{θJC(bot)}	Junction-to-case (bottom) thermal resistance	3.0	

- (1) For more information about traditional and new thermal metrics, see the *IC Package Thermal Metrics* application report, [SPRA953](#).

6.5 Electrical Characteristics⁽¹⁾

 $T_J = -40^{\circ}\text{C}$ to 150°C , $V_{IN} = 4.7$ to 60 V (unless otherwise noted)

PARAMETER	TEST CONDITIONS	MIN	TYP	MAX	UNIT
SUPPLY VOLTAGE (VIN PIN)					
Operating input voltage	V_{IN}	4.7		60	V
Shutdown supply current	$EN = 0\text{ V}$		1.4		μA
I_q Operating – Non switching	$V_{SENSE} = 0.9\text{ V}$, $V_{IN} = 12\text{ V}$		90	110	μA
ENABLE AND UVLO (EN PIN)					
Enable threshold	Rising		1.23	1.4	V
	Falling	1	1.18		V
Input current	Enable threshold +50 mV		-4.7		μA
	Enable threshold -50 mV		-1.2		μA
Hysteresis			-3.5		μA
Enable high to start switching time			450		μs
VIN					
V_{IN} start voltage	V_{IN} rising		4.5		V
VOLTAGE REFERENCE					
Voltage reference	$T_J = 25^{\circ}\text{C}$, $V_{IN} = 12\text{ V}$	0.792	0.8	0.808	V
	$1\text{ mA} < I_{OUT} < \text{Minimum Current Limit}$	0.784	0.8	0.816	
HIGH-SIDE MOSFET					
Switch resistance	$BOOT-PH = 5.7\text{ V}$		1.5	3.0	Ω
LOW-SIDE MOSFET					
Switch resistance	$V_{IN} = 12\text{ V}$		0.8	1.5	Ω
ERROR AMPLIFIER					
Input Current	V_{SENSE} pin		20		nA
Error amp gm	$-2\mu\text{A} < I_{(COMP)} < 2\mu\text{A}$, $V_{(COMP)} = 1\text{ V}$		108		μS
EA gm during slow start	$-2\mu\text{A} < I_{(COMP)} < 2\mu\text{A}$, $V_{(COMP)} = 1\text{ V}$, $V_{SENSE} = 0.4\text{ V}$		27		μS
Error amp DC gain	$V_{SENSE} = 0.8\text{ V}$		1000		V/V
Min unity gain bandwidth			0.5		MHz
Error amp source/sink	$V_{(COMP)} = 1\text{ V}$, 100 mV Overdrive		± 8		μA
Start-Switching Threshold			0.57		V
COMP to Iswitch gm			1.0		A/V
CURRENT LIMIT					
High-side sourcing current limit threshold	$BOOT-PH = 5.7\text{ V}$	250	350	500	mA
Zero cross detect current			-1.1		mA
THERMAL SHUTDOWN					
Thermal shutdown			176		C
RT/CLK					
Operating frequency using RT mode		50		1100	kHz
Switching frequency	$R_{(RT/CLK)} = 120\text{ k}\Omega$	425	472	520	kHz
Minimum CLK pulsewidth			40		ns
RT/CLK voltage	$R_{(RT/CLK)} = 120\text{ k}\Omega$		0.53		V
RT/CLK high threshold				1.8	V
RT/CLK low threshold		0.5			V
RT/CLK falling edge to PH rising edge delay	Measure at 500 kHz with RT resistor		60		ns
PLL lock in time	Measure at 500 kHz		100		μs
PLL frequency range		300		1100	kHz

(1) The Electrical Characteristics specified in this section will apply to all specifications in this document unless otherwise noted.

Electrical Characteristics⁽¹⁾ (continued)
 $T_J = -40^{\circ}\text{C}$ to 150°C , $V_{IN} = 4.7$ to 60 V (unless otherwise noted)

PARAMETER	TEST CONDITIONS	MIN	TYP	MAX	UNIT
PH					
Minimum On-time	Measured at 50% to 50%, $I_{OUT} = 200$ mA		120		ns
Dead time	$V_{IN} = 12$ V, $I_{OUT} = 200$ mA, One transition		30		ns
BOOT					
BOOT to PH regulation voltage	$V_{IN} = 12$ V		6.0		V
BOOT-PH UVLO			2.9		V
INTERNAL SLOW-START TIME					
Slow-Start time	$f_{SW} = 472$ kHz, $R_T = 120$ k Ω , 10% to 90%		2.36		ms

6.6 Typical Characteristics

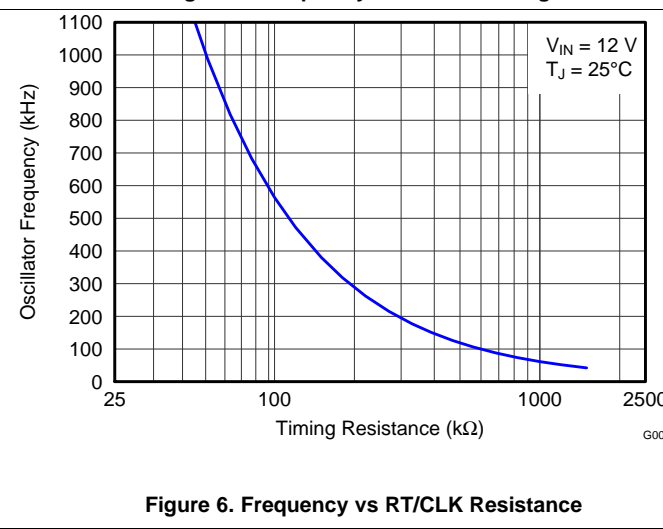
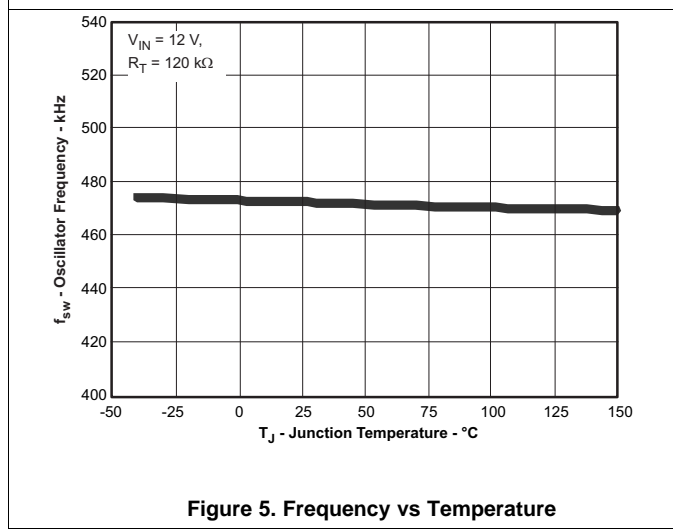
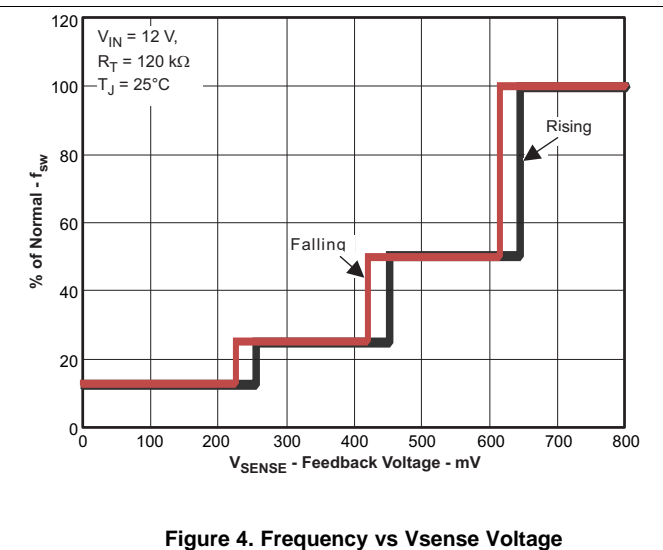
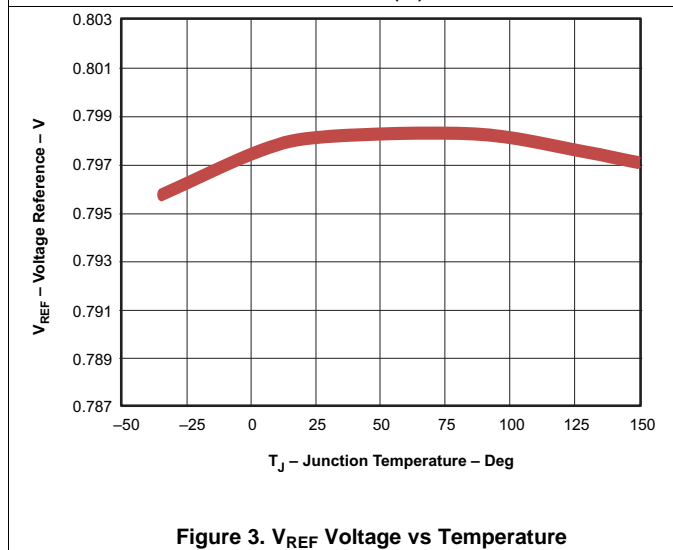
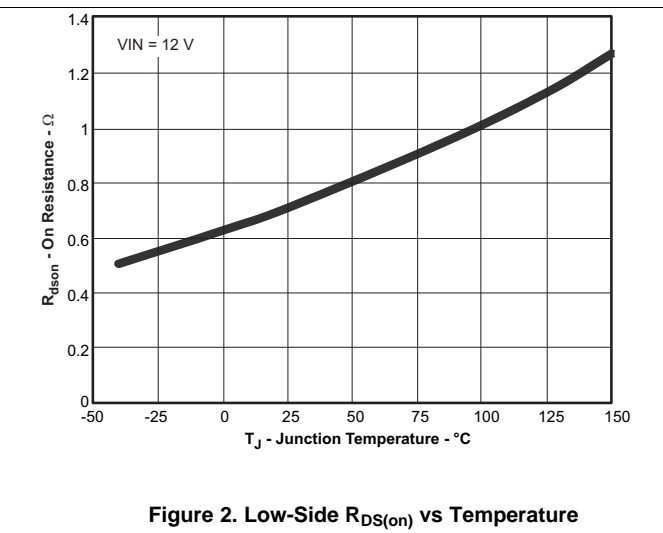
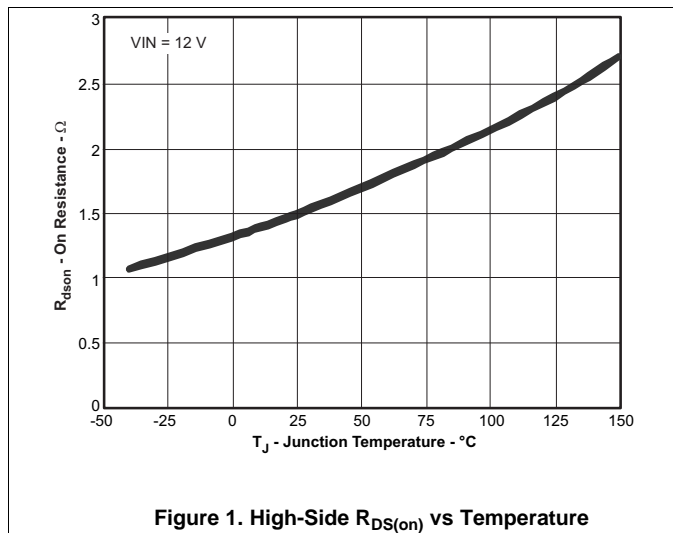

Typical Characteristics (continued)

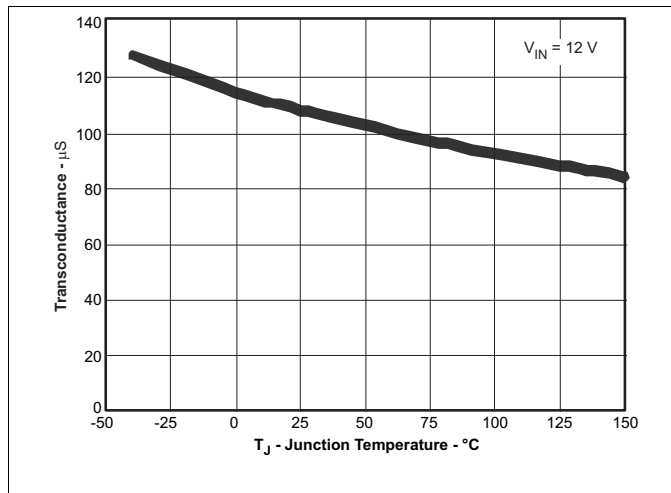

Figure 7. Error Amp Transconductance vs Temperature

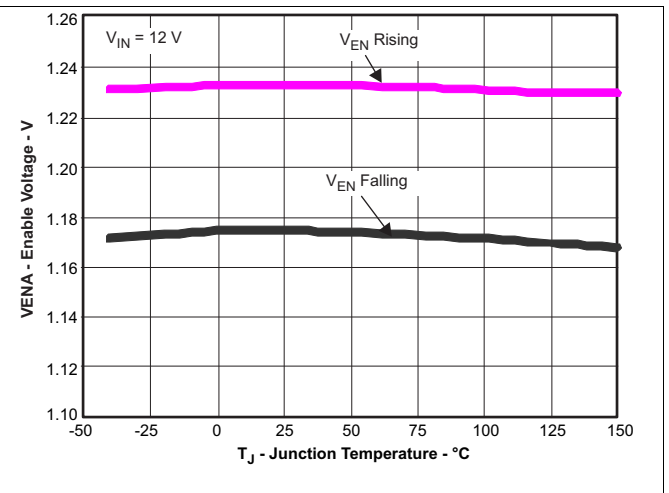

Figure 8. Enable Pin Voltage vs Temperature

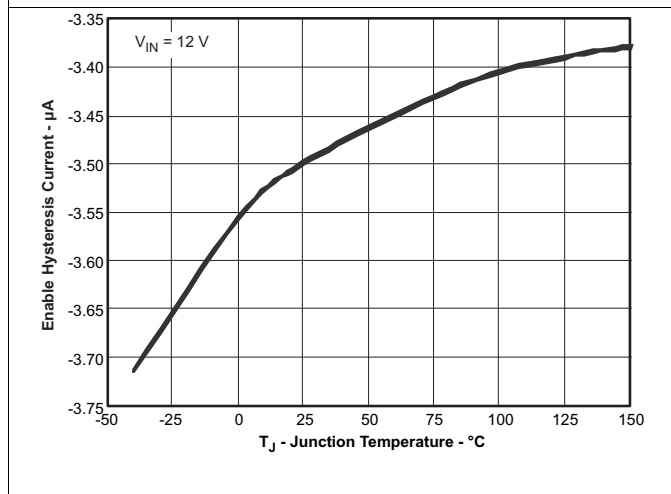

Figure 9. Enable Pin Hysteresis Current vs Temperature

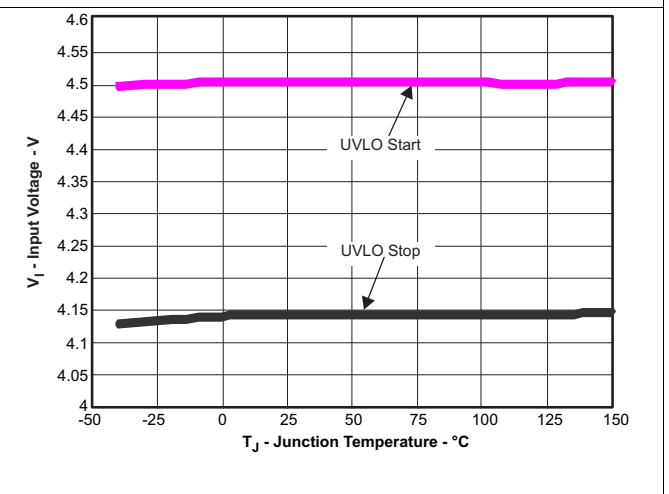

Figure 10. Input Voltage (UVLO) vs Temperature

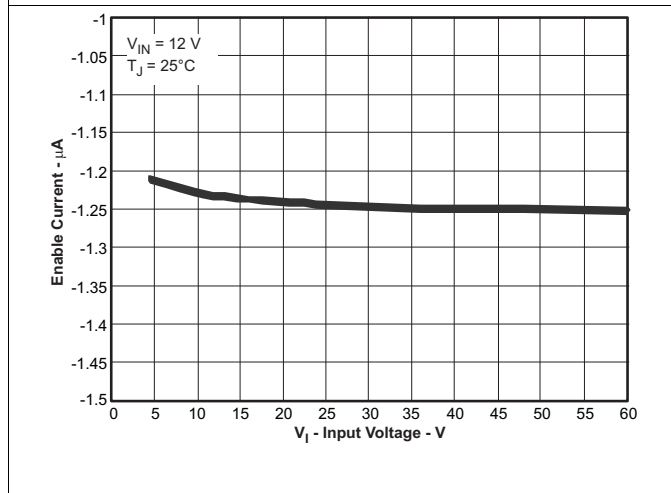

Figure 11. Enable Pin Pullup Current vs Input Voltage

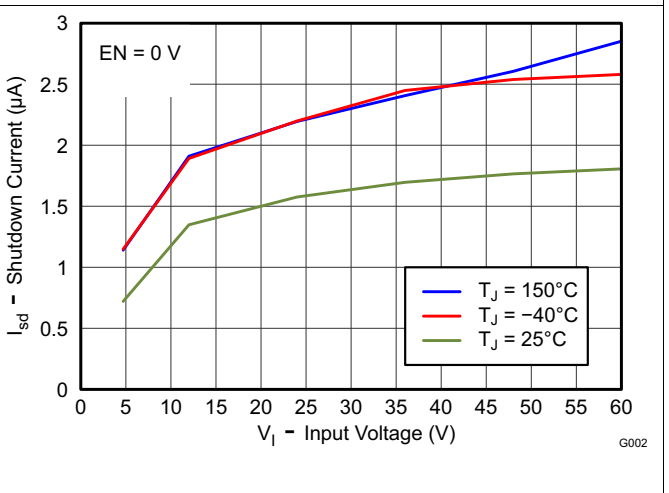

Figure 12. Shutdown Supply Current (VIN) vs Input Voltage

Typical Characteristics (continued)

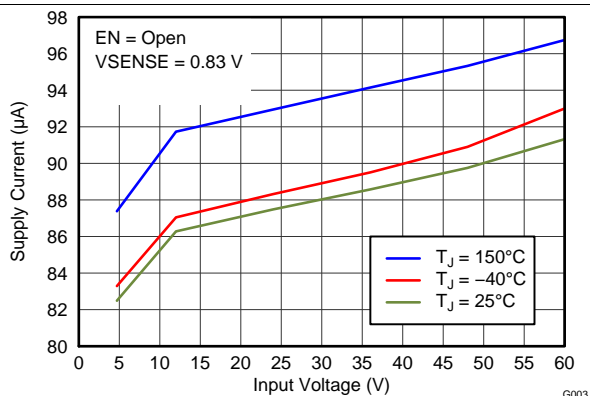

Figure 13. Supply Current (VIN Pin) vs Input Voltage

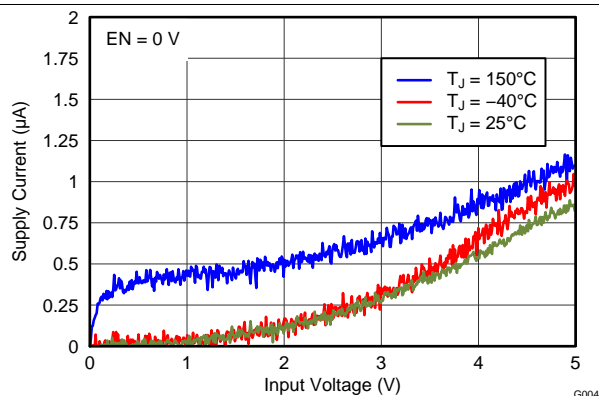

Figure 14. Supply Current (VIN Pin) vs Input Voltage (0 V to V_{START}) En Pin Low

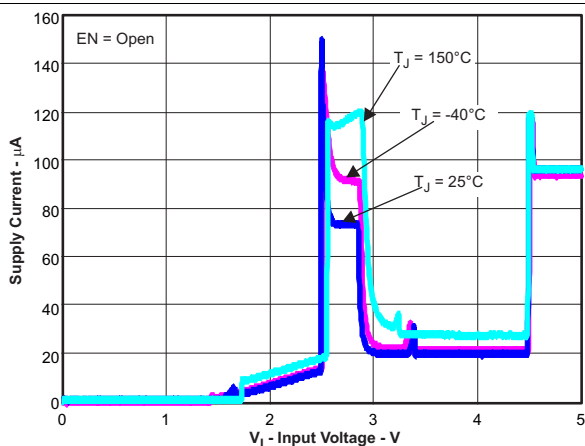

Figure 15. Supply Current (VIN Pin) vs Input Voltage (0 V to V_{START}) En Pin Open

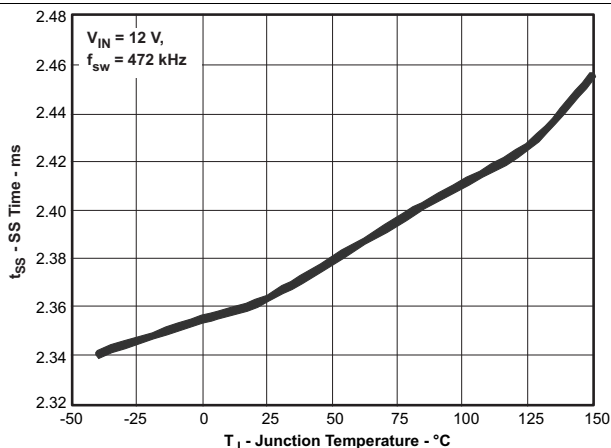

Figure 16. Slow-Start Time vs Temperature

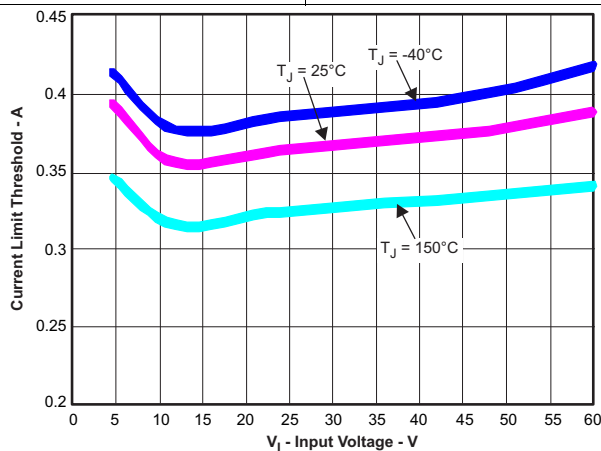

Figure 17. Current Limit vs Input Voltage

7 Detailed Description

7.1 Overview

The TPS54061 device is a 60-V, 200-mA, step-down (buck) regulator with an integrated high-side and low-side n-channel MOSFET. To improve performance during line and load transients the device implements a constant frequency, current mode control which reduces output capacitance and simplifies external frequency compensation design.

The switching frequency of 50 kHz to 1100 kHz allows for efficiency and size optimization when selecting the output filter components. The switching frequency is adjusted using a resistor-to-ground on the RT/CLK pin. The device has an internal phase-lock loop (PLL) on the RT/CLK pin that is used to synchronize the power switch turn on to a falling edge of an external system clock.

The TPS54061 has a default startup voltage of approximately 4.5 V. The EN pin has an internal pullup current source that can be used to adjust the input voltage UVLO threshold with two external resistors. In addition, the pullup current provides a default condition. When the EN pin is floating the device will operate. The operating current is 90 μ A when not switching and under no load. When the device is disabled, the supply current is 1.4 μ A.

The integrated 1.5- Ω high-side MOSFET and 0.8- Ω low-side MOSFET allows for high-efficiency power supply designs capable of delivering 200 milliamperes of continuous current to a load.

The TPS54061 reduces the external component count by integrating the boot recharge diode. The bias voltage for the integrated high-side MOSFET is supplied by a capacitor on the BOOT to PH pin. The boot capacitor voltage is monitored by an UVLO circuit and will turn the high-side MOSFET off when the boot voltage falls below a preset threshold. The TPS54061 can operate at high duty cycles because of the boot UVLO. The output voltage can be adjusted down to as low as the 0.8-V reference.

The TPS54061 has an internal output OV protection that disables the high-side MOSFET if the output voltage is 109% of the nominal output voltage.

The TPS54061 reduces external component count by integrating the slow-start time using a reference DAC system.

The TPS54061 resets the slow-start times during overload conditions with an overload recovery circuit. The overload recovery circuit will slow start the output from the fault voltage to the nominal regulation voltage once a fault condition is removed. A frequency foldback circuit reduces the switching frequency during startup and overcurrent fault conditions to help control the inductor current.

7.2 Functional Block Diagram

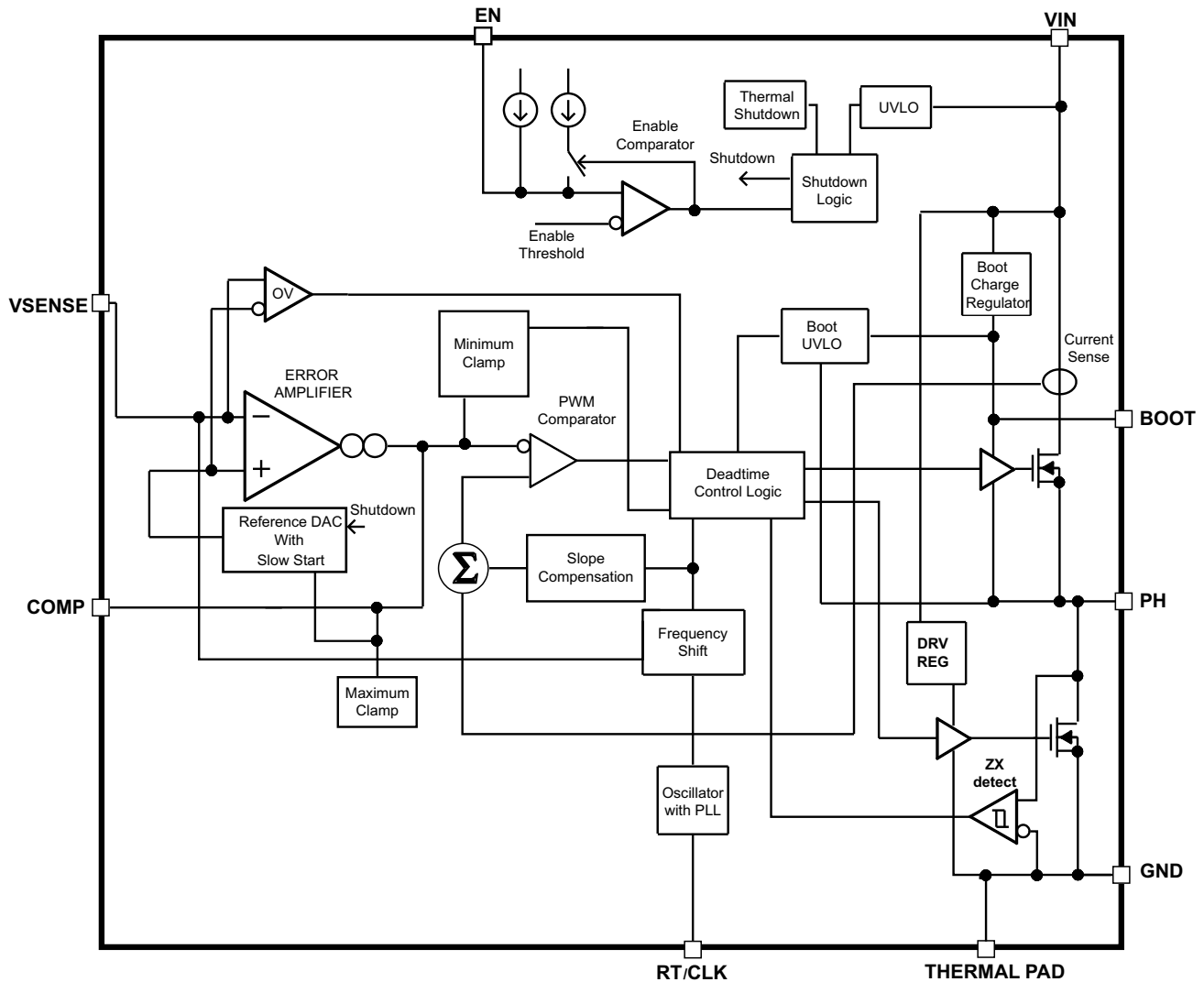

7.3 Feature Description

7.3.1 Fixed Frequency PWM Control

The TPS54061 uses adjustable fixed-frequency, peak-current mode control. The output voltage is sensed through external resistors on the VSENSE pin and compared to an internal voltage reference by an error amplifier which drives the COMP pin. An internal oscillator initiates the turn on of the high-side power switch. The error amplifier output is compared to the high-side power switch current. When the power switch current reaches the level set by the COMP voltage, the power switch is turned off. The COMP pin voltage will increase and decrease as the output current increases and decreases. The device implements current limiting by clamping the COMP pin voltage to a maximum level.

7.3.2 Slope Compensation Output Current

The TPS54061 adds a compensating ramp to the switch current signal. This slope compensation prevents sub-harmonic oscillations.

Feature Description (continued)

7.3.3 Error Amplifier

The TPS54061 uses a transconductance amplifier for the error amplifier. The error amplifier compares the VSENSE voltage to the lower of the internal slow-start voltage or the internal 0.8-V voltage reference. The transconductance (gm) of the error amplifier is 108 $\mu\text{A}/\text{V}$ during normal operation. During the slow-start operation, the transconductance is a fraction of the normal operating gm. The frequency compensation components (capacitor, series resistor and capacitor) are added to the COMP pin-to-ground.

7.3.4 Voltage Reference

The voltage reference system produces a precise voltage reference over temperature by scaling the output of a temperature stable band-gap circuit

7.3.5 Adjusting the Output Voltage

The output voltage is set with a resistor divider from the output node to the VSENSE pin. TI recommends using 1% tolerance or better divider resistors. Start with a 10-k Ω for the R_{LS} resistor and use the Equation 1 to calculate R_{HS} .

$$R_{HS} = R_{LS} \times \left(\frac{V_{OUT} - 0.8 \text{ V}}{0.8 \text{ V}} \right) \quad (1)$$

7.3.6 Enable and Adjusting UVLO

The TPS54061 is enabled when the VIN pin voltage rises above 4.5 V and the EN pin voltage exceeds the EN rising threshold of 1.23 V. The EN pin has an internal pullup current source, I1, of 1.2 μA that provides the default enabled condition when the EN pin floats.

If an application requires a higher input UVLO threshold, use the circuit shown in Figure 18 to adjust the input voltage UVLO with two external resistors. When the EN pin voltage exceeds 1.23 V, an additional 3.5 μA of hysteresis current, I_{hys} , is sourced out of the EN pin. When the EN pin is pulled below 1.18 V, the 3.5- μA I_{hys} current is removed. This additional current facilitates adjustable input voltage hysteresis. Use Equation 2 to calculate R_{UVLO1} for the desired input start and stop voltages. Use Equation 3 to similarly calculate R_{UVLO2} .

In applications designed to start at relatively low input voltages (for example, from 4.7 V to 10 V) and withstand high input voltages (for example, from 40 V to 60 V), the EN pin may experience a voltage greater than the absolute maximum voltage of 8 V during the high input voltage condition. TI recommends using a zener diode to clamp the pin voltage below the absolute maximum rating.

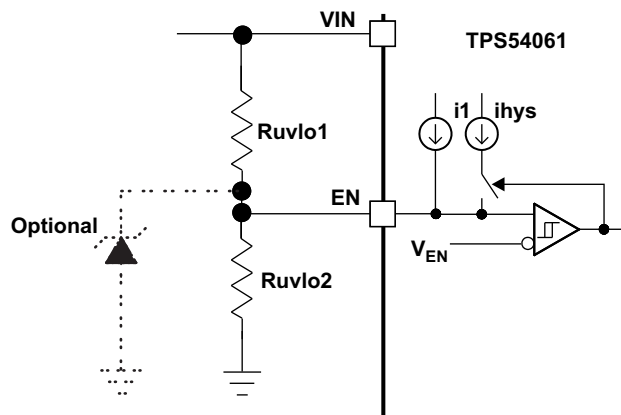

Figure 18. Adjustable Undervoltage Lock-Out

$$R_{UVLO1} = \frac{V_{START} \left(\frac{V_{ENAFALLING}}{V_{ENARISING}} \right) - V_{STOP}}{I1 \times \left(1 - \frac{V_{ENAFALLING}}{V_{ENARISING}} \right) + I_{HYS}} \quad (2)$$

Feature Description (continued)

$$R_{UVLO2} = \frac{R_{UVLO1} \times V_{ENAFALLING}}{V_{STOP} - V_{ENAFALLING} + R_{UVLO1} \times (I_1 + I_{HYS})} \quad (3)$$

7.3.7 Internal Slow-Start

The TPS54061 has an internal digital slow-start that ramps the reference voltage from zero volts to its final value in 1114 switching cycles. The internal slow-start time is calculated by the following expression:

$$t_{ss}(\text{ms}) = \frac{1114}{f_{SW}(\text{kHz})} \quad (4)$$

If the EN pin is pulled below the stop threshold of 1.18 V, switching stops and the internal slow-start resets. The slow-start also resets in thermal shutdown.

7.3.8 Constant Switching Frequency and Timing Resistor (RT/CLK Pin)

The switching frequency of the TPS54061 is adjustable over a wide range from 50 kHz to 1100 kHz by varying the resistor on the RT/CLK pin. The RT/CLK pin voltage is typically 0.53 V and must have a resistor-to-ground to set the switching frequency. To determine the timing resistance for a given switching frequency, use [Equation 5](#). To reduce the solution size, one would typically set the switching frequency as high as possible, but tradeoffs of the supply efficiency, maximum input voltage and minimum controllable on-time should be considered. The minimum controllable on-time is typically 120 ns and limits the operating frequency for high input voltages. The maximum switching frequency is also limited by the frequency shift circuit. More discussion on the details of the maximum switching frequency is located below.

$$R_T(\text{k}\Omega) = \frac{71657}{f_{SW}(\text{kHz})^{1.039}} \quad (5)$$

7.3.9 Selecting the Switching Frequency

The TPS54061 implements current-mode control which uses the COMP pin voltage to turn off the high-side MOSFET on a cycle-by-cycle basis. Each cycle the switch current and COMP pin voltage are compared, when the peak switch current intersects the COMP voltage, the high-side switch is turned off. During overcurrent conditions that pull the output voltage low, the error amplifier will respond by driving the COMP pin high, increasing the switch current. The error amplifier output is clamped internally, which functions as a switch current limit.

To enable higher switching frequency at high input voltages, the TPS54061 implements a frequency shift. The switching frequency is divided by 8, 4, 2, and 1 as the voltage ramps from 0 to 0.8 volts on VSENSE pin. The device implements a digital frequency shift to enable synchronizing to an external clock during normal startup and fault conditions. Because the device can only divide the switching frequency by 8, there is a maximum input voltage limit in which the device operates and still have frequency shift protection. During short-circuit events (particularly with high input voltage applications), the control loop has a finite minimum controllable on-time and the output has a low voltage. During the switch-on time, the inductor current ramps to the peak current limit because of the high input voltage and minimum on-time. During the switch-off time, the inductor would normally not have enough off-time and output voltage for the inductor to ramp down by the ramp up amount. The frequency shift effectively increases the off-time allowing the current to ramp down.

$$f_{SW}(\text{maxskip}) = \left(\frac{1}{t_{ON}} \right) \times \left(\frac{V_{OUT} + R_{LS} \times I_O + R_{DC} \times I_O}{V_{IN} - I_O \times R_{HS} + I_O \times R_{LS}} \right) \quad (6)$$

$$f_{SW}(\text{shift}) = \left(\frac{f_{div}}{t_{ON}} \right) \times \left(\frac{V_{OUTSC} + R_{LS} \times I_{CL} + R_{DC} \times I_{CL}}{V_{IN} - I_{CL} \times R_{HS} + I_{CL} \times R_{LS}} \right)$$

Where

- I_O = Output current
- I_{CL} = Current Limit
- V_{IN} = Input Voltage
- V_{OUT} = Output Voltage

Feature Description (continued)

- V_{OUTSC} Output Voltage during short
- R_{DC} = Inductor resistance
- R_{HS} = High-side MOSFET resistance
- R_{LS} = Low-side MOSFET resistance
- t_{on} = Controllable on-time
- f_{div} = Frequency divide (equals 1, 2, 4, or 8)

(7)

7.3.10 Synchronization to RT/CLK Pin

The RT/CLK pin can be used to synchronize the regulator to an external system clock. To implement the synchronization feature connect a square wave to the RT/CLK pin through one of the circuit networks shown in Figure 19. The square-wave amplitude must extend lower than 0.5 V and higher than 1.8 V on the RT/CLK pin and have high and low states greater than 40 ns. The synchronization frequency range is 300 kHz to 1100 kHz. The rising edge of the PH will be synchronized to the falling edge of RT/CLK pin signal. The external synchronization circuit should be designed in such a way that the device will have the default frequency set resistor connected from the RT/CLK pin-to-ground should the synchronization signal turn off. TI recommends using a frequency set resistor connected as shown in Figure 19 through another resistor-to-ground (e.g., 50 Ω) for clock signal that are not Hi-Z or tristate during the off state. The sum of the resistance should set the switching frequency close to the external CLK frequency. TI recommends to AC couple the synchronization signal through a 10-pF ceramic capacitor to RT/CLK pin. The first time the CLK is pulled above the CLK threshold the device switches from the RT resistor frequency to PLL mode. The internal 0.5 V voltage source is removed and the CLK pin becomes high impedance as the PLL starts to lock onto the external signal. The switching frequency can be higher or lower than the frequency set with the RT/CLK resistor. The device transitions from the resistor mode to the PLL mode and lock onto the CLK frequency within 100 microseconds. When the device transitions from the PLL mode to the resistor mode, the switching frequency will reduce from the external CLK frequency to 150 kHz, then reapply the 0.5-V voltage source and the resistor will then set the switching frequency. The switching frequency is divided by 8, 4, 2, and 1 as the voltage ramps from 0 to 0.8 volts on VSENSE pin. The device implements a digital frequency shift to enable synchronizing to an external clock during normal startup and fault conditions.

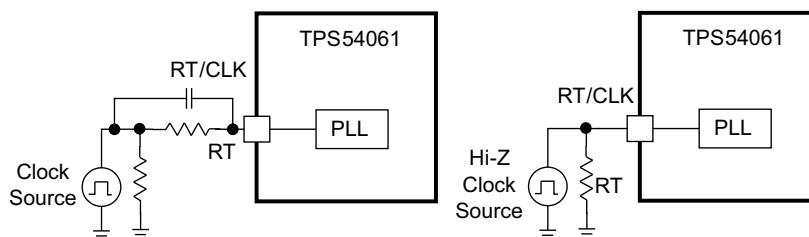

Figure 19. Synchronizing to a System Clock

7.3.11 Overvoltage Protection

The TPS54061 incorporates an output overvoltage transient protection (OVP) circuit to minimize voltage overshoot when recovering from output fault conditions or strong unload transients on power supply designs with low-value output capacitance. For example, when the power supply output is overloaded the error amplifier compares the actual output voltage to the internal reference voltage. If the VSENSE pin voltage is lower than the internal reference voltage for a considerable time, the output of the error amplifier will respond by clamping the error amplifier output to a high voltage. Thus, requesting the maximum output current. Once the condition is removed, the regulator output rises and the error amplifier output transitions to the steady-state duty cycle. In some applications, the power supply output voltage can respond faster than the error amplifier output can respond, this actuality leads to the possibility of an output overshoot.

The OVP feature minimizes the output overshoot when using a low-value output capacitor by comparing the VSENSE pin voltage to OVP threshold which is 109% of the internal voltage reference. If the VSENSE pin voltage is greater than the OVP threshold, the high-side MOSFET is disabled to minimize output overshoot. When the VSENSE voltage drops lower than the OVP threshold, the high-side MOSFET resumes normal operation.

Feature Description (continued)

7.3.12 Thermal Shutdown

The device implements an internal thermal shutdown until the junction temperature exceeds 176°C. The thermal shutdown forces the device to stop switching until the junction temperature falls below the thermal trip threshold. Once the die temperature decreases below 176°C, the device reinitiates the power-up sequence by restarting the internal slow-start.

7.4 Device Functional Modes

7.4.1 Operation Near Minimum Input Voltage

The TPS54061 is recommended to operate with input voltages above 4.7 V. The typical VIN UVLO threshold is 4.5 V and the device may operate at input voltages down to the UVLO voltage. At input voltages below the actual UVLO voltage the device will not switch. If EN is floating or externally pulled up to greater up than the typical 1.23 V rising threshold, when $V_{(VIN)}$ passes the UVLO threshold the TPS54061 will become active. Switching is enabled and the slow-start sequence is initiated. The TPS54061 starts linearly ramping up the internal reference DAC from 0 V to the reference voltage over the internal slow-start time period set by the switching frequency.

7.4.2 Operation With Enable Control

The enable start threshold voltage is 1.23 V typical. With EN held below the 1.23 V typical rising threshold voltage the TPS54061 is disabled and switching is inhibited even if VIN is above its UVLO threshold. The quiescent current is reduced in this state. If the EN voltage is increased above the rising threshold voltage while $V_{(VIN)}$ is above the UVLO threshold, the device becomes active. Switching is enabled and the slow-start sequence is initiated. The TPS54061 starts linearly ramping up the internal reference DAC from 0 V to the reference voltage over the internal slow-start time period set by the switching frequency. If EN is pulled below the 1.18 V typical falling threshold the TPS54061 will enter the reduced quiescent current state again.

8 Application and Implementation

NOTE

Information in the following applications sections is not part of the TI component specification, and TI does not warrant its accuracy or completeness. TI's customers are responsible for determining suitability of components for their purposes. Customers should validate and test their design implementation to confirm system functionality.

8.1 Application Information

The TPS54061 is a 60-V, 200-mA step-down regulator with an integrated high-side and low-side MOSFET. This device is typically used to convert a higher DC voltage to a lower DC voltage with a maximum available output current of 200 mA. Example applications are: Low-Power Standby or Bias Voltage Supplies, 4-20 mA Current Loop Powered Sensors, Industrial Process Control, Metering, and Security Systems or an efficient high voltage linear regulator replacement. Use the following design procedure to select component values for the TPS54061. This procedure illustrates the design of a high-frequency switching regulator. These calculations can be done with the aid of the excel spreadsheet tool [SLVC431](#). Alternatively, use the WEBENCH software to generate a complete design. The WEBENCH software uses an iterative design procedure and accesses a comprehensive database of components when generating a design.

8.2 Typical Applications

8.2.1 CCM Application

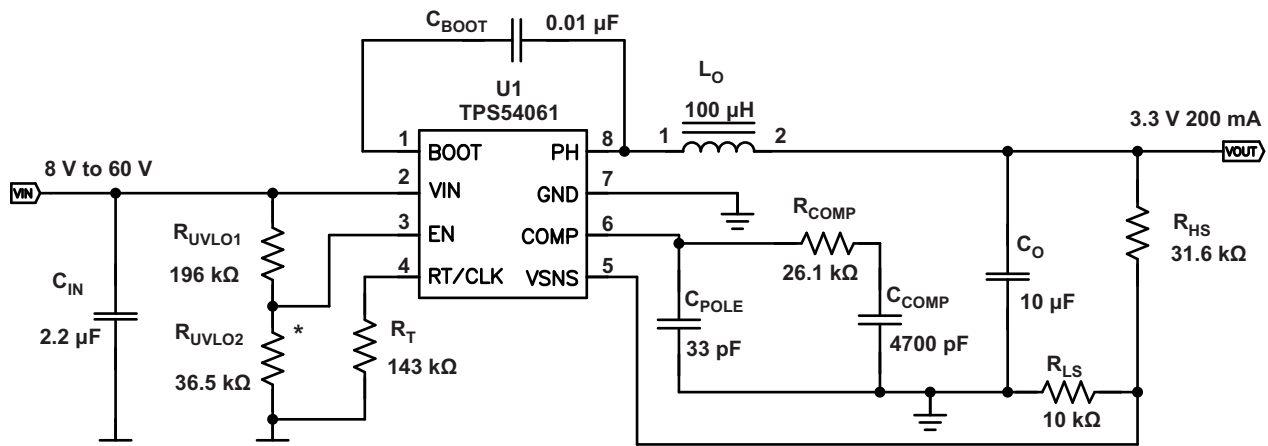

* See [Enable and Adjusting Undervoltage Lockout](#) section

Figure 20. CCM Application Schematic

8.2.1.1 Design Requirements

This example details the design of a continuous conduction mode (CCM) switching regulator design using ceramic output capacitors. If a low-output current design is needed, see [DCM Application](#). A few parameters must be known in order to start the design process. These parameters are typically determined at the system level. For this example, we will start with the following known parameters:

Table 1. Design Parameters

PARAMETERS	VALUES
Output Voltage	5.0 V
Transient Response 50 to 150mA load step	$\Delta V_{OUT} = 4\%$
Maximum Output Current	200 mA
Input Voltage	24 V nom. 8 V to 60 V
Output Voltage Ripple	0.5% of V_{OUT}

Typical Applications (continued)

Table 1. Design Parameters (continued)

PARAMETERS	VALUES
Start Input Voltage (rising VIN)	7.50 V
Stop Input Voltage (falling VIN)	6.50 V

8.2.1.2 Detailed Design Procedure

8.2.1.2.1 Selecting the Switching Frequency

The first step is to decide on a switching frequency for the regulator. Typically, the user will want to choose the highest switching frequency possible because this will produce the smallest solution size. The high switching frequency allows for lower valued inductors and smaller output capacitors compared to a power supply that switches at a lower frequency. The switching frequency is limited by the minimum on-time of the internal power switch, the maximum input voltage, the output voltage and the frequency shift limitation.

[Equation 6](#) and [Equation 7](#) must be used to find the maximum switching frequency for the regulator, choose the lower value of the two results. Switching frequencies higher than these values will result in pulse skipping or a lack of overcurrent protection during short circuit conditions. The typical minimum on-time, $t_{on,min}$, is 120 ns for the TPS54061. To ensure overcurrent runaway does not occur during short circuits in your design, use [Equation 7](#) to determine the maximum switching frequency. With a maximum input voltage of 60 V, inductor resistance of 0.77 Ω , high-side switch resistance of 3.0 Ω , low-side switch resistance of 1.5 Ω , a current limit value of 350 mA and a short circuit output voltage of 0.1 V, the maximum switching frequency is 524 kHz and 1003 kHz in each case respectively. A switching frequency of 400 kHz is used. To determine the timing resistance for a given switching frequency, use [Equation 5](#). The switching frequency is set by resistor R_T shown in [Figure 20](#). R_T is calculated to be 142 k Ω . A standard value of 143 k Ω is used.

8.2.1.2.2 Output Inductor Selection (L_O)

To calculate the minimum value of the output inductor, use [Equation 8](#). $KIND$ is a coefficient that represents the amount of inductor ripple current relative to the maximum output current. The inductor ripple current will be filtered by the output capacitor. Therefore, choosing high inductor ripple currents will impact the selection of the output capacitor because the output capacitor must have a ripple current rating equal to or greater than the inductor ripple current. In general, the inductor ripple value is at the discretion of the designer; however, the following guidelines may be used. Typically it is recommended to use $KIND$ values in the range of 0.2 to 0.4; however, for designs using low-ESR output capacitors such as ceramics and low output currents, a $KIND$ value as high as 1 may be used. In a wide input voltage regulator, it is best to choose an inductor ripple current on the larger side. This allows the inductor to still have a measurable ripple current with the input voltage at its minimum. For this design example, use $KIND$ of 0.4 and the minimum inductor value is calculated to be 97 μ H. For this design, a standard 100 μ H value was chosen. It is important that the RMS current and saturation current ratings of the inductor not be exceeded. The RMS and peak inductor current can be found from [Equation 10](#) and [Equation 11](#).

For this design, the RMS inductor current is 200 mA and the peak inductor current is 239 mA. The chosen inductor is a Würth 74408943101. It has a saturation current rating of 680 mA and an RMS current rating of 520 mA. As the equation set demonstrates, lower ripple currents will reduce the output voltage ripple of the regulator but will require a larger value of inductance. Selecting higher ripple currents will increase the output voltage ripple of the regulator but allow for a lower inductance value. The current flowing through the inductor is the inductor ripple current plus the average output current. During power-up, faults or transient load conditions, the inductor current can increase above the peak inductor current level calculated above. In transient conditions, the inductor current can increase up to the switch current limit of the device. For this reason, the most conservative approach is to specify an inductor with a saturation current rating equal to or greater than the switch current limit rather than the calculated peak inductor current.

$$L_O \min \geq \frac{V_{IN \max} - V_{OUT}}{KIND \times I_O} \times \frac{V_{OUT}}{V_{IN \max} \times f_{sw}} \quad (8)$$

$$I_{RIPPLE} \geq \frac{V_{OUT} \times (V_{IN \max} - V_{OUT})}{V_{IN \max} \times L_O \times f_{sw}} \quad (9)$$

$$I_{L\text{rms}} = \sqrt{I_O^2 + \frac{1}{12} \times \left(\frac{V_{\text{OUT}} \times (V_{\text{INmax}} - V_{\text{OUT}})}{V_{\text{INmax}} \times L_O \times f_{\text{SW}}} \right)^2} \quad (10)$$

$$I_{L\text{peak}} = I_{\text{OUT}} + \frac{I_{\text{RIPPLE}}}{2} \quad (11)$$

8.2.1.2.3 Output Capacitor

There are three primary considerations for selecting the value of the output capacitor. The output capacitor will determine the modulator pole, the output voltage ripple, and how the regulator responds to a large change in load current. The output capacitance needs to be selected based on the most stringent of these three criteria. The desired response to a large change in the load current is the first criteria. The output capacitor needs to supply the load with current until the regulator increases the inductor current. This situation would occur if there are desired hold-up times for the regulator where the output capacitor must hold the output voltage above a certain level for a specified amount of time after the input power is removed. The regulator also will temporarily not be able to supply sufficient output current if there is a large, fast increase in the current needs of the load such as transitioning from no load to a full load. The regulator usually needs two or more clock cycles for the control loop to see the change in load current and output voltage and adjust the duty cycle to react to the change. The output capacitor must be sized to supply the extra current to the load until the control loop responds to the load change. The output capacitance must be large enough to supply the difference in current for 2 clock cycles while only allowing a tolerable amount of droop in the output voltage. Equation 15 shows the minimum output capacitance necessary to accomplish this, where ΔI_{OUT} is the change in output current, f_{SW} is the regulators switching frequency and ΔV_{out} is the allowable change in the output voltage.

For this example, the transient load response is specified as a 4% change in V_{out} for a load step from 50 mA to 150 mA. For this example, $\Delta I_{\text{OUT}} = 0.150 - 0.05 = 0.10$ and $\Delta V_{\text{OUT}} = 0.04 \times 3.3 = 0.132$.

Using these values gives a minimum capacitance of 3.79 μF . This does not take the ESR of the output capacitor into account in the output voltage change. For ceramic capacitors, the ESR is usually small enough to ignore in this calculation. Aluminum electrolytic and tantalum capacitors have higher ESR that should be taken into account.

The low side FET of the regulator emulates a diode so it can not sink current so any stored energy in the inductor will produce an output voltage overshoot when the load current rapidly decreases, as in Figure 28. The output capacitor must also be sized to absorb energy stored in the inductor when transitioning from a high load current to a lower load current. The excess energy that gets stored in the output capacitor will increase the voltage on the capacitor. The capacitor must be sized to maintain the desired output voltage during these transient periods. Equation 14 is used to calculate the minimum capacitance input the output voltage overshoot to a desired value, where L_O is the value of the inductor, I_{OH} is the output current under heavy load, I_{OL} is the output under light load, $V_{\text{O}} + \Delta V_{\text{O}}$ is the final peak output voltage, and V_i is the initial capacitor voltage. For this example, the worst case load step will be from 150 mA to 50 mA. The output voltage will increase during this load transition and must be limited to 4% of the output voltage to satisfy the design goal. This will make $V_{\text{O}} + \Delta V_{\text{O}} = 1.04 \times 3.3 = 3.432$ V. V_{O} is the initial capacitor voltage which is the nominal output voltage of 3.3 V. Using these numbers in Equation 14 yields a minimum capacitance of 2.25 μF .

Equation 13 calculates the minimum output capacitance needed to meet the output voltage ripple specification, where f_{SW} is the switching frequency, V_{ripple} is the maximum allowable output voltage ripple, and I_{ripple} is the inductor ripple current. Equation 13 yields 1.48 μF . Equation 16 calculates the maximum ESR an output capacitor can have to meet the output voltage ripple specification. Equation 16 indicates the ESR should be less than 0.160 Ω .

The most stringent criteria for the output capacitor is 3.79 μF of capacitance to maintain the output voltage regulation during an load transient.

Additional capacitance de-ratings for aging, temperature and DC bias will increase this minimum value. For this example, a 10- μF , 10-V X5R ceramic capacitor with 0.003 Ω of ESR in a 1206 package is used.

Capacitors generally have limits to the amount of ripple current they can handle without failing or producing excess heat. An output capacitor that can support the inductor ripple current must be specified. Some capacitor data sheets specify the Root Mean Square (RMS) value of the maximum ripple current.

Equation 12 can be used to calculate the RMS ripple current the output capacitor needs to support. For this example, Equation 12 yields 10.23 mA.

$$I_{C_{O}rms} = \frac{1}{\sqrt{12}} \times \left(\frac{V_{OUT} \times (V_{INmax} - V_{OUT})}{V_{INmax} \times L_O \times f_{SW}} \right) \quad (12)$$

$$C_{O1} \geq \frac{I_{RIPPLE}}{V_{RIPPLE}} \times \left(\frac{1}{8 \times f_{SW}} \right) \quad (13)$$

$$C_{O2} \geq L_O \times \frac{I_{OH}^2 - I_{OL}^2}{(V_{OUT} + \Delta V_{OUT})^2 - V_{OUT}^2} \quad (14)$$

$$C_{O3} \geq \frac{\Delta I_{OUT}}{\Delta V_{OUT}} \times \frac{2}{f_{SW}} \quad (15)$$

$$R_C \leq \frac{V_{RIPPLE}}{I_{RIPPLE}} \quad (16)$$

8.2.1.2.4 Input Capacitor

The TPS54061 requires a high-quality ceramic, type X5R or X7R, input decoupling capacitor of at least 1 μ F of effective capacitance. The effective capacitance includes any deration for DC bias effects. The voltage rating of the input capacitor must be greater than the maximum input voltage. The capacitor must also have an RMS current rating greater than the maximum RMS input current. The input RMS current can be calculated using [Equation 17](#). The value of a ceramic capacitor varies significantly over temperature and the dc bias applied to the capacitor. The capacitance variations with temperature can be minimized by selecting a dielectric material that is stable over temperature. X5R and X7R ceramic dielectrics are usually selected for power regulator capacitors because they have a high capacitance to volume ratio and are fairly stable over temperature. The effective value of a capacitor decreases as the DC bias across a capacitor increases. For this example design, a ceramic capacitor with at least a 60-V voltage rating is required to support the maximum input voltage. The input capacitance value determines the input ripple voltage of the regulator. The input voltage ripple can be calculated by rearranging [Equation 18](#).

Using the design example values, $I_{OUTmax} = 200$ mA, $C_{IN} = 2.2$ μ F, $f_{SW} = 400$ kHz, yields an input voltage ripple of 56.8 mV and an RMS input ripple current of 98.5 mA.

$$I_{C_{IN}rms} = I_{OUT} \times \sqrt{\frac{V_{OUT}}{V_{INmin}}} \times \frac{(V_{INmin} - V_{OUT})}{V_{INmin}} \quad (17)$$

$$C_{IN} \geq \frac{I_o}{V_{INripple}} \times \left(\frac{0.25}{f_{SW}} \right) \quad (18)$$

8.2.1.2.5 Bootstrap Capacitor Selection

A 0.01- μ F ceramic capacitor must be connected between the BOOT and PH pins for proper operation. TI recommends using a ceramic capacitor with X5R or better grade dielectric. The capacitor should have 10 V or higher voltage rating.

8.2.1.2.6 UVLO Set Point

The UVLO can be adjusted using an external voltage divider on the EN pin of the TPS54061. The UVLO has two thresholds, one for power-up when the input voltage is rising and one for power-down or brown outs when the input voltage is falling. For the example design, the supply should turn on and start switching once the input voltage increases above 7.50 V (enabled). After the regulator starts switching, it should continue to do so until the input voltage falls below 6.50 V (UVLO stop). The programmable UVLO and enable voltages are set by connecting resistor divider between Vin and ground to the EN pin. [Equation 2](#) and [Equation 3](#) can be used to calculate the resistance values necessary. For example, a 196-k Ω resistor between Vin and EN and a 36.5-k Ω resistor between EN and ground are required to produce the 7.50 and 6.50 volt start and stop voltages. See the [Enable and Adjusting Undervoltage Lockout](#) section for additional considerations in high input voltage applications.

8.2.1.2.7 Output Voltage and Feedback Resistors Selection

For the example design, 10 kΩ was selected for R_{LS}. Using [Equation 1](#), R_{HS} is calculated as 31.46 kΩ. The nearest standard 1% resistor is 31.6 kΩ.

8.2.1.2.8 Closing the Loop

There are several methods used to compensate DC-DC regulators. The method presented here is easy to calculate and ignores the effects of the slope compensation that is internal to the device. Because the slope compensation is ignored, the actual crossover frequency will usually be lower than the crossover frequency used in the calculations. This method assume the crossover frequency is between the modulator pole and the ESR zero and the ESR zero is at least 10 times greater the modulator pole.

To get started, the modulator pole, fpole, and the ESR zero, fzero must be calculated using [Equation 19](#) and [Equation 20](#). For Cout, use a derated value of 6.0 μF. Use [Equation 21](#) and [Equation 22](#), to estimate a starting point for the crossover frequency, fco, to design the compensation. For the example design, fpole is 1015 Hz and fzero is 5584 kHz.

[Equation 21](#) is the geometric mean of the modulator pole and the ESR zero and [Equation 22](#) is the mean of modulator pole and the switching frequency. [Equation 21](#) yields 119.2 kHz and [Equation 22](#) gives 17.9 kHz. Use a frequency near the lower value of [Equation 21](#) or [Equation 22](#) for an initial crossover frequency.

For this example, fco of 17.9 kHz is used. Next, the compensation components are calculated. A resistor in series with a capacitor is used to create a compensating zero. A capacitor in parallel to these two components forms the compensating pole.

To determine the compensation resistor, R_{COMP}, use [Equation 23](#). Assume the power stage transconductance, gm_{ps}, is 1.00 A/V. The output voltage, Vo, reference voltage, V_{REF}, and amplifier transconductance, g_{mea}, are 3.3 V, 0.8 V and 108 μA/V, respectively.

R_{COMP} is calculated to be 25.9 kΩ, use the nearest standard value of 26.1 kΩ. Use [Equation 24](#) to set the compensation zero equal to the modulator pole frequency. [Equation 24](#) yields a 3790 pF for capacitor C_{COMP} and a 4700 pF is chosen. Use the larger value of [Equation 25](#) and [Equation 26](#) to calculate the C_{POLE} value, to set the compensation pole. [Equation 26](#) yields 30.5 pF so the nearest standard of 33 pF is selected.

$$f_{\text{pole}}(\text{Hz}) = \frac{1}{\frac{V_{\text{out}}}{I_{\text{O}}} \times C_{\text{O}} \times 2 \times \pi} \quad (19)$$

$$f_{\text{zero}}(\text{Hz}) = \frac{1}{R_{\text{C}} \times C_{\text{O}} \times 2 \times \pi} \quad (20)$$

$$f_{\text{co1}}(\text{Hz}) = (f_{\text{zero}} \times f_{\text{pole}})^{0.5} \quad (21)$$

$$f_{\text{co2}}(\text{Hz}) = \left(\frac{f_{\text{sw}}}{2} \times f_{\text{pole}} \right)^{0.5} \quad (22)$$

$$R_{\text{COMP}} = \frac{2 \times \pi \times f_{\text{CO}} \times C_{\text{O}}}{g_{\text{mps}}} \times \frac{V_{\text{OUT}}}{V_{\text{REF}} \times g_{\text{mea}}} \quad (23)$$

$$C_5 = \frac{1}{2 \times \pi \times R_4 \times f_{\text{POLE}}} \quad (24)$$

$$C_6 = \frac{R_{\text{C}} \times C_{\text{O}}}{R_4} \quad (25)$$

$$C_6 = \frac{1}{R_4 \times f_{\text{SW}} \times \pi} \quad (26)$$

8.2.1.3 Application Curves

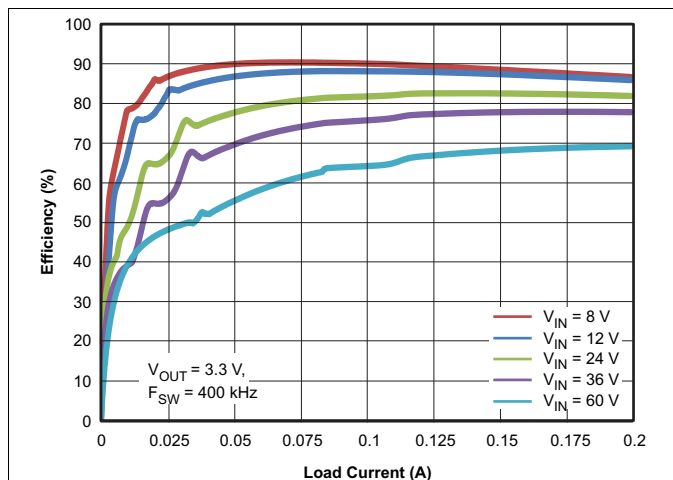

Figure 21. Efficiency vs Output Current

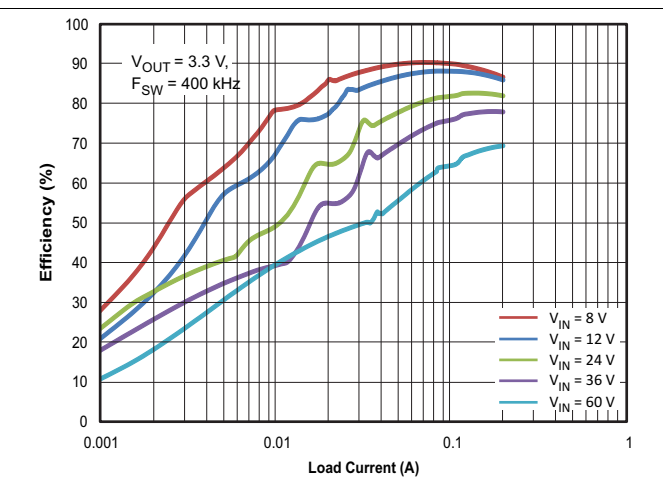

Figure 22. Efficiency vs Output Current

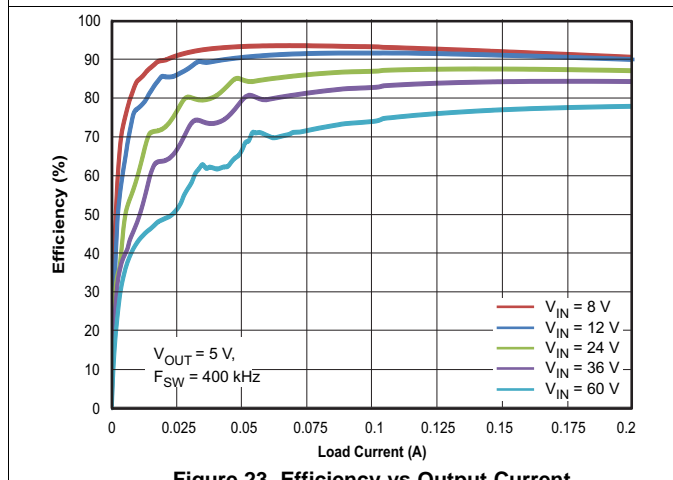

Figure 23. Efficiency vs Output Current

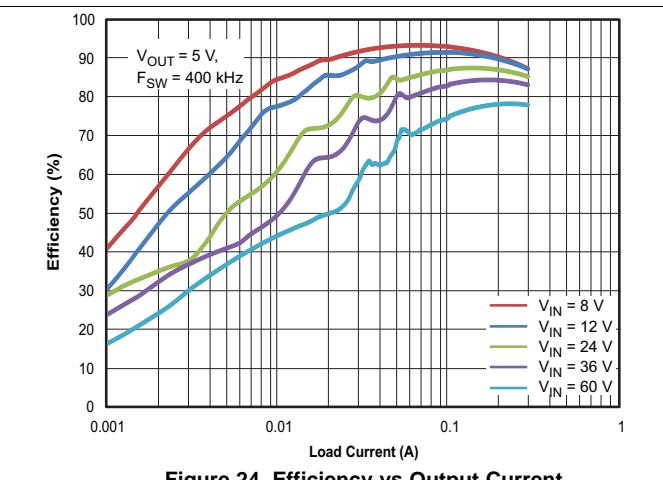

Figure 24. Efficiency vs Output Current

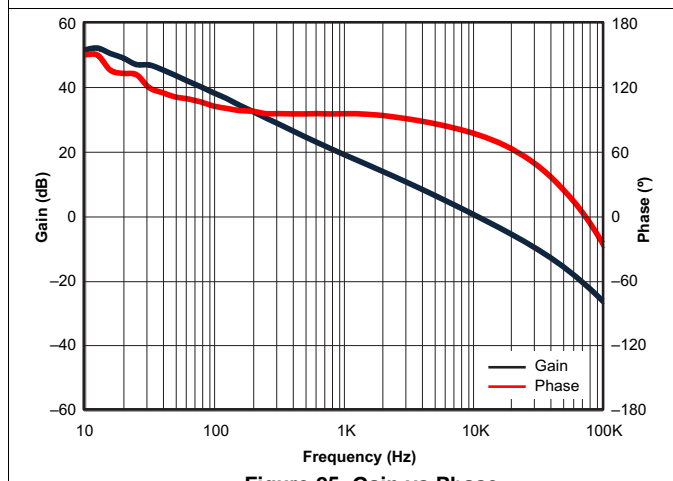

Figure 25. Gain vs Phase

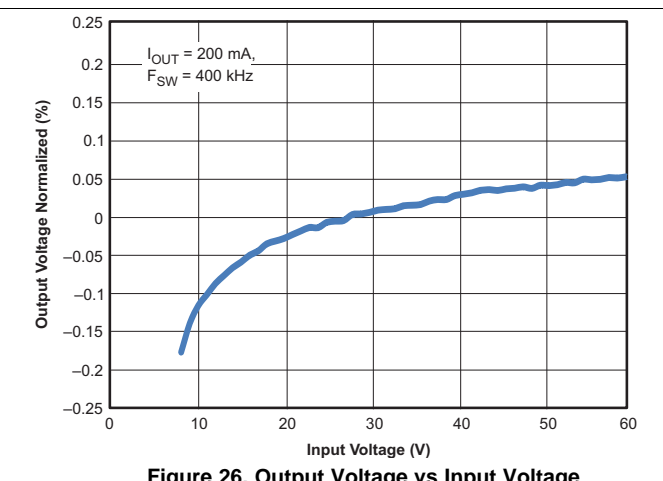

Figure 26. Output Voltage vs Input Voltage

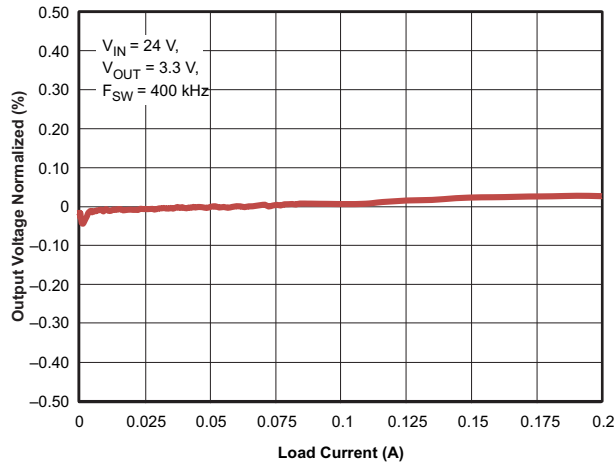

Figure 27. Output Voltage vs Output Current

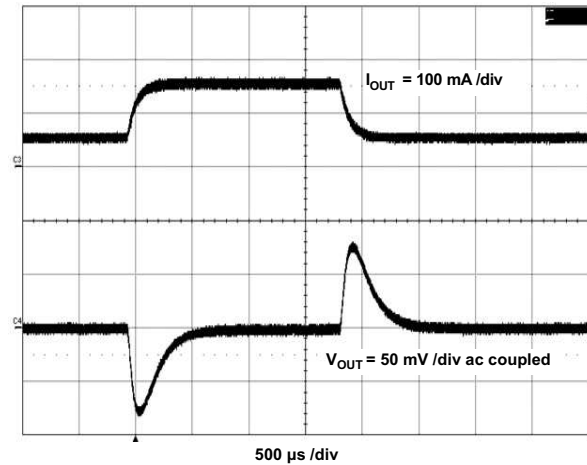

Figure 28. Load Transient

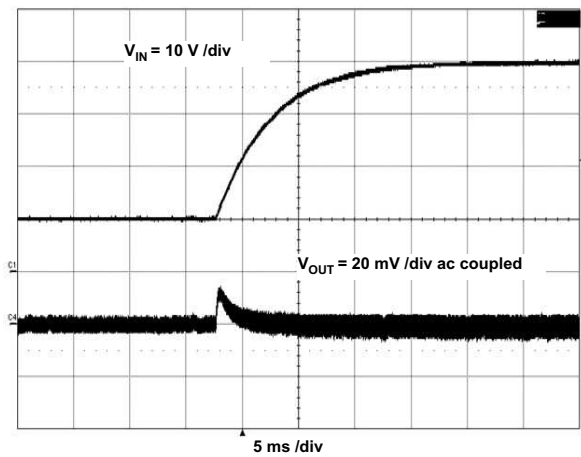

Figure 29. Line Transient

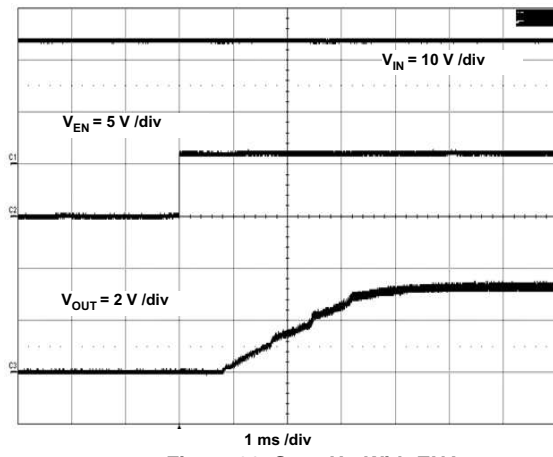

Figure 30. Start-Up With ENA

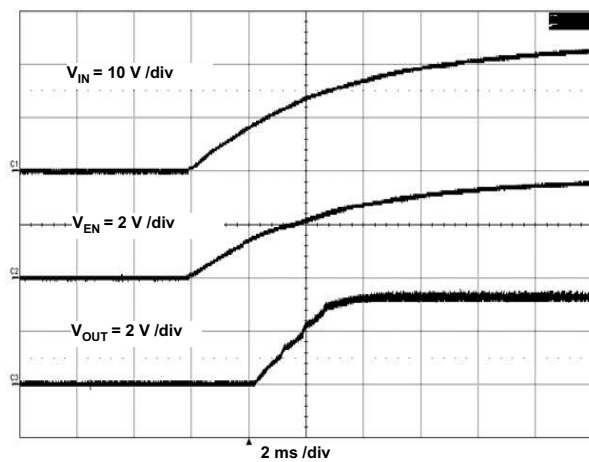

Figure 31. Start-Up With V_{IN}

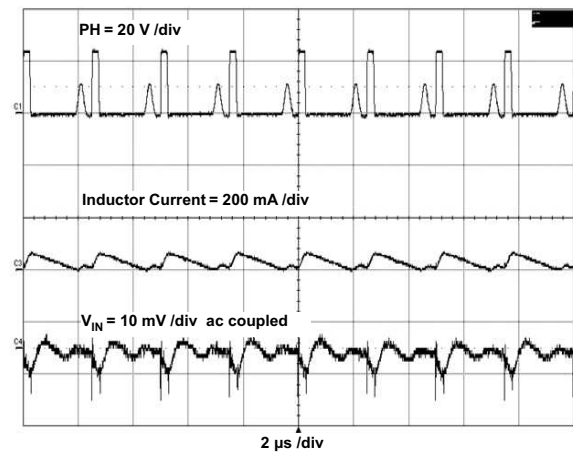

Figure 32. Input Ripple in DCM

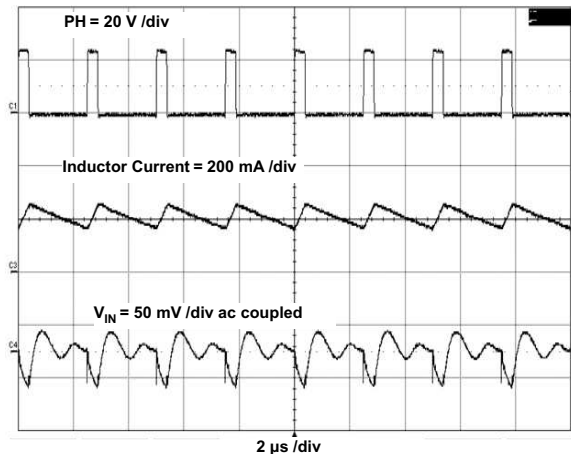

Figure 33. Input Ripple in CCM

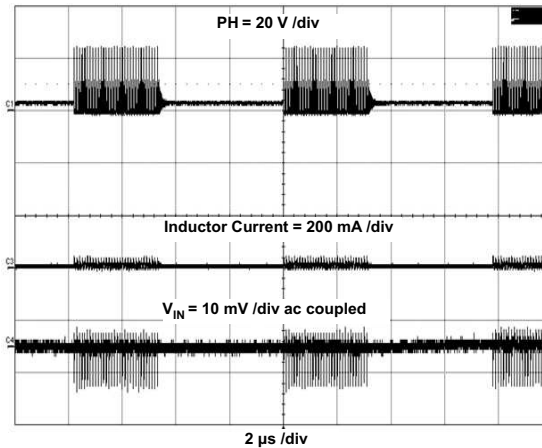

Figure 34. Input Ripple Skip

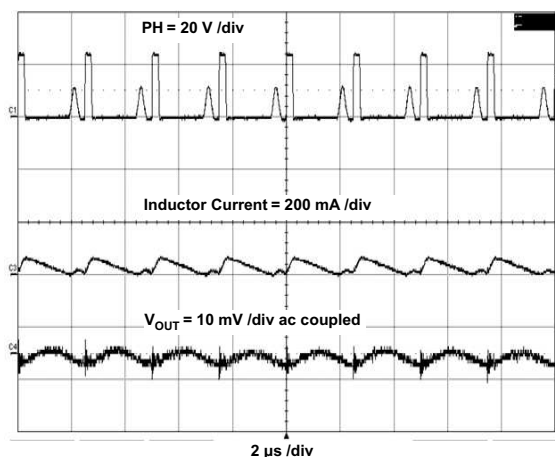

Figure 35. Output Ripple in DCM

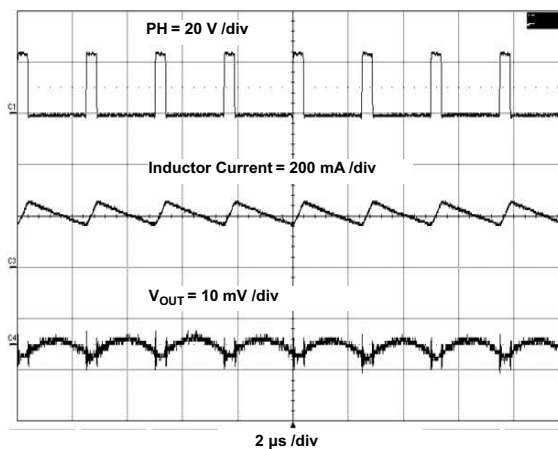

Figure 36. Output Ripple in CCM

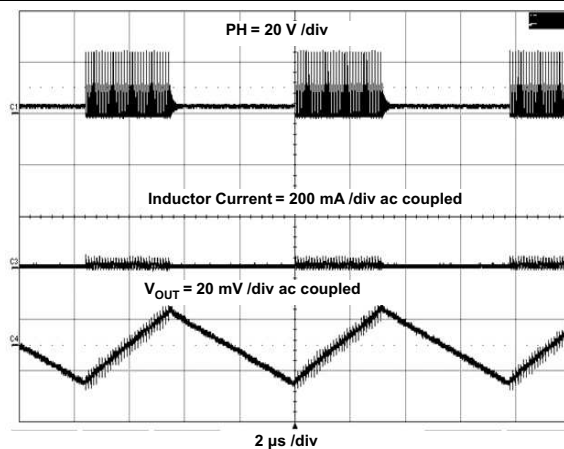

Figure 37. Output Ripple Skip

8.2.2 DCM Application

It is most desirable to have a power supply that is efficient and has a fixed switching frequency at low output currents. A fixed frequency power supply will have a predictable output voltage ripple and noise. Using a traditional continuous conduction mode (CCM) design method to calculate the output inductor will yield a large inductance for a low output current supply. Using a CCM inductor will result in a large sized supply or will affect efficiency from the large dc resistance an alternative is to operate in discontinuous conduction mode (DCM). Use the procedure below to calculate the components values for designing a power supply operating in discontinuous conduction mode. The advantage of operating a power supply in DCM for low output current is the fixed switching frequency, lower output inductance, and lower DC resistance on the inductor. Use the frequency shift and skip equations to estimate the maximum switching frequency.

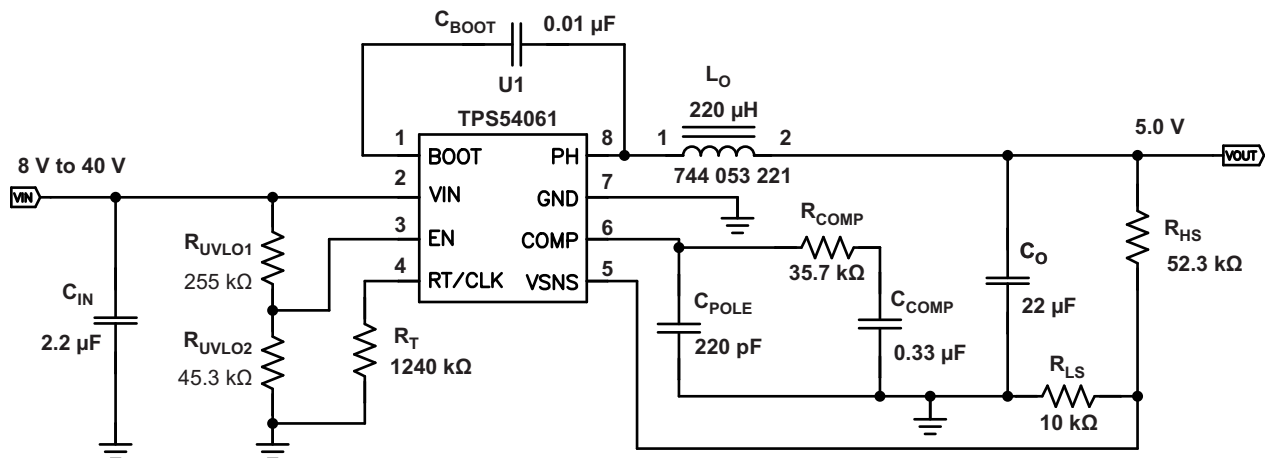

Figure 38. DCM Application Schematic

8.2.2.1 Design Requirements

This example details the design of a low-output current, fixed-switching regulator design using ceramic output capacitors. A few parameters must be known in order to start the design process. These parameters are typically determined at the system level. For this example, we will start with the following known parameters:

Table 2. Design Parameters

DESIGN PARAMETERS	VALUES
Output Voltage	5.0 V
Transient Response 37.5 to 75-mA load step	$\Delta V_{OUT} = 4\%$
Maximum Output Current	75 mA
Minimum Output Current	1 mA
Input Voltage	24 V nom. 8 V to 40 V
Output Voltage Ripple	1 % of V_{OUT}
Switching Frequency	50 kHz
Start Input Voltage (rising VIN)	8 V
Stop Input Voltage (falling VIN)	6.8 V

8.2.2.2 Detailed Design Procedure

8.2.2.2.1 Designing an Efficient, Low-Output Current Power Supply at a Fixed Switching Frequency

The TPS54061 is designed for applications which require a fixed operating frequency and low output voltage ripple at low-output currents, thus, the TPS54061 does not have a pulse skip mode at light loads. Because the device has a minimum controllable on time, there is an output current at which the power supply will pulse skip. To ensure that the supply does not pulse skip at output current of the application the inductor value will need to be selected greater than a minimum value. The minimum inductance needed to maintain a fixed switching

frequency at the minimum load is calculated to be 227 μH using Equation 27. Because the equation is ideal and was derived without losses, assume the minimum controllable light load on time, t_{onmin} , is 180 ns. To maintain DCM operation the inductor value and output current need to stay below a maximum value. The maximum inductance is calculated to be 250 μH using Equation 28. A 744053221 inductor from Würth Elektronik is selected. If CCM operation is necessary, use the previous design procedure.

Use Equation 29, to make sure the minimum current limit on the high-side power switch is not exceeded at the maximum output current. The peak current is calculated as 244 mA and is lower than the 350 mA current limit. To determine the RMS current for the inductor and output capacitor, it is necessary to calculate the duty cycle. The duty cycle, D1, for a step down regulator in DCM is calculated in Equation 30. D1 is the portion of the switching cycle the high side power switch is on, and is calculated to be 0.1345. D2 is the portion of the switching cycle the low-side power switch is on, and is calculated to be 0.5111.

Using the Equation 32 and Equation 33, the RMS current of the inductor and output capacitor are calculated, to be 0.1078 A and 0.0774 A respectively. Select components that ratings exceed the calculated RMS values. Calculate the output capacitance using the Equation 34 to Equation 36 and use the largest value, V_{ripple} is the steady-state voltage ripple and ΔV is voltage change during a transient. A minimum of 7.5- μF capacitance is calculated. Additional capacitance de-ratings for aging, temperature and DC bias should be factored in which increases this minimum value. For this example, a 22- μF 10-V X7R ceramic capacitor with 5-m Ω ESR is used. To have a low-output ripple power supply use a low ESR capacitor. Use Equation 37 to estimate the maximum ESR for the output capacitor. Equation 38 and Equation 39 estimate the RMS current and capacitance for the input capacitor. An RMS current of 38.7 mA and capacitance of 1.56 μF is calculated. A 2.2- μF 100-V/X7R ceramic is used for this example.

$$L_{\text{Omin}} \geq \left(\frac{V_{\text{INmax}} - V_{\text{OUT}}}{V_{\text{OUT}}} \right) \times \left(\frac{V_{\text{INmax}}}{2} \right) \times \frac{t_{\text{onmin}}^2}{I_{\text{Omin}}} \times f_{\text{sw}} \quad (27)$$

$$L_{\text{Omax}} \leq \left(\frac{V_{\text{INmin}} - V_{\text{OUT}}}{2} \right) \times \left(\frac{V_{\text{OUT}}}{V_{\text{INmin}}} \right) \times \frac{1}{f_{\text{sw}} \times I_{\text{O}}} \quad (28)$$

$$I_{\text{Lpeak}} = \left(\frac{2 \times V_{\text{OUT}} \times I_{\text{Omax}} \times (V_{\text{INmax}} - V_{\text{OUT}})}{V_{\text{INmax}} \times L_{\text{O}} \times f_{\text{sw}}} \right)^{0.5} \quad (29)$$

$$D1 = \left(\frac{2 \times V_{\text{OUT}} \times I_{\text{O}} \times L_{\text{O}} \times f_{\text{sw}}}{V_{\text{IN}} \times (V_{\text{IN}} - V_{\text{OUT}})} \right)^{0.5} \quad (30)$$

$$D2 = \left(\frac{V_{\text{IN}} - V_{\text{OUT}}}{V_{\text{OUT}}} \right) \times D1 \quad (31)$$

$$I_{\text{Lrms}} = I_{\text{Lpeak}} \times \left(\frac{D1 + D2}{3} \right)^{0.5} \quad (32)$$

$$I_{\text{COrms}} = I_{\text{Lpeak}} \times \left(\left(\frac{D1 + D2}{3} \right) - \left(\frac{D1 + D2}{4} \right)^2 \right)^{0.5} \quad (33)$$

$$C_{\text{O1}} \leq \frac{I_{\text{Lpeak}}}{V_{\text{RIPPLE}}} \times \left(\frac{D1 + D2}{8 \times f_{\text{SW}}} \right) \quad (34)$$

$$C_{\text{O2}} \geq L_{\text{O}} \times \frac{I_{\text{O}}^2 - I_{\text{Omin}}^2}{(V_{\text{OUT}} + \Delta V)^2 - V_{\text{OUT}}^2} \quad (35)$$

$$C_{\text{O3}} \geq \frac{I_{\text{OUT}}}{\Delta V_{\text{OUT}}} \times \frac{1}{f_{\text{co}}} \quad (36)$$

$$R_{\text{C}} \leq \frac{V_{\text{RIPPLE}}}{I_{\text{Lpeak}}} \quad (37)$$

$$I_{CINrms} = I_{Lpeak} \times \left(\left(\frac{D1}{3} \right) - \left(\frac{D1}{4} \right)^2 \right)^{0.5} \quad (38)$$

$$C_{IN} \geq \frac{I_o}{V_{INRIPPLE}} \times \left(\frac{0.25}{f_{SW}} \right) \quad (39)$$

8.2.2.2 Closing the Feedback Loop

The method presented here is easy to calculate and includes the effect of the slope compensation that is internal to the TPS54061. This method assumes the crossover frequency is between the modulator pole and the ESR zero and the ESR zero is at least 10 times greater than the modulator pole. Once the output components are determined, use the equations below to close the feedback loop. A current mode controlled power supply operating in DCM has a transfer function which includes an ESR zero and pole as shown in Equation 40. To calculate the current mode power stage gain, first calculate, Kdcm, the DCM gain, and Fm, the modulator gain, using Equation 41 and Equation 42. Kdcm and Fm are 32.4 and 0.475 respectively. The location of the pole and ESR zero are calculated using Equation 43 and Equation 44. The pole and zero are 491 Hz and 2.8 MHz, respectively. Use the lower value of Equation 45 and Equation 46 as a starting point for the crossover frequency. Equation 45 is the geometric mean of the power stage pole and the ESR zero and Equation 46 is the mean of power stage pole and the switching frequency. The crossover frequency is chosen as 5 kHz from Equation 46.

To determine the compensation resistor, R_{COMP}, use Equation 47. Assume the power stage transconductance, g_{mps}, is 1.0 A/V. The output voltage, V_O, reference voltage, V_{REF}, and amplifier transconductance, g_{mea}, are 5.0 V, 0.8 V and 108 μA/V, respectively. R_{COMP} is calculated to be 38.3 kΩ; use the nearest standard value of 35.7 kΩ. Use Equation 48 to set the compensation zero to equal the modulator pole frequency. Equation 48 yields 290 nF for compensating capacitor C_{COMP}, and a 330 nF is used. Use the larger value of Equation 49 or Equation 50 to calculate the C_{POLE}, which sets the compensation pole. Equation 50 yields 178 pF standard value of 220 pF is selected.

$$G_{dcm}(s) \approx F_m \times K_{dcm} \times \frac{1 + \frac{s}{2 \times \pi \times f_{ZERO}}}{1 + \frac{s}{2 \times \pi \times f_{POLE}}} \quad (40)$$

$$K_{dcm} = \frac{2}{D1} \times \frac{V_{OUT} \times (V_{IN} - V_{OUT})}{V_{IN} \times \left(2 + \frac{R_{dc}}{\frac{V_{OUT}}{I_o}} \right) - V_{OUT}} \quad (41)$$

$$F_m = \frac{g_{mps}}{\left(\frac{V_{IN} - V_{OUT}}{L_o \times f_{sw}} \right) + 0.380} \quad (42)$$

$$f_{POLE}(\text{Hz}) = \frac{1}{\frac{V_{OUT}}{I_o} \times C_o \times 2 \times \pi} \times \left(\frac{2 - \frac{V_{OUT}}{V_{IN}}}{1 - \frac{V_{OUT}}{V_{IN}}} \right) \quad (43)$$

$$f_{ZERO}(\text{Hz}) = \frac{1}{R_c \times C_o \times 2 \times \pi} \quad (44)$$

$$f_{CO1}(\text{Hz}) = (f_{ZERO} \times f_{POLE})^{0.5} \quad (45)$$

$$f_{CO2}(\text{Hz}) = (f_{SW} \times f_{POLE})^{0.5} \quad (46)$$

$$R_{COMP} = \frac{f_{co}}{K_{dcm} \times F_m \times f_{POLE}} \times \frac{V_{OUT}}{V_{REF} \times g_{mea}} \quad (47)$$

$$C_{COMP} = \frac{1}{2 \times \pi \times R_{COMP} \times K_{dcm} \times F_m} \tag{48}$$

$$C_{POLE1} = \frac{R_C \times C_O}{R_{COMP}} \tag{49}$$

$$C_{POLE2} = \frac{1}{R_{COMP} \times f_{SW} \times \pi} \tag{50}$$

8.2.2.3 Application Curves

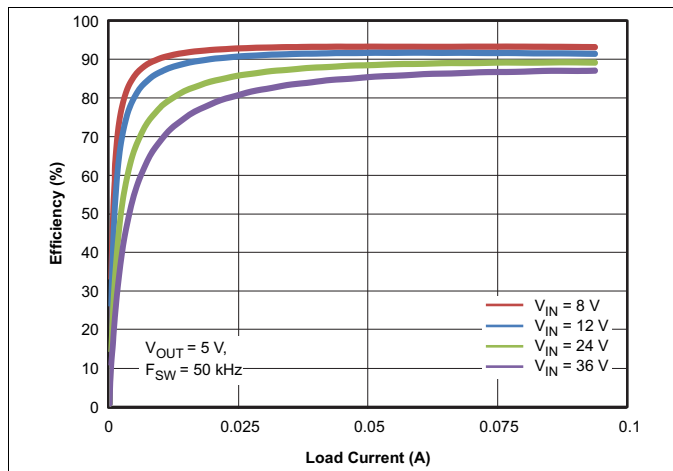

Figure 39. Efficiency vs Load Current

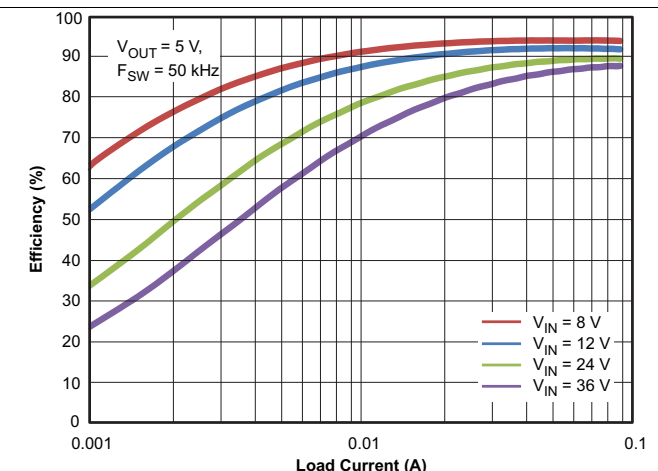

Figure 40. Efficiency vs Load Current

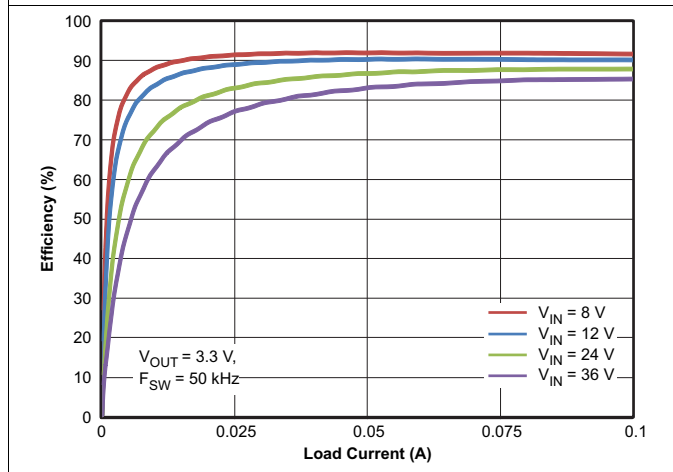

Figure 41. Efficiency vs Load Current

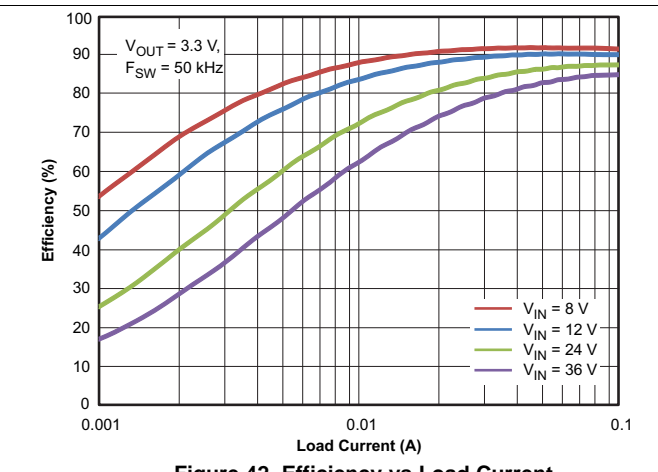

Figure 42. Efficiency vs Load Current

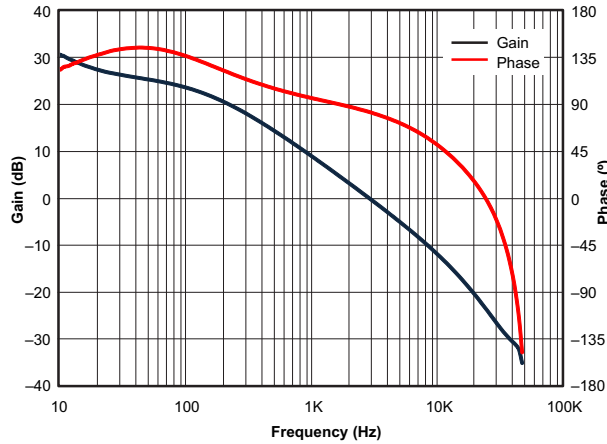

Figure 43. Frequency Response

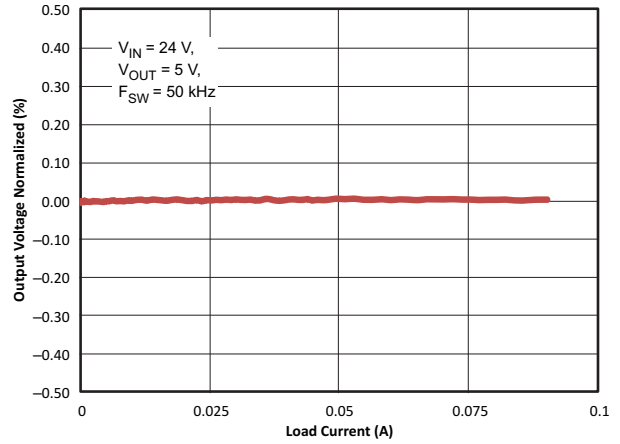

Figure 44. Output Voltage Normalized vs Load Current

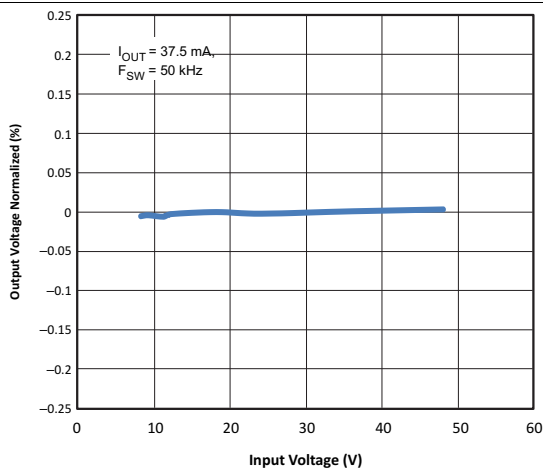

Figure 45. Output Voltage Normalized vs Input Voltage

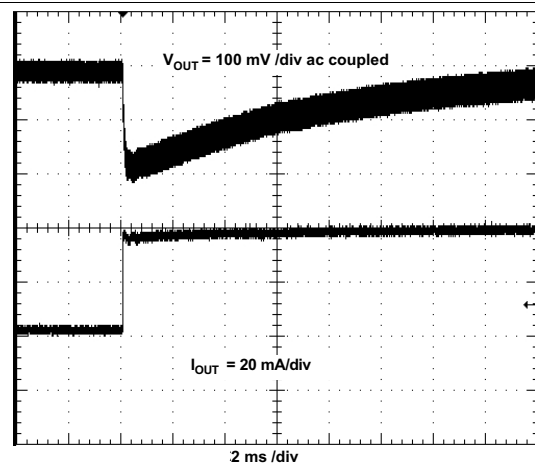

Figure 46. Load Transient

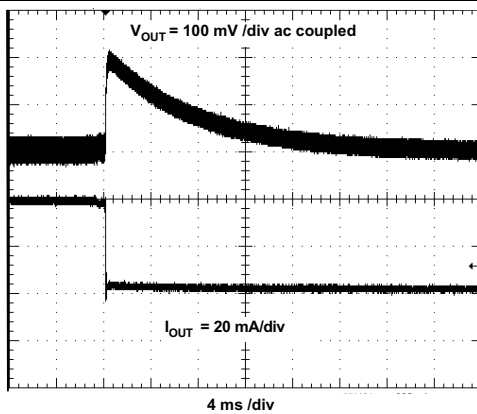

Figure 47. Unload Transient

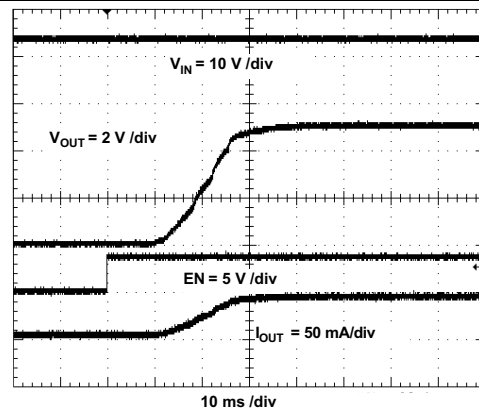

Figure 48. Start-Up With ENA

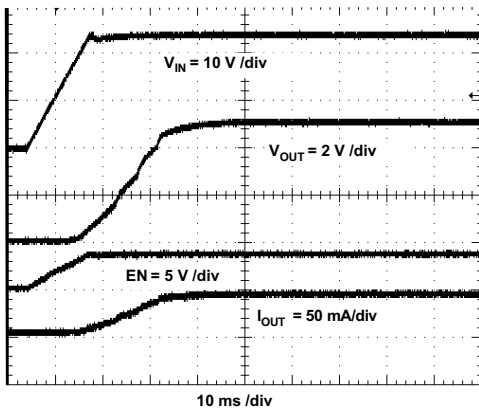

Figure 49. Start-Up With V_{IN}

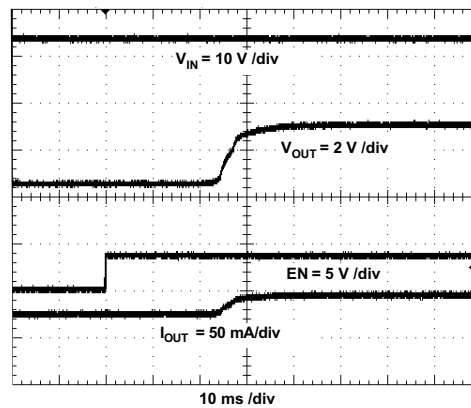

Figure 50. Prebias Start-Up With ENA

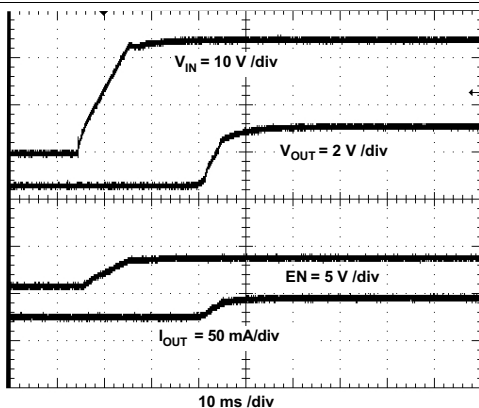

Figure 51. Prebias Start-Up With V_{IN}

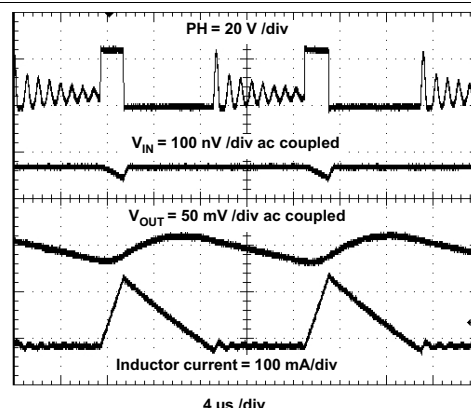

Figure 52. Input and Output Ripple in DCM

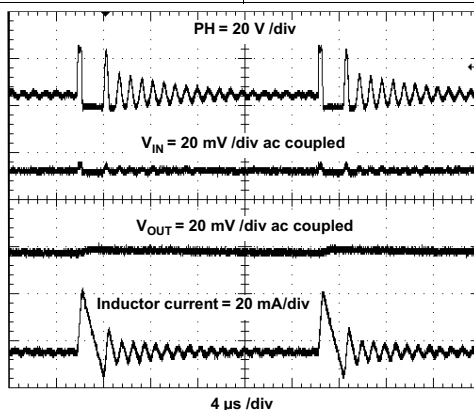

Figure 53. Input and Output Ripple in PSM

9 Power Supply Recommendations

The TPS54061 is designed to operate from an input voltage supply range between 4.7 V and 60 V. This input supply should remain within the input voltage supply range. If the input supply is located more than a few inches from the TPS54061 converter bulk capacitance may be required in addition to the ceramic bypass capacitors.

10 Layout

10.1 Layout Guidelines

Layout is a critical portion of good power supply design. There are several signals paths that conduct fast changing currents or voltages that can interact with stray inductance or parasitic capacitance to generate noise or degrade the power supplies performance. To help eliminate these problems, the VIN pin should be bypassed to ground with a low-ESR ceramic bypass capacitor with X5R or X7R dielectric. Take care to minimize the loop area formed by the bypass capacitor connections, the VIN pin, and the GND pin. See Figure 54 for a PCB layout example. Because the PH connection is the switching node and output inductor should be located close to the PH pins, and the area of the PCB conductor minimized to prevent excessive capacitive coupling. The RT/CLK pin is sensitive to noise, so the RT resistor should be located as close as possible to the IC and routed with minimal lengths of trace. The additional external components can be placed approximately as shown. It may be possible to obtain acceptable performance with alternate PCB layouts; however, this layout has been shown to produce good results and is meant as a guideline.

10.2 Layout Example

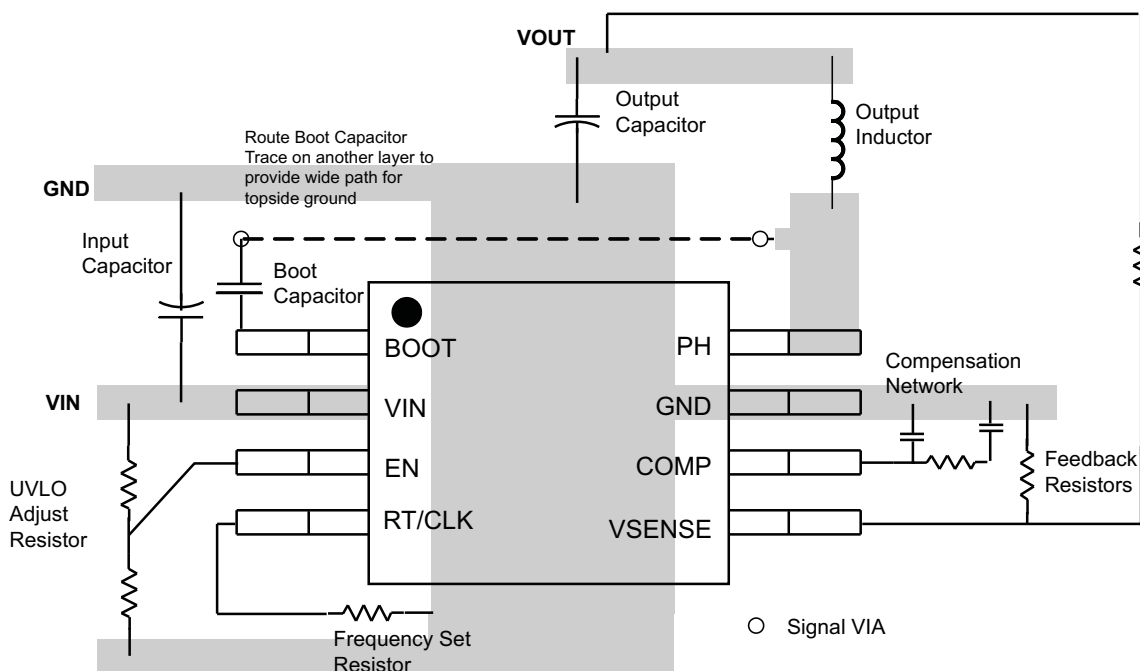

Figure 54. PCB Layout Example

11 Device and Documentation Support

11.1 Trademarks

WEBENCH is a trademark of Texas Instruments.
All other trademarks are the property of their respective owners.

11.2 Electrostatic Discharge Caution



These devices have limited built-in ESD protection. The leads should be shorted together or the device placed in conductive foam during storage or handling to prevent electrostatic damage to the MOS gates.

11.3 Glossary

[SLYZ022](#) — *TI Glossary*.

This glossary lists and explains terms, acronyms, and definitions.

12 Mechanical, Packaging, and Orderable Information

The following pages include mechanical, packaging, and orderable information. This information is the most current data available for the designated devices. This data is subject to change without notice and revision of this document. For browser-based versions of this data sheet, refer to the left-hand navigation.

PACKAGING INFORMATION

Orderable part number	Status (1)	Material type (2)	Package Pins	Package qty Carrier	RoHS (3)	Lead finish/ Ball material (4)	MSL rating/ Peak reflow (5)	Op temp (°C)	Part marking (6)
TPS54061DRBR	Active	Production	SON (DRB) 8	3000 LARGE T&R	Yes	NIPDAU	Level-2-260C-1 YEAR	-40 to 150	61
TPS54061DRBR.A	Active	Production	SON (DRB) 8	3000 LARGE T&R	Yes	NIPDAU	Level-2-260C-1 YEAR	-40 to 150	61
TPS54061DRBR.B	Active	Production	SON (DRB) 8	3000 LARGE T&R	Yes	NIPDAU	Level-2-260C-1 YEAR	-40 to 150	61
TPS54061DRBRG4	Active	Production	SON (DRB) 8	3000 LARGE T&R	Yes	NIPDAU	Level-2-260C-1 YEAR	-40 to 150	61
TPS54061DRBRG4.A	Active	Production	SON (DRB) 8	3000 LARGE T&R	Yes	NIPDAU	Level-2-260C-1 YEAR	-40 to 150	61
TPS54061DRBRG4.B	Active	Production	SON (DRB) 8	3000 LARGE T&R	Yes	NIPDAU	Level-2-260C-1 YEAR	-40 to 150	61
TPS54061DRBT	Active	Production	SON (DRB) 8	250 SMALL T&R	Yes	NIPDAU	Level-2-260C-1 YEAR	-40 to 150	61
TPS54061DRBT.A	Active	Production	SON (DRB) 8	250 SMALL T&R	Yes	NIPDAU	Level-2-260C-1 YEAR	-40 to 150	61
TPS54061DRBT.B	Active	Production	SON (DRB) 8	250 SMALL T&R	Yes	NIPDAU	Level-2-260C-1 YEAR	-40 to 150	61

(1) **Status:** For more details on status, see our [product life cycle](#).

(2) **Material type:** When designated, preproduction parts are prototypes/experimental devices, and are not yet approved or released for full production. Testing and final process, including without limitation quality assurance, reliability performance testing, and/or process qualification, may not yet be complete, and this item is subject to further changes or possible discontinuation. If available for ordering, purchases will be subject to an additional waiver at checkout, and are intended for early internal evaluation purposes only. These items are sold without warranties of any kind.

(3) **RoHS values:** Yes, No, RoHS Exempt. See the [TI RoHS Statement](#) for additional information and value definition.

(4) **Lead finish/Ball material:** Parts may have multiple material finish options. Finish options are separated by a vertical ruled line. Lead finish/Ball material values may wrap to two lines if the finish value exceeds the maximum column width.

(5) **MSL rating/Peak reflow:** The moisture sensitivity level ratings and peak solder (reflow) temperatures. In the event that a part has multiple moisture sensitivity ratings, only the lowest level per JEDEC standards is shown. Refer to the shipping label for the actual reflow temperature that will be used to mount the part to the printed circuit board.

(6) **Part marking:** There may be an additional marking, which relates to the logo, the lot trace code information, or the environmental category of the part.

Multiple part markings will be inside parentheses. Only one part marking contained in parentheses and separated by a "-" will appear on a part. If a line is indented then it is a continuation of the previous line and the two combined represent the entire part marking for that device.

Important Information and Disclaimer: The information provided on this page represents TI's knowledge and belief as of the date that it is provided. TI bases its knowledge and belief on information provided by third parties, and makes no representation or warranty as to the accuracy of such information. Efforts are underway to better integrate information from third parties. TI has taken and continues to take reasonable steps to provide representative

and accurate information but may not have conducted destructive testing or chemical analysis on incoming materials and chemicals. TI and TI suppliers consider certain information to be proprietary, and thus CAS numbers and other limited information may not be available for release.

In no event shall TI's liability arising out of such information exceed the total purchase price of the TI part(s) at issue in this document sold by TI to Customer on an annual basis.

OTHER QUALIFIED VERSIONS OF TPS54061 :

- Automotive : [TPS54061-Q1](#)

NOTE: Qualified Version Definitions:

- Automotive - Q100 devices qualified for high-reliability automotive applications targeting zero defects

TAPE AND REEL INFORMATION

QUADRANT ASSIGNMENTS FOR PIN 1 ORIENTATION IN TAPE

*All dimensions are nominal

Device	Package Type	Package Drawing	Pins	SPQ	Reel Diameter (mm)	Reel Width W1 (mm)	A0 (mm)	B0 (mm)	K0 (mm)	P1 (mm)	W (mm)	Pin1 Quadrant
TPS54061DRBR	SON	DRB	8	3000	330.0	12.4	3.3	3.3	1.1	8.0	12.0	Q2
TPS54061DRBRG4	SON	DRB	8	3000	330.0	12.4	3.3	3.3	1.1	8.0	12.0	Q2
TPS54061DRBT	SON	DRB	8	250	180.0	12.4	3.3	3.3	1.1	8.0	12.0	Q2

TAPE AND REEL BOX DIMENSIONS

*All dimensions are nominal

Device	Package Type	Package Drawing	Pins	SPQ	Length (mm)	Width (mm)	Height (mm)
TPS54061DRBR	SON	DRB	8	3000	346.0	346.0	33.0
TPS54061DRBG4	SON	DRB	8	3000	346.0	346.0	33.0
TPS54061DRBT	SON	DRB	8	250	210.0	185.0	35.0

DRB 8

GENERIC PACKAGE VIEW

VSON - 1 mm max height

PLASTIC SMALL OUTLINE - NO LEAD



Images above are just a representation of the package family, actual package may vary.
Refer to the product data sheet for package details.

4203482/L

DRB0008B



PACKAGE OUTLINE

VSON - 1 mm max height

PLASTIC SMALL OUTLINE - NO LEAD



4218876/A 12/2017

NOTES:

1. All linear dimensions are in millimeters. Any dimensions in parenthesis are for reference only. Dimensioning and tolerancing per ASME Y14.5M.
2. This drawing is subject to change without notice.
3. The package thermal pad must be soldered to the printed circuit board for thermal and mechanical performance.

EXAMPLE BOARD LAYOUT

DRB0008B

VSON - 1 mm max height

PLASTIC SMALL OUTLINE - NO LEAD



LAND PATTERN EXAMPLE
SCALE:20X



SOLDER MASK DETAILS

4218876/A 12/2017

NOTES: (continued)

4. This package is designed to be soldered to a thermal pad on the board. For more information, see Texas Instruments literature number SLUA271 (www.ti.com/lit/slue271).
5. Vias are optional depending on application, refer to device data sheet. If any vias are implemented, refer to their locations shown on this view. It is recommended that vias under paste be filled, plugged or tented.

EXAMPLE STENCIL DESIGN

DRB0008B

VSON - 1 mm max height

PLASTIC SMALL OUTLINE - NO LEAD



SOLDER PASTE EXAMPLE
BASED ON 0.125 mm THICK STENCIL
EXPOSED PAD
81% PRINTED SOLDER COVERAGE BY AREA
SCALE:25X

4218876/A 12/2017

NOTES: (continued)

6. Laser cutting apertures with trapezoidal walls and rounded corners may offer better paste release. IPC-7525 may have alternate design recommendations.

IMPORTANT NOTICE AND DISCLAIMER

TI PROVIDES TECHNICAL AND RELIABILITY DATA (INCLUDING DATASHEETS), DESIGN RESOURCES (INCLUDING REFERENCE DESIGNS), APPLICATION OR OTHER DESIGN ADVICE, WEB TOOLS, SAFETY INFORMATION, AND OTHER RESOURCES "AS IS" AND WITH ALL FAULTS, AND DISCLAIMS ALL WARRANTIES, EXPRESS AND IMPLIED, INCLUDING WITHOUT LIMITATION ANY IMPLIED WARRANTIES OF MERCHANTABILITY, FITNESS FOR A PARTICULAR PURPOSE OR NON-INFRINGEMENT OF THIRD PARTY INTELLECTUAL PROPERTY RIGHTS.

These resources are intended for skilled developers designing with TI products. You are solely responsible for (1) selecting the appropriate TI products for your application, (2) designing, validating and testing your application, and (3) ensuring your application meets applicable standards, and any other safety, security, regulatory or other requirements.

These resources are subject to change without notice. TI grants you permission to use these resources only for development of an application that uses the TI products described in the resource. Other reproduction and display of these resources is prohibited. No license is granted to any other TI intellectual property right or to any third party intellectual property right. TI disclaims responsibility for, and you fully indemnify TI and its representatives against any claims, damages, costs, losses, and liabilities arising out of your use of these resources.

TI's products are provided subject to [TI's Terms of Sale](#), [TI's General Quality Guidelines](#), or other applicable terms available either on [ti.com](#) or provided in conjunction with such TI products. TI's provision of these resources does not expand or otherwise alter TI's applicable warranties or warranty disclaimers for TI products. Unless TI explicitly designates a product as custom or customer-specified, TI products are standard, catalog, general purpose devices.

TI objects to and rejects any additional or different terms you may propose.

Copyright © 2025, Texas Instruments Incorporated

Last updated 10/2025