

# TPS54218 2.95-V to 6-V Input, 2-A Output, 2-MHz, Synchronous Step-Down SWIFT™ Converter

## 1 Features

- Two, 30-mΩ (typical) MOSFETs for high-efficiency at 2-A loads
- Switching frequency: 200 kHz to 2 MHz
- Voltage reference over temperature: 0.8 V ±1%
- Synchronizes to external clock
- Adjustable soft start/sequencing
- UV and OV power-good output
- Low operating and shutdown quiescent current
- Safe start-up into prebiased output
- Cycle-by-cycle current limit, thermal and frequency foldback protection
- Operating junction temperature range: –40°C to 150°C
- Thermally-enhanced 3-mm × 3-mm 16-pin WQFN package
- Create a custom design using the TPS54218 with the [WEBENCH® Power Designer](#)

## 2 Applications

- [Factory automation](#)
- [Broadband fixed line access](#)
- [Wireless infrastructure](#)

## 3 Description

The TPS54218 device is a full-featured, 6-V, 2-A, synchronous, step-down current-mode converter with two integrated MOSFETs.

The TPS54218 device enables small designs by integrating the MOSFETs, implementing current mode control to reduce external component count, reducing inductor size by enabling up to 2-MHz switching frequency, and minimizing the device footprint with a small, 3-mm × 3-mm, thermally-enhanced QFN package.

The TPS54218 device provides accurate regulation for a variety of loads with an accurate ±1% voltage reference ( $V_{REF}$ ) over temperature.

Efficiency is maximized through the integrated 30-mΩ MOSFETs and a 350-μA typical supply current. Using the EN pin, shutdown supply current is reduced to 2 μA by entering a shutdown mode.

Undervoltage lockout is internally set at 2.6 V, but can be increased by programming the threshold with a resistor network on the enable pin. The output voltage startup ramp is controlled by the soft-start pin. An open-drain power-good signal indicates the output is within 93% to 107% of its nominal voltage. Frequency foldback and thermal shutdown protects the device during an overcurrent condition.

For more SWIFT™ documentation, see the TI website at [www.ti.com/swift](http://www.ti.com/swift).

### Device Information<sup>(1)</sup>

PART NUMBER	PACKAGE	BODY SIZE (NOM)
TPS54218	WQFN (16)	3.00 mm × 3.00 mm

(1) For all available packages, see the orderable addendum at the end of the data sheet.

### Simplified Schematic

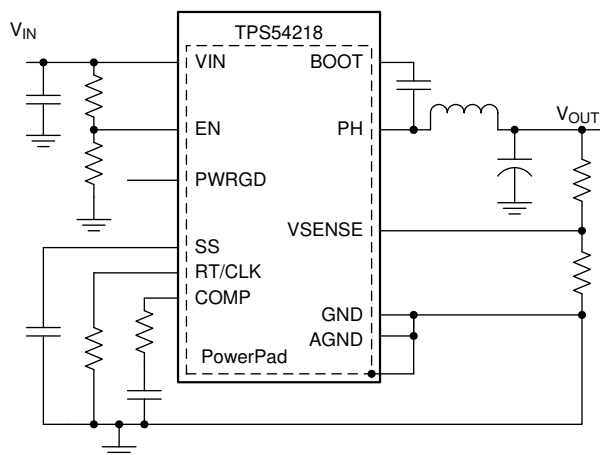

### Efficiency versus Output Current

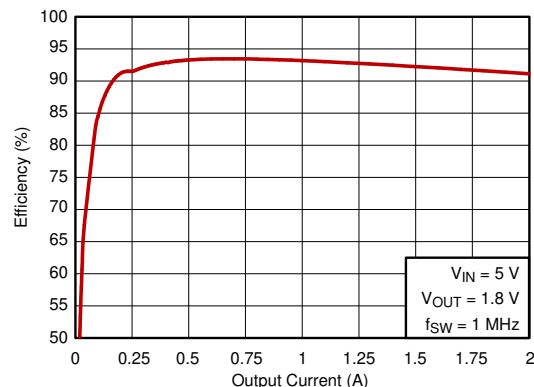

## Table of Contents

<b>1 Features</b> .....	<b>1</b>	7.4 Device Functional Modes.....	<b>19</b>
<b>2 Applications</b> .....	<b>1</b>	<b>8 Application and Implementation</b> .....	<b>23</b>
<b>3 Description</b> .....	<b>1</b>	8.1 Application Information.....	<b>23</b>
<b>4 Revision History</b> .....	<b>2</b>	8.2 Typical Application .....	<b>23</b>
<b>5 Pin Configuration and Functions</b> .....	<b>4</b>	<b>9 Power Supply Recommendations</b> .....	<b>34</b>
<b>6 Specifications</b> .....	<b>5</b>	<b>10 Layout</b> .....	<b>34</b>
6.1 Absolute Maximum Ratings .....	<b>5</b>	10.1 Layout Guidelines .....	<b>34</b>
6.2 ESD Ratings .....	<b>5</b>	10.2 Layout Example .....	<b>35</b>
6.3 Recommended Operating Conditions.....	<b>5</b>	<b>11 Device and Documentation Support</b> .....	<b>36</b>
6.4 Thermal Information .....	<b>6</b>	11.1 Device Support .....	<b>36</b>
6.5 Electrical Characteristics.....	<b>7</b>	11.2 Receiving Notification of Documentation Updates	<b>36</b>
6.6 Typical Characteristics.....	<b>9</b>	11.3 Support Resources .....	<b>36</b>
<b>7 Detailed Description</b> .....	<b>13</b>	11.4 Trademarks .....	<b>36</b>
7.1 Overview .....	<b>13</b>	11.5 Electrostatic Discharge Caution.....	<b>36</b>
7.2 Functional Block Diagram .....	<b>14</b>	11.6 Glossary .....	<b>36</b>
7.3 Feature Description.....	<b>14</b>	<b>12 Mechanical, Packaging, and Orderable Information</b> .....	<b>36</b>

## 4 Revision History

NOTE: Page numbers for previous revisions may differ from page numbers in the current version.

### Changes from Revision E (September 2018) to Revision F Page

- Changed axis names of [Figure 13](#) ..... **10**

### Changes from Revision D (April 2018) to Revision E Page

- Changed charge current from 1.8  $\mu\text{A}$  to 2.07  $\mu\text{A}$ ..... **8**
- Changed SS discharge voltage (overload) units from  $\mu\text{A}$  to mV..... **8**
- Changed SS charge current graph..... **11**
- Updated content of [Soft-Start Pin](#), including [Equation 4](#) .....

### Changes from Revision C (December 2014) to Revision D Page

- update title; add top navigator icon for TI reference design..... **1**

### Changes from Revision B (June 2013) to Revision C Page

- Added *ESD Ratings* table, *Feature Description* section, *Device Functional Modes* section, *Application and Implementation* section, *Power Supply Recommendations* section, *Layout* section, *Device and Documentation Support* section, and *Mechanical, Packaging, and Orderable Information* section..... **1**

**Changes from Revision A (August 2012) to Revision B**
**Page**

• Added <a href="#">Figure 22</a> to <i>Typical Characteristics</i> section .....	11
• Added clarity to <i>Fixed Frequency PWM Control</i> section .....	14
• Added clarity to <i>Soft-Start Pin</i> section .....	16
• Added <i>Soft-Start Pin</i> section .....	16
• Added clarity to <i>Synchronize Using the RT/CLK Pin</i> section .....	18
• Added <i>Step Five: Minimum Load DC COMP Voltage</i> section .....	26
• Added clarity to the <i>Step Six: Choose the Soft-Start Capacitor</i> section .....	26

---

**Changes from Original (September 2009) to Revision A**
**Page**

• Added "Instantaneous peak current" specification to the Current Limit section in the <i>Electrical Characteristics</i> table .....	7
--	---

---

## 5 Pin Configuration and Functions

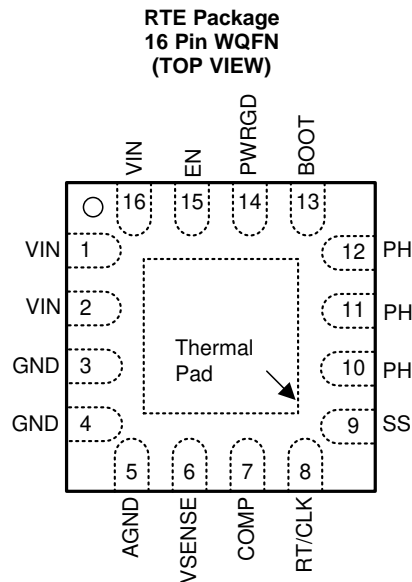

### Pin Functions

PIN		I/O <sup>(1)</sup>	DESCRIPTION
NAME	NO.		
AGND	5	G	Analog ground must be electrically connected to GND close to the device.
BOOT	13	I	A bootstrap capacitor is required between BOOT and PH. If the voltage on this capacitor is below the minimum required by the BOOT UVLO, the output is forced to switch off until the capacitor is refreshed.
COMP	7	O	Error amplifier output, and input to the output switch current comparator. Connect frequency compensation components to this pin.
EN	15	I	Enable pin, internal pullup current source. Pull below 1.2 V to disable. Float to enable. Can be used to set the on/off threshold (adjust UVLO) with two additional resistors.
GND	3	G	Power ground. This pin must be electrically connected directly to the power pad under the device.
	4		
PH	10	O	The source of the internal high-side power MOSFET, and drain of the internal low-side (synchronous) rectifier MOSFET
	11		
	12		
PWRGD	14	O	An open-drain output asserts low if output voltage is low due to thermal shutdown, overcurrent, overvoltage or undervoltage, or EN shut down.
RT/CLK	8	I/O	Resistor Timing or External Clock input pin
SS	9	I/O	Slow start. An external capacitor connected to this pin sets the output voltage rise time.
VIN	1	I	Input supply voltage, 2.95 V to 6 V
	2		
	16		
VSENSE	6	I	Inverting node of the transconductance (gm) error amplifier
Thermal Pad		G	GND pin must be connected to the exposed power pad for proper operation. This power pad must be connected to any internal PCB ground plane using multiple vias for good thermal performance.

(1) I = Input, O = Output, G = Ground

## 6 Specifications

### 6.1 Absolute Maximum Ratings

over operating free-air temperature range (unless otherwise noted)<sup>(1)</sup>

		MIN	MAX	UNIT
Input voltage	EN, PWRGD, VIN	-0.3	7	V
	RT/CLK	-0.3	6	
	COMP, SS, VSENSE	-0.3	3	
	BOOT		V <sub>PH</sub> + 8 V	
Output voltage	BOOT-PH		8	V
	PH	-0.6	7	
	PH (10 ns transient)	-2	7	
Source current	EN, RT/CLK		100	μA
Sink current	COMP, SS		100	μA
	PWRGD		10	mA
Operating junction temperature, T <sub>J</sub>		-40	150	°C
Storage temperature, T <sub>stg</sub>		-65	150	°C

(1) Stresses beyond those listed under *Absolute Maximum Ratings* may cause permanent damage to the device. These are stress ratings only, which do not imply functional operation of the device at these or any other conditions beyond those indicated under *Recommended Operating Conditions*. Exposure to absolute-maximum-rated conditions for extended periods may affect device reliability.

### 6.2 ESD Ratings

		VALUE	UNIT	
V <sub>(ESD)</sub>	Electrostatic discharge	Human body model (HBM), per ANSI/ESDA/JEDEC JS-001, all pins <sup>(1)</sup>	±2000	V
		Charged device model (CDM), per JEDEC specification JESD22-C101, all pins <sup>(2)</sup>	±500	V

(1) JEDEC document JEP155 states that 500-V HBM allows safe manufacturing with a standard ESD control process.

(2) JEDEC document JEP157 states that 250-V CDM allows safe manufacturing with a standard ESD control process.

### 6.3 Recommended Operating Conditions

over operating free-air temperature range (unless otherwise noted)

		MIN	MAX	UNIT
V <sub>VIN</sub>	Input voltage	3	6	V
T <sub>J</sub>	Operating junction temperature	-40	150	°C

## 6.4 Thermal Information<sup>(1)</sup>

THERMAL METRIC <sup>(2)</sup>		TPS54218	
		RTE (WQFN)	
		16 PINS	
			UNIT
$R_{\theta JA}$	Junction-to-ambient thermal resistance	50	°C/W
$R_{\theta JA}$	Junction-to-ambient thermal resistance <sup>(3)</sup>	37	°C/W
$R_{\theta JC(top)}$	Junction-to-case (top) thermal resistance	59.1	°C/W
$R_{\theta JB}$	Junction-to-board thermal resistance	23.1	°C/W
$\psi_{JT}$	Junction-to-top characterization parameter	1.4	°C/W
$\psi_{JB}$	Junction-to-board characterization parameter	23.1	°C/W
$R_{\theta JC(bot)}$	Junction-to-case (bottom) thermal resistance	7.9	°C/W

- (1) Unless otherwise specified, metrics listed in this table refer to JEDEC high-K board measurements
- (2) For more information about traditional and new thermal metrics, see the [Semiconductor and IC Package Thermal Metrics application report](#).
- (3) Test Board Conditions:
- (a) 2 inches x 2 inches, 4 layers, thickness: 0.062 inch
  - (b) 2 oz. copper traces located on the top of the PCB
  - (c) 2 oz. copper ground planes located on the two internal layers and bottom layer
  - (d) 4 thermal vias (10 mil) located under the device package

## 6.5 Electrical Characteristics

–40°C ≤ T<sub>J</sub> ≤ 150°C, 2.95 V ≤ V<sub>VIN</sub> ≤ 6 V (unless otherwise noted) over operating free-air temperature range

PARAMETER		TEST CONDITIONS	MIN	TYP	MAX	UNIT
<b>SUPPLY VOLTAGE (VIN)</b>						
V <sub>VIN</sub>	Operating input voltage		2.95		6	V
V <sub>UVLO</sub>	Internal under voltage lockout threshold	No voltage hysteresis, rising and falling		2.6	2.8	V
I <sub>Q(VIN)</sub>	Shutdown supply current	V <sub>EN</sub> = 0 V, T <sub>A</sub> = 25°C, 2.95 V ≤ V <sub>VIN</sub> ≤ 6 V		2	5	μA
I <sub>q</sub>	Quiescent current	V <sub>VSENSE</sub> = 0.9 V, V <sub>VIN</sub> = 5 V, 25°C, R <sub>T</sub> = 400 kΩ		350	500	μA
<b>ENABLE AND UVLO (EN)</b>						
V <sub>TH(en)</sub>	Enable threshold	Rising	1.16	1.25	1.37	V
		Falling		1.18		
I <sub>EN</sub>	Input current	Enable rising threshold + 50 mV		–3.2		μA
		Enable falling threshold – 50 mV		–0.65		
<b>VOLTAGE REFERENCE (VSENSE)</b>						
V <sub>REF</sub>	Voltage reference	2.95 V ≤ V <sub>VIN</sub> ≤ 6 V, –40°C < T <sub>J</sub> < 150°C	0.795	0.803	0.811	V
<b>MOSFET</b>						
R <sub>DS(HFET)</sub>	High-side switch resistance	(V <sub>BOOT</sub> – V <sub>PH</sub> ) = 5 V		30	60	mΩ
		(V <sub>BOOT</sub> – V <sub>PH</sub> ) = 2.95 V		44	70	
R <sub>DS(LFET)</sub>	Low-side switch resistance	V <sub>VIN</sub> = 5 V		30	60	mΩ
		V <sub>VIN</sub> = 2.95 V		44	70	
<b>ERROR AMPLIFIER</b>						
I <sub>IN</sub>	Input current			7		nA
g <sub>M(ea)</sub>	Error amplifier transconductance	–2 μA < I <sub>COMP</sub> < 2 μA, V <sub>COMP</sub> = 1 V		225		μS
g <sub>m(EA,ss)</sub>	Error amplifier transconductance during soft-start	–2 μA < I <sub>COMP</sub> < 2 μA, V <sub>COMP</sub> = 1 V, V <sub>VSENSE</sub> = 0.4 V		70		μS
I <sub>COMP</sub>	Error amplifier source/sink	V <sub>COMP</sub> = 1 V, 100 mV overdrive		±20		μA
g <sub>M</sub>	COMP to I <sub>SWITCH</sub> transconductance			13		A/V
<b>CURRENT LIMIT</b>						
I <sub>LIM</sub>	Current limit threshold	Instantaneous peak current	2.9	3.6		A
<b>THERMAL SHUTDOWN</b>						
T <sub>SD</sub>	Thermal Shutdown			175		°C
T <sub>SD(hyst)</sub>	Hysteresis			15		°C
<b>TIMING RESISTOR AND EXTERNAL CLOCK (RT/CLK)</b>						
f <sub>SW</sub>	Switching frequency range using RT mode		200		2000	kHz
f <sub>SW</sub>	Switching frequency	R <sub>RT</sub> = 400 kΩ	400	500	600	kHz
f <sub>SW</sub>	Switching frequency range using CLK mode		300		2000	kHz
t <sub>MIN(CLK)</sub>	Minimum CLK pulse width		75			ns
V <sub>RT/CLK</sub>	RT/CLK voltage	R <sub>RT/CLK</sub> = 400 kΩ		0.5		V
V <sub>IH(CLK)</sub>	RT/CLK high threshold			1.6	2.2	V
V <sub>IL(CLK)</sub>	RT/CLK low threshold		0.4	0.6		V
t <sub>DLY</sub>	RT/CLK falling edge to PH rising edge delay	f <sub>SW</sub> = 500 kHz with R <sub>RT</sub> resistor in series		90		ns
t <sub>LOCK(PLL)</sub>	PLL lock-in time	f <sub>SW</sub> = 500 kHz		14		μs

**Electrical Characteristics (continued)**
 $-40^{\circ}\text{C} \leq T_J \leq 150^{\circ}\text{C}$ ,  $2.95\text{ V} \leq V_{\text{VIN}} \leq 6\text{ V}$  (unless otherwise noted) over operating free-air temperature range

PARAMETER		TEST CONDITIONS	MIN	TYP	MAX	UNIT
<b>HIGH-SIDE POWER MOSFET (PH)</b>						
$t_{\text{ON(min)}}$	Minimum on time	Measured at 50% points on PH, $I_{\text{OUT}} = 2$		60		ns
		Measured at 50% points on PH, $V_{\text{VIN}} = 5\text{ V}$ , $I_{\text{OUT}} = 0\text{ A}$		110		
$t_{\text{OFF(min)}}$	Minimum off time	Prior to skipping off pulses, $(V_{\text{BOOT}} - V_{\text{PH}}) = 2.95\text{ V}$ , $I_{\text{OUT}} = 2$		60		ns
$t_{\text{RISE}}$	Rise time	$V_{\text{VIN}} = 5\text{ V}$		1.5		V/ns
$t_{\text{FALL}}$	Fall time	$V_{\text{VIN}} = 5\text{ V}$		1.5		V/ns
<b>BOOT (BOOT)</b>						
$R_{\text{BOOT}}$	BOOT charge resistance	$V_{\text{VIN}} = 5\text{ V}$		16		$\Omega$
$V_{\text{UVLO(Boot)}}$	BOOT-PH UVLO	$V_{\text{VIN}} = 2.95\text{ V}$		2.1		V
<b>SOFT-START (SS)</b>						
$I_{\text{CHG}}$	Charge current	$V_{\text{SS}} = 0.4\text{ V}$		2.07		$\mu\text{A}$
$V_{\text{SSxREF}}$	SS to reference crossover	98% nominal		0.9		V
$V_{\text{DSCHG(SS)}}$	SS discharge voltage (overload)	$V_{\text{VSENSE}} = 0\text{ V}$		20		mV
$I_{\text{DSCHG(SS)}}$	SS discharge current (UVLO, EN, thermal fault)	$V_{\text{VIN}} = 5\text{ V}$ , $V_{\text{SS}} = 0.5\text{ V}$		1.25		mA
<b>POWER GOOD (PWRGD)</b>						
$V_{\text{TH(PG)}}$	VSENSE threshold	$V_{\text{VSENSE}}$ falling (fault)		91%		$V_{\text{REF}}$
		$V_{\text{VSENSE}}$ rising (good)		93%		
		$V_{\text{VSENSE}}$ rising (fault)		107%		
		$V_{\text{VSENSE}}$ falling (Good)		105%		
$V_{\text{HYST(PG)}}$	Hysteresis	$V_{\text{VSENSE}}$ falling		2%		
$I_{\text{PH(lkg)}}$	Output high leakage	$V_{\text{VSENSE}} = V_{\text{REF}}$ , $V_{\text{PWRGD}} = 5.5\text{ V}$		2		nA
$R_{\text{PG}}$	Power Good on-resistance			100		$\Omega$
$V_{\text{OL}}$	Low-level output voltage	$I_{\text{PWRGD}} = 3.5\text{ mA}$		0.3		V
$V_{\text{MIN(PG)}}$	Minimum input voltage for valid output	$V_{\text{PWRGD}} < 0.5\text{ V}$ , $I_{\text{OUT}} = 100\text{ }\mu\text{A}$		1.2	1.6	V



## 6.6 Typical Characteristics

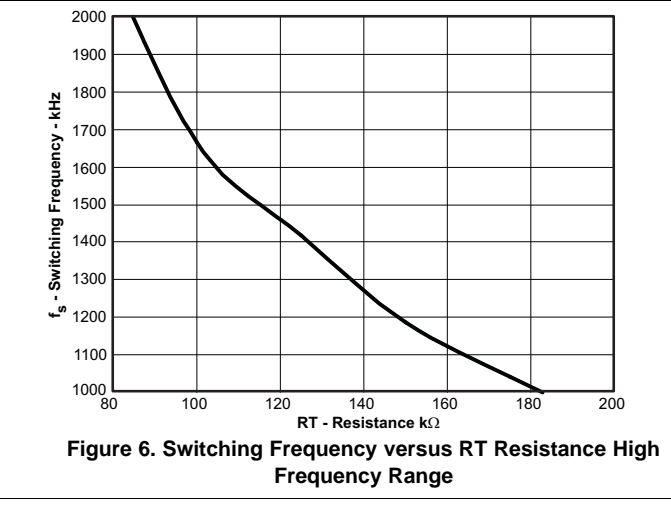
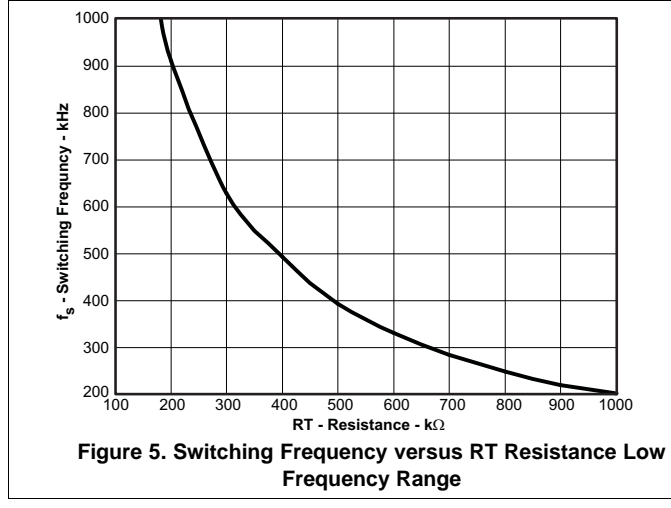
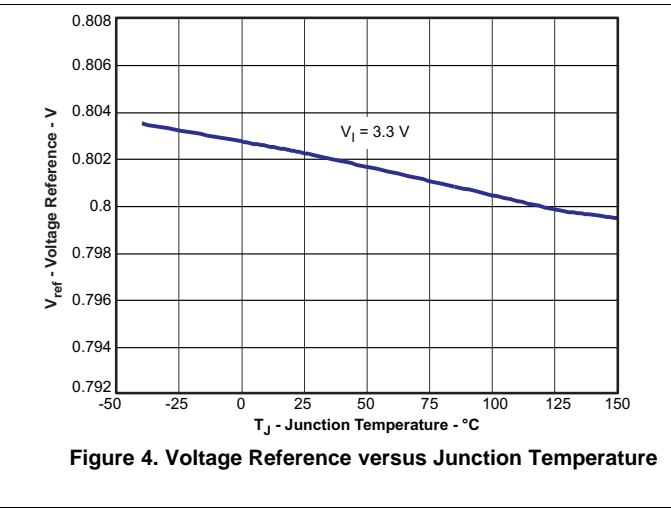
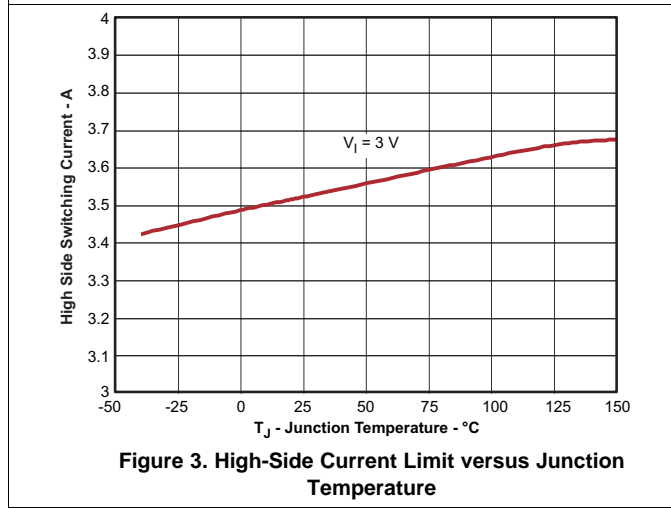
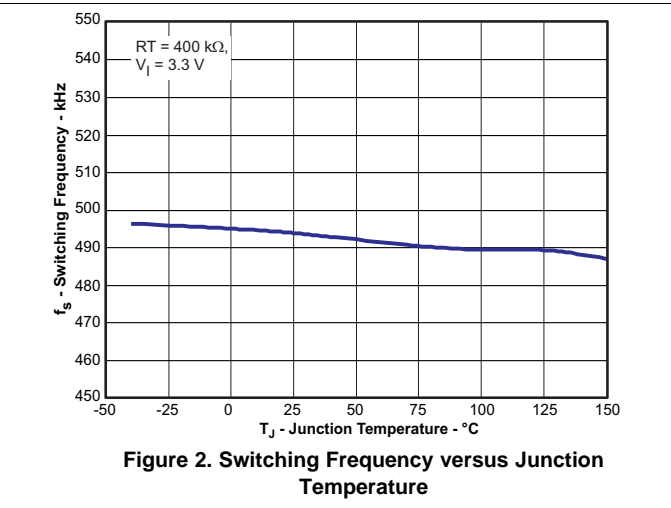
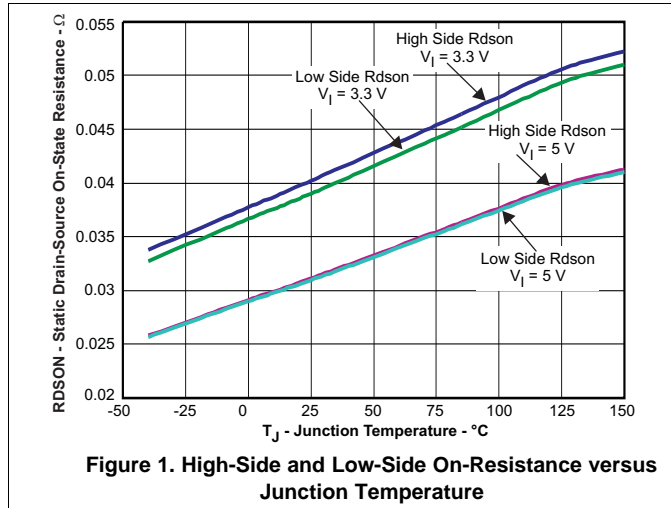

Typical Characteristics (continued)

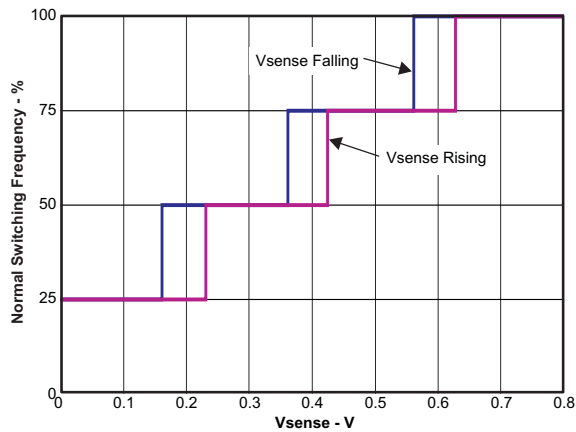

Figure 7. Switching Frequency versus Vsense

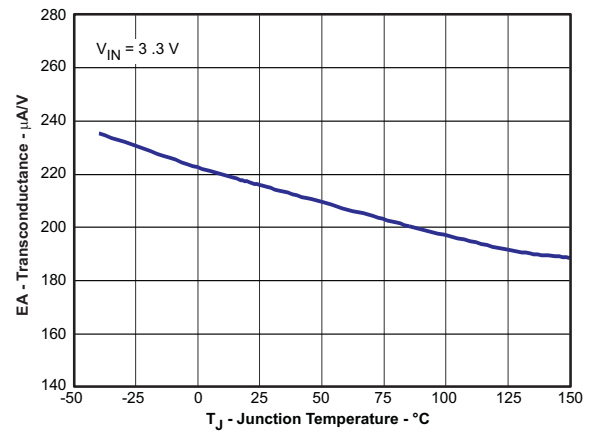

Figure 8. Transconductance versus Junction Temperature

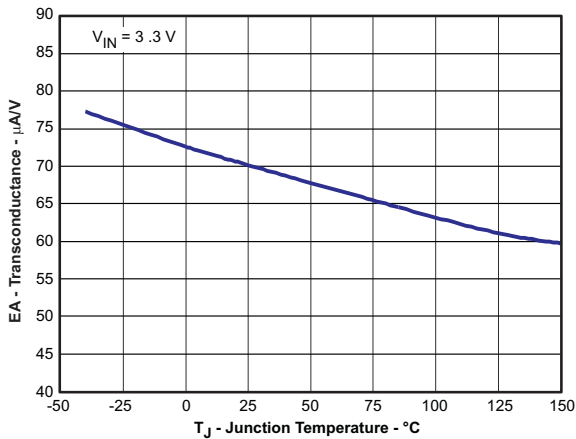

Figure 9. Transconductance (Soft Start) versus Junction Temperature

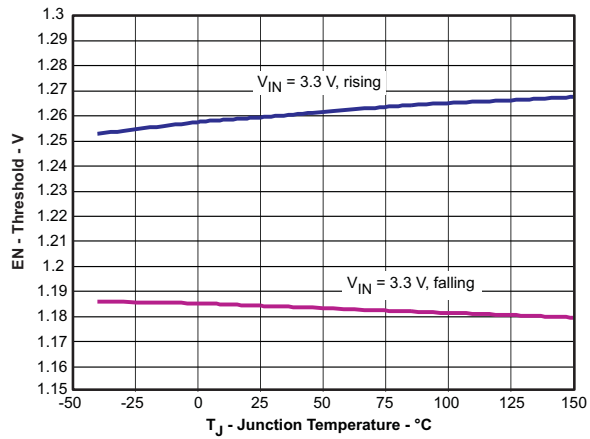

Figure 10. Enable Pin Voltage versus Junction Temperature

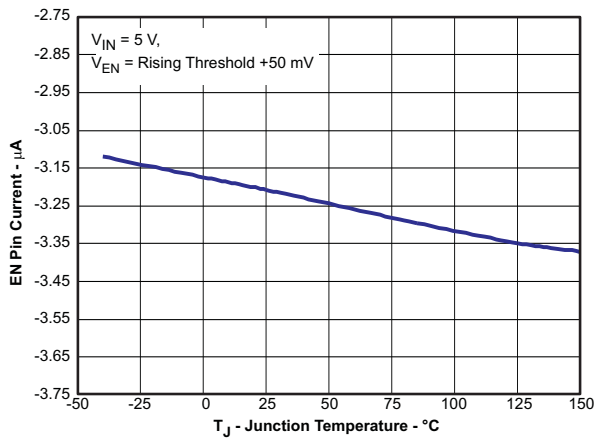

Figure 11. Pin Current versus Junction Temperature

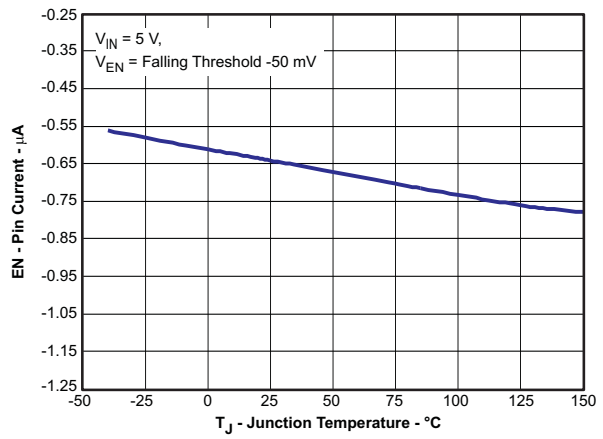

Figure 12. Pin Current versus Junction Temperature

Typical Characteristics (continued)

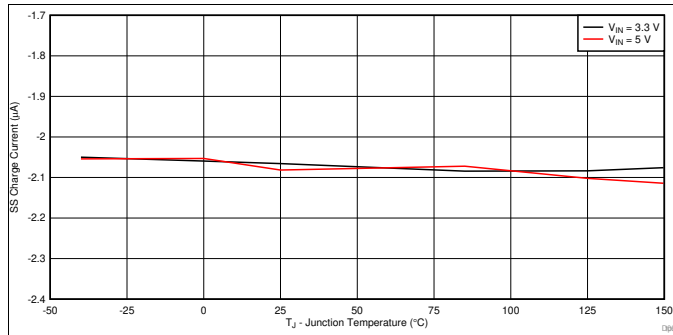

Figure 13. Junction Temperature versus SS Charge Current

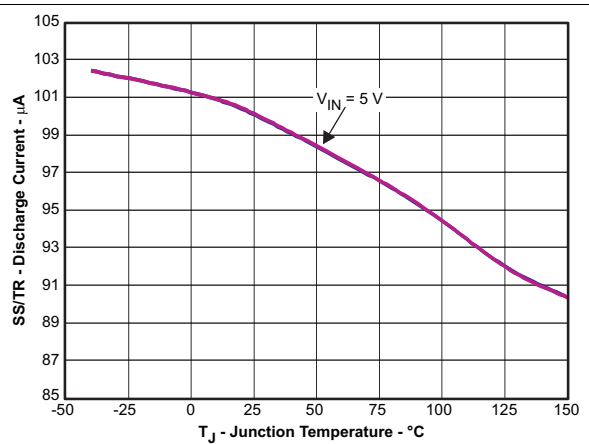

Figure 14. Discharge Current versus Junction Temperature

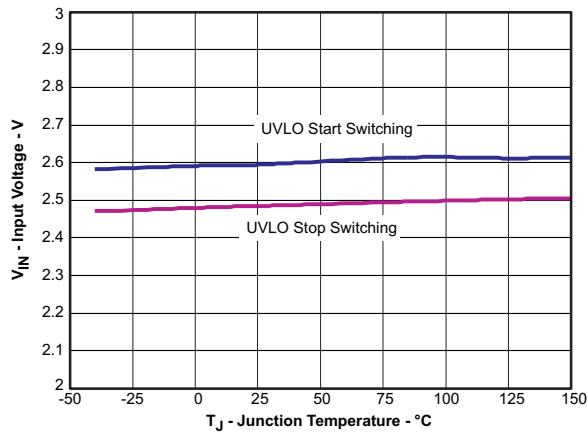

Figure 15. Input Voltage versus Junction Temperature

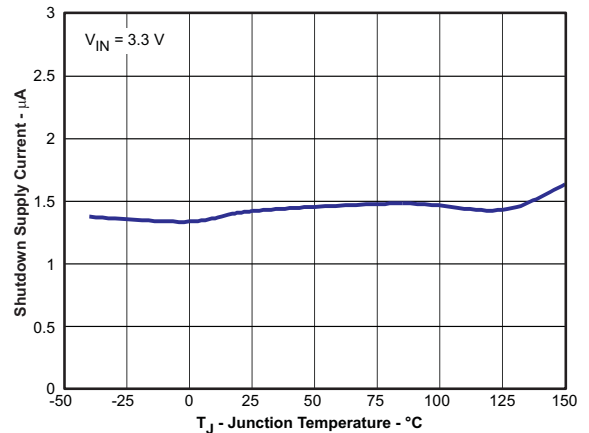

Figure 16. Shutdown Supply Current versus Junction Temperature

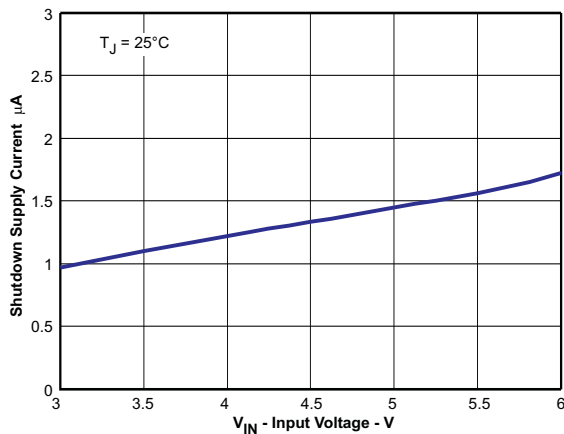

Figure 17. Shutdown Supply Current versus Input Voltage

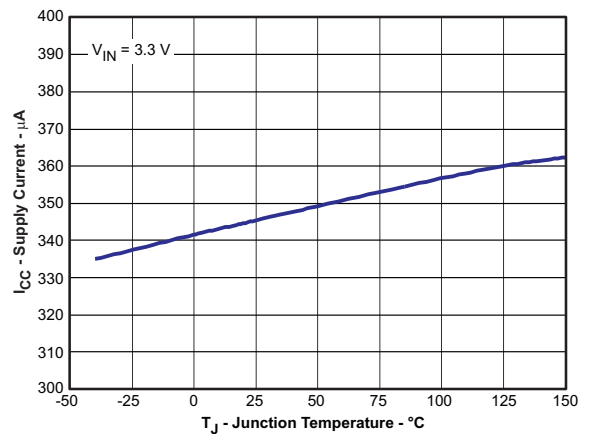

Figure 18. Supply Current versus Junction Temperature

Typical Characteristics (continued)

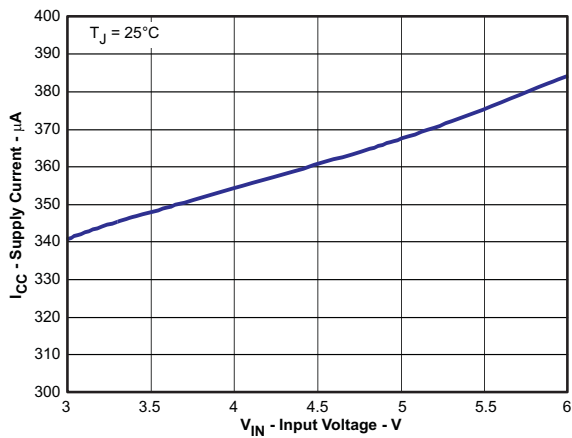

Figure 19. Supply Current versus Input Voltage

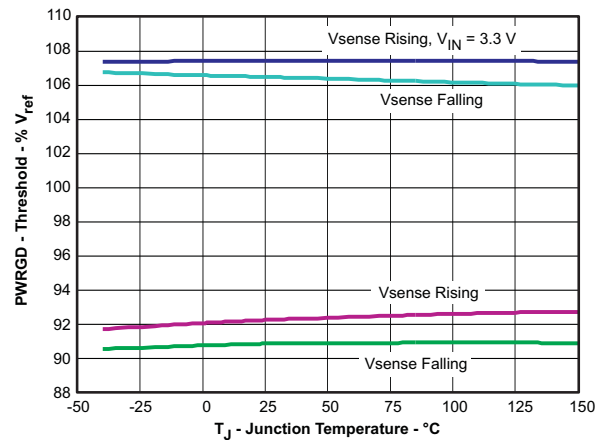

Figure 20. PWRGD Threshold versus Junction Temperature

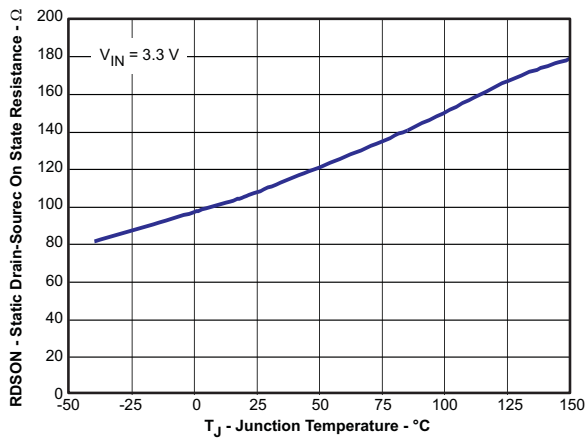

Figure 21. PWRGD On Resistance versus Junction Temperature

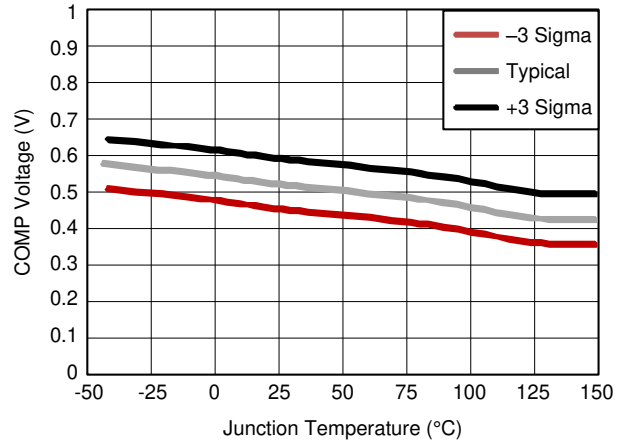

Figure 22. Minimum Comp Voltage Clamp versus Junction Temperature

## 7 Detailed Description

### 7.1 Overview

The TPS54218 device is a 6-V, 2-A, synchronous step-down (buck) converter with two integrated n-channel MOSFETs. To improve performance during line and load transients, the device implements a constant frequency, peak current mode control that reduces output capacitance and simplifies external frequency compensation design. The wide supported switching frequency range of 200 kHz to 2000 kHz allows efficiency and size optimization when selecting the output filter components. The switching frequency is adjusted using a resistor to ground on the RT/CLK pin. The device has an internal phase lock loop (PLL) on the RT/CLK pin that is used to synchronize the power switch turn on to a falling edge of an external system clock.

The TPS54218 device has a typical default start-up voltage of 2.6 V. The EN pin has an internal pullup current source that can be used to adjust the input voltage undervoltage lockout (UVLO) with two external resistors. In addition, the pullup current provides a default condition when the EN pin is floating for the device to operate. The total operating current for the TPS54218 device is 350  $\mu$ A when not switching and under no load. When the device is disabled, the supply current is less than 5  $\mu$ A.

The integrated, 30-m $\Omega$  MOSFETs allow for high-efficiency power supply designs with continuous output currents up to 2 amperes.

The TPS54218 device reduces the external component count by integrating the boot recharge diode. The bias voltage for the integrated high-side MOSFET is supplied by a capacitor on the BOOT to PH pin. The boot capacitor voltage is monitored by an UVLO circuit and turns off the high-side MOSFET when the voltage falls below a preset threshold. This BOOT circuit allows the TPS54218 device to operate approaching 100%. The output voltage can be stepped down to as low as the 0.8-V reference.

The TPS54218 device has a power-good comparator (PWRGD) with 2% hysteresis.

The TPS54218 device minimizes excessive output overvoltage transients by taking advantage of the overvoltage power-good comparator. When the regulated output voltage is greater than 109% of the nominal voltage, the overvoltage comparator is activated, and the high-side MOSFET is turned off and masked from turning on until the output voltage is lower than 105%.

The SS (soft start) pin is used to minimize inrush currents or provide power supply sequencing during power up. A small value capacitor must be coupled to the pin for soft start. The SS pin is discharged before the output power up to ensure a repeatable re-start after an overtemperature fault, UVLO fault, or disabled condition.

The use of a frequency-foldback circuit reduces the switching frequency during start-up and overcurrent fault conditions to help limit the inductor current.

## 7.2 Functional Block Diagram

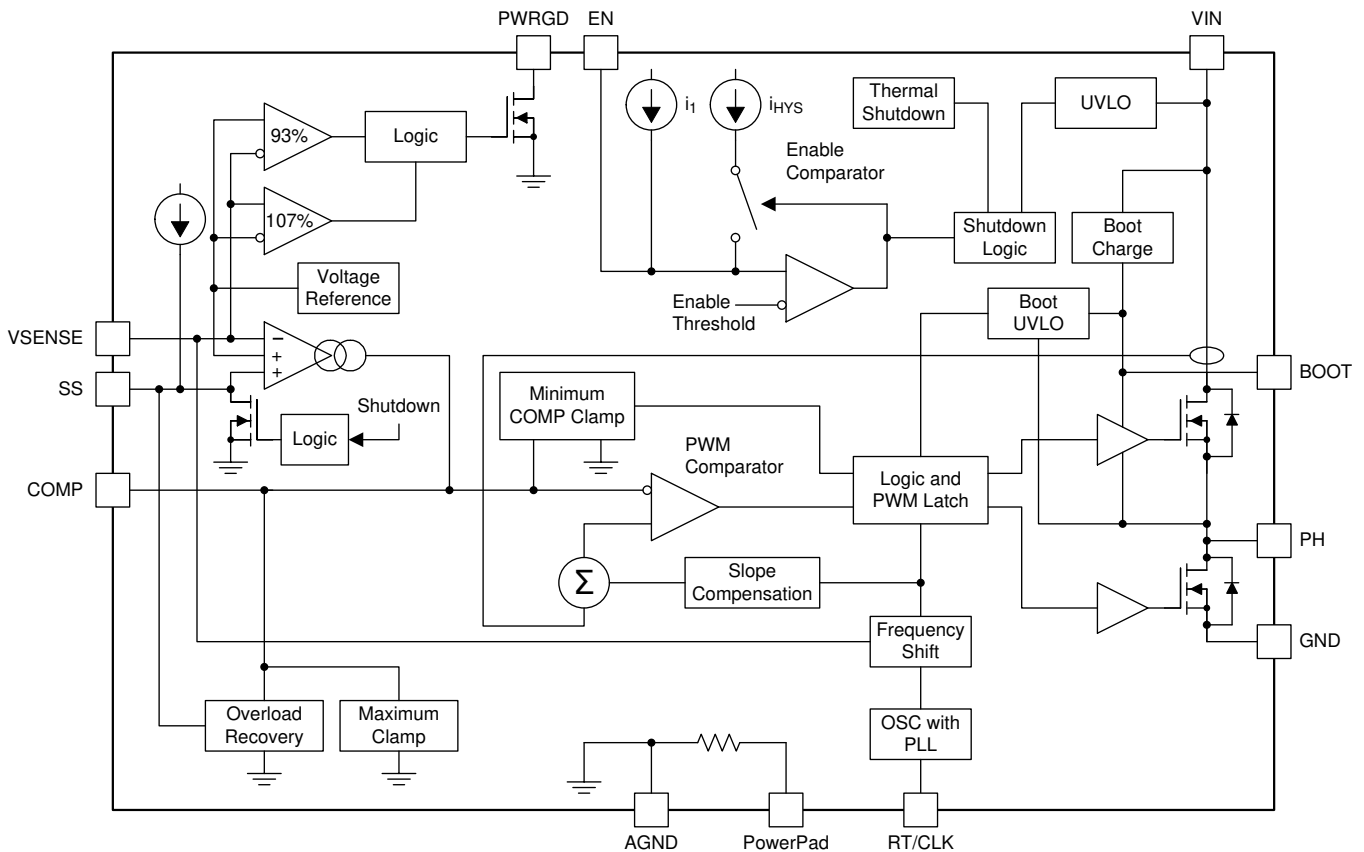

## 7.3 Feature Description

### 7.3.1 Fixed Frequency PWM Control

The TPS54218 device uses an adjustable fixed-frequency peak-current-mode control. The output voltage is compared through external resistors on the VSENSE to pin an internal voltage reference by an error amplifier that drives the COMP pin. An internal oscillator initiates the turnon of the high-side power switch. The error amplifier output is compared to the high-side power-switch current. When the power switch reaches the COMP voltage, the high-side power switch is turned off and the low-side power switch is turned on.

The COMP pin voltage increases and decreases as the peak switch current increases and decreases. The device implements a current-limit function by clamping the COMP pin voltage to a maximum value, which limits the maximum peak current the device supplies. The device also implements a minimum COMP pin voltage clamp for improved transient response. When the COMP pin voltage is pushed low to the minimum clamp, like during a load release event, turnon of the high-side power switch is inhibited.

### 7.3.2 Slope Compensation and Output Current

The TPS54218 device adds a compensating ramp to the switch current signal. This slope compensation prevents subharmonic oscillations as duty cycle increases. The available peak inductor current remains constant over the full duty cycle range.

### 7.3.3 Bootstrap Voltage (Boot) and Low Dropout Operation

The TPS54218 device has an integrated boot regulator and requires a small ceramic capacitor between the BOOT and PH pin to provide the gate drive voltage for the high-side MOSFET. The value of the ceramic capacitor must be 0.1  $\mu\text{F}$ . A ceramic capacitor with an X7R or X5R grade dielectric with a voltage rating of 10 V or higher is recommended because of the stable characteristics overtemperature and voltage.

## Feature Description (continued)

To improve dropout, the TPS54218 device is designed to operate at 100% duty cycle as long as the BOOT to PH pin voltage is greater than 2.5 V. The high-side MOSFET is turned off using an UVLO circuit, allowing for the low-side MOSFET to conduct when the voltage from BOOT to PH drops below 2.5 V. Because the supply current sourced from the BOOT pin is low, the high-side MOSFET can remain on for more switching cycles than are required to refresh the capacitor, thus the effective duty cycle of the switching regulator is high.

### 7.3.4 Error Amplifier

The TPS54218 device has a transconductance amplifier. The error amplifier compares the VSENSE voltage to the lower of the SS pin voltage or the internal 0.8-V voltage reference. The transconductance of the error amplifier is 225  $\mu\text{A}/\text{V}$  during normal operation. When the voltage of VSENSE pin is below 0.8 V and the device is regulating using the SS voltage, the transconductance is 70  $\mu\text{A}/\text{V}$ . The frequency compensation components are placed between the COMP pin and ground.

### 7.3.5 Voltage Reference

The voltage reference system produces a precise  $\pm 1\%$  voltage reference overtemperature by scaling the output of a temperature stable bandgap circuit. The bandgap and scaling circuits produce 0.8 V at the non-inverting input of the error amplifier.

### 7.3.6 Adjusting the Output Voltage

The output voltage is set with a resistor divider from the output node to the VSENSE pin. It is recommended to use divider resistors with 1% tolerance or better. Start with a value of 100 k $\Omega$  for the R1 resistor and use Equation 1 to calculate R2. To improve efficiency at very light loads, consider using larger resistor values. If the values are too high, the regulator is more susceptible to noise and voltage errors from the VSENSE input current are noticeable.

$$R2 = R1 \times \left( \frac{0.8 \text{ V}}{V_O - 0.8 \text{ V}} \right) \quad (1)$$

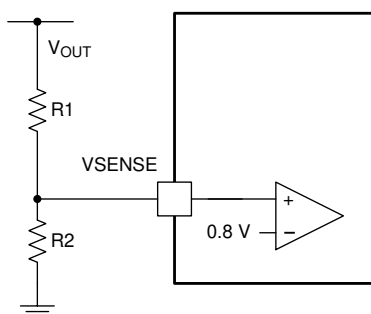

**Figure 23. Voltage Divider Circuit**

### 7.3.7 Enable and Adjusting Undervoltage Lockout

The TPS54218 device is disabled when the VIN pin voltage falls below 2.6 V. If an application requires a higher undervoltage lockout (UVLO), use the EN pin as shown in Figure 24 to adjust the input voltage UVLO by using two external resistors. It is recommended to use the enable resistors to set the UVLO falling threshold ( $V_{\text{STOP}}$ ) above 2.7 V. The rising threshold ( $V_{\text{START}}$ ) must be set to provide enough hysteresis to allow for any input supply variations. The EN pin has an internal pullup current source that provides the default condition of the TPS54218 device operating when the EN pin floats. Once the EN pin voltage exceeds 1.25 V, an additional 2.55  $\mu\text{A}$  of hysteresis is added. When the EN pin is pulled below 1.18 V, the 2.55  $\mu\text{A}$  is removed. This additional current facilitates input voltage hysteresis.

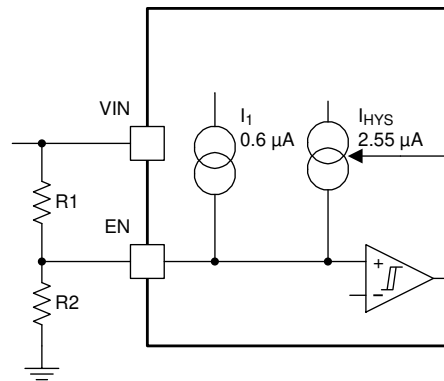
**Feature Description (continued)**

**Figure 24. Adjustable Undervoltage Lockout**

$$R1 = \frac{0.944 \cdot V_{\text{START}} - V_{\text{STOP}}}{2.59 \times 10^{-6}} \quad (2)$$

$$R2 = \frac{1.18 \cdot R1}{V_{\text{STOP}} - 1.18 + R1 \cdot 3.2 \times 10^{-6}} \quad (3)$$

**7.3.8 Soft-Start Pin**

The TPS54218 device regulates to the lower of the SS pin and the internal reference voltage. A capacitor on the SS pin to ground implements a soft-start time. The TPS54218 device has an internal pullup current source of 2.07  $\mu\text{A}$  that charges the external soft-start capacitor. Equation 4 calculates the required soft-start capacitor value where  $t_{\text{SS}}$  is the desired soft-start time in ms,  $I_{\text{SS}}$  is the internal soft-start charging current of 2.07  $\mu\text{A}$ , and 0.9 V is the SS pin voltage at the SS to reference crossover point. Equation 4 represents a first order linear approximation of the SS time using the well-known relationship  $I = C \times dV / dt$ . A constant current charging a capacitor results in a fixed value for  $dV / dt$  and a linear charge from 0 V to the 0.9 V SS to reference crossover voltage. In use, there are two factors that cause the actual output voltage to deviate from this linear ideal ramp. At the initial start, the COMP pin voltage can be below the minimum skip voltage. The TPS54218 does not begin to switch and the output voltage does not start to rise until the RC compensation network from COMP to GND has charged above the skip threshold. At the end of the SS time, when the output has reached 90% of its final regulated value, a “soft handoff” occurs to transition from the SS pin voltage to the internal reference at the non-inverting terminal of the error amplifier. When the SS pin voltage is at 0.9 V, the output voltage is defined to be within 98% typical of the final regulated voltage.

$$C_{\text{SS}} = \frac{I_{\text{SS}} \times t_{\text{SS}}}{0.9 \text{ V}}$$

where

- $C_{\text{SS}}$  is in nF
- $t_{\text{SS}}$  is in ms
- $I_{\text{SS}}$  is in  $\mu\text{A}$

(4)

It is recommended to maintain the soft-start time in the range between 1 msec and 10 msec.

There are two conditions that can cause the SS pin to be intentionally discharged. If a fault condition occurs that results in the COMP pin voltage reaching its maximum voltage as during an overcurrent condition, the comp pin is discharged to below 20 mV. Only the discharge voltage is specified, not the discharge current. This allows the TPS54218 to gracefully recover from an overcurrent condition that can reduce the output voltage. If during normal operation, the input voltage goes below the UVLO, the EN pin is pulled below 1.2 V, or a thermal shutdown event occurs, the TPS54218 stops switching and the SS capacitor is discharged before reinitiating a powering up sequence. See Figure 46 for an example of this discharge behavior.



## Feature Description (continued)

### 7.3.9 Sequencing

Many of the common power supply sequencing methods can be implemented using the SS, EN, and PWRGD pins. The sequential method can be implemented using an open drain or collector output of a power on reset pin of another device. Figure 25 shows the sequential method. The power good is coupled to the EN pin on the TPS54218 device which enables the second power supply once the primary supply reaches regulation.

Ratiometric start-up can be accomplished by connecting the SS pins together. The regulator outputs ramp up and reach regulation at the same time. When calculating the soft-start time, the pullup current source must be doubled in Equation 4. The ratiometric method is shown in Figure 27.

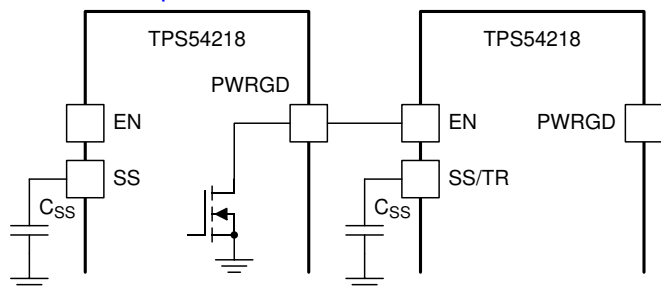

Figure 25. Sequential Start-up Schematic

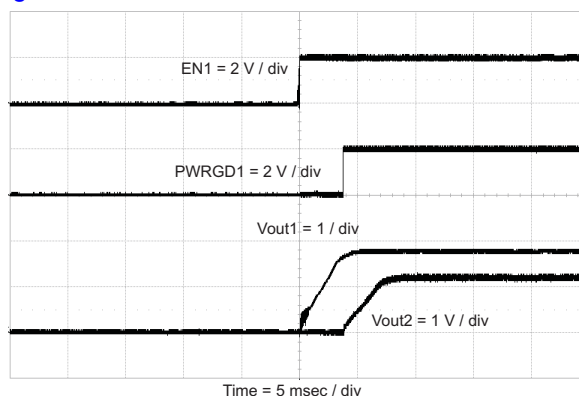

Figure 26. Sequential Start-up using EN and PWRGD

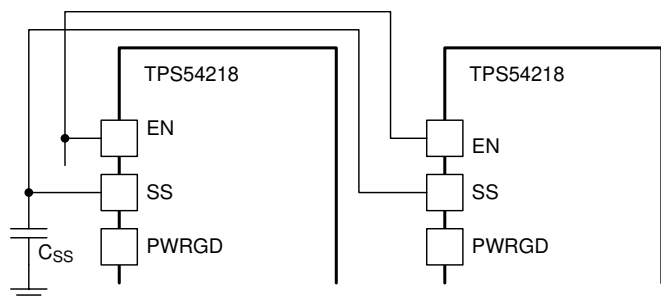

Figure 27. Ratiometric Start-up Schematic

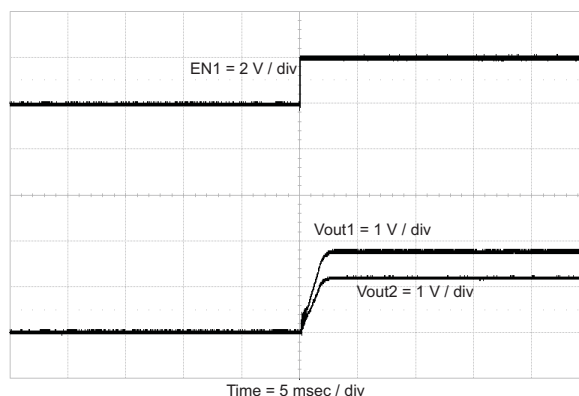

Figure 28. Ratiometric Start-up Using Coupled SS Pins

### 7.3.10 Constant Switching Frequency and Timing Resistor (RT/CLK Pin)

The switching frequency of the TPS54218 device is adjustable over a wide range by placing a maximum of 1000 kΩ and minimum of 85 kΩ, respectively, on the RT/CLK pin. An internal amplifier holds this pin at a fixed voltage when using an external resistor to ground to set the switching frequency. The RT/CLK is typically 0.5 V. To determine the timing resistance for a given switching frequency, use the curve in Figure 5 or Figure 6 or Equation 5.

$$R_{RT} = \frac{311890}{(f_{SW})^{1.0793}}$$

where

- $R_{RT}$  is in kΩ
- $f_{SW}$  is in kHz

(5)

## Feature Description (continued)

$$f_{\text{SW}} = \frac{133870}{(R_{\text{RT}})^{0.9393}}$$

where

- $R_{\text{RT}}$  is in  $k\Omega$
- $f_{\text{SW}}$  is in kHz

(6)

To reduce the solution size, one would typically set the switching frequency as high as possible, but tradeoffs of the efficiency, maximum input voltage, and minimum controllable on-time must be considered.

The minimum controllable on-time is typically 60 ns at full current load and 110 ns at no load, and limits the maximum operating input voltage or output voltage.

### 7.3.11 Overcurrent Protection

The TPS54218 device implements a cycle-by-cycle current limit. During each switching cycle, the high-side switch current is compared to the voltage on the COMP pin. When the instantaneous switch current intersects the COMP voltage, the high-side switch is turned off. During overcurrent conditions that pull the output voltage low, the error amplifier responds by driving the COMP pin high, increasing the switch current. The error amplifier output is clamped internally. This clamp functions as a switch current limit.

### 7.3.12 Frequency Shift

To operate at high switching frequencies and provide protection during overcurrent conditions, the TPS54218 device implements a frequency shift. If frequency shift was not implemented, during an overcurrent condition, the low-side MOSFET may not be turned off long enough to reduce the current in the inductor, causing a current runaway. With frequency shift, during an overcurrent condition, the switching frequency is reduced from 100%, then 75%, then 50%, then 25% as the voltage decreases from 0.8 to 0 volts on the VSENSE pin to allow the low-side MOSFET to be off long enough to decrease the current in the inductor. During start-up, the switching frequency increases as the voltage on VSENSE increases from 0 to 0.8 volts. See [Figure 7](#) for details.

### 7.3.13 Reverse Overcurrent Protection

The TPS54218 device implements low-side current protection by detecting the voltage across the low-side MOSFET. When the converter sinks current through its low-side FET, the control circuit turns off the low-side MOSFET if the reverse current is more than 1.3 A. By implementing this additional protection scheme, the converter is able to protect itself from excessive current during power cycling and start-up into pre-biased outputs.

### 7.3.14 Synchronize Using the RT/CLK Pin

The RT/CLK pin is used to synchronize the converter to an external system clock. See [Figure 29](#). To implement the synchronization feature in a system, connect a square wave to the RT/CLK pin with an on-time of at least 75 ns. If the pin is pulled above the PLL upper threshold, a mode change occurs and the pin becomes a synchronization input. The internal amplifier is disabled and the pin is a high impedance clock input to the internal PLL. If clocking edges stop, the internal amplifier is re-enabled and the mode returns to the frequency set by the resistor. The square wave amplitude at this pin must transition lower than 0.6 V and higher than 1.6 V typically. The recommended synchronization frequency range is 300 kHz to 2000 kHz. If the external system clock is to be removed, TI recommends that it be removed on the falling edge of the clock.

## Feature Description (continued)

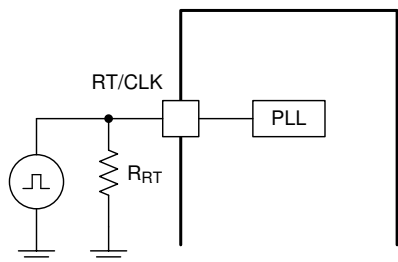

Figure 29. Synchronizing to a System Clock

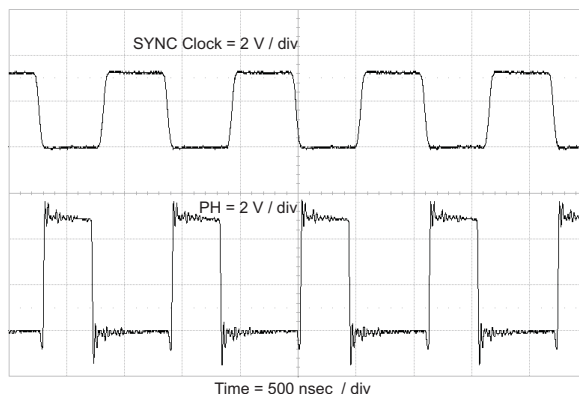

Figure 30. Plot of Synchronizing to System Clock

### 7.3.15 Power Good (PWRGD Pin)

The PWRGD pin output is an open-drain MOSFET. The output is pulled low when the VSENSE voltage enters the fault condition by falling below 91% or rising above 107% of the nominal internal reference voltage. There is a 2% hysteresis on the threshold voltage, so when the VSENSE voltage rises to the good condition above 93% or falls below 105% of the internal voltage reference the PWRGD output MOSFET is turned off. It is recommended to use a pullup resistor between the values of 1 k $\Omega$  and 100 k $\Omega$  to a voltage source that is 6 V or less. The PWRGD is in a valid state once the VIN input voltage is greater than 1.2 V.

### 7.3.16 Overvoltage Transient Protection

The TPS54218 device incorporates an overvoltage transient protection (OVTP) circuit to minimize voltage overshoot when recovering from output fault conditions or strong unload transients. The OVTP feature minimizes the output overshoot by implementing a circuit to compare the VSENSE pin voltage to the OVTP threshold which is 109% of the internal voltage reference. If the VSENSE pin voltage is greater than the OVTP threshold, the high-side MOSFET is disabled, preventing current from flowing to the output and minimizing output overshoot. When the VSENSE voltage drops lower than the OVTP threshold, the high-side MOSFET is allowed to turn on the next clock cycle.

### 7.3.17 Thermal Shutdown

The device implements an internal thermal shutdown to protect itself if the junction temperature exceeds 175°C. The thermal shutdown forces the device to stop switching when the junction temperature exceeds the thermal trip threshold. Once the die temperature decreases below 160°C, the device reinitiates the power-up sequence by discharging the SS pin to 0 volts. The thermal shutdown hysteresis is 15°C.

## 7.4 Device Functional Modes

### 7.4.1 Small Signal Model for Loop Response

Figure 31 shows an equivalent model for the TPS54218 device control loop which can be modeled in a circuit simulation program to check frequency response and dynamic load response. The error amplifier is a transconductance amplifier with a  $g_M$  of 225  $\mu\text{A/V}$ . The error amplifier can be modeled using an ideal voltage controlled current source. The resistor  $R_{\text{OUT(ea)}}$  and capacitor  $C_{\text{OUT(ea)}}$  model the open loop gain and frequency response of the amplifier. The 1-mV AC voltage source between the nodes a and b effectively breaks the control loop for the frequency response measurements. Plotting a/c shows the small signal response of the frequency compensation. Plotting a/b shows the small signal response of the overall loop. The dynamic loop response can be checked by replacing the  $R_{\text{LOAD}}$  with a current source with the appropriate load step amplitude and step rate in a time domain analysis.

Device Functional Modes (continued)

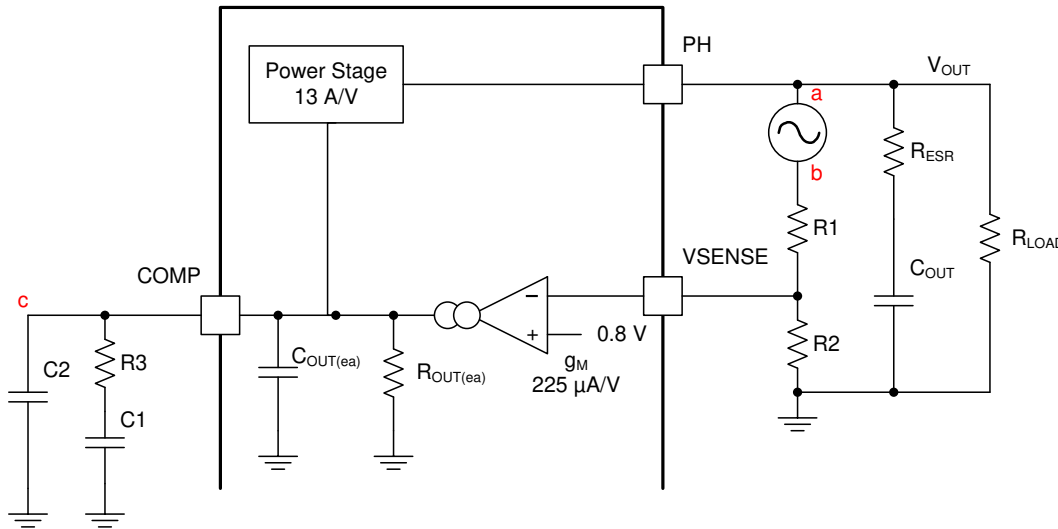

Figure 31. Small Signal Model for Loop Response

7.4.2 Simple Small Signal Model for Peak Current Mode Control

Figure 32 is a simple small signal model that can be used to understand how to design the frequency compensation. The TPS54218 device power stage can be approximated to a voltage controlled current source (duty cycle modulator) supplying current to the output capacitor and load resistor. The control to output transfer function is shown in Equation 7 and consists of a dc gain, one dominant pole, and one ESR zero. The quotient of the change in switch current and the change in COMP pin voltage (node c in Figure 31) is the power stage transconductance. The  $g_M$  for the TPS54218 device is 13 A/V. The low frequency gain of the power stage frequency response is the product of the transconductance and the load resistance as shown in Equation 8. As the load current increases and decreases, the low frequency gain decreases and increases, respectively. This variation with load can seem problematic at first glance, but the dominant pole moves with load current (see Equation 9). The combined effect is highlighted by the dashed line in the right half of Figure 33. As the load current decreases, the gain increases and the pole frequency lowers, keeping the 0-dB crossover frequency the same for the varying load conditions which makes it easier to design the frequency compensation.

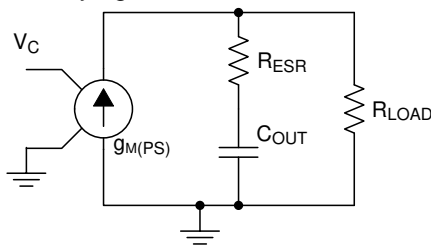

Figure 32. Simple Small Signal Model

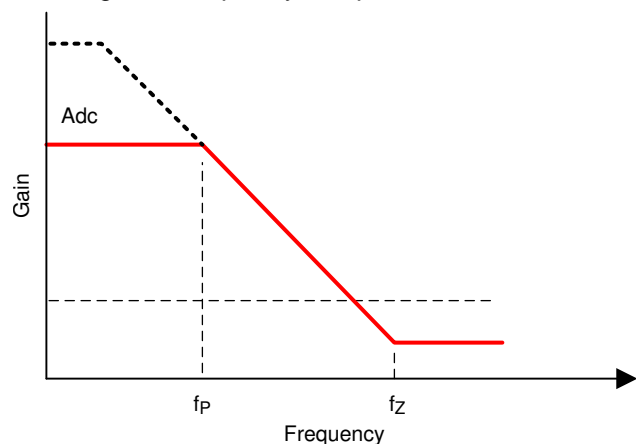

Figure 33. Frequency Response

$$\frac{V_{OUT}}{V_C} = A_{dc} \times \frac{1 + \left( \frac{s}{2\pi \times f_Z} \right)}{1 + \left( \frac{s}{2\pi \times f_P} \right)}$$

(7)

## Device Functional Modes (continued)

$$A_{dc} = g_{M(PS)} \times R_{LOAD} \quad (8)$$

$$f_p = \frac{1}{C_{OUT} \times R_{LOAD} \times 2\pi} \quad (9)$$

$$f_z = \frac{1}{C_{OUT} \times R_{ESR} \times 2\pi} \quad (10)$$

### 7.4.3 Small Signal Model for Frequency Compensation

The TPS54218 device uses a transconductance amplifier for the error amplifier and readily supports two of the commonly used frequency compensation circuits. The compensation circuits are shown in Figure 34. The Type-II circuits are most likely implemented in high bandwidth power supply designs using low-ESR output capacitors. In Type-IIA, one additional high frequency pole is added to attenuate high-frequency noise.

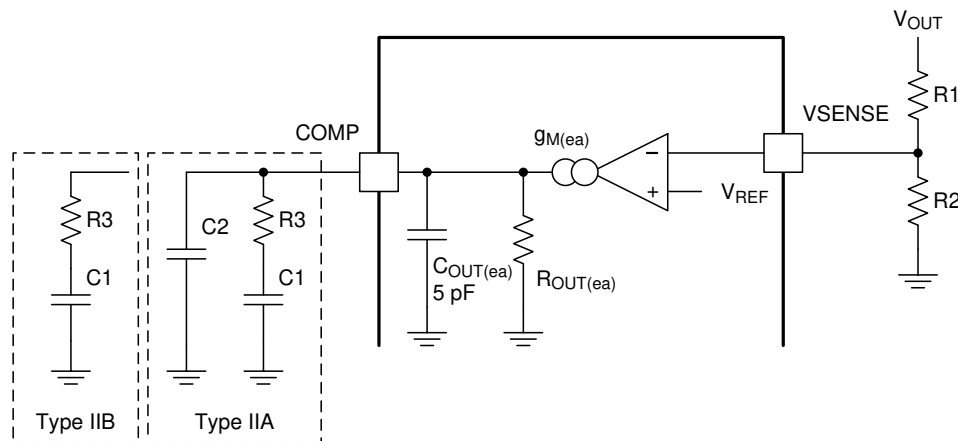

Figure 34. Types of Frequency Compensation

The design guidelines for TPS54218 device loop compensation are as follows:

1. Calculate the modulator pole ( $f_{P(MOD)}$ ) and the esr zero, ( $f_{z1}$ ) using Equation 11 and Equation 12. If the output voltage is a high percentage of the capacitor rating, it can be necessary to derate the output capacitor ( $C_{OUT}$ ). Use the capacitor manufacturer information to derate the capacitor value. Use Equation 13 and Equation 14 to estimate a starting point for the crossover frequency,  $f_c$ . Equation 13 shows the geometric mean of the modulator pole and the ESR zero and Equation 14 is the mean of modulator pole and the switching frequency. Use the lower value of Equation 13 or Equation 14 as the maximum crossover frequency.

$$f_{P(mod)} = \frac{I_{OUT(max)}}{2\pi \times V_{OUT} \times C_{OUT}} \quad (11)$$

$$f_{z1} = \frac{1}{C_{OUT} \times R_{ESR} \times 2\pi} \quad (12)$$

$$f_c = \sqrt{f_{P(mod)} + f_{z1}} \quad (13)$$

$$f_c = \sqrt{f_{P(mod)} \times \frac{f_{SW}}{2}} \quad (14)$$

**Device Functional Modes (continued)**

2. Calculate resistor R3. [Equation 15](#) shows the calculation for resistor R3.

$$R3 = \frac{2\pi \times f_C \times V_{OUT} \times C_{OUT}}{g_{M(ea)} \times V_{REF} \times g_{M(ps)}}$$

where

- $g_{M(ea)}$  is the amplifier gain (225  $\mu A/V$ )
- $g_{M(ps)}$  is the power stage gain (13 A/V) (15)

3. Place a compensation zero at the dominant pole,  $f_p$ . [Equation 16](#) shows the calculation for capacitor C1.

$$f_p = \frac{1}{C_{OUT} \times R_{LOAD} \times 2\pi}$$
(16)

$$C1 = \frac{R_L \times C_{OUT}}{R3}$$
(17)

4. Capacitor C2 is optional. It can be used to cancel the zero from the output capacitor ( $C_{OUT}$ ) ESR.

$$C2 = \frac{R_{ESR} \times C_{OUT}}{R3}$$
(18)

## 8 Application and Implementation

### NOTE

Information in the following applications sections is not part of the TI component specification, and TI does not warrant its accuracy or completeness. TI's customers are responsible for determining suitability of components for their purposes. Customers should validate and test their design implementation to confirm system functionality.

### 8.1 Application Information

This design example describes a high-frequency switching regulator design using ceramic output capacitors. This design is available as the evaluation module (EVM) HPA511 (*TPS54218EVM-511 2-A, SWIFT Regulator Evaluation Module User's Guide*).

### 8.2 Typical Application

This section details a high-frequency, 1.8-V output power supply design application with adjusted UVLO.

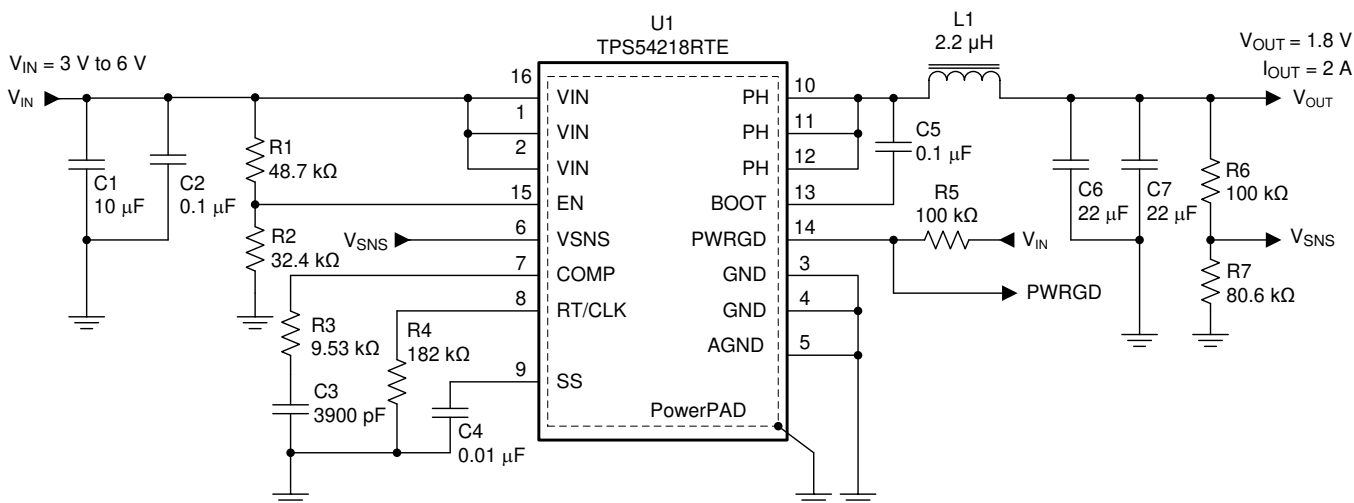

Figure 35. Typical Application Schematic, TPS54218

#### 8.2.1 Design Requirements

Table 1. Design Parameters

PARAMETER	NOTES AND CONDITIONS	MIN	TYP	MAX	UNIT
$V_{IN}$	Input voltage	3	3.3	6	V
$V_{START}$	Start input voltage		3.1		
$V_{STOP}$	Stop input voltage		2.8		
$V_{OUT}$	Output voltage		1.8		V
$\Delta V_{OUT}$	Transient response		3%		
$I_{OUT(max)}$	Maximum output current			2	A
$V_{OUT(ripple)}$	Output voltage ripple			30	mV <sub>P-P</sub>
$f_{SW}$	Switching frequency		1		MHz

## 8.2.2 Detailed Design Procedure

### 8.2.2.1 Step One: Select the Switching Frequency

Choose the highest switching frequency possible to produce the smallest solution size. The high switching frequency allows for lower valued inductors and smaller output capacitors compared to a power supply that switches at a lower frequency. However, the highest switching frequency causes extra switching losses, which in turn, decreases the device performance. The device is capable of operating between 200 kHz and 2 MHz. Select a moderate switching frequency of 1 MHz to achieve both a small solution size and a high-efficiency operation. Using Equation 5, R4 is calculated to 180 kΩ. A standard 1%, 182-kΩ resistor is used in the design.

### 8.2.2.2 Step Two: Select the Output Inductor

The inductor selected must operate across the entire TPS54218 device input voltage range. To calculate the value of the output inductor, use Equation 19.  $K_{IND}$  is a coefficient that represents the amount of inductor ripple current relative to the maximum output current. The inductor ripple current is filtered by the output capacitor. Therefore, choosing high inductor ripple currents impacts the selection of the output capacitor since the output capacitor must have a ripple current rating equal to or greater than the inductor ripple current. In general, the inductor ripple value is at the discretion of the designer; however,  $K_{IND}$  is normally from 0.1 to 0.3 for the majority of applications.

For this design example, use a  $K_{IND}$  of 0.3 and the inductor value is calculated to be 2.10 μH. For this design, use an inductor with the nearest standard value of 2.20 μH. For the output filter inductor, it is important that the RMS current and saturation current ratings not be exceeded. The RMS and peak inductor current can be calculated in Equation 21 and Equation 22.

The current flowing through the inductor is the inductor ripple current plus the output current. During power up, faults, or transient load conditions, the inductor current can increase above the calculated peak inductor current level calculated above. In transient conditions, the inductor current can increase up to the switch current limit of the device. For this reason, the most conservative approach is to specify an inductor with a saturation current rating equal to or greater than the switch current limit rather than the peak inductor current.

$$L1 = \frac{(V_{IN(max)} - V_{OUT})}{I_{OUT} \times K_{IND}} \times \frac{V_{OUT}}{V_{IN(max)} \times f_{SW}} \quad (19)$$

$$I_{RIPPLE} = \frac{(V_{IN(max)} - V_{OUT})}{L1} \times \frac{V_{OUT}}{V_{IN(max)} \times f_{SW}} \quad (20)$$

$$I_{L(rms)} = \sqrt{(I_{OUT})^2 + \frac{1}{12} \times \left( \frac{V_{OUT} \times (V_{IN(max)} - V_{OUT})}{V_{IN(max)} \times L1 \times f_{SW}} \right)^2} \quad (21)$$

$$I_{L(peak)} = I_{OUT} + \left( \frac{I_{RIPPLE}}{2} \right) \quad (22)$$

### 8.2.2.3 Step Three: Choose the Output Capacitor

There are three primary considerations for selecting the value of the output capacitor. The output capacitor determines the modulator pole, the output voltage ripple, and how the regulator responds to a large change in load current. The output capacitance needs to be selected based on the more stringent of these three criteria.

The desired response to a large change in the load current is the first criteria. The output capacitor needs to supply the load with current when the regulator cannot. This situation would occur if there are desired hold-up times for the regulator where the output capacitor must hold the output voltage above a certain level for a specified amount of time after the input power is removed. The regulator is temporarily not able to supply sufficient output current if there is a large, fast increase in the current needs of the load such as transitioning from no load to a full load. The regulator usually needs two or more clock cycles for the control loop to see the



change in load current and output voltage and adjust the duty cycle to react to the change. The output capacitor must be sized to supply the extra current to the load until the control loop responds to the load change. The output capacitance must be large enough to supply the difference in current for two clock cycles while only allowing a tolerable amount of droop in the output voltage. Equation 25 shows the necessary minimum output capacitance.

For this example, the transient load response is specified as a 3% change in  $V_{OUT}$  for a load step from 1 A (50% load) to 2 A (100%).

$$\Delta I_{OUT} = 2 - 1 = 1 \text{ A} \quad (23)$$

$$\Delta V_{OUT} = 0.03 \times 1.8 = 0.054 \text{ V} \quad (24)$$

Using these numbers gives a minimum capacitance of 37  $\mu\text{F}$ . This value does not take the ESR of the output capacitor into account in the output voltage change. For ceramic capacitors, the ESR is usually small enough to ignore in this calculation.

Equation 26 calculates the minimum output capacitance needed to meet the output voltage ripple specification where  $f_{SW}$  is the switching frequency,  $V_{RIPPLE}$  is the maximum allowable output voltage ripple, and  $I_{RIPPLE}$  is the inductor ripple current. In this case, the maximum output voltage ripple is 30 mV. Equation 26 yields 2.38  $\mu\text{F}$ .

$$C_{OUT(\text{transient})} > \frac{2 \times \Delta I_{IOUT}}{f_{SW} \times \Delta V_{OUT}} \quad (25)$$

$$C_{OUT(\text{ripple})} > \frac{I_{Ripple}}{8 \times f_{SW} \times V_{OUT(\text{ripple})}} \quad (26)$$

where

- $\Delta I_{OUT}$  is the load step size
- $\Delta V_{OUT}$  is the acceptable output deviation
- $f_{SW}$  is the switching frequency
- $I_{Ripple}$  is the inductor ripple current
- $V_{OUT(Ripple)}$  is the acceptable DC output voltage ripple

Equation 27 calculates the maximum ESR an output capacitor can have to meet the output voltage ripple specification. Equation 27 indicates the ESR must be less than 26 m $\Omega$ . In this case, the ESR of the ceramic capacitor is much less than 26 m $\Omega$ .

Additional capacitance de-ratings for aging, temperature, and DC bias must be factored in, which increases this minimum value. For this example, two 22- $\mu\text{F}$ , 10-V, X5R ceramic capacitors with 3 m $\Omega$  of ESR are used.

Capacitors generally have limits to the amount of ripple current they can handle without failing or producing excess heat. An output capacitor that can support the inductor ripple current must be specified. Some capacitor data sheets specify the RMS (root mean square) value of the maximum ripple current. Equation 28 can be used to calculate the RMS ripple current the output capacitor needs to support. For this application, Equation 28 yields 151 mA.

$$R_{ESR} < \frac{V_{OUT(\text{ripple})}}{I_{Ripple}} \quad (27)$$

$$I_{CO(\text{rms})} = \frac{V_{OUT} \times (V_{IN(\text{max})} - V_{OUT})}{\sqrt{12} \times V_{IN(\text{max})} \times L1 \times f_{SW}} \quad (28)$$

#### 8.2.2.4 Step Four: Select the Input Capacitor

The TPS54218 device requires a high quality ceramic, type X5R or X7R, input decoupling capacitor of at least 4.7  $\mu\text{F}$  of effective capacitance and in some applications a bulk capacitance. The effective capacitance includes any DC bias effects. The voltage rating of the input capacitor must be greater than the maximum input voltage. The capacitor must also have a ripple current rating greater than the maximum input current ripple of the device. The input ripple current can be calculated using Equation 29.

The value of a ceramic capacitor varies significantly over temperature and the amount of DC bias applied to the capacitor. The capacitance variations due to temperature can be minimized by selecting a dielectric material that is stable over temperature. X5R and X7R ceramic dielectrics are usually selected for power regulator capacitors because they have a high capacitance-to-volume ratio and are fairly stable over temperature. The output capacitor must also be selected with the dc bias taken into account. The capacitance value of a capacitor decreases as the dc bias across a capacitor increases.

For this example design, a ceramic capacitor with at least a 10-V voltage rating is required to support the maximum input voltage. For this example, one 10- $\mu\text{F}$  and one 0.1- $\mu\text{F}$ , 10-V capacitors in parallel have been selected. The input capacitance value determines the input ripple voltage of the regulator. The input voltage ripple can be calculated using [Equation 30](#).

$$I_{CIN(rms)} = I_{OUT} \times \sqrt{\frac{V_{OUT}}{V_{IN(min)}} \times \frac{(V_{IN(min)} - V_{OUT})}{V_{IN(min)}}} \quad (29)$$

$$\Delta V_{IN} = \frac{I_{OUT(max)} \times 0.25}{C_{IN} \times f_{SW}} \quad (30)$$

Using the design example values,  $I_{OUT(max)} = 2 \text{ A}$ ,  $C_{IN} = 10 \mu\text{F}$ , and  $f_{SW} = 1 \text{ MHz}$ , yields an input voltage ripple of 34 mV and a rms input ripple current of 0.98 A.

### 8.2.2.5 Step Five: Minimum Load DC COMP Voltage

The TPS54218 implements a minimum COMP voltage clamp for improved load-transient response. The COMP voltage tracks the peak inductor current, increasing as the peak inductor current increases, and decreasing as the peak inductor current decreases. During a severe load-dump event, for instance, the COMP voltage decreases suddenly, falls below the minimum clamp value, then settles to a lower DC value as the control loop compensates for the transient event. During the time when COMP reaches the minimum clamp voltage, turnon of the high-side power switch is inhibited, keeping the low-side power switch on to discharge the output voltage overshoot more quickly.

Proper application circuit design must ensure that the minimum load steady-state COMP voltage is above the +3 sigma minimum clamp to avoid unwanted inhibition of the high-side power switch. For a given design, the steady-state DC level of COMP must be measured at the minimum designed load and at the maximum designed input voltage, then compared to the minimum COMP clamp voltage shown in [Figure 22](#). These conditions give the minimum COMP voltage for a given design. Generally, the COMP voltage and minimum clamp voltage move by about the same amount with temperature. Increasing the minimum load COMP voltage is accomplished by decreasing the output inductor value or the switching frequency used in a given design.

### 8.2.2.6 Step Six: Choose the Soft-Start Capacitor

The soft-start capacitor determines the minimum amount of time it takes for the output voltage to reach its nominal programmed value during power up. This is useful if a load requires a controlled voltage slew rate. This is also used if the output capacitance is very large and would require large amounts of current to quickly charge the capacitor to the output voltage level. The large currents necessary to charge the capacitor can make the device reach the current limit or excessive current draw from the input power supply can cause the input voltage rail to sag. Limiting the output voltage slew rate solves both of these problems.

The soft-start capacitor value can be calculated using [Equation 31](#). For the example circuit, the soft-start time is not too critical since the output capacitor value is 44  $\mu\text{F}$ , which does not require much current to charge to 1.8 V. The example circuit has the soft-start time set to an arbitrary value of 4 ms, which requires a 9.2-nF capacitor. The nearest standard value of 10 nF is used, resulting in a calculated soft-start time of 4.3 msec. In the device,  $I_{SS}$  is 2.07  $\mu\text{A}$ . For this application, maintain the soft-start time in the range between 1 ms and 10 ms.

$$C_{SS} = \frac{I_{SS} \times t_{SS}}{0.9 \text{ V}}$$

where

- $C_{SS}$  is in nF
- $I_{SS}$  is in  $\mu\text{A}$
- $t_{SS}$  is in ms

(31)

### 8.2.2.7 Step Seven: Select the Bootstrap Capacitor

A 0.1- $\mu$ F ceramic capacitor must be connected between the BOOT to PH pin for proper operation. It is recommended to use a ceramic capacitor with X5R or better grade dielectric. The capacitor must have 10 V or higher voltage rating.

### 8.2.2.8 Step Eight: Undervoltage Lockout Threshold

The undervoltage lockout (UVLO) can be adjusted using an external voltage divider on the EN pin of the TPS54218. The UVLO has two thresholds, one for power up when the input voltage is rising, and one for power down or brown outs when the input voltage is falling. For the example design, the supply must turn on and start switching once the input voltage increases above 3.1 V ( $V_{START}$ ). Switching continues until the input voltage falls below 2.8 V ( $V_{STOP}$ ).

The programmable UVLO and enable voltages are set using a resistor divider between the VIN pin and GND to the EN pin. Equation 32 and Equation 33 can be used to calculate the resistance values necessary. From Equation 32 and Equation 33, a 48.7-k $\Omega$  resistor between the VIN pin and the EN pin and a 32.4-k $\Omega$  resistor between the EN pin and GND are required to produce the 3.1-V start voltage and the 2.8-V stop voltage.

$$R1 = \frac{0.944 \cdot V_{START} - V_{STOP}}{2.59 \times 10^{-6}} \quad (32)$$

$$R2 = \frac{1.18 \cdot R1}{V_{STOP} - 1.18 + R1 \cdot 3.2 \times 10^{-6}} \quad (33)$$

### 8.2.2.9 Step Nine: Select Output Voltage and Feedback Resistors

For the example design, 100 k $\Omega$  was selected for R6. Using Equation 34, R7 is calculated as 80 k $\Omega$ . The nearest standard 1% resistor is 80.6 k $\Omega$ .

$$R7 = \frac{V_{ref}}{V_{OUT} - V_{ref}} R6 \quad (34)$$

#### 8.2.2.9.1 Output Voltage Limitations

Due to the internal design of the TPS54218, there are limitations to the minimum and maximum achievable output voltages. The output voltage can never be lower than the internal voltage reference of 0.8 V. Above 0.8 V, the output voltage can be limited by the minimum controllable on-time. The minimum output voltage in this case is given by Equation 35. There is also a maximum achievable output voltage which is limited by the minimum off-time. The maximum output voltage is given by Equation 36. These equations represent the results when the power MOSFETs are matched. Refer to the [Understanding Output Voltage Limitations of DC/DC Buck Converters Technical Brief](#) for more information.

$$V_{OUT(min)} = t_{ON(min)} \times f_{SW(max)} \times V_{IN(max)} - I_{OUT(min)}(R_{LS(min)} + R_{DCR})$$

where

- $V_{OUT(min)}$  is the minimum achievable output voltage
  - $t_{ON(min)}$  is the minimum controllable on-time (110 nsec typical)
  - $f_{SW(max)}$  is the maximum switching frequency including tolerance
  - $V_{IN(max)}$  is the maximum input voltage
  - $I_{OUT(min)}$  is the minimum load current
  - $R_{LS(min)}$  is the minimum low-side MOSFET on-resistance (30 m $\Omega$  typical)
  - $R_{DCR}$  is the series resistance of output inductor
- (35)

$$V_{OUT(max)} = (1 - t_{OFF(max)} f_{SW(max)}) V_{IN(min)} - I_{OUT(max)} (R_{LS(max)} + R_{DCR})$$

where

- $V_{OUT(max)}$  is the maximum achievable output voltage
  - $t_{OFF(max)}$  is the maximum, minimum controllable off-time (60 ns typical)
  - $f_{SW(max)}$  is the maximum switching frequency including tolerance
  - $V_{IN(min)}$  is the minimum input voltage
  - $I_{OUT(max)}$  is the maximum load current
  - $R_{HS(max)}$  is the maximum high-side MOSFET on-resistance (70 mΩ max)
  - $R_{DCR}$  is the series resistance of output inductor
- (36)

### 8.2.2.10 Step 10: Select Loop Compensation Components

There are several industry techniques used to compensate DC/DC regulators. The method presented here is easy to calculate and yields high phase margins. For most conditions, the regulator has a phase margin between 60 and 90 degrees. The method presented here ignores the effects of the slope compensation that is internal to the TPS54218. Because the slope compensation is ignored, the actual crossover frequency is usually lower than the crossover frequency used in the calculations.

To get started, the modulator pole,  $f_{P(mod)}$ , and the esr zero,  $f_{Z1}$ , must be calculated using [Equation 37](#) and [Equation 38](#). For  $C_{OUT}$ , derating the capacitor is not needed as the 1.8-V output is a small percentage of the 10-V capacitor rating. If the output is a high percentage of the capacitor rating, use the capacitor manufacturer information to derate the capacitor value. Use [Equation 39](#) and [Equation 40](#) to estimate a starting point for the crossover frequency,  $f_C$ . For the example design,  $f_{P(mod)}$  is 4.02 kHz and  $f_{Z1}$  is 1206 kHz. [Equation 39](#) is the geometric mean of the modulator pole and the esr zero and [Equation 40](#) is the mean of modulator pole and the switching frequency. [Equation 39](#) yields 69.6 kHz and [Equation 40](#) gives 44.8 kHz. Use the lower value of [Equation 39](#) or [Equation 40](#) as the maximum crossover frequency. For this example,  $f_C$  is 45 kHz. Next, the compensation components are calculated. A resistor in series with a capacitor is used to create a compensating zero. A capacitor in parallel to these two components forms the compensating pole (if needed).

$$f_{P(mod)} = \frac{I_{OUT(max)}}{2\pi \times V_{OUT} \times C_{OUT}} \quad (37)$$

$$f_{Z1} = \frac{1}{C_{OUT} \times R_{ESR} \times 2\pi} \quad (38)$$

$$f_C = \sqrt{f_{P(mod)} + f_{Z1}} \quad (39)$$

$$f_C = \sqrt{f_{P(mod)} \times \frac{f_{SW}}{2}} \quad (40)$$

The compensation design takes the following steps:

1. Set up the anticipated cross-over frequency. Use [Equation 41](#) to calculate the resistor value of the compensation network. In this example, the anticipated cross-over frequency,  $f_C$ , is 45 kHz. The power stage gain ( $g_{M(ps)}$ ) is 13 A/V and the error amplifier gain ( $g_{M(ea)}$ ) is 225  $\mu$ A/V.

$$R3 = \frac{2\pi \times f_C \times V_{OUT} \times C_{OUT}}{g_{M(ea)} \times V_{REF} \times g_{M(ps)}} \quad (41)$$

2. Place compensation zero at the pole formed by the load resistor and the output capacitor. The capacitor of the compensation network can be calculated from [Equation 42](#).

$$C3 = \frac{R_{OUT} \times C_{OUT}}{R3} \quad (42)$$

3. An additional pole can be added to attenuate high frequency noise. In this application, it is not necessary to add it.

From the procedures above, start with a 14.3-kΩ resistor and a 4130-pF capacitor. After prototyping and bode plot measurement, the optimized compensation network selected for this design includes a 9.53-kΩ resistor and a 3900-pF capacitor.

### 8.2.2.11 Power Dissipation Estimate

Use Equation 43 through Equation 52 to help estimate the device power dissipation under continuous conduction mode (CCM) operation. The power dissipation of the device ( $P_{TOT}$ ) includes the following:

- Conduction loss ( $P_{COND}$ )
- Dead time loss ( $P_D$ )
- Switching loss ( $P_{SW}$ )
- Gate drive loss ( $P_{GD}$ )
- Supply current loss ( $P_Q$ )

$$P_{COND} = (I_{OUT})^2 \times R_{DS(on)} \quad (43)$$

$$P_D = f_{SW} \times I_{OUT} \times 0.7 \times 60 \times (10)^{-9} \quad (44)$$

$$P_D = f_{SW} \times I_{OUT} \times 0.7 \times 60 \times (10)^{-9} \quad (45)$$

$$P_{SW} = 2 \times (V_{IN})^2 \times f_{SW} \times I_{OUT} \times 0.25 \times (10)^{-9} \quad (46)$$

$$P_{SW} = 2 \times (V_{IN})^2 \times f_{SW} \times I_{OUT} \times 0.25 \times (10)^{-9} \quad (47)$$

$$P_{GD} = 2 \times V_{IN} \times 3 \times (10)^{-9} \times f_{SW} \quad (48)$$

$$P_Q = 350 \times (10)^{-6} \times V_{IN}$$

where

- $I_{OUT}$  is the output current (A)
- $R_{DS(on)}$  is the on-resistance of the high-side MOSFET ( $\Omega$ )
- $V_{OUT}$  is the output voltage (V)
- $V_{IN}$  is the input voltage (V)
- $f_{SW}$  is the switching frequency (Hz) (49)

$$P_{TOT} = P_{COND} + P_D + P_{SW} + P_{GD} + P_Q \quad (50)$$

For a given ambient temperature,

$$T_J = T_A + R_{TH} \times P_{TOT} \quad (51)$$

For maximum junction temperature ( $T_{J(max)} = 150^\circ\text{C}$ ),

$$T_{A(max)} = T_{J(max)} - R_{TH} \times P_{TOT}$$

where

- $P_{TOT}$  is the total device power dissipation (W)
- $T_A$  is the ambient temperature ( $^\circ\text{C}$ )
- $T_J$  is the junction temperature ( $^\circ\text{C}$ )
- $R_{TH}$  is the thermal resistance of the package ( $^\circ\text{C}/\text{W}$ )
- $T_{J(max)}$  is maximum junction temperature ( $^\circ\text{C}$ )
- $T_{A(max)}$  is maximum ambient temperature ( $^\circ\text{C}$ ) (52)

Additional power can be lost in the regulator circuit due to the inductor ac and dc losses and trace resistance that impact the overall regulator efficiency. Figure 36 and Figure 37 show power dissipation for the EVM.

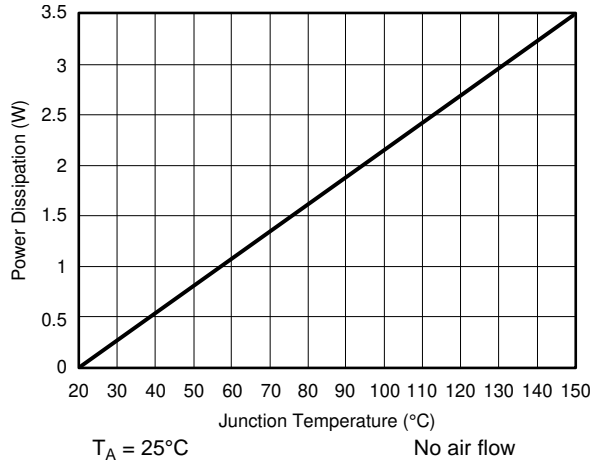

Figure 36. Power Dissipation versus Junction Temperature

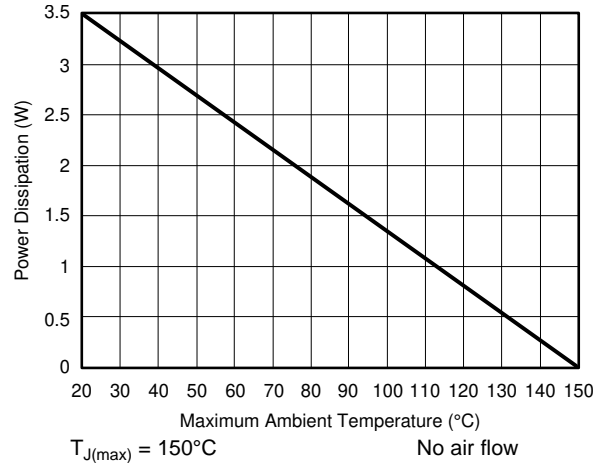

Figure 37. Power Dissipation versus Ambient Temperature

### 8.2.3 Application Curves

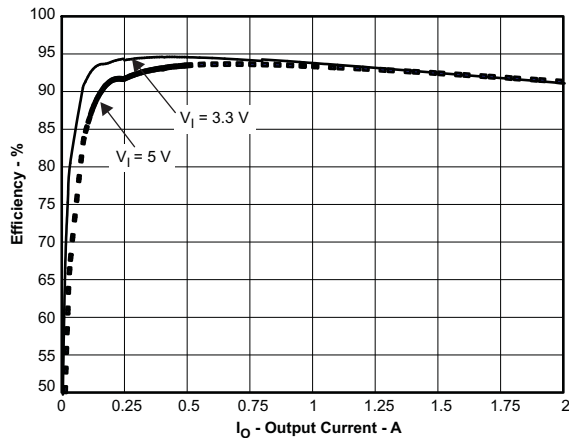

Figure 38. Efficiency versus Load Current

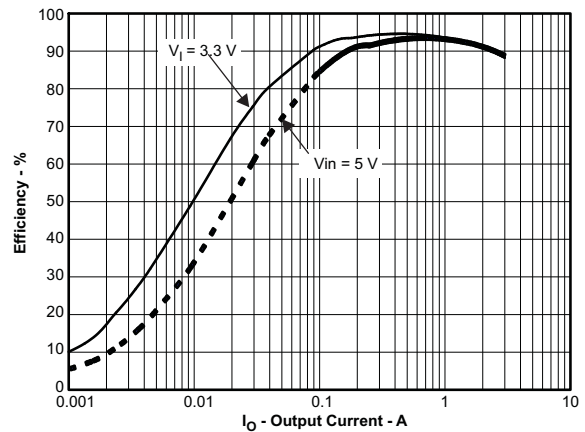

Figure 39. Efficiency versus Load Current

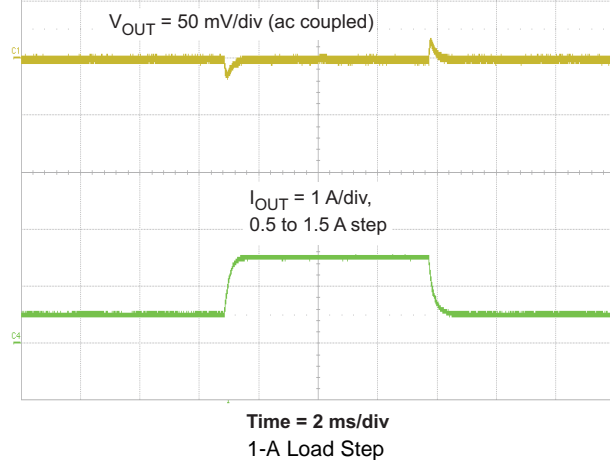

Figure 40. Transient Response

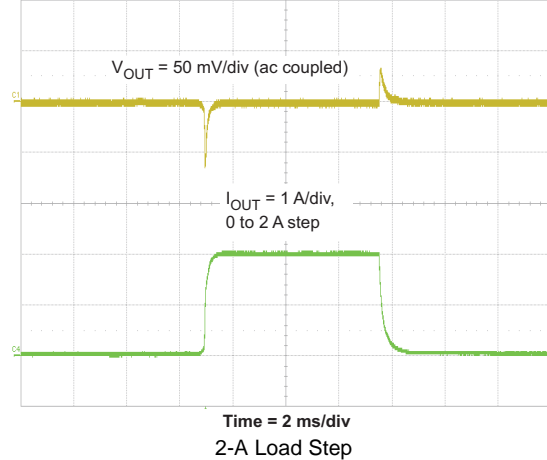
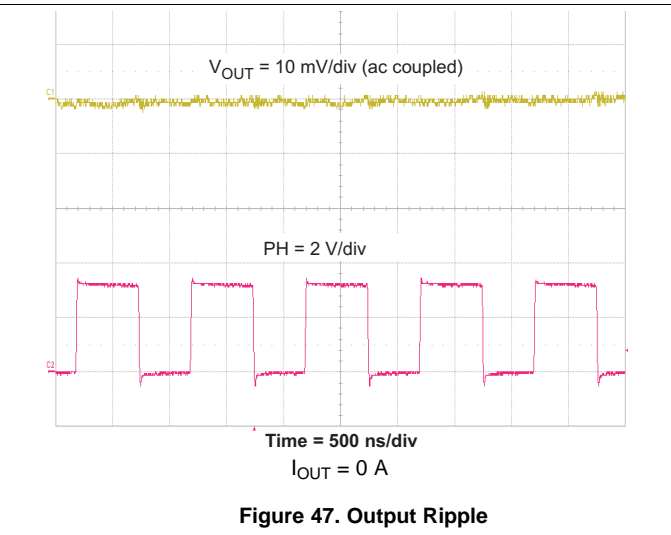
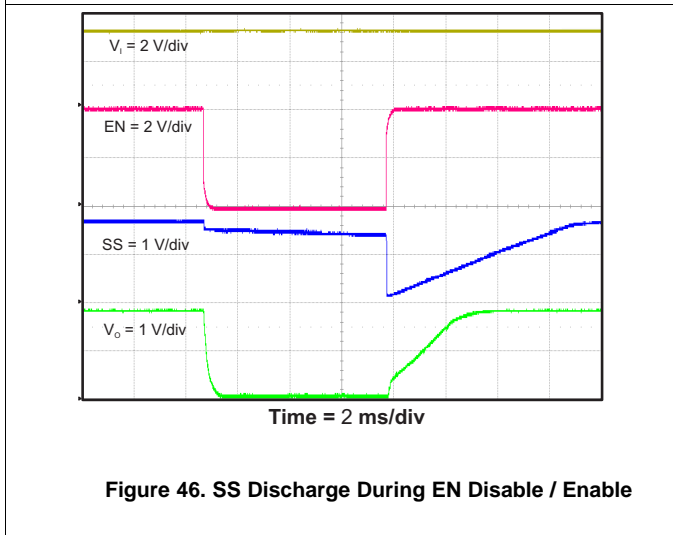
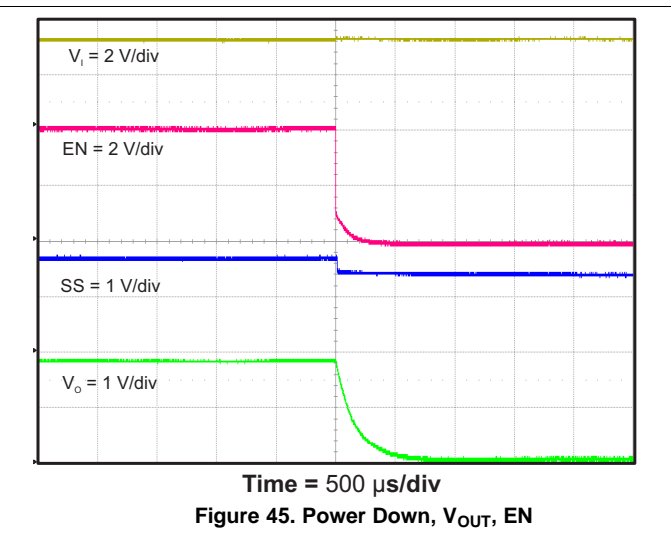
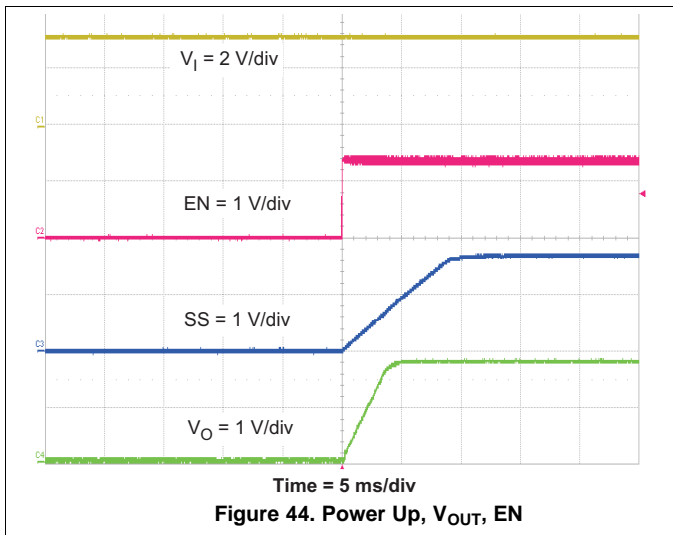
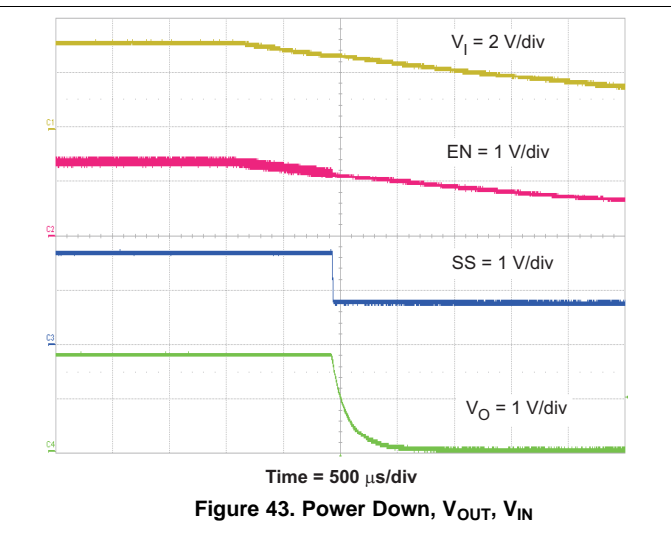
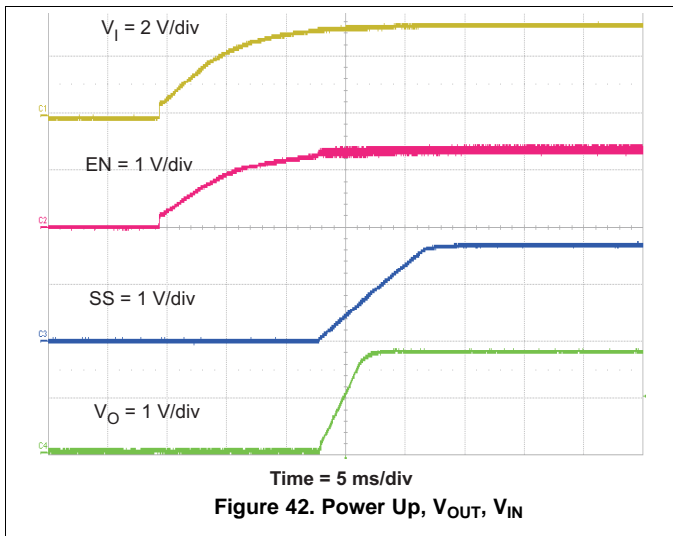
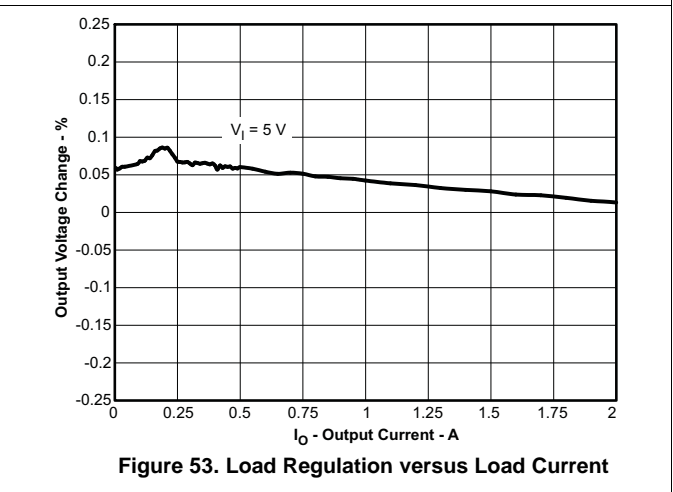
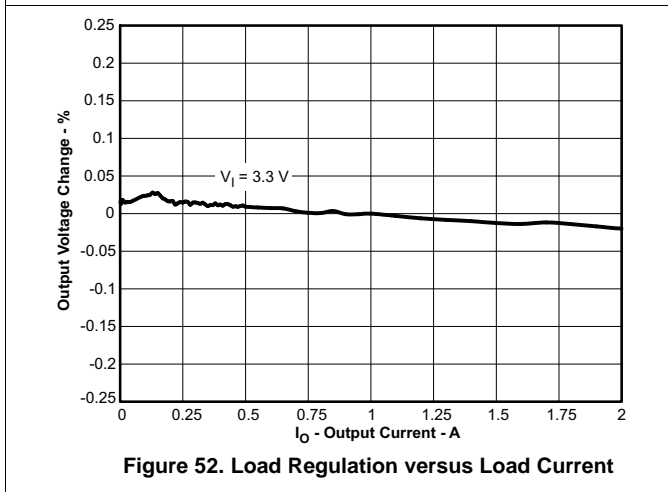
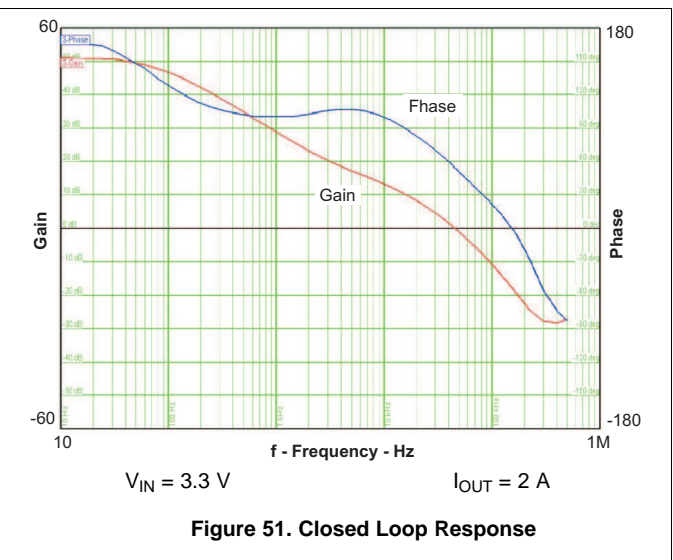
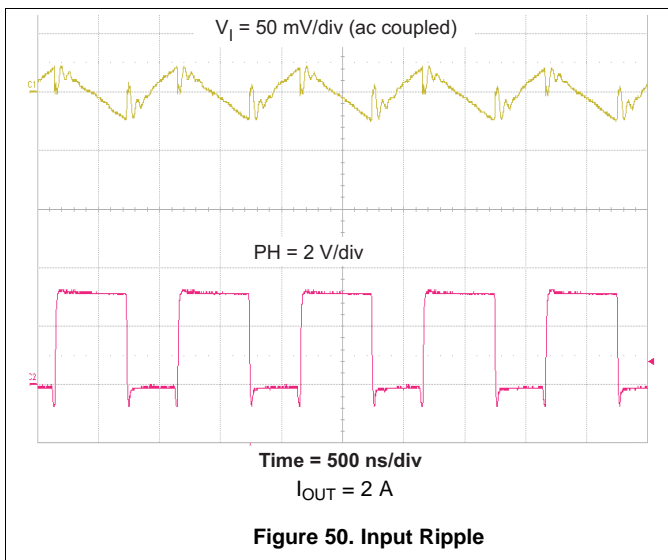
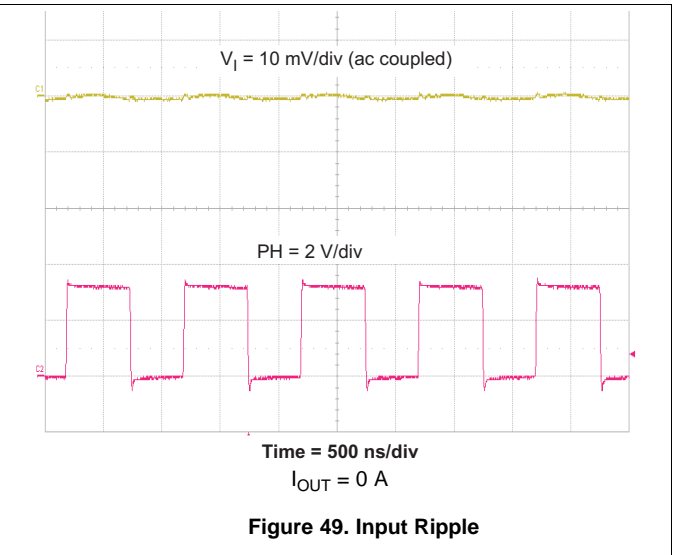
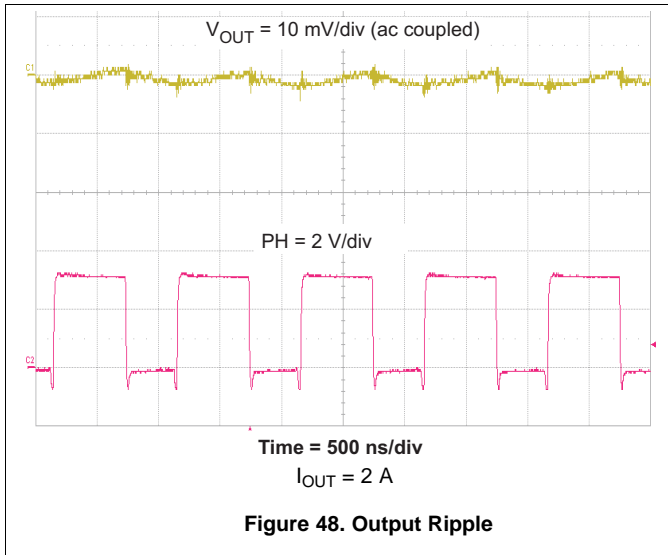

Figure 41. Transient Response







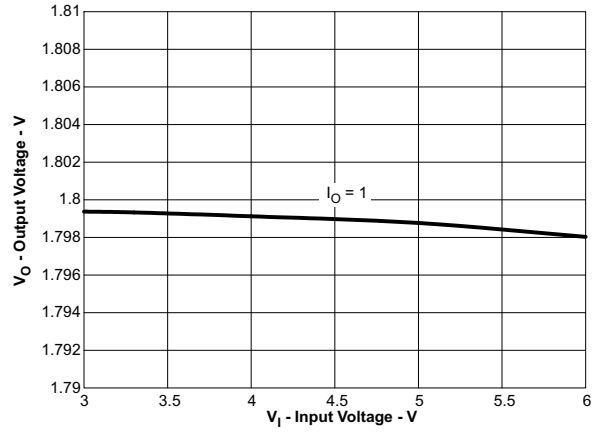

Figure 54. Regulation versus Input Voltage

## 9 Power Supply Recommendations

These devices are designed to operate from an input voltage supply between 2.95 V and 6 V. This supply must be well-regulated. Proper bypassing of input supplies and internal regulators is also critical for noise performance, as is PCB layout and grounding scheme. See the recommendations in the [Layout Guidelines](#) section.

## 10 Layout

### 10.1 Layout Guidelines

Layout is a critical portion of good power supply design. There are several signal paths that conduct fast changing currents or voltages that can interact with stray inductance or parasitic capacitance to generate noise or degrade the power supplies performance.

- Minimize the loop area formed by the bypass capacitor connections and the VIN pins. See [Figure 55](#) for a PCB layout example.
- The GND pins and AGND pin must be tied directly to the power pad under the TPS54218 device. The power pad must be connected to any internal PCB ground planes using multiple vias directly under the device. Additional vias can be used to connect the top-side ground area to the internal planes near the input and output capacitors. For operation at a full-rated load, the top-side ground area along with any additional internal ground planes must provide adequate heat dissipating area.
- Place the input bypass capacitor as close to the device as possible.
- Route the PH pin to the output inductor. Because the PH connection is the switching node, place the output inductor close to the PH pins. Minimize the area of the PCB conductor to prevent excessive capacitive coupling.
- The boot capacitor must also be located close to the device.
- The sensitive analog ground connections for the feedback voltage divider, compensation components, soft-start capacitor, and frequency set resistor must be connected to a separate analog ground trace as shown in [Figure 55](#).
- The RT/CLK pin is particularly sensitive to noise so the RT resistor must be located as close as possible to the device and routed with minimal trace lengths.
- The additional external components can be placed approximately as shown. It is possible to obtain acceptable performance with alternate PCB layouts, however, this layout has been shown to produce good results and can be used as a guide.

## 10.2 Layout Example

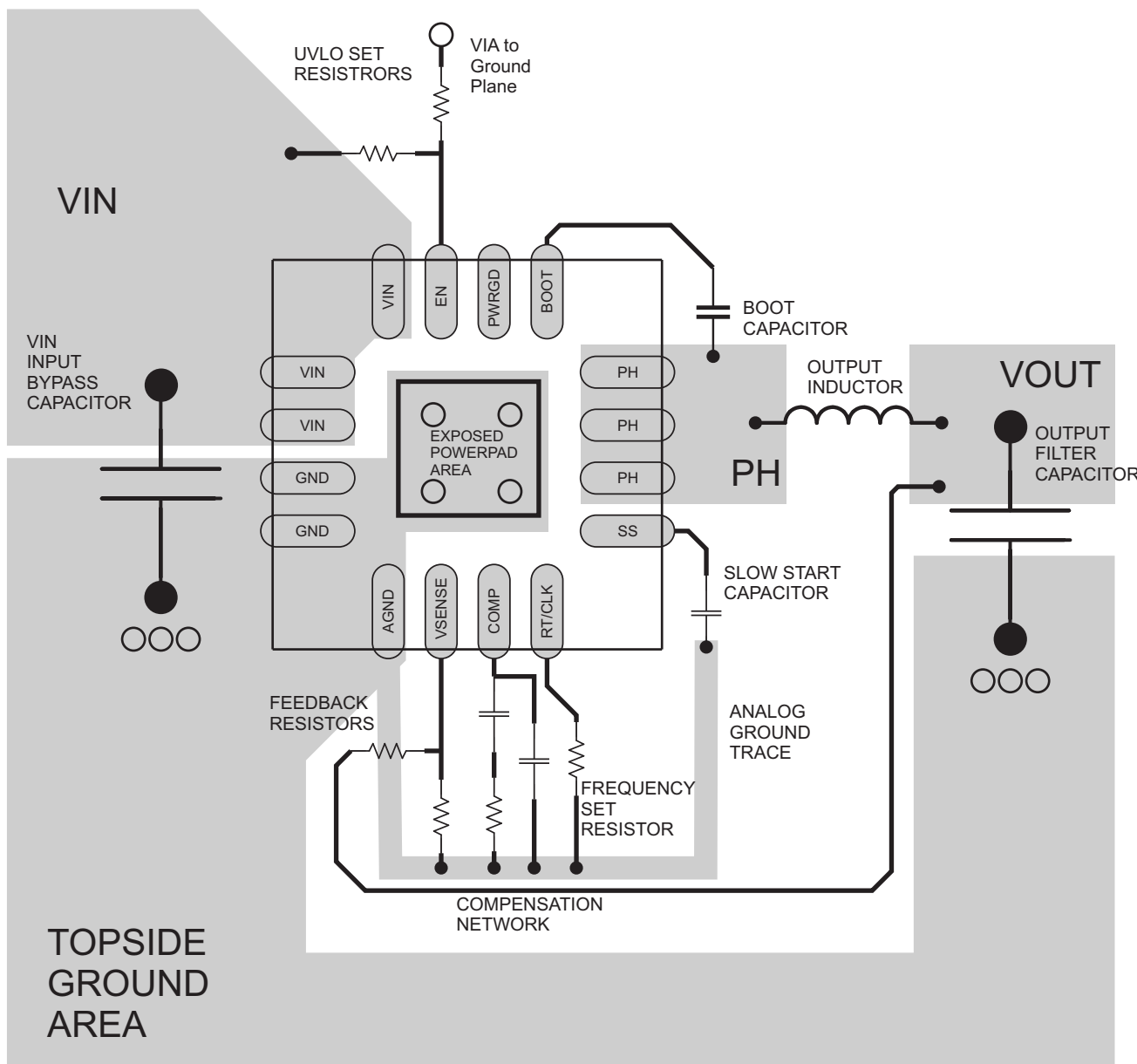

○ VIA to Ground Plane

Figure 55. PCB Layout Example

## 11 Device and Documentation Support

### 11.1 Device Support

#### 11.1.1 Development Support

##### 11.1.1.1 Custom Design With WEBENCH® Tools

Click [here](#) to create a custom design using the TPS54218 device with the WEBENCH® Power Designer.

1. Start by entering the input voltage ( $V_{IN}$ ), output voltage ( $V_{OUT}$ ), and output current ( $I_{OUT}$ ) requirements.
2. Optimize the design for key parameters such as efficiency, footprint, and cost using the optimizer dial.
3. Compare the generated design with other possible solutions from Texas Instruments.

The WEBENCH Power Designer provides a customized schematic along with a list of materials with real-time pricing and component availability.

In most cases, these actions are available:

- Run electrical simulations to see important waveforms and circuit performance
- Run thermal simulations to understand board thermal performance
- Export customized schematic and layout into popular CAD formats
- Print PDF reports for the design, and share the design with colleagues

Get more information about WEBENCH tools at [www.ti.com/WEBENCH](http://www.ti.com/WEBENCH).

For more SWIFT™ documentation, see the TI website at [www.ti.com/swift](http://www.ti.com/swift).

### 11.2 Receiving Notification of Documentation Updates

To receive notification of documentation updates, navigate to the device product folder on ti.com. In the upper right corner, click on *Alert me* to register and receive a weekly digest of any product information that has changed. For change details, review the revision history included in any revised document.

### 11.3 Support Resources

TI E2E™ support forums are an engineer's go-to source for fast, verified answers and design help — straight from the experts. Search existing answers or ask your own question to get the quick design help you need.

Linked content is provided "AS IS" by the respective contributors. They do not constitute TI specifications and do not necessarily reflect TI's views; see TI's [Terms of Use](#).

### 11.4 Trademarks

SWIFT, E2E are trademarks of Texas Instruments.  
 WEBENCH is a registered trademark of Texas Instruments.  
 All other trademarks are the property of their respective owners.

### 11.5 Electrostatic Discharge Caution



These devices have limited built-in ESD protection. The leads should be shorted together or the device placed in conductive foam during storage or handling to prevent electrostatic damage to the MOS gates.

### 11.6 Glossary

[SLYZ022](#) — TI Glossary.

This glossary lists and explains terms, acronyms, and definitions.

## 12 Mechanical, Packaging, and Orderable Information

The following pages include mechanical, packaging, and orderable information. This information is the most current data available for the designated devices. This data is subject to change without notice and revision of this document. For browser-based versions of this data sheet, refer to the left-hand navigation.

**PACKAGING INFORMATION**

Orderable part number	Status (1)	Material type (2)	Package   Pins	Package qty   Carrier	RoHS (3)	Lead finish/ Ball material (4)	MSL rating/ Peak reflow (5)	Op temp (°C)	Part marking (6)
<a href="#">TPS54218RTER</a>	Active	Production	WQFN (RTE)   16	3000   LARGE T&R	Yes	NIPDAU	Level-2-260C-1 YEAR	-40 to 150	54218
TPS54218RTER.A	Active	Production	WQFN (RTE)   16	3000   LARGE T&R	Yes	NIPDAU	Level-2-260C-1 YEAR	-40 to 150	54218
TPS54218RTERG4	Active	Production	WQFN (RTE)   16	3000   LARGE T&R	Yes	NIPDAU	Level-2-260C-1 YEAR	-40 to 150	54218
TPS54218RTERG4.A	Active	Production	WQFN (RTE)   16	3000   LARGE T&R	Yes	NIPDAU	Level-2-260C-1 YEAR	-40 to 150	54218
<a href="#">TPS54218RTET</a>	Active	Production	WQFN (RTE)   16	250   SMALL T&R	Yes	NIPDAU	Level-2-260C-1 YEAR	-40 to 150	54218
TPS54218RTET.A	Active	Production	WQFN (RTE)   16	250   SMALL T&R	Yes	NIPDAU	Level-2-260C-1 YEAR	-40 to 150	54218

(1) **Status:** For more details on status, see our [product life cycle](#).

(2) **Material type:** When designated, preproduction parts are prototypes/experimental devices, and are not yet approved or released for full production. Testing and final process, including without limitation quality assurance, reliability performance testing, and/or process qualification, may not yet be complete, and this item is subject to further changes or possible discontinuation. If available for ordering, purchases will be subject to an additional waiver at checkout, and are intended for early internal evaluation purposes only. These items are sold without warranties of any kind.

(3) **RoHS values:** Yes, No, RoHS Exempt. See the [TI RoHS Statement](#) for additional information and value definition.

(4) **Lead finish/Ball material:** Parts may have multiple material finish options. Finish options are separated by a vertical ruled line. Lead finish/Ball material values may wrap to two lines if the finish value exceeds the maximum column width.

(5) **MSL rating/Peak reflow:** The moisture sensitivity level ratings and peak solder (reflow) temperatures. In the event that a part has multiple moisture sensitivity ratings, only the lowest level per JEDEC standards is shown. Refer to the shipping label for the actual reflow temperature that will be used to mount the part to the printed circuit board.

(6) **Part marking:** There may be an additional marking, which relates to the logo, the lot trace code information, or the environmental category of the part.

Multiple part markings will be inside parentheses. Only one part marking contained in parentheses and separated by a "~" will appear on a part. If a line is indented then it is a continuation of the previous line and the two combined represent the entire part marking for that device.

**Important Information and Disclaimer:**The information provided on this page represents TI's knowledge and belief as of the date that it is provided. TI bases its knowledge and belief on information provided by third parties, and makes no representation or warranty as to the accuracy of such information. Efforts are underway to better integrate information from third parties. TI has taken and continues to take reasonable steps to provide representative and accurate information but may not have conducted destructive testing or chemical analysis on incoming materials and chemicals. TI and TI suppliers consider certain information to be proprietary, and thus CAS numbers and other limited information may not be available for release.

In no event shall TI's liability arising out of such information exceed the total purchase price of the TI part(s) at issue in this document sold by TI to Customer on an annual basis.



**TAPE AND REEL INFORMATION**

**QUADRANT ASSIGNMENTS FOR PIN 1 ORIENTATION IN TAPE**

\*All dimensions are nominal

Device	Package Type	Package Drawing	Pins	SPQ	Reel Diameter (mm)	Reel Width W1 (mm)	A0 (mm)	B0 (mm)	K0 (mm)	P1 (mm)	W (mm)	Pin1 Quadrant
TPS54218RTER	WQFN	RTE	16	3000	330.0	12.4	3.3	3.3	1.1	8.0	12.0	Q2
TPS54218RTER	WQFN	RTE	16	3000	330.0	12.4	3.3	3.3	1.1	8.0	12.0	Q2
TPS54218RTERG4	WQFN	RTE	16	3000	330.0	12.4	3.3	3.3	1.1	8.0	12.0	Q2
TPS54218RTET	WQFN	RTE	16	250	180.0	12.4	3.3	3.3	1.1	8.0	12.0	Q2

**TAPE AND REEL BOX DIMENSIONS**

\*All dimensions are nominal

Device	Package Type	Package Drawing	Pins	SPQ	Length (mm)	Width (mm)	Height (mm)
TPS54218RTER	WQFN	RTE	16	3000	346.0	346.0	33.0
TPS54218RTER	WQFN	RTE	16	3000	353.0	353.0	32.0
TPS54218RTERG4	WQFN	RTE	16	3000	353.0	353.0	32.0
TPS54218RTET	WQFN	RTE	16	250	210.0	185.0	35.0



## GENERIC PACKAGE VIEW

**RTE 16**

**WQFN - 0.8 mm max height**

3 x 3, 0.5 mm pitch

PLASTIC QUAD FLATPACK - NO LEAD

This image is a representation of the package family, actual package may vary.  
Refer to the product data sheet for package details.



4225944/A



# EXAMPLE BOARD LAYOUT

RTE0016F

WQFN - 0.8 mm max height

PLASTIC QUAD FLATPACK - NO LEAD

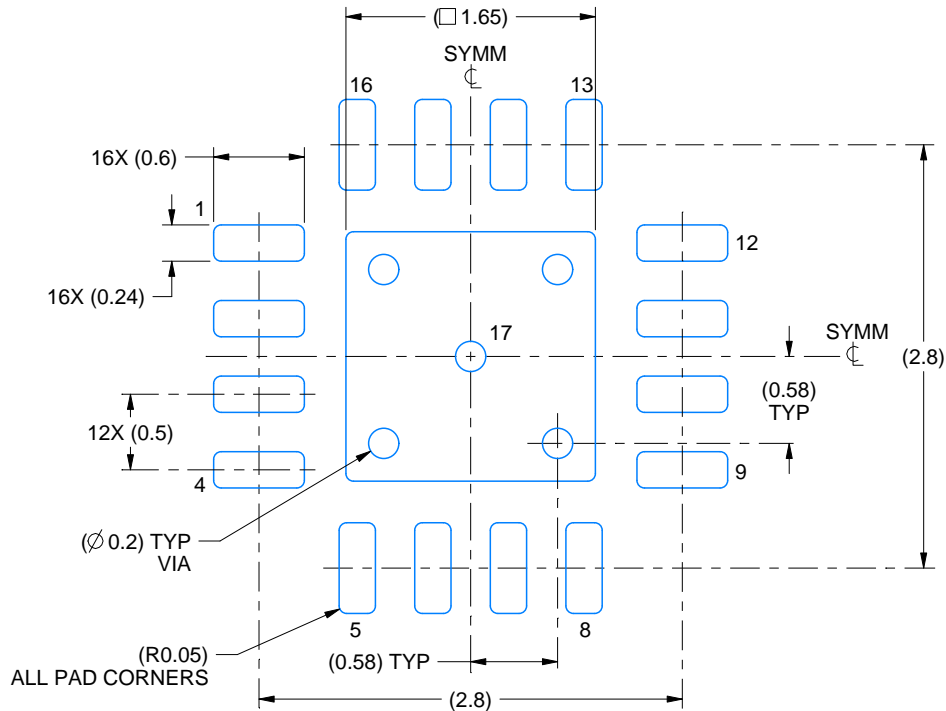

LAND PATTERN EXAMPLE  
EXPOSED METAL SHOWN  
SCALE:20X

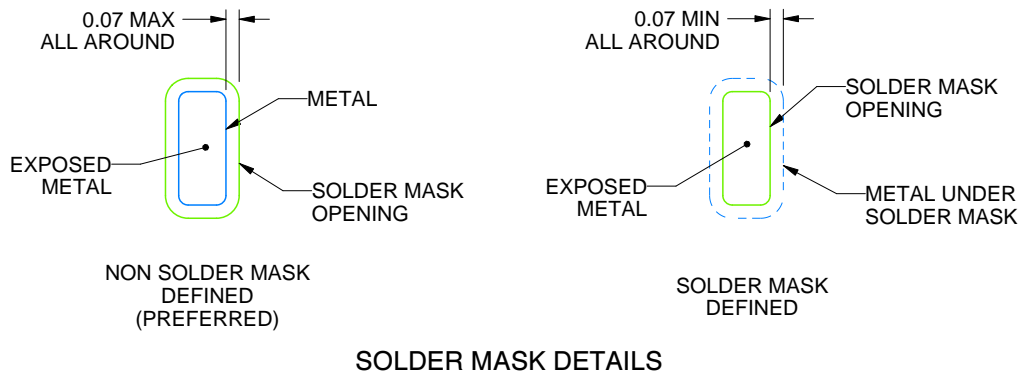

SOLDER MASK DETAILS

4219119/A 03/2018

NOTES: (continued)

4. This package is designed to be soldered to a thermal pad on the board. For more information, see Texas Instruments literature number SLUA271 ([www.ti.com/lit/slua271](http://www.ti.com/lit/slua271)).
5. Vias are optional depending on application, refer to device data sheet. If any vias are implemented, refer to their locations shown on this view. It is recommended that vias under paste be filled, plugged or tented.

# EXAMPLE STENCIL DESIGN

RTE0016F

WQFN - 0.8 mm max height

PLASTIC QUAD FLATPACK - NO LEAD

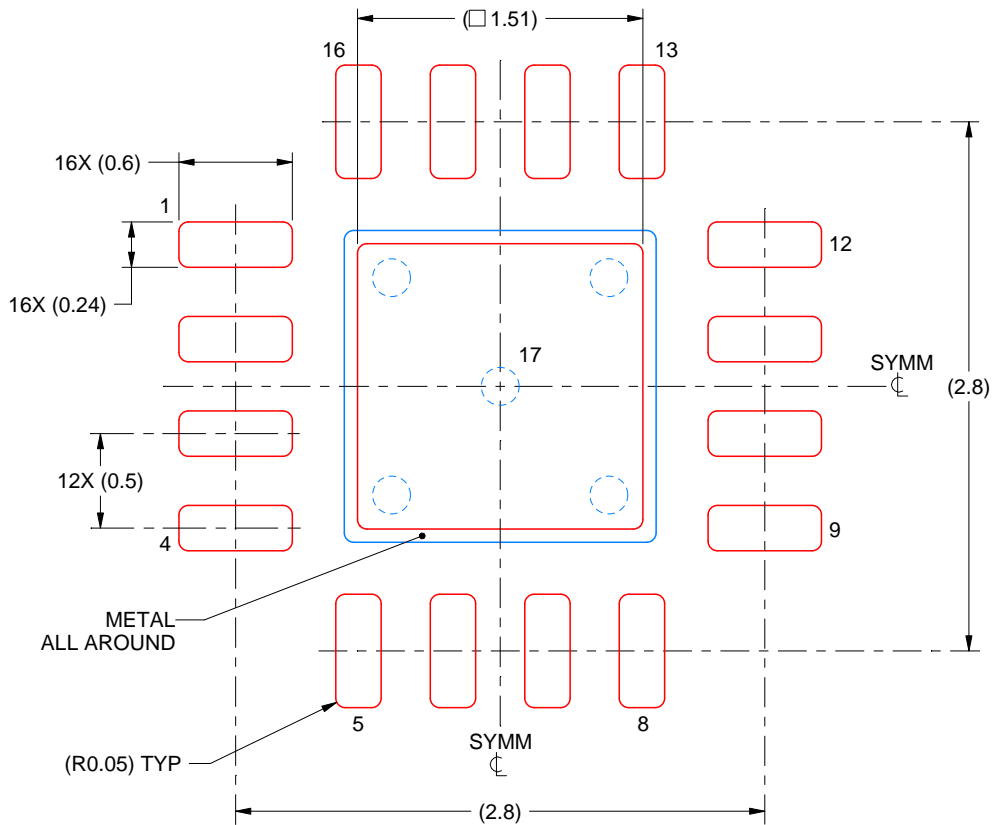

**SOLDER PASTE EXAMPLE**  
BASED ON 0.125 mm THICK STENCIL

EXPOSED PAD 17:  
84% PRINTED SOLDER COVERAGE BY AREA UNDER PACKAGE  
SCALE:25X

4219119/A 03/2018

NOTES: (continued)

6. Laser cutting apertures with trapezoidal walls and rounded corners may offer better paste release. IPC-7525 may have alternate design recommendations.

## IMPORTANT NOTICE AND DISCLAIMER

TI PROVIDES TECHNICAL AND RELIABILITY DATA (INCLUDING DATASHEETS), DESIGN RESOURCES (INCLUDING REFERENCE DESIGNS), APPLICATION OR OTHER DESIGN ADVICE, WEB TOOLS, SAFETY INFORMATION, AND OTHER RESOURCES "AS IS" AND WITH ALL FAULTS, AND DISCLAIMS ALL WARRANTIES, EXPRESS AND IMPLIED, INCLUDING WITHOUT LIMITATION ANY IMPLIED WARRANTIES OF MERCHANTABILITY, FITNESS FOR A PARTICULAR PURPOSE OR NON-INFRINGEMENT OF THIRD PARTY INTELLECTUAL PROPERTY RIGHTS.

These resources are intended for skilled developers designing with TI products. You are solely responsible for (1) selecting the appropriate TI products for your application, (2) designing, validating and testing your application, and (3) ensuring your application meets applicable standards, and any other safety, security, regulatory or other requirements.

These resources are subject to change without notice. TI grants you permission to use these resources only for development of an application that uses the TI products described in the resource. Other reproduction and display of these resources is prohibited. No license is granted to any other TI intellectual property right or to any third party intellectual property right. TI disclaims responsibility for, and you fully indemnify TI and its representatives against any claims, damages, costs, losses, and liabilities arising out of your use of these resources.

TI's products are provided subject to [TI's Terms of Sale](#), [TI's General Quality Guidelines](#), or other applicable terms available either on [ti.com](http://ti.com) or provided in conjunction with such TI products. TI's provision of these resources does not expand or otherwise alter TI's applicable warranties or warranty disclaimers for TI products. Unless TI explicitly designates a product as custom or customer-specified, TI products are standard, catalog, general purpose devices.

TI objects to and rejects any additional or different terms you may propose.

Copyright © 2025, Texas Instruments Incorporated

Last updated 10/2025