

## TPS7A85A 4-A, High-Accuracy (0.75%), Low-Noise (4.4 $\mu\text{VRMS}$ ), LDO Regulator

### 1 Features

- Low Dropout: 150 mV (Typical) at 4 A
- 0.75% (Maximum) Accuracy Over Line, Load, and Temperature With BIAS
- Output Voltage Noise:
  - 4.4  $\mu\text{VRMS}$  at 0.8-V Output
  - 7.7  $\mu\text{VRMS}$  at 5.1-V Output
- Input Voltage Range:
  - Without BIAS: 1.4 V to 6.5 V
  - With BIAS: 1.1 V to 6.5 V
- ANY-OUT™ Operation:
  - Output Voltage Range: 0.8 V to 3.95 V
- Adjustable Operation:
  - Output Voltage Range: 0.8 V to 5.1 V
- Power-Supply Ripple Rejection:
  - 40 dB at 500 kHz
- Excellent Load Transient Response
- Adjustable Soft-Start In-Rush Control
- Open-Drain Power-Good (PG) Output
- Stable with a 47- $\mu\text{F}$  or Larger Ceramic Output Capacitor
- $\theta_{\text{JC}} = 3.4^\circ\text{C/W}$
- 3.5-mm x 3.5-mm, 20-Pin VQFN

### 2 Applications

- Digital Loads: SerDes, FPGAs, and DSPs
- Instrumentation, Medical, and Audio
- High-Speed Analog Circuits:
  - VCO, ADC, DAC, and LVDS
- Imaging: CMOS Sensors and Video ASICs
- Test and Measurement

### 3 Description

The TPS7A85A is a low-noise (4.4  $\mu\text{VRMS}$ ), low dropout linear regulator (LDO) capable of sourcing 4 A with only 240 mV of maximum dropout. The device output voltage is pin-programmable from 0.8 V to 3.95 V and adjustable from 0.8 V to 5.1 V using an external resistor divider.

The combination of low-noise (4.4  $\mu\text{VRMS}$ ), high-PSRR, and high output current capability makes the TPS7A85A ideal to power noise-sensitive components such as those found in high-speed communications, video, medical, or test and measurement applications. The high performance of the TPS7A85A limits power-supply-generated phase noise and clock jitter, making this device ideal for powering high-performance serializer and deserializer (SerDes), analog-to-digital converters (ADCs), digital-to-analog converters (DACs), and RF components. Specifically, RF amplifiers benefit from the high-performance and 5.1-V output capability of the device.

For digital loads (such as application-specific integrated circuits (ASICs), field-programmable gate arrays (FPGAs), and digital signal processors (DSPs)) requiring low-input voltage, low-output (LILO) voltage operation, the exceptional accuracy (0.75% over load and temperature), remote sensing, excellent transient performance, and soft-start capabilities of the TPS7A85A ensure optimal system performance.

The versatility of the TPS7A8500A makes the device a component of choice for many demanding applications.

#### Device Information<sup>(1)</sup>

PART NUMBER	PACKAGE	BODY SIZE (NOM)
TPS7A85A	VQFN (20)	3.50 mm x 3.50 mm

(1) For all available packages, see the orderable addendum at the end of the data sheet.

#### Powering RF Components

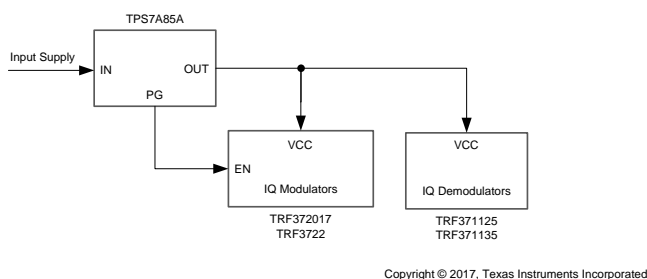

#### Powering Digital Loads

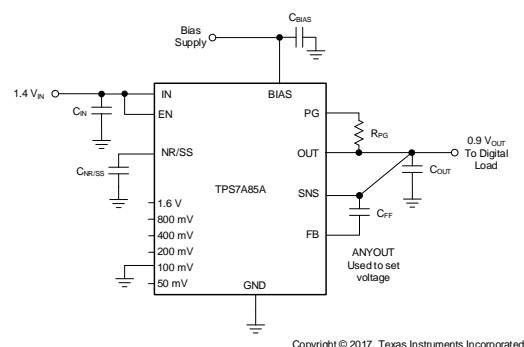

## Table of Contents

<b>1 Features</b> .....	<b>1</b>	<b>7 Detailed Description</b> .....	<b>16</b>
<b>2 Applications</b> .....	<b>1</b>	7.1 Overview .....	16
<b>3 Description</b> .....	<b>1</b>	7.2 Functional Block Diagram .....	16
<b>4 Revision History</b> .....	<b>2</b>	7.3 Feature Description .....	17
<b>5 Pin Configuration and Functions</b> .....	<b>3</b>	7.4 Device Functional Modes .....	20
<b>6 Specifications</b> .....	<b>4</b>	<b>8 Application and Implementation</b> .....	<b>21</b>
6.1 Absolute Maximum Ratings .....	4	8.1 Application Information .....	21
6.2 ESD Ratings .....	4	8.2 Typical Applications .....	38
6.3 Recommended Operating Conditions .....	5	<b>9 Power-Supply Recommendations</b> .....	<b>39</b>
6.4 Thermal Information .....	5	<b>10 Layout</b> .....	<b>39</b>
6.5 Electrical Characteristics .....	6	10.1 Layout Guidelines .....	39
6.6 Typical Characteristics .....	8	10.2 Layout Example .....	40

## 4 Revision History

DATE	REVISION	NOTES
June 2017	*	Initial release.

## 5 Pin Configuration and Functions

**RGR Package  
20-Pin VQFN  
Top View**

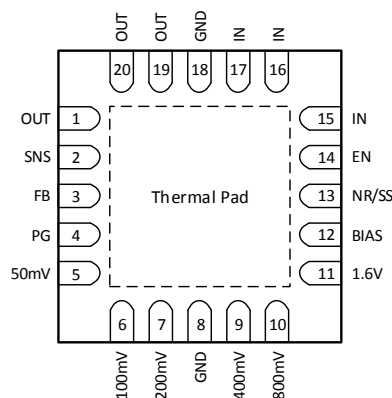

### Pin Functions

PIN		I/O	DESCRIPTION
NAME	NO.		
50mV	5	I	ANY-OUT voltage setting pins. These pins connect to an internal feedback network. Connect these pins to ground, SNS, or leave floating. Connecting these pins to ground increases the output voltage, whereas connecting these pins to SNS increases the resolution of the ANY-OUT network but decreases the range of the network; multiple pins may be simultaneously connected to GND or SNS to select the desired output voltage. Leave these pins floating (open) when not in use. See <a href="#">ANY-OUT Programmable Output Voltage</a> for additional details.
100mV	6		
200mV	7		
400mV	9		
800mV	10		
1.6V	11		
BIAS	12	I	BIAS supply voltage. This pin enables the use of low-input voltage, low-output (LILO) voltage conditions (that is, $V_{IN} = 1.2\text{ V}$ , $V_{OUT} = 1\text{ V}$ ) to reduce power dissipation across the die. The use of a BIAS voltage improves dc and ac performance for $V_{IN} \leq 2.2\text{ V}$ . A 10- $\mu\text{F}$ capacitor (5- $\mu\text{F}$ capacitance) or larger must be connected between this pin and ground if BIAS pin is used. If not used, this pin must be left floating or tied to ground and a capacitor is not required.
EN	14	I	Enable pin. Driving this pin to logic high enables the device; driving this pin to logic low disables the device. If enable functionality is not required, this pin must be connected to IN or BIAS.
FB	3	I	Feedback pin connected to the error amplifier. Although not required, TI recommends a 10-nF feed-forward capacitor from FB to OUT (as close to the device as possible) to maximize ac performance. The use of a feed-forward capacitor may disrupt power-good (PG) functionality. See <a href="#">ANY-OUT Programmable Output Voltage</a> and <a href="#">Adjustable Operation</a> for more details.
GND	8, 18	—	Ground pin. These pins must be connected to ground, the thermal pad, and each other with a low-impedance connection.
IN	15, 16, 17	I	Input supply voltage pin. A 10- $\mu\text{F}$ or larger ceramic capacitor (5 $\mu\text{F}$ of capacitance or greater) from IN to ground is required to reduce the impedance of the input supply. Place the input capacitor as close as possible to the input. See <a href="#">Input and Output Capacitor Requirements (<math>C_{IN}</math> and <math>C_{OUT}</math>)</a> for more details.
NR/SS	13	—	Noise-reduction and soft-start pin. Connecting an external capacitor between this pin and ground reduces reference voltage noise and enables the soft-start function. Although not required, TI recommends a 10-nF or larger capacitor be connected from NR/SS to GND (as close as possible to the pin) to maximize ac performance. See <a href="#">Input and Output Capacitor Requirements (<math>C_{IN}</math> and <math>C_{OUT}</math>)</a> for more details.
OUT	1, 19, 20	O	Regulated output pin. A 47- $\mu\text{F}$ or larger ceramic capacitor (25 $\mu\text{F}$ of capacitance or greater) from OUT to ground is required for stability and must be placed as close as possible to the output. Minimize the impedance from the OUT pin to the load. See <a href="#">Input and Output Capacitor Requirements (<math>C_{IN}</math> and <math>C_{OUT}</math>)</a> for more details.
PG	4	O	Active-high, PG pin. An open-drain output indicates when the output voltage reaches $V_{IT(PG)}$ of the target. The use of a feed-forward capacitor may disrupt PG functionality. See <a href="#">Input and Output Capacitor Requirements (<math>C_{IN}</math> and <math>C_{OUT}</math>)</a> for more details.
SNS	2	I	Output voltage sense input pin. This pin connects the internal $R_1$ resistor to the output. Connect this pin to the load side of the output trace only if the ANY-OUT feature is used. If the ANY-OUT feature is not used, leave this pin floating. See <a href="#">ANY-OUT Programmable Output Voltage</a> and <a href="#">Adjustable Operation</a> for more details.
Thermal pad		—	Connect the thermal pad to a large-area ground plane. The thermal pad is internally connected to GND.

## 6 Specifications

### 6.1 Absolute Maximum Ratings

over operating free-air temperature range (unless otherwise noted)<sup>(1)</sup>

		MIN	MAX	UNIT
Voltage	IN, BIAS, PG, EN	-0.3	7	V
	IN, BIAS, PG, EN (5% duty cycle, pulse duration = 200 $\mu$ s)	-0.3	7.5	V
	SNS, OUT	-0.3	$V_{IN} + 0.3$	V
	NR/SS, FB	-0.3	3.6	V
	50mV, 100mV, 200mV, 400mV, 800mV, 1.6V	-0.3	$V_{OUT} + 0.3$	V
Current	OUT	Internally limited	Internally limited	A
	PG (sink current into device)		5	mA
Operating junction temperature, $T_J$		-55	150	$^{\circ}$ C
Storage temperature, $T_{stg}$		-55	150	$^{\circ}$ C

- (1) Stresses beyond those listed under *Absolute Maximum Ratings* may cause permanent damage to the device. These are stress ratings only, which do not imply functional operation of the device at these or any other conditions beyond those indicated under *Recommended Operating Conditions*. Exposure to absolute-maximum-rated conditions for extended periods may affect device reliability.

### 6.2 ESD Ratings

		VALUE	UNIT
$V_{(ESD)}$ Electrostatic discharge	Human-body model (HBM), per ANSI/ESDA/JEDEC JS-001 <sup>(1)</sup>	$\pm 2000$	V
	Charged-device model (CDM), per JEDEC specification JESD22-C101 <sup>(2)</sup>	$\pm 500$	

- (1) JEDEC document JEP155 states that 500-V HBM allows safe manufacturing with a standard ESD control process. Manufacturing with less than 500-V HBM is possible with the necessary precautions. Pins listed as  $\pm 2000$  V may actually have higher performance.
- (2) JEDEC document JEP157 states that 250-V CDM allows safe manufacturing with a standard ESD control process. Manufacturing with less than 250-V CDM is possible with the necessary precautions. Pins listed as  $\pm 500$  V may actually have higher performance.

### 6.3 Recommended Operating Conditions

over junction temperature range (unless otherwise noted)

		MIN	NOM	MAX	UNIT
$V_{IN}$	Input supply voltage range	1.1		6.5	V
$V_{BIAS}$	Bias supply voltage range <sup>(1)</sup>	3		6.5	V
$V_{OUT}$	Output voltage range <sup>(2)</sup>	0.8		5.1	V
$V_{EN}$	Enable voltage range	0		$V_{IN}$	V
$I_{OUT}$	Output current	0		4	A
$C_{IN}$	Input capacitor	10	47		$\mu$ F
$C_{OUT}$	Output capacitor	47	47    10    10 <sup>(3)</sup>		$\mu$ F
$C_{BIAS}$	BIAS Capacitor	10			$\mu$ F
$R_{PG}$	Power-good pullup resistance	10		100	k $\Omega$
$C_{NR/SS}$	NR/SS capacitor		10		nF
$C_{FF}$	Feed-forward capacitor		10		nF
$R_1$	Top resistor value in feedback network for adjustable operation		12.1 <sup>(4)</sup>		k $\Omega$
$R_2$	Bottom resistor value in feedback network for adjustable operation			160 <sup>(5)</sup>	k $\Omega$
$T_J$	Operating junction temperature	–40		125	$^{\circ}$ C

- (1) BIAS supply is required when the  $V_{IN}$  supply is below 1.4 V. Conversely, no BIAS supply is required when the  $V_{IN}$  supply is higher than or equal to 1.4 V. A BIAS supply helps improve dc and ac performance for  $V_{IN} \leq 2.2$  V.
- (2) This output voltage range does not include device accuracy or accuracy of the feedback resistors.
- (3) The recommended output capacitors are selected to optimize PSRR for the frequency range of 400 kHz to 700 kHz. This frequency range is a typical value for dc-dc supplies.
- (4) The 12.1-k $\Omega$  resistor is selected to optimize PSRR and noise by matching the internal  $R_1$  value.
- (5) The upper limit for the  $R_2$  resistor is to ensure accuracy by making the current through the feedback network much larger than the leakage current into the feedback node.

### 6.4 Thermal Information

THERMAL METRIC <sup>(1)</sup>		TPS7A85A	UNIT
		RGR (VQFN)	
		20 PINS	
$R_{\theta JA}$	Junction-to-ambient thermal resistance	43.4	$^{\circ}$ C/W
$R_{\theta JC(top)}$	Junction-to-case (top) thermal resistance	36.8	$^{\circ}$ C/W
$R_{\theta JB}$	Junction-to-board thermal resistance	17.6	$^{\circ}$ C/W
$\psi_{JT}$	Junction-to-top characterization parameter	0.8	$^{\circ}$ C/W
$\psi_{JB}$	Junction-to-board characterization parameter	17.6	$^{\circ}$ C/W
$R_{\theta JC(bot)}$	Junction-to-case (bottom) thermal resistance	3.4	$^{\circ}$ C/W

- (1) For more information about traditional and new thermal metrics, see the [Semiconductor and IC Package Thermal Metrics](#) application report.

## 6.5 Electrical Characteristics

over operating junction temperature range ( $T_J = -40^\circ\text{C}$  to  $+125^\circ\text{C}$ ),  $V_{IN} = 1.4\text{ V}$  or  $V_{IN} = V_{OUT(nom)} + 0.5\text{ V}$  (whichever is greater),  $V_{BIAS} = \text{open}$ ,  $V_{OUT(nom)} = 0.8\text{ V}^{(1)}$ , OUT connected to  $50\ \Omega$  to GND<sup>(2)</sup>,  $V_{EN} = 1.1\text{ V}$ ,  $C_{IN} = 10\ \mu\text{F}$ ,  $C_{OUT} = 47\ \mu\text{F}$ ,  $C_{NR/SS} = 0\text{ nF}$ ,  $C_{FF} = 0\text{ nF}$ , and PG pin pulled up to  $V_{IN}$  with  $100\text{ k}\Omega$  unless otherwise noted. Typical values are at  $T_J = 25^\circ\text{C}$ .

PARAMETER		TEST CONDITIONS	MIN	TYP	MAX	UNIT
$V_{IN}$	Input supply voltage range <sup>(3)</sup>		1.1		6.5	V
$V_{BIAS}$	Bias supply voltage range <sup>(3)</sup>	$V_{IN} = 1.1\text{ V}$	3		6.5	V
$V_{FB}$	Feedback voltage			0.8		V
$V_{NR/SS}$	NR/SS pin voltage			0.8		V
$V_{UVLO1(IN)}$	Input supply UVLO with BIAS	$V_{IN}$ rising with $V_{BIAS} = 3\text{ V}$		1.02	1.085	V
$V_{HYS1(IN)}$	$V_{UVLO1(IN)}$ hysteresis	$V_{BIAS} = 3\text{ V}$		320		mV
$V_{UVLO2(IN)}$	Input supply UVLO without BIAS	$V_{IN}$ rising		1.31	1.39	V
$V_{HYS2(IN)}$	$V_{UVLO2(IN)}$ hysteresis			253		mV
$V_{UVLO(BIAS)}$	Bias supply UVLO	$V_{BIAS}$ rising $V_{IN} = 1.1\text{ V}$		2.83	2.9	V
$V_{HYS(BIAS)}$	$V_{UVLO(BIAS)}$ hysteresis	$V_{IN} = 1.1\text{ V}$		290		mV
$V_{OUT}$	Output voltage	Range	Using the ANY-OUT pins		3.95 + 1%	V
			Using external resistors <sup>(4)</sup>	0.8 – 1%	5.1 + 1%	
		Accuracy <sup>(4)</sup> <sup>(5)</sup>	$0.8\text{ V} \leq V_{OUT} \leq 5.1\text{ V}^{(6)}$ $5\text{ mA} \leq I_{OUT} \leq 4\text{ A}$ $1.4\text{ V} \leq V_{IN} \leq 6.5\text{ V}$	–1%		1%
	Accuracy with BIAS	$1.1\text{ V} \leq V_{IN} \leq 2.2\text{ V}$ $0.8\text{ V} \leq V_{OUT} \leq 1.9\text{ V}$ $5\text{ mA} \leq I_{OUT} \leq 4\text{ A}$ $3\text{ V} \leq V_{BIAS} \leq 6.5\text{ V}$	–0.75%		0.75%	
$\Delta V_{OUT} / \Delta V_{IN}$	Line regulation	$I_{OUT} = 5\text{ mA}$ $1.4\text{ V} \leq V_{IN} \leq 6.5\text{ V}$		0.0035		mV/V
$\Delta V_{OUT} / \Delta I_{OUT}$	Load regulation	$5\text{ mA} \leq I_{OUT} \leq 4\text{ A}$ $3\text{ V} \leq V_{BIAS} \leq 6.5\text{ V}$ $V_{IN} = 1.1\text{ V}$		0.07		mV/A
		$5\text{ mA} \leq I_{OUT} \leq 4\text{ A}$		0.08		
		$5\text{ mA} \leq I_{OUT} \leq 4\text{ A}$ $V_{OUT} = 5.1\text{ V}$		0.4		
$V_{DO}$	Dropout voltage	$V_{IN} = 1.4\text{ V}$ $I_{OUT} = 4\text{ A}$ $V_{FB} = 0.8\text{ V} - 3\%$		215	320	mV
		$V_{IN} = 5.5\text{ V}$ $I_{OUT} = 4\text{ A}$ $V_{FB} = 0.8\text{ V} - 3\%$		325	500	
		$V_{IN} = 1.1\text{ V}$ $V_{BIAS} = 5\text{ V}$ $I_{OUT} = 4\text{ A}$ $V_{FB} = 0.8\text{ V} - 3\%$		150	240	
		$V_{IN} = 5.7\text{ V}$ $I_{OUT} = 4\text{ A}$ $V_{FB} = 0.8\text{ V} - 3\%$			600	
$I_{LIM}$	Output current limit	$V_{OUT}$ forced at $0.9 \times V_{OUT(nom)}$ , $V_{IN} = V_{OUT(nom)} + 0.4\text{ V}$	4.7	5.2	5.7	A
$I_{SC}$	Short-circuit current limit	$R_{LOAD} = 20\text{ m}\Omega$		1		A

- $V_{OUT(nom)}$  is the calculated  $V_{OUT}$  target value from the ANY-OUT in a fixed configuration. In an adjustable configuration,  $V_{OUT(nom)}$  is the expected  $V_{OUT}$  value set by the external feedback resistors.
- This  $50\text{-}\Omega$  load is disconnected when the test conditions specify an  $I_{OUT}$  value.
- BIAS supply is required when the  $V_{IN}$  supply is below  $1.4\text{ V}$ . Conversely, no BIAS supply is required when the  $V_{IN}$  supply is higher than or equal to  $1.4\text{ V}$ . A BIAS supply helps improve dc and ac performance for  $V_{IN} \leq 2.2\text{ V}$ .
- When the device is connected to external feedback resistors at the FB pin, external resistor tolerances are not included.
- The device is not tested under conditions where  $V_{IN} > V_{OUT} + 1.25\text{ V}$  and  $I_{OUT} = 4\text{ A}$  because the power dissipation is higher than the maximum rating of the package.
- For  $V_{OUT} \leq 5\text{ V}$ ,  $V_{IN} = V_{OUT} + 0.5\text{ V}$ . For  $V_{OUT} > 5\text{ V}$ ,  $V_{IN} = V_{OUT} + 0.6\text{ V}$ .

## Electrical Characteristics (continued)

over operating junction temperature range ( $T_J = -40^\circ\text{C}$  to  $+125^\circ\text{C}$ ),  $V_{IN} = 1.4\text{ V}$  or  $V_{IN} = V_{OUT(nom)} + 0.5\text{ V}$  (whichever is greater),  $V_{BIAS} = \text{open}$ ,  $V_{OUT(nom)} = 0.8\text{ V}^{(1)}$ , OUT connected to  $50\ \Omega$  to GND<sup>(2)</sup>,  $V_{EN} = 1.1\text{ V}$ ,  $C_{IN} = 10\ \mu\text{F}$ ,  $C_{OUT} = 47\ \mu\text{F}$ ,  $C_{NR/SS} = 0\text{ nF}$ ,  $C_{FF} = 0\text{ nF}$ , and PG pin pulled up to  $V_{IN}$  with  $100\text{ k}\Omega$  unless otherwise noted. Typical values are at  $T_J = 25^\circ\text{C}$ .

PARAMETER	TEST CONDITIONS	MIN	TYP	MAX	UNIT	
$I_{GND}$	GND pin current	$V_{IN} = 6.5\text{ V}$ $I_{OUT} = 5\text{ mA}$	2.8	4	mA	
		$V_{IN} = 1.4\text{ V}$ $I_{OUT} = 4\text{ A}$	4.8	6		
		Shutdown, PG = open, $V_{IN} = 6.5\text{ V}$ $V_{EN} = 0.5\text{ V}$			25	$\mu\text{A}$
$I_{EN}$	EN pin current	$V_{IN} = 6.5\text{ V}$ $V_{EN} = 0\text{ V}$ and $6.5\text{ V}$	-0.1	0.1	$\mu\text{A}$	
$I_{BIAS}$	BIAS pin current	$V_{IN} = 1.1\text{ V}$ $V_{BIAS} = 6.5\text{ V}$ $V_{OUT(nom)} = 0.8\text{ V}$ $I_{OUT} = 4\text{ A}$	2.3	3.5	mA	
$V_{IL(EN)}$	EN pin low-level input voltage (disable device)		0	0.5	V	
$V_{IH(EN)}$	EN pin high-level input voltage (enable device)		1.1	6.5	V	
$V_{IT(PG)}$	PG pin threshold	For falling $V_{OUT}$	$82\% \times V_{OUT}$	$88.3\% \times V_{OUT}$	$93\% \times V_{OUT}$	V
$V_{HYS(PG)}$	PG pin hysteresis	For rising $V_{OUT}$	$1\% \times V_{OUT}$			V
$V_{OL(PG)}$	PG pin low-level output voltage	$V_{OUT} < V_{IT(PG)}$ $I_{PG} = -1\text{ mA}$ (current into device)		0.4	V	
$I_{lk(PG)}$	PG pin leakage current	$V_{OUT} > V_{IT(PG)}$ $V_{PG} = 6.5\text{ V}$		1	$\mu\text{A}$	
$I_{NR/SS}$	NR/SS pin charging current	$V_{NR/SS} = \text{GND}$ $V_{IN} = 6.5\text{ V}$	4	6.2	9	$\mu\text{A}$
$I_{FB}$	FB pin leakage current	$V_{IN} = 6.5\text{ V}$	-100	100	nA	
PSRR	Power-supply ripple rejection	$V_{IN} - V_{OUT} = 0.5\text{ V}$ $I_{OUT} = 4\text{ A}$ $C_{NR/SS} = 100\text{ nF}$ $C_{FF} = 10\text{ nF}$ $C_{OUT} = 47\ \mu\text{F} \parallel 10\ \mu\text{F} \parallel 10\ \mu\text{F}$	$f = 10\text{ kHz}$ $V_{OUT} = 0.8\text{ V}$ $V_{BIAS} = 5\text{ V}$	42	dB	
			$f = 500\text{ kHz}$ $V_{OUT} = 0.8\text{ V}$ $V_{BIAS} = 5\text{ V}$	39		
			$f = 10\text{ kHz}$ $V_{OUT} = 5\text{ V}$	40		
			$f = 500\text{ kHz}$ $V_{OUT} = 5\text{ V}$	25		
$V_n$	Output noise voltage	Bandwidth = 10 Hz to 100 kHz, $V_{IN} = 1.1\text{ V}$ $V_{OUT} = 0.8\text{ V}$ $V_{BIAS} = 5\text{ V}$ $I_{OUT} = 4\text{ A}$ $C_{NR/SS} = 100\text{ nF}$ $C_{FF} = 10\text{ nF}$ $C_{OUT} = 47\ \mu\text{F} \parallel 10\ \mu\text{F} \parallel 10\ \mu\text{F}$	4.4	$\mu\text{V}_{RMS}$		
			Bandwidth = 10 Hz to 100 kHz $V_{OUT} = 5\text{ V}$ $I_{OUT} = 4\text{ A}$ $C_{NR/SS} = 100\text{ nF}$ $C_{FF} = 10\text{ nF}$ $C_{OUT} = 47\ \mu\text{F} \parallel 10\ \mu\text{F} \parallel 10\ \mu\text{F}$		8.4	
$T_{sd}$	Thermal shutdown temperature	Shutdown, temperature increasing	160	$^\circ\text{C}$		
		Reset, temperature decreasing	140			
$T_J$	Operating junction temperature		-40	125	$^\circ\text{C}$	

### 6.6 Typical Characteristics

at  $T_A = 25^\circ\text{C}$ ,  $V_{IN} = 1.4\text{ V}$  or  $V_{IN} = V_{OUT(NOM)} + 0.5\text{ V}$  (whichever is greater),  $V_{BIAS} = \text{open}$ ,  $V_{OUT(NOM)} = 0.8\text{ V}$ ,  $V_{EN} = 1.1\text{ V}$ ,  $C_{OUT} = 47\text{ }\mu\text{F}$ ,  $C_{NR/SS} = 0\text{ nF}$ ,  $C_{FF} = 0\text{ nF}$ , and PG pin pulled up to  $V_{IN}$  with  $100\text{ k}\Omega$  (unless otherwise noted)

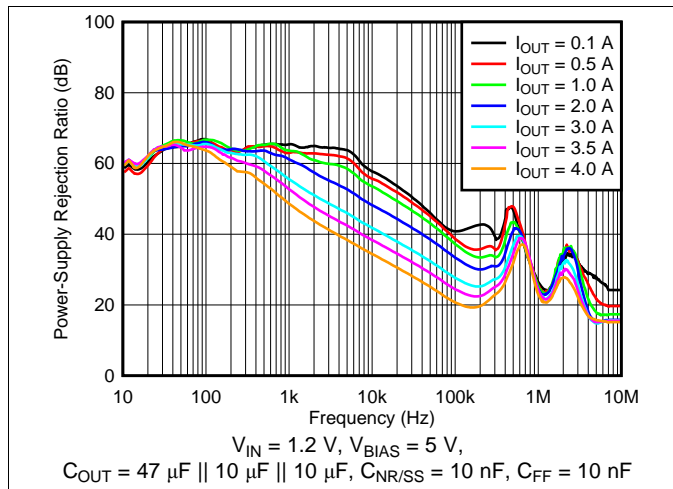

Figure 1. PSRR vs Frequency and  $I_{OUT}$

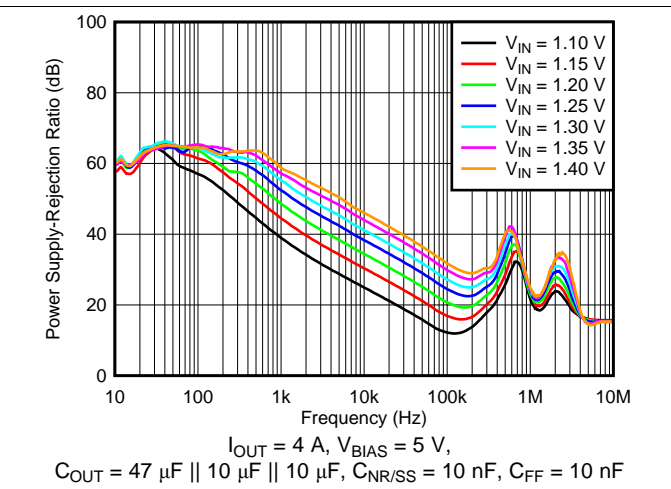

Figure 2. PSRR vs Frequency and  $V_{IN}$  With Bias

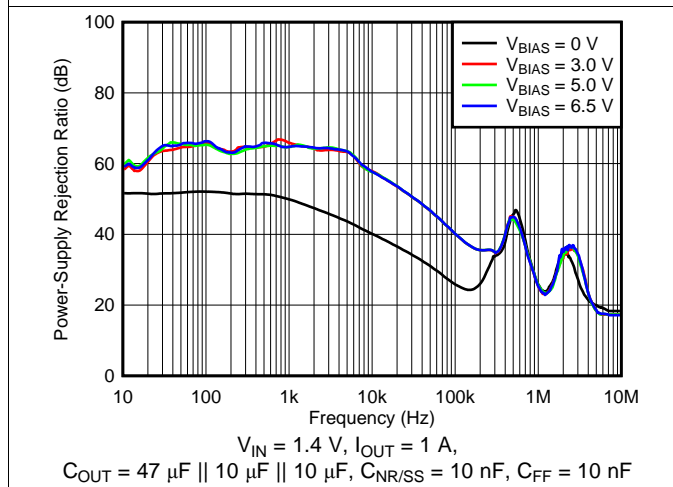

Figure 3. PSRR vs Frequency and  $V_{BIAS}$

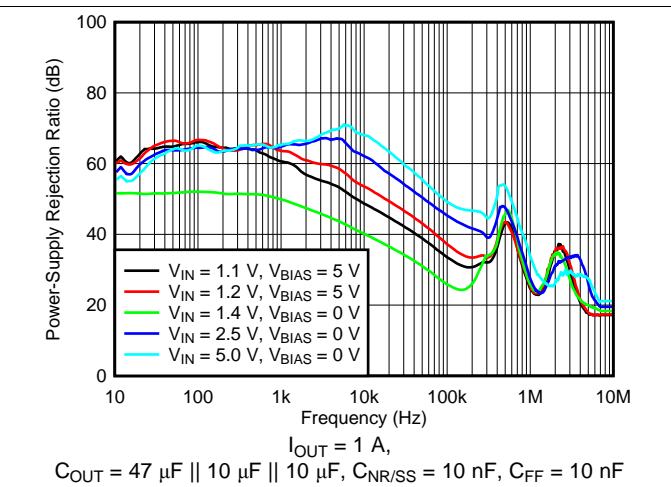

Figure 4. PSRR vs Frequency and  $V_{IN}$

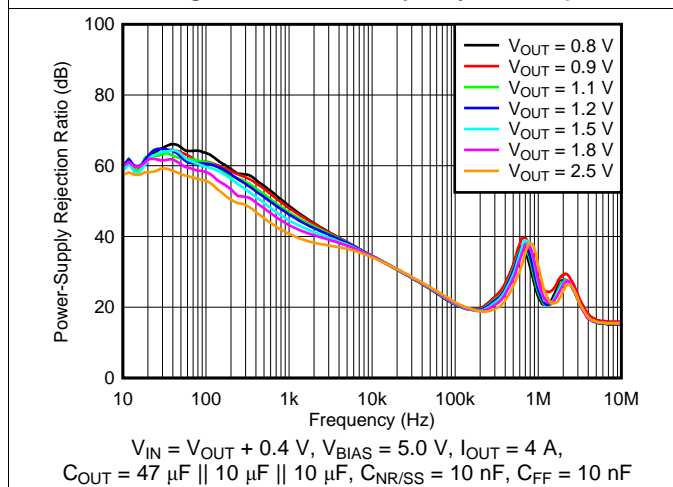

Figure 5. PSRR vs Frequency and  $V_{OUT}$  With Bias

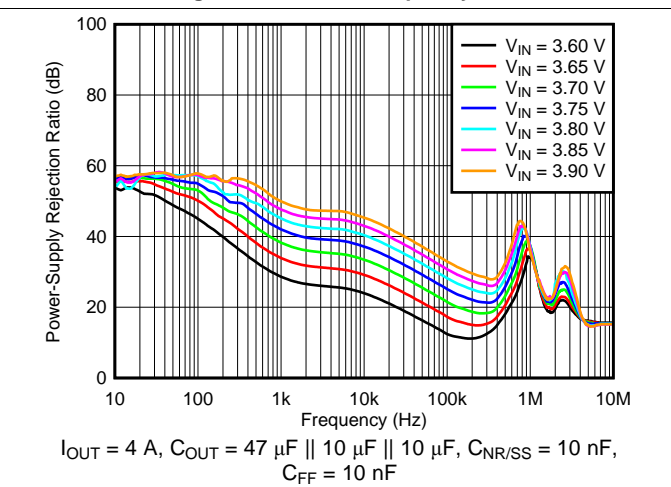

Figure 6. PSRR vs Frequency and  $V_{IN}$  for  $V_{OUT} = 3.3\text{ V}$



Typical Characteristics (continued)

at  $T_A = 25^\circ\text{C}$ ,  $V_{IN} = 1.4\text{ V}$  or  $V_{IN} = V_{OUT(NOM)} + 0.5\text{ V}$  (whichever is greater),  $V_{BIAS} = \text{open}$ ,  $V_{OUT(NOM)} = 0.8\text{ V}$ ,  $V_{EN} = 1.1\text{ V}$ ,  $C_{OUT} = 47\text{ }\mu\text{F}$ ,  $C_{NR/SS} = 0\text{ nF}$ ,  $C_{FF} = 0\text{ nF}$ , and PG pin pulled up to  $V_{IN}$  with  $100\text{ k}\Omega$  (unless otherwise noted)

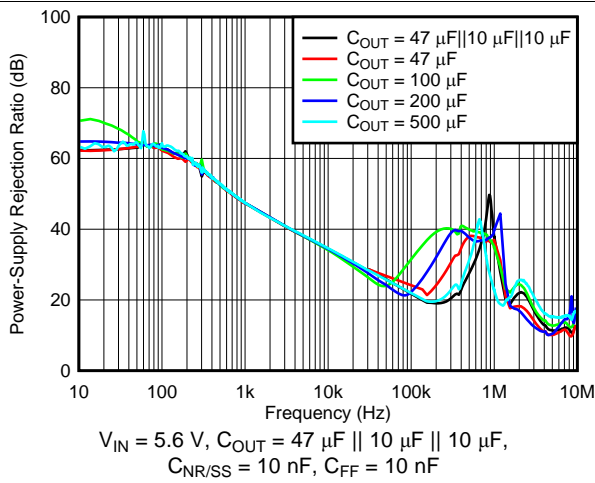

Figure 7. PSRR vs Frequency and  $C_{OUT}$

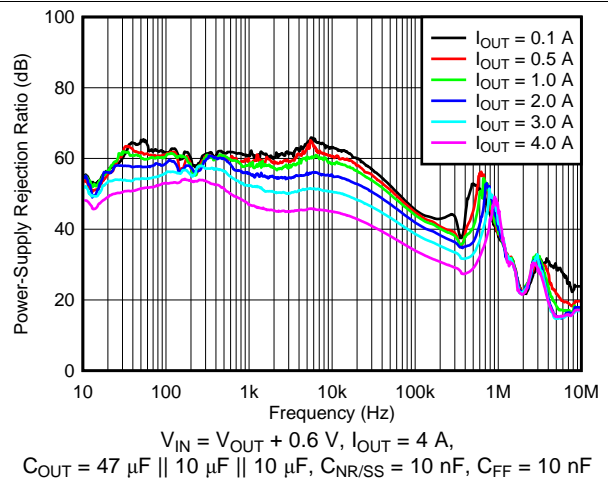

Figure 8. PSRR vs Frequency and  $I_{OUT}$  for  $V_{OUT} = 5\text{ V}$

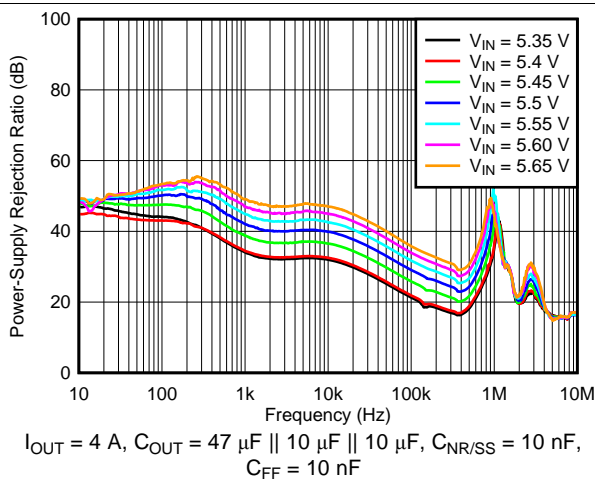

Figure 9. PSRR vs Frequency and  $V_{IN}$  for  $V_{OUT} = 5\text{ V}$

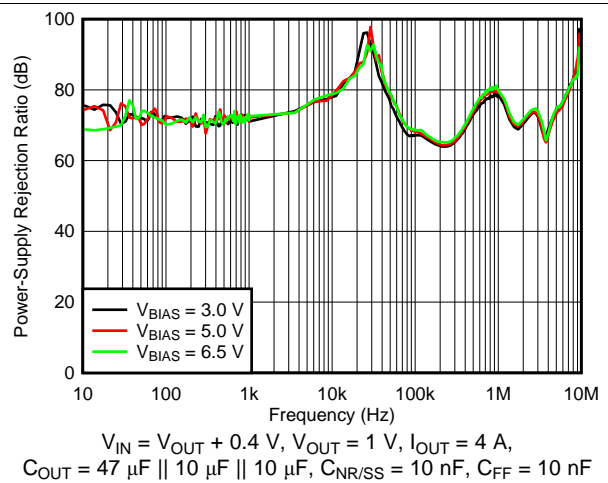

Figure 10.  $V_{BIAS}$  PSRR vs Frequency

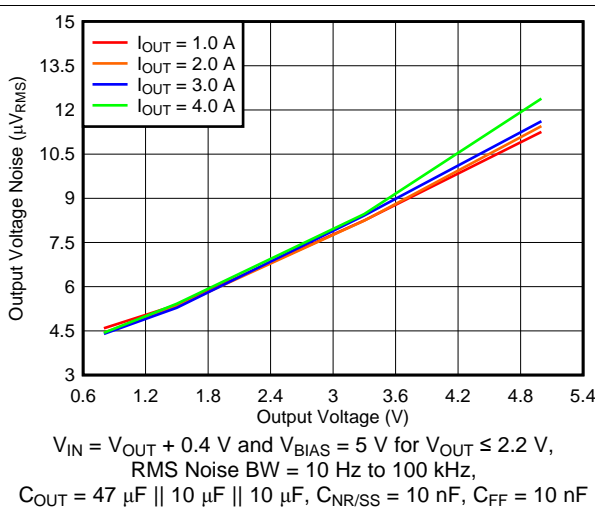

Figure 11. Output Voltage Noise vs Output Voltage

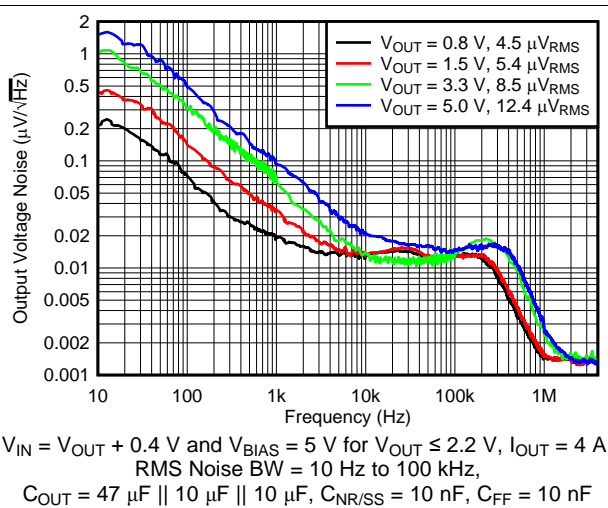
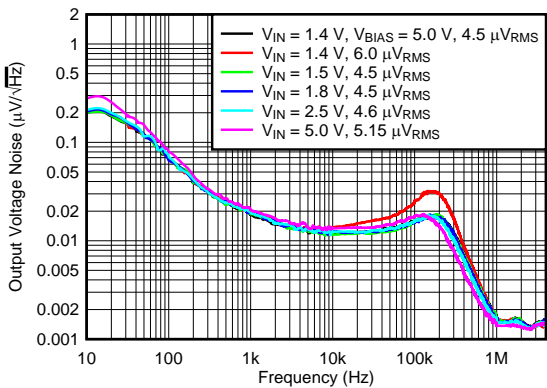

Figure 12. Output Noise vs Frequency and  $V_{OUT}$

Typical Characteristics (continued)

at  $T_A = 25^\circ\text{C}$ ,  $V_{IN} = 1.4\text{ V}$  or  $V_{IN} = V_{OUT(NOM)} + 0.5\text{ V}$  (whichever is greater),  $V_{BIAS} = \text{open}$ ,  $V_{OUT(NOM)} = 0.8\text{ V}$ ,  $V_{EN} = 1.1\text{ V}$ ,  $C_{OUT} = 47\text{ }\mu\text{F}$ ,  $C_{NR/SS} = 0\text{ nF}$ ,  $C_{FF} = 0\text{ nF}$ , and PG pin pulled up to  $V_{IN}$  with  $100\text{ k}\Omega$  (unless otherwise noted)



$I_{OUT} = 1\text{ A}$ , RMS Noise BW = 10 Hz to 100 kHz,  $C_{OUT} = 47\text{ }\mu\text{F} \parallel 10\text{ }\mu\text{F} \parallel 10\text{ }\mu\text{F}$ ,  $C_{NR/SS} = 10\text{ nF}$ ,  $C_{FF} = 10\text{ nF}$

Figure 13. Output Noise vs Frequency and  $V_{IN}$

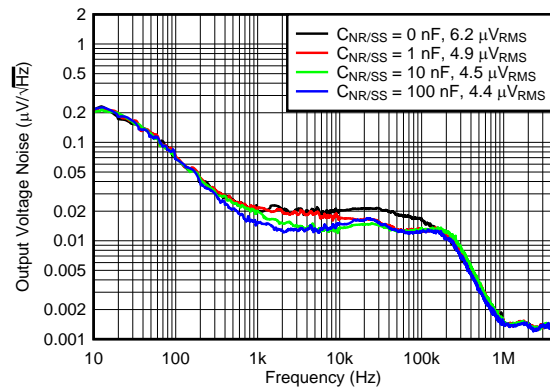

$V_{IN} = V_{OUT} + 0.4\text{ V}$ ,  $V_{BIAS} = 5\text{ V}$ ,  $I_{OUT} = 4\text{ A}$ , RMS Noise BW = 10 Hz to 100 kHz,  $C_{OUT} = 47\text{ }\mu\text{F} \parallel 10\text{ }\mu\text{F} \parallel 10\text{ }\mu\text{F}$ ,  $C_{FF} = 10\text{ nF}$

Figure 14. Output Noise vs Frequency and  $C_{NR/SS}$

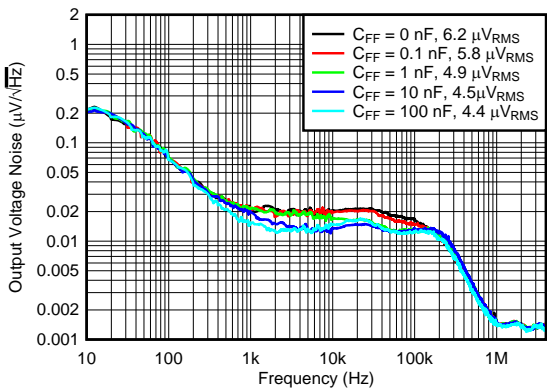

$V_{IN} = V_{OUT} + 0.4\text{ V}$ ,  $V_{BIAS} = 5\text{ V}$ ,  $I_{OUT} = 4\text{ A}$ , RMS Noise BW = 10 Hz to 100 kHz,  $C_{OUT} = 47\text{ }\mu\text{F} \parallel 10\text{ }\mu\text{F} \parallel 10\text{ }\mu\text{F}$ ,  $C_{NR/SS} = 10\text{ nF}$

Figure 15. Output Noise vs Frequency and  $C_{FF}$

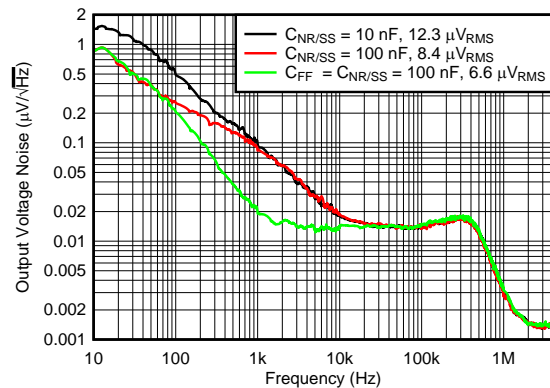

$V_{IN} = 5.6\text{ V}$ ,  $I_{OUT} = 4\text{ A}$ , RMS Noise BW = 10 Hz to 100 kHz,  $C_{OUT} = 47\text{ }\mu\text{F} \parallel 10\text{ }\mu\text{F} \parallel 10\text{ }\mu\text{F}$ ,  $C_{FF} = 10\text{ nF}$

Figure 16. Output Noise at 5.0-V Output vs  $C_{NR/SS}$  and  $C_{FF}$

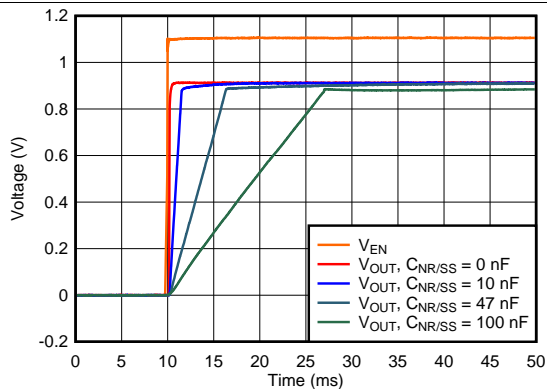

$V_{IN} = 1.2\text{ V}$ ,  $V_{OUT} = 0.9\text{ V}$ ,  $V_{BIAS} = 5.0\text{ V}$ ,  $I_{OUT} = 4\text{ A}$ ,  $C_{OUT} = 47\text{ }\mu\text{F} \parallel 10\text{ }\mu\text{F} \parallel 10\text{ }\mu\text{F}$ ,  $C_{FF} = 10\text{ nF}$

Figure 17. Start-Up Waveform vs Time and  $C_{NR/SS}$

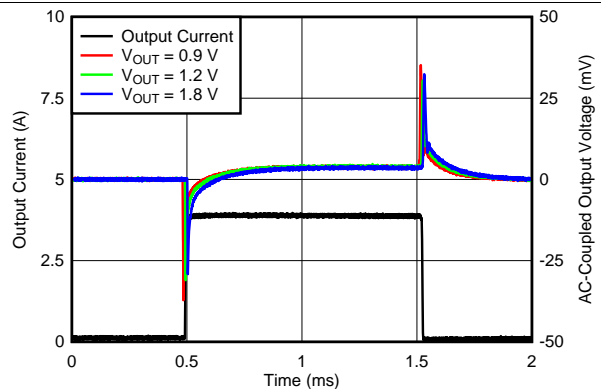

$V_{IN} = V_{OUT} + 0.3\text{ V}$ ,  $V_{BIAS} = 5\text{ V}$ ,  $I_{OUT, DC} = 100\text{ mA}$ , slew rate =  $1\text{ A}/\mu\text{s}$ ,  $C_{NR/SS} = C_{FF} = 10\text{ nF}$ ,  $C_{OUT} = 47\text{ }\mu\text{F} \parallel 10\text{ }\mu\text{F} \parallel 10\text{ }\mu\text{F}$

Figure 18. Load Transient Waveform vs Time and  $V_{OUT}$  With Bias

Typical Characteristics (continued)

at  $T_A = 25^\circ\text{C}$ ,  $V_{IN} = 1.4\text{ V}$  or  $V_{IN} = V_{OUT(NOM)} + 0.5\text{ V}$  (whichever is greater),  $V_{BIAS} = \text{open}$ ,  $V_{OUT(NOM)} = 0.8\text{ V}$ ,  $V_{EN} = 1.1\text{ V}$ ,  $C_{OUT} = 47\text{ }\mu\text{F}$ ,  $C_{NR/SS} = 0\text{ nF}$ ,  $C_{FF} = 0\text{ nF}$ , and PG pin pulled up to  $V_{IN}$  with  $100\text{ k}\Omega$  (unless otherwise noted)

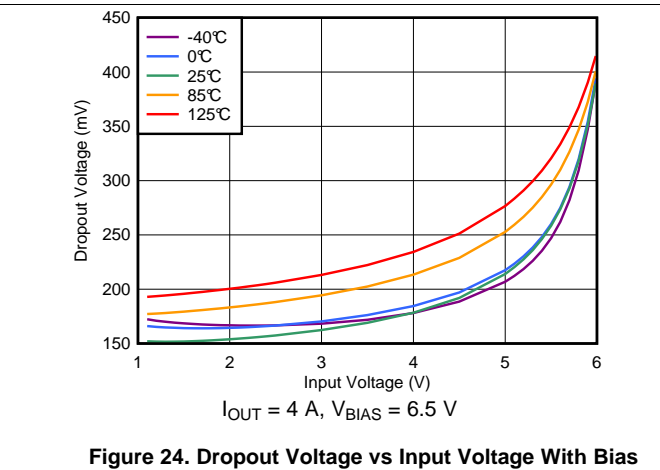
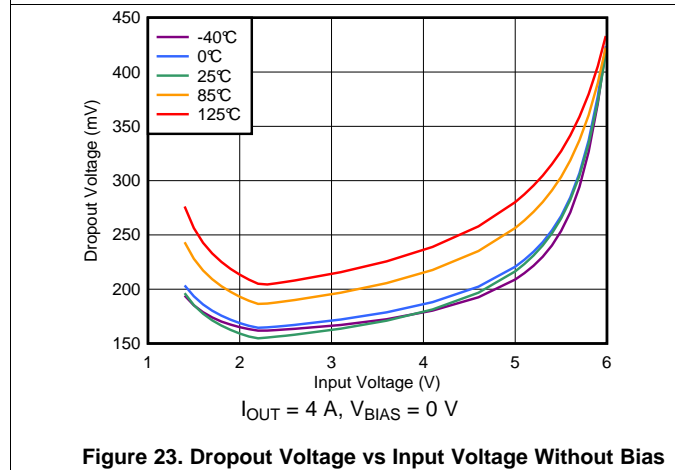
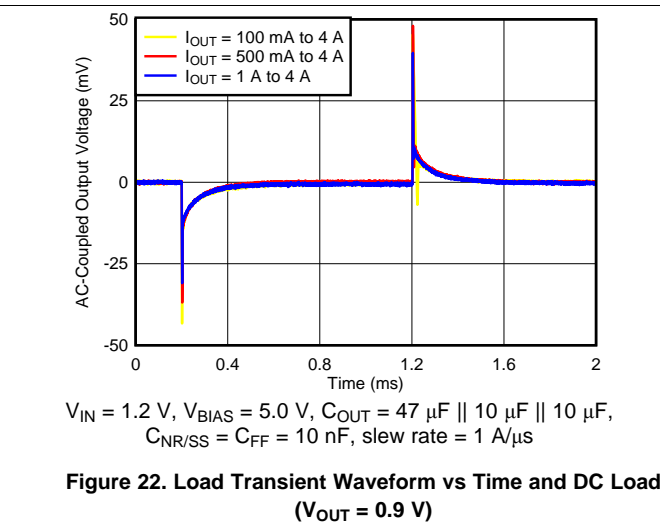
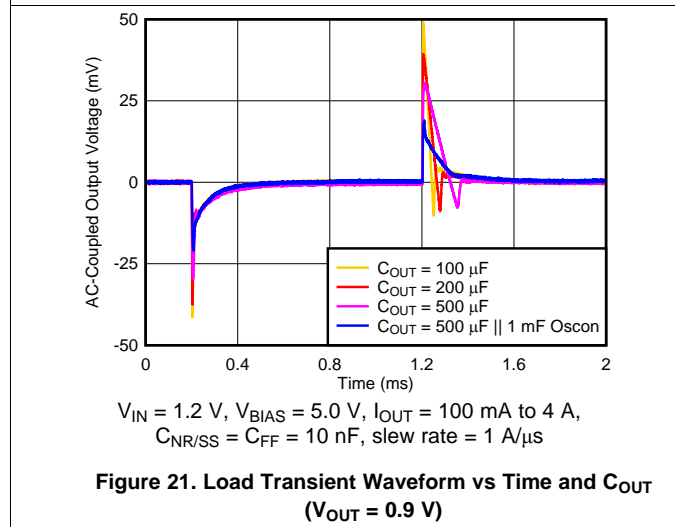
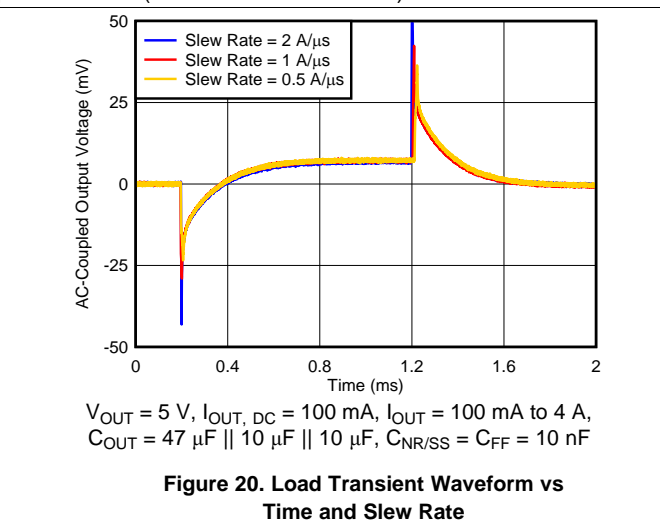
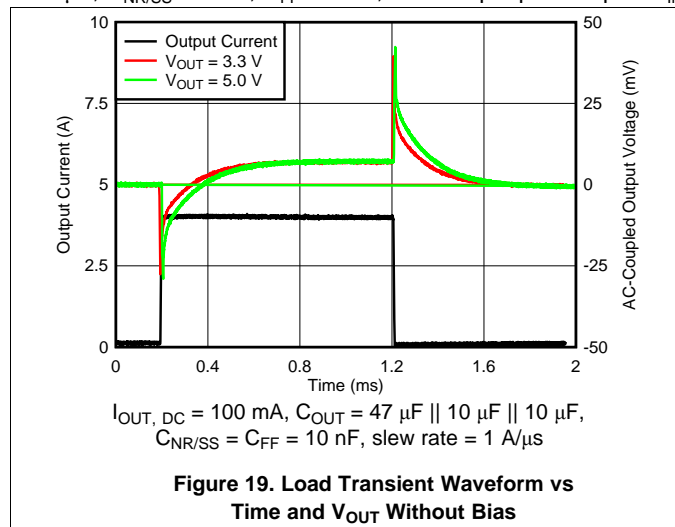

### Typical Characteristics (continued)

at  $T_A = 25^\circ\text{C}$ ,  $V_{IN} = 1.4\text{ V}$  or  $V_{IN} = V_{OUT(NOM)} + 0.5\text{ V}$  (whichever is greater),  $V_{BIAS} = \text{open}$ ,  $V_{OUT(NOM)} = 0.8\text{ V}$ ,  $V_{EN} = 1.1\text{ V}$ ,  $C_{OUT} = 47\text{ }\mu\text{F}$ ,  $C_{NR/SS} = 0\text{ nF}$ ,  $C_{FF} = 0\text{ nF}$ , and PG pin pulled up to  $V_{IN}$  with  $100\text{ k}\Omega$  (unless otherwise noted)

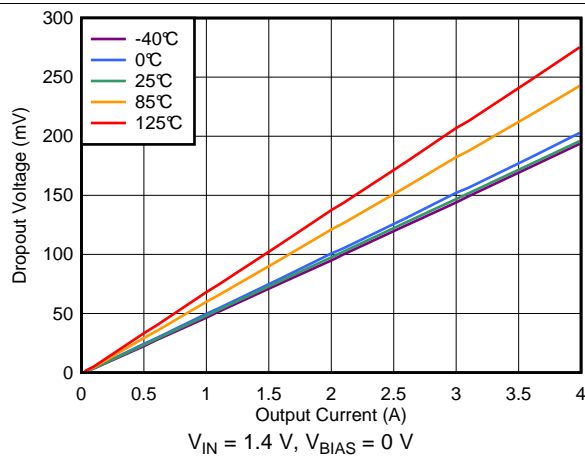

Figure 25. Dropout Voltage vs Output Current Without Bias

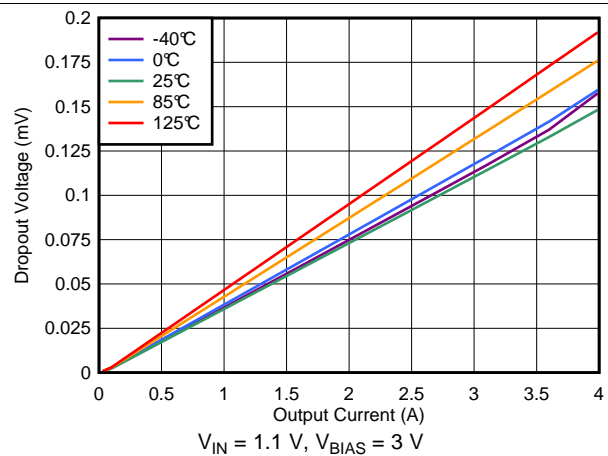

Figure 26. Dropout Voltage vs Output Current With Bias

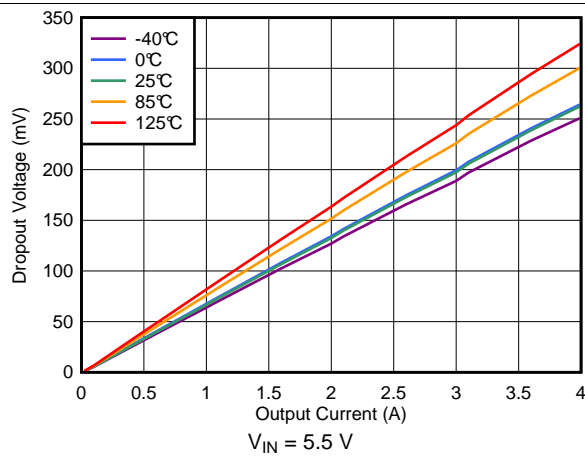

Figure 27. Dropout Voltage vs Output Current (High  $V_{IN}$ )

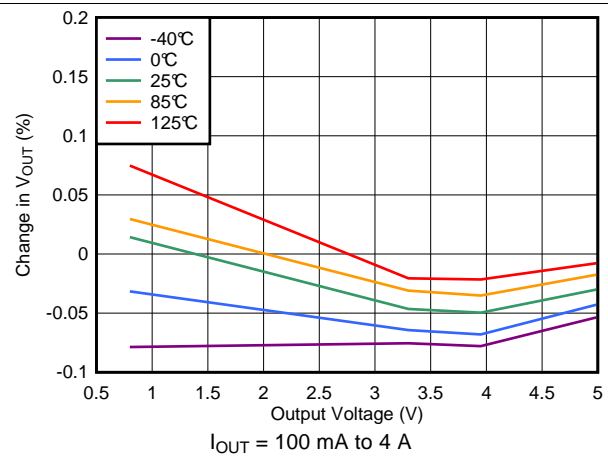

Figure 28. Load Regulation vs Output Voltage

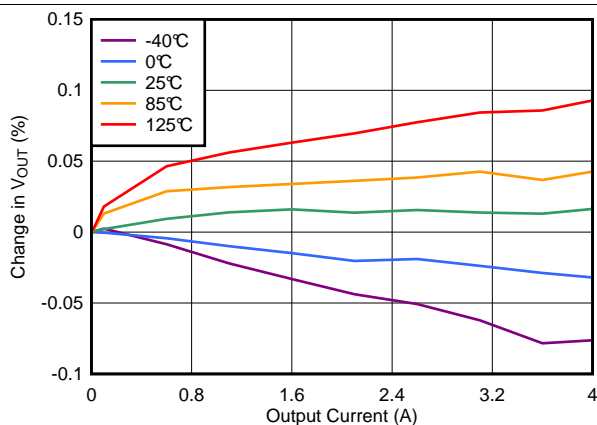

Figure 29. Load Regulation (0.8-V Output)

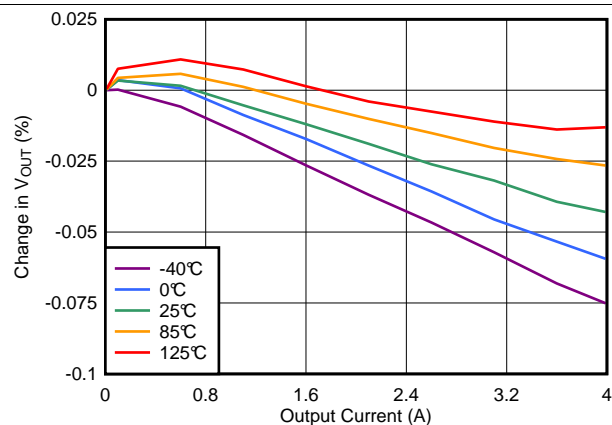

Figure 30. Load Regulation (3.3-V Output)

Typical Characteristics (continued)

at  $T_A = 25^\circ\text{C}$ ,  $V_{IN} = 1.4\text{ V}$  or  $V_{IN} = V_{OUT(NOM)} + 0.5\text{ V}$  (whichever is greater),  $V_{BIAS} = \text{open}$ ,  $V_{OUT(NOM)} = 0.8\text{ V}$ ,  $V_{EN} = 1.1\text{ V}$ ,  $C_{OUT} = 47\text{ }\mu\text{F}$ ,  $C_{NR/SS} = 0\text{ nF}$ ,  $C_{FF} = 0\text{ nF}$ , and PG pin pulled up to  $V_{IN}$  with  $100\text{ k}\Omega$  (unless otherwise noted)

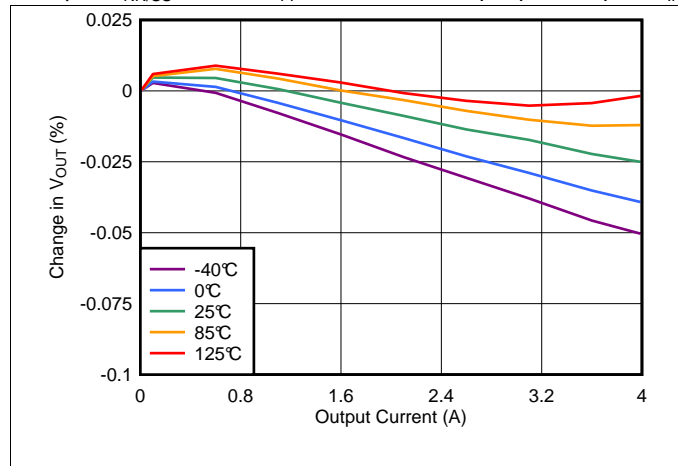

Figure 31. Load Regulation (5-V Output)

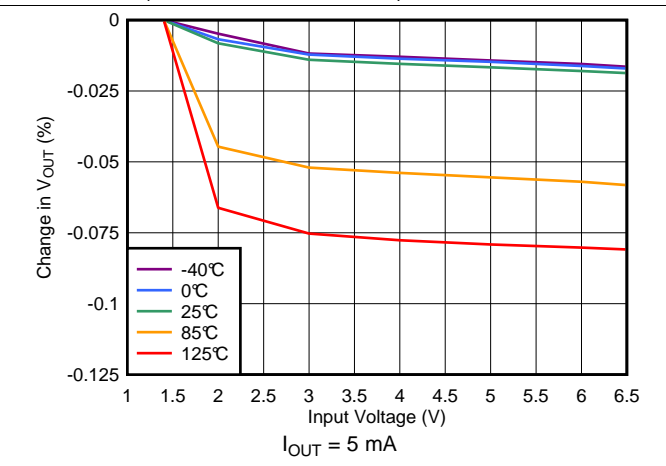

Figure 32. Line Regulation Without Bias

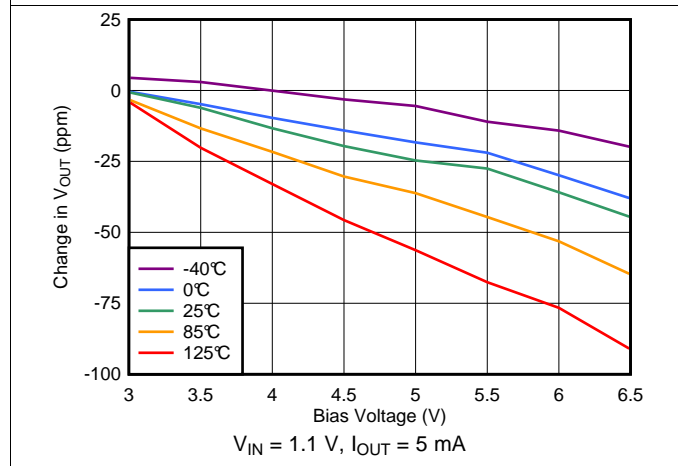

Figure 33. Line Regulation vs Bias Voltage

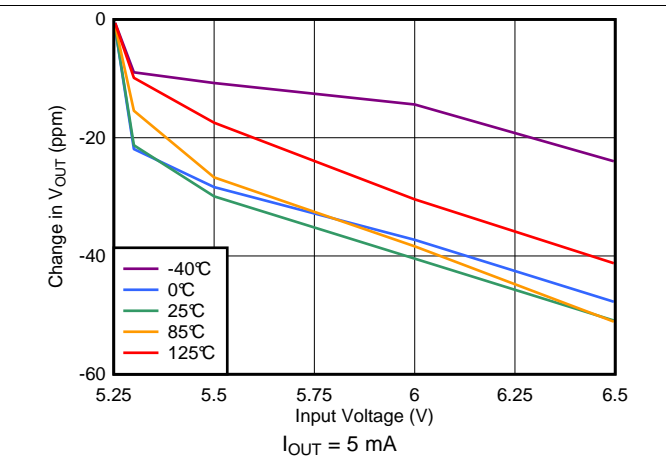

Figure 34. Line Regulation (5-V Output)

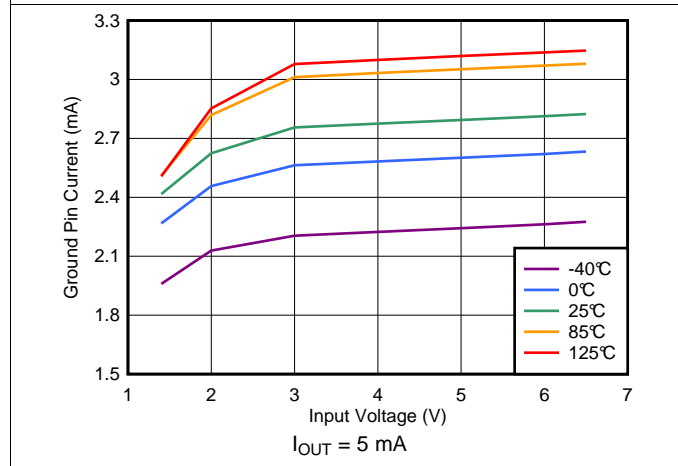

Figure 35. Ground Pin Current vs Input Voltage

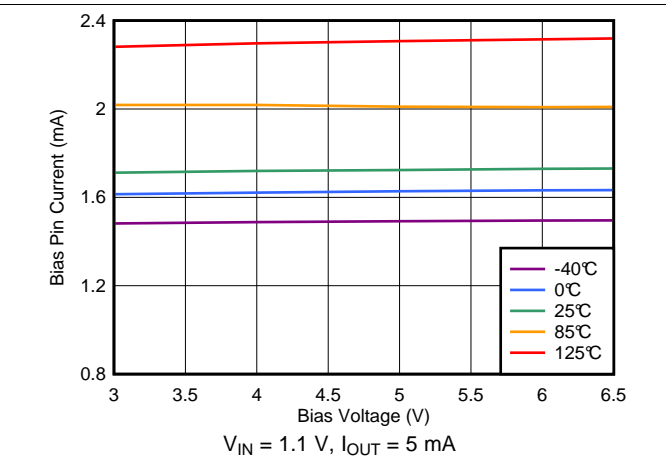

Figure 36. Bias Pin Current vs Bias Voltage

### Typical Characteristics (continued)

at  $T_A = 25^\circ\text{C}$ ,  $V_{IN} = 1.4\text{ V}$  or  $V_{IN} = V_{OUT(NOM)} + 0.5\text{ V}$  (whichever is greater),  $V_{BIAS} = \text{open}$ ,  $V_{OUT(NOM)} = 0.8\text{ V}$ ,  $V_{EN} = 1.1\text{ V}$ ,  $C_{OUT} = 47\text{ }\mu\text{F}$ ,  $C_{NR/SS} = 0\text{ nF}$ ,  $C_{FF} = 0\text{ nF}$ , and PG pin pulled up to  $V_{IN}$  with  $100\text{ k}\Omega$  (unless otherwise noted)

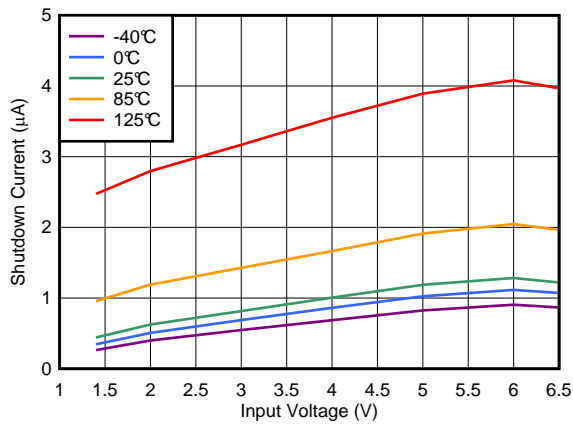

Figure 37. Shutdown Current vs Input Voltage

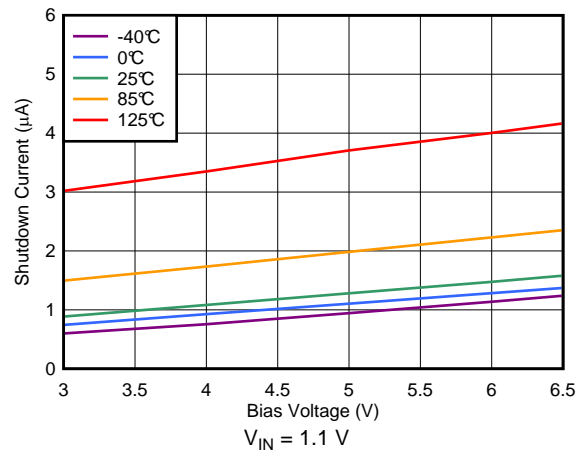

Figure 38. Shutdown Current vs Bias Voltage

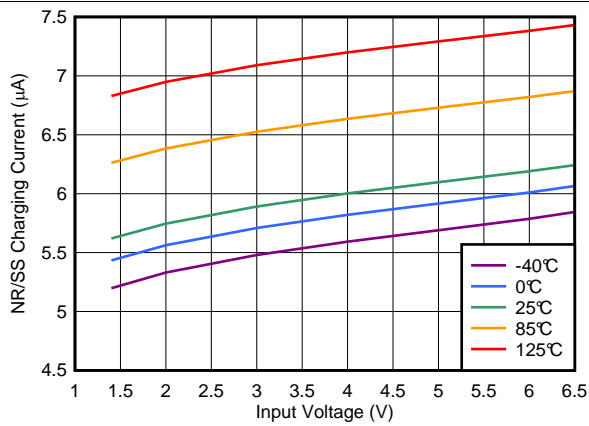

Figure 39. NR/SS Charging Current vs Input Voltage

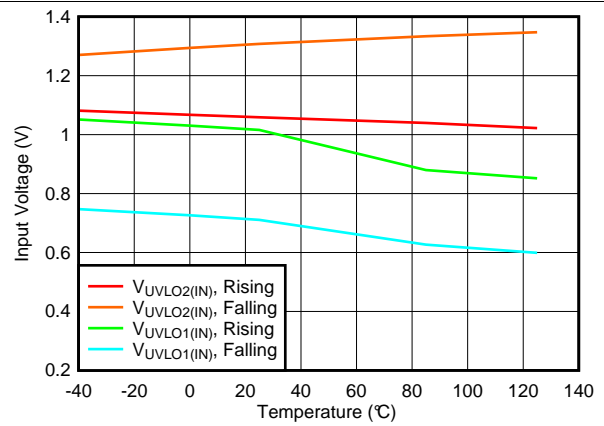

Figure 40.  $V_{IN}$  UVLO vs Temperature

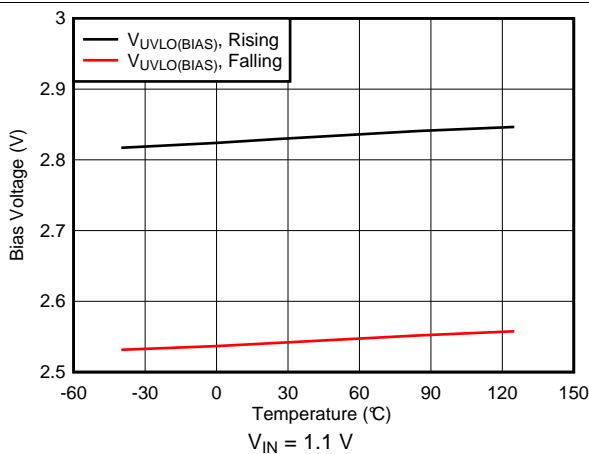

Figure 41.  $V_{BIAS}$  UVLO vs Temperature

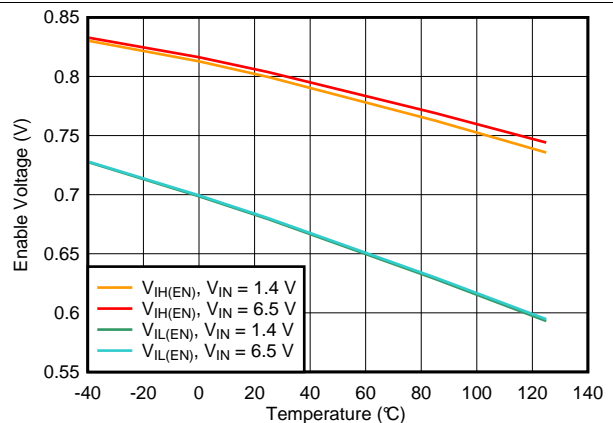

Figure 42. Enable Threshold vs Temperature

Typical Characteristics (continued)

at  $T_A = 25^\circ\text{C}$ ,  $V_{IN} = 1.4\text{ V}$  or  $V_{IN} = V_{OUT(NOM)} + 0.5\text{ V}$  (whichever is greater),  $V_{BIAS} = \text{open}$ ,  $V_{OUT(NOM)} = 0.8\text{ V}$ ,  $V_{EN} = 1.1\text{ V}$ ,  $C_{OUT} = 47\ \mu\text{F}$ ,  $C_{NR/SS} = 0\text{ nF}$ ,  $C_{FF} = 0\text{ nF}$ , and PG pin pulled up to  $V_{IN}$  with  $100\text{ k}\Omega$  (unless otherwise noted)

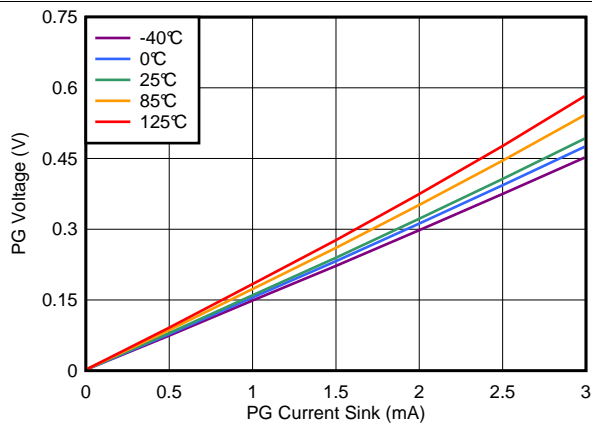

Figure 43. PG Voltage vs PG Current Sink

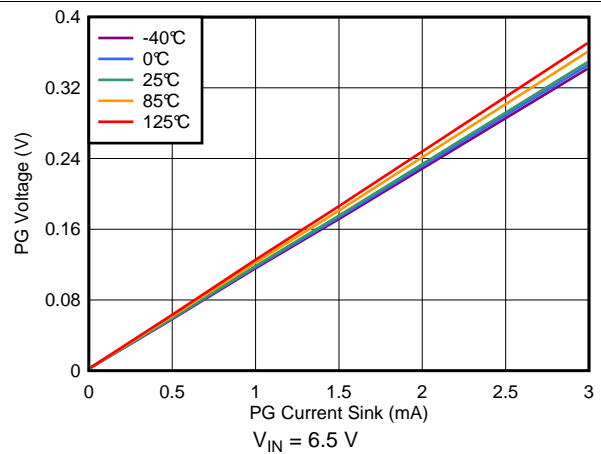

Figure 44. PG Voltage vs PG Current Sink

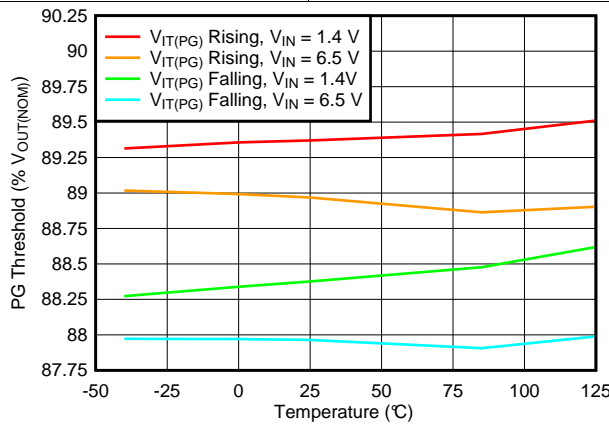

Figure 45. PG Threshold vs Temperature

## 7 Detailed Description

### 7.1 Overview

The TPS7A85A is a high-current (4 A), low-noise (4.4  $\mu\text{V}_{\text{RMS}}$ ), high accuracy (0.75%) low-dropout linear voltage regulator (LDO). These features make the device a robust solution to solve many challenging problems in generating a clean, accurate power supply.

The TPS7A85A has several features that makes the device useful in a variety of applications. See [Table 1](#) for a categorization of the functions shown in the [Functional Block Diagram](#).

**Table 1. Features**

VOLTAGE REGULATION	SYSTEM START-UP	INTERNAL PROTECTION
High accuracy	Programmable soft-start	Foldback current limit
Low-noise, high-PSRR output	No sequencing requirement between BIAS, IN and EN	Thermal shutdown
Fast transient response	Power-good output	
	Start-up with negative bias on OUT	

Overall, these features make the TPS7A85A the component of choice due to its versatility and ability to generate a supply for most applications.

### 7.2 Functional Block Diagram

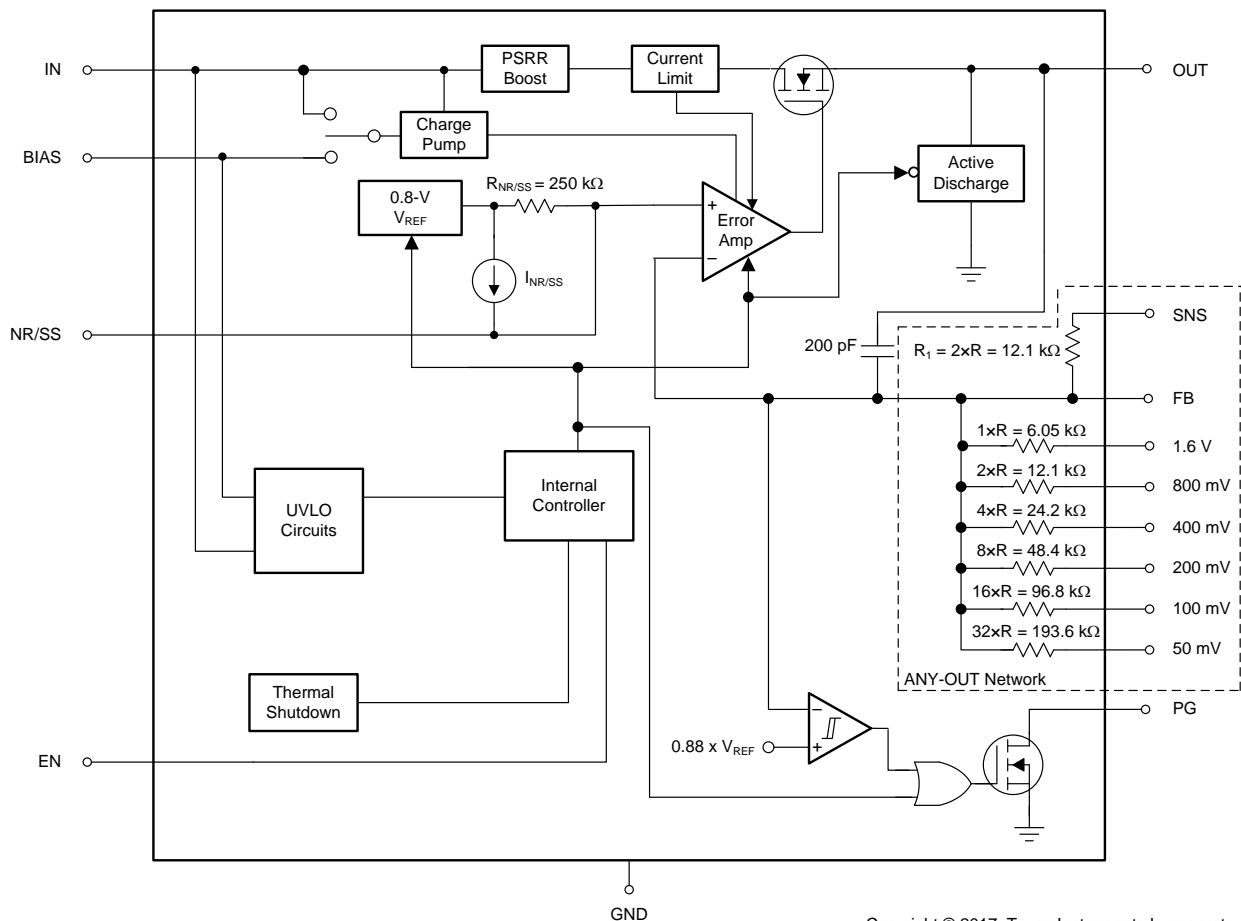

Copyright © 2017, Texas Instruments Incorporated

NOTE: For the ANY-OUT network, the ratios between the values are highly accurate as a result of matching, but the actual resistance may vary significantly from the numbers listed.



## 7.3 Feature Description

### 7.3.1 Voltage Regulation Features

#### 7.3.1.1 DC Regulation

An LDO functions as a class-B amplifier in which the input signal is the internal reference voltage ( $V_{REF}$ ), as shown in [Figure 46](#).  $V_{REF}$  is designed to have a very low bandwidth at the input to the error amplifier through the use of a low-pass filter ( $V_{NR/SS}$ ).

As such, the reference can be considered as a pure dc input signal. The low output impedance of an LDO comes from the combination of the output capacitor and pass element. The pass element presents a high input impedance to the source voltage when operating as a current source. A positive LDO can only source current because of the class-B architecture.

This device achieves a maximum of 0.75% output voltage accuracy primarily because of the high-precision band-gap voltage ( $V_{BG}$ ) that creates  $V_{REF}$ . The low dropout voltage ( $V_{DO}$ ) reduces the thermal power dissipation required by the device to regulate the output voltage at a given current level, which improves system efficiency. These features combine to make this device a good approximation of an ideal voltage source.

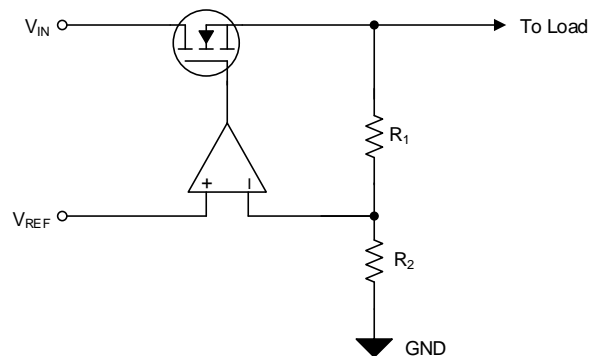

NOTE:  $V_{OUT} = V_{REF} \times (1 + R_1 / R_2)$ .

**Figure 46. Simplified Regulation Circuit**

#### 7.3.1.2 AC and Transient Response

The LDO responds quickly to a transient (large-signal response) on the input supply (line transient) or the output current (load transient) resulting from the LDO high-input impedance and low output-impedance across frequency. This same capability also means that the LDO has a high power-supply rejection ratio (PSRR) and, when coupled with a low internal noise-floor ( $V_n$ ), the LDO approximates an ideal power supply in ac (small-signal) and large-signal conditions.

The choice of external component values optimizes the small- and large-signal response. The NR/SS capacitor ( $C_{NR/SS}$ ) and feed-forward capacitor ( $C_{FF}$ ) reduce the device noise floor and improve PSRR; see [Optimizing Noise and PSRR](#) for more information on optimizing the noise and PSRR performance.

### 7.3.2 System Start-Up Features

In many different applications, the power-supply output must turn on within a specific window of time to either ensure proper operation of the load or to minimize the loading on the input supply or other sequencing requirements. The LDO start-up is well-controlled and user-adjustable, solving the demanding requirements faced by many power-supply design engineers in a simple fashion.

#### 7.3.2.1 Programmable Soft Start (NR/SS)

Soft start directly controls the output start-up time and indirectly controls the output current during start-up (inrush current).

The external capacitor at the NR/SS pin ( $C_{NR/SS}$ ) sets the output start-up time by setting the rise time of the internal reference ( $V_{NR/SS}$ ), as shown in [Figure 47](#).

Feature Description (continued)

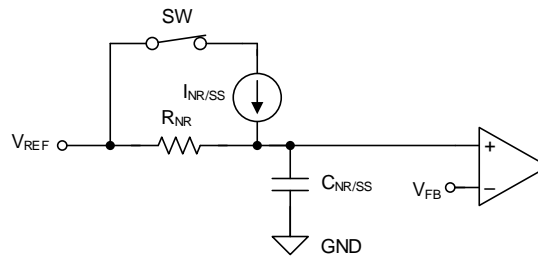

Figure 47. Simplified Soft-Start Circuit

7.3.2.2 Internal Sequencing

Controlling when a single power supply turns on can be difficult in a power distribution network (PDN) because of the high power levels inherent in a PDN, and the variations between all of the supplies. The LDO turnon and turnoff time is set by the enable circuit (EN) and undervoltage lockout circuits ( $UVLO_{1,2(IN)}$  and  $UVLO_{BIAS}$ ), as shown in Figure 48 and Table 2.

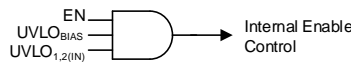

Figure 48. Simplified Turnon Control

Table 2. Internal Sequencing Functionality Table

INPUT VOLTAGE	BIAS VOLTAGE	ENABLE STATUS	LDO STATUS	ACTIVE DISCHARGE	POWER GOOD
$V_{IN} \geq V_{UVLO_{1,2(IN)}}$	$V_{BIAS} \geq V_{UVLO(BIAS)}$	EN = 1	On	Off	PG = 1 when $V_{OUT} \geq V_{IT(PG)}$
	$V_{BIAS} < V_{UVLO(BIAS)} + V_{HYS(BIAS)}$	EN = 0	Off	On	
$V_{IN} < V_{UVLO_{1,2(IN)}} - V_{HYS_{1,2(IN)}}$	BIAS = don't care	EN = don't care	Off	On <sup>(1)</sup>	PG = 0
IN = don't care	$V_{BIAS} \geq V_{UVLO(BIAS)}$		Off		

(1) The active discharge remains on as long as  $V_{IN}$  or  $V_{BIAS}$  provides enough headroom for the discharge circuit to function.

7.3.2.2.1 Enable (EN)

The enable signal ( $V_{EN}$ ) is an active-high digital control that enables the LDO when the enable voltage is past the rising threshold ( $V_{EN} \geq V_{IH(EN)}$ ) and disables the LDO when the enable voltage is below the falling threshold ( $V_{EN} \leq V_{IL(EN)}$ ). The exact enable threshold is between  $V_{IH(EN)}$  and  $V_{IL(EN)}$  because EN is a digital control. Connect EN to  $V_{IN}$  if enable functionality is not desired.

### 7.3.2.2.2 Undervoltage Lockout (UVLO) Control

The UVLO circuits respond quickly to glitches on IN or BIAS and attempts to disable the output of the device if either of these rails collapse.

The local input capacitance prevents severe brownouts in most applications; see [Undervoltage Lockout \(UVLO\)](#) for more details.

### 7.3.2.2.3 Active Discharge

When EN or UVLO is low, the device connects a resistor of several hundred ohms from  $V_{OUT}$  to GND, discharging the output capacitance.

Do not rely on the active discharge circuit for discharging large output capacitors when the input voltage drops below the targeted output voltage. Current flows from the output to the input (reverse current) when  $V_{OUT} > V_{IN}$ , which can cause damage to the device (when  $V_{OUT} > V_{IN} + 0.3\text{ V}$ ); see [Reverse Current](#) for more details.

### 7.3.2.3 Power-Good Output (PG)

The PG signal provides an easy solution to meet demanding sequencing requirements because PG signals when the output nears its nominal value. PG can be used to signal other devices in a system when the output voltage is near, at, or above the set output voltage ( $V_{OUT(nom)}$ ). A simplified schematic is shown in [Figure 49](#).

The PG signal is an open-drain digital output that requires a pullup resistor to a voltage source and is active high. The PG circuit sets the PG pin into a high-impedance state to indicate that the power is good.

Using a large feed-forward capacitor ( $C_{FF}$ ) delays the output voltage and, because the PG circuit monitors the FB pin, the PG signal can indicate a false positive. A simple solution to this scenario is to use an external voltage detector device, such as the [TPS3890](#); see [Feed-Forward Capacitor \( \$C\_{FF}\$ \)](#) for more information.

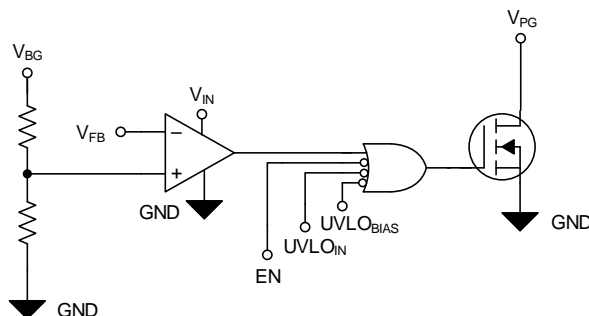

Figure 49. Simplified PG Circuit

## 7.3.3 Internal Protection Features

In many applications, fault events can occur that damage devices in the system. Short circuits and excessive heat are the most common fault events for power supplies. The TPS7A85A implements circuitry to protect the device and the load during these events. Continuously operating in these fault conditions or above a junction temperature of 125°C is not recommended because the long-term reliability of the device is reduced.

### 7.3.3.1 Foldback Current Limit ( $I_{CL}$ )

The internal current limit circuit protects the LDO against high load-current faults or shorting events. During a current-limit event, the LDO sources constant current. As a result, the output voltage falls with decreased load impedance. Thermal shutdown can activate during a current limit event because of the high power dissipation typically found in these conditions. To ensure proper operation of the current limit, minimize the inductances to the input and load. Continuous operation in current limit is not recommended.

### 7.3.3.2 Thermal Protection ( $T_{sd}$ )

The thermal shutdown circuit protects the LDO against excessive heat in the system, resulting from current limit or high ambient temperature.

The output of the LDO turns off when the LDO temperature (junction temperature,  $T_J$ ) exceeds the rising thermal shutdown temperature. The output turns on again after  $T_J$  decreases below the falling thermal shutdown temperature.

A high power dissipation across the device, combined with a high ambient temperature ( $T_A$ ), can cause  $T_J$  to be greater than or equal to  $T_{sd}$ , which triggers the thermal shutdown and causing the output to fall to 0 V. The LDO can cycle on and off when thermal shutdown is reached under these conditions.

## 7.4 Device Functional Modes

Table 3 lists a comparison between the regulation and disabled operation.

**Table 3. Device Functional Modes Comparison**

OPERATING MODE	PARAMETER				
	$V_{IN}$	$V_{BIAS}$	EN	$I_{OUT}$	$T_J$
Regulation <sup>(1)</sup>	$V_{IN} > V_{OUT(nom)} + V_{DO}$	$V_{BIAS} \geq V_{UVLO(BIAS)}$ <sup>(2)</sup>	$V_{EN} > V_{IH(EN)}$	$I_{OUT} < I_{CL}$	$T_J \leq T_{J(maximum)}$
Disabled <sup>(3)</sup>	$V_{IN} < V_{UVLO\_1,2(IN)}$	$V_{BIAS} < V_{UVLO(BIAS)}$	$V_{EN} < V_{IL(EN)}$		$T_J > T_{sd}$
Current limit operation				$I_{OUT} \geq I_{CL}$	

(1) All table conditions must be met.

(2)  $V_{BIAS}$  only required for  $V_{IN} < 1.4$  V.

(3) The device is disabled when any condition is met.

### 7.4.1 Regulation

The device regulates the output to the nominal output voltage when all the conditions in Table 3 are met.

### 7.4.2 Disabled

When disabled, the pass device is turned off, the internal circuits are shut down, and the output voltage is actively discharged to ground by an internal resistor from the output to ground. See [Active Discharge](#) for additional information.

## 8 Application and Implementation

### NOTE

Information in the following applications sections is not part of the TI component specification, and TI does not warrant its accuracy or completeness. TI's customers are responsible for determining suitability of components for their purposes. Customers should validate and test their design implementation to confirm system functionality.

### 8.1 Application Information

Successfully implementing an LDO in an application depends on the application requirements. This section discusses key device features and how to best implement them to achieve a reliable design.

#### 8.1.1 External Component Selection

##### 8.1.1.1 Adjustable Operation

The TPS7A85A can be used with the internal ANY-OUT network or by using external resistors. Using the ANY-OUT network allows the TPS7A85A to be programmed from 0.8 V to 3.95 V. For output voltage range greater than 3.95 V and up to 5.1 V, external resistors must be used. This configuration is referred to as the adjustable configuration of the TPS7A85A throughout the data sheet. The output voltage is set by two resistors, as shown in Figure 50. 0.75% accuracy can be achieved with an external BIAS for  $V_{IN}$  lower than 2.2 V.

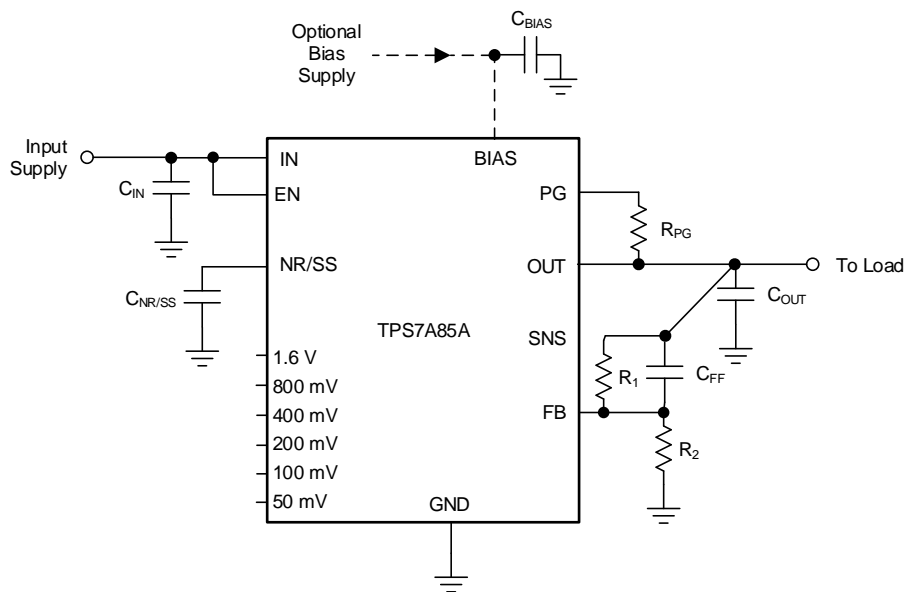

Copyright © 2017, Texas Instruments Incorporated

Figure 50. Adjustable Operation

$R_1$  and  $R_2$  can be calculated for any output voltage range using . This resistive network must provide a current equal to or greater than 5  $\mu$ A for dc accuracy. TI recommends using an  $R_1$  approximately 12 k $\Omega$  to optimize the noise and PSRR.

$$V_{OUT} = V_{NR/SS} \times (1 + R_1 / R_2) \quad (1)$$

## Application Information (continued)

Table 4 lists the resistor combinations required to achieve several common rails using standard 1%-tolerance resistors.

**Table 4. Recommended Feedback-Resistor Values<sup>(1)</sup>**

TARGETED OUTPUT VOLTAGE (V)	FEEDBACK RESISTOR VALUES		CALCULATED OUTPUT VOLTAGE (V)
	R <sub>1</sub> (kΩ)	R <sub>2</sub> (kΩ)	
0.9	12.4	100	0.899
0.95	12.4	66.5	0.949
1	12.4	49.9	0.999
1.1	12.4	33.2	1.099
1.2	12.4	24.9	1.198
1.5	12.4	14.3	1.494
1.8	12.4	10	1.798
1.9	12.1	8.87	1.89
2.5	12.4	5.9	2.48
2.85	12.1	4.75	2.838
3	12.1	4.42	2.990
3.3	11.8	3.74	3.324
3.6	12.1	3.48	3.582
4.5	11.8	2.55	4.502
5	12.4	2.37	4.985

(1) R<sub>1</sub> is connected from OUT to FB; R<sub>2</sub> is connected from FB to GND.

### 8.1.1.2 ANY-OUT Programmable Output Voltage

The TPS7A85A can use external resistors or the internally-matched ANY-OUT feedback resistor network to set output voltage. The ANY-OUT resistors are accessible through pin 2 and pins 5 to 11 and program the regulated output voltage. Each pin can be connected to ground (active), left open (floating), or connected to SNS. ANY-OUT programming is set by as the sum of the internal reference voltage ( $V_{NR/SS} = 0.8\text{ V}$ ) plus the accumulated sum of the respective voltages assigned to each active pin; that is, 50mV (pin 5), 100mV (pin 6), 200mV (pin 7), 400mV (pin 9), 800mV (pin 10), or 1.6V (pin 11). Table 5 lists the voltage values associated with each active pin setting for reference. By leaving all program pins open or floating, the output is programmed to the minimum possible output voltage equal to  $V_{FB}$ .

$$V_{OUT} = V_{NR/SS} + (\sum \text{ANY-OUT Pins to Ground}) \quad (2)$$

**Table 5. ANY-OUT Programmable Output Voltage (RGR Package)**

ANY-OUT PROGRAM PINS (ACTIVE LOW)	ADDITIVE OUTPUT VOLTAGE LEVEL
Pin 5 (50mV)	50 mV
Pin 6 (100mV)	100 mV
Pin 7 (200mV)	200 mV
Pin 9 (400mV)	400 mV
Pin 10 (800mV)	800 mV
Pin 11 (1.6V)	1.6 V

Table 6 lists target output voltages and corresponding pin settings when the ANY-OUT pins are only tied to ground or left floating. The voltage setting pins have a binary weight, so the output voltage can be programmed to any value from 0.8 V to 3.95 V in 50-mV steps when tying these pins to ground. There are several alternative ways to set the output voltage. The program pins can be driven using external general-purpose input or output pins (GPIOs), manually connected using 0-Ω resistors (or left open), or hardwired by the given layout of the printed circuit board (PCB) to set the ANY-OUT voltage. As with the adjustable operation, the output voltage is set according to except that R<sub>1</sub> and R<sub>2</sub> are internally integrated and matched for higher accuracy. Tying any of the ANY-OUT pins to SNS can increase the resolution of the internal feedback network by decreasing the value of R<sub>1</sub>. See [Increasing ANY-OUT Resolution for LILO Conditions](#) for additional information.

$$V_{OUT} = V_{NR/SS} \times (1 + R_1 / R_2) \quad (3)$$

---

**NOTE**

For output voltages greater than 3.95 V, use a traditional adjustable configuration (see [Adjustable Operation](#)).

---

**Table 6. User-Configurable Output Voltage Settings**

V <sub>OUT(NOM)</sub> (V)	50 mV	100 mV	200 mV	400 mV	800 mV	1.6 V	V <sub>OUT(NOM)</sub> (V)	50 mV	100 mV	200 mV	400 mV	800 mV	1.6 V
0.8	Open	Open	Open	Open	Open	Open	2.4	Open	Open	Open	Open	Open	GND
0.85	GND	Open	Open	Open	Open	Open	2.45	GND	Open	Open	Open	Open	GND
0.9	Open	GND	Open	Open	Open	Open	2.5	Open	GND	Open	Open	Open	GND
0.95	GND	GND	Open	Open	Open	Open	2.55	GND	GND	Open	Open	Open	GND
1	Open	Open	GND	Open	Open	Open	2.6	Open	Open	GND	Open	Open	GND
1.05	GND	Open	GND	Open	Open	Open	2.65	GND	Open	GND	Open	Open	GND
1.1	Open	GND	GND	Open	Open	Open	2.7	Open	GND	GND	Open	Open	GND
1.15	GND	GND	GND	Open	Open	Open	2.75	GND	GND	GND	Open	Open	GND
1.2	Open	Open	Open	GND	Open	Open	2.8	Open	Open	Open	GND	Open	GND
1.25	GND	Open	Open	GND	Open	Open	2.85	GND	Open	Open	GND	Open	GND
1.3	Open	GND	Open	GND	Open	Open	2.9	Open	GND	Open	GND	Open	GND
1.35	GND	GND	Open	GND	Open	Open	2.95	GND	GND	Open	GND	Open	GND
1.4	Open	Open	GND	GND	Open	Open	3	Open	Open	GND	GND	Open	GND
1.45	GND	Open	GND	GND	Open	Open	3.05	GND	Open	GND	GND	Open	GND
1.5	Open	GND	GND	GND	Open	Open	3.1	Open	GND	GND	GND	Open	GND
1.55	GND	GND	GND	GND	Open	Open	3.15	GND	GND	GND	GND	Open	GND
1.6	Open	Open	Open	Open	GND	Open	3.2	Open	Open	Open	Open	GND	GND
1.65	GND	Open	Open	Open	GND	Open	3.25	GND	Open	Open	Open	GND	GND
1.7	Open	GND	Open	Open	GND	Open	3.3	Open	GND	Open	Open	GND	GND
1.75	GND	GND	Open	Open	GND	Open	3.35	GND	GND	Open	Open	GND	GND
1.8	Open	Open	GND	Open	GND	Open	3.4	Open	Open	GND	Open	GND	GND
1.85	GND	Open	GND	Open	GND	Open	3.45	GND	Open	GND	Open	GND	GND
1.9	Open	GND	GND	Open	GND	Open	3.5	Open	GND	GND	Open	GND	GND
1.95	GND	GND	GND	Open	GND	Open	3.55	GND	GND	GND	Open	GND	GND
2	Open	Open	Open	GND	GND	Open	3.6	Open	Open	Open	GND	GND	GND
2.05	GND	Open	Open	GND	GND	Open	3.65	GND	Open	Open	GND	GND	GND
2.10	Open	GND	Open	GND	GND	Open	3.7	Open	GND	Open	GND	GND	GND
2.15	GND	GND	Open	GND	GND	Open	3.75	GND	GND	Open	GND	GND	GND
2.2	Open	Open	GND	GND	GND	Open	3.8	Open	Open	GND	GND	GND	GND
2.25	GND	Open	GND	GND	GND	Open	3.85	GND	Open	GND	GND	GND	GND
2.3	Open	GND	GND	GND	GND	Open	3.9	Open	GND	GND	GND	GND	GND
2.35	GND	GND	GND	GND	GND	Open	3.95	GND	GND	GND	GND	GND	GND

### 8.1.1.3 ANY-OUT Operation

Considering the use of the ANY-OUT internal network where the unit resistance of 1R, as shown in ( ) is equal to 6.05 kΩ, the output voltage is set by grounding the appropriate control pins as shown in Figure 51. When grounded, all control pins add a specific voltage on top of the internal reference voltage ( $V_{NR/SS} = 0.8\text{ V}$ ). The output voltage can be calculated by and . Figure 51 and Figure 52 show a 0.9-V output voltage (respectively) that show an example of the circuit usage with and without bias voltage.

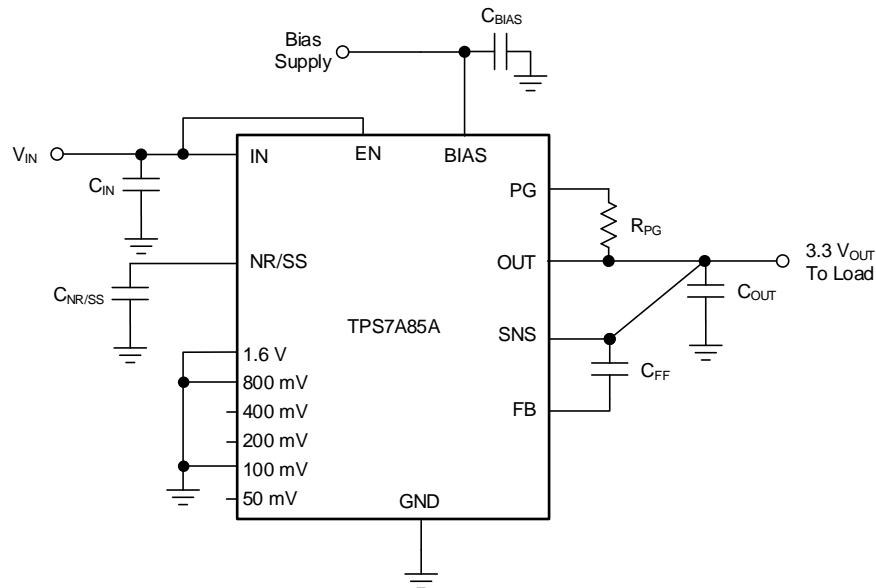

Copyright © 2017, Texas Instruments Incorporated

**Figure 51. ANY-OUT Configuration Circuit (3.3-V Output, No External Bias)**

$$V_{OUT(nom)} = V_{NR/SS} + 1.6\text{ V} + 0.8\text{ V} + 0.1\text{ V} = 0.8\text{ V} + 1.6\text{ V} + 0.8\text{ V} + 0.1\text{ V} = 3.3\text{ V} \quad (4)$$

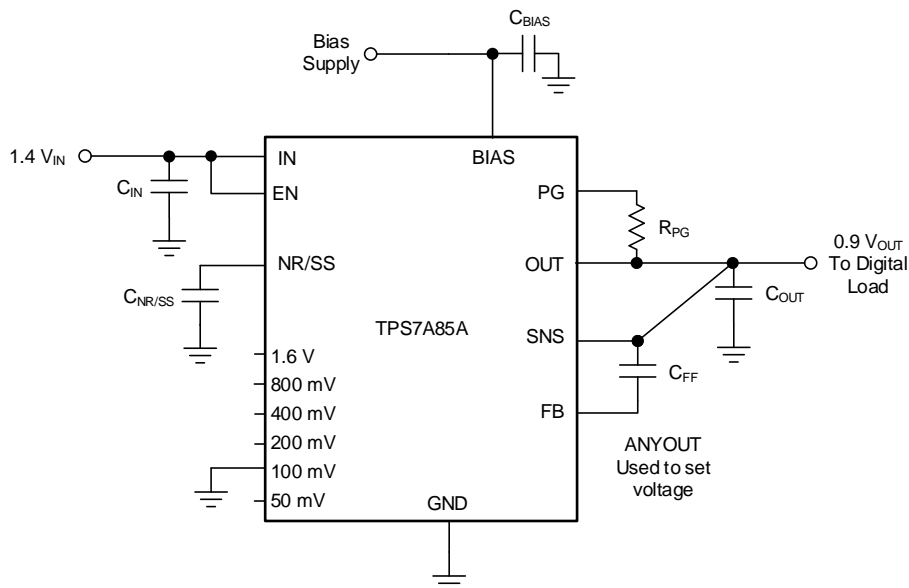

Copyright © 2017, Texas Instruments Incorporated

**Figure 52. ANY-OUT Configuration Circuit (0.9-V Output with Bias)**



$$V_{OUT(nom)} = V_{NR/SS} + 0.1\text{ V} = 0.8\text{ V} + 0.1\text{ V} = 0.9\text{ V} \quad (5)$$

#### 8.1.1.4 Increasing ANY-OUT Resolution for LILO Conditions

As with the adjustable operation, the output voltage is set according to [Equation 5](#). However,  $R_1$  and  $R_2$  are internally integrated and matched for higher accuracy. Tying any of the ANY-OUT pins to SNS can increase the resolution of the internal feedback network by decreasing the value of  $R_1$ . One of the more useful pin combinations is to tie the 800mV pin to SNS, which reduces the resolution by 50% to 25 mV but limits the range. The new ANY-OUT ranges are 0.8 V to 1.175 V and 1.6 V to 1.975 V. [Table 7](#) lists the new additive output voltage levels.

**Table 7. ANY-OUT Programmable Output Voltage With 800 mV Tied to SNS (RGR Package)**

ANY-OUT PROGRAM PINS (ACTIVE LOW)	ADDITIVE OUTPUT VOLTAGE LEVEL
Pin 5 (50mV)	25 mV
Pin 6 (100mV)	50 mV
Pin 7 (200mV)	100 mV
Pin 9 (400mV)	200 mV
Pin 11 (1.6V)	800 V

#### 8.1.1.5 Current Sharing

Current sharing is possible through the use of external operational amplifiers. For more details, see [6A Current-Sharing Dual LDO](#).

#### 8.1.1.6 Recommended Capacitor Types

The TPS7A85A is designed to be stable using low equivalent series resistance (ESR) ceramic capacitors at the input, output, and noise-reduction pin (NR/SS). Multilayer ceramic capacitors are the industry standard for these types of applications and are recommended, but must be used with good judgment. Ceramic capacitors that use X7R-, X5R-, and COG-rated dielectric materials provide relatively good capacitive stability across temperature, whereas the use of Y5V-rated capacitors is not recommended because of large variations in capacitance.

Regardless of the ceramic capacitor type selected, ceramic capacitance varies with operating voltage and temperature; derate ceramic capacitors by at least 50%. The input and output capacitors recommended herein account for a capacitance derating of approximately 50%, but at high  $V_{IN}$  and  $V_{OUT}$  conditions (for example,  $V_{IN} = 5.6\text{ V}$  to  $V_{OUT} = 5.1\text{ V}$ ) the derating can be greater than 50% and must be taken into consideration.

#### 8.1.1.7 Input and Output Capacitor Requirements ( $C_{IN}$ and $C_{OUT}$ )

The TPS7A85A is designed and characterized for operation with ceramic capacitors of 47  $\mu\text{F}$  or greater (22  $\mu\text{F}$  or greater of capacitance) at the output and 10  $\mu\text{F}$  or greater (5  $\mu\text{F}$  or greater of capacitance) at the input. TI recommends using a capacitor with a value of at least 47  $\mu\text{F}$  at the input to minimize input impedance. Place the input and output capacitors as close as possible to the respective input and output pins to minimize trace parasitic. If the trace inductance from the input supply to the TPS7A85A is high, a fast current transient can cause  $V_{IN}$  to ring above the absolute maximum voltage rating and damage the device. This situation can be mitigated by additional input capacitors to dampen the ringing and to keep it below the device absolute maximum ratings.

A combination of multiple output capacitors boosts the high-frequency PSRR as shown in several of the PSRR curves. The combination of one 0805-sized, 47- $\mu\text{F}$  ceramic capacitor in parallel with two 0805-sized, 10- $\mu\text{F}$  ceramic capacitors with a sufficient voltage rating in conjunction with the PSRR boost circuit optimizes PSRR for the frequency range of 400 kHz to 700 kHz, a typical range for dc-dc supply switching frequency. This 47- $\mu\text{F}$  || 10- $\mu\text{F}$  || 10- $\mu\text{F}$  combination also ensures that at high input voltage and high output voltage configurations, the minimum effective capacitance is met. Many 0805-sized, 47- $\mu\text{F}$  ceramic capacitors have a voltage derating of approximately 60% to 80% at 5.15 V, so the addition of the two 10- $\mu\text{F}$  capacitors ensures that the capacitance is at or above 25  $\mu\text{F}$ .

### 8.1.1.8 Feed-Forward Capacitor ( $C_{FF}$ )

Although a feed-forward capacitor ( $C_{FF}$ ) from the FB pin to the OUT pin is not required to achieve stability, a 10-nF external feed-forward capacitor optimizes the transient, noise, and PSRR performance. A higher capacitance  $C_{FF}$  can be used; however, the start-up time is longer, and the PG signal can incorrectly indicate that the output voltage is settled. For a detailed description, see [Pros and Cons of Using a Feed-Forward Capacitor with a Low Dropout Regulator](#).

### 8.1.1.9 Noise-Reduction and Soft-Start Capacitor ( $C_{NR/SS}$ )

The TPS7A85A features a programmable, monotonic, voltage-controlled soft-start that is set with an external capacitor ( $C_{NR/SS}$ ). The use of an external  $C_{NR/SS}$  is highly recommended, especially to minimize inrush current into the output capacitors. This soft-start eliminates power-up initialization problems when powering field-programmable gate arrays (FPGAs), digital signal processors (DSPs), or other processors. The controlled voltage ramp of the output reduces peak inrush current during start-up, which minimizes start-up transients to the input power bus.

To achieve a monotonic start-up, the TPS7A85A error amplifier tracks the voltage ramp of the external soft-start capacitor until the voltage approaches the internal reference. The soft-start ramp time depends on the soft-start charging current ( $I_{NR/SS}$ ), the soft-start capacitance ( $C_{NR/SS}$ ), and the internal reference ( $V_{NR/SS}$ ). Soft-start ramp time can be calculated with [Equation 6](#):

$$t_{SS} = (V_{NR/SS} \times C_{NR/SS}) / I_{NR/SS} \quad (6)$$

$I_{NR/SS}$  is shown in [Electrical Characteristics](#).

The noise-reduction capacitor (in conjunction with the noise-reduction resistor) forms a low-pass filter (LPF) that minimizes the noise from the reference. The reference and noise are amplified by the error amplifier and so the  $C_{NR/SS}$  reduces the overall noise floor. The LPF is a single-pole filter and the cutoff frequency can be calculated with [Equation 7](#). The typical value of  $R_{NR/SS}$  is 250 k $\Omega$ . Increasing the  $C_{NR/SS}$  capacitor has a dominant effect on the output noise at higher output voltages because of the larger gain that is present on the error amplifier. For low-noise applications, TI recommends using a 10-nF to 1- $\mu$ F  $C_{NR/SS}$ . A larger  $C_{NR/SS}$  has a higher leakage current and as a result, the start-up time may be higher than the expected soft-start time calculated with [Equation 6](#).

$$f_{cutoff} = 1 / (2 \times \pi \times R_{NR/SS} \times C_{NR/SS}) \quad (7)$$

## 8.1.2 Start-Up

### 8.1.2.1 Circuit Soft-Start Control (NR/SS)

Each output of the device features a user-adjustable, monotonic, voltage-controlled soft-start that is set with an external capacitor ( $C_{NR/SS}$ ). This soft-start eliminates power-up initialization problems when powering field-programmable gate arrays (FPGAs), digital signal processors (DSPs), or other processors. The controlled voltage ramp of the output reduces peak inrush current during start-up, which minimizes start-up transients to the input power bus.

The output voltage ( $V_{OUT}$ ) rises proportionally to  $V_{NR/SS}$  during start-up as the LDO regulates so that the feedback voltage equals the NR/SS voltage ( $V_{FB} = V_{NR/SS}$ ). The time required for  $V_{NR/SS}$  to reach the nominal value determines the rise time of  $V_{OUT}$  (start-up time).

Not using a noise-reduction capacitor on the NR/SS pin may result in an output voltage overshoot of approximately 10%. Using a capacitor on the NR/SS pin minimizes the overshoot.

lists the soft-start charging current values.

#### 8.1.2.1.1 Inrush Current

Inrush current is defined as the current into the LDO at the IN pin during start-up. Inrush current consists of the sum of load current and the current that charges the output capacitor. This current is difficult to measure because the input capacitor must be removed, which is not recommended. This soft-start current can be estimated by [Equation 8](#):

$$I_{OUT}(t) = \left( \frac{C_{OUT} \times dV_{OUT}(t)}{dt} \right) + \left( \frac{V_{OUT}(t)}{R_{LOAD}} \right)$$

where:

- $V_{OUT}(t)$  is the instantaneous output voltage of the turnon ramp
  - $dV_{OUT}(t) / dt$  is the slope of the  $V_{OUT}$  ramp
  - $R_{LOAD}$  is the resistive load impedance
- (8)

### 8.1.2.2 Undervoltage Lockout (UVLO)

The UVLO circuits ensure that the device stays disabled before the input or bias supplies reach the minimum operational voltage range, and ensures that the device properly shuts down when the input or bias supply collapses.

Figure 53 and Table 8 show one of the UVLO circuits triggered by various input voltage events, assuming that  $V_{EN} \geq V_{IH(EN)}$ .

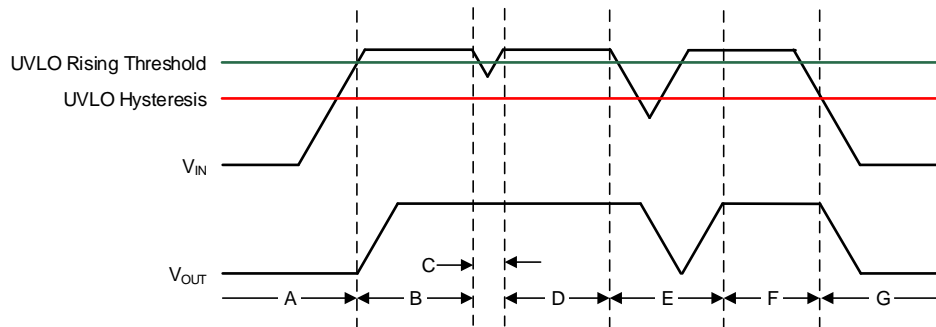

Figure 53. Typical UVLO Operation

Table 8. Typical UVLO Operation Description

REGION	EVENT	$V_{OUT}$ STATUS	COMMENT
A	Turnon, $V_{IN} \geq V_{UVLO\_1, 2(IN)}$ and $V_{BIAS} \geq V_{UVLO(BIAS)}$	Off	Start-up
B	Regulation	On	Regulates to target $V_{OUT}$
C	Brownout, $V_{IN} \geq V_{UVLO\_1, 2(IN)} - V_{HYS\_1, 2(IN)}$ or $V_{BIAS} \geq V_{UVLO(BIAS)} - V_{HYS(BIAS)}$	On	The output can fall out of regulation but the device is still enabled.
D	Regulation	On	Regulates to target $V_{OUT}$
E	Brownout, $V_{IN} < V_{UVLO\_1, 2(IN)} - V_{HYS\_1, 2(IN)}$ or $V_{BIAS} < V_{UVLO(BIAS)} - V_{HYS(BIAS)}$	Off	The device is disabled and the output falls because of the load and active discharge circuit. The device is reenabled when the UVLO fault is removed when either the IN or BIAS UVLO rising threshold is reached by the input or bias voltage and a normal start-up then follows.
F	Regulation	On	Regulates to target $V_{OUT}$
G	Turnoff, $V_{IN} < V_{UVLO\_1, 2(IN)} - V_{HYS\_1, 2(IN)}$ or $V_{BIAS} < V_{UVLO(BIAS)} - V_{HYS(BIAS)}$	Off	The output falls because of the load and active discharge circuit.

Similar to many other LDOs with this feature, the UVLO circuits take a few microseconds to fully assert. During this time, a downward line transient below approximately 0.8 V causes the UVLO to assert for a short time; however, the UVLO circuits do not have enough stored energy to fully discharge the internal circuits inside of the device. When the UVLO circuits are not given enough time to fully discharge the internal nodes, the outputs are not fully disabled.

The effect of the downward line transient can be mitigated by using a larger input capacitor to increase the fall time of the input supply when operating near the minimum  $V_{IN}$ .

### 8.1.2.3 Power-Good (PG) Function

The PG circuit monitors the voltage at the feedback pin to indicate the status of the output voltage. The PG circuit asserts whenever FB,  $V_{IN}$ , or EN are below the thresholds. The PG operation versus the output voltage is shown in Figure 54, which is listed in Table 9.

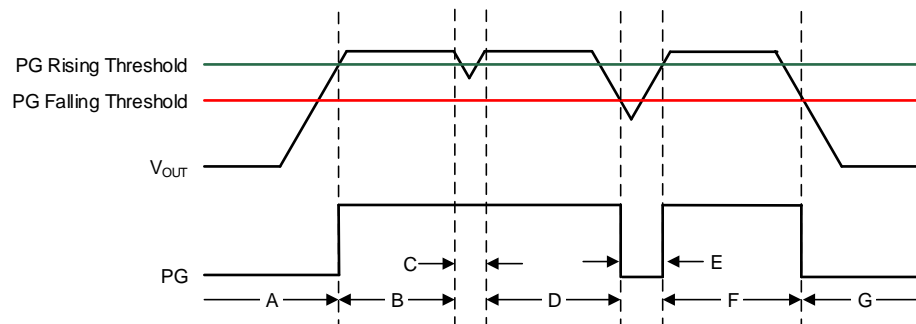

**Figure 54. Typical PG Operation**

**Table 9. Typical PG Operation Description**

REGION	EVENT	PG STATUS	FB VOLTAGE
A	Turnon	0	$V_{FB} < V_{IT(PG)} + V_{HYS(PG)}$
B	Regulation	Hi-Z	$V_{FB} \geq V_{IT(PG)}$
C	Output voltage dip	Hi-Z	
D	Regulation	Hi-Z	
E	Output voltage dip	0	$V_{FB} < V_{IT(PG)}$
F	Regulation	Hi-Z	$V_{FB} \geq V_{IT(PG)}$
G	Turnoff	0	$V_{FB} < V_{IT(PG)}$

The PG pin is open-drain and connects a pullup resistor to an external supply, enabling other devices to receive power good as a logic signal that can be used for sequencing. Take care to ensure that the external pullup supply voltage results in a valid logic signal for the receiving device or devices.

To ensure proper operation of the PG circuit, the pullup resistor value must be from 10 k $\Omega$  and 100 k $\Omega$ . The lower limit of 10 k $\Omega$  results from the maximum pulldown strength of the PG transistor, and the upper limit of 100 k $\Omega$  results from the maximum leakage current at the PG node. If the pullup resistor is outside of this range, then the PG signal may not read a valid digital logic level.

Using a large  $C_{FF}$  with a small  $C_{NR/SS}$  causes the PG signal to incorrectly indicate that the output voltage has settled during turnon. The  $C_{FF}$  time constant must be greater than the soft-start time constant to ensure proper operation of the PG during start-up. For a detailed description, see [Pros and Cons of Using a Feed-Forward Capacitor with a Low Dropout Regulator](#).

The state of PG is only valid when the device operates above the minimum supply voltage. During short brownout events and at light loads, PG does not assert because the output voltage (and as a result,  $V_{FB}$ ) is sustained by the output capacitance.

### 8.1.3 AC and Transient Performance

LDO ac performance includes power-supply-rejection ratio, output-current transient response, and output noise. These metrics are primarily a function of open-loop gain, bandwidth, and phase margin that control the closed-loop input and output impedance of the LDO. The output noise is primarily a result of the reference and error amplifier noise.

### 8.1.3.1 Power-Supply Rejection Ratio (PSRR)

PSRR is a measure of how well the LDO control loop rejects signals from  $V_{IN}$  to  $V_{OUT}$  across the frequency spectrum (usually 10 Hz to 10 MHz). Equation 9 gives the PSRR calculation as a function of frequency for the input signal ( $V_{IN}(f)$ ) and output signal ( $V_{OUT}(f)$ ).

$$PSRR(dB) = 20\text{Log}_{10}\left(\frac{V_{IN}(f)}{V_{OUT}(f)}\right) \tag{9}$$

Although PSRR is a loss in signal amplitude, PSRR is shown as positive values in decibels (dB) for convenience. A simplified diagram of PSRR versus frequency is shown in Figure 55.

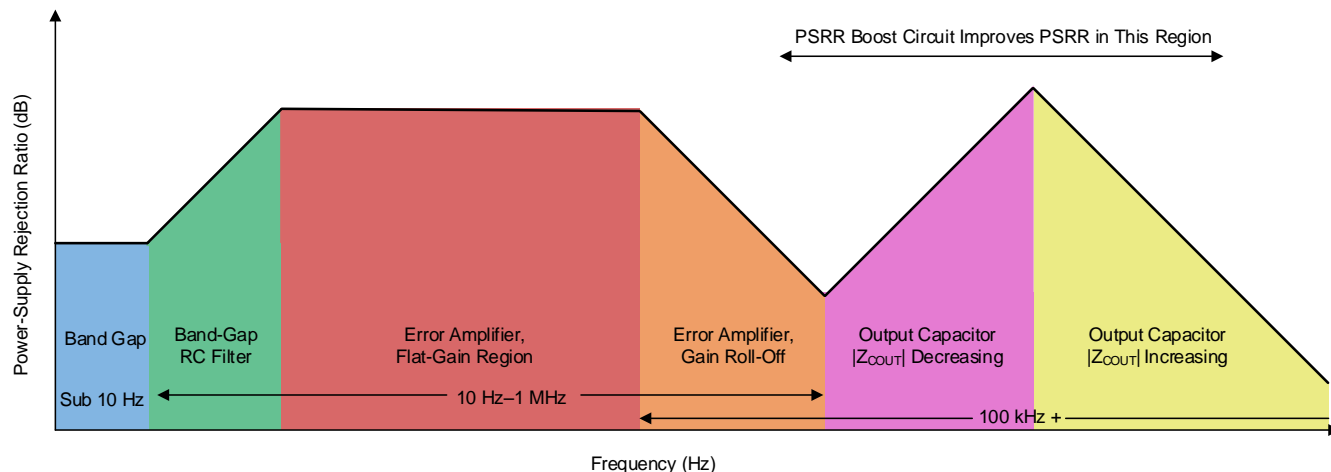

Figure 55. Power-Supply Rejection Ratio Diagram

An LDO is often employed not only as a dc-dc regulator, but provides exceptionally clean power-supply voltages that exhibit ultra-low noise and ripple to sensitive system components. This usage is especially true for the TPS7A85A.

The TPS7A85A features an innovative circuit to boost the PSRR from 200 kHz to 1 MHz; see . To achieve the maximum benefit of this PSRR boost circuit, TI recommends using a capacitor with a minimum impedance in the 100-kHz to 1-MHz band.

### 8.1.3.2 Output Voltage Noise

The TPS7A85A is designed for system applications where minimizing noise on the power-supply rail is critical to system performance. For example, the TPS7A85A can be used in a phase-locked loop (PLL)-based clocking circuit can be used for minimum phase noise, or in test and measurement systems where small power-supply noise fluctuations reduce system dynamic range.

LDO noise is defined as the internally-generated intrinsic noise created by the semiconductor circuits alone. This noise is the sum of various types of noise (such as shot noise associated with current-through-pin junctions, thermal noise caused by thermal agitation of charge carriers, flicker noise, or 1/f noise and dominates at lower frequencies as a function of 1/f). [Figure 56](#) shows a simplified output voltage noise density plot versus frequency.

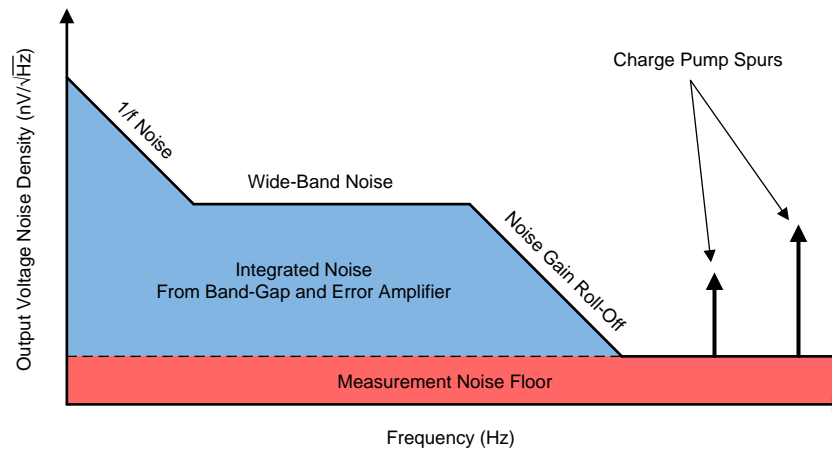

Figure 56. Output Voltage Noise Diagram

For further details, see the [How to Measure LDO Noise](#) white paper.

### 8.1.3.3 Optimizing Noise and PSRR

The ultra-low noise floor and PSRR of the device can be improved in several ways, as listed in [Table 10](#).

Table 10. Effect of Various Parameters on AC Performance<sup>(1)(2)</sup>

PARAMETER	NOISE			PSRR		
	LOW-FREQUENCY	MID-FREQUENCY	HIGH-FREQUENCY	LOW-FREQUENCY	MID-FREQUENCY	HIGH-FREQUENCY
C <sub>NR/SS</sub>	+++	No effect	No effect	+++	+	No effect
C <sub>FF</sub>	++	+++	+	++	+++	+
C <sub>OUT</sub>	No effect	+	+++	No effect	+	+++
V <sub>IN</sub> – V <sub>OUT</sub>	+	+	+	+++	+++	++
PCB layout	++	++	+	+	+++	+++

(1) The number of + symbols indicate the improvement in noise or PSRR performance by increasing the parameter value.  
 (2) Shaded cells indicate the simplest improvement to noise or PSRR performance.

The noise-reduction capacitor (in conjunction with the noise-reduction resistor) forms a low-pass filter (LPF) that filters out the noise from the reference before being gained up with the error amplifier, which minimizes the output voltage noise floor. The LPF is a single-pole filter, and the cutoff frequency can be calculated with [Equation 10](#). The typical value of R<sub>NR/SS</sub> is 250 kΩ. The effect of the C<sub>NR/SS</sub> capacitor increases when V<sub>OUT(nom)</sub> increases because the noise from the reference is gained up when the output voltage increases. For low-noise applications, TI recommends a 10-nF to 10-μF C<sub>NR/SS</sub>.

$$f_{\text{cutoff}} = 1 / (2 \times \pi \times R_{\text{NR/SS}} \times C_{\text{NR/SS}}) \tag{10}$$

The feed-forward capacitor reduces output voltage noise by filtering out the mid-band frequency noise. The feed-forward capacitor can be optimized by placing a pole-zero pair near the edge of the loop bandwidth and pushing out the loop bandwidth, which improves mid-band PSRR.

A larger  $C_{OUT}$  or multiple output capacitors reduces high-frequency output voltage noise and PSRR by reducing the high-frequency output impedance of the power supply.

Additionally, a higher input voltage improves the noise and PSRR because greater headroom is provided for the internal circuits. However, a high power dissipation across the die increases the output noise because of the increase in junction temperature.

Good PCB layout improves the PSRR and noise performance by providing heat sinking at low frequencies and isolating  $V_{OUT}$  at high frequencies.

Table 11 lists the output voltage noise for the 10-Hz to 100-kHz band at a 5-V output for a variety of conditions with an input voltage of 5.5 V and a load current of 4 A. The 5-V output is selected as a worst-case nominal operation for output voltage noise.

**Table 11. Output Noise Voltage at a 5-V Output**

OUTPUT VOLTAGE NOISE ( $\mu V_{RMS}$ )	$C_{NR/SS}$ (nF)	$C_{FF}$ (nF)	$C_{OUT}$ ( $\mu F$ )
11.7	10	10	47    10    10
7.7	100	10	47    10    10
6	100	100	47    10    10
7.4	100	10	1000
5.8	100	100	1000

### 8.1.3.3.1 Charge Pump Noise

The device internal charge pump generates a minimal amount of noise, as shown in Figure 57.

Using a bias rail minimizes the internal charge-pump noise when the internal voltage is clamped, which reduces the overall output noise floor.

The high-frequency components of the output voltage noise density curve are filtered out in most applications by using 10-nF to 100-nF bypass capacitors close to the load. Using a ferrite bead between the LDO output and the load input capacitors forms a pi-filter, which further reduces the high-frequency noise contribution.

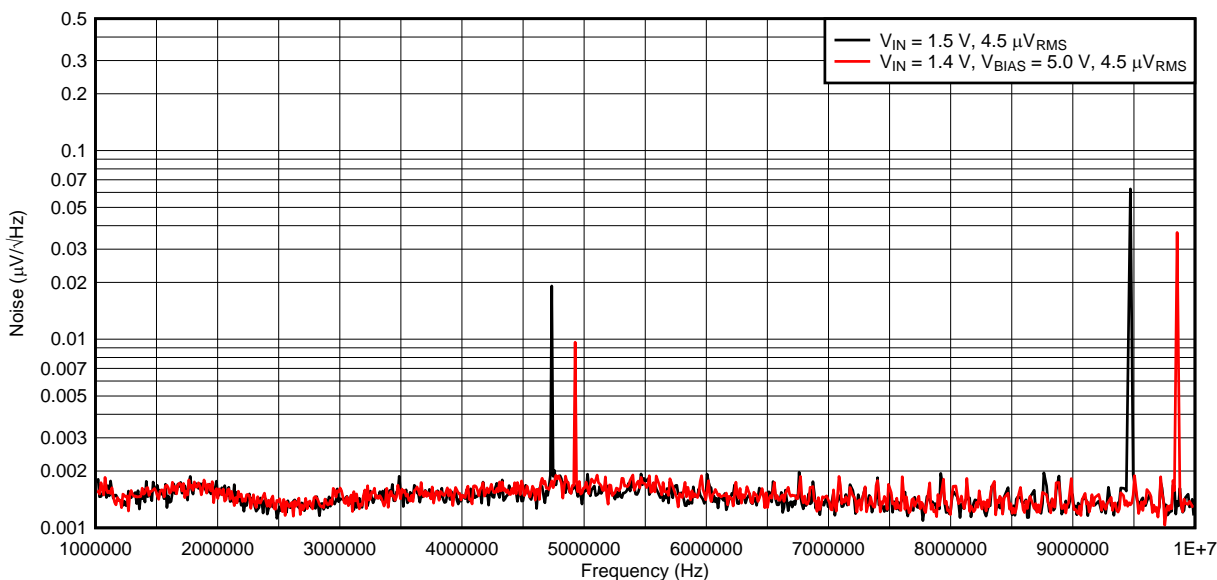

**Figure 57. Charge Pump Noise**

### 8.1.3.4 Load Transient Response

The load-step transient response is the output voltage response by the LDO to a step in load current, where output voltage regulation is maintained. There are two key transitions during a load transient response: the transition from a light to a heavy load and the transition from a heavy to a light load. The regions shown in [Figure 58](#) are further described in this section and are listed in [Table 12](#). Regions A, E, and H are where the output voltage is in steady-state.

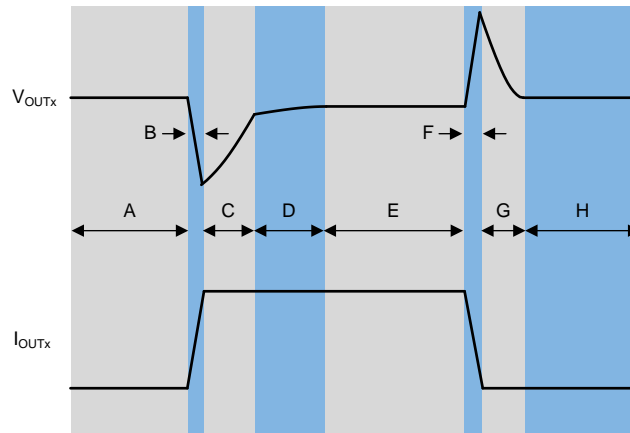

**Figure 58. Load Transient Waveform**

**Table 12. Load Transient Waveform Description**

REGION	DESCRIPTION	COMMENT
A	Regulation	Regulation
B	Output current ramping	Initial voltage dip is a result of the depletion of the output capacitor charge.
C	LDO responding to transient	Recovery from the dip results from the LDO increasing its sourcing current, and leads to output voltage regulation.
D	Reaching thermal equilibrium	At high load currents the LDO takes some time to heat up. During this time the output voltage changes slightly.
E	Regulation	Regulation
F	Output current ramping	Initial voltage rise results from the LDO sourcing a large current, and leads to the output capacitor charge to increase.
G	LDO responding to transient	Recovery from the rise results from the LDO decreasing its sourcing current in combination with the load discharging the output capacitor.
H	Regulation	Regulation



The transient response peaks ( $V_{OUT(max)}$  and  $V_{OUT(min)}$ ) are improved by using more output capacitance; however, using more output capacitance slows down the recovery time ( $W_{rise}$  and  $W_{fall}$ ). Figure 59 shows these parameters during a load transient with a given pulse duration (PW) and current levels ( $I_{OUT(LO)}$  and  $I_{OUT(HI)}$ ).

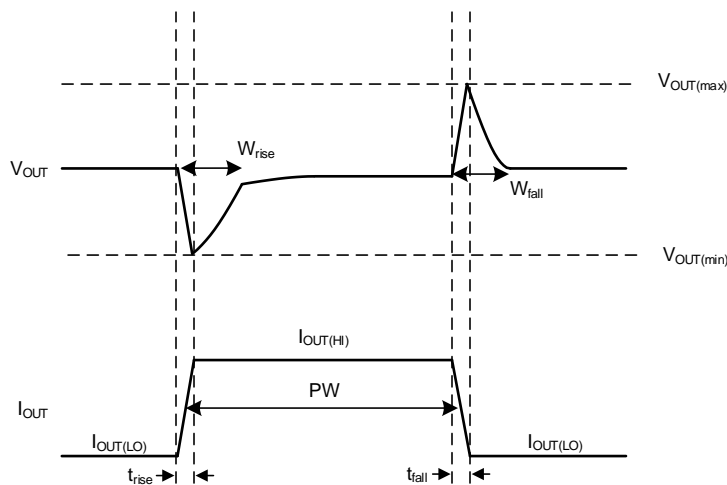

Figure 59. Simplified Load Transient Waveform

## 8.1.4 DC Performance

### 8.1.4.1 Output Voltage Accuracy ( $V_{OUT}$ )

The device features an output voltage accuracy of 0.75% maximum with BIAS that includes the errors introduced by the internal reference, load regulation, line regulation, and operating temperature as shown in the . Output voltage accuracy specifies minimum and maximum output voltage error relative to the expected nominal output voltage stated as a percent.

### 8.1.4.2 Dropout Voltage ( $V_{DO}$ )

Generally, the dropout voltage refers to the minimum voltage difference between the input and output voltage ( $V_{DO} = V_{IN} - V_{OUT}$ ) that is required for regulation. When  $V_{IN}$  drops below the required  $V_{DO}$  for the given load current, the device functions as a resistive switch and does not regulate output voltage. Dropout voltage is proportional to the output current because the device is operating as a resistive switch, as shown in Figure 60.

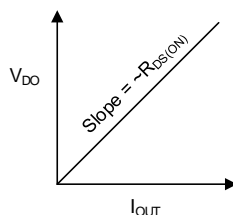

Figure 60. Dropout Voltage versus Output Current

Dropout voltage is affected by the drive strength for the gate of the pass element, which is nonlinear with respect to  $V_{IN}$  on this device because of the internal charge pump. Dropout voltage increases exponentially when the input voltage approaches the maximum operating voltage.

### 8.1.4.2.1 Behavior When Transitioning From Dropout Into Regulation

Some applications can have transients that place the LDO into dropout, such as slower ramps on  $V_{IN}$  for start-up or load transients. As with many other LDOs, the output can overshoot on recovery from these conditions.

A ramping input supply can cause an LDO to overshoot on start-up when the slew rate and voltage levels are in the right range, as shown in Figure 61. This condition is simply avoided by using an enable signal or by increasing the soft-start time with  $C_{SS/NR}$ .

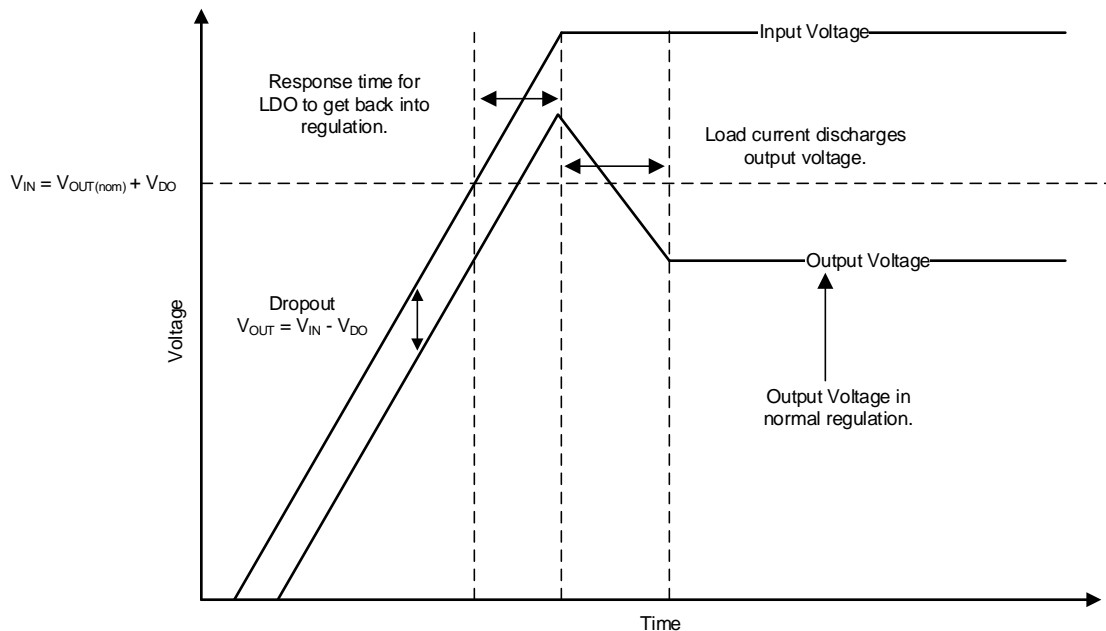

**Figure 61. Start-Up Into Dropout**

### 8.1.5 Sequencing Requirements

There is no sequencing requirement between the BIAS, IN, and EN pins in the TPS7A85A.

### 8.1.6 Negatively Biased Output

The TPS7A85A output can be negatively biased to the absolute maximum rating without effecting start-up condition.

### 8.1.7 Reverse Current

As with most LDOs, excessive reverse current can damage this device.

Reverse current is current that flows through the body diode on the pass element instead of the normal conducting channel. This current flow, at high enough magnitudes, degrades long-term reliability of the device resulting from risks of electromigration and excess heat being dissipated across the device. If the current flow gets high enough, a latch-up condition can be entered.

This section outlines conditions where excessive current can occur, all of which can exceed the absolute maximum rating of  $V_{OUT} > V_{IN} + 0.3\text{ V}$ :

- If the device has a large  $C_{OUT}$  and the input supply collapses quickly with little or no load current,
- The output is biased when the input supply is not established, or
- The output is biased above the input supply.

If excessive reverse current flow is expected in the application, then external protection must be used to protect the device. Figure 62 shows one approach of protecting the device.

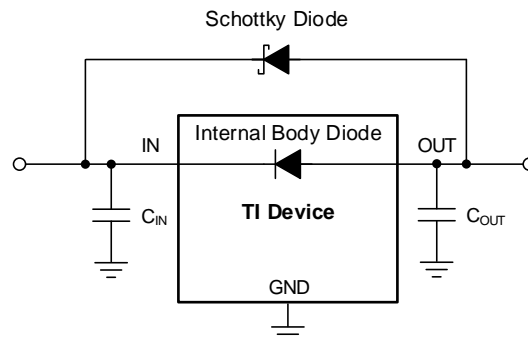

Copyright © 2016, Texas Instruments Incorporated

**Figure 62. Example Circuit for Reverse Current Protection Using a Schottky Diode**

### 8.1.8 Power Dissipation ( $P_D$ )

Circuit reliability demands that proper consideration is given to device power dissipation, location of the circuit on the printed circuit board (PCB), and correct sizing of the thermal plane. The PCB area around the regulator must be as free as possible of other heat-generating devices that cause added thermal stresses.

As a first-order approximation, power dissipation in the regulator depends on the input-to-output voltage difference and load conditions.  $P_D$  can be approximated using [Equation 11](#):

$$P_D = (V_{IN} - V_{OUT}) \times I_{OUT} \quad (11)$$

Power dissipation can be minimized, and thus greater efficiency achieved, by proper selection of the system voltage rails. The minimum input to output voltage differential is obtained by properly selecting the system voltage rails. The low dropout of the device allows for maximum efficiency across a wide range of output voltages.

The main heat conduction path for the device is through the thermal pad on the package. As a result, the thermal pad must be soldered to a copper pad area under the device. This pad area contains an array of plated vias that conduct heat to any inner plane areas or to a bottom-side copper plane.

The maximum power dissipation determines the maximum allowable junction temperature ( $T_J$ ) for the device. Power dissipation and junction temperature are most often related by the junction-to-ambient thermal resistance ( $R_{\theta JA}$ ) of the combined PCB, device package, and the temperature of the ambient air ( $T_A$ ), according to [Equation 12](#). The equation is rearranged for output current in [Equation 13](#).

$$T_J = T_A + R_{\theta JA} \times P_D \quad (12)$$

$$I_{OUT} = (T_J - T_A) / R_{\theta JA} \times (V_{IN} - V_{OUT}) \quad (13)$$

Unfortunately, this thermal resistance ( $R_{\theta JA}$ ) is highly dependent on the heat-spreading capability built into the particular PCB design, which varies according to the total copper area, copper weight, and location of the planes. The  $R_{\theta JA}$  recorded in the v table is determined by the JEDEC standard, PCB, and copper-spreading area, and is only used as a relative measure of package thermal performance. For a well-designed thermal layout,  $R_{\theta JA}$  is the sum of the VQFN package junction-to-case (bottom) thermal resistance ( $R_{\theta JCbot}$ ) plus the thermal resistance contribution by the PCB copper.

### 8.1.8.1 Estimating Junction Temperature

The JEDEC standard now recommends the use of psi ( $\Psi$ ) thermal metrics to estimate the junction temperatures of the LDO when in-circuit on a typical PCB board application. These metrics are not referencing thermal resistances, but rather offer practical and relative means of estimating junction temperatures. These psi metrics are determined to be significantly independent of the copper-spreading area. The key thermal metrics ( $\Psi_{JT}$  and  $\Psi_{JB}$ ) are shown in and are used in accordance with Equation 14.

$$\Psi_{JT}: T_J = T_T + \Psi_{JT} \times P_D$$

$$\Psi_{JB}: T_J = T_B + \Psi_{JB} \times P_D$$

where:

- $P_D$  is the power dissipated as explained in
  - $T_T$  is the temperature at the center-top of the device package, and
  - $T_B$  is the PCB surface temperature measured 1 mm from the device package and centered on the package edge
- (14)

### 8.1.8.2 Recommended Area for Continuous Operation (RACO)

The operational area of an LDO is limited by the dropout voltage, output current, junction temperature, and input voltage. The recommended area for continuous operation for a linear regulator can be separated into the following parts, as shown in Figure 63:

- Limited by dropout: Dropout voltage limits the minimum differential voltage between the input and the output ( $V_{IN} - V_{OUT}$ ) at a given output current level; see [Dropout Voltage \( \$V\_{DO}\$ \)](#) for more details.
- Limited by rated output current: The rated output current limits the maximum recommended output current level. Exceeding this rating causes the device to fall out of specification.
- Limited by thermals: The shape of the slope is calculated by Equation 14. The slope is nonlinear because the junction temperature of the LDO is controlled by the power dissipation across the LDO. As a result, when  $V_{IN} - V_{OUT}$  increases, the output current must decrease to ensure that the rated junction temperature of the device is not exceeded. Exceeding this rating can cause the device to fall out of specifications and reduces long-term reliability.
- Limited by  $V_{IN}$  range: The rated input voltage range governs both the minimum and maximum of  $V_{IN} - V_{OUT}$ .

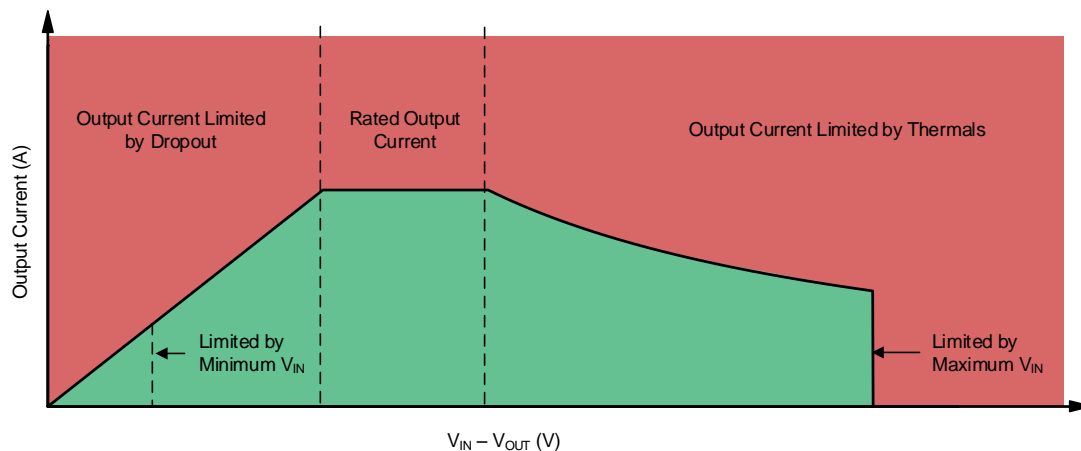

**Figure 63. Continuous Operation Slope Region Description**

Figure 64 to Figure 69 show the recommended area of operation curves for this device on a JEDEC-standard, high-K board with a  $R_{\theta JA} = 43.4^{\circ}\text{C}/\text{W}$ , as shown in .

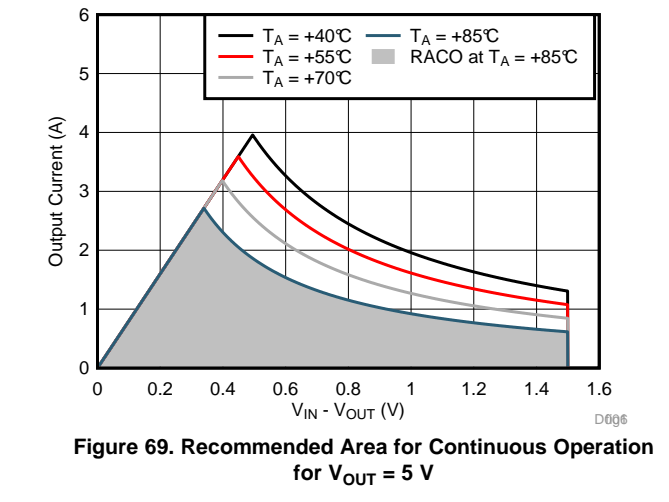
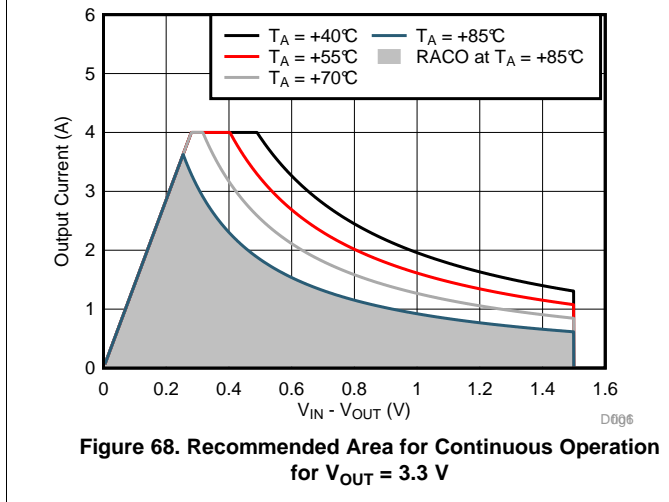
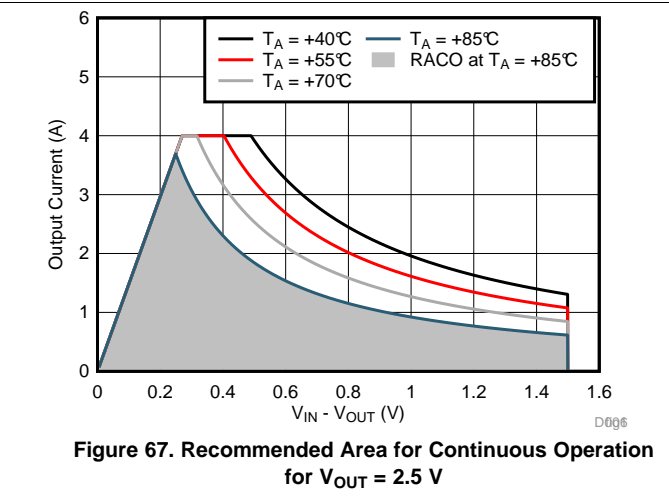
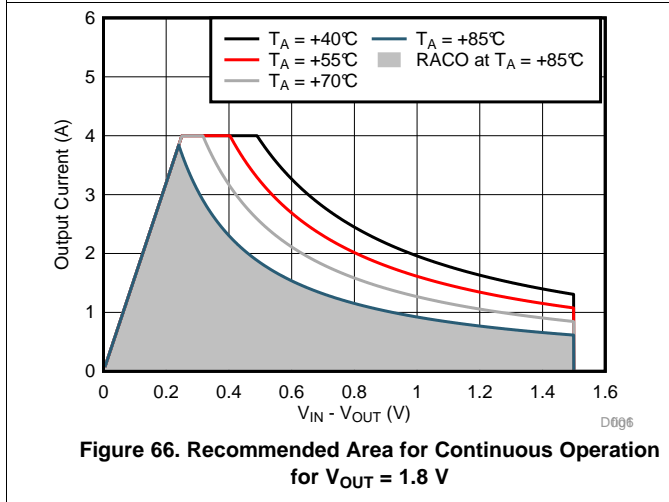
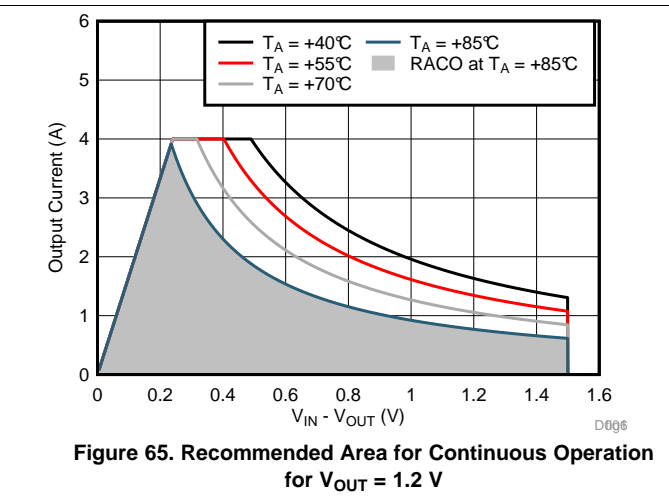
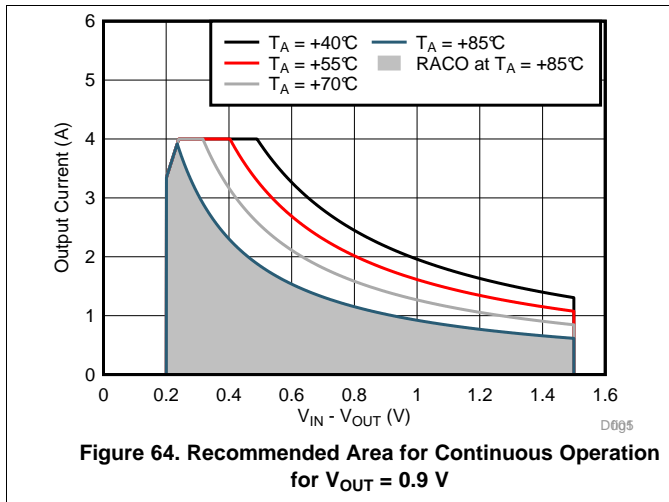

## 8.2 Typical Applications

### 8.2.1 Low-Input, Low-Output (LILO) Voltage Conditions

The TPS7A85A device uses the ANY-OUT configuration to regulate a 4-A load requiring good PSRR at high frequency with low-noise at 0.9 V using a 1.2-V input voltage and a 5-V bias supply. The schematic for this typical application circuit is shown in [Figure 70](#).

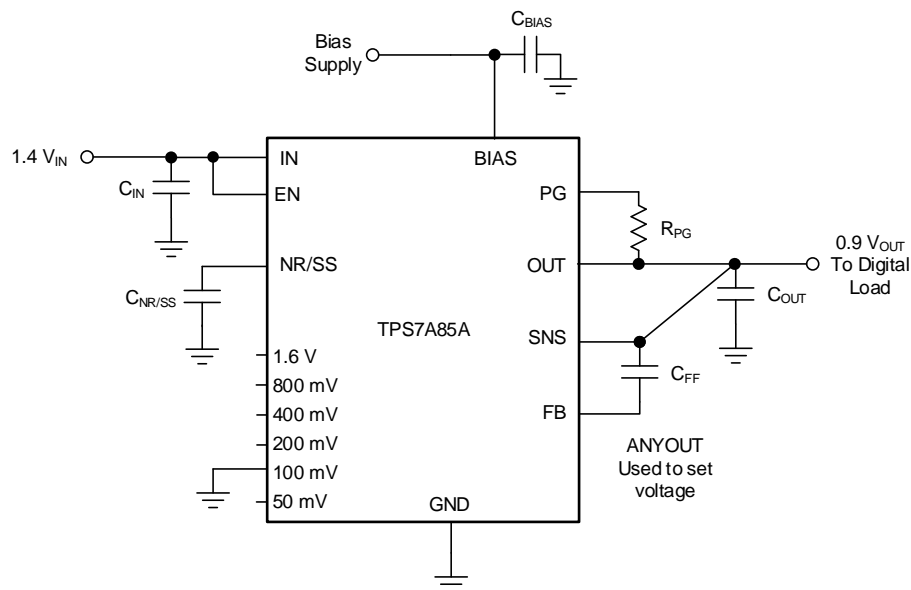

Copyright © 2017, Texas Instruments Incorporated

**Figure 70. TPS7A85A Typical Application**

#### 8.2.1.1 Design Requirements

For this design example, use the parameters listed in [Table 13](#) as the input parameters.

**Table 13. Design Parameters**

PARAMETER	DESIGN REQUIREMENT
Input voltage	1.4 V, $\pm 3\%$ , provided by the dc-dc converter switching at 500 kHz
Bias voltage	5 V, $\pm 5\%$
Output voltage	0.9 V, $\pm 1\%$
Output current	4 A (maximum), 100 mA (minimum)
RMS noise, 10 Hz to 100 kHz	$< 10 \mu V_{RMS}$
PSRR at 500 kHz	$> 40$ dB
Start-up time	$< 25$ ms

#### 8.2.1.2 Detailed Design Procedure

At 4 A, the dropout of the TPS7A85A has 240-mV maximum dropout over temperature, and as a result, a 400-mV headroom is sufficient for operation over input and output voltage accuracy. The bias rail is provided for better performance for the LILO conditions. The PSRR is greater than 40 dB in these conditions, and noise is less than  $10 \mu V_{RMS}$ , as listed in [Table 13](#).

The ANY-OUT internal resistor network is used for maximum accuracy.

The 100mV pin is grounded to achieve 0.9 V on the output. The voltage value of 100 mV is added to the 0.8-V internal reference voltage for  $V_{OUT(nom)}$  equal to 0.9 V, as shown in [Equation 15](#).

$$V_{OUT(nom)} = V_{NR/SS} + 0.1 V = 0.8 V + 0.1 V = 0.9 V \quad (15)$$

Input and output capacitors are selected in accordance with [External Component Selection](#). Ceramic capacitances of 47  $\mu\text{F}$  for the input and one 47- $\mu\text{F}$  capacitor in parallel with two 10- $\mu\text{F}$  capacitors for the output are selected.

To satisfy the required start-up time and still maintain low-noise performance, a 100-nF  $C_{\text{NR/SS}}$  is selected. This value is calculated with [Equation 16](#).

$$t_{\text{SS}} = (V_{\text{NR/SS}} \times C_{\text{NR/SS}}) / I_{\text{NR/SS}} \quad (16)$$

At the 4-A maximum load, the internal power dissipation is 2 W and corresponds to a 7°C junction temperature rise for the RGR package on a standard JEDEC board. With an 55°C maximum ambient temperature, the junction temperature is at 62°C. To further minimize noise, a feed-forward capacitance ( $C_{\text{FF}}$ ) of 10 nF is selected.

### 8.2.1.3 Application Curves

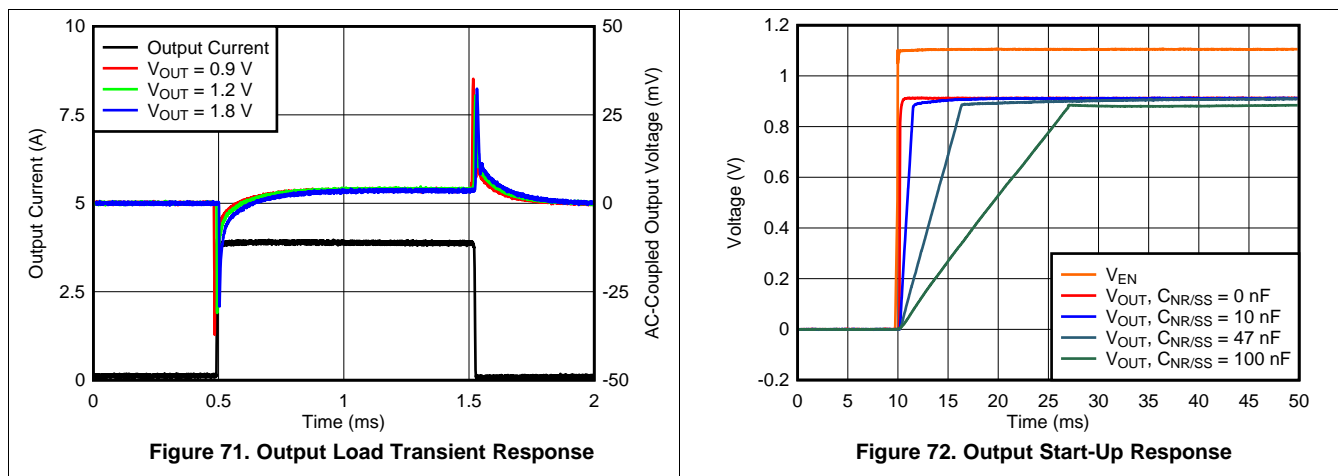

## 9 Power-Supply Recommendations

The TPS7A85A device is designed to operate from an input voltage supply range from 1.1 V to 6.5 V. If the input supply is less than 1.4 V, then a bias rail of at least 3 V must be used. The input voltage range provides adequate headroom for the device to have a regulated output. This input supply must be well-regulated. If the input supply is noisy, additional input capacitors with low ESR may help improve output noise performance.

## 10 Layout

### 10.1 Layout Guidelines

For best overall performance, place all circuit components on the same side of the circuit board and as near as practical to the respective LDO pin connections. Place ground return connections to the input and output capacitor, and to the LDO ground pin as close as possible to each other, connected by a wide, component-side, copper surface. The use of vias and long traces to the input and output capacitors is strongly discouraged and negatively affects system performance. The grounding and layout scheme shown in [Figure 73](#) minimizes inductive parasitics, and as a result, reduces load-current transients, minimizes noise, and increases circuit stability.

TI recommends a ground reference plane embedded in the PCB itself or located on the bottom side of the PCB opposite the components. This reference plane serves to ensure accuracy of the output voltage, shield noise, and behaves similarly to a thermal plane to spread (or sink) heat from the LDO device when connected to the thermal pad. In most applications, this ground plane is necessary to meet thermal requirements.

## 10.2 Layout Example

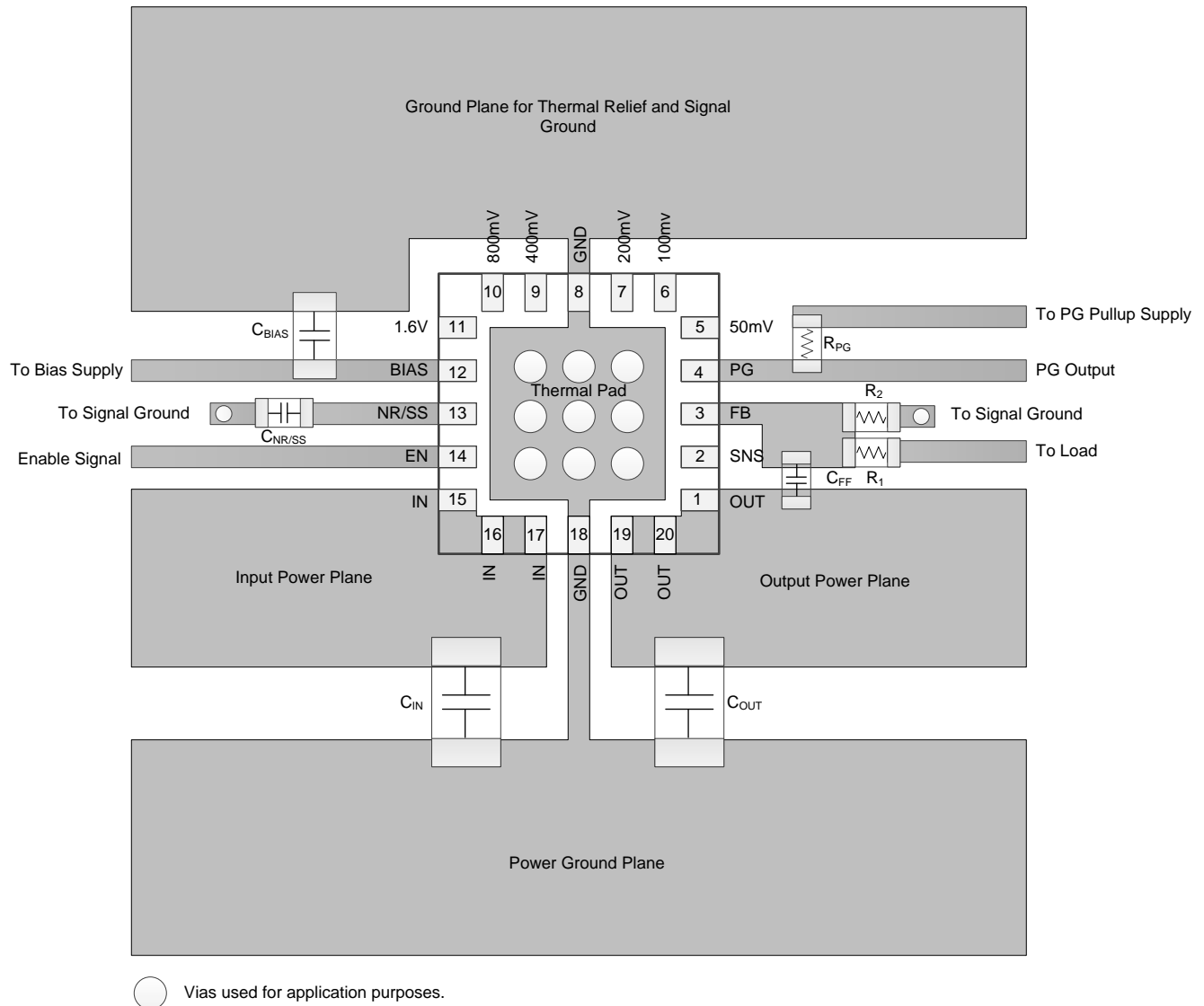

Figure 73. Example Layout



**PACKAGING INFORMATION**

Orderable part number	Status (1)	Material type (2)	Package   Pins	Package qty   Carrier	RoHS (3)	Lead finish/ Ball material (4)	MSL rating/ Peak reflow (5)	Op temp (°C)	Part marking (6)
<a href="#">TPS7A8500ARGRR</a>	Active	Production	VQFN (RGR)   20	3000   LARGE T&R	Yes	NIPDAU	Level-1-260C-UNLIM	-40 to 125	8500A
TPS7A8500ARGRR.A	Active	Production	VQFN (RGR)   20	3000   LARGE T&R	Yes	NIPDAU	Level-1-260C-UNLIM	-40 to 125	8500A
<a href="#">TPS7A8500ARGRT</a>	Active	Production	VQFN (RGR)   20	250   SMALL T&R	Yes	NIPDAU	Level-1-260C-UNLIM	-40 to 125	8500A
TPS7A8500ARGRT.A	Active	Production	VQFN (RGR)   20	250   SMALL T&R	Yes	NIPDAU	Level-1-260C-UNLIM	-40 to 125	8500A
TPS7A8500ARGRTG4	Active	Production	VQFN (RGR)   20	250   SMALL T&R	Yes	NIPDAU	Level-1-260C-UNLIM	-40 to 125	8500A
TPS7A8500ARGRTG4.A	Active	Production	VQFN (RGR)   20	250   SMALL T&R	Yes	NIPDAU	Level-1-260C-UNLIM	-40 to 125	8500A

<sup>(1)</sup> **Status:** For more details on status, see our [product life cycle](#).

<sup>(2)</sup> **Material type:** When designated, preproduction parts are prototypes/experimental devices, and are not yet approved or released for full production. Testing and final process, including without limitation quality assurance, reliability performance testing, and/or process qualification, may not yet be complete, and this item is subject to further changes or possible discontinuation. If available for ordering, purchases will be subject to an additional waiver at checkout, and are intended for early internal evaluation purposes only. These items are sold without warranties of any kind.

<sup>(3)</sup> **RoHS values:** Yes, No, RoHS Exempt. See the [TI RoHS Statement](#) for additional information and value definition.

<sup>(4)</sup> **Lead finish/Ball material:** Parts may have multiple material finish options. Finish options are separated by a vertical ruled line. Lead finish/Ball material values may wrap to two lines if the finish value exceeds the maximum column width.

<sup>(5)</sup> **MSL rating/Peak reflow:** The moisture sensitivity level ratings and peak solder (reflow) temperatures. In the event that a part has multiple moisture sensitivity ratings, only the lowest level per JEDEC standards is shown. Refer to the shipping label for the actual reflow temperature that will be used to mount the part to the printed circuit board.

<sup>(6)</sup> **Part marking:** There may be an additional marking, which relates to the logo, the lot trace code information, or the environmental category of the part.

Multiple part markings will be inside parentheses. Only one part marking contained in parentheses and separated by a "~" will appear on a part. If a line is indented then it is a continuation of the previous line and the two combined represent the entire part marking for that device.

**Important Information and Disclaimer:** The information provided on this page represents TI's knowledge and belief as of the date that it is provided. TI bases its knowledge and belief on information provided by third parties, and makes no representation or warranty as to the accuracy of such information. Efforts are underway to better integrate information from third parties. TI has taken and continues to take reasonable steps to provide representative and accurate information but may not have conducted destructive testing or chemical analysis on incoming materials and chemicals. TI and TI suppliers consider certain information to be proprietary, and thus CAS numbers and other limited information may not be available for release.

In no event shall TI's liability arising out of such information exceed the total purchase price of the TI part(s) at issue in this document sold by TI to Customer on an annual basis.



**TAPE AND REEL INFORMATION**

**QUADRANT ASSIGNMENTS FOR PIN 1 ORIENTATION IN TAPE**

\*All dimensions are nominal

Device	Package Type	Package Drawing	Pins	SPQ	Reel Diameter (mm)	Reel Width W1 (mm)	A0 (mm)	B0 (mm)	K0 (mm)	P1 (mm)	W (mm)	Pin1 Quadrant
TPS7A8500ARGRR	VQFN	RGR	20	3000	330.0	12.4	3.75	3.75	1.15	8.0	12.0	Q2
TPS7A8500ARGRT	VQFN	RGR	20	250	180.0	12.4	3.75	3.75	1.15	8.0	12.0	Q2
TPS7A8500ARGRTG4	VQFN	RGR	20	250	180.0	12.4	3.75	3.75	1.15	8.0	12.0	Q2

**TAPE AND REEL BOX DIMENSIONS**

\*All dimensions are nominal

Device	Package Type	Package Drawing	Pins	SPQ	Length (mm)	Width (mm)	Height (mm)
TPS7A8500ARGRR	VQFN	RGR	20	3000	367.0	367.0	35.0
TPS7A8500ARGRT	VQFN	RGR	20	250	210.0	185.0	35.0
TPS7A8500ARGRTG4	VQFN	RGR	20	250	210.0	185.0	35.0

## GENERIC PACKAGE VIEW

**RGR 20**

**VQFN - 1 mm max height**

3.5 x 3.5, 0.5 mm pitch

PLASTIC QUAD FLATPACK - NO LEAD

This image is a representation of the package family, actual package may vary.  
Refer to the product data sheet for package details.

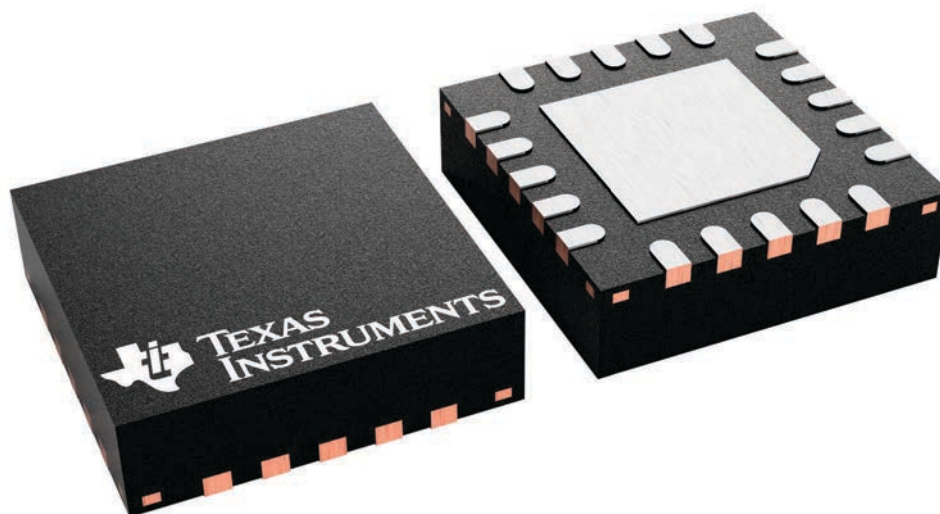

4228482/A



# EXAMPLE BOARD LAYOUT

RGR0020A

VQFN - 1 mm max height

PLASTIC QUAD FLATPACK - NO LEAD

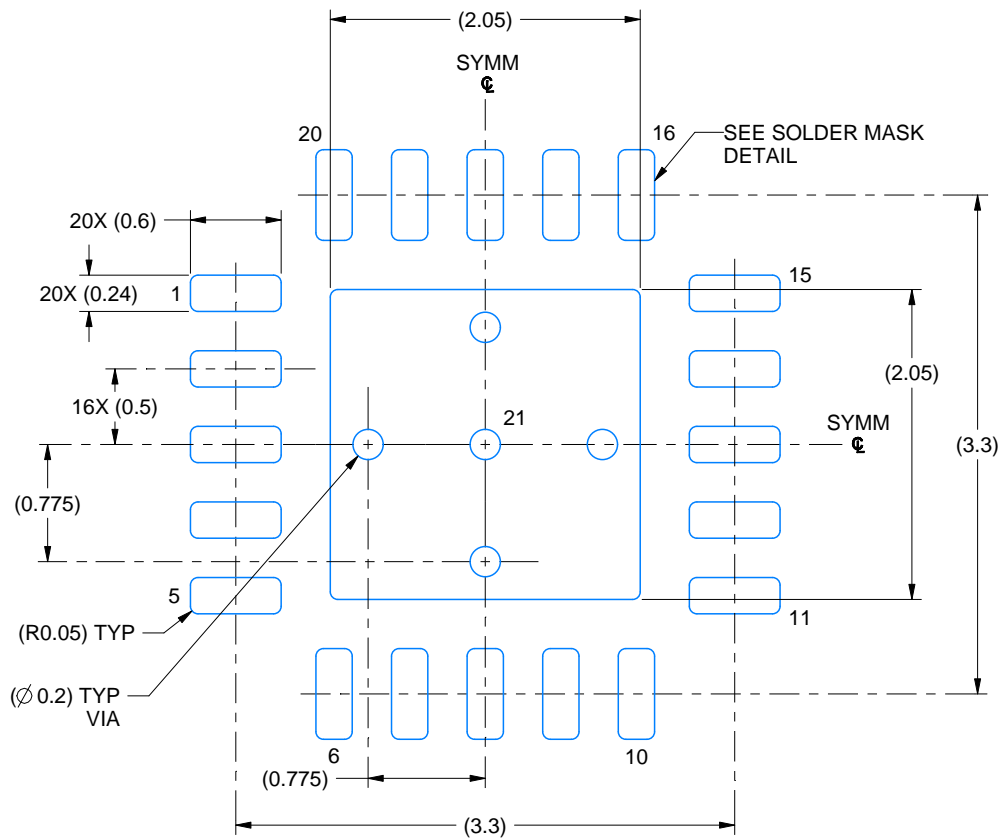

LAND PATTERN EXAMPLE  
EXPOSED METAL SHOWN  
SCALE: 20X

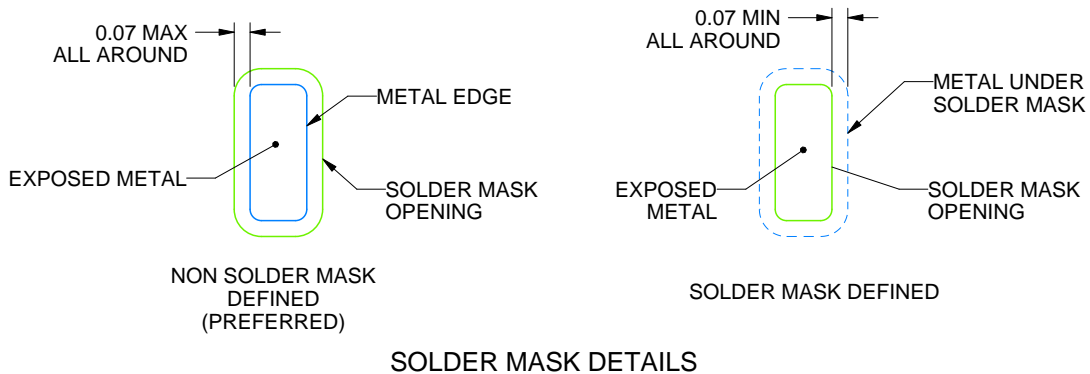

SOLDER MASK DETAILS

4219031/B 04/2022

NOTES: (continued)

4. This package is designed to be soldered to a thermal pad on the board. For more information, see Texas Instruments literature number SLUA271 ([www.ti.com/lit/sluea271](http://www.ti.com/lit/sluea271)).
5. Vias are optional depending on application, refer to device data sheet. If any vias are implemented, refer to their locations shown on this view. It is recommended that vias under paste be filled, plugged or tented.

# EXAMPLE STENCIL DESIGN

RGR0020A

VQFN - 1 mm max height

PLASTIC QUAD FLATPACK - NO LEAD

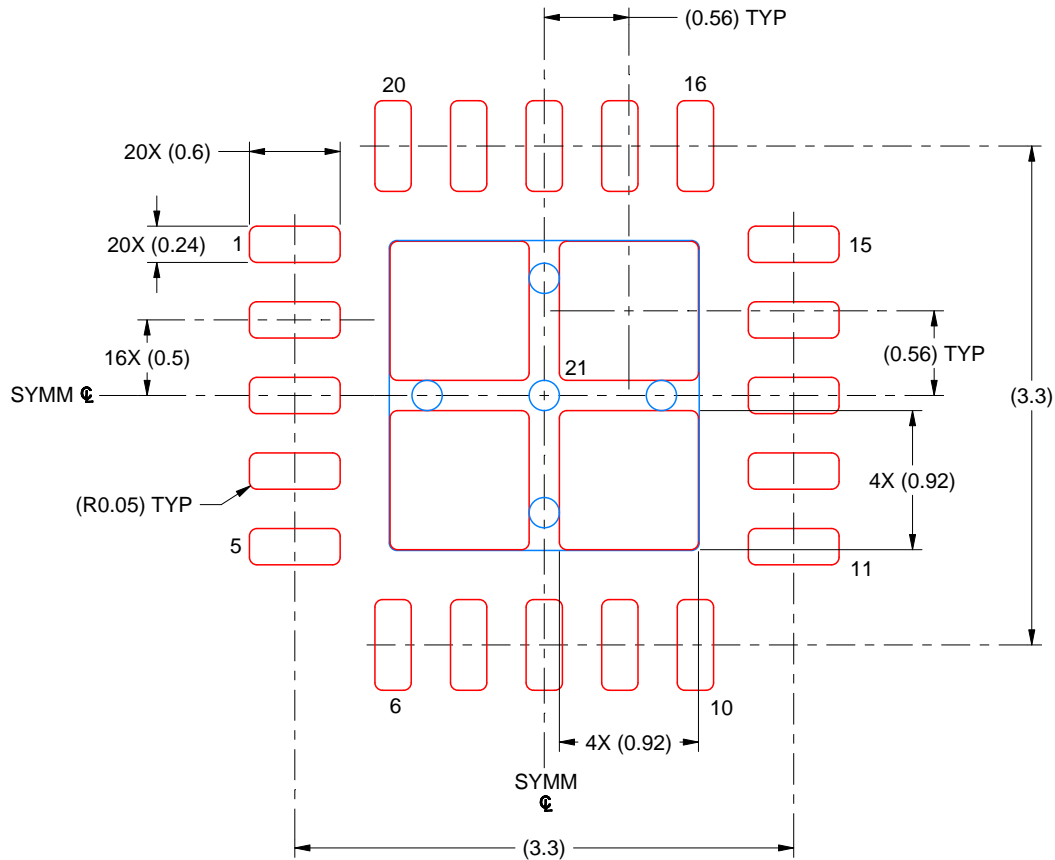

SOLDER PASTE EXAMPLE  
BASED ON 0.125 MM THICK STENCIL  
SCALE: 20X

EXPOSED PAD 21  
81% PRINTED SOLDER COVERAGE BY AREA UNDER PACKAGE

4219031/B 04/2022

NOTES: (continued)

6. Laser cutting apertures with trapezoidal walls and rounded corners may offer better paste release. IPC-7525 may have alternate design recommendations.



## IMPORTANT NOTICE AND DISCLAIMER

TI PROVIDES TECHNICAL AND RELIABILITY DATA (INCLUDING DATASHEETS), DESIGN RESOURCES (INCLUDING REFERENCE DESIGNS), APPLICATION OR OTHER DESIGN ADVICE, WEB TOOLS, SAFETY INFORMATION, AND OTHER RESOURCES "AS IS" AND WITH ALL FAULTS, AND DISCLAIMS ALL WARRANTIES, EXPRESS AND IMPLIED, INCLUDING WITHOUT LIMITATION ANY IMPLIED WARRANTIES OF MERCHANTABILITY, FITNESS FOR A PARTICULAR PURPOSE OR NON-INFRINGEMENT OF THIRD PARTY INTELLECTUAL PROPERTY RIGHTS.

These resources are intended for skilled developers designing with TI products. You are solely responsible for (1) selecting the appropriate TI products for your application, (2) designing, validating and testing your application, and (3) ensuring your application meets applicable standards, and any other safety, security, regulatory or other requirements.

These resources are subject to change without notice. TI grants you permission to use these resources only for development of an application that uses the TI products described in the resource. Other reproduction and display of these resources is prohibited. No license is granted to any other TI intellectual property right or to any third party intellectual property right. TI disclaims responsibility for, and you fully indemnify TI and its representatives against any claims, damages, costs, losses, and liabilities arising out of your use of these resources.

TI's products are provided subject to [TI's Terms of Sale](#), [TI's General Quality Guidelines](#), or other applicable terms available either on [ti.com](http://ti.com) or provided in conjunction with such TI products. TI's provision of these resources does not expand or otherwise alter TI's applicable warranties or warranty disclaimers for TI products. Unless TI explicitly designates a product as custom or customer-specified, TI products are standard, catalog, general purpose devices.

TI objects to and rejects any additional or different terms you may propose.

Copyright © 2025, Texas Instruments Incorporated

Last updated 10/2025