

# AMC0x00D Precision, $\pm 250\text{mV}$ Input, Basic and Reinforced Isolated Amplifiers With Fixed Gain and Differential Output

## 1 Features

- Linear input voltage range:  $\pm 250\text{mV}$
- Supply voltage range:
  - High-side (VDD1): 3.0V to 5.5V
  - Low-side (VDD2): 3.0V to 5.5V
- Fixed gain: 8.2V/V
- Differential analog output
- Low DC errors:
  - Offset error:  $\pm 0.2\text{mV}$  (maximum)
  - Offset drift:  $\pm 2\mu\text{V}/^\circ\text{C}$  (maximum)
  - Gain error:  $\pm 0.25\%$  (maximum)
  - Gain drift:  $\pm 35\text{ppm}/^\circ\text{C}$  (maximum)
  - Nonlinearity: 0.04% (maximum)
- High CMTI: 150V/ns (minimum)
- Low EMI: Meets CISPR-11 and CISPR-25 standards
- Isolation ratings:
  - AMC0200D: Basic isolation
  - AMC0300D: Reinforced Isolation
- Safety-related certifications:
  - DIN EN IEC 60747-17 (VDE 0884-17)
  - UL1577
- Fully specified over the extended industrial temperature range:  $-40^\circ\text{C}$  to  $+125^\circ\text{C}$

## 2 Applications

- [Industrial motor drives](#)
- [Frequency inverters](#)
- [Server power-supply units \(PSU\)](#)
- [Power factor correction \(PFC\)](#)

## 3 Description

The AMC0x00D is a precision, galvanically isolated amplifier with a  $\pm 250\text{mV}$ , differential input and differential output. The input is optimized for direct connection to a shunt resistor or other low-impedance signal source.

The isolation barrier separates parts of the system that operate on different common-mode voltage levels. The isolation barrier is highly resistant to magnetic interference. This barrier is certified to provide reinforced isolation up to  $5\text{kV}_{\text{RMS}}$  (DWV package) and basic isolation up to  $3\text{kV}_{\text{RMS}}$  (D package) (60s).

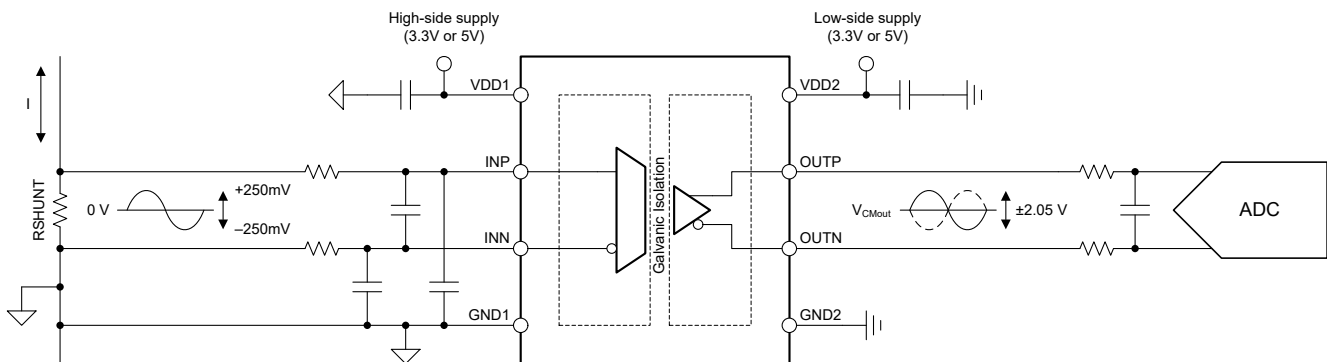
The AMC0x00D outputs a differential signal proportional to the input voltage. The differential output is insensitive to ground shifts and enables routing the output signal over long distances.

The AMC0x00D comes in 8-pin, wide- and narrow-body SOIC packages, and is fully specified over the temperature range from  $-40^\circ\text{C}$  to  $+125^\circ\text{C}$ .

### Package Information

PART NUMBER	PACKAGE <sup>(1)</sup>	PACKAGE SIZE <sup>(2)</sup>
AMC0200D	D (SOIC, 8)	4.9mm × 6mm
AMC0300D	DWV (SOIC, 8)	5.85mm × 11.5mm

- (1) For more information, see the [Mechanical, Packaging, and Orderable Information](#).
- (2) The package size (length × width) is a nominal value and includes pins, where applicable.



Typical Application



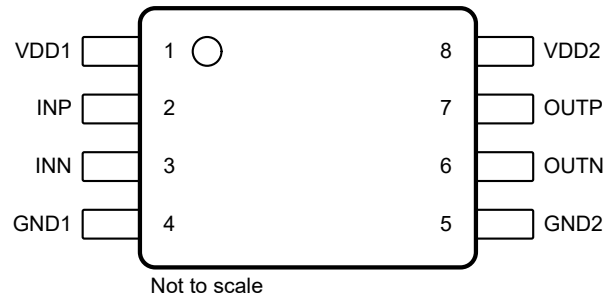
## Table of Contents

<b>1 Features</b> .....	1	6.17 Typical Characteristics.....	16
<b>2 Applications</b> .....	1	<b>7 Detailed Description</b> .....	22
<b>3 Description</b> .....	1	7.1 Overview.....	22
<b>4 Device Comparison Table</b> .....	3	7.2 Functional Block Diagram.....	22
<b>5 Pin Configuration and Functions</b> .....	3	7.3 Feature Description.....	23
<b>6 Specifications</b> .....	4	7.4 Device Functional Modes.....	25
6.1 Absolute Maximum Ratings .....	4	<b>8 Application and Implementation</b> .....	26
6.2 ESD Ratings.....	4	8.1 Application Information.....	26
6.3 Recommended Operating Conditions .....	4	8.2 Typical Application.....	26
6.4 Thermal Information (D Package).....	5	8.3 Best Design Practices.....	29
6.5 Thermal Information (DWV Package).....	6	8.4 Power Supply Recommendations.....	29
6.6 Power Ratings .....	6	8.5 Layout.....	30
6.7 Insulation Specifications (Basic Isolation).....	7	<b>9 Device and Documentation Support</b> .....	31
6.8 Insulation Specifications (Reinforced Isolation).....	8	9.1 Documentation Support.....	31
6.9 Safety-Related Certifications (Basic Isolation).....	9	9.2 Receiving Notification of Documentation Updates....	31
6.10 Safety-Related Certifications (Reinforced Isolation).....	10	9.3 Support Resources.....	31
6.11 Safety Limiting Values (D Package).....	11	9.4 Trademarks.....	31
6.12 Safety Limiting Values (DWV Package).....	12	9.5 Electrostatic Discharge Caution.....	31
6.13 Electrical Characteristics.....	13	9.6 Glossary.....	31
6.14 Switching Characteristics .....	14	<b>10 Revision History</b> .....	31
6.15 Timing Diagram.....	14	<b>11 Mechanical, Packaging, and Orderable Information</b> .....	32
6.16 Insulation Characteristics Curves.....	15		

## 4 Device Comparison Table

PARAMETER	AMC0200D	AMC0300D
Isolation rating per VDE 0884-17	Basic	Reinforced
Package	Narrow-body SOIC (D)	Wide-body SOIC (DWV)

## 5 Pin Configuration and Functions



**Figure 5-1. DWV and D Packages, 8-Pin SOIC (Top View)**

**Table 5-1. Pin Functions**

PIN		TYPE	DESCRIPTION
NO.	NAME		
1	VDD1	High-side power	High-side power supply <sup>(1)</sup>
2	INP	Analog input	Noninverting analog input <sup>(2)</sup>
3	INN	Analog Input	Inverting analog input <sup>(2)</sup>
4	GND1	High-side ground	High-side analog ground
5	GND2	Low-side ground	Low-side analog ground
6	OUTN	Analog output	Inverting analog output
7	OUTP	Analog output	Noninverting analog output
8	VDD2	Low-side power	Low-side power supply <sup>(1)</sup>

- (1) See the [Power Supply Recommendations](#) section for power-supply decoupling recommendations.  
 (2) See the [Input Filter Design](#) section for input filter design.

## 6 Specifications

### 6.1 Absolute Maximum Ratings

over operating free-air temperature range (unless otherwise noted)<sup>(1)</sup>

		MIN	MAX	UNIT
Power-supply voltage	High-side VDD1 to GND1	-0.3	6.5	V
	Low-side VDD2 to GND2	-0.3	6.5	
Analog input voltage	INP, INN to GND1	GND1 - 4	VDD1 + 0.5	V
Analog output voltage	OUTP, OUTN to GND2	GND2 - 0.5	VDD2 + 0.5	V
Input current	Continuous, any pin except power-supply pins	-10	10	mA
Temperature	Junction, T <sub>J</sub>		150	°C
	Storage, T <sub>stg</sub>	-65	150	

- (1) Operation outside the *Absolute Maximum Ratings* may cause permanent device damage. *Absolute Maximum Ratings* do not imply functional operation of the device at these or any other conditions beyond those listed under *Recommended Operating Conditions*. If used outside the Recommended Operating Conditions but within the Absolute Maximum Ratings, the device may not be fully functional, and this may affect device reliability, functionality, performance, and shorten the device lifetime.

### 6.2 ESD Ratings

			VALUE	UNIT
V <sub>(ESD)</sub>	Electrostatic discharge	Human-body model (HBM), per ANSI/ESDA/JEDEC JS-001 <sup>(1)</sup>	±2000	V
		Charged-device model (CDM), per ANSI/ESDA/JEDEC JS-002 <sup>(2)</sup>	±1000	

- (1) JEDEC document JEP155 states that 500V HBM allows safe manufacturing with a standard ESD control process.  
 (2) JEDEC document JEP157 states that 250V CDM allows safe manufacturing with a standard ESD control process.

### 6.3 Recommended Operating Conditions

over operating ambient temperature range (unless otherwise noted)

				MIN	NOM	MAX	UNIT
<b>POWER SUPPLY</b>							
VDD1	High-side power supply	VDD1 to GND1		3	5.0	5.5	V
VDD2	Low-side power supply	VDD2 to GND2		3	3.3	5.5	V
<b>ANALOG INPUT</b>							
V <sub>Clipping</sub>	Nominal differential input voltage before clipping output	V <sub>IN</sub> = V <sub>INP</sub> - V <sub>INN</sub>		-320		320	mV
V <sub>FSR</sub>	Specified linear differential input voltage	V <sub>IN</sub> = V <sub>INP</sub> - V <sub>INN</sub>		-250		250	mV
V <sub>CM</sub>	Operating common-mode input voltage	(V <sub>INP</sub> + V <sub>INN</sub> ) / 2 to GND1		-0.16		1	V
C <sub>IN, EXT</sub>	Minimum external capacitance connected to the input	from INP to INN			10		nF
<b>ANALOG OUTPUT</b>							
C <sub>LOAD</sub>	Capacitive load	OUTP or OUTN to GND2				500	pF
		OUTP to OUTN				250	
R <sub>LOAD</sub>	Resistive load	OUTP or OUTN to GND2			10	1	kΩ
<b>TEMPERATURE RANGE</b>							
T <sub>A</sub>	Specified ambient temperature			-40		125	°C

## 6.4 Thermal Information (D Package)

THERMAL METRIC <sup>(1)</sup>		D (SOIC)	UNIT
		8 PINS	
$R_{\theta JA}$	Junction-to-ambient thermal resistance	116.5	°C/W
$R_{\theta JC(top)}$	Junction-to-case (top) thermal resistance	52.8	°C/W
$R_{\theta JB}$	Junction-to-board thermal resistance	58.9	°C/W
$\Psi_{JT}$	Junction-to-top characterization parameter	19.4	°C/W
$\Psi_{JB}$	Junction-to-board characterization parameter	58.0	°C/W
$R_{\theta JC(bot)}$	Junction-to-case (bottom) thermal resistance	N/A	°C/W

- (1) For more information about traditional and new thermal metrics, see the [Semiconductor and IC Package Thermal Metrics](#) application note.

## 6.5 Thermal Information (DWV Package)

THERMAL METRIC <sup>(1)</sup>		DWV (SOIC)	UNIT
		8 PINS	
$R_{\theta JA}$	Junction-to-ambient thermal resistance	102.8	°C/W
$R_{\theta JC(top)}$	Junction-to-case (top) thermal resistance	45.1	°C/W
$R_{\theta JB}$	Junction-to-board thermal resistance	63.0	°C/W
$\Psi_{JT}$	Junction-to-top characterization parameter	14.3	°C/W
$\Psi_{JB}$	Junction-to-board characterization parameter	61.1	°C/W
$R_{\theta JC(bot)}$	Junction-to-case (bottom) thermal resistance	N/A	°C/W

(1) For more information about traditional and new thermal metrics, see the [Semiconductor and IC Package Thermal Metrics](#) application note.

## 6.6 Power Ratings

PARAMETER	TEST CONDITIONS	VALUE	UNIT	
$P_D$	Maximum power dissipation (both sides)	VDD1 = VDD2 = 5.5V	91	mW
$P_{D1}$	Maximum power dissipation (high-side)	VDD1 = 5.5V	37	mW
$P_{D2}$	Maximum power dissipation (low-side)	VDD2 = 5.5V	54	mW

## 6.7 Insulation Specifications (Basic Isolation)

over operating ambient temperature range (unless otherwise noted)

PARAMETER		TEST CONDITIONS	VALUE	UNIT
<b>GENERAL</b>				
CLR	External clearance <sup>(1)</sup>	Shortest pin-to-pin distance through air	≥ 4	mm
CPG	External creepage <sup>(1)</sup>	Shortest pin-to-pin distance across the package surface	≥ 4	mm
DTI	Distance through insulation	Minimum internal gap (internal clearance) of the insulation	≥ 15.4	μm
CTI	Comparative tracking index	DIN EN 60112 (VDE 0303-11); IEC 60112	≥ 600	V
	Material group	According to IEC 60664-1	I	
	Overvoltage category per IEC 60664-1	Rated mains voltage ≤ 300V <sub>RMS</sub>	I-IV	
		Rated mains voltage ≤ 600V <sub>RMS</sub>	I-III	
<b>DIN EN IEC 60747-17 (VDE 0884-17)<sup>(2)</sup></b>				
V <sub>IORM</sub>	Maximum repetitive peak isolation voltage	At AC voltage	1130	V <sub>PK</sub>
V <sub>IOWM</sub>	Maximum-rated isolation working voltage	At AC voltage (sine wave)	800	V <sub>RMS</sub>
		At DC voltage	1130	V <sub>DC</sub>
V <sub>IOTM</sub>	Maximum transient isolation voltage	V <sub>TEST</sub> = V <sub>IOTM</sub> , t = 60s (qualification test), V <sub>TEST</sub> = 1.2 × V <sub>IOTM</sub> , t = 1s (100% production test)	4250	V <sub>PK</sub>
V <sub>IMP</sub>	Maximum impulse voltage <sup>(3)</sup>	Tested in air, 1.2/50μs waveform per IEC 62368-1	5000	V <sub>PK</sub>
V <sub>IOSM</sub>	Maximum surge isolation voltage <sup>(4)</sup>	Tested in oil (qualification test), 1.2/50μs waveform per IEC 62368-1	10000	V <sub>PK</sub>
q <sub>pd</sub>	Apparent charge <sup>(5)</sup>	Method a, after input/output safety test subgroups 2 and 3, V <sub>pd(ini)</sub> = V <sub>IOTM</sub> , t <sub>ini</sub> = 60s, V <sub>pd(m)</sub> = 1.2 × V <sub>IORM</sub> , t <sub>m</sub> = 10s	≤ 5	pC
		Method a, after environmental tests subgroup 1, V <sub>pd(ini)</sub> = V <sub>IOTM</sub> , t <sub>ini</sub> = 60s, V <sub>pd(m)</sub> = 1.3 × V <sub>IORM</sub> , t <sub>m</sub> = 10s	≤ 5	
		Method b1, at preconditioning (type test) and routine test, V <sub>pd(ini)</sub> = V <sub>IOTM</sub> , t <sub>ini</sub> = 1s, V <sub>pd(m)</sub> = 1.5 × V <sub>IORM</sub> , t <sub>m</sub> = 1s	≤ 5	
		Method b2, at routine test (100% production) <sup>(7)</sup> , V <sub>pd(ini)</sub> = V <sub>IOTM</sub> = V <sub>pd(m)</sub> , t <sub>ini</sub> = t <sub>m</sub> = 1s	≤ 5	
C <sub>IO</sub>	Barrier capacitance, input to output <sup>(6)</sup>	V <sub>IO</sub> = 0.5V <sub>PP</sub> at 1MHz	≈ 1.5	pF
R <sub>IO</sub>	Insulation resistance, input to output <sup>(6)</sup>	V <sub>IO</sub> = 500V at T <sub>A</sub> = 25°C	> 10 <sup>12</sup>	Ω
		V <sub>IO</sub> = 500V at 100°C ≤ T <sub>A</sub> ≤ 125°C	> 10 <sup>11</sup>	
		V <sub>IO</sub> = 500V at T <sub>S</sub> = 150°C	> 10 <sup>9</sup>	
	Pollution degree		2	
	Climatic category		55/125/21	
<b>UL1577</b>				
V <sub>ISO</sub>	Withstand isolation voltage	V <sub>TEST</sub> = V <sub>ISO</sub> , t = 60s (qualification test), V <sub>TEST</sub> = 1.2 × V <sub>ISO</sub> , t = 1s (100% production test)	3000	V <sub>RMS</sub>

- (1) Apply creepage and clearance requirements according to the specific equipment isolation standards of an application. Maintain the creepage and clearance distance of a board design to make sure that the mounting pads of the isolator on the printed circuit board (PCB) do not reduce this distance. Creepage and clearance on a PCB become equal in certain cases. Techniques such as inserting grooves, ribs, or both on a PCB are used to help increase these specifications.
- (2) This coupler is suitable for *safe electrical insulation* only within the safety ratings. Compliance with the safety ratings shall be ensured by means of suitable protective circuits.
- (3) Testing is carried out in air to determine the surge immunity of the package.
- (4) Testing is carried out in oil to determine the intrinsic surge immunity of the isolation barrier.
- (5) Apparent charge is electrical discharge caused by a partial discharge (pd).
- (6) All pins on each side of the barrier are tied together, creating a two-pin device.
- (7) Either method b1 or b2 is used in production.

## 6.8 Insulation Specifications (Reinforced Isolation)

over operating ambient temperature range (unless otherwise noted)

PARAMETER		TEST CONDITIONS	VALUE	UNIT
<b>GENERAL</b>				
CLR	External clearance <sup>(1)</sup>	Shortest pin-to-pin distance through air	≥ 8.5	mm
CPG	External creepage <sup>(1)</sup>	Shortest pin-to-pin distance across the package surface	≥ 8.5	mm
DTI	Distance through insulation	Minimum internal gap (internal clearance) of the double insulation	≥ 15.4	µm
CTI	Comparative tracking index	DIN EN 60112 (VDE 0303-11); IEC 60112	≥ 600	V
	Material group	According to IEC 60664-1	I	
	Overvoltage category per IEC 60664-1	Rated mains voltage ≤ 300V <sub>RMS</sub>	I-IV	
		Rated mains voltage ≤ 6000V <sub>RMS</sub>	I-III	
<b>DIN EN IEC 60747-17 (VDE 0884-17)<sup>(2)</sup></b>				
V <sub>IORM</sub>	Maximum repetitive peak isolation voltage	At AC voltage	2120	V <sub>PK</sub>
V <sub>IOWM</sub>	Maximum-rated isolation working voltage	At AC voltage (sine wave)	1500	V <sub>RMS</sub>
		At DC voltage	2120	V <sub>DC</sub>
V <sub>IOTM</sub>	Maximum transient isolation voltage	V <sub>TEST</sub> = V <sub>IOTM</sub> , t = 60s (qualification test), V <sub>TEST</sub> = 1.2 × V <sub>IOTM</sub> , t = 1s (100% production test)	7000	V <sub>PK</sub>
V <sub>IMP</sub>	Maximum impulse voltage <sup>(3)</sup>	Tested in air, 1.2/50µs waveform per IEC 62368-1	7700	V <sub>PK</sub>
V <sub>IOSM</sub>	Maximum surge isolation voltage <sup>(4)</sup>	Tested in oil (qualification test), 1.2/50µs waveform per IEC 62368-1	10000	V <sub>PK</sub>
q <sub>pd</sub>	Apparent charge <sup>(5)</sup>	Method a, after input/output safety test subgroups 2 and 3, V <sub>pd(ini)</sub> = V <sub>IOTM</sub> , t <sub>ini</sub> = 60s, V <sub>pd(m)</sub> = 1.2 × V <sub>IORM</sub> , t <sub>m</sub> = 10s	≤ 5	pC
		Method a, after environmental tests subgroup 1, V <sub>pd(ini)</sub> = V <sub>IOTM</sub> , t <sub>ini</sub> = 60s, V <sub>pd(m)</sub> = 1.6 × V <sub>IORM</sub> , t <sub>m</sub> = 10s	≤ 5	
		Method b1, at preconditioning (type test) and routine test, V <sub>pd(ini)</sub> = 1.2 × V <sub>IOTM</sub> , t <sub>ini</sub> = 1s, V <sub>pd(m)</sub> = 1.875 × V <sub>IORM</sub> , t <sub>m</sub> = 1s	≤ 5	
		Method b2, at routine test (100% production) <sup>(7)</sup> V <sub>pd(ini)</sub> = V <sub>pd(m)</sub> = 1.2 × V <sub>IOTM</sub> , t <sub>ini</sub> = t <sub>m</sub> = 1s	≤ 5	
C <sub>IO</sub>	Barrier capacitance, input to output <sup>(6)</sup>	V <sub>IO</sub> = 0.5V <sub>PP</sub> at 1MHz	≈ 1.5	pF
R <sub>IO</sub>	Insulation resistance, input to output <sup>(6)</sup>	V <sub>IO</sub> = 500V at T <sub>A</sub> = 25°C	> 10 <sup>12</sup>	Ω
		V <sub>IO</sub> = 500V at 100°C ≤ T <sub>A</sub> ≤ 125°C	> 10 <sup>11</sup>	
		V <sub>IO</sub> = 500V at T <sub>S</sub> = 150°C	> 10 <sup>9</sup>	
	Pollution degree		2	
	Climatic category		55/125/21	
<b>UL1577</b>				
V <sub>ISO</sub>	Withstand isolation voltage	V <sub>TEST</sub> = V <sub>ISO</sub> , t = 60s (qualification test), V <sub>TEST</sub> = 1.2 × V <sub>ISO</sub> , t = 1s (100% production test)	5000	V <sub>RMS</sub>

- (1) Apply creepage and clearance requirements according to the specific equipment isolation standards of an application. Maintain the creepage and clearance distance of a board design to make sure that the mounting pads of the isolator on the printed circuit board (PCB) do not reduce this distance. Creepage and clearance on a PCB become equal in certain cases. Techniques such as inserting grooves, ribs, or both on a PCB are used to help increase these specifications.
- (2) This coupler is suitable for *safe electrical insulation* only within the safety ratings. Compliance with the safety ratings shall be ensured by means of suitable protective circuits.
- (3) Testing is carried out in air to determine the surge immunity of the package.
- (4) Testing is carried in oil to determine the intrinsic surge immunity of the isolation barrier.
- (5) Apparent charge is electrical discharge caused by a partial discharge (pd).
- (6) All pins on each side of the barrier are tied together, creating a two-pin device.
- (7) Either method b1 or b2 is used in production.

## 6.9 Safety-Related Certifications (Basic Isolation)

VDE	UL
DIN EN IEC 60747-17 (VDE 0884-17), EN IEC 60747-17, DIN EN 61010-1 (VDE 0411-1) Clause : 6.4.3 ; 6.7.1.3 ; 6.7.2.1 ; 6.7.2.2 ; 6.7.3.4.2 ; 6.8.3.1	Recognized under 1577 component recognition and CSA component acceptance NO 5 programs
Basic insulation	Single protection
Certificate number: 40040142	File number: E181974

### 6.10 Safety-Related Certifications (Reinforced Isolation)

VDE	UL
DIN EN IEC 60747-17 (VDE 0884-17), EN IEC 60747-17, DIN EN IEC 62368-1 (VDE 0868-1), EN IEC 62368-1, IEC 62368-1 Clause : 5.4.3 ; 5.4.4.4 ; 5.4.9	Recognized under 1577 component recognition and CSA component acceptance NO 5 programs
Reinforced insulation	Single protection
Certificate number: 40040142	File number: E181974

## 6.11 Safety Limiting Values (D Package)

Safety limiting<sup>(1)</sup> intends to minimize potential damage to the isolation barrier upon failure of input or output circuitry. A failure of the I/O can allow low resistance to ground or the supply and, without current limiting, dissipate sufficient power to over-heat the die and damage the isolation barrier potentially leading to secondary system failures.

PARAMETER		TEST CONDITIONS	MIN	TYP	MAX	UNIT
$I_S$	Safety input, output, or supply current	$R_{\theta JA} = 116.5^\circ\text{C/W}$ , $V_{DDX} = 5.5\text{V}$ , $T_J = 150^\circ\text{C}$ , $T_A = 25^\circ\text{C}$			195	mA
$P_S$	Safety input, output, or total power	$R_{\theta JA} = 116.5^\circ\text{C/W}$ , $T_J = 150^\circ\text{C}$ , $T_A = 25^\circ\text{C}$			1070	mW
$T_S$	Maximum safety temperature				150	$^\circ\text{C}$

- (1) The maximum safety temperature,  $T_S$ , has the same value as the maximum junction temperature,  $T_J$ , specified for the device. The  $I_S$  and  $P_S$  parameters represent the safety current and safety power, respectively. Do not exceed the maximum limits of  $I_S$  and  $P_S$ . These limits vary with the ambient temperature,  $T_A$ .

The junction-to-air thermal resistance,  $R_{\theta JA}$ , in the Thermal Information table is that of a device installed on a high-K test board for leaded surface-mount packages. Use these equations to calculate the value for each parameter:

$T_J = T_A + R_{\theta JA} \times P$ , where  $P$  is the power dissipated in the device.

$T_{J(\text{max})} = T_S = T_A + R_{\theta JA} \times P_S$ , where  $T_{J(\text{max})}$  is the maximum junction temperature.

$P_S = I_S \times V_{DD_{\text{max}}}$ , where  $V_{DD_{\text{max}}}$  is the maximum supply voltage for high-side and low-side.

## 6.12 Safety Limiting Values (DWV Package)

Safety limiting<sup>(1)</sup> intends to minimize potential damage to the isolation barrier upon failure of input or output circuitry. A failure of the I/O can allow low resistance to ground or the supply and, without current limiting, dissipate sufficient power to over-heat the die and damage the isolation barrier potentially leading to secondary system failures.

PARAMETER		TEST CONDITIONS	MIN	TYP	MAX	UNIT
$I_S$	Safety input, output, or supply current	$R_{\theta JA} = 102.8^\circ\text{C/W}$ , $VDDx = 5.5\text{V}$ , $T_J = 150^\circ\text{C}$ , $T_A = 25^\circ\text{C}$			220	mA
$P_S$	Safety input, output, or total power	$R_{\theta JA} = 102.8^\circ\text{C/W}$ , $T_J = 150^\circ\text{C}$ , $T_A = 25^\circ\text{C}$			1210	mW
$T_S$	Maximum safety temperature				150	$^\circ\text{C}$

- (1) The maximum safety temperature,  $T_S$ , has the same value as the maximum junction temperature,  $T_J$ , specified for the device. The  $I_S$  and  $P_S$  parameters represent the safety current and safety power, respectively. Do not exceed the maximum limits of  $I_S$  and  $P_S$ . These limits vary with the ambient temperature,  $T_A$ .

The junction-to-air thermal resistance,  $R_{\theta JA}$ , in the Thermal Information table is that of a device installed on a high-K test board for leaded surface-mount packages. Use these equations to calculate the value for each parameter:

$T_J = T_A + R_{\theta JA} \times P$ , where  $P$  is the power dissipated in the device.

$T_{J(max)} = T_S = T_A + R_{\theta JA} \times P_S$ , where  $T_{J(max)}$  is the maximum junction temperature.

$P_S = I_S \times VDD_{max}$ , where  $VDD_{max}$  is the maximum supply voltage for high-side and low-side.

## 6.13 Electrical Characteristics

minimum and maximum specifications apply from  $T_A = -40^\circ\text{C}$  to  $+125^\circ\text{C}$ ,  $V_{DD1} = 3.0\text{V}$  to  $5.5\text{V}$ ,  $V_{DD2} = 3.0\text{V}$  to  $5.5\text{V}$ ,  $V_{INP} = -250\text{mV}$  to  $+250\text{mV}$ , and  $V_{INN} = 0\text{V}$ ; typical specifications are at  $T_A = 25^\circ\text{C}$ ,  $V_{DD1} = 5\text{V}$ , and  $V_{DD2} = 3.3\text{V}$  (unless otherwise noted)

PARAMETER		TEST CONDITIONS	MIN	TYP	MAX	UNIT
<b>ANALOG INPUT</b>						
$C_{IN}$	Effective input sampling capacitance			1.8		pF
$R_{IN}$	Input impedance		25	27.5	30	k $\Omega$
$I_{INP}$	Input current	$V_{IN} = (V_{INP} - V_{INN}) = V_{FSR, MAX}$		9		$\mu\text{A}$
$I_{INN}$	Input current	$V_{IN} = (V_{INP} - V_{INN}) = V_{FSR, MAX}$		-9		$\mu\text{A}$
CMTI	Common-mode transient immunity	$ GND1 - GND2  = 1\text{kV}$	150			V/ns
<b>ANALOG OUTPUT</b>						
	Nominal gain			8.2		V/V
$V_{CMout}$	Common-mode output voltage		1.39	1.44	1.49	V
$V_{CLIPout}$	Clipping differential output voltage	$V_{OUT} = (V_{OUTP} - V_{OUTN})$ ; $ V_{IN}  =  V_{INP} - V_{INN}  >  V_{Clipping} $	-2.52	$\pm 2.49$	2.52	V
$V_{FAILSAFE}$	Failsafe differential output voltage	VDD1 missing	-2.63	-2.57	2.53	V
$R_{OUT}$	Output resistance	On OOUTP or OOUTN		<0.2		$\Omega$
	Output short-circuit current	On OOUTP or OOUTN, sourcing or sinking, INN = INP = GND1, outputs shorted to either GND2 or VDD2		11		mA
<b>DC ACCURACY</b>						
$V_{OS}$	Offset voltage <sup>(1) (2)</sup>	$T_A = 25^\circ\text{C}$ , INP = INN = GND1	-0.2	$\pm 0.01$	0.2	mV
TCV <sub>OS</sub>	Offset drift <sup>(1) (2) (4)</sup>		-2	$\pm 0.25$	2	$\mu\text{V}/^\circ\text{C}$
$E_G$	Gain error <sup>(1)</sup>	$T_A = 25^\circ\text{C}$	-0.25%	$\pm 0.04\%$	0.25%	
TCE <sub>G</sub>	Gain drift <sup>(1) (5)</sup>		-35	$\pm 5$	35	ppm/ $^\circ\text{C}$
	Nonlinearity		-0.04%		0.04%	
	Output noise	INP = INN = GND1, $f_{IN} = 0\text{Hz}$ , BW = 100kHz brickwall filter		400		$\mu\text{V}_{RMS}$
CMRR	Common-mode rejection ratio	$f_{IN} = 0\text{Hz}$ , $V_{CM min} \leq V_{CM} \leq V_{CM max}$		-100		dB
		$f_{IN} = 10\text{kHz}$ , $V_{CM min} \leq V_{CM} \leq V_{CM max}$		-87		
PSRR	Power-supply rejection ratio <sup>(2)</sup>	VDD1 DC PSRR, INP = INN = GND1, VDD1 from 3V to 5.5V		-89		dB
		VDD1 AC PSRR, INP = INN = GND1, VDD1 with 10kHz / 100mV ripple		-79		
		VDD2 DC PSRR, INP = INN = GND1, VDD2 from 3V to 5.5V		-110		
		VDD2 AC PSRR, INP = INN = GND1, VDD2 with 10kHz / 100mV ripple		-79		
<b>AC ACCURACY</b>						
BW	Output bandwidth		250	280		kHz
THD	Total harmonic distortion <sup>(3)</sup>	$f_{IN} = 10\text{kHz}$		-82		dB
SNR	Signal-to-noise ratio	$f_{IN} = 1\text{kHz}$ , BW = 10kHz	80.5	85		dB
		$f_{IN} = 10\text{kHz}$ , BW = 100kHz		77		
<b>POWER SUPPLY</b>						
IDD1	High-side supply current			5.4	6.7	mA
IDD2	Low-side supply current			6.4	9.9	mA
$V_{DD1UV}$	High-side undervoltage detection threshold	VDD1 rising	2.5	2.6	2.7	V
		VDD1 falling	1.9	2.0	2.1	

### 6.13 Electrical Characteristics (continued)

minimum and maximum specifications apply from  $T_A = -40^{\circ}\text{C}$  to  $+125^{\circ}\text{C}$ ,  $V_{DD1} = 3.0\text{V}$  to  $5.5\text{V}$ ,  $V_{DD2} = 3.0\text{V}$  to  $5.5\text{V}$ ,  $V_{INP} = -250\text{mV}$  to  $+250\text{mV}$ , and  $V_{INN} = 0\text{V}$ ; typical specifications are at  $T_A = 25^{\circ}\text{C}$ ,  $V_{DD1} = 5\text{V}$ , and  $V_{DD2} = 3.3\text{V}$  (unless otherwise noted)

PARAMETER		TEST CONDITIONS	MIN	TYP	MAX	UNIT
VDD2 <sub>UV</sub>	Low-side undervoltage detection threshold	VDD2 rising	2.3	2.5	2.7	V
		VDD2 falling	1.9	2.05	2.2	

- (1) The typical value includes one standard deviation (*sigma*) at nominal operating conditions.
- (2) This parameter is input referred.
- (3) THD is the ratio of the rms sum of the amplitudes of first five higher harmonics to the amplitude of the fundamental.
- (4) Offset error temperature drift is calculated using the box method, as described by the following equation:  
 $TCV_{OS} = (V_{OS,MAX} - V_{OS,MIN}) / TempRange$  where  $V_{OS,MAX}$  and  $V_{OS,MIN}$  refer to the maximum and minimum  $V_{OS}$  values measured within the temperature range ( $-40$  to  $125^{\circ}\text{C}$ ).
- (5) Gain error temperature drift is calculated using the box method, as described by the following equation:  
 $TCE_G (ppm) = ((E_{G,MAX} - E_{G,MIN}) / TempRange) \times 10^4$  where  $E_{G,MAX}$  and  $E_{G,MIN}$  refer to the maximum and minimum  $E_G$  values (in %) measured within the temperature range ( $-40$  to  $125^{\circ}\text{C}$ ).

### 6.14 Switching Characteristics

over operating ambient temperature range (unless otherwise noted)

PARAMETER		TEST CONDITIONS	MIN	TYP	MAX	UNIT
$t_r$	Output signal rise time			1.7		$\mu\text{s}$
$t_f$	Output signal fall time			1.7		$\mu\text{s}$
	$V_{INx}$ to $V_{OUTx}$ signal delay (50% - 10%)	Unfiltered output		0.8	1.3	$\mu\text{s}$
	$V_{INx}$ to $V_{OUTx}$ signal delay (50% - 50%)	Unfiltered output		1.6	2.1	$\mu\text{s}$
	$V_{INx}$ to $V_{OUTx}$ signal delay (50% - 90%)	Unfiltered output		2.5	3	$\mu\text{s}$
$t_{AS}$	Analog settling time	VDD1 step to 3.0V with VDD2 $\geq 3.0\text{V}$ , to $V_{OUTP}$ , $V_{OUTN}$ valid, 0.1% settling		20	100	$\mu\text{s}$

### 6.15 Timing Diagram

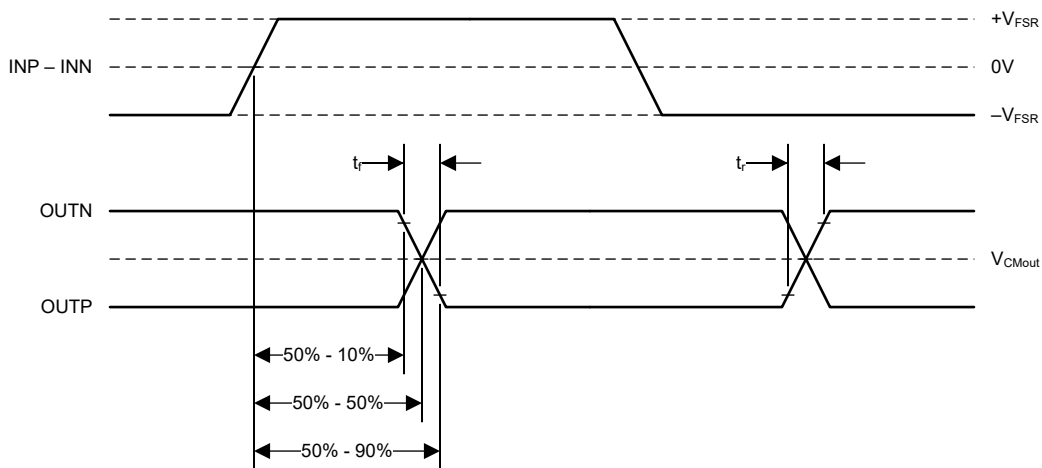
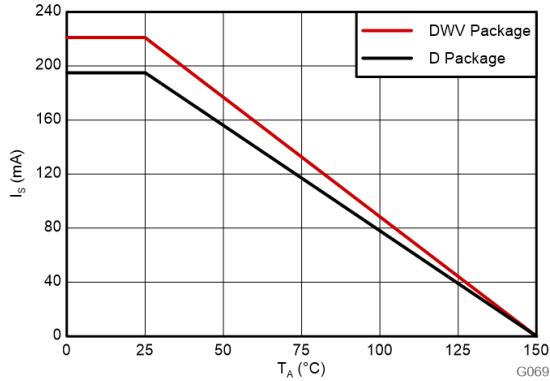
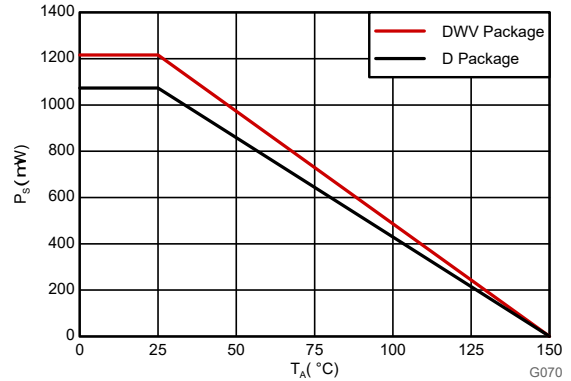


Figure 6-1. Rise, Fall, and Delay Time Waveforms

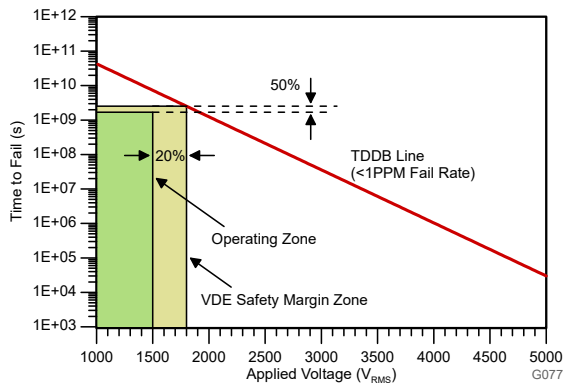
### 6.16 Insulation Characteristics Curves



**Figure 6-2. Thermal Derating Curve for Safety-Limiting Current per VDE**

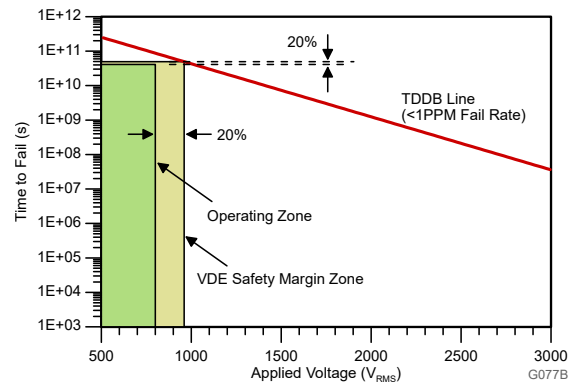


**Figure 6-3. Thermal Derating Curve for Safety-Limiting Power per VDE**



$T_A$  up to 150°C, stress-voltage frequency = 60Hz, isolation working voltage = 1500V<sub>RMS</sub>, projected operating lifetime ≥50 years

**Figure 6-4. Isolation Capacitor Lifetime Projection (Reinforced Isolation)**



$T_A$  up to 150°C, stress-voltage frequency = 60Hz, isolation working voltage = 800V<sub>RMS</sub>, projected operating lifetime >>100 years

**Figure 6-5. Isolation Capacitor Lifetime Projection (Basic Isolation)**

## 6.17 Typical Characteristics

at VDD1 = 5V, VDD2 = 3.3V, VINP = -250mV to 250mV, VINN = 0V, and  $f_{IN} = 10\text{kHz}$  (unless otherwise noted)

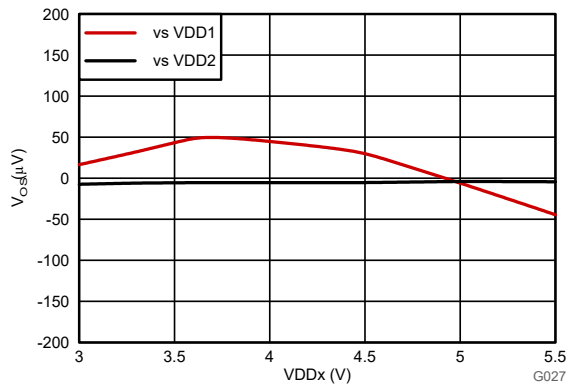


Figure 6-6. Input Offset Voltage vs Supply Voltage

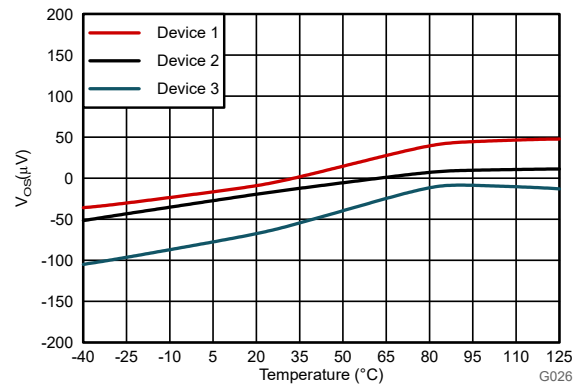


Figure 6-7. Input Offset Voltage vs Temperature

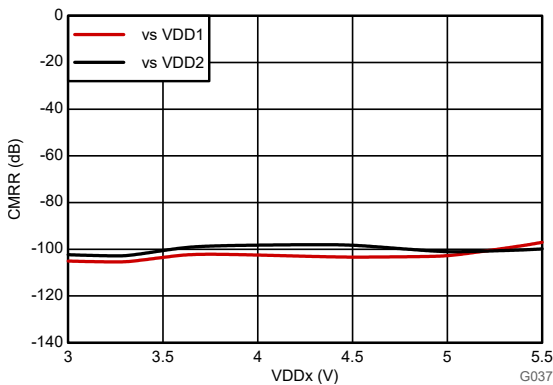


Figure 6-8. Common-Mode Rejection Ratio vs Supply Voltage

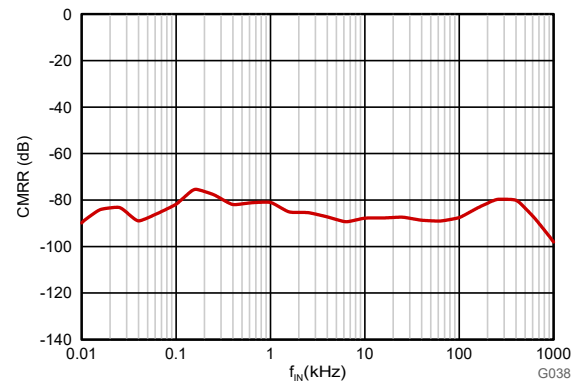


Figure 6-9. Common-Mode Rejection Ratio vs Input Frequency

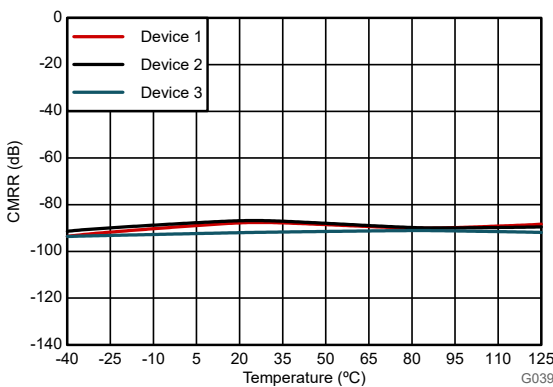


Figure 6-10. Common-Mode Rejection Ratio vs Temperature

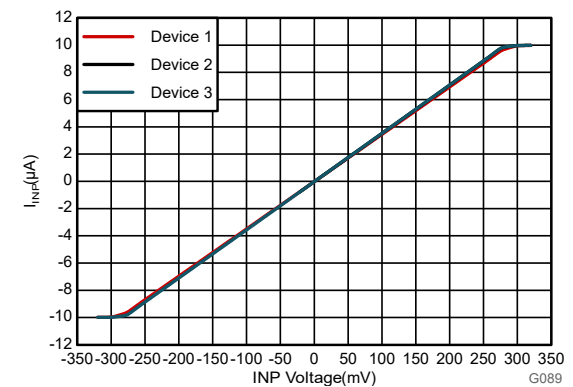
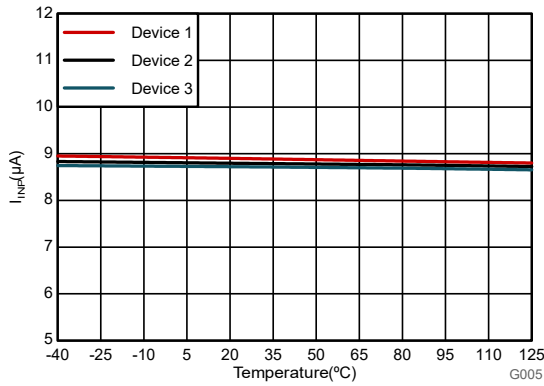


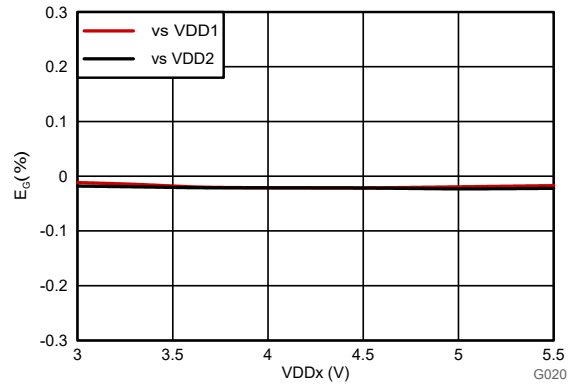
Figure 6-11. Input Current vs Input Voltage

### 6.17 Typical Characteristics (continued)

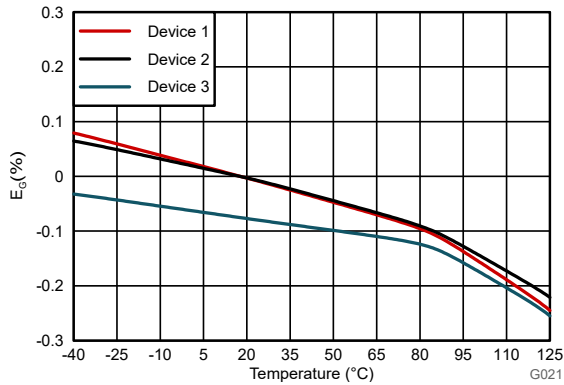
at VDD1 = 5V, VDD2 = 3.3V, VINP = -250mV to 250mV, VINN = 0V, and f<sub>IN</sub> = 10kHz (unless otherwise noted)



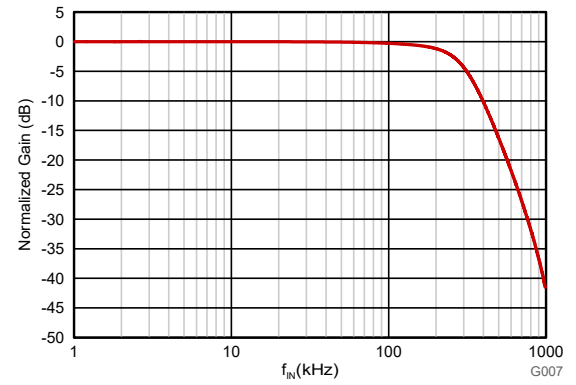
**Figure 6-12. Input Current vs Temperature**



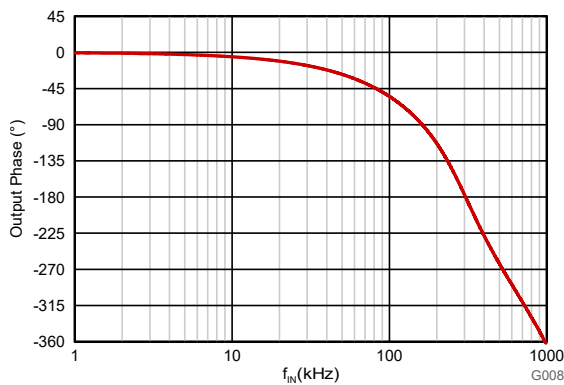
**Figure 6-13. Gain Error vs Supply Voltage**



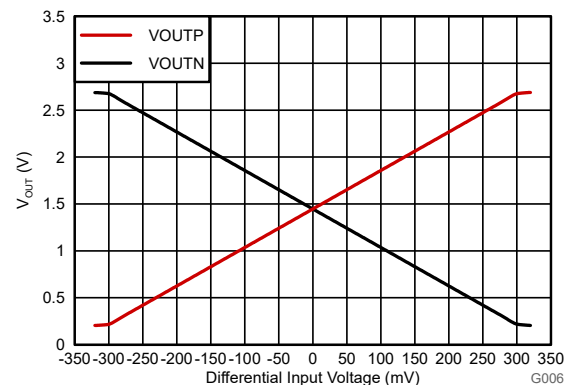
**Figure 6-14. Gain Error vs Temperature**



**Figure 6-15. Normalized Gain vs Input Frequency**



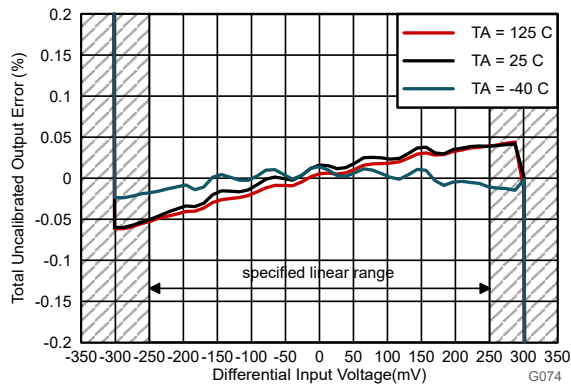
**Figure 6-16. Output Phase vs Input Frequency**



**Figure 6-17. Output Voltage vs Input Voltage**

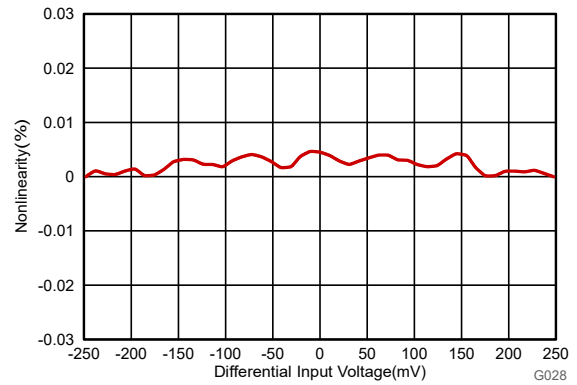
### 6.17 Typical Characteristics (continued)

at VDD1 = 5V, VDD2 = 3.3V, VINP = -250mV to 250mV, VINN = 0V, and f<sub>IN</sub> = 10kHz (unless otherwise noted)

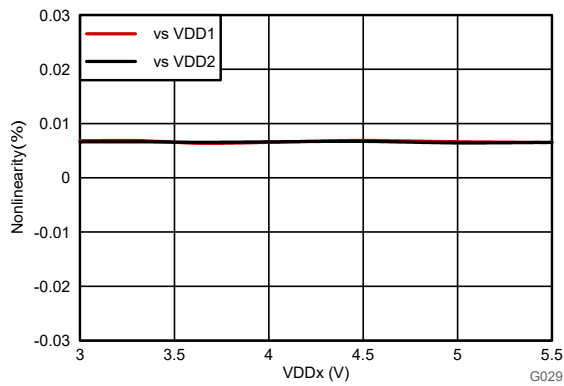


Total uncalibrated output error is defined as:  
 $(V_{OUT} / G - V_{IN}) / (V_{Clipping} \times 100)$ , where G is the nominal gain of the device (8.2V/V) and V<sub>Clipping</sub> is 0.32V

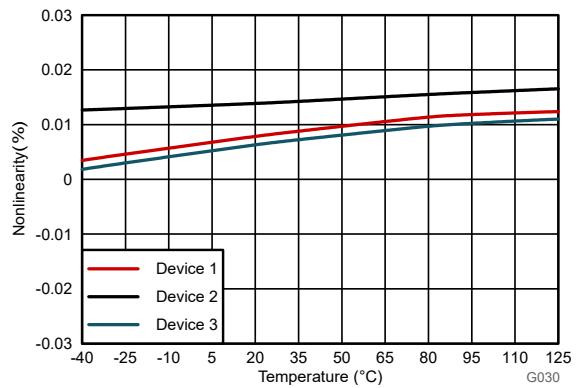
**Figure 6-18. Unadjusted Error vs Input Voltage**



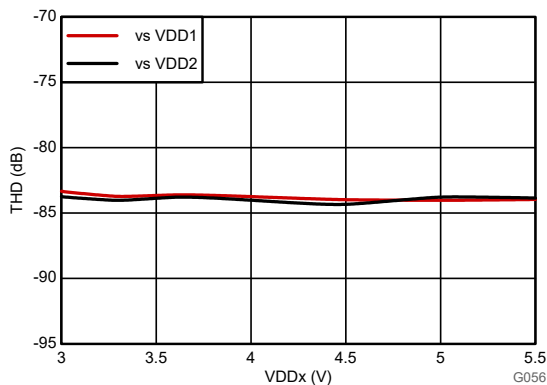
**Figure 6-19. Nonlinearity vs Input Voltage**



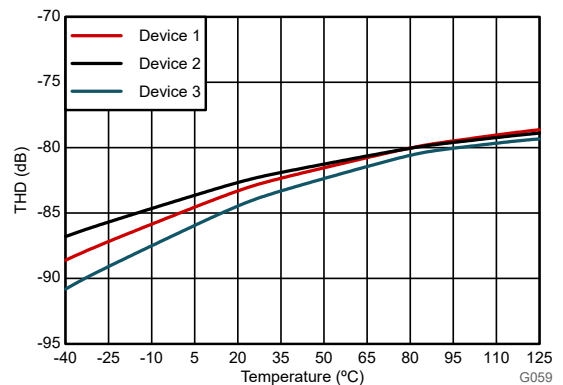
**Figure 6-20. Nonlinearity vs Supply Voltage**



**Figure 6-21. Nonlinearity vs Temperature**



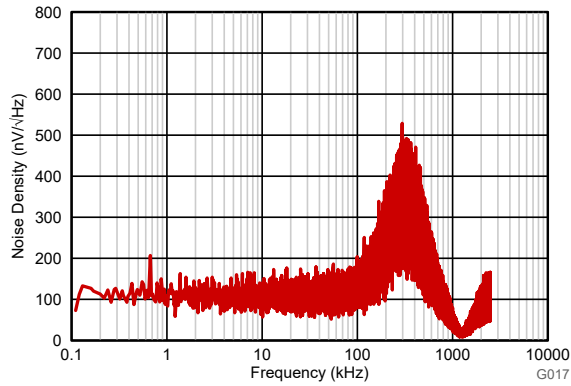
**Figure 6-22. Total Harmonic Distortion vs Supply Voltage**



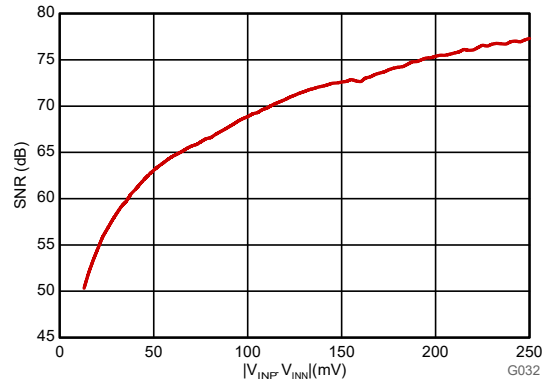
**Figure 6-23. Total Harmonic Distortion vs Temperature**

### 6.17 Typical Characteristics (continued)

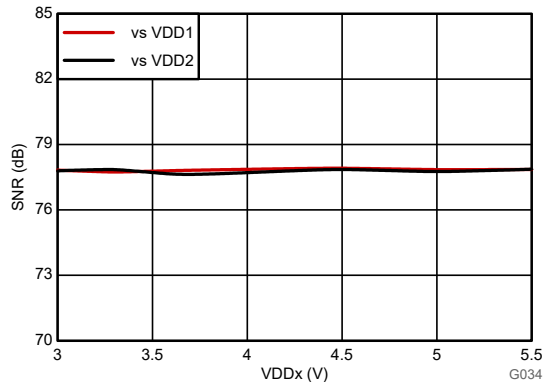
at VDD1 = 5V, VDD2 = 3.3V, VINP = -250mV to 250mV, VINN = 0V, and f<sub>IN</sub> = 10kHz (unless otherwise noted)



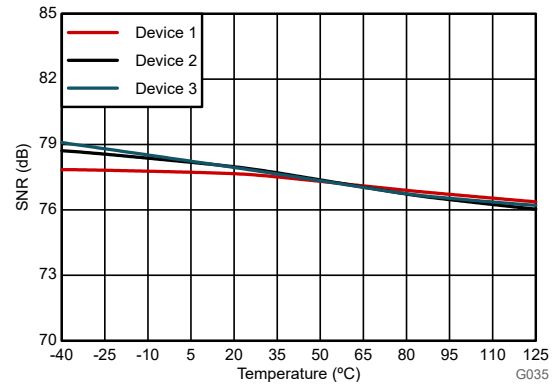
**Figure 6-24. Input-Referred Noise Density vs Frequency**



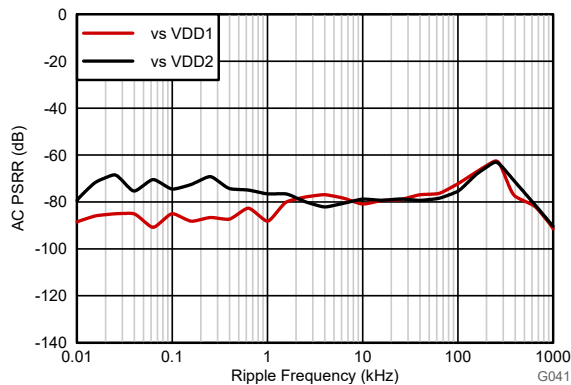
**Figure 6-25. Signal-to-Noise Ratio vs Input Voltage**



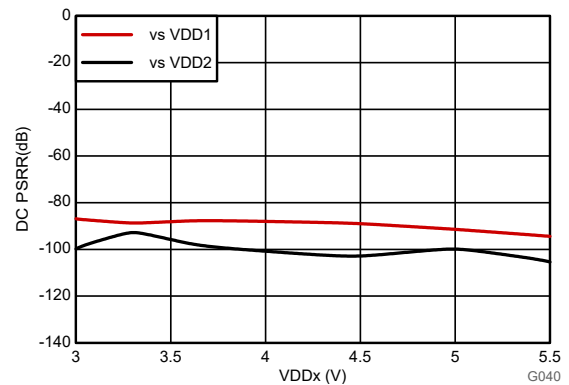
**Figure 6-26. Signal-to-Noise Ratio vs Supply Voltage**



**Figure 6-27. Signal-to-Noise Ratio vs Temperature**



**Figure 6-28. Power-Supply Rejection Ratio vs Ripple Frequency**



**Figure 6-29. Power-Supply Rejection Ratio vs Supply Voltage**

### 6.17 Typical Characteristics (continued)

at VDD1 = 5V, VDD2 = 3.3V, VINP = -250mV to 250mV, VINN = 0V, and  $f_{IN} = 10\text{kHz}$  (unless otherwise noted)

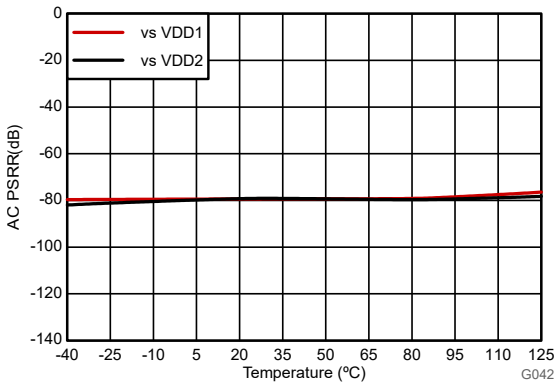


Figure 6-30. Power-Supply Rejection Ratio vs Temperature

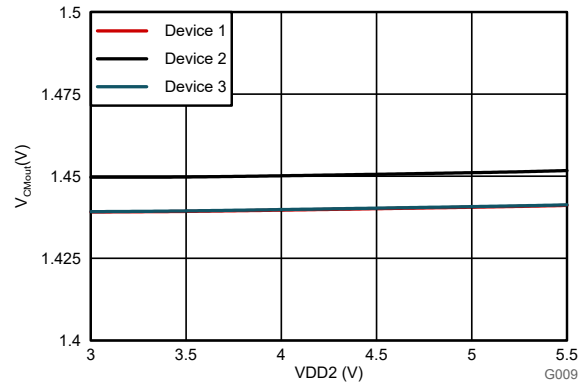


Figure 6-31. Output Common-Mode Voltage vs Low-Side Supply Voltage

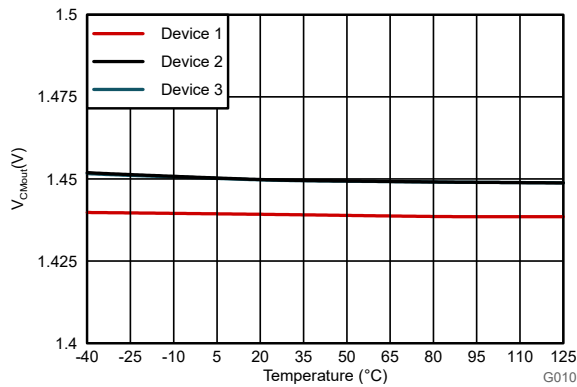


Figure 6-32. Output Common-Mode Voltage vs Temperature

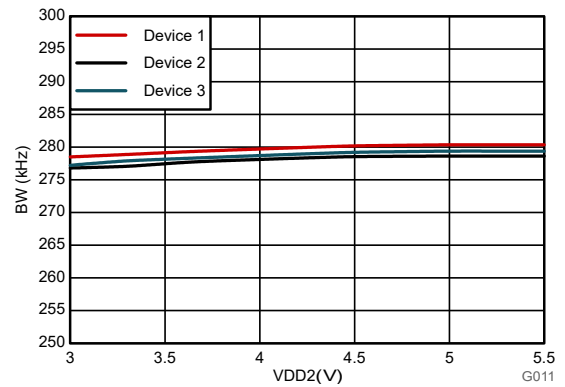


Figure 6-33. Output Bandwidth vs Low-Side Supply Voltage

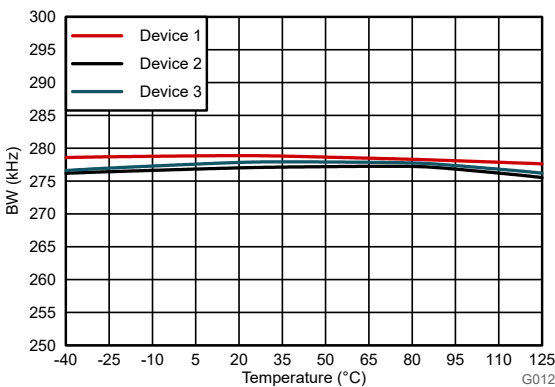


Figure 6-34. Output Bandwidth vs Temperature

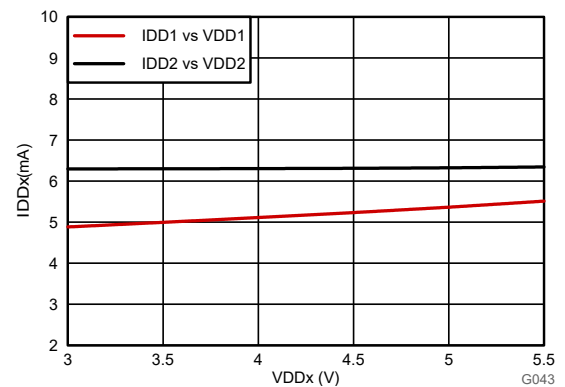


Figure 6-35. Supply Current vs Supply Voltage

### 6.17 Typical Characteristics (continued)

at VDD1 = 5V, VDD2 = 3.3V, VINP = -250mV to 250mV, VINN = 0V, and f<sub>IN</sub> = 10kHz (unless otherwise noted)

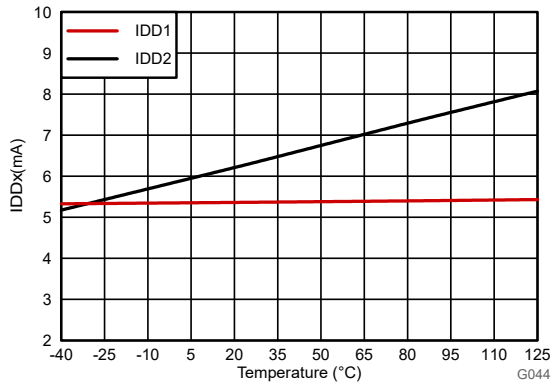


Figure 6-36. Supply Current vs Temperature

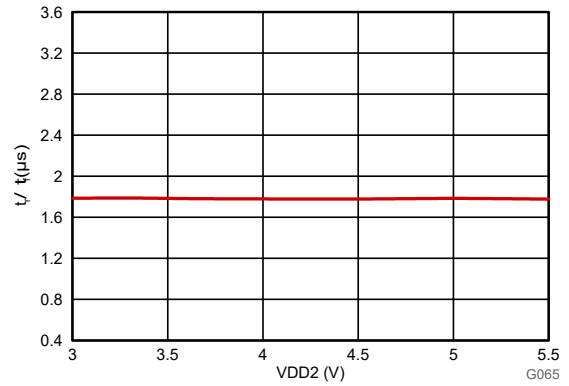


Figure 6-37. Output Rise and Fall Time vs Low-Side Supply

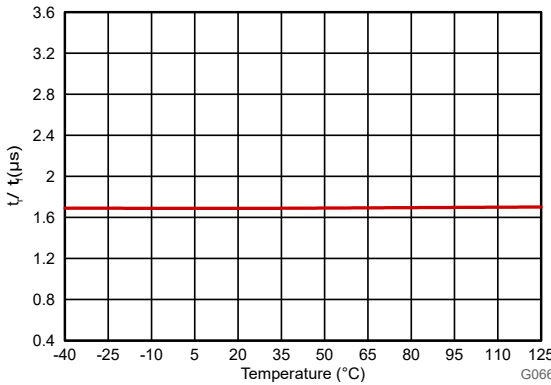


Figure 6-38. Output Rise and Fall Time vs Temperature

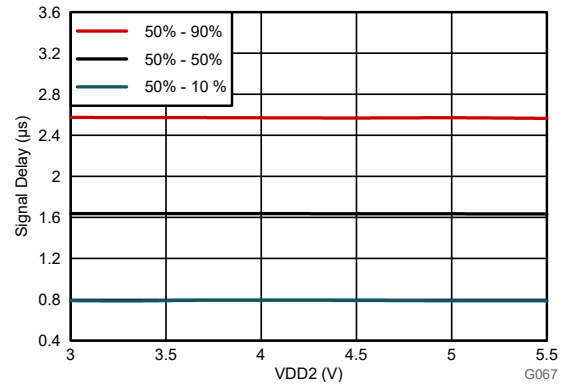


Figure 6-39. V<sub>IN</sub> to V<sub>OUT</sub> Signal Delay vs Low-Side Supply Voltage

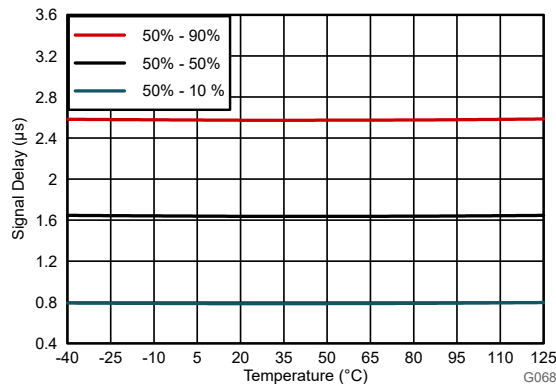


Figure 6-40. V<sub>IN</sub> to V<sub>OUT</sub> Signal Delay vs Temperature

## 7 Detailed Description

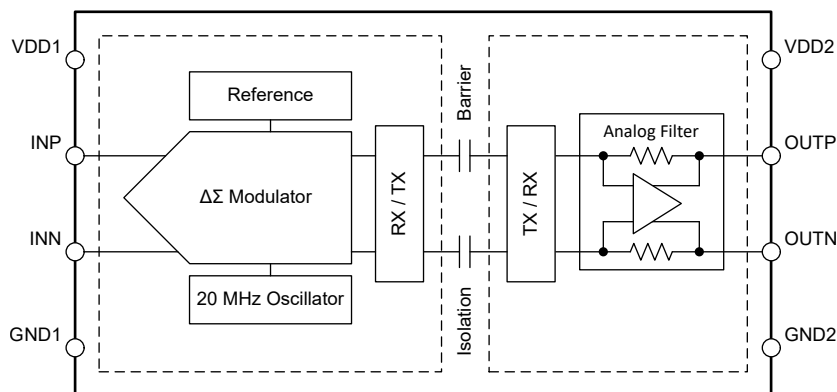
### 7.1 Overview

The AMC0x00D is a precision, galvanically isolated amplifier with a  $\pm 250\text{mV}$ , differential input and differential output. The input stage of the device drives a second-order, delta-sigma ( $\Delta\Sigma$ ) modulator. The modulator converts the analog input signal into a digital bitstream that is transferred across the isolation barrier that separates the high-side from the low-side.

On the low-side, the received bitstream is processed by a fourth-order analog filter that outputs a differential signal at the OUTP and OUTN pins. This differential output signal is proportional to the input signal.

The  $\text{SiO}_2$ -based, capacitive isolation barrier supports a high level of magnetic field immunity, as described in the [ISO72x Digital Isolator Magnetic-Field Immunity application note](#). The digital modulation used in the AMC0x00D transmits data across the isolation barrier. This modulation, and the isolation barrier characteristics, result in high reliability and high common-mode transient immunity.

### 7.2 Functional Block Diagram



## 7.3 Feature Description

### 7.3.1 Analog Input

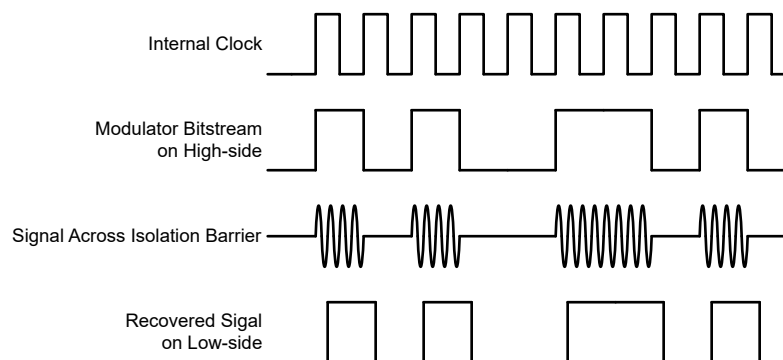
The high-impedance input buffer on the INP pin feeds a second-order, switched-capacitor, feed-forward  $\Delta\Sigma$  modulator. The modulator converts the analog signal into a bitstream that is transferred across the isolation barrier, as described in the [Isolation Channel Signal Transmission](#) section.

There are two restrictions on the analog input signal. First, if the input voltage exceeds the value specified in the [Absolute Maximum Ratings](#) table, the input current must be limited to 10mA. This limitation is caused by the device input electrostatic discharge (ESD) diodes turning on. Second, linearity and noise performance are specified only when the input voltage is within the linear full-scale range ( $V_{FSR}$ ).  $V_{FSR}$  is specified in the [Recommended Operating Conditions](#) table.

### 7.3.2 Isolation Channel Signal Transmission

As shown in [Figure 7-1](#), the AMC0x00D uses an on-off keying (OOK) modulation scheme to transmit the modulator output bitstream across the SiO<sub>2</sub>-based isolation barrier. The transmit driver (TX) is illustrated in the [Functional Block Diagram](#). TX transmits an internally generated, high-frequency carrier across the isolation barrier to represent a digital *one*. However, TX does not send a signal to represent a digital *zero*. The nominal frequency of the carrier used inside the AMC0x00D is 480MHz.

The receiver (RX) on the other side of the isolation barrier recovers and demodulates the signal and provides the input to the analog filter. The AMC0x00D transmission channel is optimized to achieve the highest level of common-mode transient immunity (CMTI) and the lowest level of radiated emissions. The high-frequency carrier and RX/TX buffer switching cause these emissions.



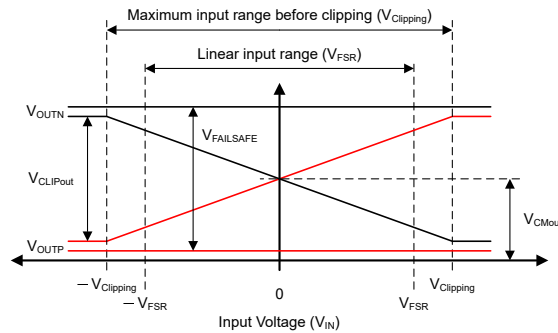
**Figure 7-1. OOK-Based Modulation Scheme**

### 7.3.3 Analog Output

The AMC0x00D provides a differential analog output voltage on the OUTP and OUTN pins proportional to the input voltage. For input voltages in the range from  $V_{FSR, MIN}$  to  $V_{FSR, MAX}$ , the device has a linear response with an output voltage equal to:

$$V_{OUT} = V_{OUTP} - V_{OUTN} = 8.2 \times V_{IN} = 8.2 \times (V_{INP} - V_{INN}) \quad (1)$$

At zero input, both pins output the same common-mode output voltage  $V_{CMout}$ , as specified in the [Electrical Characteristics](#) table. For absolute input voltages greater than  $|V_{FSR}|$  but less than  $|V_{Clipping}|$ , the differential output voltage continues to increase in magnitude, but with reduced linearity performance. The outputs saturate at a differential output voltage of  $V_{CLIPout}$ , as shown in [Figure 7-2](#), if the input voltage exceeds the  $V_{Clipping}$  value.



**Figure 7-2. Input to Output Transfer Curve of the AMC0x00D**

The AMC0x00D output offers a fail-safe feature that simplifies diagnostics on a system level. [Figure 7-2](#) shows the behavior in fail-safe mode, in which the AMC0x00D outputs a negative differential output voltage that does not occur under normal operating conditions. The fail-safe output is active:

- When the high-side supply VDD1 of the AMC0x00D device is missing
- When the high-side supply VDD1 falls below the undervoltage threshold  $VDD1_{UV}$

Use the maximum  $V_{FAILSAFE}$  voltage specified in the [Electrical Characteristics](#) table as a reference value for fail-safe detection on a system level.

## 7.4 Device Functional Modes

The AMC0x00D operates in one of the following states:

- Off-state: The low-side supply (VDD2) is below the  $VDD2_{UV}$  threshold. The device is not responsive. OUP and OUTN are in Hi-Z state. Internally, OUP and OUTN are clamped to VDD2 and GND2 by ESD protection diodes.
- Missing high-side supply: The low-side of the device (VDD2) is supplied and within recommended operating conditions. The high-side supply (VDD1) is below the  $VDD1_{UV}$  threshold. The device outputs the  $V_{FAILSAFE}$  voltage.
- Analog input overrange (positive full-scale input): VDD1 and VDD2 are within recommended operating conditions but the analog input voltage  $V_{IN}$  is above the maximum clipping voltage  $V_{Clipping, MAX}$ . The device outputs positive  $V_{CLIPout}$ .
- Analog input underrange (negative full-scale input): VDD1 and VDD2 are within recommended operating conditions but the analog input voltage  $V_{IN}$  is below the minimum clipping voltage  $V_{Clipping, MIN}$ . The device outputs negative  $V_{CLIPout}$ .
- Normal operation: VDD1, VDD2, and  $V_{IN}$  are within the recommended operating conditions. The device outputs a differential voltage that is proportional to the input voltage.

Table 7-1 lists the operating modes.

**Table 7-1. Device Operational Modes**

OPERATING CONDITION	VDD1	VDD2	$V_{IN}$	DEVICE RESPONSE
Off	Don't care	$VDD2 < VDD2_{UV}$	Don't care	OUP and OUTN are in Hi-Z state. Internally, OUP and OUTN are clamped to VDD2 and GND2 by ESD protection diodes.
Missing high-side supply	$VDD1 < VDD1_{UV}$	Valid <sup>(1)</sup>	Don't care	The device outputs the $V_{FAILSAFE}$ voltage.
Input overrange	Valid <sup>(1)</sup>	Valid <sup>(1)</sup>	$V_{IN} > V_{Clipping, MAX}$	The device outputs positive $V_{CLIPout}$ .
Input underrange	Valid <sup>(1)</sup>	Valid <sup>(1)</sup>	$V_{IN} < V_{Clipping, MIN}$	The device outputs negative $V_{CLIPout}$ .
Normal operation	Valid <sup>(1)</sup>	Valid <sup>(1)</sup>	Valid <sup>(1)</sup>	The device outputs a differential voltage that is proportional to the input voltage.

(1) *Valid* denotes operation within the recommended operating conditions.

## 8 Application and Implementation

### Note

Information in the following applications sections is not part of the TI component specification, and TI does not warrant its accuracy or completeness. TI's customers are responsible for determining suitability of components for their purposes, as well as validating and testing their design implementation to confirm system functionality.

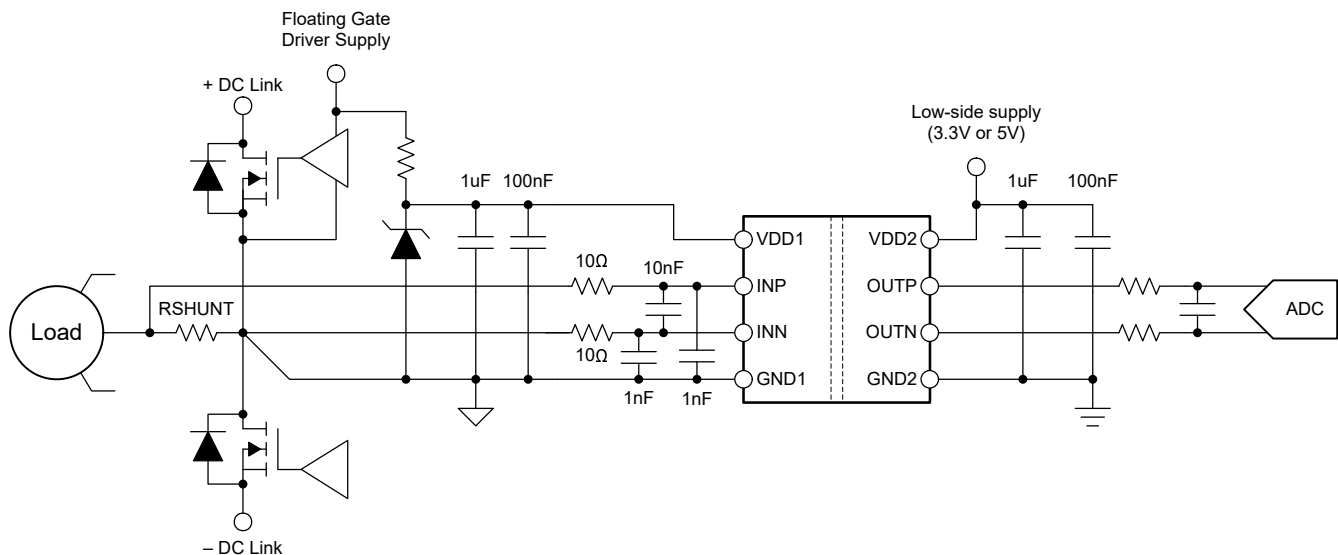
### 8.1 Application Information

The AMC0x00D has low analog input voltage range, high accuracy, low temperature drift, and high common-mode transient immunity. The AMC0x00D is primarily designed for shunt-based current-sensing applications where accurate current monitoring is required in the presence of high common-mode voltages. The AMC0x00D is preferred for isolated current sensing in motor drives, frequency inverters, and uninterruptible power-supply applications.

### 8.2 Typical Application

The following image shows the AMC0x00D in a typical application. The load current flowing through an external shunt resistor RSHUNT produces a voltage drop. The AMC0x00D high-side circuitry senses the voltage drop across the shunt resistor, then digitizes and transfers data across the isolation barrier to the low side. Low-side circuitry reconstructs the digitized data into an analog signal and provides the signal as a differential voltage on the output pins.

The differential input, differential output, and high common-mode transient immunity (CMTI) of the AMC0x00D provide reliable and accurate operation even in high-noise environments.



**Figure 8-1. Using the AMC0x00D for Current Sensing in a Typical Application**

### 8.2.1 Design Requirements

Table 8-1 lists the parameters for this typical application.

**Table 8-1. Design Requirements**

PARAMETER	VALUE
High-side supply voltage	3.3V or 5V
Low-side supply voltage	3.3V or 5V
Voltage drop across RSHUNT for a linear response	±250mV(maximum)

### 8.2.2 Detailed Design Procedure

In the *Typical Application* figure, the high-side power supply (VDD1) for the AMC0x00D is derived from the floating power supply of the upper gate driver.

The floating ground reference (GND1) is derived from the end of the shunt resistor that is connected to the negative input of the AMC0x00D (INN). If a four-pin shunt is used, the inputs of the AMC0x00D are connected to the inner leads. GND1 is then connected to the outer lead on the INN-side of the shunt. To minimize offset and improve accuracy, route the ground connection as a separate trace that connects directly to the shunt resistor. Do not short GND1 to INN directly at the device input; see the *Layout Example* section for more details.

Use Ohm's Law to calculate the voltage drop across the shunt resistor ( $V_{SHUNT}$ ) for the desired measured current:

$$V_{SHUNT} = I \times RSHUNT \tag{2}$$

Select a RSHUNT value to satisfy the following two conditions:

- First, the voltage drop caused by the nominal current range does not exceed the recommended differential input voltage range of  $V_{SHUNT} \leq \pm 250\text{mV}$ .
- Secondly, the voltage drop caused by the maximum allowed overcurrent does not exceed the input voltage that causes a clipping output. Keep  $V_{SHUNT} \leq V_{Clipping}$ .

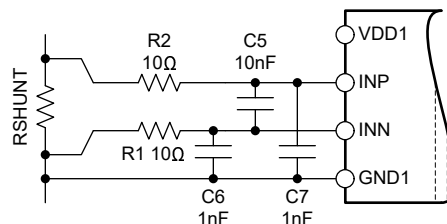
#### 8.2.2.1 Input Filter Design

Place a differential RC filter (R1, R2, C5) in front of the isolated amplifier to improve signal-to-noise performance of the signal path. Design the input filter such that:

- The cutoff frequency of the filter is at least one order of magnitude lower than the sampling frequency (20MHz) of the  $\Delta\Sigma$  modulator
- The input bias current does not generate significant voltage drop across the DC impedance of the input filter
- The impedances measured from the analog inputs are equal

Place capacitors C6 and C7 to improve common-mode rejection at high frequencies (>1MHz) and to improve offset voltage performance. For best performance, verify C6 matches the value of C7 and that both capacitors are 10 to 20 times lower in value than C5. NP0-type capacitors offer low temperature drift and low voltage coefficients, and are preferred for common-mode filtering.

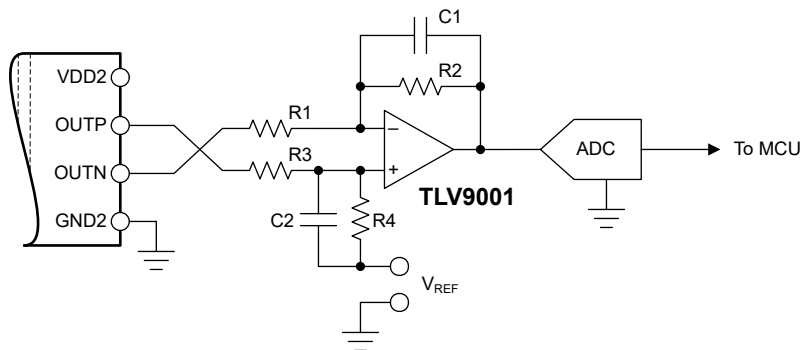
For most applications, the structure shown in Figure 8-2 achieves excellent performance.



**Figure 8-2. Input Filter**

### 8.2.2.2 Differential-to-Single-Ended Output Conversion

Many systems use ADCs with single-ended inputs that cannot connect directly to the differential output of the AMC0x00D. Figure 8-3 shows a circuit for converting the differential output signal into a single-ended signal in front of the ADC. For  $R1 = R3$  and  $R2 = R4$ , the output voltage equals  $(R2 / R1) \times (V_{OUTP} - V_{OUTN}) + V_{REF}$ . For  $C1 = C2$  the bandwidth of the filter becomes  $1 / (2 \times \pi \times C1 \times R1)$ . Configure the bandwidth of the filter to match the bandwidth requirement of the system. For best linearity, use capacitors with low voltage coefficients (such as NP0-type capacitors). For most applications,  $R1 = R2 = R3 = R4 = 3.3k\Omega$  and  $C1 = C2 = 330pF$  yield good performance.



**Figure 8-3. Connecting the AMC0x00D Output to a Single-Ended Input ADC**

The following reference guides provide further information on the general procedure to design the filtering and driving stages of SAR ADCs. These reference guides are available for download at [www.ti.com](http://www.ti.com).

- [18-Bit, 1MSPS Data Acquisition Block \(DAQ\) Optimized for Lowest Distortion and Noise reference guide](#)
- [18-Bit Data Acquisition Block \(DAQ\) Optimized for Lowest Power reference guide](#)

### 8.2.3 Application Curve

One important aspect of power-stage design is the effective detection of an overcurrent condition to protect the switching devices and passive components from damage. To power off the system quickly in the event of an overcurrent condition, the isolated amplifier is required to have low signal delay. Figure 8-4 shows the typical full-scale step response of the AMC0x00D.

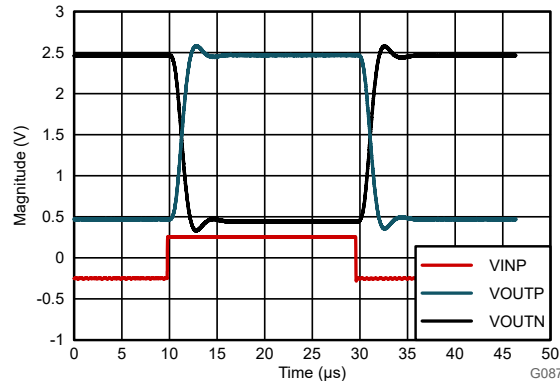


Figure 8-4. Step Response of the AMC0x00D

### 8.3 Best Design Practices

Place a minimum 10nF capacitor at the device input (from INP to INN). This capacitor helps avoid voltage droop at the input during the sampling period of the switched-capacitor input stage.

Do not short GND1 to INN directly at the device input. For best accuracy, route the ground connection as a separate trace that connects directly to the shunt resistor. See the [Layout Example](#) section for more details.

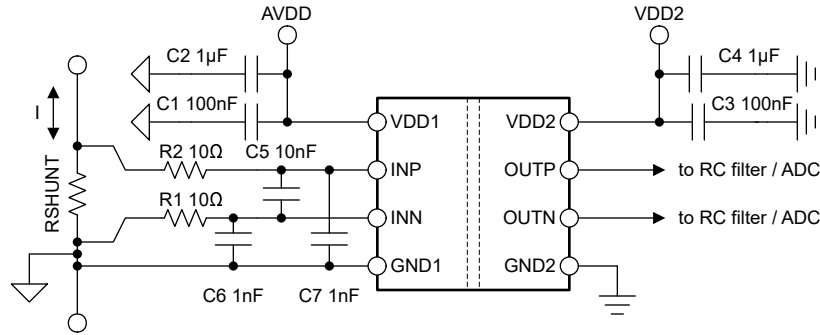
Do not leave the inputs of the AMC0x00D unconnected (floating) when the device is powered up. If the device inputs are left floating, the input bias current potentially drives the inputs to a positive value that exceeds the operating common-mode input voltage. This condition causes the device to output the fail-safe voltage described in the [Analog Output](#) section.

Connect the high-side ground (GND1) to INN, either by a hard short or through a resistive path. A DC current path between INN and GND1 is required to define the input common-mode voltage. Do not exceed the input common-mode range specified in the [Recommended Operating Conditions](#) table.

### 8.4 Power Supply Recommendations

In a typical application, the high-side power supply (VDD1) for the AMC0x00D is generated from the low-side supply (VDD2) by an isolated DC/DC converter. A low-cost option is based on the push-pull driver [SN6501](#) and a transformer that supports the desired isolation voltage ratings.

The AMC0x00D does not require any specific power-up sequencing. The high-side power supply (VDD1) is decoupled with a low-ESR, 100nF capacitor (C1) parallel to a low-ESR, 1µF capacitor (C2). The low-side power supply (VDD2) is equally decoupled with a low-ESR, 100nF capacitor (C3) parallel to a low-ESR, 1µF capacitor (C4). Place all four capacitors (C1, C2, C3, and C4) as close to the device as possible. Figure 8-5 shows a decoupling diagram for the AMC0x00D.



**Figure 8-5. Decoupling of the AMC0x00D**

Verify capacitors provide adequate *effective* capacitance under the applicable DC bias conditions experienced in the application. Multilayer ceramic capacitors (MLCC) typically exhibit only a fraction of the nominal capacitance under real-world conditions. Consider this factor when selecting these capacitors. This issue is especially acute in low-profile capacitors, where the dielectric field strength is higher than in taller components. Reputable capacitor manufacturers provide capacitance versus DC bias curves that greatly simplify component selection.

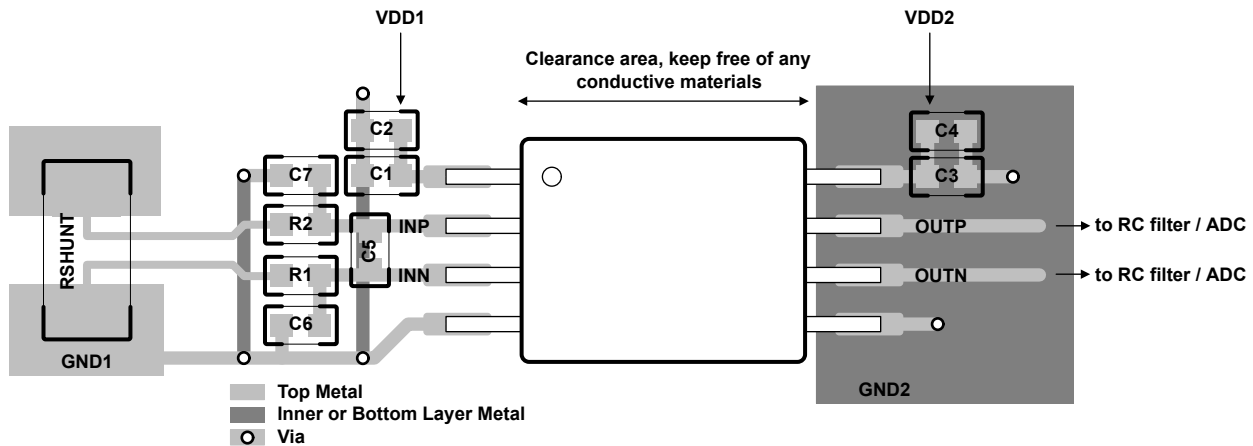
## 8.5 Layout

### 8.5.1 Layout Guidelines

The [Layout Example](#) section details a layout recommendation with the critical placement of the decoupling capacitors (as close as possible to the AMC0x00D supply pins). This example also depicts the placement of other components required by the device.

### 8.5.2 Layout Example

**Figure 8-6. Recommended Layout of the AMC0x00D**



## 9 Device and Documentation Support

### 9.1 Documentation Support

#### 9.1.1 Related Documentation

For related documentation, see the following:

- Texas Instruments, [Isolation Glossary application note](#)
- Texas Instruments, [Semiconductor and IC Package Thermal Metrics application note](#)
- Texas Instruments, [ISO72x Digital Isolator Magnetic-Field Immunity application note](#)
- Texas Instruments, [TLV900x Low-Power, RRIO, 1MHz Operational Amplifier for Cost-Sensitive Systems data sheet](#)
- Texas Instruments, [18-Bit, 1MSPS Data Acquisition Block \(DAQ\) Optimized for Lowest Distortion and Noise reference guide](#)
- Texas Instruments, [18-Bit, 1MSPS Data Acquisition Block \(DAQ\) Optimized for Lowest Power reference guide](#)
- Texas Instruments, [Isolated Amplifier Voltage Sensing Excel Calculator design tool](#)
- Texas Instruments, [Isolated Amplifier Current Sensing Excel Calculator design tool](#)

### 9.2 Receiving Notification of Documentation Updates

To receive notification of documentation updates, navigate to the device product folder on [ti.com](http://ti.com). Click on *Notifications* to register and receive a weekly digest of any product information that has changed. For change details, review the revision history included in any revised document.

### 9.3 Support Resources

[TI E2E™ support forums](#) are an engineer's go-to source for fast, verified answers and design help — straight from the experts. Search existing answers or ask your own question to get the quick design help you need.

Linked content is provided "AS IS" by the respective contributors. They do not constitute TI specifications and do not necessarily reflect TI's views; see TI's [Terms of Use](#).

### 9.4 Trademarks

TI E2E™ is a trademark of Texas Instruments.  
All trademarks are the property of their respective owners.

### 9.5 Electrostatic Discharge Caution



This integrated circuit can be damaged by ESD. Texas Instruments recommends that all integrated circuits be handled with appropriate precautions. Failure to observe proper handling and installation procedures can cause damage.

ESD damage can range from subtle performance degradation to complete device failure. Precision integrated circuits may be more susceptible to damage because very small parametric changes could cause the device not to meet its published specifications.

### 9.6 Glossary

[TI Glossary](#) This glossary lists and explains terms, acronyms, and definitions.

## 10 Revision History

NOTE: Page numbers for previous revisions may differ from page numbers in the current version.

### Changes from September 15, 2025 to June 8, 2026 (from Revision \* (September 2025) to Revision A (June 2026))

	<b>Page</b>
• Deleted Product Preview Information (not Production Data) tag for AMC0200D .....	1
• Added VDE and UL certificate numbers.....	10

## 11 Mechanical, Packaging, and Orderable Information

The following pages include mechanical, packaging, and orderable information. This information is the most current data available for the designated devices. This data is subject to change without notice and revision of this document. For browser-based versions of this data sheet, refer to the left-hand navigation.

**PACKAGING INFORMATION**

Orderable part number	Status (1)	Material type (2)	Package   Pins	Package qty   Carrier	RoHS (3)	Lead finish/ Ball material (4)	MSL rating/ Peak reflow (5)	Op temp (°C)	Part marking (6)
<a href="#">AMC0300DDWVR</a>	Active	Production	SOIC (DWV)   8	1000   LARGE T&R	Yes	NIPDAU	Level-2-260C-1 YEAR	-40 to 125	C0300D

(1) **Status:** For more details on status, see our [product life cycle](#).

(2) **Material type:** When designated, preproduction parts are prototypes/experimental devices, and are not yet approved or released for full production. Testing and final process, including without limitation quality assurance, reliability performance testing, and/or process qualification, may not yet be complete, and this item is subject to further changes or possible discontinuation. If available for ordering, purchases will be subject to an additional waiver at checkout, and are intended for early internal evaluation purposes only. These items are sold without warranties of any kind.

(3) **RoHS values:** Yes, No, RoHS Exempt. See the [TI RoHS Statement](#) for additional information and value definition.

(4) **Lead finish/Ball material:** Parts may have multiple material finish options. Finish options are separated by a vertical ruled line. Lead finish/Ball material values may wrap to two lines if the finish value exceeds the maximum column width.

(5) **MSL rating/Peak reflow:** The moisture sensitivity level ratings and peak solder (reflow) temperatures. In the event that a part has multiple moisture sensitivity ratings, only the lowest level per JEDEC standards is shown. Refer to the shipping label for the actual reflow temperature that will be used to mount the part to the printed circuit board.

(6) **Part marking:** There may be an additional marking, which relates to the logo, the lot trace code information, or the environmental category of the part.

Multiple part markings will be inside parentheses. Only one part marking contained in parentheses and separated by a "-" will appear on a part. If a line is indented then it is a continuation of the previous line and the two combined represent the entire part marking for that device.

**Important Information and Disclaimer:**The information provided on this page represents TI's knowledge and belief as of the date that it is provided. TI bases its knowledge and belief on information provided by third parties, and makes no representation or warranty as to the accuracy of such information. Efforts are underway to better integrate information from third parties. TI has taken and continues to take reasonable steps to provide representative and accurate information but may not have conducted destructive testing or chemical analysis on incoming materials and chemicals. TI and TI suppliers consider certain information to be proprietary, and thus CAS numbers and other limited information may not be available for release.

In no event shall TI's liability arising out of such information exceed the total purchase price of the TI part(s) at issue in this document sold by TI to Customer on an annual basis.

**OTHER QUALIFIED VERSIONS OF AMC0300D :**

- Automotive : [AMC0300D-Q1](#)

NOTE: Qualified Version Definitions:

- Automotive - Q100 devices qualified for high-reliability automotive applications targeting zero defects

**TAPE AND REEL INFORMATION**

**QUADRANT ASSIGNMENTS FOR PIN 1 ORIENTATION IN TAPE**


\*All dimensions are nominal

Device	Package Type	Package Drawing	Pins	SPQ	Reel Diameter (mm)	Reel Width W1 (mm)	A0 (mm)	B0 (mm)	K0 (mm)	P1 (mm)	W (mm)	Pin1 Quadrant
AMC0300DDWVR	SOIC	DWV	8	1000	330.0	16.4	12.15	6.2	3.05	16.0	16.0	Q1

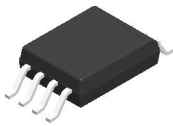
**TAPE AND REEL BOX DIMENSIONS**


\*All dimensions are nominal

Device	Package Type	Package Drawing	Pins	SPQ	Length (mm)	Width (mm)	Height (mm)
AMC0300DDWVR	SOIC	DWV	8	1000	353.0	353.0	32.0

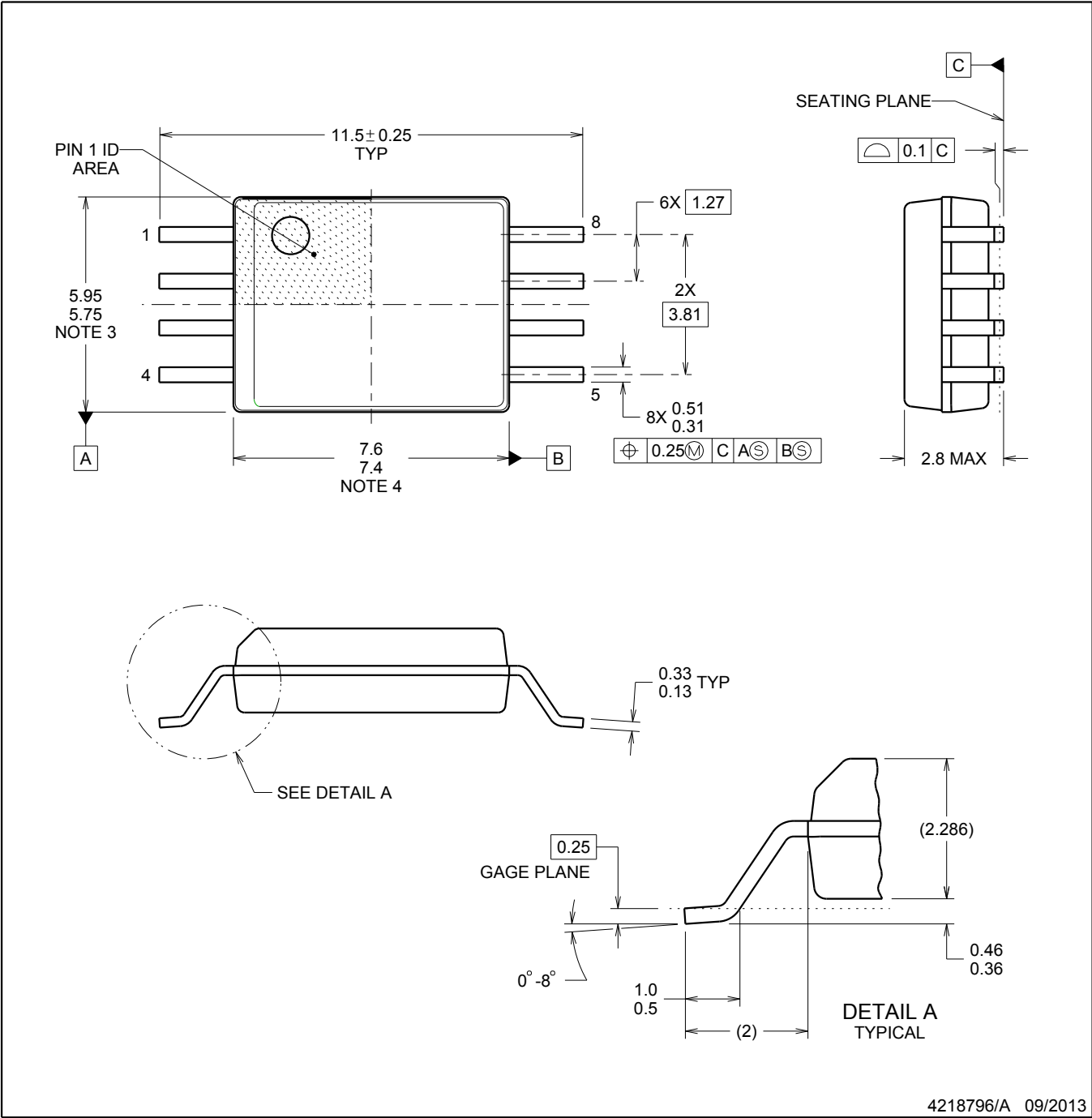
# PACKAGE OUTLINE

DWV0008A



SOIC - 2.8 mm max height

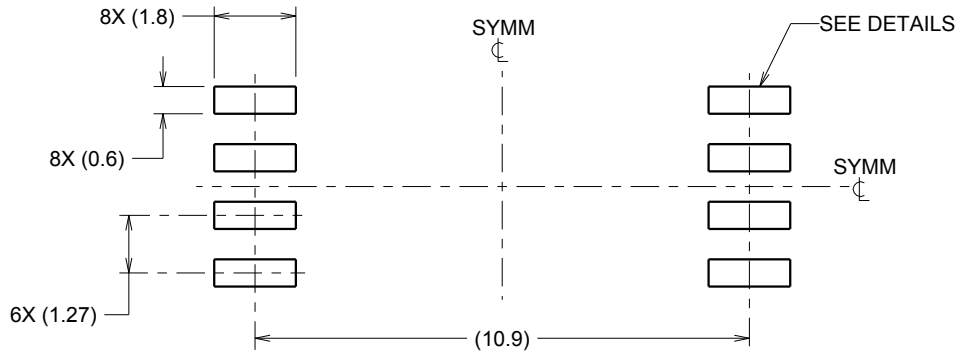
SOIC



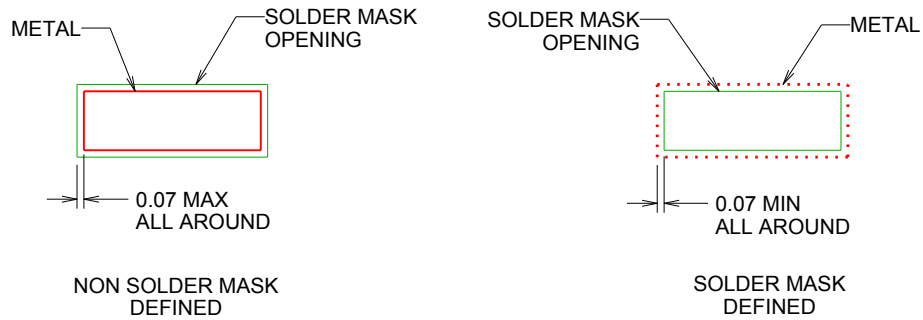
4218796/A 09/2013

**NOTES:**

1. All linear dimensions are in millimeters. Dimensions in parenthesis are for reference only. Dimensioning and tolerancing per ASME Y14.5M.
2. This drawing is subject to change without notice.
3. This dimension does not include mold flash, protrusions, or gate burrs. Mold flash, protrusions, or gate burrs shall not exceed 0.15 mm, per side.
4. This dimension does not include interlead flash. Interlead flash shall not exceed 0.25 mm, per side.



LAND PATTERN EXAMPLE  
9.1 mm NOMINAL CLEARANCE/CREEPAGE  
SCALE:6X

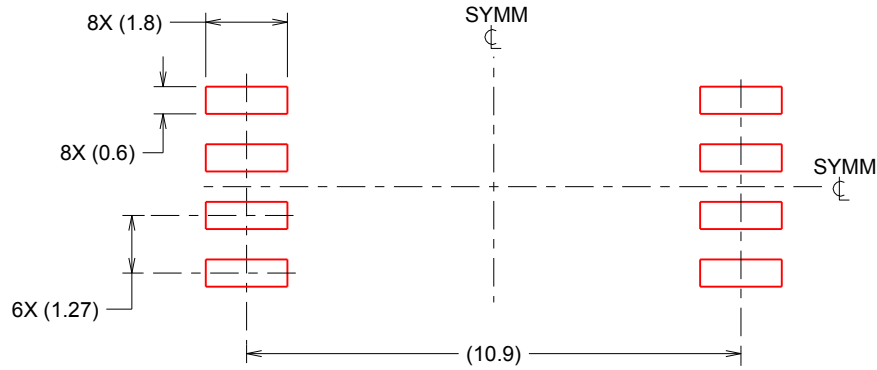


SOLDER MASK DETAILS

4218796/A 09/2013

NOTES: (continued)

- 5. Publication IPC-7351 may have alternate designs.
- 6. Solder mask tolerances between and around signal pads can vary based on board fabrication site.



SOLDER PASTE EXAMPLE  
 BASED ON 0.125 mm THICK STENCIL  
 SCALE:6X

4218796/A 09/2013

NOTES: (continued)

- 7. Laser cutting apertures with trapezoidal walls and rounded corners may offer better paste release. IPC-7525 may have alternate design recommendations.
- 8. Board assembly site may have different recommendations for stencil design.



# EXAMPLE BOARD LAYOUT

D0008A

SOIC - 1.75 mm max height

SMALL OUTLINE INTEGRATED CIRCUIT



LAND PATTERN EXAMPLE  
EXPOSED METAL SHOWN  
SCALE:8X



SOLDER MASK DETAILS

4214825/C 02/2019

NOTES: (continued)

- 6. Publication IPC-7351 may have alternate designs.
- 7. Solder mask tolerances between and around signal pads can vary based on board fabrication site.

# EXAMPLE STENCIL DESIGN

D0008A

SOIC - 1.75 mm max height

SMALL OUTLINE INTEGRATED CIRCUIT



SOLDER PASTE EXAMPLE  
BASED ON .005 INCH [0.125 MM] THICK STENCIL  
SCALE:8X

4214825/C 02/2019

NOTES: (continued)

8. Laser cutting apertures with trapezoidal walls and rounded corners may offer better paste release. IPC-7525 may have alternate design recommendations.
9. Board assembly site may have different recommendations for stencil design.

## IMPORTANT NOTICE AND DISCLAIMER

TI PROVIDES TECHNICAL AND RELIABILITY DATA (INCLUDING DATASHEETS), DESIGN RESOURCES (INCLUDING REFERENCE DESIGNS), APPLICATION OR OTHER DESIGN ADVICE, WEB TOOLS, SAFETY INFORMATION, AND OTHER RESOURCES "AS IS" AND WITH ALL FAULTS, AND DISCLAIMS ALL WARRANTIES, EXPRESS AND IMPLIED, INCLUDING WITHOUT LIMITATION ANY IMPLIED WARRANTIES OF MERCHANTABILITY, FITNESS FOR A PARTICULAR PURPOSE OR NON-INFRINGEMENT OF THIRD PARTY INTELLECTUAL PROPERTY RIGHTS.

These resources are intended for skilled developers designing with TI products. You are solely responsible for (1) selecting the appropriate TI products for your application, (2) designing, validating and testing your application, and (3) ensuring your application meets applicable standards, and any other safety, security, regulatory or other requirements.

These resources are subject to change without notice. TI grants you permission to use these resources only for development of an application that uses the TI products described in the resource. Other reproduction and display of these resources is prohibited. No license is granted to any other TI intellectual property right or to any third party intellectual property right. TI disclaims responsibility for, and you fully indemnify TI and its representatives against any claims, damages, costs, losses, and liabilities arising out of your use of these resources.

TI's products are provided subject to [TI's Terms of Sale](#), [TI's General Quality Guidelines](#), or other applicable terms available either on [ti.com](http://ti.com) or provided in conjunction with such TI products. TI's provision of these resources does not expand or otherwise alter TI's applicable warranties or warranty disclaimers for TI products. Unless TI explicitly designates a product as custom or customer-specified, TI products are standard, catalog, general purpose devices.

TI objects to and rejects any additional or different terms you may propose.

Copyright © 2026, Texas Instruments Incorporated

Last updated 10/2025