

CC1200 Low-Power, High-Performance RF Transceiver

1 Device Overview

1.1 Features

- RF Performance and Analog Features:
 - High-Performance, Single-Chip Transceiver
 - Excellent Receiver Sensitivity:
 - –123 dBm at 1.2 kbps
 - –109 dBm at 50 kbps
 - Blocking Performance: 86 dB at 10 MHz
 - Adjacent Channel Selectivity: Up to 60 dB at 12.5-kHz Offset
 - Very Low Phase Noise: –114 dBc/Hz at 10-kHz Offset (169 MHz)
 - Programmable Output Power Up to +16 dBm With 0.4-dB Step Size
 - Automatic Output Power Ramping
 - Supported Modulation Formats: 2-FSK, 2-GFSK, 4-FSK, 4-GFSK, MSK, OOK
 - Supports Data Rate Up to 1.25 Mbps in Transmit and Receive
- Low Current Consumption:
 - Enhanced Wake-On-Radio (eWOR) Functionality for Automatic Low-Power Receive Polling
 - Power Down: 0.12 μ A (0.5 μ A With eWOR Timer Active)
 - RX: 0.5 mA in RX Sniff Mode
 - RX: 19 mA Peak Current in Low-Power Mode
 - RX: 23 mA Peak Current in High-Performance Mode
 - TX: 46 mA at +14 dBm
- Other:
 - Data FIFOs: Separate 128-Byte RX and TX
 - Support for Seamless Integration With the CC1190 Device for Increased Range Providing up to 3-dB Improvement in RX Sensitivity and up to +27 dBm TX Output Power
- Digital Features:
 - WaveMatch: Advanced Digital Signal Processing for Improved Sync Detect Performance
 - Security: Hardware AES128 Accelerator
 - Data FIFOs: Separate 128-Byte RX and TX
 - Includes Functions for Antenna Diversity Support
 - Support for Retransmission
 - Support for Auto-Acknowledge of Received Packets
 - Automatic Clear Channel Assessment (CCA) for Listen-Before-Talk (LBT) Systems
 - Built-in Coding Gain Support for Increased Range and Robustness
 - Digital RSSI Measurement
 - Improved OOK Shaping for Less Occupied Bandwidth, Enabling Higher Output Power While Meeting Regulatory Requirements
- Dedicated Packet Handling for 802.15.4g:
 - CRC 16/32
 - FEC, Dual Sync Detection (FEC and non-FEC Packets)
 - Whitening
- General:
 - RoHS-Compliant 5-mm x 5-mm No-Lead QFN 32-Pin Package (RHB)
 - Pin-Compatible With the CC1120 Device
- Regulations – Suitable for Systems Targeting Compliance With
 - **Europe:** ETSI EN 300 220, EN 54-25
 - **US:** FCC CFR47 Part 15, FCC CFR47 Part 90
 - **Japan:** ARIB STD-T30, T67, T108

1.2 Applications

- Low-Power, High-Performance, Wireless Systems With Data Rate Up to 1250 kbps
- ISM/SRD Bands: 169, 433, 868, 915, and 920 MHz
- Possible Support for Additional Frequency Bands: 137 to 158.3 MHz, 205 to 237.5 MHz, and 274 to 316.6 MHz
- Smart Metering (AMR/AMI)
- Home and Building Automation
- Wireless Alarm and Security Systems
- Industrial Monitoring and Control
- Wireless Healthcare Applications
- Wireless Sensor Networks and Active RFID
- IEEE 802.15.4g Applications
- Wireless M-Bus, All Modes



1.3 Description

The CC1200 device is a fully integrated single-chip radio transceiver designed for high performance at very low-power and low-voltage operation in cost-effective wireless systems. All filters are integrated, thus removing the need for costly external SAW and IF filters. The device is mainly intended for the ISM (Industrial, Scientific, and Medical) and SRD (Short Range Device) frequency bands at 164–190 MHz, 410–475 MHz, and 820–950 MHz.

The CC1200 device provides extensive hardware support for packet handling, data buffering, burst transmissions, clear channel assessment, link quality indication, and Wake-On-Radio. The main operating parameters of the CC1200 device can be controlled through an SPI interface. In a typical system, the CC1200 device will be used with a microcontroller and only a few external passive components.

The CC1200 and the CC1120 devices are both part of the high-performance transceiver family. The CC1120 device is more optimized toward narrowband applications, while the CC1200 device is optimized toward wideband applications but can also effectively cover narrowband down to 12.5-kHz channels.

Device Information⁽¹⁾

PART NUMBER	PACKAGE	BODY SIZE
CC1200RHB	VQFN (32)	5.00 mm x 5.00 mm

(1) For more information, see [Section 8, Mechanical Packaging and Orderable Information](#)

1.4 Functional Block Diagram

Figure 1-1 shows the system block diagram of the CC120x family of devices.

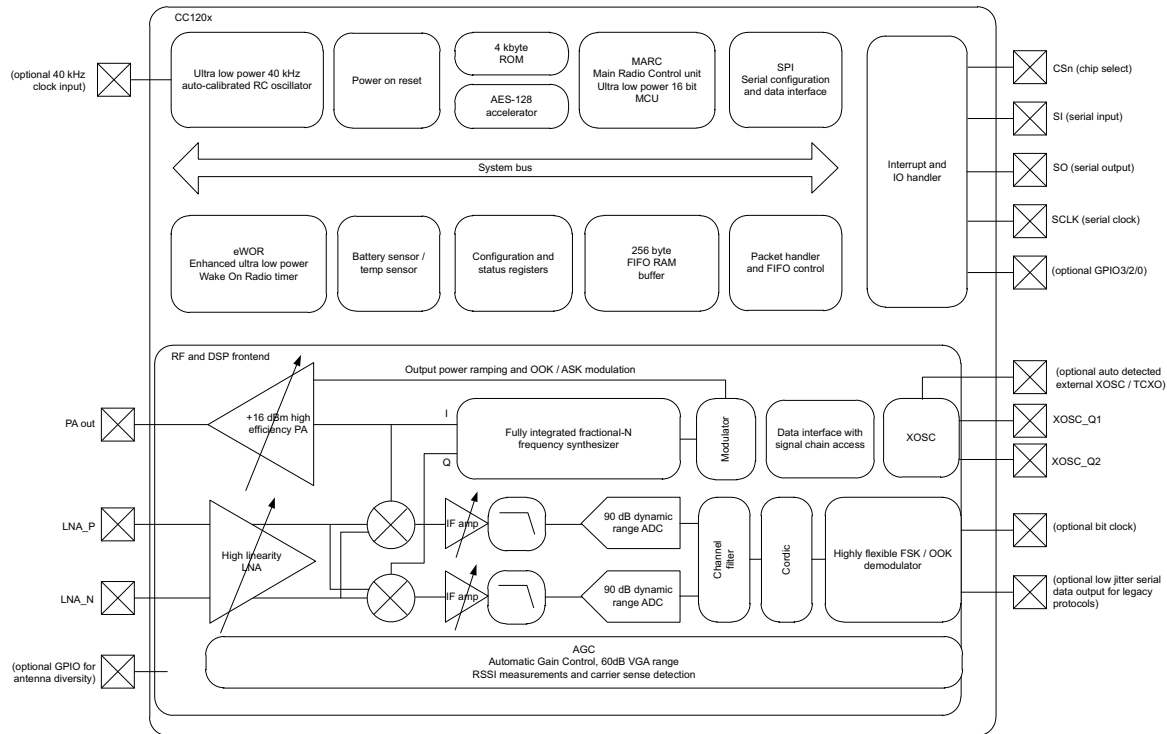

Figure 1-1. Functional Block Diagram

Table of Contents

1 Device Overview 1	
1.1 Features 1	4.15 40-MHz Clock Input (TCXO) 15
1.2 Applications 1	4.16 32-kHz Clock Input 16
1.3 Description 2	4.17 40-kHz RC Oscillator 16
1.4 Functional Block Diagram 2	4.18 I/O and Reset 16
2 Revision History 4	4.19 Temperature Sensor 16
3 Terminal Configuration and Functions 5	4.20 Typical Characteristics 17
3.1 Pin Diagram 5	5 Detailed Description 20
3.2 Pin Configuration 6	5.1 Block Diagram 20
4 Specifications 7	5.2 Frequency Synthesizer 20
4.1 Absolute Maximum Ratings 7	5.3 Receiver 21
4.2 Handling Ratings 7	5.4 Transmitter 21
4.3 Recommended Operating Conditions (General Characteristics) 7	5.5 Radio Control and User Interface 21
4.4 Thermal Resistance Characteristics for RHB Package 7	5.6 Enhanced Wake-On-Radio (eWOR) 21
4.5 RF Characteristics 8	5.7 RX Sniff Mode 22
4.6 Regulatory Standards 8	5.8 Antenna Diversity 22
4.7 Current Consumption, Static Modes 9	5.9 WaveMatch 23
4.8 Current Consumption, Transmit Modes 9	6 Typical Application Circuit 24
4.9 Current Consumption, Receive Modes 10	7 Device and Documentation Support 25
4.10 Receive Parameters 10	7.1 Device Support 25
4.11 Transmit Parameters 13	7.2 Documentation Support 26
4.12 PLL Parameters 14	7.3 Community Resources 26
4.13 Wake-up and Timing 15	7.4 Trademarks 26
4.14 40-MHz Crystal Oscillator 15	7.5 Electrostatic Discharge Caution 26
	7.6 Glossary 26
	8 Mechanical Packaging and Orderable Information 27

2 Revision History

NOTE: Page numbers for previous revisions may differ from page numbers in the current version.

This data manual revision history highlights the changes made to the SWRS123C device-specific data manual to make it an SWRS123D revision.

Changes from Revision C (June 2014) to Revision D	Page
• Added Ambient to the temperature range condition and removed Tj from Temperature range	7
• Added data to TCXO table	15

3 Terminal Configuration and Functions

3.1 Pin Diagram

Figure 3-1 shows pin names and locations for the CC1200 device.

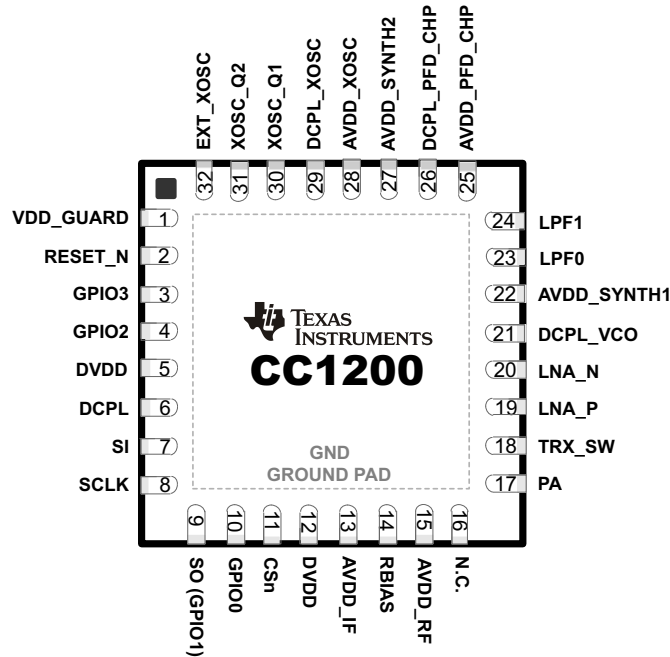

Figure 3-1. Package 5-mm x 5-mm QFN

3.2 Pin Configuration

The following table lists the pin-out configuration for the CC1200 device.

PIN NO.	PIN NAME	TYPE / DIRECTION	DESCRIPTION
1	VDD_GUARD	Power	2.0–3.6 V VDD
2	RESET_N	Digital input	Asynchronous, active-low digital reset
3	GPIO3	Digital I/O	General-purpose I/O
4	GPIO2	Digital I/O	General-purpose I/O
5	DVDD	Power	2.0–3.6 VDD to internal digital regulator
6	DCPL	Power	Digital regulator output to external decoupling capacitor
7	SI	Digital input	Serial data in
8	SCLK	Digital input	Serial data clock
9	SO(GPIO1)	Digital I/O	Serial data out (general-purpose I/O)
10	GPIO0	Digital I/O	General-purpose I/O
11	CSn	Digital input	Active-low chip select
12	DVDD	Power	2.0–3.6 V VDD
13	AVDD_IF	Power	2.0–3.6 V VDD
14	RBIAS	Analog	External high-precision resistor
15	AVDD_RF	Power	2.0–3.6 V VDD
16	N.C.		Not connected
17	PA	Analog	Single-ended TX output (requires DC path to VDD)
18	TRX_SW	Analog	TX and RX switch. Connected internally to GND in TX and floating (high-impedance) in RX.
19	LNA_P	Analog	Differential RX input (requires DC path to ground)
20	LNA_N	Analog	Differential RX input (requires DC path to ground)
21	DCPL_VCO	Power	Pin for external decoupling of VCO supply regulator
22	AVDD_SYNTH1	Power	2.0–3.6 V VDD
23	LPF0	Analog	External loop filter components
24	LPF1	Analog	External loop filter components
25	AVDD_PFD_CHP	Power	2.0–3.6 V VDD
26	DCPL_PFD_CHP	Power	Pin for external decoupling of PFD and CHP regulator
27	AVDD_SYNTH2	Power	2.0–3.6 V VDD
28	AVDD_XOSC	Power	2.0–3.6 V VDD
29	DCPL_XOSC	Power	Pin for external decoupling of XOSC supply regulator
30	XOSC_Q1	Analog	Crystal oscillator pin 1 (must be grounded if a TCXO or other external clock connected to EXT_XOSC is used)
31	XOSC_Q2	Analog	Crystal oscillator pin 2 (must be left floating if a TCXO or other external clock connected to EXT_XOSC is used)
32	EXT_XOSC	Digital input	Pin for external clock input (must be grounded if a regular crystal connected to XOSC_Q1 and XOSC_Q2 is used)
–	GND	Ground pad	The ground pad must be connected to a solid ground plane.

4 Specifications

All measurements performed on CC1200EM_868_930 rev.1.0.0, CC1200EM_420_470 rev.1.0.1, or CC1200EM_169 rev.1.2.

4.1 Absolute Maximum Ratings⁽¹⁾⁽²⁾

over operating free-air temperature range (unless otherwise noted)

PARAMETER	MIN	MAX	UNIT	CONDITION
Supply voltage (VDD, AVDD_x)	-0.3	3.9	V	All supply pins must have the same voltage
Input RF level		+10	dBm	
Voltage on any digital pin	-0.3	VDD+0.3	V	max 3.9 V
Voltage on analog pins (including DCPL pins)	-0.3	2.0	V	

- Stresses beyond those listed under absolute maximum ratings may cause permanent damage to the device. These are stress ratings only, and functional operation of the device at these or any other conditions beyond those indicated under general characteristics is not implied. Exposure to absolute-maximum-rated conditions for extended periods may affect device reliability.
- All voltage values are with respect to V_{SS} , unless otherwise noted.

4.2 Handling Ratings

		MIN	MAX	UNIT
T_{stg}	Storage temperature range	-40	125	°C
V_{ESD}	Electrostatic discharge (ESD) performance:	Human body model (HBM), per ANSI/ESDA/JEDEC JS001 ⁽¹⁾		kV
		Charged device model (CDM), per JESD22-C101 ⁽²⁾		V
	All pins	-500	500	

- JEDEC document JEP155 states that 500-V HBM allows safe manufacturing with a standard ESD control process.
- JEDEC document JEP157 states that 250-V HBM allows safe manufacturing with a standard ESD control process.

4.3 Recommended Operating Conditions (General Characteristics)

PARAMETER	MIN	TYP	MAX	UNIT	CONDITION
Voltage supply range	2.0		3.6	V	All supply pins must have the same voltage
Voltage on digital inputs	0		VDD	V	
Temperature range	-40		85	°C	Ambient

4.4 Thermal Resistance Characteristics for RHB Package

	°C/W ⁽¹⁾	AIR FLOW (m/s) ⁽²⁾
$R\theta_{JC}$ Junction-to-case (top)	21.1	0.00
$R\theta_{JB}$ Junction-to-board	5.3	0.00
$R\theta_{JA}$ Junction-to-free air	31.3	0.00
Ps_{JT} Junction-to-package top	0.2	0.00
Ps_{JB} Junction-to-board	5.3	0.00
$R\theta_{JC}$ Junction-to-case (bottom)	0.8	0.00

- These values are based on a JEDEC-defined 2S2P system (with the exception of the Theta JC [$R\theta_{JC}$] value, which is based on a JEDEC-defined 1S0P system) and will change based on environment as well as application. For more information, see these EIA/JEDEC standards:
 - JESD51-2, *Integrated Circuits Thermal Test Method Environmental Conditions - Natural Convection (Still Air)*
 - JESD51-3, *Low Effective Thermal Conductivity Test Board for Leaded Surface Mount Packages*
 - JESD51-7, *High Effective Thermal Conductivity Test Board for Leaded Surface Mount Packages*
 - JESD51-9, *Test Boards for Area Array Surface Mount Package Thermal Measurements*
Power dissipation of 40 mW and an ambient temperature of 25°C is assumed.
- m/s = meters per second

4.5 RF Characteristics

PARAMETER	MIN	TYP	MAX	UNIT	CONDITION
Frequency bands	820		950	MHz	Contact TI for more information about the use of these frequency bands.
	410		475	MHz	
	164		190	MHz	
	(274)		(316.6)	MHz	
	(205)		(237.5)	MHz	
	(137)		(158.3)	MHz	
Frequency resolution		30		Hz	In 820–950 MHz band
		15		Hz	In 410–475 MHz band
		6		Hz	In 164–190 MHz band
Data rate	0		1250	kbps	Packet mode
	0		625	kbps	Transparent mode

4.6 Regulatory Standards

PERFORMANCE MODE	FREQUENCY BAND	SUITABLE FOR COMPLIANCE WITH	COMMENTS
High-performance mode	820–950 MHz	ARIB STD-T108 ETSI EN 300 220 receiver, categories 2 and 3 FCC Part 15.247 FCC Part 15.249 FCC Part 90 Mask G FCC Part 90 Mask J	Performance also suitable for systems targeting maximum allowed output power in the respective bands, using a range extender such as the CC1190 device
	410–475 MHz	ARIB STD-T67 ARIB RCR STD-T30 ETSI EN 300 220 receiver, categories 2 and 3 FCC Part 90 Mask D FCC Part 90 Mask G	Performance also suitable for systems targeting maximum allowed output power in the respective bands, using a range extender
	164–190 MHz	ETSI EN 300 220 receiver, category 1 FCC Part 90 Mask D	Performance also suitable for systems targeting maximum allowed output power in the respective bands, using a range extender
Low-power mode	820–950 MHz	ETSI EN 300 220 receiver, categories 2 and 3 FCC Part 15.247 FCC Part 15.249	
	410–475 MHz	ETSI EN 300 220 receiver, categories 2 and 3	
	164–190 MHz	ETSI EN 300 220	

4.7 Current Consumption, Static Modes

 $T_A = 25^\circ\text{C}$, VDD = 3.0 V if nothing else stated

PARAMETER	MIN	TYP	MAX	UNIT	CONDITION
Power down with retention		0.12	1	μA	
		0.5		μA	Low-power RC oscillator running
XOFF mode		180		μA	Crystal oscillator / TCXO disabled
IDLE mode		1.5		mA	Clock running, system waiting with no radio activity

4.8 Current Consumption, Transmit Modes

4.8.1 868-, 915-, and 920-MHz Bands (High-Performance Mode)

 $T_A = 25^\circ\text{C}$, VDD = 3.0 V if nothing else stated

PARAMETER	MIN	TYP	MAX	UNIT	CONDITION
TX current consumption +14 dBm		46		mA	
TX current consumption +10 dBm		36		mA	

4.8.2 433-MHz Band (High-Performance Mode)

 $T_A = 25^\circ\text{C}$, VDD = 3.0 V if nothing else stated

PARAMETER	MIN	TYP	MAX	UNIT	CONDITION
TX current consumption +15 dBm		49		mA	
TX current consumption +14 dBm		46		mA	
TX current consumption +10 dBm		35		mA	

4.8.3 169-MHz Band (High-Performance Mode)

 $T_A = 25^\circ\text{C}$, VDD = 3.0 V if nothing else stated

PARAMETER	MIN	TYP	MAX	UNIT	CONDITION
TX current consumption +15 dBm		54		mA	
TX current consumption +14 dBm		50		mA	
TX current consumption +10 dBm		39		mA	

4.8.4 Low-Power Mode

 $T_A = 25^\circ\text{C}$, VDD = 3.0 V, $f_c = 869.5\text{ MHz}$ if nothing else stated

PARAMETER	MIN	TYP	MAX	UNIT	CONDITION
TX current consumption +10 dBm		33.6		mA	

4.9 Current Consumption, Receive Modes

4.9.1 High-Performance Mode

$T_A = 25^\circ\text{C}$, $V_{DD} = 3.0\text{ V}$, $f_c = 869.5\text{ MHz}$ if nothing else stated

PARAMETER	MIN	TYP	MAX	UNIT	CONDITION
RX Wait for sync					
1.2 kbps, 4-byte preamble (50 kHz Channel Filter Bandwidth)		0.5		mA	Using RX sniff mode, where the receiver wakes up at regular intervals looking for an incoming packet. Sniff mode configured to terminate on Carrier Sense, and is measured using <code>RSSI_VALID_COUNT = 1</code> (0 for 1.2 kbps with 50 kHz Channel Filter Bandwidth), <code>AGC_WIN_SIZE = 0</code> , and <code>SETTLE_WAIT = 1</code> . ⁽¹⁾
1.2 kbps, 3-byte preamble (11 kHz Channel Filter Bandwidth)		3.1		mA	
38.4 kbps, 12-byte preamble		3.4		mA	
50 kbps, 24-byte preamble		2.1		mA	
RX Peak Current					
1.2kbps		23.5		mA	Peak current consumption during packet reception
Average current consumption Check for data packet every 1 second using Wake on Radio		8		μA	50 kbps, 5-byte preamble, 40-kHz RC oscillator used as sleep timer

(1) See the sniff mode design note for more information ([SWRA428](#)).

4.9.2 Low-Power Mode

$T_A = 25^\circ\text{C}$, $V_{DD} = 3.0\text{ V}$, $f_c = 869.5\text{ MHz}$ if nothing else stated

PARAMETER	MIN	TYP	MAX	UNIT	CONDITION
RX Peak Current Low-power RX mode					
1.2 kbps		19		mA	Peak current consumption during packet reception at the sensitivity limit

4.10 Receive Parameters

All RX measurements made at the antenna connector, to a bit error rate (BER) limit of 1%. Selectivity and blocking is measured with the desired signal 3 dB greater than the sensitivity level.

4.10.1 General Receive Parameters (High-Performance Mode)

$T_A = 25^\circ\text{C}$, $V_{DD} = 3.0\text{ V}$, $f_c = 869.5\text{ MHz}$ if nothing else stated

PARAMETER	MIN	TYP	MAX	UNIT	CONDITION
Saturation		+10		dBm	
Digital channel filter programmable bandwidth	9.5		1600	kHz	
IIP3		-14		dBm	At maximum gain
Data rate offset tolerance		± 14 ± 1600		% ppm	With carrier sense detection enabled With carrier sense detection disabled
Spurious emissions					
1–13 GHz (VCO leakage at 3.5 GHz)		< -56		dBm	Radiated emissions measured according to ETSI EN 300 220, $f_c = 869.5\text{ MHz}$
30 MHz to 1 GHz		< -57		dBm	
Optimum source impedance					
868-, 915-, and 920-MHz bands		$60 + j60 / 30 + j30$		Ω	(Differential or single-ended RX configurations)
433-MHz band		$100 + j60 / 50 + j30$		Ω	
169-MHz band		$140 + j40 / 70 + j20$		Ω	

4.10.2 RX Performance in 868-, 915-, and 920-MHz Bands (High-Performance Mode)

 $T_A = 25^\circ\text{C}$, $V_{DD} = 3.0\text{ V}$ if nothing else stated

PARAMETER	MIN	TYP	MAX	UNIT	CONDITION
Sensitivity		-122		dBm	1.2 kbps 2-FSK, DEV=4 kHz CHF=11 kHz ⁽¹⁾
		-113		dBm	4.8 kbps OOK
		-108		dBm	32.768 kbps 2-GFSK, DEV=50 kHz CHF=208 kHz ⁽¹⁾
		-110		dBm	38.4 kbps 2-GFSK, DEV=20 kHz CHF=104 kHz ⁽¹⁾
		-109		dBm	50 kbps 2-GFSK, DEV=25 kHz, CHF=104 kHz ⁽¹⁾
		-107		dBm	100-kbps 2-GFSK, DEV=50 kHz, CHF=208 kHz ⁽¹⁾
		-97		dBm	500 kbps 2-GMSK, CHF=833 kHz ⁽¹⁾
Blocking and Selectivity 1.2-kbps 2-FSK, 12.5-kHz channel separation, 4-kHz deviation, 11-kHz channel filter		54		dB	± 12.5 kHz (adjacent channel)
		55		dB	± 25 kHz (alternate channel)
		77		dB	± 2 MHz
		82		dB	± 10 MHz
Blocking and Selectivity 32.768-kbps 2-GFSK, 200-kHz channel separation, 50-kHz deviation, 208-kHz channel filter		38		dB	± 200 kHz
		46		dB	± 400 kHz
		66		dB	± 2 MHz
		70		dB	± 10 MHz
Blocking and Selectivity 38.4-kbps 2-GFSK, 100-kHz channel separation, 20-kHz deviation, 104-kHz channel filter		44		dB	+ 100 kHz (adjacent channel)
		44		dB	± 200 kHz (alternate channel)
		64		dB	± 2 MHz
		72		dB	± 10 MHz
Blocking and Selectivity 50-kbps 2-GFSK, 200-kHz channel separation, 25-kHz deviation, 104-kHz channel filter (Same modulation format as 802.15.4g Mandatory Mode)		41		dB	± 200 kHz (adjacent channel)
		46		dB	± 400 kHz (alternate channel)
		65		dB	± 2 MHz
		71		dB	± 10 MHz
Blocking and Selectivity 100-kbps 2-GFSK, 50-kHz deviation, 208-kHz channel filter		45		dB	± 400 kHz (adjacent channel)
		54		dB	± 800 kHz (alternate channel)
		63		dB	± 2 MHz
		68		dB	± 10 MHz
Blocking and Selectivity 500-kbps GMSK, 833-kHz channel filter		42		dB	+ 1 MHz (adjacent channel)
		42		dB	± 2 MHz (alternate channel)
		57		dB	± 10 MHz
Blocking and Selectivity 1-Mbps 4-GFSK, 400-kHz deviation, 1.6-MHz channel filter		46		dB	± 2 MHz (adjacent channel)
		52		dB	± 4 MHz (alternate channel)
		59		dB	± 10 MHz
Image rejection (Image compensation enabled)		56		dB	1.2 kbps, DEV=4 kHz, CHF=10 kHz, image at -125 kHz

(1) DEV is short for deviation, CHF is short for Channel Filter Bandwidth

4.10.3 RX Performance in 433-MHz Band (High-Performance Mode)

$T_A = 25^\circ\text{C}$, $V_{DD} = 3.0\text{ V}$ if nothing else stated

PARAMETER	MIN	TYP	MAX	UNIT	CONDITION
Sensitivity		-123		dBm	1.2 kbps 2-FSK, DEV=4 kHz CHF=11 kHz ⁽¹⁾
		-111		dBm	38.4 kbps 2-GFSK, DEV=20 kHz CHF=104 kHz ⁽¹⁾
Blocking and Selectivity 1.2-kbps 2-FSK, 12.5-kHz channel separation, 4-kHz deviation, 11-kHz channel filter		60		dB	± 12.5 kHz (adjacent channel)
		61		dB	± 25 kHz (alternate channel)
		82		dB	± 2 MHz
		85		dB	± 10 MHz
Blocking and Selectivity 38.4-kbps 2-GFSK, 100-kHz channel separation, 20-kHz deviation, 104-kHz channel filter		49		dB	+ 100 kHz (adjacent channel)
		48		dB	± 200 kHz (alternate channel)
		66		dB	± 2 MHz
		74		dB	± 10 MHz

(1) DEV is short for deviation, CHF is short for Channel Filter Bandwidth

4.10.4 RX Performance in 169-MHz Band (High-Performance Mode)

$T_A = 25^\circ\text{C}$, $V_{DD} = 3.0\text{ V}$ if nothing else stated

PARAMETER	MIN	TYP	MAX	UNIT	CONDITION
Sensitivity		-122		dBm	1.2 kbps 2-FSK, DEV=4 kHz CHF=11 kHz ⁽¹⁾
Blocking and Selectivity 1.2 kbps 2-FSK, 12.5-kHz channel separation, 4-kHz deviation, 11-kHz channel filter		59		dB	± 12.5 kHz (adjacent channel)
		64		dB	± 25 kHz (alternate channel)
		84		dB	± 2 MHz
		86		dB	± 10 MHz
Spurious response rejection 1.2 kbps 2-FSK, 12.5-kHz channel separation, 4-kHz deviation, 11-kHz channel filter		68		dB	Spurious at ± 40 MHz from carrier
Image rejection (Image compensation enabled)		68		dB	1.2 kbps, DEV=4 kHz, CHF=10 kHz, image at -125 kHz

(1) DEV is short for deviation, CHF is short for Channel Filter Bandwidth

4.10.5 RX Performance in Low-Power Mode

$T_A = 25^\circ\text{C}$, $V_{DD} = 3.0\text{ V}$, $f_c = 869.5\text{ MHz}$ if nothing else stated

PARAMETER	MIN	TYP	MAX	UNIT	CONDITION
Sensitivity		-110		dBm	1.2 kbps 2-FSK, DEV=4 kHz CHF=11 kHz ⁽¹⁾
		-96		dBm	50 kbps 2-GFSK, DEV=25 kHz, CHF=119 kHz ⁽¹⁾
Blocking and Selectivity 50 kbps 2-GFSK, 200-kHz channel separation, 25-kHz deviation, 104-kHz channel filter (Same modulation format as 802.15.4g Mandatory Mode)		41		dB	+ 200 kHz (adjacent channel)
		45		dB	+ 400 kHz (alternate channel)
		62		dB	± 2 MHz
		60		dB	± 10 MHz
Saturation		+10		dBm	

(1) DEV is short for deviation, CHF is short for Channel Filter Bandwidth

4.11 Transmit Parameters

 $T_A = 25^\circ\text{C}$, $V_{DD} = 3.0\text{ V}$, $f_c = 869.5\text{ MHz}$ if nothing else stated

PARAMETER	MIN	TYP	MAX	UNIT	CONDITION	
Max output power		+14		dBm	At 915- and 920-MHz	
		+15		dBm	At 915- and 920-MHz with $V_{DD} = 3.6\text{ V}$	
		+15		dBm	At 868 MHz	
		+16		dBm	At 868 MHz with $V_{DD} = 3.6\text{ V}$	
		+15		dBm	At 433 MHz	
		+16		dBm	At 433 MHz with $V_{DD} = 3.6\text{ V}$	
Min output power		-12		dBm	Within fine step size range	
		-38		dBm	Within coarse step size range	
Output power step size		0.4		dB	Within fine step size range	
Adjacent channel power		-60		dBc	4-GFSK 9.6 kbps in 12.5-kHz channel, measured in 8.75-kHz bandwidth (ETSI 300 220 compliant)	
Spurious emissions (Excluding harmonics)					Transmission at +14 dBm Suitable for systems targeting compliance with ETSI EN 300 220, ETSI EN 54-25, FCC Part 15, FCC Part 90, ARIB STD-T108, ARIB STD-T67, ARIB RCR STD-30 Measured in 1-MHz bandwidth	
30 MHz–1 GHz		< -57		dBm		
1–12.75 GHz		< -50		dBm		
Harmonics						
Second Harm, 169 MHz (ETSI)		-43		dBm	Transmission at +14 dBm (or maximum allowed in applicable band where this is less than +14 dBm) using TI reference design Suitable for systems targeting compliance with ETSI EN 300-220, ETSI EN 54-25, FCC Part 15, FCC Part 90, ARIB STD-T108, ARIB STD-T67, ARIB RCR STD-30	
Third Harm, 169 MHz (ETSI)		-57		dBm		
Fourth Harm, 169 MHz (ETSI)		-63		dBm		
Second Harm, 433 MHz (ETSI)		-59		dBm		
Third Harm, 433 MHz (ETSI)		-51		dBm		
Fourth Harm, 433 MHz (ETSI)		-63		dBm		
Second Harm, 868 MHz (ETSI)		-50		dBm		
Third Harm, 868 MHz (ETSI)		-44		dBm		
Fourth Harm, 868 MHz (ETSI)		-56		dBm		
Second Harm, 915 MHz (FCC)		-58		dBm		
Third Harm, 915 MHz (FCC)		-46		dBm		
Fourth Harm, 915 MHz (FCC)		-62		dBm		
Second Harm, 920 MHz (ARIB)		-65		dBm		
Third Harm, 920 MHz (ARIB)		-60		dBm		
Optimum load impedance						
868-, 915-, and 920-MHz bands		35 + j35		Ω		
433-MHz band		55 + j25		Ω		
169-MHz band		80 + j0		Ω		

4.12 PLL Parameters

4.12.1 High-Performance Mode

$T_A = 25^\circ\text{C}$, $V_{DD} = 3.0\text{ V}$ if nothing else stated

PARAMETER	MIN	TYP	MAX	UNIT	CONDITION
Phase noise in 868-, 915-, and 920-MHz bands 200-kHz loop bandwidth setting		-94		dBc/Hz	$\pm 10\text{ kHz offset}$
		-96		dBc/Hz	$\pm 100\text{ kHz offset}$
		-123		dBc/Hz	$\pm 1\text{ MHz offset}$
		-137		dBc/Hz	$\pm 10\text{ MHz offset}$
Phase noise in 868-, 915-, and 920-MHz bands 300-kHz loop bandwidth setting		-100		dBc/Hz	$\pm 10\text{ kHz offset}$
		-102		dBc/Hz	$\pm 100\text{ kHz offset}$
		-121		dBc/Hz	$\pm 1\text{ MHz offset}$
Phase noise in 868-, 915-, and 920-MHz bands 400-kHz loop bandwidth setting		-103		dBc/Hz	$\pm 10\text{ kHz offset}$
		-104		dBc/Hz	$\pm 100\text{ kHz offset}$
		-119		dBc/Hz	$\pm 1\text{ MHz offset}$
Phase noise in 868-, 915-, and 920-MHz bands 500-kHz loop bandwidth setting		-133		dBc/Hz	$\pm 10\text{ MHz offset}$
		-104		dBc/Hz	$\pm 10\text{ kHz offset}$
		-106		dBc/Hz	$\pm 100\text{ kHz offset}$
Phase noise in 868-, 915-, and 920-MHz bands 500-kHz loop bandwidth setting		-116		dBc/Hz	$\pm 1\text{ MHz offset}$
		-130		dBc/Hz	$\pm 10\text{ MHz offset}$
	Phase noise in 433-MHz band 300-kHz loop bandwidth setting		-106		dBc/Hz
		-107		dBc/Hz	$\pm 100\text{ kHz offset}$
		-127		dBc/Hz	$\pm 1\text{ MHz offset}$
		-141		dBc/Hz	$\pm 10\text{ MHz offset}$
Phase noise in 169-MHz band 300-kHz loop bandwidth setting		-114		dBc/Hz	$\pm 10\text{ kHz offset}$
		-114		dBc/Hz	$\pm 100\text{ kHz offset}$
		-132		dBc/Hz	$\pm 1\text{ MHz offset}$
	-142		dBc/Hz	$\pm 10\text{ MHz offset}$	

4.12.2 Low-Power Mode

$T_A = 25^\circ\text{C}$, $V_{DD} = 3.0\text{ V}$ if nothing else stated

PARAMETER	MIN	TYP	MAX	UNIT	CONDITION
Phase noise in 868-, 915-, and 920-MHz bands 200-kHz loop bandwidth setting		-99		dBc/Hz	$\pm 10\text{ kHz offset}$
		-101		dBc/Hz	$\pm 100\text{ kHz offset}$
		-121		dBc/Hz	$\pm 1\text{ MHz offset}$
		-135		dBc/Hz	$\pm 10\text{ MHz offset}$

4.13 Wake-up and Timing

 $T_A = 25^\circ\text{C}$, $V_{DD} = 3.0\text{ V}$, $f_c = 869.5\text{ MHz}$ if nothing else stated

The turnaround behavior to and from RX and/or TX is highly configurable, and the time it takes will depend on how the device is set up. See the CC120X user guide ([SWRU346](#)) for more information.

PARAMETER	MIN	TYP	MAX	UNIT	CONDITION
Powerdown to IDLE		0.24		ms	Depends on crystal
IDLE to RX/TX		133		μs	Calibration disabled
		369		μs	Calibration enabled
RX/TX turnaround		43		μs	
RX-to-RX turnaround		369		μs	With PLL calibration
		0		μs	Without PLL calibration
TX-to-TX turnaround		369		μs	With PLL calibration
		0		μs	Without PLL calibration
RX/TX to IDLE time		237		μs	Calibrate when leaving RX/TX enabled
		0		μs	Calibrate when leaving RX/TX disabled
Frequency synthesizer calibration		314		μs	When using SCAL strobe
Minimum required number of preamble bytes		0.5		bytes	Required for RF front-end gain settling only. Digital demodulation does not require preamble for settling.
Time from start RX until valid RSSI ⁽¹⁾ Including gain settling (function of channel bandwidth. Programmable for trade-off between speed and accuracy)		4.2		ms	12.5-kHz channels
		0.25		ms	120-kHz channels

(1) See the design note on RSSI and response time. It is written for the CC112X devices, but the same principles apply for the CC1200 device.

4.14 40-MHz Crystal Oscillator

 $T_A = 25^\circ\text{C}$, $V_{DD} = 3.0\text{ V}$ if nothing else stated

PARAMETER	MIN	TYP	MAX	UNIT	CONDITION
Crystal frequency	38.4		40	MHz	It is expected that there will be degraded sensitivity at multiples of XOSC/2 in RX, and an increase in spurious emissions when the RF channel is close to multiples of XOSC in TX. We recommend that the RF channel is kept $RX_BW/2$ away from XOSC/2 in RX, and that the level of spurious emissions be evaluated if the RF channel is closer than 1 MHz to multiples of XOSC in TX.
Load capacitance (C_L)		10		pF	
ESR			60	Ω	Simulated over operating conditions
Start-up time		0.24		ms	Depends on crystal

4.15 40-MHz Clock Input (TCXO)

 $T_A = 25^\circ\text{C}$, $V_{DD} = 3.0\text{ V}$ if nothing else stated

PARAMETER	MIN	TYP	MAX	UNIT	CONDITION
Clock frequency	38.4		40	MHz	
TCXO with CMOS output					TCXO with CMOS output directly coupled to pin EXT_OSC
High input voltage	1.4		V_{DD}	V	
Low input voltage	0		0.6	V	
Rise / Fall time			2	ns	
Clipped sine output					TCXO clipped sine output connected to pin EXT_OSC through series capacitor
Clock input amplitude (peak-to-peak)	0.8		1.5	V	

4.16 32-kHz Clock Input

$T_A = 25^\circ\text{C}$, $V_{DD} = 3.0\text{ V}$ if nothing else stated

PARAMETER	MIN	TYP	MAX	UNIT	CONDITION
Clock frequency		32		kHz	
32-kHz clock input pin input high voltage	$0.8 \times V_{DD}$			V	
32-kHz clock input pin input low voltage			$0.2 \times V_{DD}$	V	

4.17 40-kHz RC Oscillator

$T_A = 25^\circ\text{C}$, $V_{DD} = 3.0\text{ V}$ if nothing else stated

PARAMETER	MIN	TYP	MAX	UNIT	CONDITION
Frequency		40		kHz	After calibration (frequency calibrated against the 40-MHz crystal or TCXO)
Frequency accuracy after calibration		± 0.1		%	Relative to frequency reference (that is, 40-MHz crystal or TCXO)
Initial calibration time		1.32		ms	

4.18 I/O and Reset

$T_A = 25^\circ\text{C}$, $V_{DD} = 3.0\text{ V}$ if nothing else stated

PARAMETER	MIN	TYP	MAX	UNIT	CONDITION
Logic input high voltage	$0.8 \times V_{DD}$			V	
Logic input low voltage			$0.2 \times V_{DD}$	V	
Logic output high voltage	$0.8 \times V_{DD}$			V	At 4-mA output load or less
Logic output low voltage			$0.2 \times V_{DD}$	V	
Power-on reset threshold		1.3		V	Voltage on DVDD pin

4.19 Temperature Sensor

$T_A = 25^\circ\text{C}$, $V_{DD} = 3.0\text{ V}$ if nothing else stated

PARAMETER	MIN	TYP	MAX	UNIT	CONDITION
Temperature sensor range	-40		85	$^\circ\text{C}$	
Temperature coefficient		2.66		$\text{mV} / ^\circ\text{C}$	Change in sensor output voltage versus change in temperature
Typical output voltage		794		mV	Typical sensor output voltage at $T_A = 25^\circ\text{C}$, $V_{DD} = 3.0\text{ V}$
VDD coefficient		1.17		mV / V	Change in sensor output voltage versus change in VDD

The CC1200 device can be configured to provide a voltage proportional to temperature on GPIO1. The temperature can be estimated by measuring this voltage (see [Section 4.19, Temperature Sensor](#)). For more information, see the temperature sensor design note ([SWRA415](#)).

4.20 Typical Characteristics

T_A = 25°C, VDD = 3.0 V, f_c = 869.5 MHz if nothing else stated

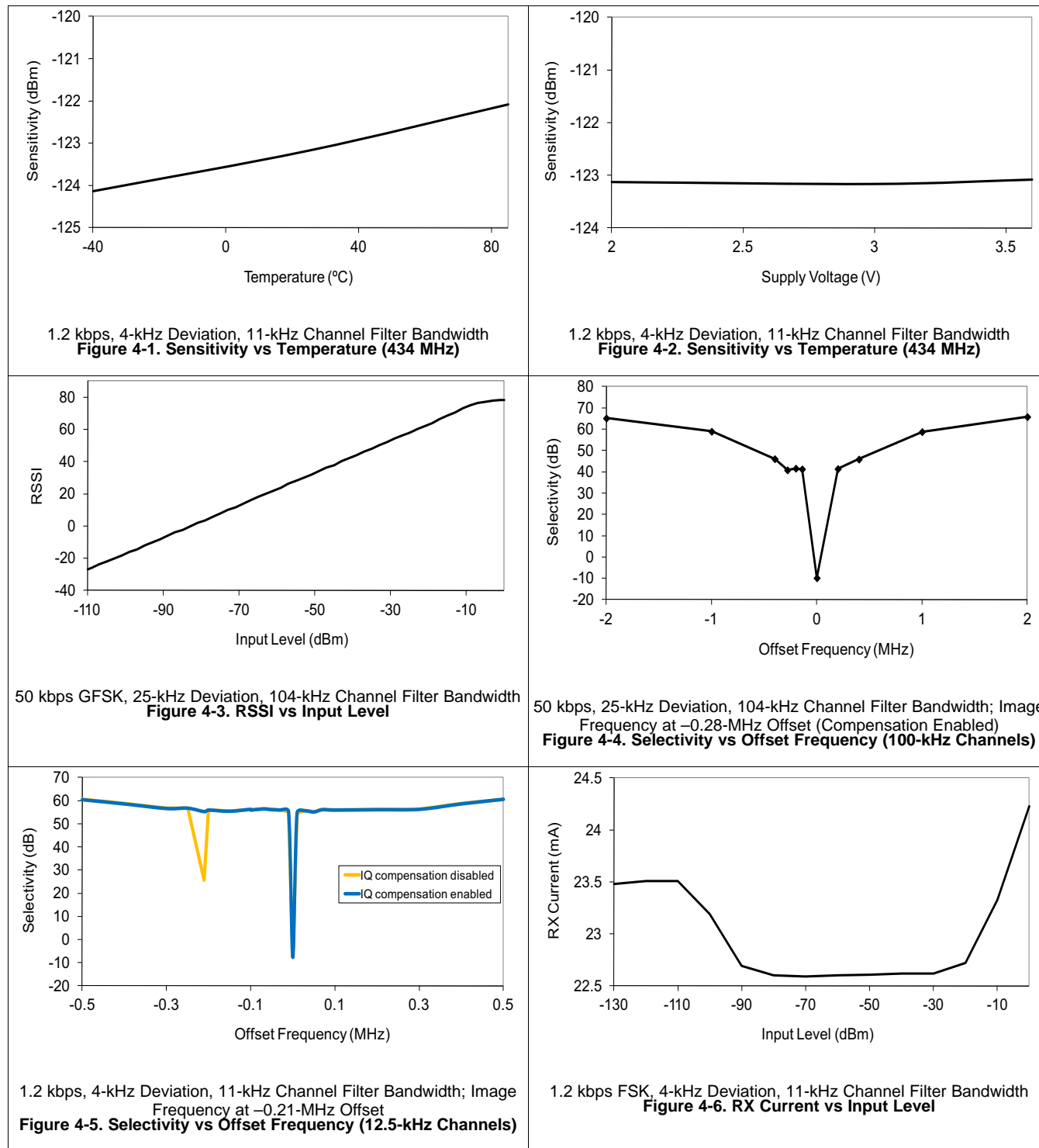

Typical Characteristics (continued)

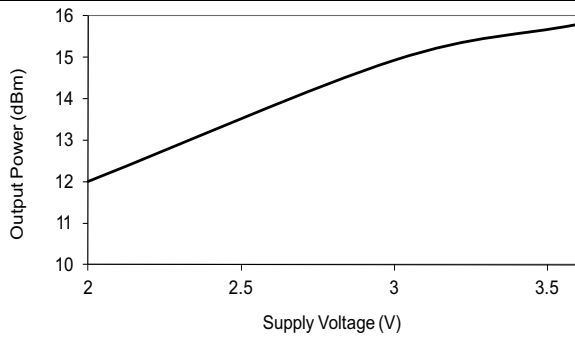

Maximum Output Power Setting (0x7F)
Figure 4-7. Output Power vs Supply Voltage

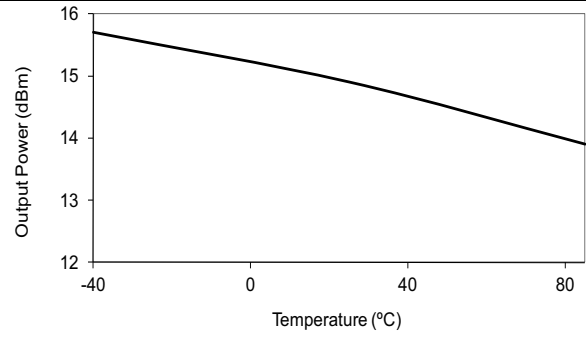

Maximum Power Setting (0x7F)
Figure 4-8. Output Power vs Temperature

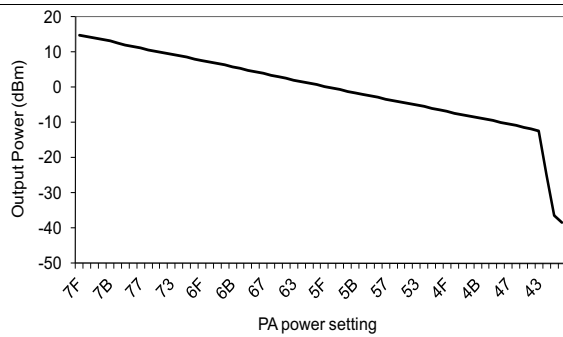

Figure 4-9. Output Power at 868 MHz PA Power Setting

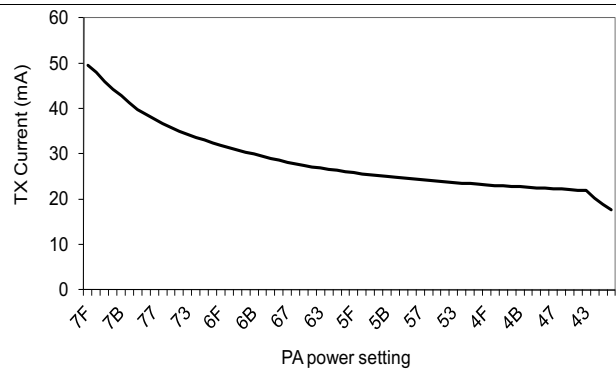
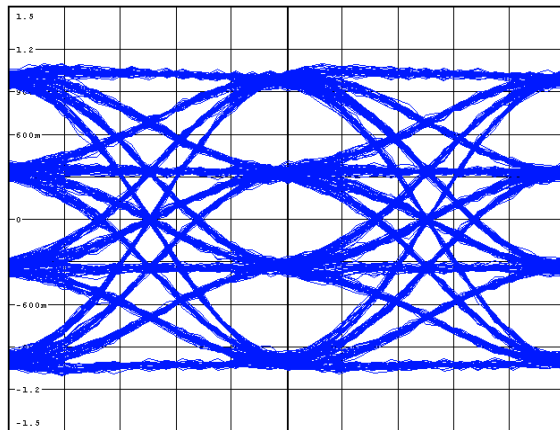
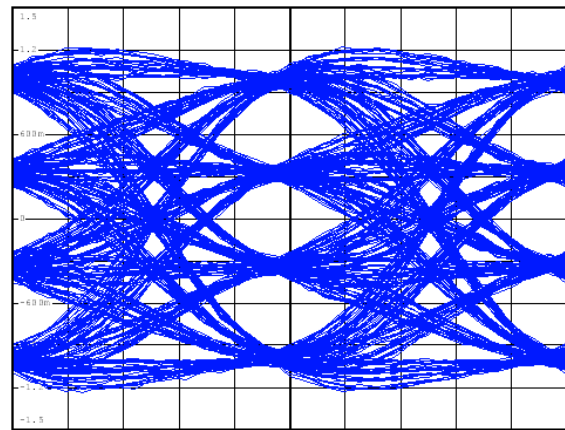

Figure 4-10. TX Current at 868 MHz vs PA Power Setting



1 Mbps 4-GFSK, 400-kHz Deviation, 500-kHz Loop Bandwidth
Figure 4-11. Eye Diagram



1 Mbps 4-GFSK, 400-kHz Deviation, 300-kHz Loop Bandwidth
Figure 4-12. Eye Diagram

Typical Characteristics (continued)

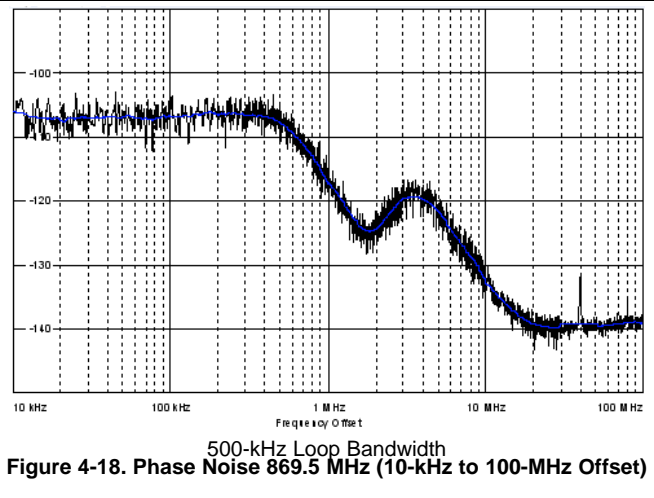
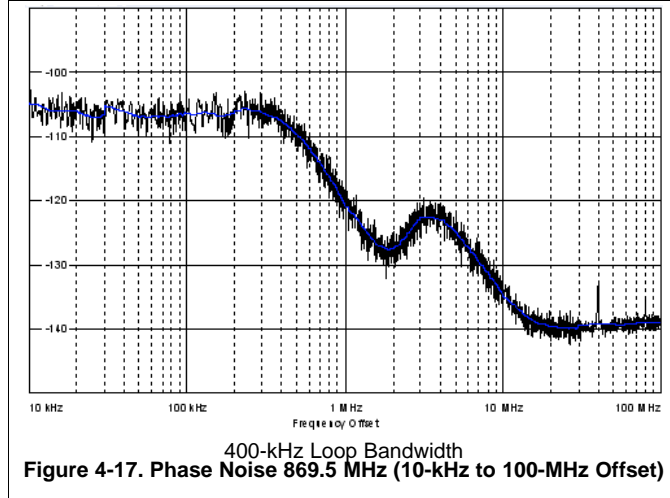
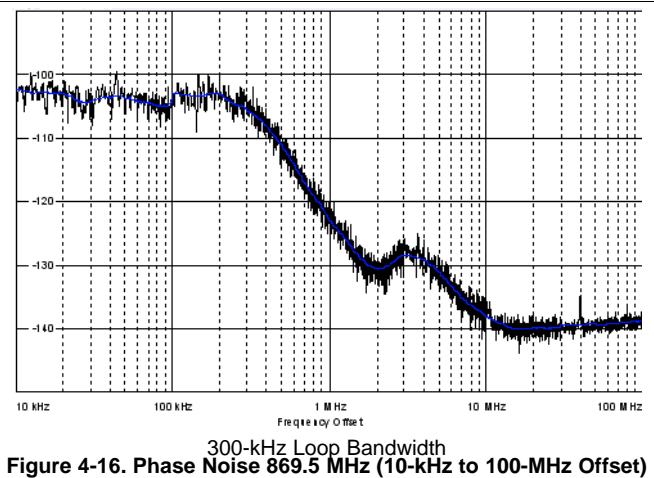
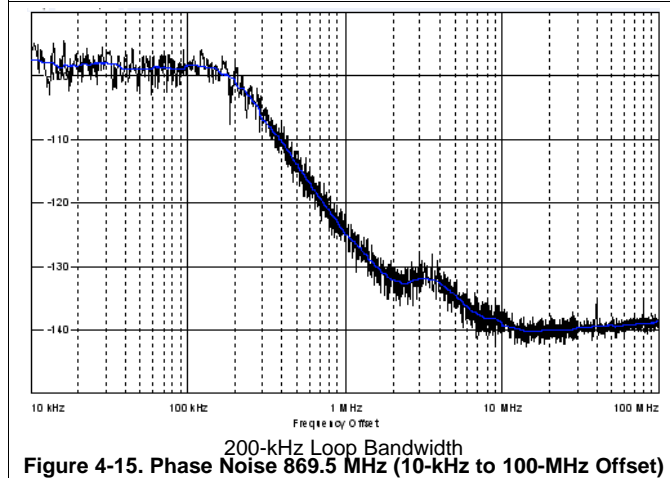
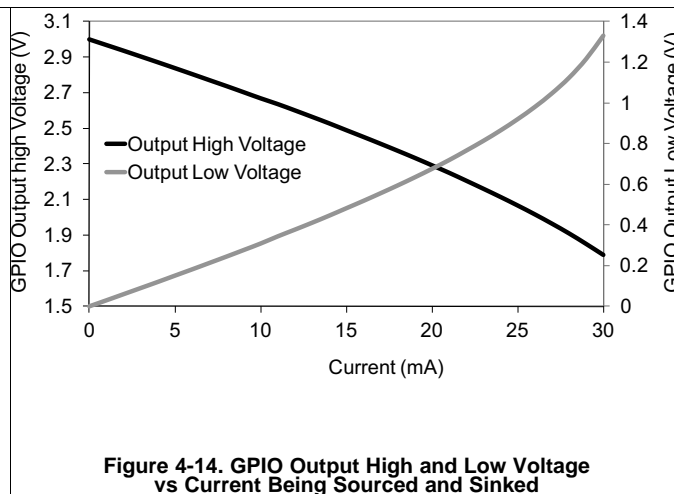
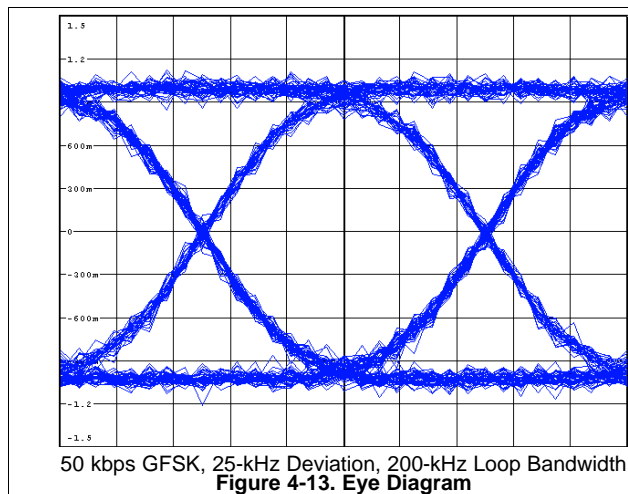

5 Detailed Description

5.1 Block Diagram

Figure 5-1 shows the system block diagram of the CC120x family of devices.

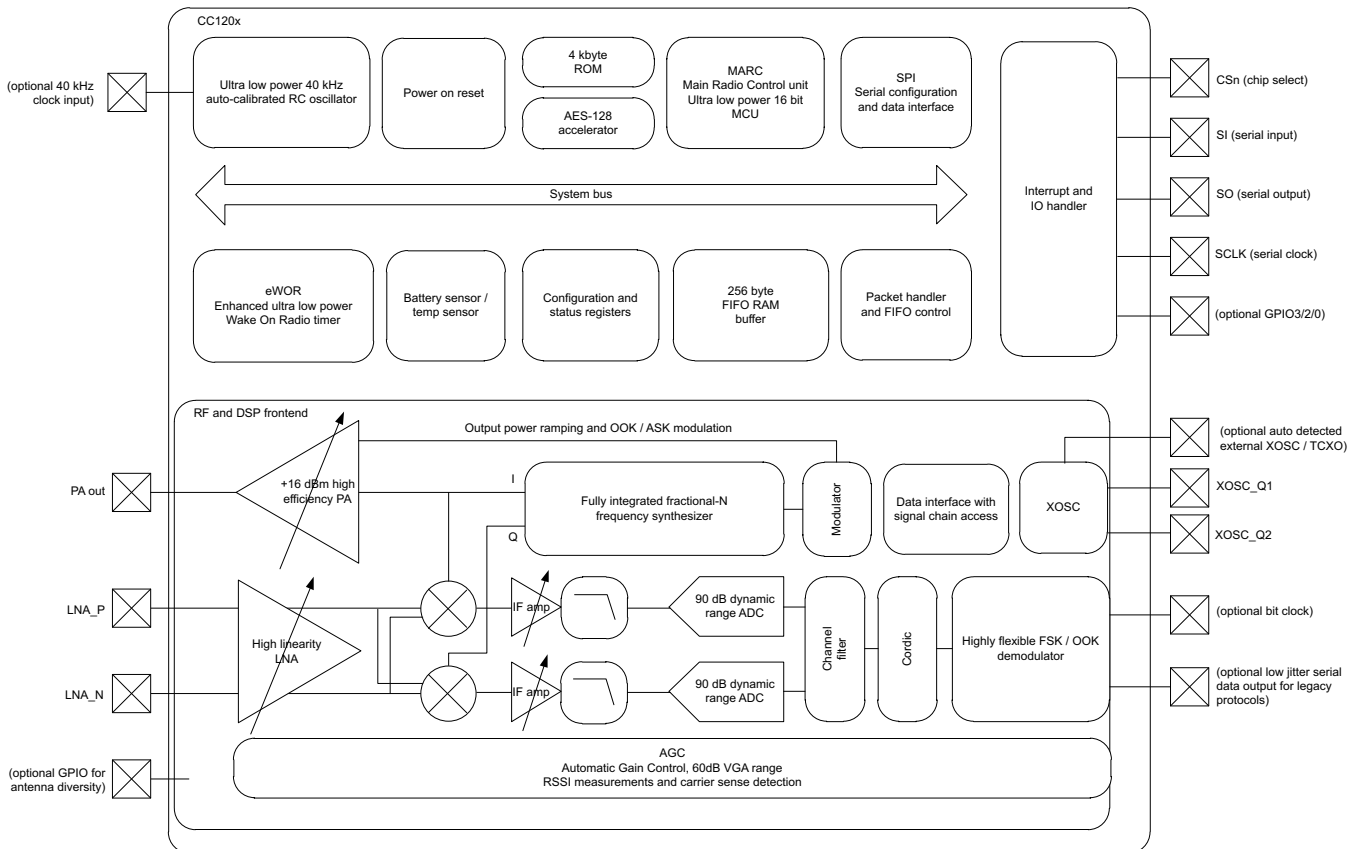

Figure 5-1. System Block Diagram

5.2 Frequency Synthesizer

At the center of the CC1200 device there is a fully integrated, fractional-N, ultra-high-performance frequency synthesizer. The frequency synthesizer is designed for excellent phase noise performance, providing very high selectivity and blocking performance. The system is designed to comply with the most stringent regulatory spectral masks at maximum transmit power.

Either a crystal can be connected to XOSC_Q1 and XOSC_Q2, or a TCXO can be connected to the EXT_XOSC input. The oscillator generates the reference frequency for the synthesizer, as well as clocks for the analog-to-digital converter (ADC) and the digital part. To reduce system cost, the CC1200 device has high-accuracy frequency estimation and compensation registers to measure and compensate for crystal inaccuracies. This compensation enables the use of lower cost crystals. If a TCXO is used, the CC1200 device automatically turns on and off the TCXO when needed to support low-power modes and Wake-On-Radio operation.

5.3 Receiver

The CC1200 device features a highly flexible receiver. The received RF signal is amplified by the low-noise amplifier (LNA) and is down-converted in quadrature (I/Q) to the intermediate frequency (IF). At IF, the I/Q signals are digitized by the high dynamic-range ADCs.

An advanced automatic gain control (AGC) unit adjusts the front-end gain, and enables the CC1200 device to receive strong and weak signals, even in the presence of strong interferers. High-attenuation channels and data filtering enable reception with strong neighbor channel interferers. The I/Q signal is converted to a phase and magnitude signal to support the FSK and OOK modulation schemes.

NOTE

A unique I/Q compensation algorithm removes any problem of I/Q mismatch, thus avoiding time-consuming and costly I/Q image calibration steps.

5.4 Transmitter

The CC1200 transmitter is based on direct synthesis of the RF frequency (in-loop modulation). To use the spectrum effectively, the CC1200 device has extensive data filtering and shaping in TX mode to support high throughput data communication in narrowband channels. The modulator also controls power ramping to remove issues such as spectral splattering when driving external high-power RF amplifiers.

5.5 Radio Control and User Interface

The CC1200 digital control system is built around the main radio control (MARC), which is implemented using an internal high-performance, 16-bit ultra-low-power processor. MARC handles power modes, radio sequencing, and protocol timing.

A 4-wire SPI serial interface is used for configuration and data buffer access. The digital baseband includes support for channel configuration, packet handling, and data buffering. The host MCU can stay in power-down mode until a valid RF packet is received. This greatly reduces power consumption. When the host MCU receives a valid RF packet, it burst-reads the data. This reduces the required computing power.

The CC1200 radio control and user interface are based on the widely used CC1101 transceiver. This relationship enables an easy transition between the two platforms. The command strobes and the main radio states are the same for the two platforms.

For legacy formats, the CC1200 device also supports two serial modes.

- Synchronous serial mode: The CC1200 device performs bit synchronization and provides the MCU with a bit clock with associated data.
- Transparent mode: The CC1200 device outputs the digital baseband signal using a digital interpolation filter to eliminate jitter introduced by digital filtering and demodulation.

5.6 Enhanced Wake-On-Radio (eWOR)

eWOR, using a flexible integrated sleep timer, enables automatic receiver polling with no intervention from the MCU. When the CC1200 device enters RX mode, it listens and then returns to sleep if a valid RF packet is not received. The sleep interval and duty cycle can be configured to make a trade-off between network latency and power consumption. Incoming messages are time-stamped to simplify timer re-synchronization.

The eWOR timer runs off an ultra-low-power RC oscillator. To improve timing accuracy, the RC oscillator can be automatically calibrated to the RF crystal in configurable intervals.

5.7 RX Sniff Mode

The CC1200 device supports quick start up times, and requires few preamble bits. RX Sniff Mode uses these conditions to dramatically reduce the current consumption while the receiver is waiting for data.

Because the CC1200 device can wake up and settle much faster than the duration of most preambles, it is not required to be in RX mode continuously while waiting for a packet to arrive. Instead, the enhanced Wake-On-Radio feature can be used to put the device into sleep mode periodically. By setting an appropriate sleep time, the CC1200 device can wake up and receive the packet when it arrives with no performance loss. This sequence removes the need for accurate timing synchronization between transmitter and receiver, and lets the user trade off current consumption between the transmitter and receiver.

For more information, see the RX Sniff Mode design note ([SWRA428](#)).

5.8 Antenna Diversity

Antenna diversity can increase performance in a multipath environment. An external antenna switch is required. The CC1200 device uses one of the GPIO pins to automatically control the switch. This device also supports differential output control signals typically used in RF switches.

If antenna diversity is enabled, the GPIO alternates between high and low states until a valid RF input signal is detected. An optional acknowledge packet can be transmitted without changing the state of the GPIO.

An incoming RF signal can be validated by received signal strength or by using the automatic preamble detector. Using the automatic preamble detector ensures a more robust system and avoids the need to set a defined signal strength threshold (such a threshold sets the sensitivity limit of the system).

5.9 WaveMatch

Advanced capture logic locks onto the synchronization word and does not require preamble settling bytes. Therefore, receiver settling time is reduced to the settling time of the AGC, typically 4 bits.

The WaveMatch feature also greatly reduces false sync triggering on noise, further reducing the power consumption and improving sensitivity and reliability. The same logic can also be used as a high-performance preamble detector to reliably detect a valid preamble in the channel.

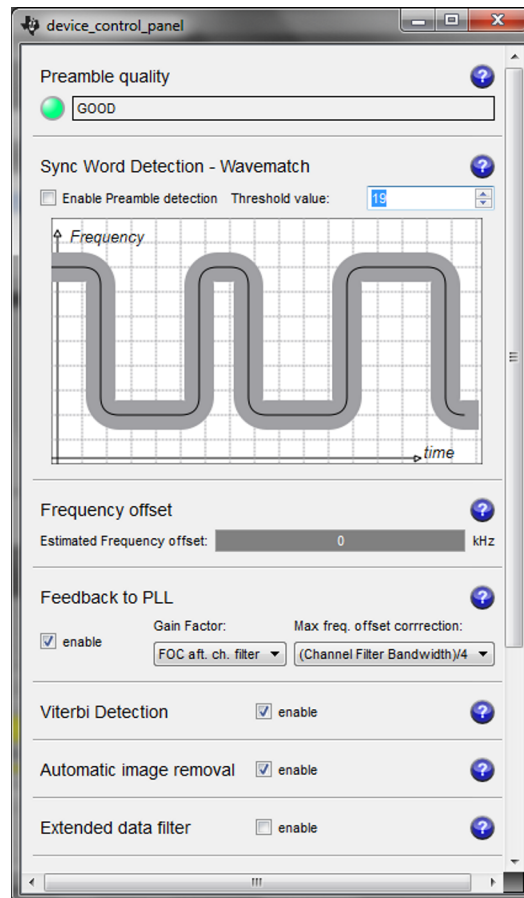

See [SWRC046](#) for more information.

Figure 5-2. Receiver Configurator in SmartRF™ Studio

6 Typical Application Circuit

NOTE

This section is intended only as an introduction.

Very few external components are required for the operation of the CC1200 device. [Figure 6-1](#) shows a typical application circuit. The board layout will greatly influence the RF performance of the CC1200 device. Also, [Figure 6-1](#) does not show decoupling capacitors for power pins.

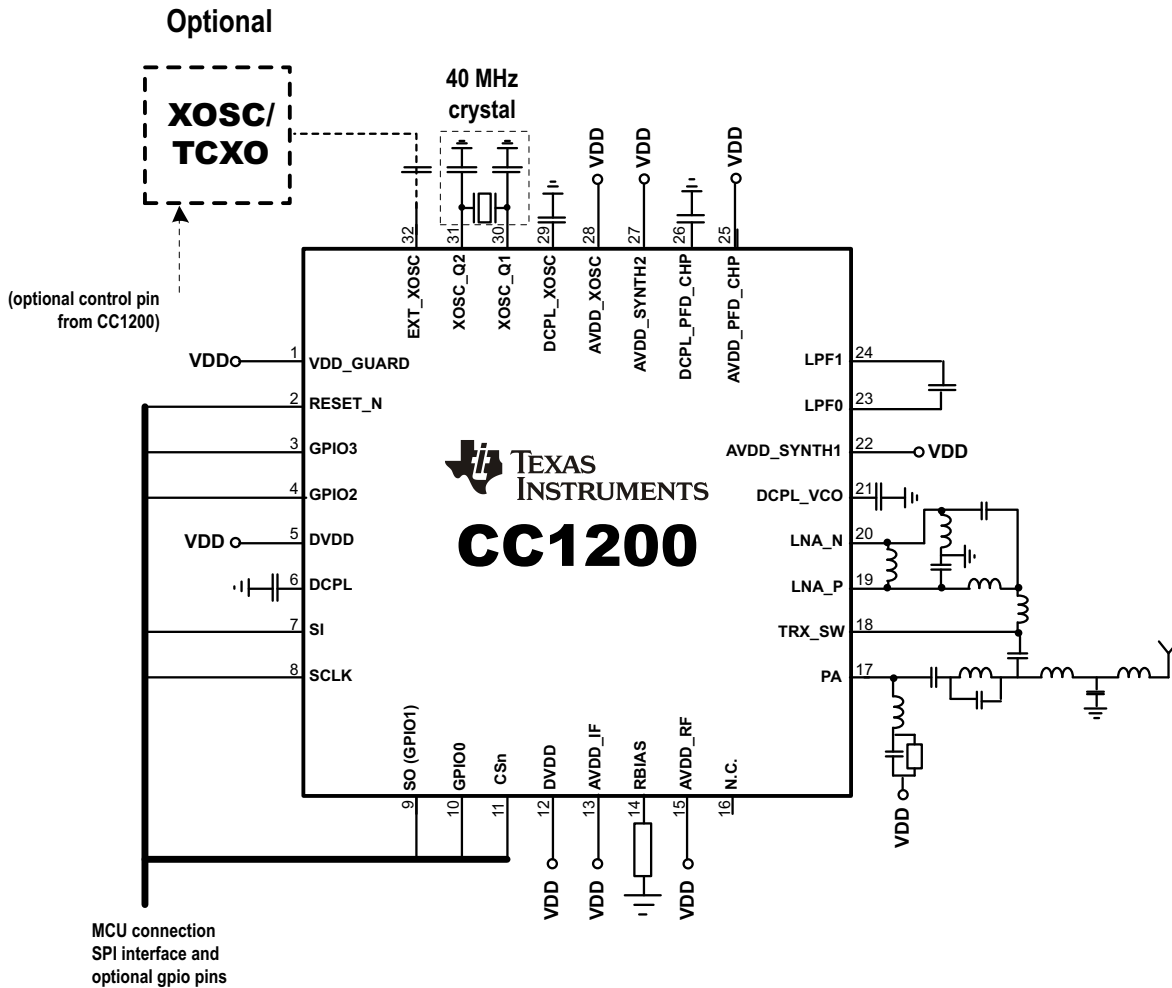

Figure 6-1. Typical Application Circuit

For more information, see the reference designs available for the CC1200 device in [Section 7.2, Documentation Support](#).

7 Device and Documentation Support

7.1 Device Support

7.1.1 Development Support

7.1.1.1 Configuration Software

The CC1200 device can be configured using the SmartRF Studio software ([SWRC046](#)). The SmartRF Studio software is highly recommended for obtaining optimum register settings, and for evaluating performance and functionality.

7.1.2 Device and Development-Support Tool Nomenclature

To designate the stages in the product development cycle, TI assigns prefixes to the part numbers of all microprocessors (MPUs) and support tools. Each device has one of three prefixes: X, P, or null (no prefix) (for example, CC1200). Texas Instruments recommends two of three possible prefix designators for its support tools: TMDX and TMDS. These prefixes represent evolutionary stages of product development from engineering prototypes (TMDX) through fully qualified production devices and tools (TMDS).

Device development evolutionary flow:

- X** Experimental device that is not necessarily representative of the final device's electrical specifications and may not use production assembly flow.
- P** Prototype device that is not necessarily the final silicon die and may not necessarily meet final electrical specifications.
- null** Production version of the silicon die that is fully qualified.

Support tool development evolutionary flow:

- TMDX** Development-support product that has not yet completed Texas Instruments internal qualification testing.
- TMDS** Fully qualified development-support product.

X and P devices and TMDX development-support tools are shipped against the following disclaimer:

"Developmental product is intended for internal evaluation purposes."

Production devices and TMDS development-support tools have been characterized fully, and the quality and reliability of the device have been demonstrated fully. TI's standard warranty applies.

Predictions show that prototype devices (X or P) have a greater failure rate than the standard production devices. Texas Instruments recommends that these devices not be used in any production system because their expected end-use failure rate still is undefined. Only qualified production devices are to be used.

TI device nomenclature also includes a suffix with the device family name. This suffix indicates the package type (for example, RHB) and the temperature range (for example, blank is the default commercial temperature range) provides a legend for reading the complete device name for any CC1200 device.

For orderable part numbers of CC1200 devices in the QFN package types, see the Package Option Addendum of this document, the TI website (www.ti.com), or contact your TI sales representative.

7.2 Documentation Support

The following documents supplement the CC1200 processor. Copies of these documents are available on the Internet at www.ti.com. *Tip:* Enter the literature number in the search box provided at www.ti.com.

[SWRR106](#) CC112x IPC 868- and 915-MHz 2-layer Reference Design

[SWRR107](#) CC112x IPC 868- and 915-MHz 4-layer Reference Design

[SWRR122](#) CC1200EM 420- to 470-MHz Reference Design

[SWRR121](#) CC1200EM 868- to 930-MHz Reference Design

[SWRC046](#) SmartRF Studio Software

[SWRA428](#) CC112x/CC120x Sniff Mode Application Note

7.3 Community Resources

The following links connect to TI community resources. Linked contents are provided "AS IS" by the respective contributors. They do not constitute TI specifications and do not necessarily reflect TI's views; see TI's [Terms of Use](#).

[TI E2E™ Online Community](#) *TI's Engineer-to-Engineer (E2E) Community*. Created to foster collaboration among engineers. At e2e.ti.com, you can ask questions, share knowledge, explore ideas and help solve problems with fellow engineers.

[TI Embedded Processors Wiki](#) *Texas Instruments Embedded Processors Wiki*. Established to help developers get started with Embedded Processors from Texas Instruments and to foster innovation and growth of general knowledge about the hardware and software surrounding these devices.

7.4 Trademarks

SmartRF, E2E are trademarks of Texas Instruments.
All other trademarks are the property of their respective owners.

7.5 Electrostatic Discharge Caution



This integrated circuit can be damaged by ESD. Texas Instruments recommends that all integrated circuits be handled with appropriate precautions. Failure to observe proper handling and installation procedures can cause damage.

ESD damage can range from subtle performance degradation to complete device failure. Precision integrated circuits may be more susceptible to damage because very small parametric changes could cause the device not to meet its published specifications.

7.6 Glossary

[SLYZ022](#) — *TI Glossary*.

This glossary lists and explains terms, acronyms, and definitions.

8 Mechanical Packaging and Orderable Information

The following pages include mechanical packaging and orderable information. This information is the most current data available for the designated devices. This data is subject to change without notice and revision of this document. For browser-based versions of this data sheet, refer to the left-hand navigation.

PACKAGING INFORMATION

Orderable part number	Status (1)	Material type (2)	Package Pins	Package qty Carrier	RoHS (3)	Lead finish/ Ball material (4)	MSL rating/ Peak reflow (5)	Op temp (°C)	Part marking (6)
CC1200RHBR	Active	Production	VQFN (RHB) 32	3000 LARGE T&R	Yes	NIPDAU NIPDAUAG	Level-2-260C-1 YEAR	-40 to 85	CC1200
CC1200RHBR.A	Active	Production	VQFN (RHB) 32	3000 LARGE T&R	Yes	NIPDAU	Level-2-260C-1 YEAR	-40 to 85	CC1200
CC1200RHBR.B	Active	Production	VQFN (RHB) 32	3000 LARGE T&R	Yes	NIPDAU	Level-2-260C-1 YEAR	-40 to 85	CC1200
CC1200RHBT	Active	Production	VQFN (RHB) 32	250 SMALL T&R	Yes	NIPDAU NIPDAUAG	Level-2-260C-1 YEAR	-40 to 85	CC1200
CC1200RHBT.A	Active	Production	VQFN (RHB) 32	250 SMALL T&R	Yes	NIPDAU	Level-2-260C-1 YEAR	-40 to 85	CC1200
CC1200RHBT.B	Active	Production	VQFN (RHB) 32	250 SMALL T&R	Yes	NIPDAU	Level-2-260C-1 YEAR	-40 to 85	CC1200

⁽¹⁾ **Status:** For more details on status, see our [product life cycle](#).

⁽²⁾ **Material type:** When designated, preproduction parts are prototypes/experimental devices, and are not yet approved or released for full production. Testing and final process, including without limitation quality assurance, reliability performance testing, and/or process qualification, may not yet be complete, and this item is subject to further changes or possible discontinuation. If available for ordering, purchases will be subject to an additional waiver at checkout, and are intended for early internal evaluation purposes only. These items are sold without warranties of any kind.

⁽³⁾ **RoHS values:** Yes, No, RoHS Exempt. See the [TI RoHS Statement](#) for additional information and value definition.

⁽⁴⁾ **Lead finish/Ball material:** Parts may have multiple material finish options. Finish options are separated by a vertical ruled line. Lead finish/Ball material values may wrap to two lines if the finish value exceeds the maximum column width.

⁽⁵⁾ **MSL rating/Peak reflow:** The moisture sensitivity level ratings and peak solder (reflow) temperatures. In the event that a part has multiple moisture sensitivity ratings, only the lowest level per JEDEC standards is shown. Refer to the shipping label for the actual reflow temperature that will be used to mount the part to the printed circuit board.

⁽⁶⁾ **Part marking:** There may be an additional marking, which relates to the logo, the lot trace code information, or the environmental category of the part.

Multiple part markings will be inside parentheses. Only one part marking contained in parentheses and separated by a "~" will appear on a part. If a line is indented then it is a continuation of the previous line and the two combined represent the entire part marking for that device.

Important Information and Disclaimer: The information provided on this page represents TI's knowledge and belief as of the date that it is provided. TI bases its knowledge and belief on information provided by third parties, and makes no representation or warranty as to the accuracy of such information. Efforts are underway to better integrate information from third parties. TI has taken and continues to take reasonable steps to provide representative and accurate information but may not have conducted destructive testing or chemical analysis on incoming materials and chemicals. TI and TI suppliers consider certain information to be proprietary, and thus CAS numbers and other limited information may not be available for release.

In no event shall TI's liability arising out of such information exceed the total purchase price of the TI part(s) at issue in this document sold by TI to Customer on an annual basis.

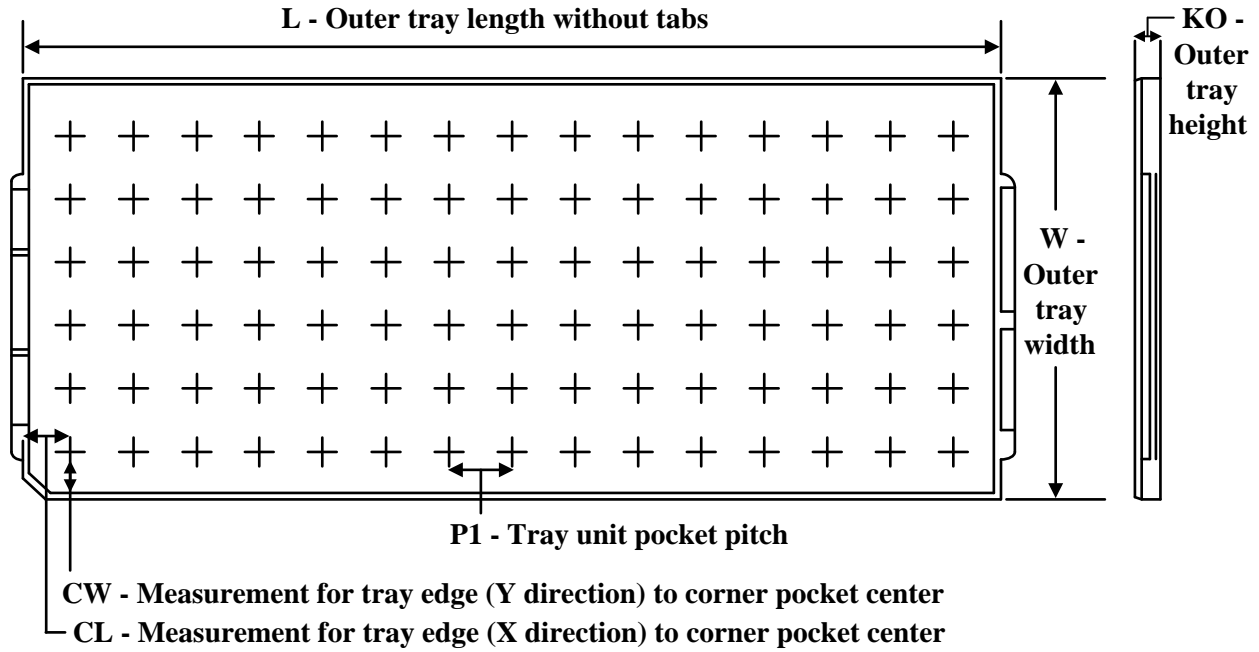
TRAY

Chamfer on Tray corner indicates Pin 1 orientation of packed units.

*All dimensions are nominal

Device	Package Name	Package Type	Pins	SPQ	Unit array matrix	Max temperature (°C)	L (mm)	W (mm)	K0 (µm)	P1 (mm)	CL (mm)	CW (mm)
CC1200RHBR	RHB	VQFN	32	3000	14 x 35	150	315	135.9	7620	8.8	7.9	8.15
CC1200RHBR.A	RHB	VQFN	32	3000	14 x 35	150	315	135.9	7620	8.8	7.9	8.15
CC1200RHBR.B	RHB	VQFN	32	3000	14 x 35	150	315	135.9	7620	8.8	7.9	8.15
CC1200RHBT	RHB	VQFN	32	250	14 x 35	150	315	135.9	7620	8.8	7.9	8.15
CC1200RHBT	RHB	VQFN	32	250	14 x 35	150	315	135.9	7620	8.8	7.9	8.15
CC1200RHBT.A	RHB	VQFN	32	250	14 x 35	150	315	135.9	7620	8.8	7.9	8.15
CC1200RHBT.A	RHB	VQFN	32	250	14 x 35	150	315	135.9	7620	8.8	7.9	8.15
CC1200RHBT.B	RHB	VQFN	32	250	14 x 35	150	315	135.9	7620	8.8	7.9	8.15
CC1200RHBT.B	RHB	VQFN	32	250	14 x 35	150	315	135.9	7620	8.8	7.9	8.15

GENERIC PACKAGE VIEW

RHB 32

VQFN - 1 mm max height

5 x 5, 0.5 mm pitch

PLASTIC QUAD FLATPACK - NO LEAD

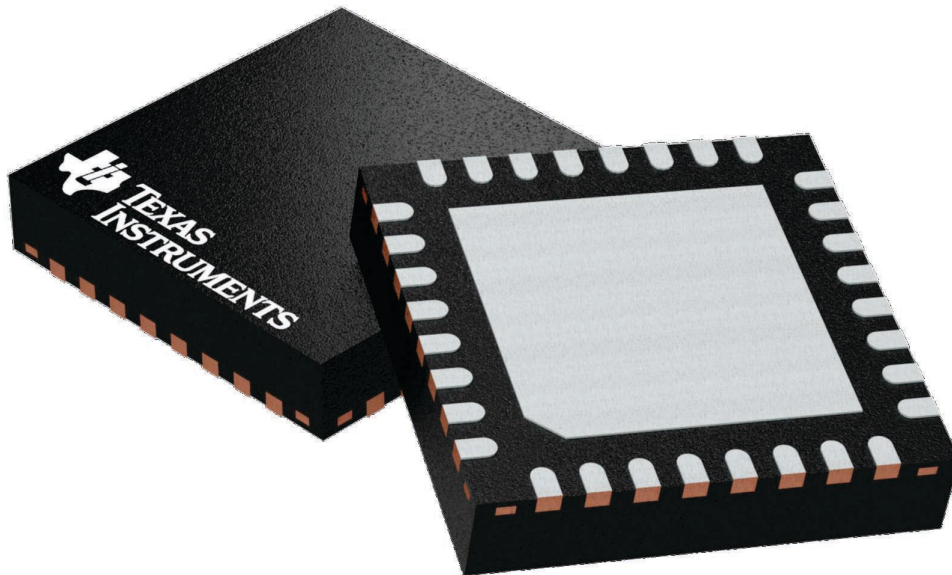

Images above are just a representation of the package family, actual package may vary.
Refer to the product data sheet for package details.

4224745/A

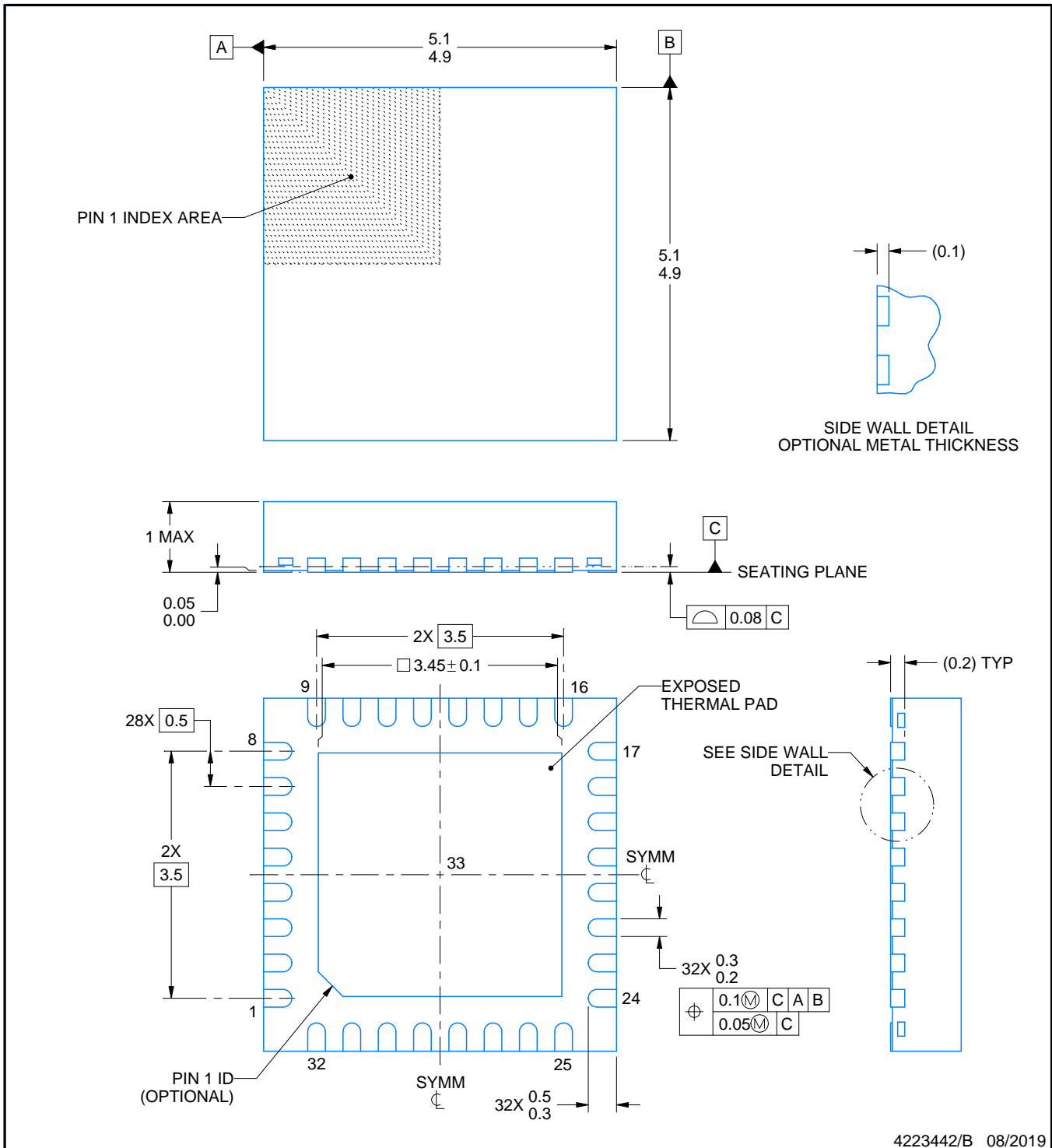

4223442/B 08/2019

NOTES:

1. All linear dimensions are in millimeters. Any dimensions in parenthesis are for reference only. Dimensioning and tolerancing per ASME Y14.5M.
2. This drawing is subject to change without notice.
3. The package thermal pad must be soldered to the printed circuit board for thermal and mechanical performance.

EXAMPLE BOARD LAYOUT

RHB0032E

VQFN - 1 mm max height

PLASTIC QUAD FLATPACK - NO LEAD



LAND PATTERN EXAMPLE
SCALE:18X

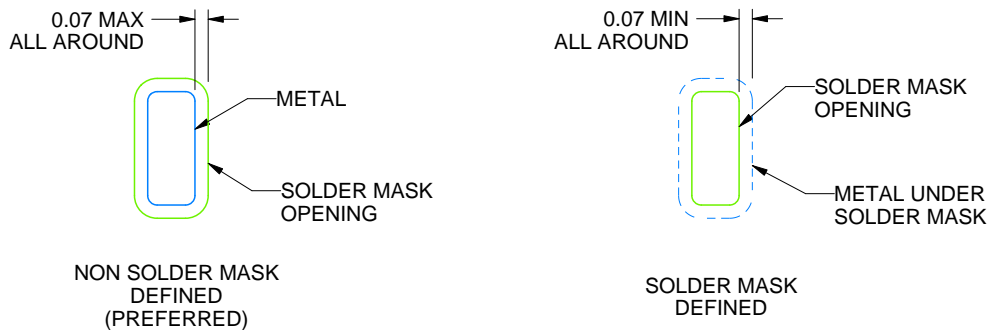

SOLDER MASK DETAILS

4223442/B 08/2019

NOTES: (continued)

4. This package is designed to be soldered to a thermal pad on the board. For more information, see Texas Instruments literature number SLUA271 (www.ti.com/lit/sluea271).
5. Vias are optional depending on application, refer to device data sheet. If any vias are implemented, refer to their locations shown on this view. It is recommended that vias under paste be filled, plugged or tented.

EXAMPLE STENCIL DESIGN

RHB0032E

VQFN - 1 mm max height

PLASTIC QUAD FLATPACK - NO LEAD

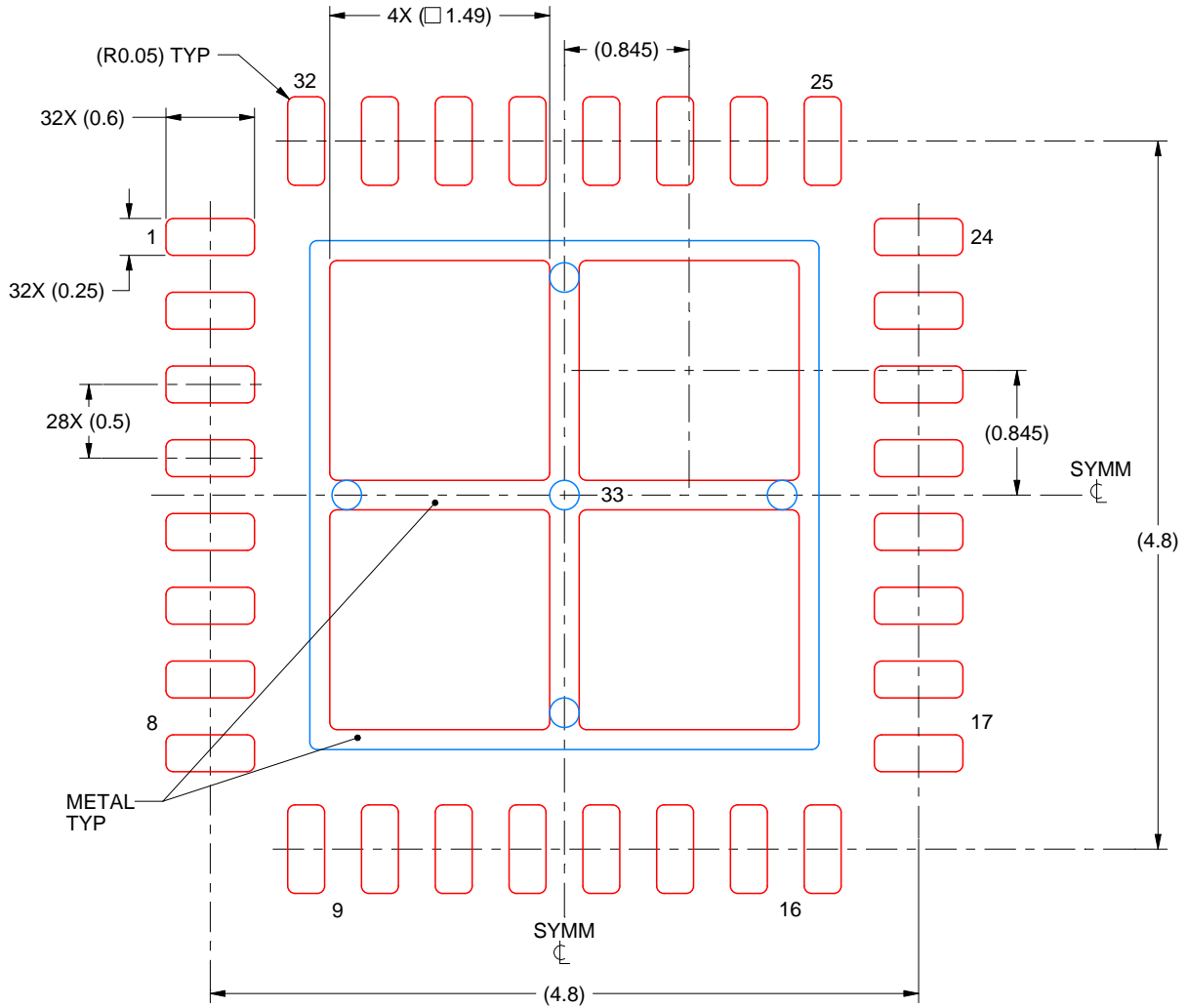

SOLDER PASTE EXAMPLE
 BASED ON 0.125 mm THICK STENCIL

EXPOSED PAD 33:
 75% PRINTED SOLDER COVERAGE BY AREA UNDER PACKAGE
 SCALE:20X

4223442/B 08/2019

NOTES: (continued)

6. Laser cutting apertures with trapezoidal walls and rounded corners may offer better paste release. IPC-7525 may have alternate design recommendations.

IMPORTANT NOTICE AND DISCLAIMER

TI PROVIDES TECHNICAL AND RELIABILITY DATA (INCLUDING DATASHEETS), DESIGN RESOURCES (INCLUDING REFERENCE DESIGNS), APPLICATION OR OTHER DESIGN ADVICE, WEB TOOLS, SAFETY INFORMATION, AND OTHER RESOURCES "AS IS" AND WITH ALL FAULTS, AND DISCLAIMS ALL WARRANTIES, EXPRESS AND IMPLIED, INCLUDING WITHOUT LIMITATION ANY IMPLIED WARRANTIES OF MERCHANTABILITY, FITNESS FOR A PARTICULAR PURPOSE OR NON-INFRINGEMENT OF THIRD PARTY INTELLECTUAL PROPERTY RIGHTS.

These resources are intended for skilled developers designing with TI products. You are solely responsible for (1) selecting the appropriate TI products for your application, (2) designing, validating and testing your application, and (3) ensuring your application meets applicable standards, and any other safety, security, regulatory or other requirements.

These resources are subject to change without notice. TI grants you permission to use these resources only for development of an application that uses the TI products described in the resource. Other reproduction and display of these resources is prohibited. No license is granted to any other TI intellectual property right or to any third party intellectual property right. TI disclaims responsibility for, and you fully indemnify TI and its representatives against any claims, damages, costs, losses, and liabilities arising out of your use of these resources.

TI's products are provided subject to [TI's Terms of Sale](#), [TI's General Quality Guidelines](#), or other applicable terms available either on [ti.com](#) or provided in conjunction with such TI products. TI's provision of these resources does not expand or otherwise alter TI's applicable warranties or warranty disclaimers for TI products. Unless TI explicitly designates a product as custom or customer-specified, TI products are standard, catalog, general purpose devices.

TI objects to and rejects any additional or different terms you may propose.

Copyright © 2025, Texas Instruments Incorporated

Last updated 10/2025