

±3-A HIGH-EFFICIENCY PWM POWER DRIVER

 Check for Samples: [DRV593](#), [DRV594](#)

FEATURES

- Operation Reduces Output Filter Size and Cost by 50% Compared to DRV591
- ±3-A Maximum Output Current
- Low Supply Voltage Operation: 2.8 V to 5.5 V
- High Efficiency Generates Less Heat
- Overcurrent and Thermal Protection
- Fault Indicators for Overcurrent, Thermal and Undervoltage Conditions
- Two Selectable Switching Frequencies
- Internal or External Clock Sync
- PWM Scheme Optimized for EMI
- 9×9 mm PowerPAD™ Quad Flatpack Package

APPLICATIONS

- Thermoelectric Cooler (TEC) Driver
- Laser Diode Biasing

DESCRIPTION

The DRV593 and DRV594 are high-efficiency, high-current power amplifiers ideal for driving a wide variety of thermoelectric cooler elements in systems powered from 2.8 V to 5.5 V. The operation of the device requires only one inductor and capacitor for the output filter, saving significant printed-circuit board area. Pulse-width modulation (PWM) operation and low output stage on-resistance significantly decrease power dissipation in the amplifier.

The DRV593 and DRV594 are internally protected against thermal and current overloads. Logic-level fault indicators signal when the junction temperature has reached approximately 128°C to allow for system-level shutdown before the amplifier's internal thermal shutdown circuitry activates. The fault indicators also signal when an overcurrent event has occurred. If the overcurrent circuitry is tripped, the devices automatically reset (see application information section for more details).

The PWM switching frequency may be set to 500 kHz or 100 kHz depending on system requirements. To eliminate external components, the gain is fixed at 2.3 V/V for the DRV593. For the DRV594, the gain is fixed at 14.5 V/V.

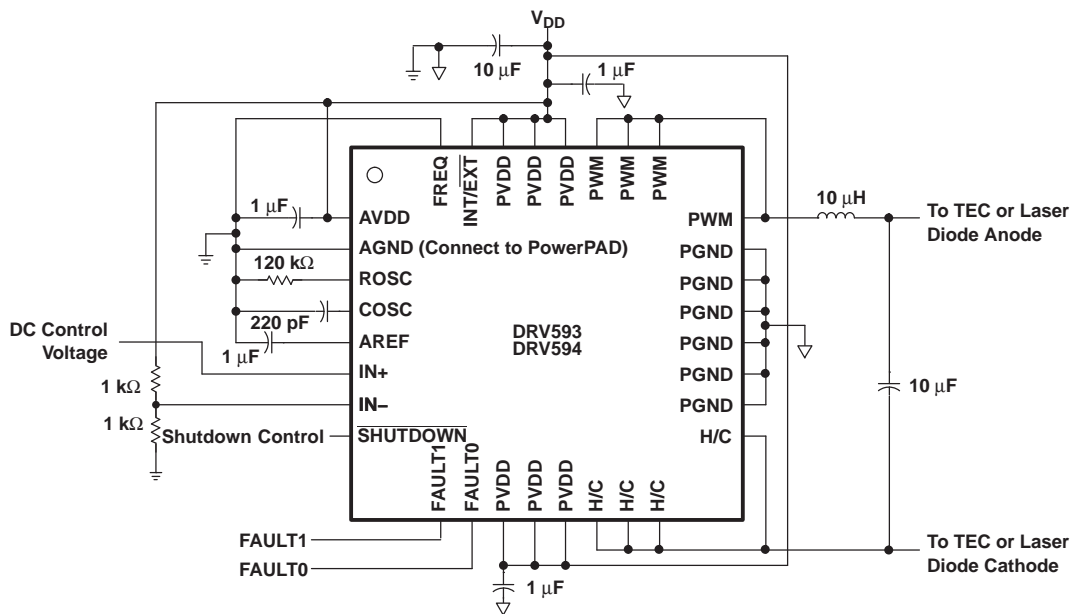

Please be aware that an important notice concerning availability, standard warranty, and use in critical applications of Texas Instruments semiconductor products and disclaimers thereto appears at the end of this data sheet.

PowerPAD is a trademark of Texas Instruments.



This integrated circuit can be damaged by ESD. Texas Instruments recommends that all integrated circuits be handled with appropriate precautions. Failure to observe proper handling and installation procedures can cause damage.

ESD damage can range from subtle performance degradation to complete device failure. Precision integrated circuits may be more susceptible to damage because very small parametric changes could cause the device not to meet its published specifications.

Table 1. ORDERING INFORMATION⁽¹⁾

T_A	PowerPAD QUAD FLATPACK (VFP)
-40°C to 85°C	DRV593VFP ⁽²⁾
	DRV594VFP ⁽²⁾

- (1) For the most current package and ordering information, see the Package Option Addendum at the end of this document, or see the TI Web site at www.ti.com
- (2) This package is available taped and reeled. To order this packaging option, add an R suffix to the part number (e.g., DRV593VFPR or DRV594VFPR).

ABSOLUTE MAXIMUM RATINGS

over operating free-air temperature range unless otherwise noted⁽¹⁾

		DRV593, DRV594
AVDD, PVDD	Supply voltage	-0.3 V to 5.5 V
V_I	Input voltage	-0.3 V to $V_{DD} + 0.3$ V
I_O (FAULT0, FAULT1)	Output current	1 mA
Continuous total power dissipation		See Dissipation Rating Table
T_A	Operating free-air temperature range	-40°C to 85°C
T_J	Operating junction temperature range	-40°C to 150°C
T_{stg}	Storage temperature range	-65°C to 165°C

- (1) Stresses beyond those listed under absolute maximum ratings may cause permanent damage to the device. These are stress ratings only, and functional operation of the device at these or any other conditions beyond those indicated under recommended operating conditions is not implied. Exposure to absolute-maximum-rated conditions for extended periods may affect device reliability.

RECOMMENDED OPERATING CONDITIONS

			MIN	MAX	UNIT
AVDD, PVDD	Supply voltage		2.8	5.5	V
V_{IH}	High-level input voltage	FREQ, INT/EXT, SHUTDOWN, COSC	2		V
V_{IL}	Low-level input voltage	FREQ, INT/EXT, SHUTDOWN, COSC		0.8	V
T_A	Operating free-air temperature		-40	85	°C

PACKAGE DISSIPATION RATINGS

PACKAGE	θ_{JA} ⁽¹⁾ (°C/W)	θ_{JC} (°C/W)	$T_A=25^\circ\text{C}$ POWER RATING
VFP	29.4	1.2	4.1 W

- (1) This data was taken using 2 oz trace and copper pad that is soldered directly to a JEDEC standard 4-layer 3 in x 3 in PCB.

ELECTRICAL CHARACTERISTICS

over operating free-air temperature range unless otherwise noted

PARAMETER		TEST CONDITIONS	MIN	TYP	MAX	UNIT	
$ V_{OO} $	Output offset voltage (measured differentially)	$V_I = V_{DD}/2$, $I_O = 0$ A	14	100		mV	
$ I_{IH} $	High-level input current	$V_{DD} = 5.5$ V, $V_I = V_{DD}$			1	μ A	
$ I_{IL} $	Low-level input current	$V_{DD} = 5.5$ V, $V_I = 0$ V			1	μ A	
V_n	Integrated output noise voltage	$f = <1$ Hz to 10 kHz		40		μ V	
V_{ICM}	Common-mode voltage range	$V_{DD} = 5$ V	1.2		3.8	V	
		$V_{DD} = 3.3$ V	1.2		2.1		
A_v	Closed-loop voltage gain	DRV593	2.1	2.3	2.6	V/V	
		DRV594	13.7	14.5	15.3	V/V	
	Full power bandwidth			60		kHz	
V_O	Voltage output (measured differentially)	$I_O = \pm 1$ A, $r_{DS(on)} = 65$ m Ω , $V_{DD} = 5$ V		4.87		V	
		$I_O = \pm 3$ A, $r_{DS(on)} = 65$ m Ω , $V_{DD} = 5$ V		4.61			
$r_{DS(on)}$	Drain-source on-state resistance	$V_{DD} = 5$ V, $I_O = 4$ A, $T_A = 25^\circ$ C	High side	25	60	95	m Ω
			Low side	25	65	95	
		$V_{DD} = 3.3$ V, $I_O = 4$ A, $T_A = 25^\circ$ C	High side	25	80	140	m Ω
			Low side	25	90	140	
	Maximum continuous current output			3		A	
	Status flag output pins (FAULT0, FAULT1) Fault active (open drain output)	Sinking 200 μ A			0.1	V	
	External clock frequency range	For 500 kHz operation	225	250	300	kHz	
		For 100 kHz operation	45	50	55		
I_q	Quiescent current	$V_{DD} = 5$ V, No load or filter		4	12	mA	
		$V_{DD} = 3.3$ V, No load or filter		2.5	8		
$I_{q(SD)}$	Quiescent current in shutdown mode	$V_{DD} = 5$ V, $\overline{SHUTDOWN} = 0.8$ V	0	40	80	μ A	
	Output resistance in shutdown	$\overline{SHUTDOWN} = 0.8$ V	1	2		k Ω	
	Power-on threshold		1.7		2.8	V	
	Power-off threshold		1.6		2.6	V	
	Thermal trip point	FAULT0 active		128		$^\circ$ C	
	Thermal shutdown	Power off		158		$^\circ$ C	
Z_I	Input impedance (IN+, IN-)			100		k Ω	

PIN ASSIGNMENTS

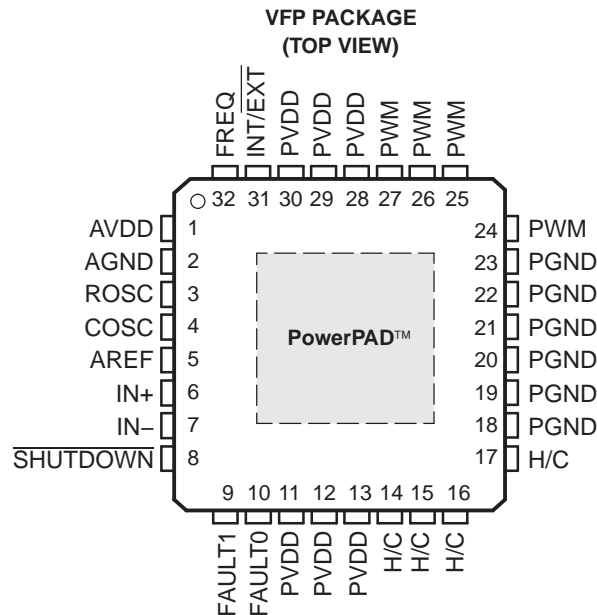

TERMINAL FUNCTIONS

TERMINAL NAME	TERMINAL NO.	I/O	DESCRIPTION
AGND	2		Analog ground
AREF	5	O	Connect 1 μ F capacitor to ground for AREF voltage filtering
AVDD	1	I	Analog power supply
COSC	4	I	Connect capacitor to ground to set oscillation frequency (220 pF for 500 kHz, 1 nF for 100 kHz) when the internal oscillator is selected; connect clock signal when an external oscillator is used
FAULT0	10	O	Fault flag 0, low when active open drain output (see application information)
FAULT1	9	O	Fault flag 1, high when active open drain output (see application information)
FREQ	32	I	Selects 500 kHz switching frequency when a TTL logic low is applied to this terminal; selects 100 kHz switching frequency when a TTL logic high is applied
IN-	7	I	Negative differential input
IN+	6	I	Positive differential input
INT/EXT	31	I	Selects the internal oscillator when a TTL logic high is applied to this terminal; selects the use of an external oscillator when a TTL logic low is applied to this terminal
H/C	14, 15, 16, 17	O	Direction control output for heat and cool modes (4 pins)
PWM	24, 25, 26, 27	O	PWM output for voltage magnitude (4 pins)
PGND	18, 19, 20, 21, 22, 23		High-current ground (6 pins)
PVDD	11, 12, 13, 28, 29, 30	I	High-current power supply (6 pins)
ROSC	3	I	Connect 120-k Ω resistor to AGND to set oscillation frequency (either 500 kHz or 100 kHz). Not needed if an external clock is used.
SHUTDOWN	8	I	Places the amplifier in shutdown mode when a TTL logic low is applied to this terminal; places the amplifier in normal operation when a TTL logic high is applied

FUNCTIONAL BLOCK DIAGRAM

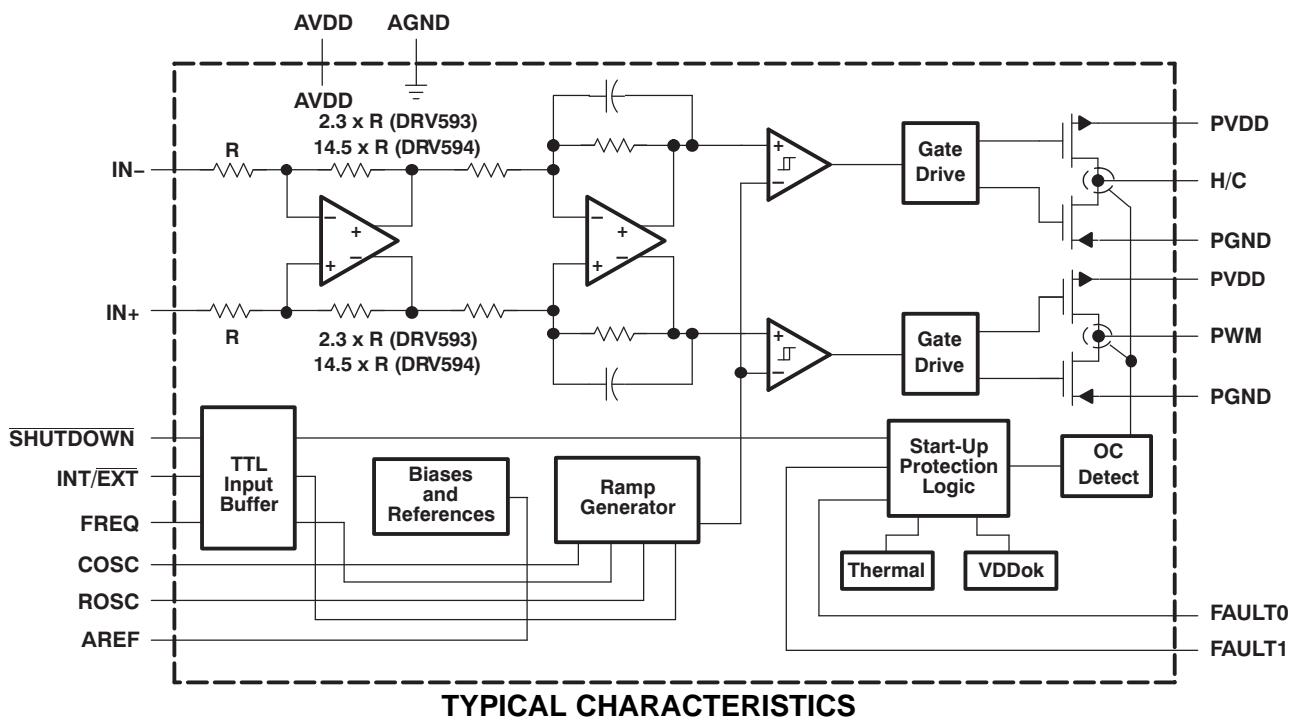
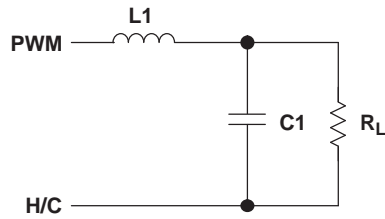

Table of Graphs

			FIGURE
Efficiency		vs Load resistance	2, 3
$r_{DS(on)}$	Drain-source on-state resistance	vs Supply voltage	4
		vs Free-air temperature	5
		vs Free-air temperature	6
		vs Supply voltage	7
PSRR	Power supply rejection ratio	vs Frequency	8, 9
	Closed loop response		12, 13
I_O	Maximum output current	vs Output voltage	14
		vs Ambient temperature	15
V_{IO}	Input offset voltage	Common-mode input voltage	16, 17

TEST SETUP FOR GRAPHS

The LC output filter used in [Figure 2](#), [Figure 3](#), [Figure 8](#), and [Figure 9](#) is shown below.



L1 = 10 μ H (part number: CDRH104R, manufacturer: Sumida)
C1 = 10 μ F (part number: ECJ-4YB1C106K, manufacturer: Panasonic)

Figure 1. LC Output Filter

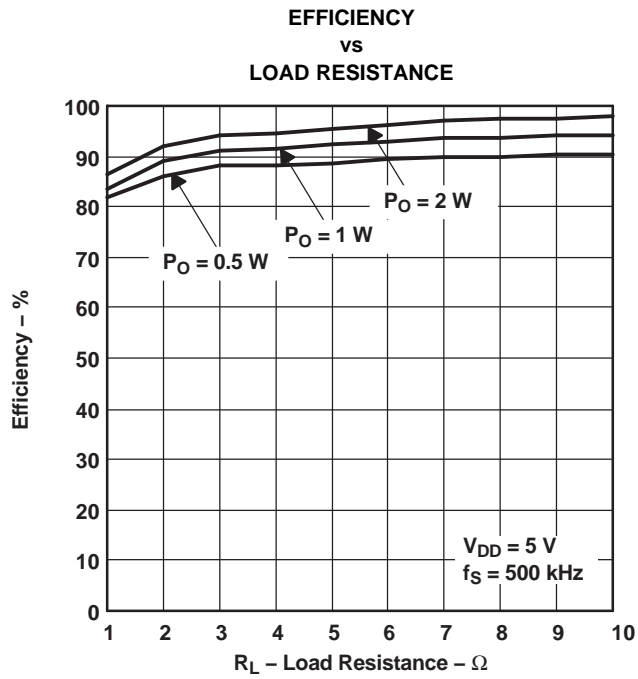

Figure 2.

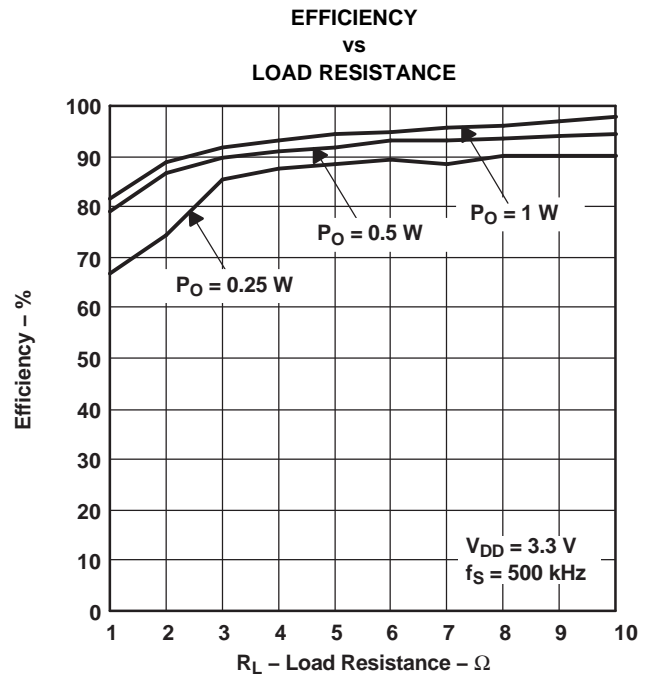

Figure 3.

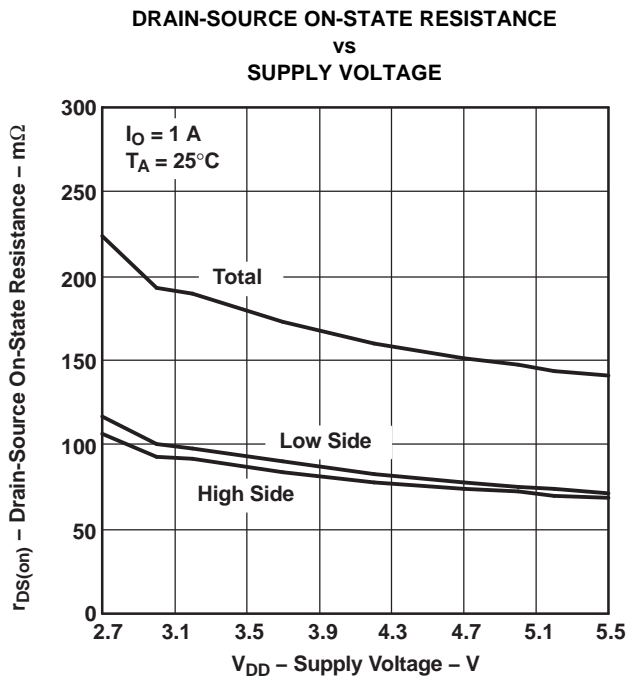

Figure 4.

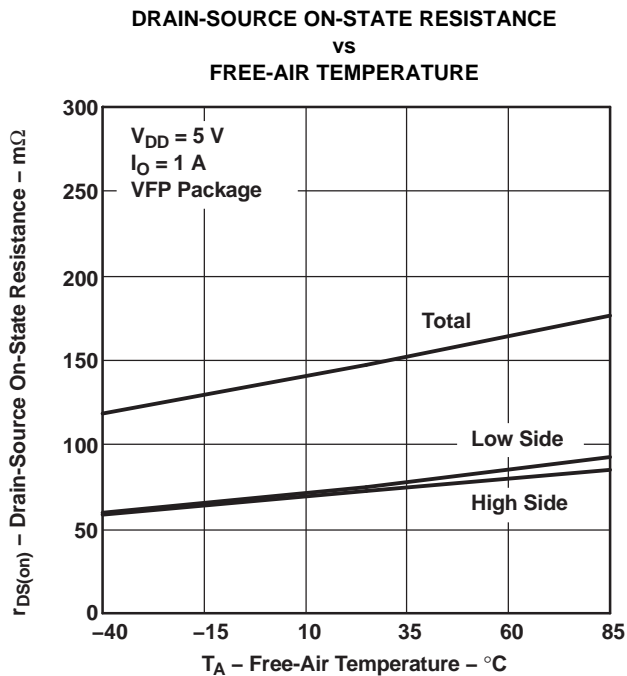

Figure 5.

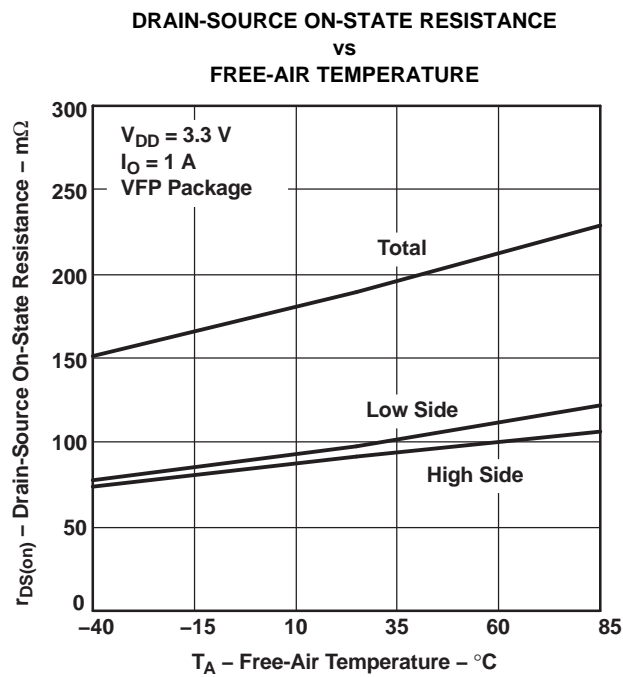

Figure 6.

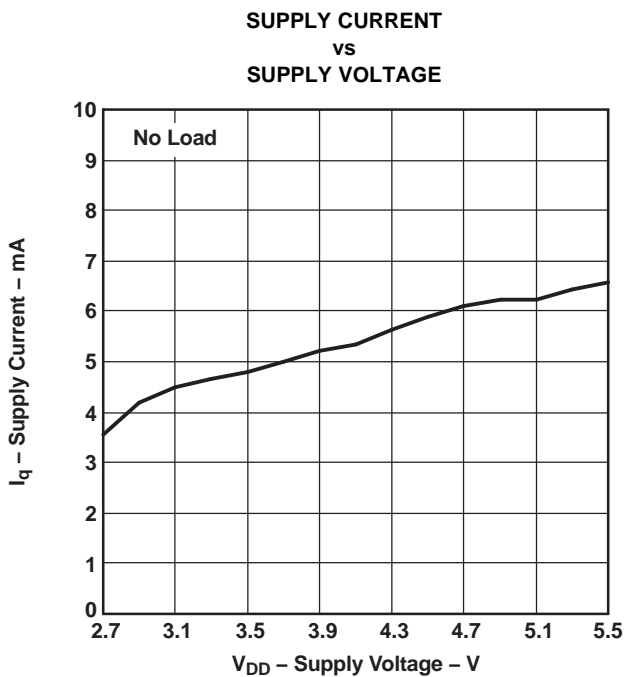

Figure 7.

POWER SUPPLY REJECTION RATIO
vs
FREQUENCY

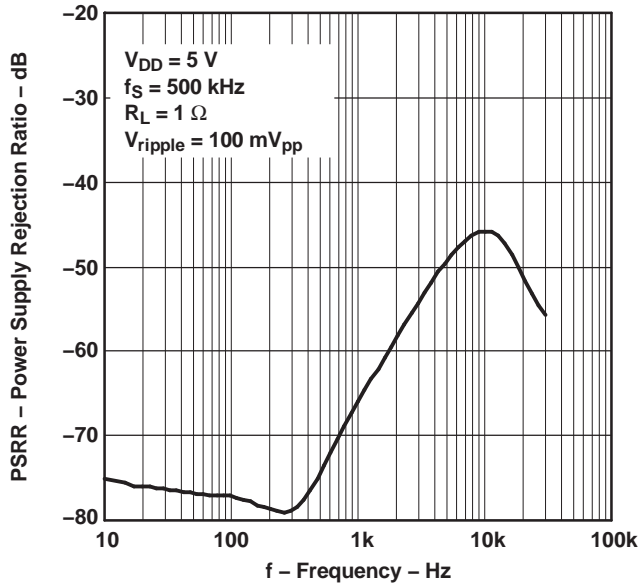

Figure 8.

POWER SUPPLY REJECTION RATIO
vs
FREQUENCY

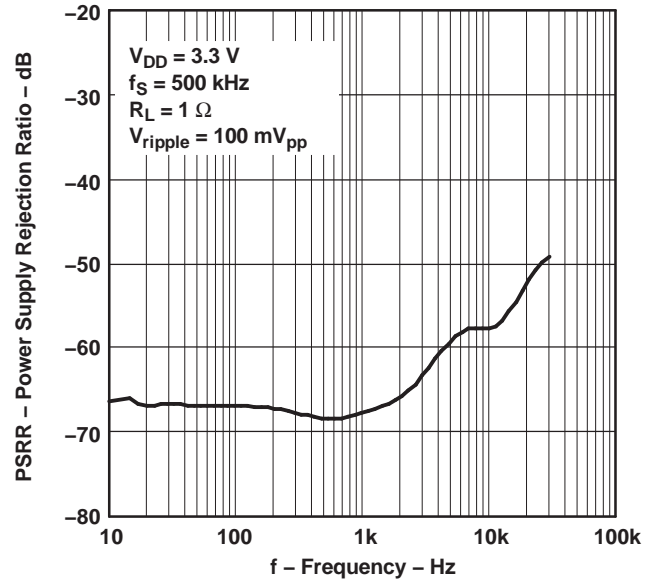

Figure 9.

DRV593
CLOSED LOOP RESPONSE

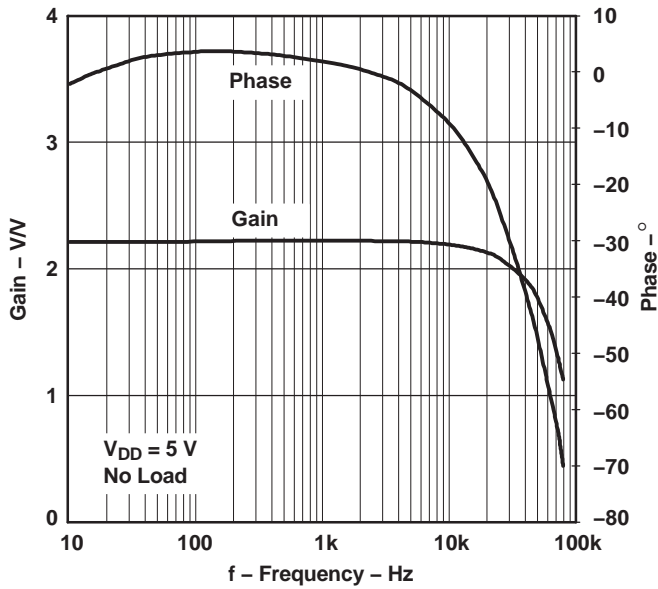

Figure 10.

DRV594
CLOSED LOOP RESPONSE

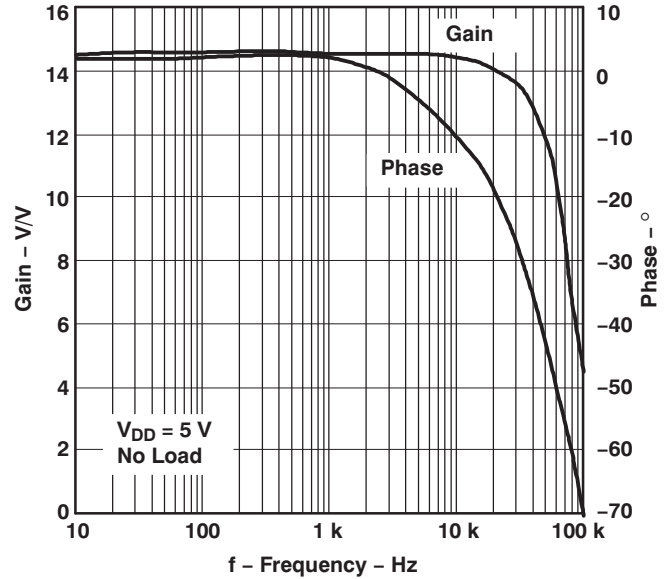

Figure 11.

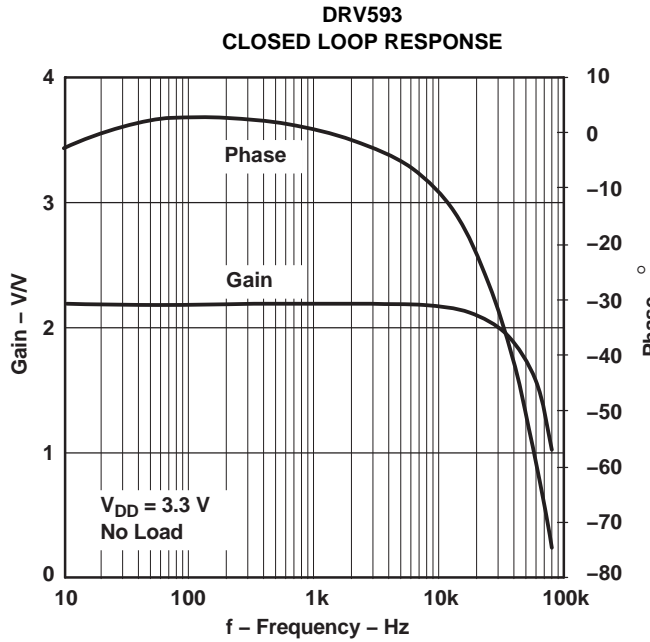

Figure 12.

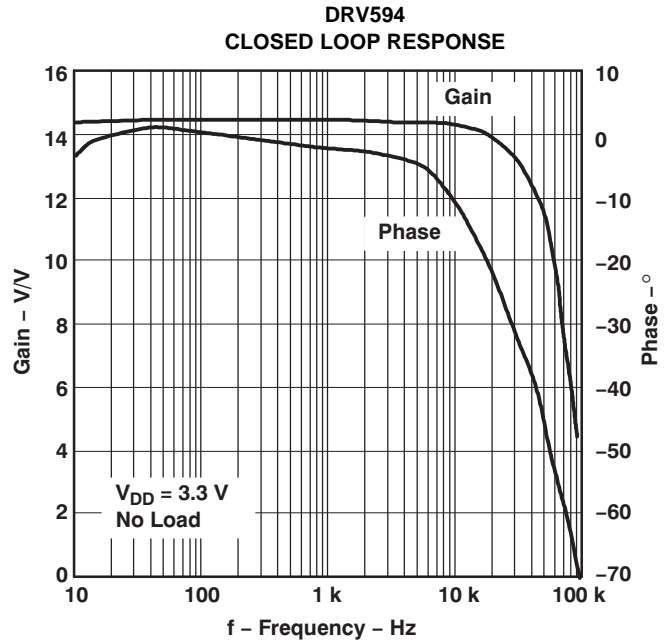

Figure 13.

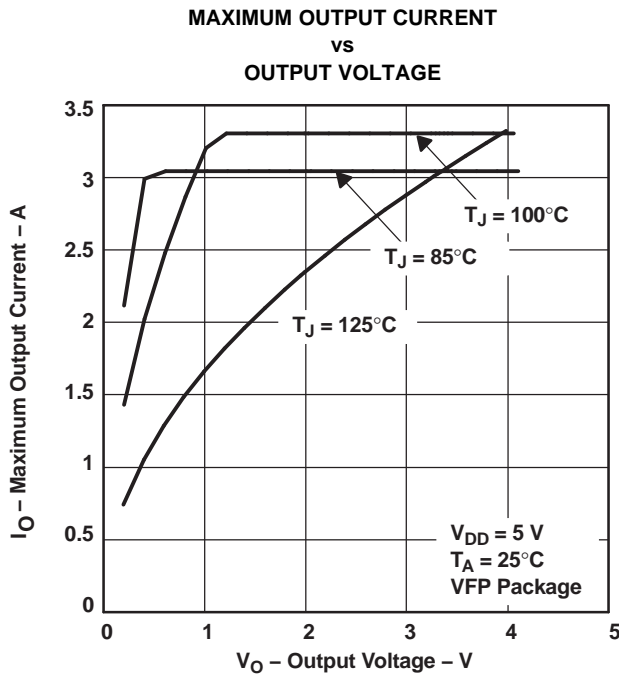

Figure 14.

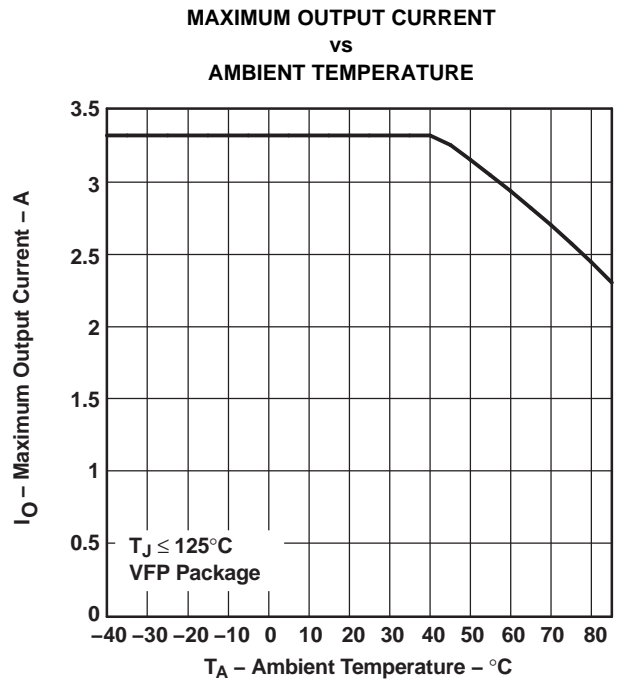

Figure 15.

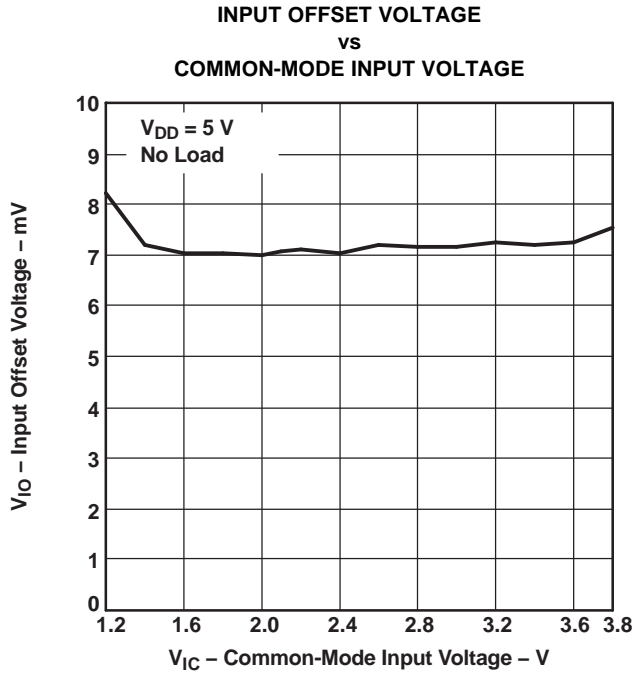

Figure 16.

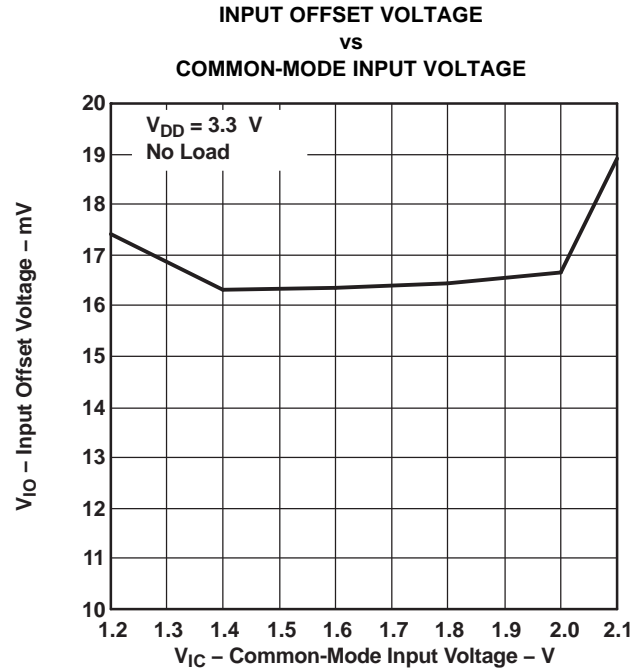

Figure 17.

APPLICATION INFORMATION

PULSE-WIDTH MODULATION SCHEME FOR DRV593 AND DRV594

The pulse-width modulation scheme implemented in the DRV593 and DRV594 eliminates one-half of the full output filter previously required for PWM drivers. The DRV593 and DRV594 require only one inductor and capacitor for the output filter. The H/C outputs determine the direction of the current and do not switch back and forth. The PWM outputs switch to produce a voltage across the load that is proportional to the input control voltage.

COOLING MODE

Figure 18 shows the DRV593 and DRV594 in cooling mode. The H/C outputs (pins 14-17) are at ground and the PWM outputs (pins 24-27) create a voltage across the load that is proportional to the input voltage.

The differential voltage across the load is determined using Equation 1 and the duty cycle using Equation 2. The differential voltage is defined as the voltage measured after the filter on the PWM output relative to the H/C output.

$$V_{\text{Load}} = D \times V_{\text{DD}} \quad (1)$$

$$D = \frac{A_v(V_{\text{IN}+} - V_{\text{IN}-})}{V_{\text{DD}}} \quad (2)$$

where D duty cycle of the PWM signal A_v Gain of DRV593/594 (DRV593: 2.3 V/V, DRV594: 14.5 V/V) $V_{\text{IN}+}$ Positive input terminal of the DRV593/594 $V_{\text{IN}-}$ Negative input terminal of the DRV593/594 V_{DD} Power supply voltage

For example, a 50% duty cycle, shown in Figure 18, results in 2.5 V across the load for $V_{\text{DD}} = 5 \text{ V}$.

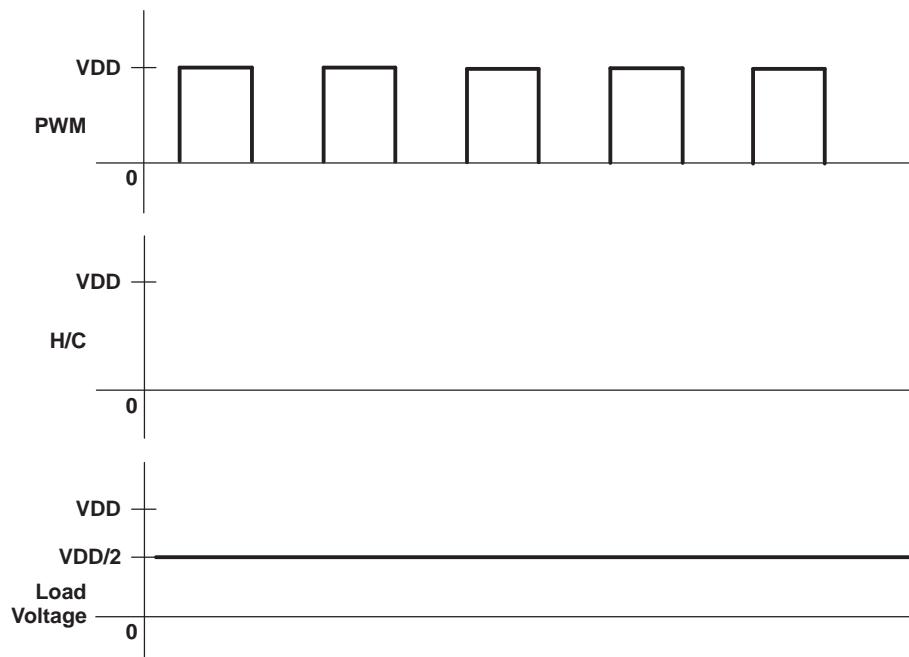

Figure 18. Cooling Mode

HEATING MODE

Figure 19 shows the DRV593 and DRV594 in heating mode. The H/C output is at VDD and the PWM output is proportional to the voltage across the load.

The differential voltage across the load is determined using Equation 3. The variables are the same as used previously for Equation 1 and Equation 2.

$$V_{\text{Load}} = -(1-D) \times V_{\text{DD}} \quad (3)$$

For example, a 50% duty cycle, shown in Figure 19, results in -2.5 V across the load for $V_{\text{DD}} = 5 \text{ V}$. The differential voltage across the load is defined as the voltage measured after the filter on the PWM output relative to the H/C output.

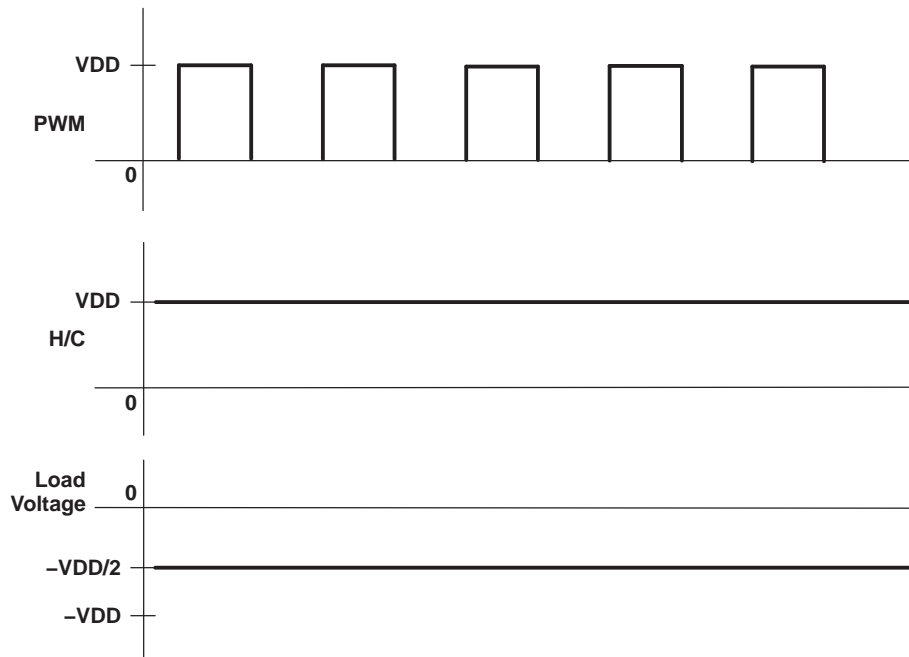

Figure 19. Heating Mode

HEAT/COOL TRANSITION

As the device transitions from cooling to heating, the duty cycle of the PWM outputs decrease to a small value and the H/C outputs remains at ground. When the device transitions to heating mode, the H/C outputs change from zero volts to VDD and the PWM outputs change to a high duty cycle. The direction of the current flow is reversed, but a low voltage is maintained across the load. The duty cycle decreases as the part is put further into heating mode to drive more current through the load. Figure 20 illustrates the transition from cooling to heating.

ZERO-CROSSING REGION

When the differential output voltage is near zero, the control logic in the DRV593 and DRV594 causes the outputs to change between heating and cooling modes. There are two possible states for the PWM and H/C outputs to obtain zero volts differentially: both outputs can be at VDD or both outputs can be at ground. Therefore, random noise causes the outputs to change between the two states when the two input voltages are equal. The outputs switch from zero to VDD, although not at a fixed frequency rate. Some of the pulses may be wider than others, but the two outputs (PWM and H/C) track each other to provide zero differential voltage. These uneven pulse widths can increase the switching noise during the zero-crossing condition.

To avoid this phenomenon, hysteresis should be implemented in the control loop to prevent the device from operating within this region. Although planning for operation during the zero-crossing is important, the normal operating points for the DRV593 and DRV594 are outside of this region. For laser temperature/wavelength regulation, the zero volts output condition is only a concern when the laser temperature or wavelength, relative to the ambient temperature, requires no heating or cooling from the TEC element.

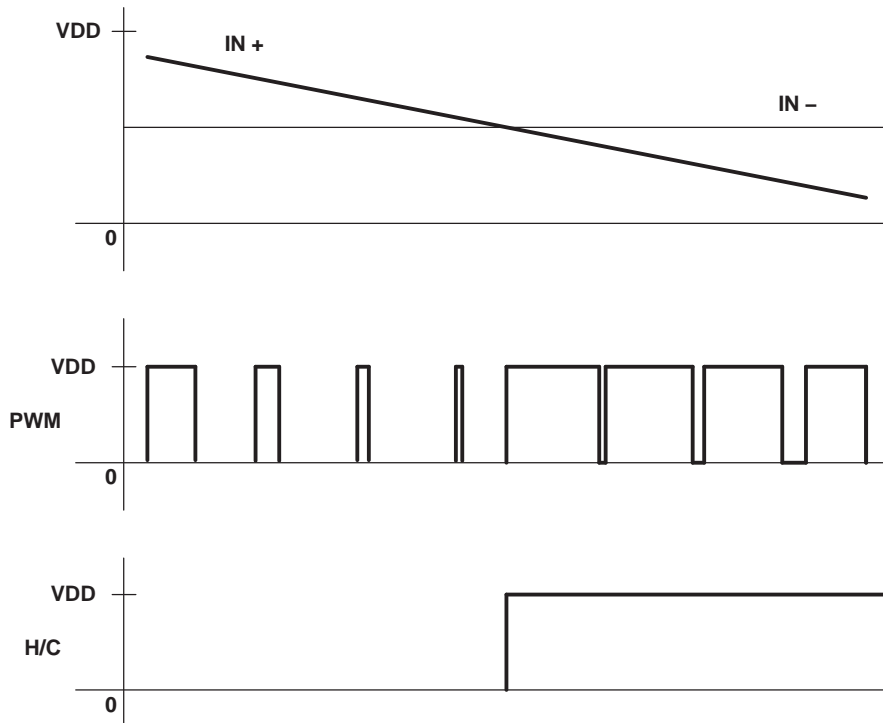

Figure 20. Transition From Cooling to Heating

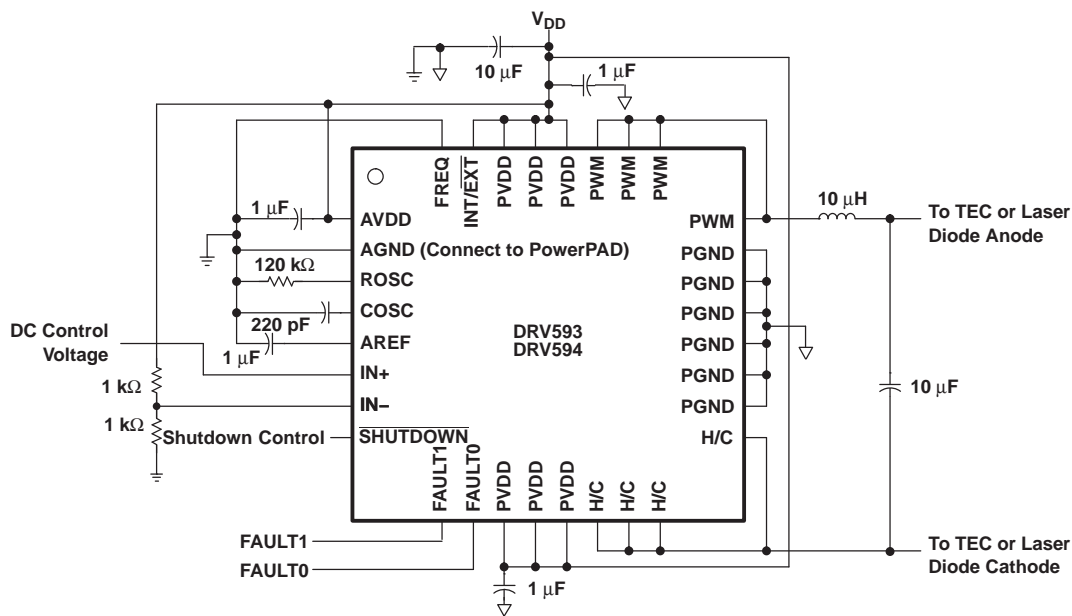

Figure 21. Typical Application Circuit

OUTPUT FILTER CONSIDERATIONS

TEC element manufacturers provide electrical specifications for maximum dc current and maximum output voltage for each particular element. The maximum ripple current, however, is typically only recommended to be less than 10% with no reference to the frequency components of the current. The maximum temperature differential across the element, which decreases as ripple current increases, may be calculated with the following equation:

$$\Delta T = \frac{1}{(1 + N^2)} \times \Delta T_{\max} \quad (4)$$

where

ΔT = actual temperature differential

ΔT_{\max} = maximum temperature differential (specified by manufacturer)

N = ratio of ripple current to dc current

According to this relationship, a 10% ripple current reduces the maximum temperature differential by 1%. An LC network may be used to filter the current flowing to the TEC to reduce the amount of ripple and, more importantly, protect the rest of the system from any electromagnetic interference (EMI).

FILTER COMPONENT SELECTION

The LC filter, which may be designed from two different perspectives, both described below, helps estimate the overall performance of the system. The filter should be designed for the worst-case conditions during operation, which is typically when the differential output is at 50% duty cycle. The following section serves as a starting point for the design, and any calculations should be confirmed with a prototype circuit in the lab.

Any filter should always be placed as close as possible to the DRV593 and DRV594 to reduce EMI.

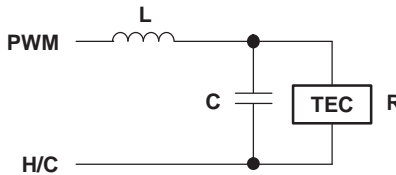

Figure 22. Output Filter

LC FILTER IN THE FREQUENCY DOMAIN

The transfer function for a second-order low-pass filter (Figure 22) is shown in Equation 5:

$$H_{LP}(j\omega) = \frac{1}{-\left(\frac{\omega}{\omega_0}\right)^2 + \frac{1}{Q} \frac{j\omega}{\omega_0} + 1}$$

$$\omega_0 = \frac{1}{\sqrt{LC}}$$

Q = quality factor

ω = DRV593 or DRV594 switching frequency

(5)

For the DRV593 and DRV594, the differential output switching frequency is typically selected to be 500 kHz. The resonant frequency for the filter is typically chosen to be at least one order of magnitude lower than the switching frequency. Equation 5 may then be simplified to give the following magnitude Equation 6. These equations assume the use of the filter in Figure 22.

$$\begin{aligned}
 |H_{LP}|_{dB} &= -40 \log \left(\frac{f_s}{f_o} \right) \\
 f_o &= \frac{1}{2\pi\sqrt{LC}} \\
 f_s &= 500 \text{ kHz (DRV593 or DRV594 switching frequency)}
 \end{aligned}
 \tag{6}$$

If $L=10 \mu\text{H}$ and $C=10 \mu\text{F}$, the cutoff frequency is 15.9 kHz, which corresponds to -60 dB of attenuation at the 500 kHz switching frequency. For $V_{DD} = 5 \text{ V}$, the amount of ripple voltage at the TEC element is approximately 5 mV.

The average TEC element has a resistance of 1.5Ω , so the ripple current through the TEC is approximately 3.4 mA. At the 3-A maximum output current of the DRV593 and DRV594, this 5.4 mA corresponds to 0.11% ripple current, causing less than 0.0001% reduction of the maximum temperature differential of the TEC element (see Equation 4).

LC FILTER IN THE TIME DOMAIN

The ripple current of an inductor may be calculated using Equation 7:

$$\begin{aligned}
 \Delta I_L &= \frac{(V_O - V_{TEC})DT_s}{L} \\
 D &= \text{duty cycle (0.5 worst case)} \\
 T_s &= 1/f_s = 1/500 \text{ kHz}
 \end{aligned}
 \tag{7}$$

For $V_O = 5 \text{ V}$, $V_{TEC} = 2.5 \text{ V}$, and $L = 10 \mu\text{H}$, the inductor ripple current is 250 mA. To calculate how much of that ripple current flows through the TEC element, however, the properties of the filter capacitor must be considered.

For relatively small capacitors (less than $22 \mu\text{F}$) with very low equivalent series resistance (ESR, less than $10 \text{ m}\Omega$), such as ceramic capacitors, the following Equation 8 may be used to estimate the ripple voltage on the capacitor due to the change in charge:

$$\begin{aligned}
 \Delta V_C &= \frac{\pi^2}{2} (1-D) \left(\frac{f_o}{f_s} \right)^2 V_{TEC} \\
 D &= \text{duty cycle} \\
 f_s &= 500 \text{ kHz} \\
 f_o &= \frac{1}{2\pi\sqrt{LC}}
 \end{aligned}
 \tag{8}$$

For $L = 10 \mu\text{H}$ and $C = 10 \mu\text{F}$, the cutoff frequency, f_o , is 15.9 kHz. For worst case duty cycle of 0.5 and $V_{TEC}=2.5 \text{ V}$, the ripple voltage on the capacitors is 6.2 mV. The ripple current may be calculated by dividing the ripple voltage by the TEC resistance of 1.5Ω , resulting in a ripple current through the TEC element of 4.1 mA. Note that this is similar to the value calculated using the frequency domain approach.

For larger capacitors (greater than $22 \mu\text{F}$) with relatively high ESR (greater than $100 \text{ m}\Omega$), such as electrolytic capacitors, the ESR dominates over the charging/discharging of the capacitor. The following simple Equation 9 may be used to estimate the ripple voltage:

$$\begin{aligned}
 \Delta V_C &= \Delta I_L \times R_{ESR} \\
 \Delta I_L &= \text{inductor ripple current} \\
 R_{ESR} &= \text{filter capacitor ESR}
 \end{aligned}
 \tag{9}$$

For a 100 μF electrolytic capacitor, an ESR of 0.1 Ω is common. If the 10 μH inductor is used, delivering 250 mA of ripple current to the capacitor (as calculated above), then the ripple voltage is 25 mV. This is over ten times that of the 10 μF ceramic capacitor, as ceramic capacitors typically have negligible ESR.

SWITCHING FREQUENCY CONFIGURATION: OSCILLATOR COMPONENTS R_{OSC} and C_{OSC} AND FREQ OPERATION

The onboard ramp generator requires an external resistor and capacitor to set the oscillation frequency. The frequency may be either 500 kHz or 100 kHz by selecting the proper capacitor value and by holding the FREQ pin either low (500 kHz) or high (100 kHz). Table 2 shows the values required and FREQ pin configuration for each switching frequency.

Table 2. Frequency Configuration Options

SWITCHING FREQUENCY	R_{OSC}	C_{OSC}	FREQ
500 kHz	120 k Ω	220 pF	LOW (GND)
100 kHz	120 k Ω	1 nF	HIGH (VDD)

For proper operation, the resistor R_{OSC} should have 1% tolerance while capacitor C_{OSC} should be a ceramic type with 10% tolerance. Both components should be grounded to AGND, which should be connected to PGND at a single point, typically where power and ground are physically connected to the printed-circuit board.

EXTERNAL CLOCKING OPERATION

To synchronize the switching to an external clock signal, pull the $\overline{\text{INT/EXT}}$ terminal low, and drive the clock signal into the COSC terminal. This clock signal must be from 10% to 90% duty cycle and meet the voltage requirements specified in the electrical specifications table. Since the DRV593 and DRV594 include an internal frequency doubler, the external clock signal must be approximately 250 kHz. Deviations from the 250 kHz clock frequency are allowed and are specified in the electrical characteristic table. The resistor connected from ROSC to ground may be omitted from the circuit in this mode of operation—the source is disconnected internally.

INPUT CONFIGURATION: DIFFERENTIAL AND SINGLE-ENDED

If a differential input is used, it should be biased around the midrail of the DRV593 or DRV594 and must not exceed the common-mode input range of the input stage (see the operating characteristics at the beginning of the data sheet).

The most common configuration employs a single-ended input. The unused input should be tied to $V_{\text{DD}}/2$, which may be simply accomplished with a resistive voltage divider. For the best performance, the resistor values chosen should be at least 100 times lower than the input resistance of the DRV593 or DRV594. This prevents the bias voltage at the unused input from shifting when the signal input is applied. A small ceramic capacitor should also be placed from the input to ground to filter noise and keep the voltage stable. An op amp configured as a buffer may also be used to set the voltage at the unused input.

FIXED INTERNAL GAIN

The differential output voltage may be calculated using Equation 10:

$$V_{\text{O}} = V_{\text{OUT}+} - V_{\text{OUT}-} = A_{\text{V}}(V_{\text{IN}+} - V_{\text{IN}-}) \quad (10)$$

A_{V} is the voltage gain, which is fixed internally at 2.3 V/V for DRV593 and 14.5 V/V for DRV594. The maximum and minimum ratings are provided in the electrical specification table at the beginning of the data sheet.

POWER SUPPLY DECOUPLING

To reduce the effects of high-frequency transients or spikes, a small ceramic capacitor, typically 0.1 μF to 1 μF , should be placed as close to each set of PVDD pins of the DRV593 and DRV594 as possible. For bulk decoupling, a 10 μF to 100 μF tantalum or aluminum electrolytic capacitor should be placed relatively close to the DRV593 and DRV594.

AREF CAPACITOR

The AREF terminal is the output of an internal mid-rail voltage regulator used for the onboard oscillator and ramp generator. The regulator may not be used to provide power to any additional circuitry. A 1 μ F ceramic capacitor must be connected from AREF to AGND for stability (see oscillator components above for AGND connection information).

SHUTDOWN OPERATION

The DRV593 and DRV594 include a shutdown mode that disables the outputs and places the device in a low supply current state. The SHUTDOWN pin may be controlled with a TTL logic signal. When SHUTDOWN is held high, the device operates normally. When SHUTDOWN is held low, the device is placed in shutdown. The SHUTDOWN pin must not be left floating. If the shutdown feature is unused, the pin may be connected to VDD.

FAULT REPORTING

The DRV593 and DRV594 include circuitry to sense three faults:

- Overcurrent
- Undervoltage
- Overtemperature

These three fault conditions are decoded via the FAULT1 and FAULT0 terminals. Internally, these are open-drain outputs, so an external pullup resistor of 5 k Ω or greater is required.

Table 3. Fault Indicators

FAULT1	FAULT0	
0	0	Overcurrent
1	0	Undervoltage
0	1	Overtemperature
1	1	Normal operation

The overcurrent fault is reported when the output current exceeds four amps. As soon as the condition is sensed, the overcurrent fault is set and the outputs go into a high-impedance state for approximately 3 μ s to 5 μ s (500 kHz operation). After 3 μ s to 5 μ s, the outputs are re-enabled. If the overcurrent condition has ended, the fault is cleared and the device resumes normal operation. If the overcurrent condition still exists, the above sequence repeats.

The undervoltage fault is reported when the operating voltage is reduced below 2.8 V. This fault is not latched, so as soon as the power supply recovers, the fault is cleared and normal operation resumes. During the undervoltage condition, the outputs go into a high-impedance state to prevent overdissipation due to increased $r_{DS(on)}$.

The overtemperature fault is reported when the junction temperature exceeds 128°C. The device continues operating normally until the junction temperature reaches 158°C, at which point the IC is disabled to prevent permanent damage from occurring. The system's controller must reduce the power demanded from the DRV593 or DRV594 once the overtemperature flag is set, or else the device switches off when it reaches 158°C. This fault is not latched; once the junction temperature drops below 128°C, the fault is cleared, and normal operation resumes.

POWER DISSIPATION AND MAXIMUM AMBIENT TEMPERATURE

Though the DRV593 and DRV594 are much more efficient than traditional linear solutions, the power drop across the on-resistance of the output transistors does generate some heat in the package, which may be calculated as shown in [Equation 11](#):

$$P_{DISS} = (I_{OUT})^2 \times r_{DS(on), total} \quad (11)$$

For example, at the maximum output current of 3 A through a total on-resistance of 130 m Ω (at $T_J = 25^\circ\text{C}$), the power dissipated in the package is 1.17 W.

Calculate the maximum ambient temperature using [Equation 12](#):

$$T_A = T_J - (\theta_{JA} \times P_{DISS}) \quad (12)$$

PRINTED-CIRCUIT BOARD (PCB) LAYOUT CONSIDERATIONS

Since the DRV593 and DRV594 are high-current switching devices, a few guidelines for the layout of the printed-circuit board (PCB) must be considered:

1. **Grounding.** Analog ground (AGND) and power ground (PGND) must be kept separated, ideally back to where the power supply physically connects to the PCB, minimally back to the bulk decoupling capacitor (10 μ F ceramic minimum). Furthermore, the PowerPAD ground connection should be made to AGND, not PGND. Ground planes are not recommended for AGND or PGND, traces should be used to route the currents. Wide traces (100 mils) should be used for PGND while narrow traces (15 mils) should be used for AGND.
2. **Power supply decoupling.** A small 0.1 μ F to 1 μ F ceramic capacitor should be placed as close to each set of PVDD pins as possible, connecting from PVDD to PGND. A 0.1 μ F to 1 μ F ceramic capacitor should also be placed close to the AVDD pin, connecting from AVDD to AGND. A bulk decoupling capacitor of at least 10 μ F, preferably ceramic, should be placed close to the DRV593 or DRV594, from PVDD to PGND. If power supply lines are long, additional decoupling may be required.
3. **Power and output traces.** The power and output traces should be sized to handle the desired maximum output current. The output traces should be kept as short as possible to reduce EMI, i.e., the output filter should be placed as close to the DRV593 or DRV594 outputs as possible.
4. **PowerPAD.** The DRV593 and DRV594 in the Quad Flatpack package use TI's PowerPAD technology to enhance the thermal performance. The PowerPAD is physically connected to the substrate of the DRV593 and DRV594 silicon, which is connected to AGND. The PowerPAD ground connection should therefore be kept separate from PGND as described above. The pad underneath the AGND pin may be connected underneath the device to the PowerPAD ground connection for ease of routing. For additional information on PowerPAD PCB layout, refer to the *PowerPAD Thermally Enhanced Package* application note, ([SLMA002](#)).
5. **Thermal performance.** For proper thermal performance, the PowerPAD must be soldered down to a thermal land, as described in the *PowerPAD Thermally Enhanced Package* application note, ([SLMA002](#)). In addition, at high current levels (greater than 2 A) or high ambient temperatures (greater than 25°C), an internal plane may be used for heat sinking. The vias under the PowerPAD should make a solid connection, and the plane should not be tied to ground except through the PowerPAD connection, as described above.

Changes from Revision A (October 2002) to Revision B**Page**

- Changed Thermal trip point from 115°C to 128°C 3
 - Changed Thermal shutdown point from 128°C to 158°C 3
-

Changes from Revision B (November 2008) to Revision C**Page**

- Changed figure cross reference from "Figure 17 and Figure 18" to "Figure 22" in the "LC FILTER....." section. 14
-

PACKAGING INFORMATION

Orderable part number	Status (1)	Material type (2)	Package Pins	Package qty Carrier	RoHS (3)	Lead finish/ Ball material (4)	MSL rating/ Peak reflow (5)	Op temp (°C)	Part marking (6)
DRV593VFP	Active	Production	HLQFP (VFP) 32	250 JEDEC TRAY (10+1)	Yes	NIPDAU	Level-2-260C-1 YEAR	-40 to 85	DRV593
DRV593VFP.A	Active	Production	HLQFP (VFP) 32	250 JEDEC TRAY (10+1)	Yes	NIPDAU	Level-2-260C-1 YEAR	-40 to 85	DRV593
DRV593VFPG4	Active	Production	HLQFP (VFP) 32	250 JEDEC TRAY (10+1)	Yes	NIPDAU	Level-2-260C-1 YEAR	-40 to 85	DRV593
DRV593VFPG4.A	Active	Production	HLQFP (VFP) 32	250 JEDEC TRAY (10+1)	Yes	NIPDAU	Level-2-260C-1 YEAR	-40 to 85	DRV593
DRV593VFPR	Active	Production	HLQFP (VFP) 32	1000 LARGE T&R	Yes	NIPDAU	Level-2-260C-1 YEAR	-40 to 85	DRV593
DRV593VFPR.A	Active	Production	HLQFP (VFP) 32	1000 LARGE T&R	Yes	NIPDAU	Level-2-260C-1 YEAR	-40 to 85	DRV593
DRV594VFP	Active	Production	HLQFP (VFP) 32	250 JEDEC TRAY (5+1)	Yes	NIPDAU	Level-2-260C-1 YEAR	-40 to 85	DRV594
DRV594VFP.A	Active	Production	HLQFP (VFP) 32	250 JEDEC TRAY (5+1)	Yes	NIPDAU	Level-2-260C-1 YEAR	-40 to 85	DRV594
DRV594VFPR	Active	Production	HLQFP (VFP) 32	1000 LARGE T&R	Yes	NIPDAU	Level-2-260C-1 YEAR	-40 to 85	DRV594
DRV594VFPR.A	Active	Production	HLQFP (VFP) 32	1000 LARGE T&R	Yes	NIPDAU	Level-2-260C-1 YEAR	-40 to 85	DRV594
DRV594VFPRG4	Active	Production	HLQFP (VFP) 32	1000 LARGE T&R	Yes	NIPDAU	Level-2-260C-1 YEAR	-40 to 85	DRV594
DRV594VFPRG4.A	Active	Production	HLQFP (VFP) 32	1000 LARGE T&R	Yes	NIPDAU	Level-2-260C-1 YEAR	-40 to 85	DRV594

(1) **Status:** For more details on status, see our [product life cycle](#).

(2) **Material type:** When designated, preproduction parts are prototypes/experimental devices, and are not yet approved or released for full production. Testing and final process, including without limitation quality assurance, reliability performance testing, and/or process qualification, may not yet be complete, and this item is subject to further changes or possible discontinuation. If available for ordering, purchases will be subject to an additional waiver at checkout, and are intended for early internal evaluation purposes only. These items are sold without warranties of any kind.

(3) **RoHS values:** Yes, No, RoHS Exempt. See the [TI RoHS Statement](#) for additional information and value definition.

(4) **Lead finish/Ball material:** Parts may have multiple material finish options. Finish options are separated by a vertical ruled line. Lead finish/Ball material values may wrap to two lines if the finish value exceeds the maximum column width.

(5) **MSL rating/Peak reflow:** The moisture sensitivity level ratings and peak solder (reflow) temperatures. In the event that a part has multiple moisture sensitivity ratings, only the lowest level per JEDEC standards is shown. Refer to the shipping label for the actual reflow temperature that will be used to mount the part to the printed circuit board.

(6) Part marking: There may be an additional marking, which relates to the logo, the lot trace code information, or the environmental category of the part.

Multiple part markings will be inside parentheses. Only one part marking contained in parentheses and separated by a "~" will appear on a part. If a line is indented then it is a continuation of the previous line and the two combined represent the entire part marking for that device.

Important Information and Disclaimer: The information provided on this page represents TI's knowledge and belief as of the date that it is provided. TI bases its knowledge and belief on information provided by third parties, and makes no representation or warranty as to the accuracy of such information. Efforts are underway to better integrate information from third parties. TI has taken and continues to take reasonable steps to provide representative and accurate information but may not have conducted destructive testing or chemical analysis on incoming materials and chemicals. TI and TI suppliers consider certain information to be proprietary, and thus CAS numbers and other limited information may not be available for release.

In no event shall TI's liability arising out of such information exceed the total purchase price of the TI part(s) at issue in this document sold by TI to Customer on an annual basis.

TAPE AND REEL INFORMATION

QUADRANT ASSIGNMENTS FOR PIN 1 ORIENTATION IN TAPE

*All dimensions are nominal

Device	Package Type	Package Drawing	Pins	SPQ	Reel Diameter (mm)	Reel Width W1 (mm)	A0 (mm)	B0 (mm)	K0 (mm)	P1 (mm)	W (mm)	Pin1 Quadrant
DRV593VFPR	HLQFP	VFP	32	1000	330.0	16.4	9.6	9.6	1.9	12.0	16.0	Q2
DRV594VFPR	HLQFP	VFP	32	1000	330.0	16.4	9.6	9.6	1.9	12.0	16.0	Q2
DRV594VFPRG4	HLQFP	VFP	32	1000	330.0	16.4	9.6	9.6	1.9	12.0	16.0	Q2

TAPE AND REEL BOX DIMENSIONS

*All dimensions are nominal

Device	Package Type	Package Drawing	Pins	SPQ	Length (mm)	Width (mm)	Height (mm)
DRV593VFPR	HLQFP	VFP	32	1000	350.0	350.0	43.0
DRV594VFPR	HLQFP	VFP	32	1000	350.0	350.0	43.0
DRV594VFPRG4	HLQFP	VFP	32	1000	350.0	350.0	43.0

TRAY

Chamfer on Tray corner indicates Pin 1 orientation of packed units.

*All dimensions are nominal

Device	Package Name	Package Type	Pins	SPQ	Unit array matrix	Max temperature (°C)	L (mm)	W (mm)	K0 (µm)	P1 (mm)	CL (mm)	CW (mm)
DRV593VFP	VFP	HLQFP	32	250	10 x 25	150	315	135.9	7620	12.2	11.1	11.25
DRV593VFP.A	VFP	HLQFP	32	250	10 x 25	150	315	135.9	7620	12.2	11.1	11.25
DRV593VFPG4	VFP	HLQFP	32	250	10 x 25	150	315	135.9	7620	12.2	11.1	11.25
DRV593VFPG4.A	VFP	HLQFP	32	250	10 x 25	150	315	135.9	7620	12.2	11.1	11.25
DRV594VFP	VFP	HLQFP	32	250	10 x 25	150	315	135.9	7620	12.2	11.1	11.25
DRV594VFP.A	VFP	HLQFP	32	250	10 x 25	150	315	135.9	7620	12.2	11.1	11.25

GENERIC PACKAGE VIEW

VFP 32

PowerPAD™ LQFP - 1.6 mm max height

PLASTIC QUAD FLATPACK

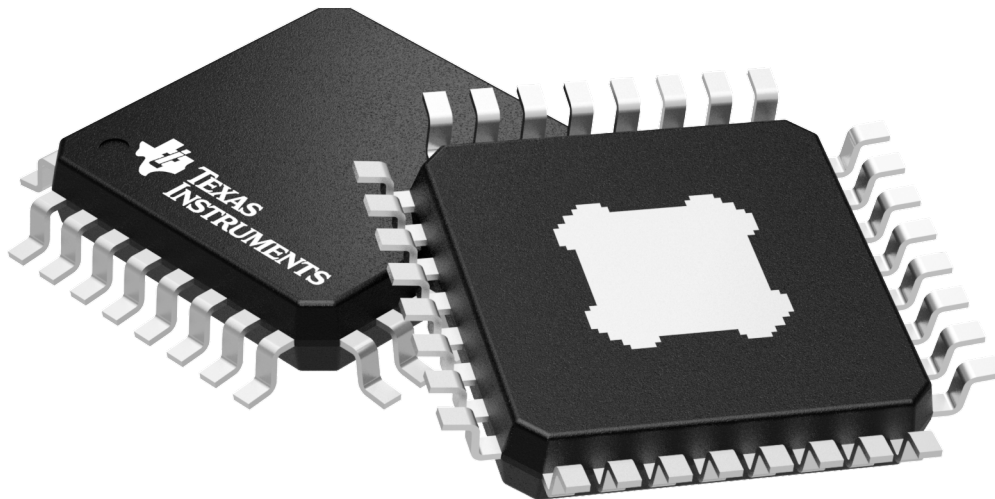

Images above are just a representation of the package family, actual package may vary.
Refer to the product data sheet for package details.

4200791/D

THERMAL PAD MECHANICAL DATA

VFP (S-PQFP-G32)

PowerPAD™ PLASTIC QUAD FLATPACK

THERMAL INFORMATION

This PowerPAD™ package incorporates an exposed thermal pad that is designed to be attached to a printed circuit board (PCB). The thermal pad must be soldered directly to the PCB. After soldering, the PCB can be used as a heatsink. In addition, through the use of thermal vias, the thermal pad can be attached directly to the appropriate copper plane shown in the electrical schematic for the device, or alternatively, can be attached to a special heatsink structure designed into the PCB. This design optimizes the heat transfer from the integrated circuit (IC).

For additional information on the PowerPAD package and how to take advantage of its heat dissipating abilities, refer to Technical Brief, PowerPAD Thermally Enhanced Package, Texas Instruments Literature No. SLMA002 and Application Brief, PowerPAD Made Easy, Texas Instruments Literature No. SLMA004. Both documents are available at www.ti.com.

The exposed thermal pad dimensions for this package are shown in the following illustration.

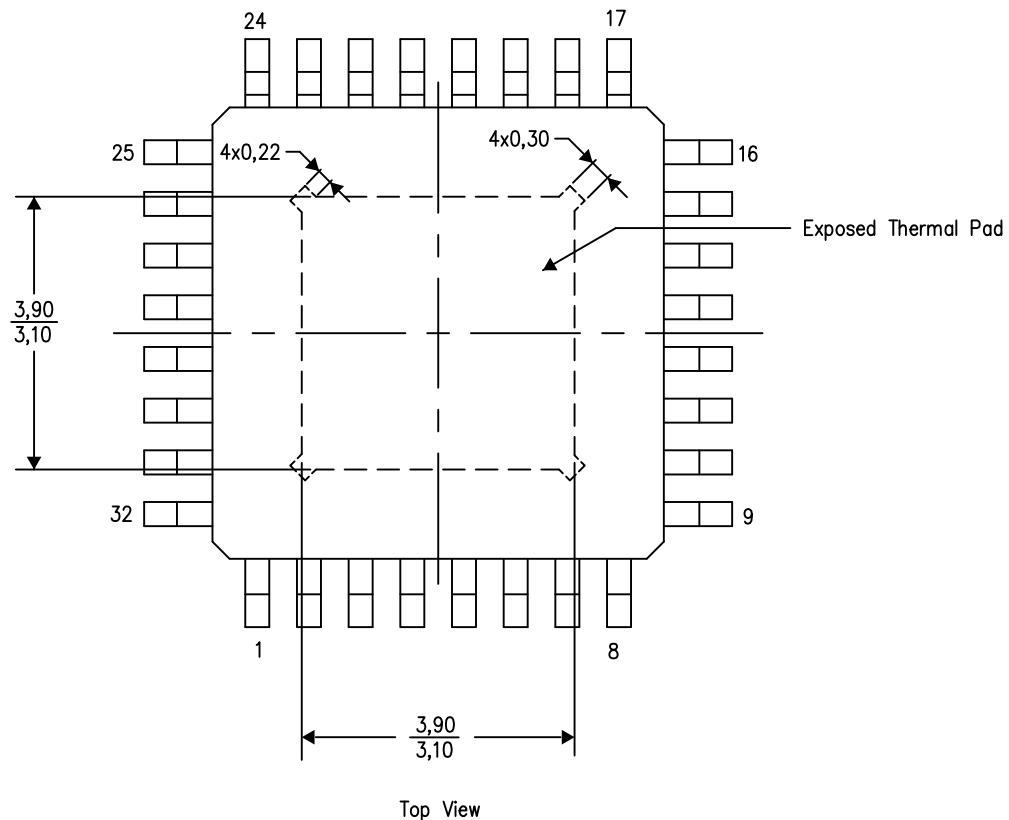

Exposed Thermal Pad Dimensions

4206318-2/E 06/13

NOTE: All linear dimensions are in millimeters

VFP (S-PQFP-G32) PowerPAD™

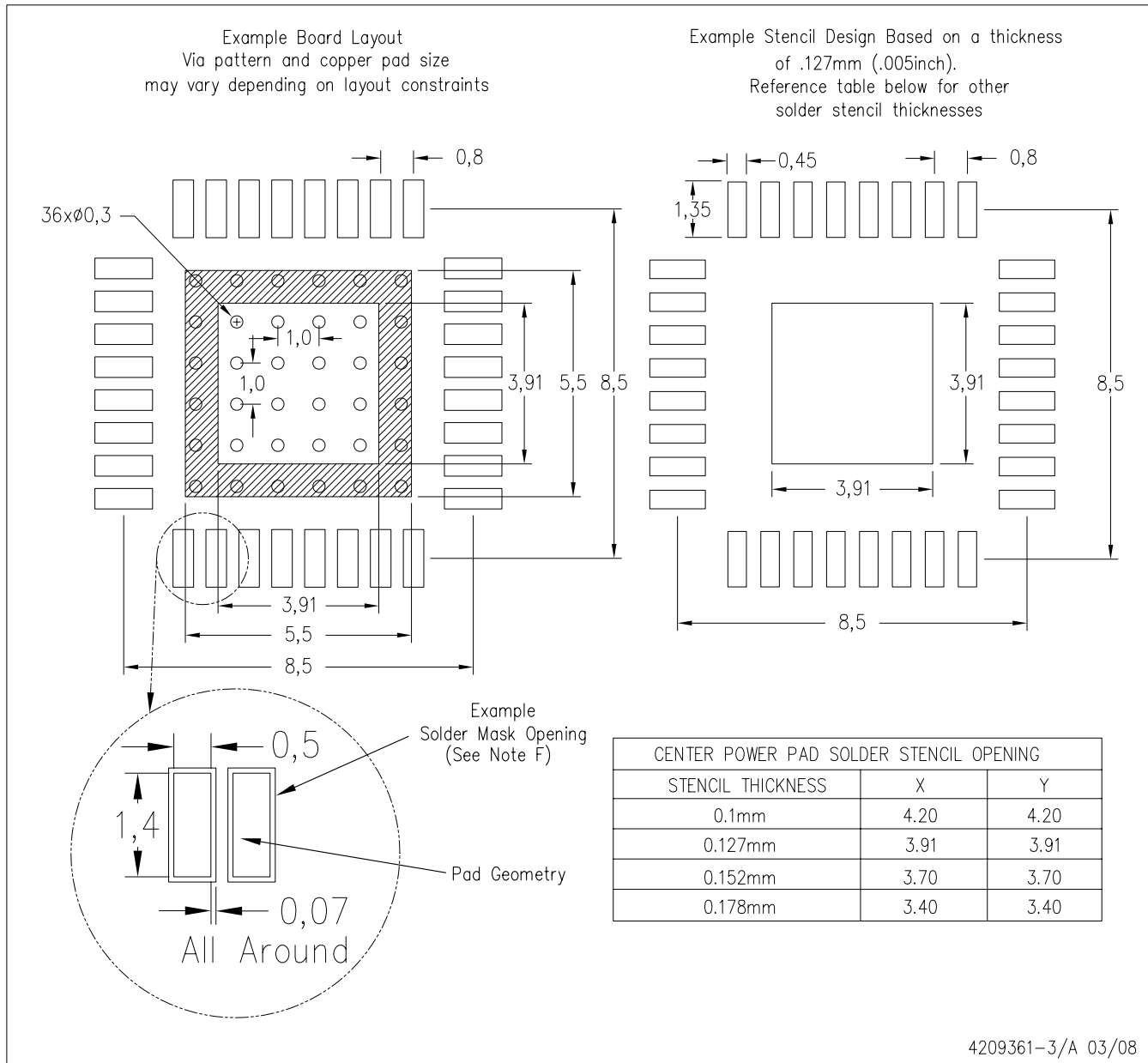

- NOTES:
- A. All linear dimensions are in millimeters.
 - B. This drawing is subject to change without notice.
 - C. Customers should place a note on the circuit board fabrication drawing not to alter the center solder mask defined pad.
 - D. This package is designed to be soldered to a thermal pad on the board. Refer to Technical Brief, PowerPAD Thermally Enhanced Package, Texas Instruments Literature No. SLMA002, SLMA004, and also the Product Data Sheets for specific thermal information, via requirements, and recommended board layout. These documents are available at www.ti.com <<http://www.ti.com>>. Publication IPC-7351 is recommended for alternate designs.
 - E. Laser cutting apertures with trapezoidal walls and also rounding corners will offer better paste release. Customers should contact their board assembly site for stencil design recommendations. Example stencil design based on a 50% volumetric metal load solder paste. Refer to IPC-7525 for other stencil recommendations.
 - F. Customers should contact their board fabrication site for solder mask tolerances between and around signal pads.

PowerPAD is a trademark of Texas Instruments.

IMPORTANT NOTICE AND DISCLAIMER

TI PROVIDES TECHNICAL AND RELIABILITY DATA (INCLUDING DATASHEETS), DESIGN RESOURCES (INCLUDING REFERENCE DESIGNS), APPLICATION OR OTHER DESIGN ADVICE, WEB TOOLS, SAFETY INFORMATION, AND OTHER RESOURCES "AS IS" AND WITH ALL FAULTS, AND DISCLAIMS ALL WARRANTIES, EXPRESS AND IMPLIED, INCLUDING WITHOUT LIMITATION ANY IMPLIED WARRANTIES OF MERCHANTABILITY, FITNESS FOR A PARTICULAR PURPOSE OR NON-INFRINGEMENT OF THIRD PARTY INTELLECTUAL PROPERTY RIGHTS.

These resources are intended for skilled developers designing with TI products. You are solely responsible for (1) selecting the appropriate TI products for your application, (2) designing, validating and testing your application, and (3) ensuring your application meets applicable standards, and any other safety, security, regulatory or other requirements.

These resources are subject to change without notice. TI grants you permission to use these resources only for development of an application that uses the TI products described in the resource. Other reproduction and display of these resources is prohibited. No license is granted to any other TI intellectual property right or to any third party intellectual property right. TI disclaims responsibility for, and you fully indemnify TI and its representatives against any claims, damages, costs, losses, and liabilities arising out of your use of these resources.

TI's products are provided subject to [TI's Terms of Sale](#), [TI's General Quality Guidelines](#), or other applicable terms available either on ti.com or provided in conjunction with such TI products. TI's provision of these resources does not expand or otherwise alter TI's applicable warranties or warranty disclaimers for TI products. Unless TI explicitly designates a product as custom or customer-specified, TI products are standard, catalog, general purpose devices.

TI objects to and rejects any additional or different terms you may propose.

Copyright © 2025, Texas Instruments Incorporated

Last updated 10/2025