

INA350 Cost and Size Optimized, Low Power, 1.8-V to 5.5-V Selectable Gain Instrumentation Amplifier

1 Features

- Ideal for size, cost, and power conscious designs
- Selectable gain options
 - $G = 10$ or $G = 20$ (INA350ABS)
 - $G = 30$ or $G = 50$ (INA350CDS)
- Space saving ultra-small package options
 - 10-pin X2QFN (RUG) – 3 mm^2
 - 8-pin WSON (DSG) – 4 mm^2
 - 8-pin SOT23-THN (DDF) – 4.64 mm^2
- Optimized performance for 10-bit to 14-bit systems
 - CMRR: 95 dB (typical) across all gains
 - Offset voltage: 0.2 mV (typical) across all gains
 - Gain error (typical):
 - 0.05% for $G = 10$; 0.06% for $G = 20$
 - 0.075% for $G = 30$; 0.082% for $G = 50$
- Bandwidth: 100 kHz for $G = 10$ (typical)
- Drives 500 pF with less than 20% overshoot (typical)
- Optimized quiescent current: 100 μA (typical)
- Shutdown option for power conscious applications
- Supply range: 1.8 V (± 0.9 V) to 5.5 V (± 2.75 V)
- Specified temperature range: -40°C to 125°C

2 Applications

- Bridge network sensing
- Differential to single-ended conversion
- [Weigh scale](#)
- [Analog input module](#)
- [Flow transmitter](#)
- [Wearable fitness and activity monitor](#)
- [Blood glucose monitor](#)
- Pressure and temperature sensing

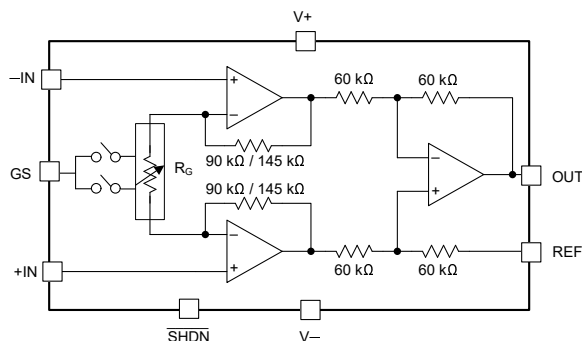

Note: 90 k Ω for INA350ABS and 145 k Ω for INA350CDS

Simplified Internal Schematic

3 Description

INA350 is a selectable-gain instrumentation amplifier that offers four gain options across INA350ABS and INA350CDS variants available in small packages. INA350ABS has gain options of 10 or 20 and INA350CDS has gain options of 30 or 50. These gain options can be selected by toggling the gain select (GS) pin. INA350 is ideal for bridge-type sensing and for differential to single-ended conversion applications.

Built with precision matched integrated resistors, INA350 saves on bill of materials (BOM) costs, pick-and-place machine handling costs, and board space by removing the need for precise or closely-matched external resistors. The device interface directly to low-speed, 10-bit to 14-bit, analog-to-digital converters (ADC) and is ideal for replacing discrete implementation of instrumentation amplifiers built with commodity amplifiers and discrete resistors.

Designed with the three-amplifier architecture, INA350 is optimized for delivering performance. It achieves 85 dB of minimum CMRR and 0.6% of maximum gain error, along with 1.2 mV of maximum offset across all gain options, while consuming just 125 μA of maximum quiescent current. It has an integrated shutdown option to turn off the amplifier when idle for additional power savings in battery powered applications.

Package Information

PART NUMBER	PACKAGE ⁽¹⁾	BODY SIZE (NOM)
INA350ABS, INA350CDS	DSG (WSON, 8)	2.00 mm × 2.00 mm
	DDF (SOT-23, 8)	1.60 mm × 2.90 mm
	RUG (X2QFN, 10)	1.50 mm × 2.00 mm

- (1) For all available packages, see the package option addendum at the end of the data sheet.



Table of Contents

1 Features	1	8.4 Device Functional Modes.....	24
2 Applications	1	9 Application and Implementation	25
3 Description	1	9.1 Application Information.....	25
4 Revision History	2	9.2 Typical Applications.....	27
5 Device Comparison Table	3	9.3 Power Supply Recommendations.....	29
6 Pin Configuration and Functions	4	9.4 Layout.....	30
7 Specifications	6	10 Device and Documentation Support	31
7.1 Absolute Maximum Ratings.....	6	10.1 Device Support.....	31
7.2 ESD Ratings.....	6	10.2 Documentation Support.....	31
7.3 Recommended Operating Conditions.....	6	10.3 Receiving Notification of Documentation Updates..	31
7.4 Thermal Information.....	6	10.4 Support Resources.....	31
7.5 Electrical Characteristics.....	7	10.5 Trademarks.....	31
7.6 Typical Characteristics.....	9	10.6 Electrostatic Discharge Caution.....	31
8 Detailed Description	19	10.7 Glossary.....	31
8.1 Overview.....	19	11 Mechanical, Packaging, and Orderable Information	31
8.2 Functional Block Diagram.....	19		
8.3 Feature Description.....	20		

4 Revision History

NOTE: Page numbers for previous revisions may differ from page numbers in the current version.

Changes from Revision B (April 2022) to Revision C (May 2023)	Page
• Removed the preview note for X2QFN (10) from the <i>Package Information</i> table.....	1
• Removed the preview note for X2QFN (RUG) from the <i>Device Comparison Table</i>	3
• Updated the <i>Thermal Information</i> table for X2QFN (RUG) production release.....	6

Changes from Revision A (December 2021) to Revision B (April 2022)	Page
• Removed the preview note for INA350CDS from the <i>Package Information</i> table.....	1
• Removed the preview note for INA350CDS from the <i>Device Comparison Table</i>	3
• Updated the <i>Electrical Characteristics</i> table for INA350CDS production release.....	6
• Included G = 30 and G = 50 data into the <i>EMIRR Testing</i> curve.....	21
• Included G = 30 and G = 50 data into the <i>Input Common-Mode Voltage vs Output Voltage</i> curve.....	28
• Removed the note about external resistor, RG.....	30

Changes from Revision * (November 2021) to Revision A (December 2021)	Page
• Changed the device status from <i>Advance Information</i> to <i>Production Data</i>	1

5 Device Comparison Table

DEVICE	NO. OF CHANNELS	PACKAGE LEADS		
		SOT-23-8 DDF	WSON DSG	X2QFN RUG
INA350ABS	1	8	8	8
INA350CDS	1	8	8	8

6 Pin Configuration and Functions

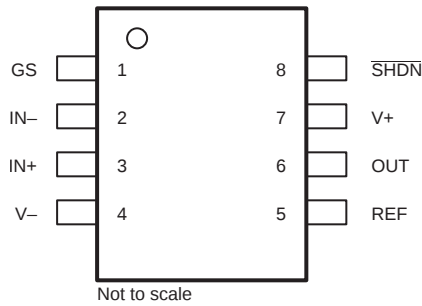

Not to scale
**Figure 6-1. DDF Package,
8-Pin SOT-23
(Top View)**

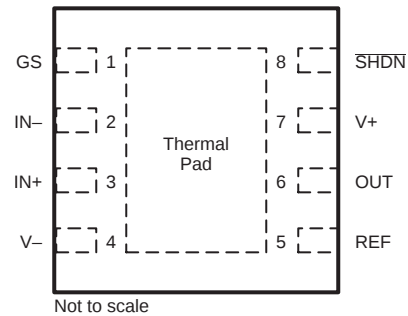

Not to scale
Note: Connect Thermal Pad to (V-)

**Figure 6-2. DSG Package,
8-Pin WSON With Exposed Thermal Pad
(Top View)**

Table 6-1. Pin Functions

PIN		TYPE ⁽¹⁾	DESCRIPTION
NAME	NO.		
IN-	2	I	Negative (inverting) input
IN+	3	O	Positive (non-inverting) input
OUT	6	—	Output
REF	5	—	Reference input. This pin must be driven by a low impedance source.
GS	1	I	Gain select – logic low (G = 10 for INA350ABS and G = 30 for INA350CDS) Gain select – logic high (G = 20 for INA350ABS and G = 50 for INA350CDS) Gain select – no connect (G = 20 for INA350ABS and G = 50 for INA350CDS)
SHDN	8	I	Shutdown – logic high (device enabled) Shutdown – logic low (device disabled) Shutdown – no connect (device enabled)
V-	4	—	Negative supply
V+	7	—	Positive supply

(1) I = input, O = output

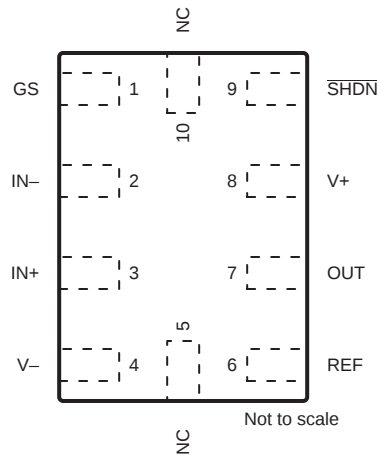

**Figure 6-3. RUG Package,
10-Pin X2QFN
(Top View)**

Table 6-2. Pin Functions

PIN		TYPE ⁽¹⁾	DESCRIPTION
NAME	NO.		
IN-	2	I	Negative (inverting) input
IN+	3	O	Positive (noninverting) input
OUT	7	—	Output
REF	6	—	Reference input. This pin must be driven by a low impedance source.
GS	1	I	Gain select – logic low (G = 10 for INA350ABS and G = 30 for INA350CDS) Gain select – logic high (G = 20 for INA350ABS and G = 50 for INA350CDS) Gain select – no connect (G = 20 for INA350ABS and G = 50 for INA350CDS)
SHDN	9	I	Shutdown – logic high (device enabled) Shutdown – logic low (device disabled) Shutdown – no connect (device enabled)
V-	4	—	Negative supply
V+	8	—	Positive supply
NC	5, 10	—	No connect

(1) I = input, O = output

7 Specifications

7.1 Absolute Maximum Ratings

over operating free-air temperature range (unless otherwise noted)⁽¹⁾

		MIN	MAX	UNIT
Supply voltage, $V_S = (V+) - (V-)$		0	6	V
Signal input pins	Common mode voltage ⁽²⁾	$(V-) - 0.5$	$(V+) + 0.5$	V
	Differential voltage ⁽³⁾		$V_S + 0.2$	V
	Current ⁽²⁾	-10	10	mA
Output short-circuit ⁽⁴⁾		Continuous		
Operating Temperature, T_A		-55	150	°C
Junction Temperature, T_J			150	
Storage Temperature, T_{stg}		-65	150	

- (1) Stresses beyond those listed under *Absolute Maximum Ratings* may cause permanent damage to the device. These are stress ratings only, which do not imply functional operation of the device at these or any other conditions beyond those indicated under *Recommended Operating Conditions*. Exposure to absolute-maximum-rated conditions for extended periods may affect device reliability.
- (2) Input pins are diode-clamped to the power-supply rails. Input signals that may swing more than 0.5 V beyond the supply rails must be current limited to 10 mA or less
- (3) Differential input voltages greater than 0.5 V applied continuously can result in a shift to the input offset voltage above the maximum specification of this parameter. The magnitude of this effect increases as the ambient operating temperature rises.
- (4) Short-circuit to $V_S / 2$.

7.2 ESD Ratings

			VALUE	UNIT
$V_{(ESD)}$	Electrostatic discharge	Human-body model (HBM), per ANSI/ESDA/JEDEC JS-001 ⁽¹⁾	±2000	V
		Charged-device model (CDM), per JEDEC specification JESD22-C101 ⁽²⁾	±1000	

- (1) JEDEC document JEP155 states that 500-V HBM allows safe manufacturing with a standard ESD control process.
- (2) JEDEC document JEP157 states that 250-V CDM allows safe manufacturing with a standard ESD control process.

7.3 Recommended Operating Conditions

over operating free-air temperature range (unless otherwise noted)

		MIN	MAX	UNIT
Supply voltage $V_S = (V+) - (V-)$	Single-supply	1.8	5.5	V
	Dual-supply	±0.9	±2.75	
Input Voltage Range		$(V-)$	$(V+)$	V
Specified temperature		-40	125	°C

7.4 Thermal Information

THERMAL METRIC ⁽¹⁾		INA350ABS, INA350CDS			UNIT
		DDF (SOT-23-THN)	DSG (WSON)	RUG (X2QFN)	
		8 PINS	8 PINS	10 PINS	
$R_{\theta JA}$	Junction-to-ambient thermal resistance	169.1	89.2	199.0	°C/W
$R_{\theta JC(top)}$	Junction-to-case (top) thermal resistance	101.7	111.8	78.3	°C/W
$R_{\theta JB}$	Junction-to-board thermal resistance	84.8	55.8	123.2	°C/W
Ψ_{JT}	Junction-to-top characterization parameter	12.6	9.3	2.1	°C/W
Ψ_{JB}	Junction-to-board characterization parameter	84.3	55.7	122.7	°C/W
$R_{\theta JC(bot)}$	Junction-to-case (bottom) thermal resistance	n/a	31.0	n/a	°C/W

- (1) For more information about traditional and new thermal metrics, see the [Semiconductor and IC Package Thermal Metrics](#) application report.

7.5 Electrical Characteristics

For $V_S = (V_+) - (V_-) = 1.8\text{ V to }5.5\text{ V}$ ($\pm 0.9\text{ V to } \pm 2.75\text{ V}$) at $T_A = 25^\circ\text{C}$, $V_{REF} = V_S/2$, $G = 10, 20, 30$, and 50 , $R_L = 10\text{ k}\Omega$ connected to $V_S/2$, $V_{CM} = [(V_{IN+}) + (V_{IN-})] / 2 = V_S/2$, $V_{IN} = (V_{IN+}) - (V_{IN-}) = 0\text{ V}$ and $V_{OUT} = V_S/2$ (unless otherwise noted)

PARAMETER		TEST CONDITIONS		MIN	TYP	MAX	UNIT
INPUT							
V_{OSI}	Offset Voltage, RTI ⁽¹⁾	$V_S = 5.5\text{ V}$	$T_A = 25^\circ\text{C}$		± 0.2	± 1.2	mV
V_{OSI}	Offset Voltage over T, RTI ⁽¹⁾	$V_S = 5.5\text{ V}$	$T_A = -40^\circ\text{C to }125^\circ\text{C}$			± 1.3	mV
V_{OSI}	Offset temp drift, RTI ⁽²⁾	$V_S = 5.5\text{ V}$	$T_A = -40^\circ\text{C to }125^\circ\text{C}$		± 0.6		$\mu\text{V}/^\circ\text{C}$
PSRR	Power-supply rejection ratio		$T_A = 25^\circ\text{C}$		20	75	$\mu\text{V}/\text{V}$
Z_{IN-DM}	Differential Impedance				$100 \parallel 5$		$\text{G}\Omega \parallel \text{pF}$
Z_{IN-CM}	Common Mode Impedance				$100 \parallel 9$		$\text{G}\Omega \parallel \text{pF}$
V_{CM}	Input Stage Common Mode Range ⁽³⁾			(V-)		(V+)	V
CMRR DC	Common-mode rejection ratio, RTI	$V_{CM} = (V_-) + 0.1\text{ V to } (V_+) - 1\text{ V}$, High CMRR Region	$V_S = 5.5\text{ V}$, $V_{REF} = V_S/2$	85	95		dB
CMRR DC	Common-mode rejection ratio, RTI	$V_{CM} = (V_-) + 0.1\text{ V to } (V_+) - 1\text{ V}$, High CMRR Region	$V_S = 3.3\text{ V}$, $V_{REF} = V_S/2$		94		dB
CMRR DC	Common-mode rejection ratio, RTI	$V_{CM} = (V_-) + 0.1\text{ V to } (V_+) - 0.1\text{ V}$	$V_S = 5.5\text{ V}$, $V_{REF} = V_S/2$	62	75		dB
BIAS CURRENT							
I_B	Input bias current	$V_{CM} = V_S/2$			± 0.65		pA
I_{OS}	Input offset current	$V_{CM} = V_S/2$			± 0.25		pA
NOISE VOLTAGE							
e_{NI}	Input referred voltage noise density ⁽⁵⁾		$f = 1\text{ kHz}$		36		$\text{nV}/\sqrt{\text{Hz}}$
e_{NI}	Input referred voltage noise density ⁽⁵⁾		$f = 10\text{ kHz}$		34		$\text{nV}/\sqrt{\text{Hz}}$
E_{NI}	Input referred voltage noise ⁽⁵⁾	$f_B = 0.1\text{ Hz to }10\text{ Hz}$			3.2		μV_{PP}
i_n	Input current noise	$f = 1\text{ kHz}$	$f = 1\text{ kHz}$		22		$\text{fA}/\sqrt{\text{Hz}}$
GAIN							
GE	Gain error ⁽⁴⁾	$G = 10$, $V_{REF} = V_S/2$	$V_O = (V_-) + 0.1\text{ V to } (V_+) - 0.1\text{ V}$		± 0.05	± 0.50	%
		$G = 20$, $V_{REF} = V_S/2$		± 0.06	± 0.60		
	Gain error ⁽⁴⁾	$G = 30$, $V_{REF} = V_S/2$		± 0.075	± 0.60		
	$G = 50$, $V_{REF} = V_S/2$	± 0.082		± 0.60			
OUTPUT							
V_{OH}	Positive rail headroom	$R_L = 10\text{ k}\Omega$ to $V_S/2$			15	30	mV
V_{OL}	Negative rail headroom	$R_L = 10\text{ k}\Omega$ to $V_S/2$			15	30	mV
C_L Drive	Load capacitance drive	$V_O = 100\text{ mV}$ step, Overshoot < 20%			500		pF
Z_O	Closed-loop output impedance	$f = 10\text{ kHz}$			51		Ω
I_{SC}	Short-circuit current	$V_S = 5.5\text{ V}$			± 20		mA
FREQUENCY RESPONSE							
BW	Bandwidth, -3 dB	$G = 10$	$V_{IN} = 10\text{ mV}_{pk-pk}$		100		kHz
		$G = 20$		50			
	Bandwidth, -3 dB	$G = 30$		40			
		$G = 50$		25			
THD + N	Total harmonic distortion + noise	$V_S = 5.5\text{ V}$, $V_{CM} = 2.75\text{ V}$, $V_O = 1\text{ V}_{RMS}$, $G = 10$, $R_L = 100\text{ k}\Omega$ $f = 1\text{ kHz}$, 80-kHz measurement BW			0.04		%
THD + N	Total harmonic distortion + noise	$V_S = 5.5\text{ V}$, $V_{CM} = 2.75\text{ V}$, $V_O = 1\text{ V}_{RMS}$, $G = 50$, $R_L = 100\text{ k}\Omega$ $f = 1\text{ kHz}$, 80-kHz measurement BW	$V_S = 5.5\text{ V}$, $V_{CM} = 2.75\text{ V}$, $V_O = 1\text{ V}_{RMS}$, $G = 50$, $R_L = 100\text{ k}\Omega$ $f = 1\text{ kHz}$, 80-kHz measurement BW		0.15		%

7.5 Electrical Characteristics (continued)

For $V_S = (V_+) - (V_-) = 1.8\text{ V to }5.5\text{ V}$ ($\pm 0.9\text{ V to } \pm 2.75\text{ V}$) at $T_A = 25^\circ\text{C}$, $V_{REF} = V_S/2$, $G = 10, 20, 30,$ and 50 , $R_L = 10\text{ k}\Omega$ connected to $V_S/2$, $V_{CM} = [(V_{IN+}) + (V_{IN-})] / 2 = V_S/2$, $V_{IN} = (V_{IN+}) - (V_{IN-}) = 0\text{ V}$ and $V_{OUT} = V_S/2$ (unless otherwise noted)

PARAMETER		TEST CONDITIONS	MIN	TYP	MAX	UNIT
EMIRR	Electro-magnetic interference rejection ratio	$f = 1\text{ GHz}$, $V_{IN_EMIRR} = 100\text{ mV}$		96		dB
SR	Slew rate	$V_S = 5\text{ V}$, $V_O = 2\text{ V step}$		0.24		V/ μs
t_s	Settling time	$G = 10$, $T_o 0.1\%$, $V_S = 5.5\text{ V}$, $V_{STEP} = 2\text{ V}$, $C_L = 10\text{ pF}$		17		μs
		$G = 10$, $T_o 0.01\%$, $V_S = 5.5\text{ V}$, $V_{STEP} = 2\text{ V}$, $C_L = 10\text{ pF}$		38		
		$G = 20$, $T_o 0.1\%$, $V_S = 5.5\text{ V}$, $V_{STEP} = 2\text{ V}$, $C_L = 10\text{ pF}$		20		
		$G = 20$, $T_o 0.01\%$, $V_S = 5.5\text{ V}$, $V_{STEP} = 2\text{ V}$, $C_L = 10\text{ pF}$		27		
	Settling time	$G = 30$, $T_o 0.1\%$, $V_S = 5.5\text{ V}$, $V_{STEP} = 2\text{ V}$, $C_L = 10\text{ pF}$		30		
		$G = 30$, $T_o 0.01\%$, $V_S = 5.5\text{ V}$, $V_{STEP} = 2\text{ V}$, $C_L = 10\text{ pF}$		57		
		$G = 50$, $T_o 0.1\%$, $V_S = 5.5\text{ V}$, $V_{STEP} = 2\text{ V}$, $C_L = 10\text{ pF}$		44		
		$G = 50$, $T_o 0.01\%$, $V_S = 5.5\text{ V}$, $V_{STEP} = 2\text{ V}$, $C_L = 10\text{ pF}$		85		
	Overload recovery	$V_{IN} = 1\text{ V}$, $G = 10$		16		μs
	Overload recovery	$V_{IN} = 1\text{ V}$, $G = 50$	$V_{IN} = 1\text{ V}$, $G = 50$	6.5		μs
REFERENCE INPUT						
R_{IN}	Input impedance			60		k Ω
	Voltage range		(V-)		(V+)	V
	Gain to output			1		V/V
	Reference gain error			± 0.004		%
POWER SUPPLY						
V_S	Power-supply voltage	Single-supply		1.7	5.5	V
V_S	Power-supply voltage	Dual-supply		± 0.85	± 2.75	V
I_Q	Quiescent current	$V_{IN} = 0\text{ V}$		100	125	μA
		$T_A = -40^\circ\text{C to }125^\circ\text{C}$			135	
I_{QSD}	Quiescent current per amplifier	All amplifiers disabled, $\overline{\text{SHDN}} = V_-$		0.70	1.25	μA
V_{IL}	Logic low threshold voltage (Gain Select)	$G = 10$ for INA350ABS, $G = 30$ for INA350CDS			(V-) + 0.2 V	V
V_{IH}	Logic high threshold voltage (Gain Select)	$G = 20$ for INA350ABS, $G = 50$ for INA350CDS	(V-) + 1 V			V
t_{ON}	Amplifier enable time (full shutdown) ⁽⁶⁾	$V_{CM} = V_S/2$, $V_O = 0.9 \times V_S/2$, R_L connected to V-		100		μs
t_{OFF}	Amplifier disable time ⁽⁶⁾	$V_{CM} = V_S/2$, $V_O = 0.1 \times V_S/2$, R_L connected to V-		4		μs
	$\overline{\text{SHDN}}$ pin input bias current (per pin)	$(V_+) \geq \overline{\text{SHDN}} \geq (V_-) + 1\text{ V}$		10		nA
	$\overline{\text{SHDN}}$ pin input bias current (per pin)	$(V_-) \leq \overline{\text{SHDN}} \leq (V_-) + 0.2\text{ V}$		175		nA

- (1) Total offset, referred-to-input (RTI): $V_{OS} = (V_{OSI}) + (V_{OSO} / G)$.
- (2) Offset drifts are uncorrelated. Input-referred offset drift is calculated using: $\Delta V_{OS(RTI)} = \sqrt{[\Delta V_{OSI}]^2 + (\Delta V_{OSO} / G)^2}$
- (3) Input common mode voltage range of the just the input stage of the instrumentation amplifier. The entire INA350x input range depends on the combination input common-mode voltage, differential voltage, gain, reference voltage and power supply voltage. *Typical Characteristic* curves will be added with more information.
- (4) Min and Max values are specified by characterization.
- (5) Total RTI voltage noise is equal to: $e_{N(RTI)} = \sqrt{[e_{NI}]^2 + (e_{NO} / G)^2}$
- (6) Disable time (t_{OFF}) and enable time (t_{ON}) are defined as the time interval between the 50% point of the signal applied to the $\overline{\text{SHDN}}$ pin and the point at which the output voltage reaches the 10% (disable) or 90% (enable) level.

7.6 Typical Characteristics

at $T_A = 25^\circ\text{C}$, $V_S = (V+) - (V-) = 5.5\text{ V}$, $V_{IN} = (V_{IN+}) - (V_{IN-}) = 0\text{ V}$, $R_L = 10\text{ k}\Omega$, $C_L = 10\text{ pF}$, $V_{REF} = V_S / 2$, $V_{CM} = [(V_{IN+}) + (V_{IN-})] / 2 = V_S / 2$, $V_{OUT} = V_S / 2$ and $G = 10$ (unless otherwise noted)

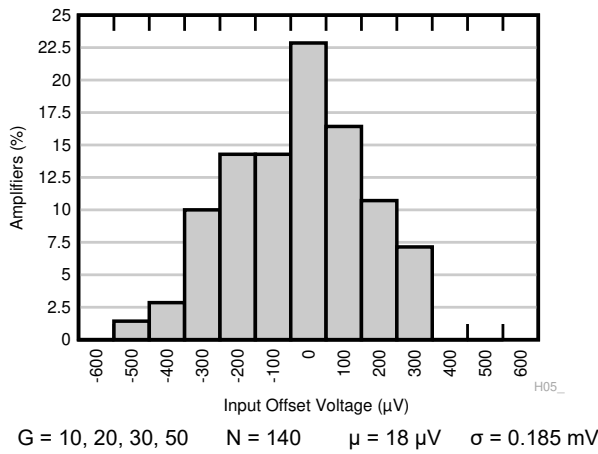

Figure 7-1. Typical Distribution of Input Referred Offset Voltage

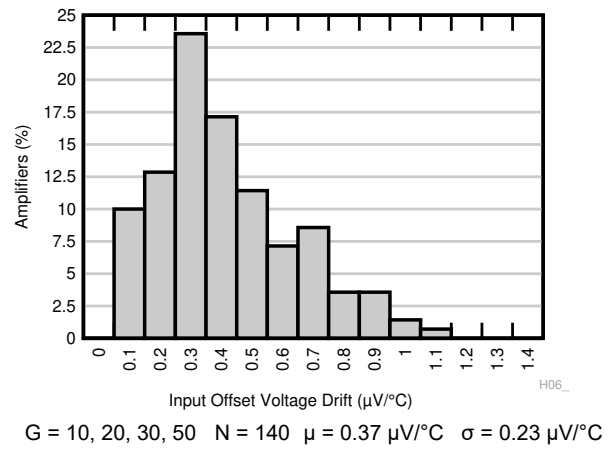

Figure 7-2. Typical Distribution of Input Referred Offset Drift

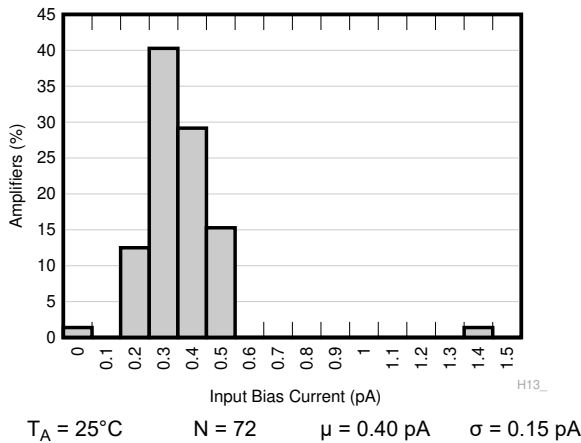

Figure 7-3. Typical Distribution of Input Bias Current

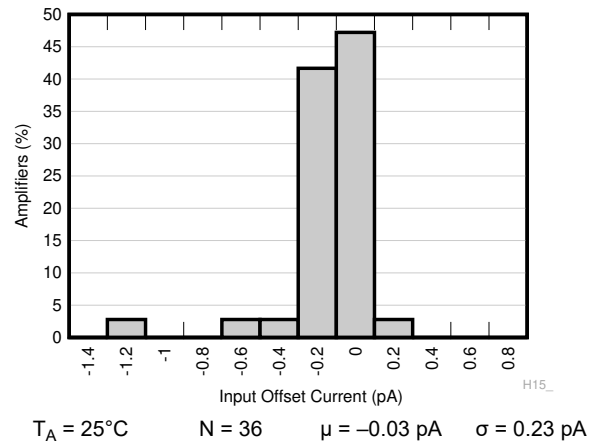

Figure 7-4. Typical Distribution of Input Offset Current

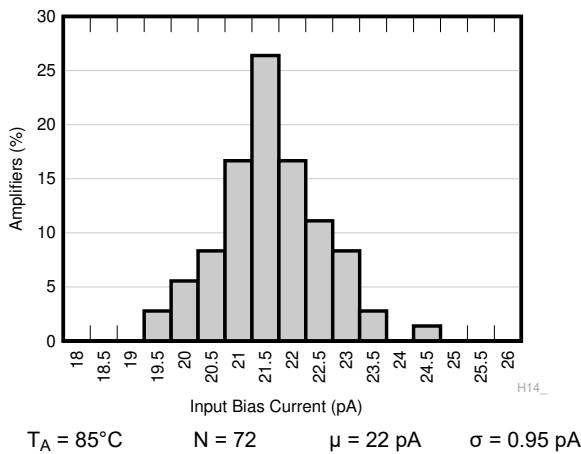

Figure 7-5. Typical Distribution of Input Bias Current

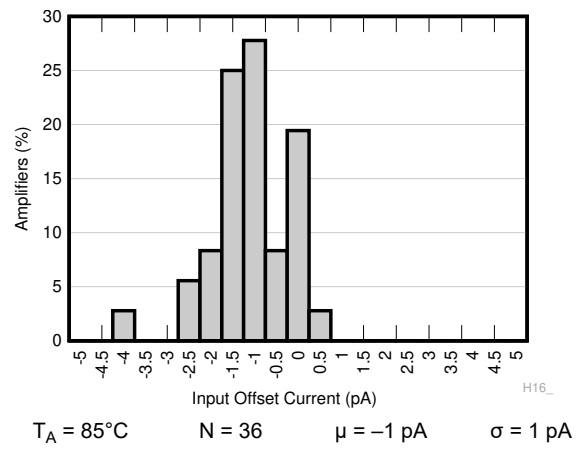
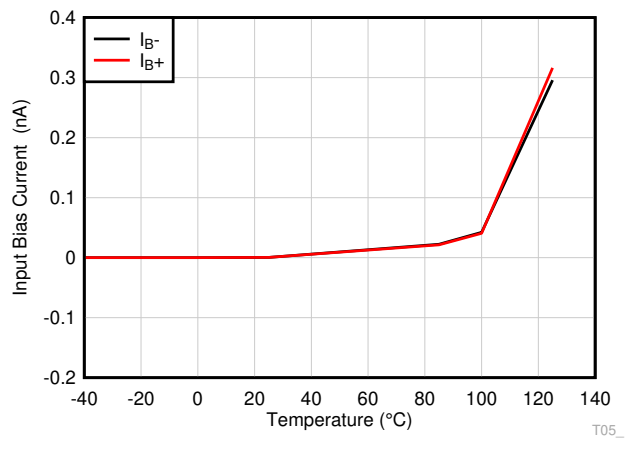
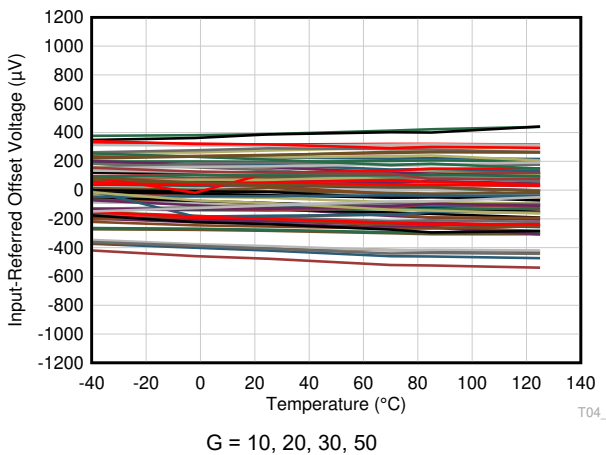
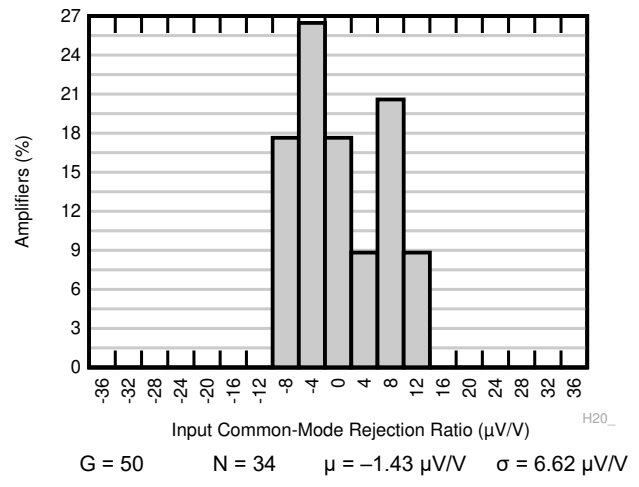
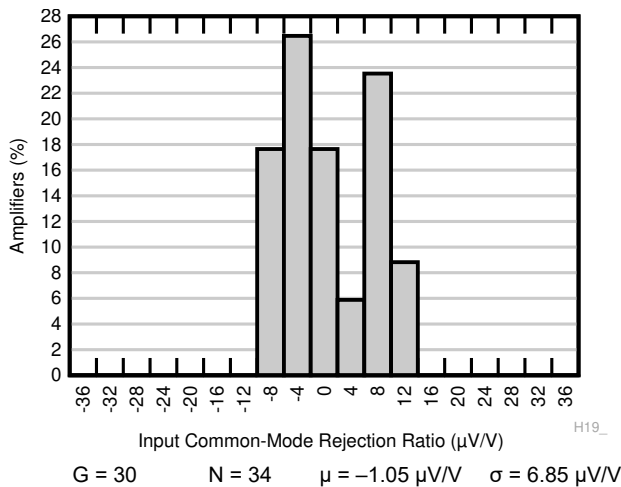
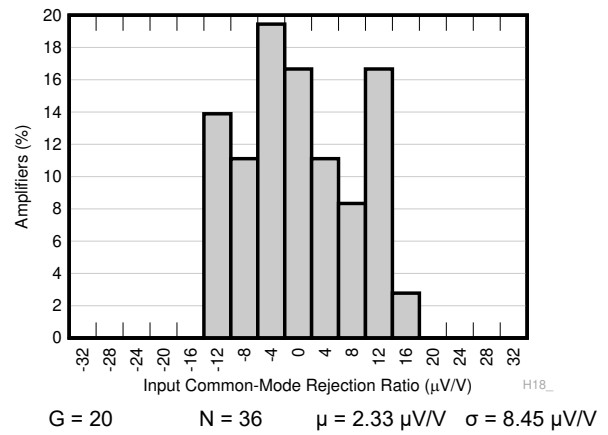
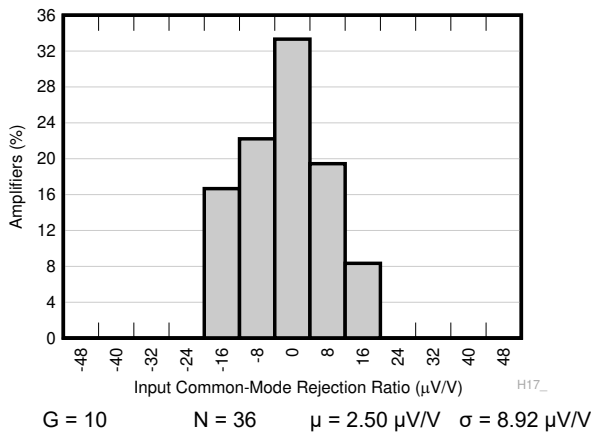

Figure 7-6. Typical Distribution of Input Offset Current

7.6 Typical Characteristics (continued)

at $T_A = 25^\circ\text{C}$, $V_S = (V_+) - (V_-) = 5.5\text{ V}$, $V_{IN} = (V_{IN+}) - (V_{IN-}) = 0\text{ V}$, $R_L = 10\text{ k}\Omega$, $C_L = 10\text{ pF}$, $V_{REF} = V_S / 2$, $V_{CM} = [(V_{IN+}) + (V_{IN-})] / 2 = V_S / 2$, $V_{OUT} = V_S / 2$ and $G = 10$ (unless otherwise noted)



7.6 Typical Characteristics (continued)

at $T_A = 25^\circ\text{C}$, $V_S = (V+) - (V-) = 5.5\text{ V}$, $V_{IN} = (V_{IN+}) - (V_{IN-}) = 0\text{ V}$, $R_L = 10\text{ k}\Omega$, $C_L = 10\text{ pF}$, $V_{REF} = V_S / 2$, $V_{CM} = [(V_{IN+}) + (V_{IN-})] / 2 = V_S / 2$, $V_{OUT} = V_S / 2$ and $G = 10$ (unless otherwise noted)

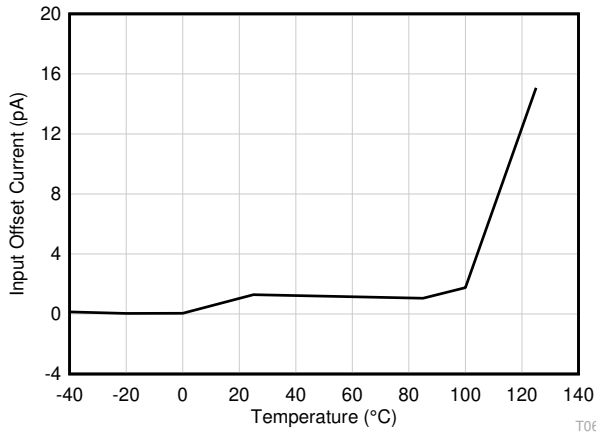

Figure 7-13. Input Offset Current vs Temperature

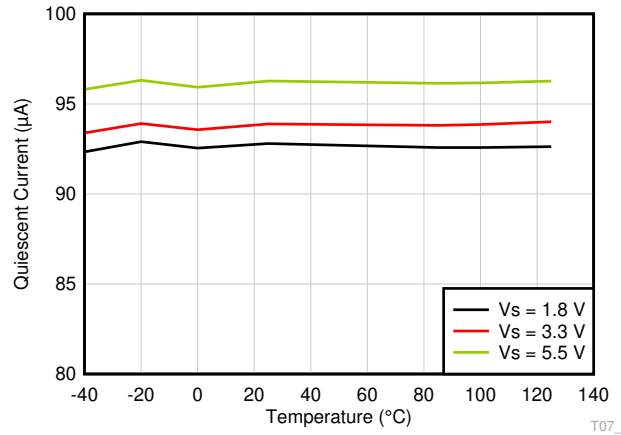

Figure 7-14. Quiescent Current vs Temperature

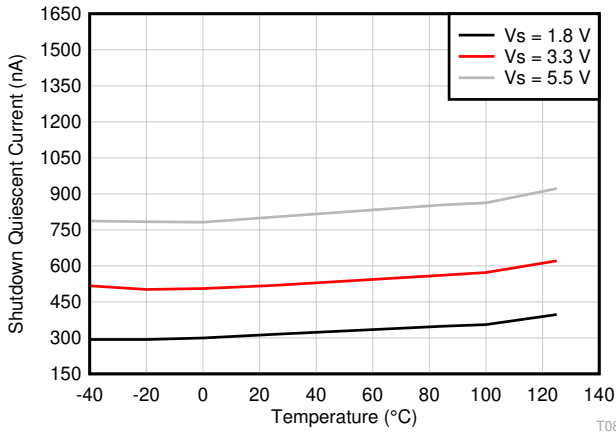

Figure 7-15. Shutdown Quiescent Current vs Temperature

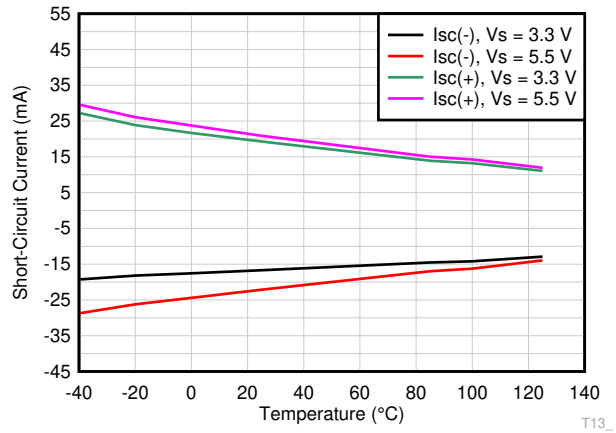

Figure 7-16. Short Circuit Current vs Temperature

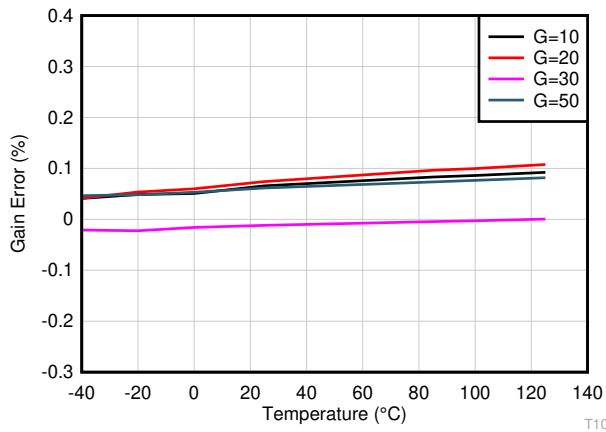

Figure 7-17. Gain Error vs Temperature

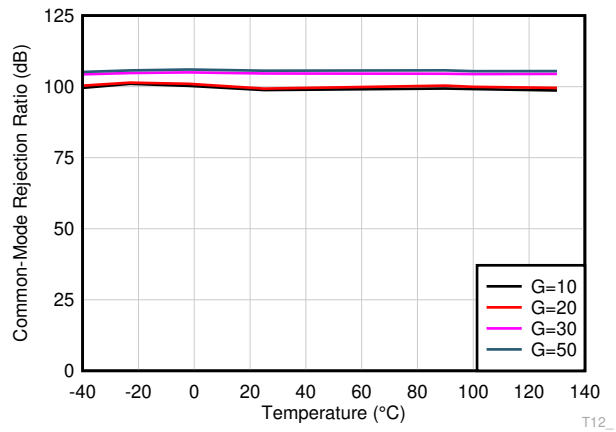

Figure 7-18. CMRR vs Temperature

7.6 Typical Characteristics (continued)

at $T_A = 25^\circ\text{C}$, $V_S = (V_+) - (V_-) = 5.5\text{ V}$, $V_{IN} = (V_{IN+}) - (V_{IN-}) = 0\text{ V}$, $R_L = 10\text{ k}\Omega$, $C_L = 10\text{ pF}$, $V_{REF} = V_S / 2$, $V_{CM} = [(V_{IN+}) + (V_{IN-})] / 2 = V_S / 2$, $V_{OUT} = V_S / 2$ and $G = 10$ (unless otherwise noted)

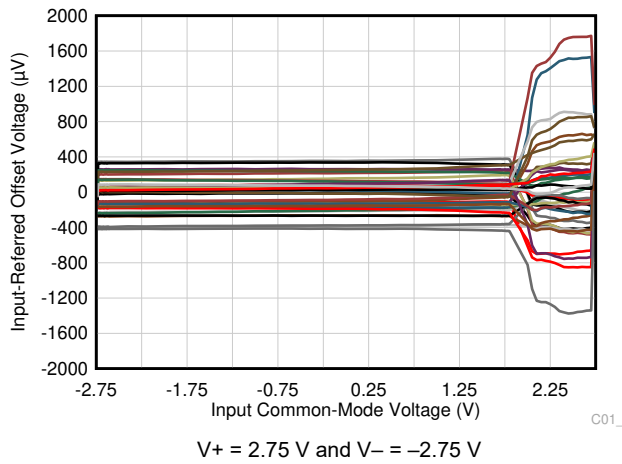

Figure 7-19. Input Referred Offset Voltage vs Input Common-Mode Voltage

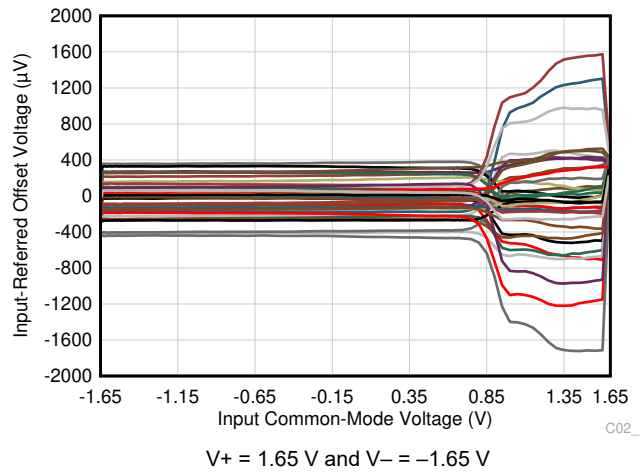

Figure 7-20. Input Referred Offset Voltage vs Input Common-Mode Voltage

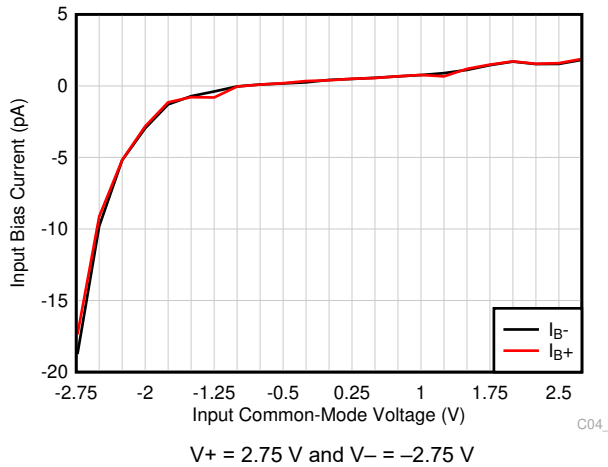

Figure 7-21. Input Bias Current vs Input Common-Mode Voltage

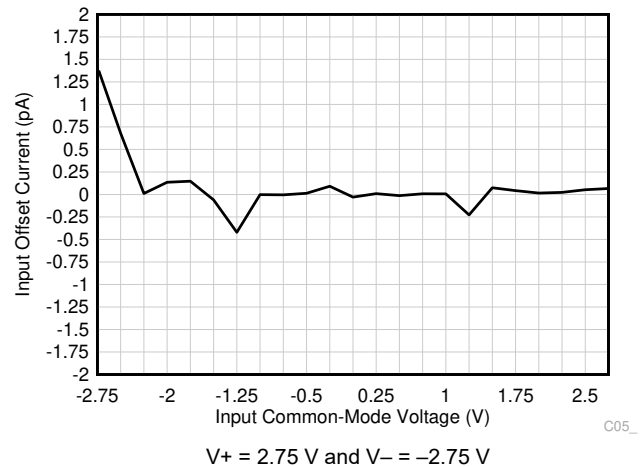

Figure 7-22. Input Offset Current vs Input Common-Mode Voltage

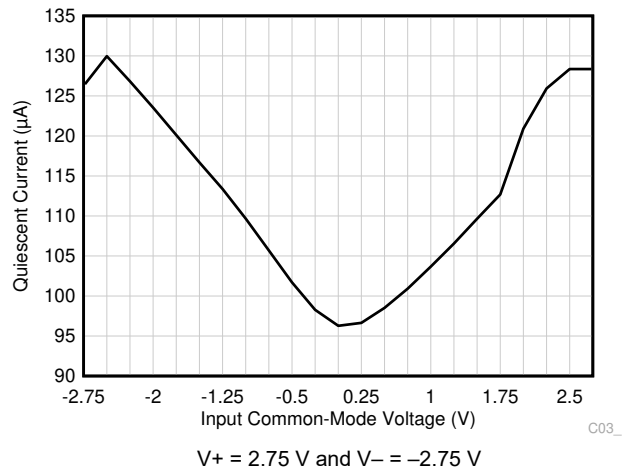

Figure 7-23. Quiescent Current vs Input Common-Mode Voltage

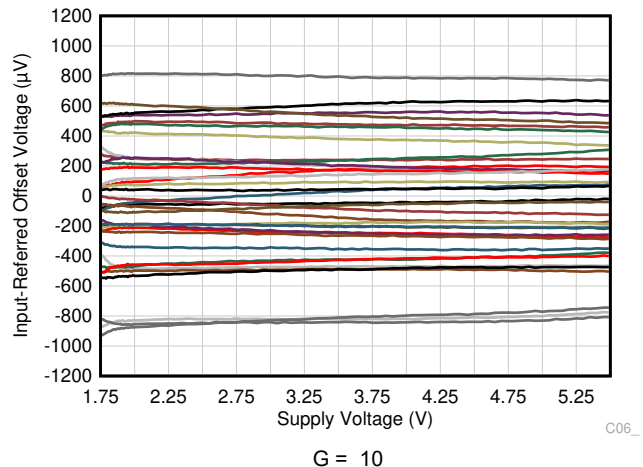

Figure 7-24. Input Referred Offset Voltage vs Supply Voltage

7.6 Typical Characteristics (continued)

at $T_A = 25^\circ\text{C}$, $V_S = (V+) - (V-) = 5.5\text{ V}$, $V_{IN} = (V_{IN+}) - (V_{IN-}) = 0\text{ V}$, $R_L = 10\text{ k}\Omega$, $C_L = 10\text{ pF}$, $V_{REF} = V_S / 2$, $V_{CM} = [(V_{IN+}) + (V_{IN-})] / 2 = V_S / 2$, $V_{OUT} = V_S / 2$ and $G = 10$ (unless otherwise noted)

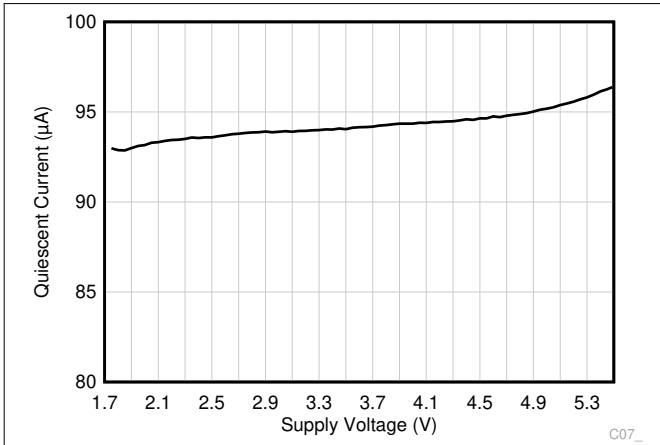

Figure 7-25. Quiescent Current vs Supply Voltage

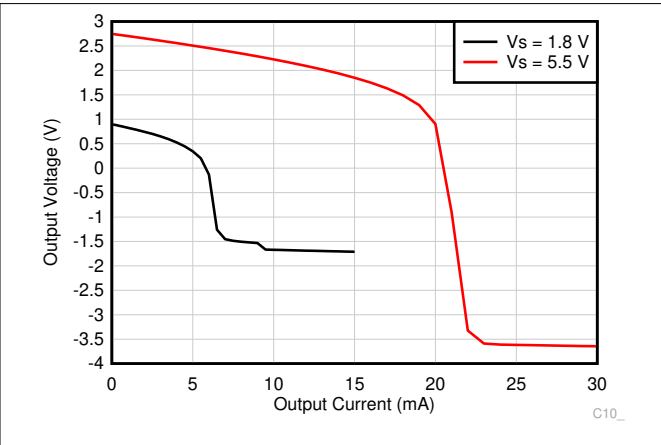

Figure 7-26. Output Voltage vs Output Current (Sourcing)

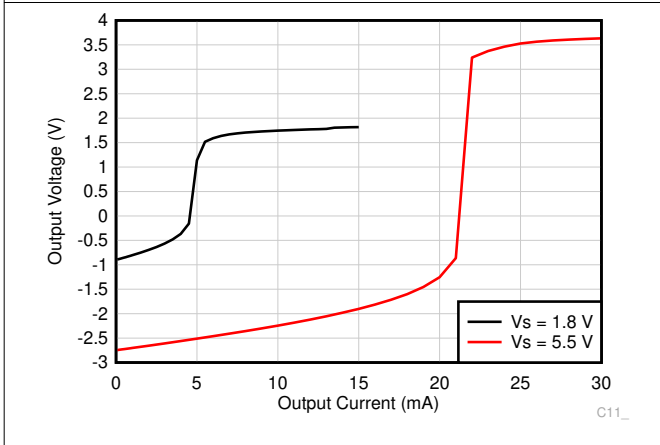

Figure 7-27. Output Voltage vs Output Current (Sinking)

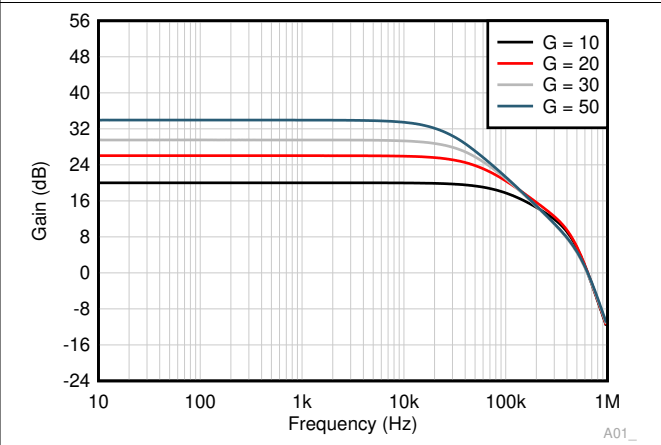

Figure 7-28. Closed-Loop Gain vs Frequency

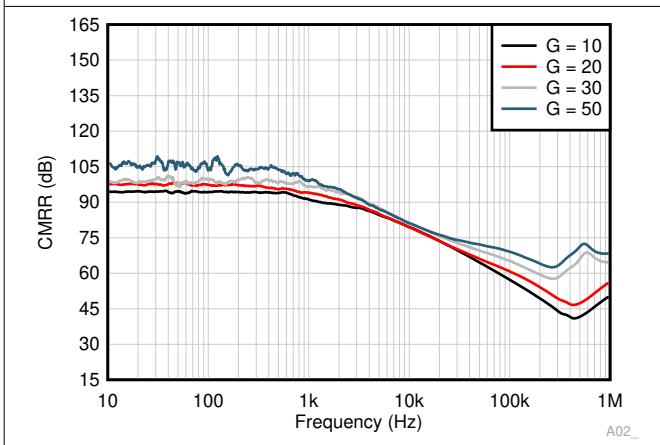

Figure 7-29. CMRR (Referred to Input) vs Frequency

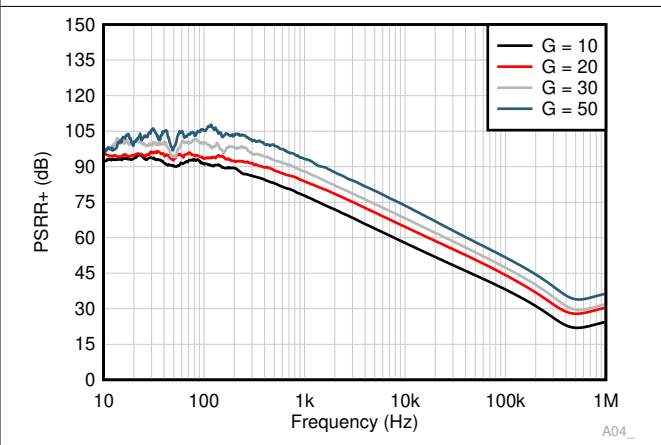

Figure 7-30. PSRR+ (Referred to Input) vs Frequency

7.6 Typical Characteristics (continued)

at $T_A = 25^\circ\text{C}$, $V_S = (V_+) - (V_-) = 5.5\text{ V}$, $V_{IN} = (V_{IN+}) - (V_{IN-}) = 0\text{ V}$, $R_L = 10\text{ k}\Omega$, $C_L = 10\text{ pF}$, $V_{REF} = V_S / 2$, $V_{CM} = [(V_{IN+}) + (V_{IN-})] / 2 = V_S / 2$, $V_{OUT} = V_S / 2$ and $G = 10$ (unless otherwise noted)

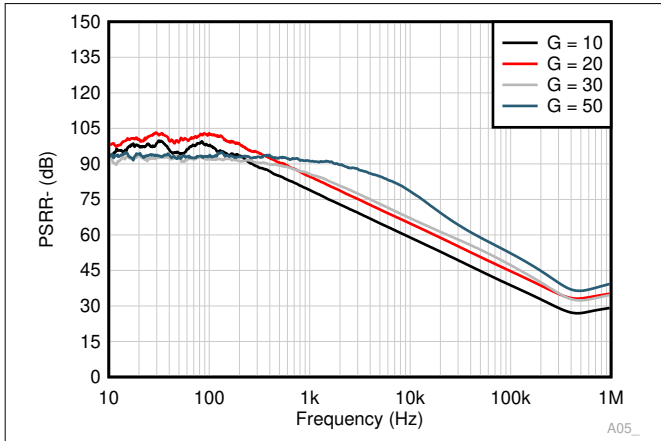

Figure 7-31. PSRR- (Referred to Input) Vs Frequency

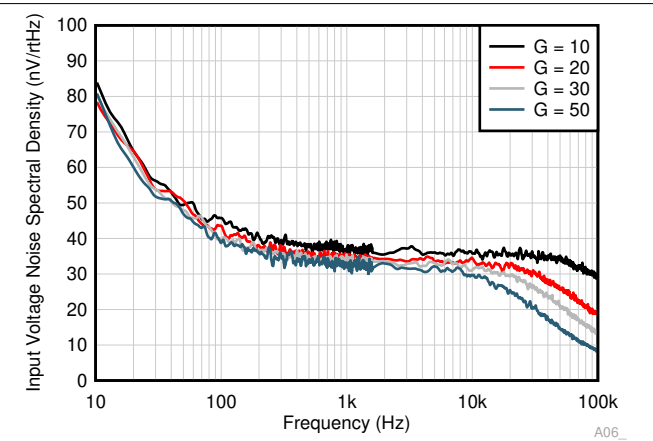

Figure 7-32. Input Referred Voltage Noise Spectral Density

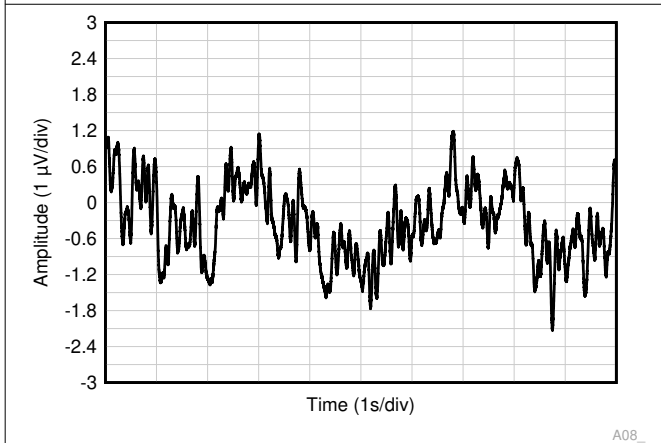

Figure 7-33. 0.1 Hz to 10 Hz Voltage Noise in Time Domain

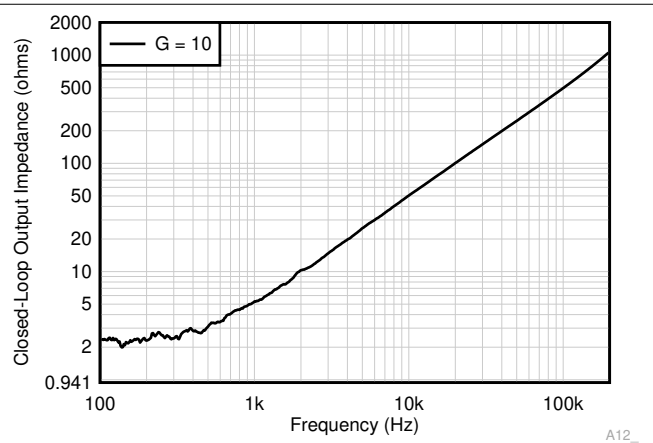

Figure 7-34. Closed-Loop Output Impedance vs Frequency

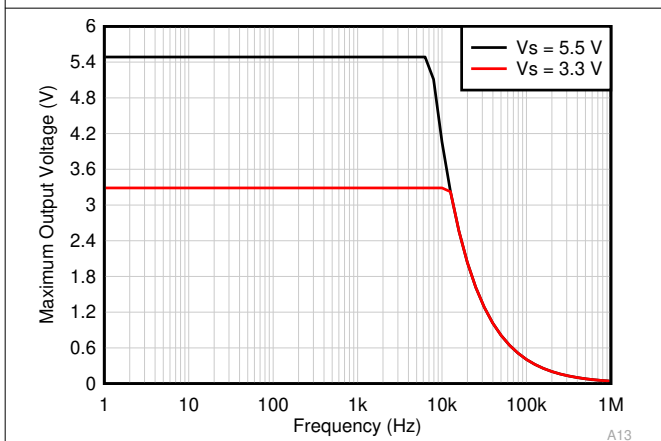
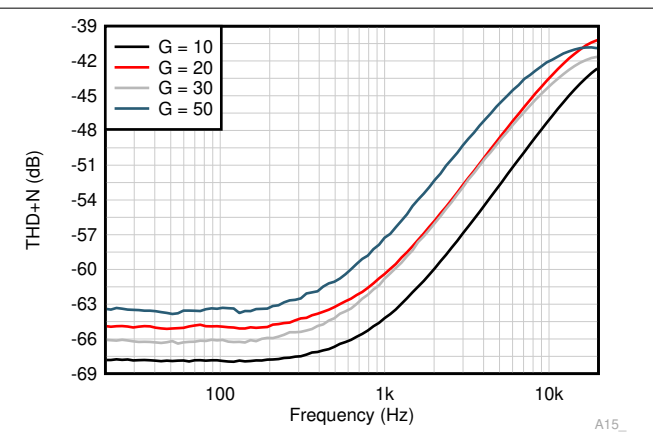

Figure 7-35. Maximum Output Voltage vs Frequency



$V_S = 5.5\text{ V}$ $BW = 80\text{ kHz}$ $V_{CM} = 2.75\text{ V}$
 $R_L = 10\text{ k}\Omega$ $V_{OUT} = 0.5\text{ V}_{RMS}$

Figure 7-36. THD + N Frequency

7.6 Typical Characteristics (continued)

at $T_A = 25^\circ\text{C}$, $V_S = (V_+) - (V_-) = 5.5\text{ V}$, $V_{IN} = (V_{IN+}) - (V_{IN-}) = 0\text{ V}$, $R_L = 10\text{ k}\Omega$, $C_L = 10\text{ pF}$, $V_{REF} = V_S / 2$, $V_{CM} = [(V_{IN+}) + (V_{IN-})] / 2 = V_S / 2$, $V_{OUT} = V_S / 2$ and $G = 10$ (unless otherwise noted)

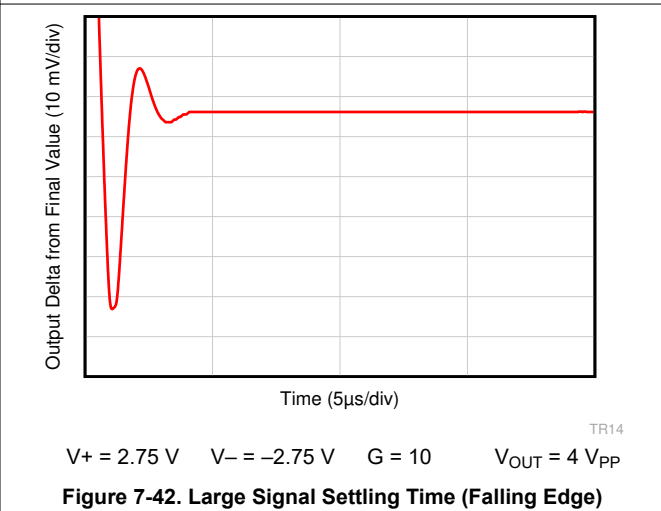
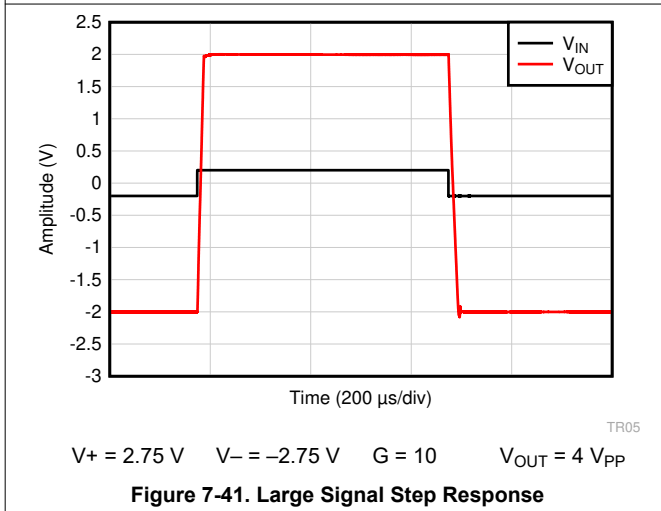
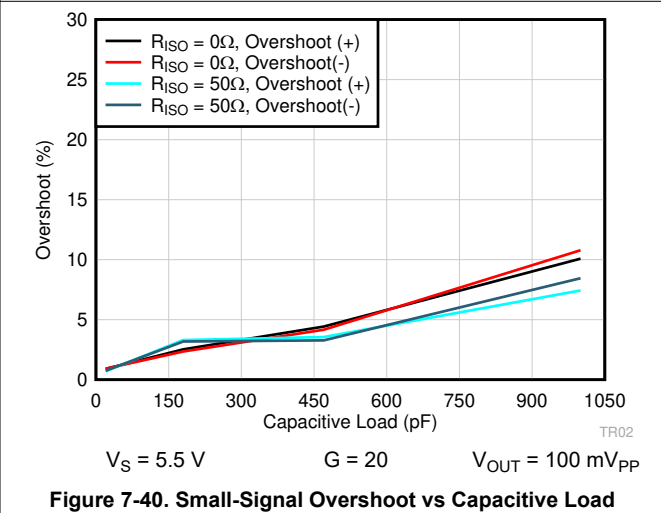
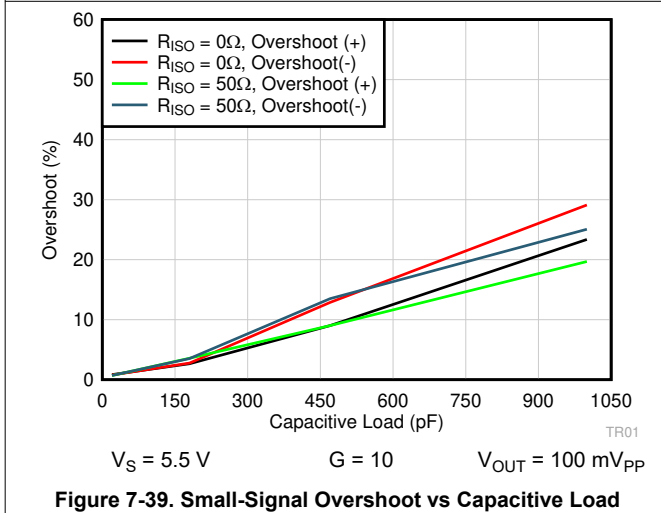
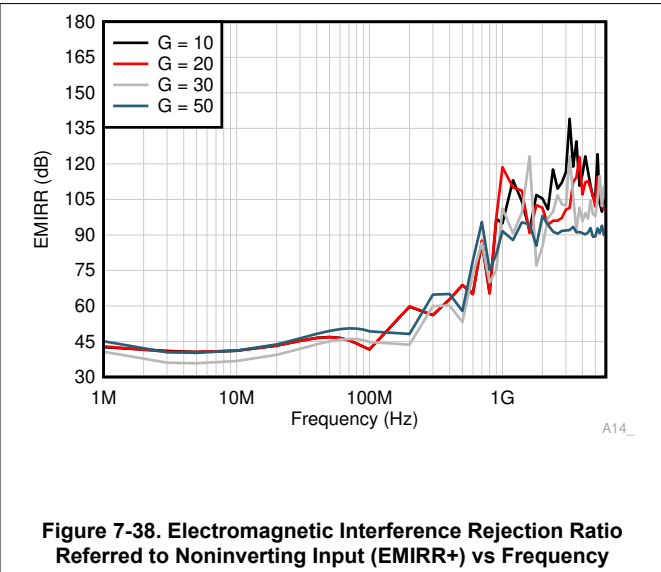
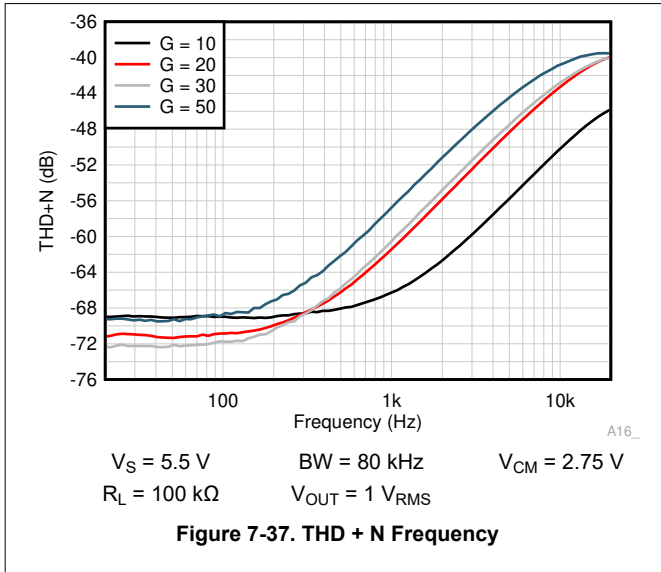

7.6 Typical Characteristics (continued)

at $T_A = 25^\circ\text{C}$, $V_S = (V_+) - (V_-) = 5.5\text{ V}$, $V_{IN} = (V_{IN+}) - (V_{IN-}) = 0\text{ V}$, $R_L = 10\text{ k}\Omega$, $C_L = 10\text{ pF}$, $V_{REF} = V_S / 2$, $V_{CM} = [(V_{IN+}) + (V_{IN-})] / 2 = V_S / 2$, $V_{OUT} = V_S / 2$ and $G = 10$ (unless otherwise noted)

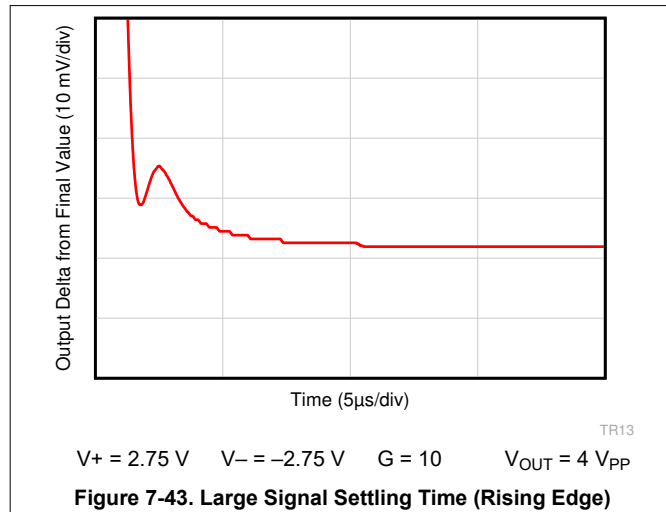

Figure 7-43. Large Signal Settling Time (Rising Edge)

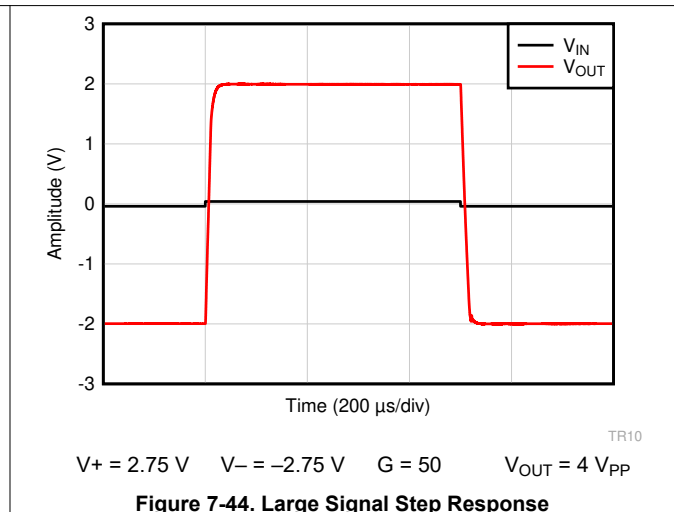

Figure 7-44. Large Signal Step Response

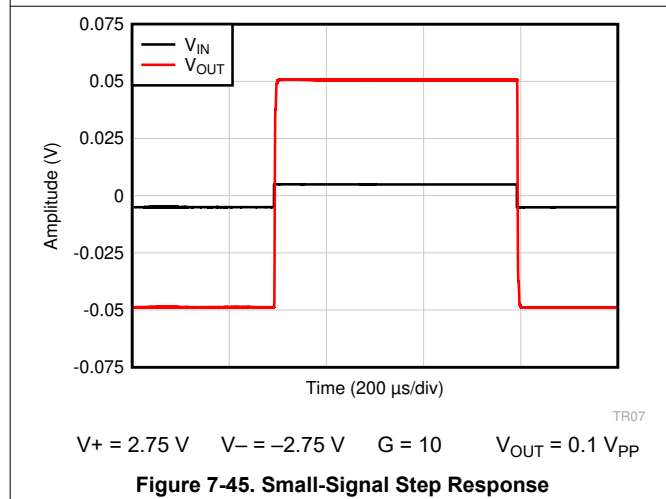

Figure 7-45. Small-Signal Step Response

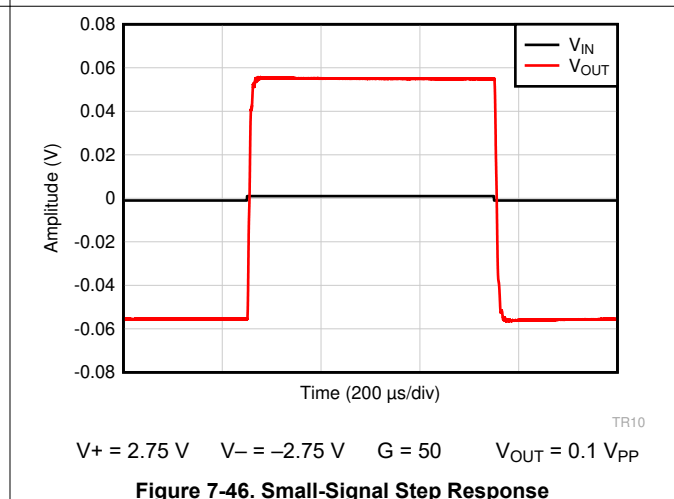

Figure 7-46. Small-Signal Step Response

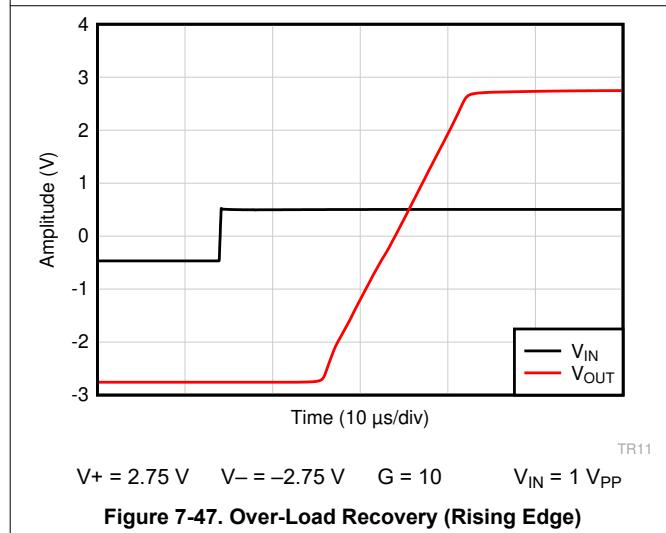

Figure 7-47. Over-Load Recovery (Rising Edge)

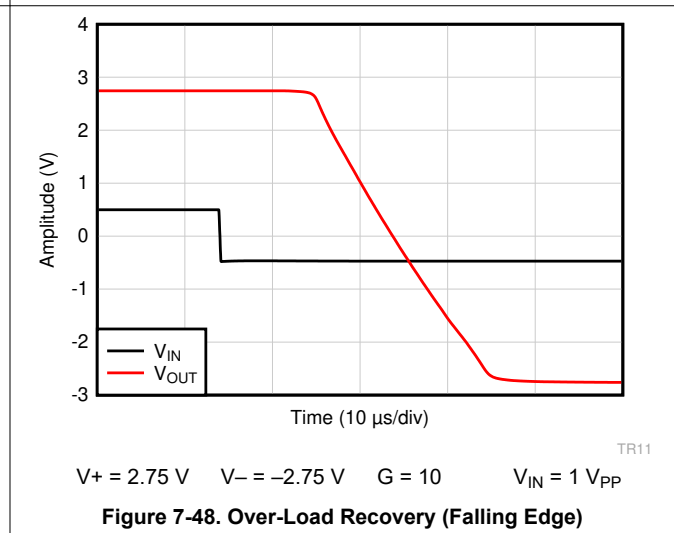

Figure 7-48. Over-Load Recovery (Falling Edge)

7.6 Typical Characteristics (continued)

at $T_A = 25^\circ\text{C}$, $V_S = (V+) - (V-) = 5.5\text{ V}$, $V_{IN} = (V_{IN+}) - (V_{IN-}) = 0\text{ V}$, $R_L = 10\text{ k}\Omega$, $C_L = 10\text{ pF}$, $V_{REF} = V_S / 2$, $V_{CM} = [(V_{IN+}) + (V_{IN-})] / 2 = V_S / 2$, $V_{OUT} = V_S / 2$ and $G = 10$ (unless otherwise noted)

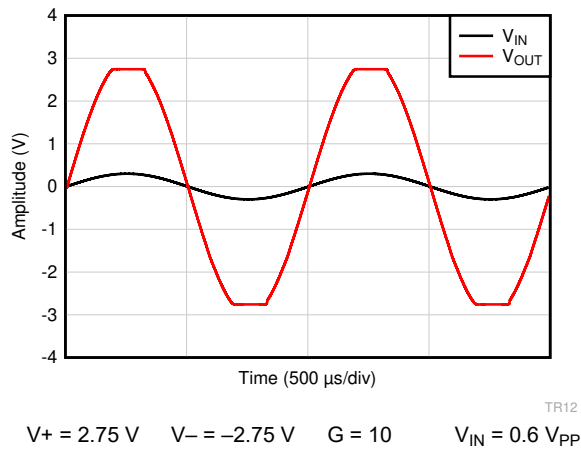

Figure 7-49. No Phase Reversal

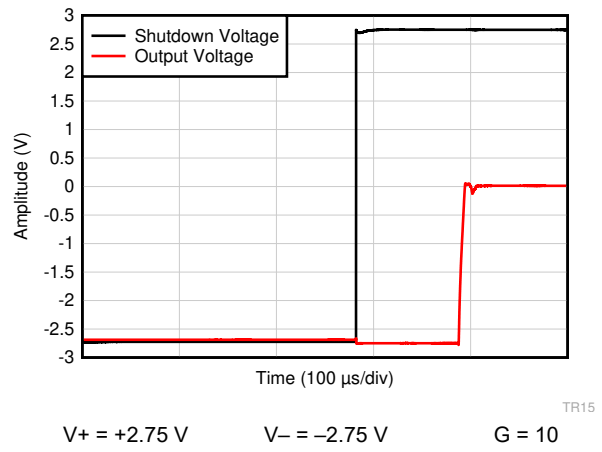

Figure 7-50. Enable Response

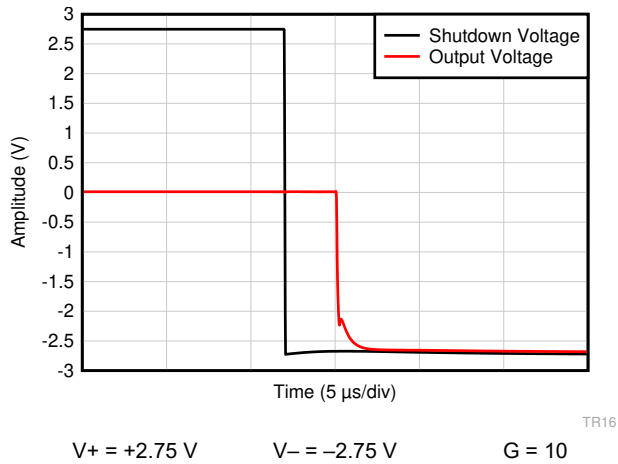

Figure 7-51. Disable Response

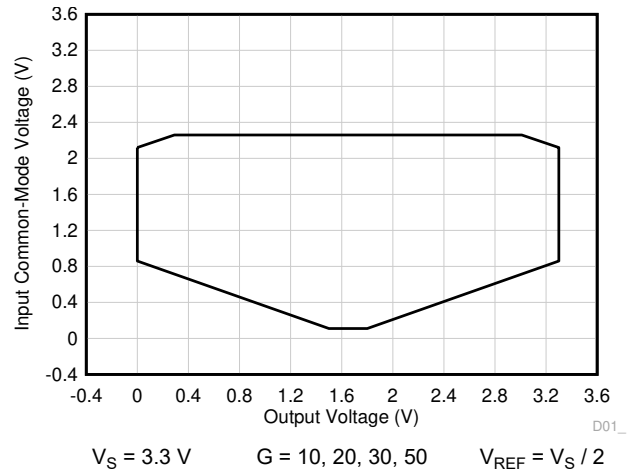

Figure 7-52. Input Common-Mode Voltage vs Output Voltage (High CMRR Region)

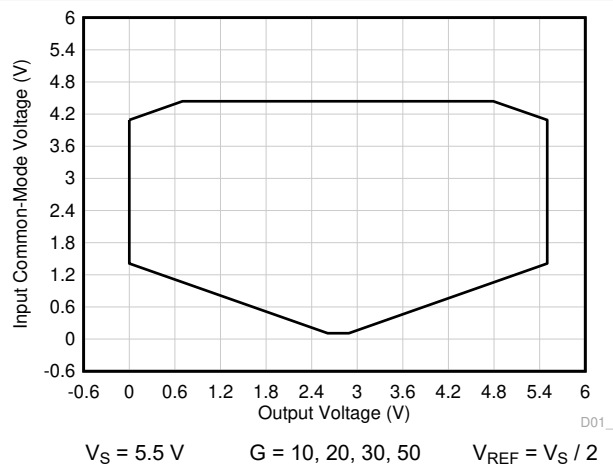

Figure 7-53. Input Common-Mode Voltage vs Output Voltage (High CMRR Region)

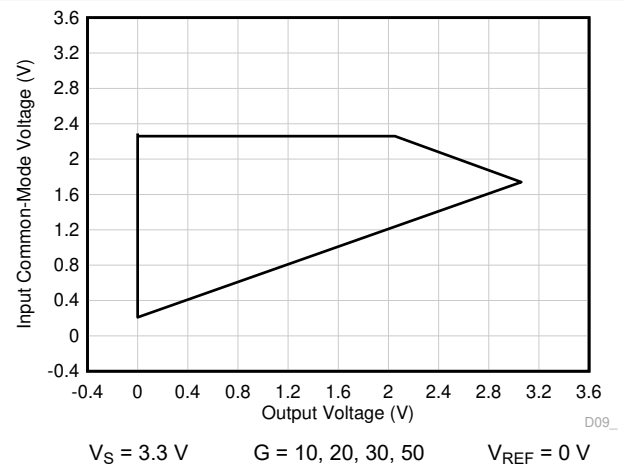
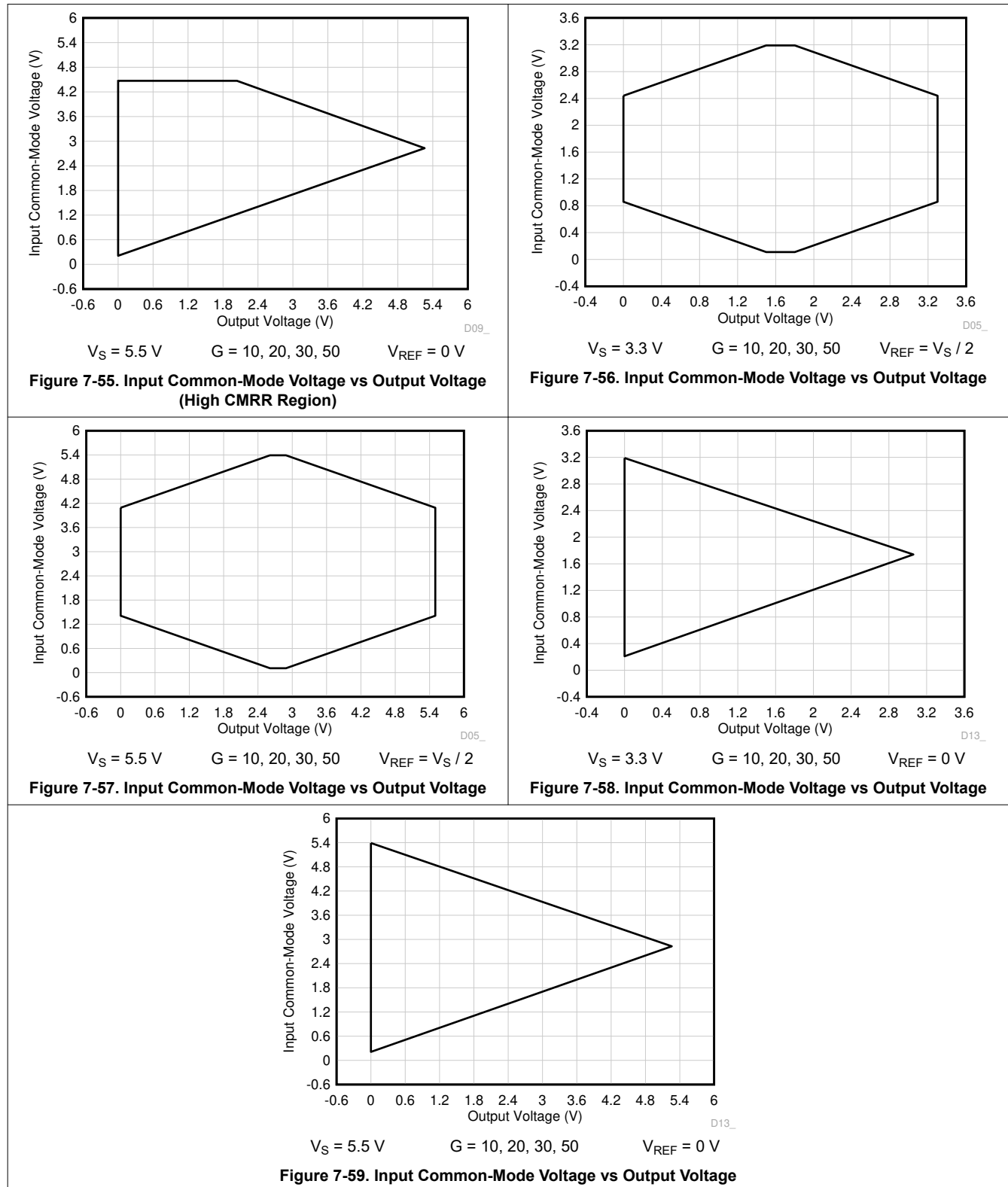

Figure 7-54. Input Common-Mode Voltage vs Output Voltage (High CMRR Region)

7.6 Typical Characteristics (continued)

at $T_A = 25^\circ\text{C}$, $V_S = (V_+) - (V_-) = 5.5\text{ V}$, $V_{IN} = (V_{IN+}) - (V_{IN-}) = 0\text{ V}$, $R_L = 10\text{ k}\Omega$, $C_L = 10\text{ pF}$, $V_{REF} = V_S / 2$, $V_{CM} = [(V_{IN+}) + (V_{IN-})] / 2 = V_S / 2$, $V_{OUT} = V_S / 2$ and $G = 10$ (unless otherwise noted)



8 Detailed Description

8.1 Overview

INA350 is a selectable gain instrumentation amplifier mainly targeted to provide an integrated small size, cost effective solution for applications employing general purpose INAs or discrete implementation of INAs using commodity amplifiers and resistors. It incorporates a three op amp INA architecture integrating three operational amplifiers and seven precision matched integrated resistors. It is mainly targeted for use in 10-bit to 14-bit systems, but calibrating offset and gain error at a system level can further improve system resolution and accuracy enabling use in precision applications.

One of the key features of INA350 is that it does not need any external resistors to set the gain. Often these external resistors warrant tighter tolerance and need to be routed carefully which adds to the system complexity and cost. INA350 is offered in four gain options across two variants. INA350ABS has two gain options of 10 and 20. INA350CDS has two other gain options of 30 and 50. Gains can be selected by connecting the GS pin to logic high or logic low. Note that the GS pin can be left floating as well, as it is designed with an internal pull up to default to the same configuration as GS tied logic high.

The INA350 is developed for industrial applications in factory automation and appliances sector where pressure sensing and temperature sensing are done using bridge-type sensor networks and load cells. It can also be used in tight spaces in medical applications such as patient monitoring, sleep diagnostics, electronic hospital beds, blood glucose monitoring, and so forth for voltage sensing and differential to single-ended conversion. INA350 can enable these applications to reduce their overall size through the use of tiny packages, including a 2-mm × 1.5-mm X2QFN package and a 2-mm × 2-mm WSON package.

8.2 Functional Block Diagram

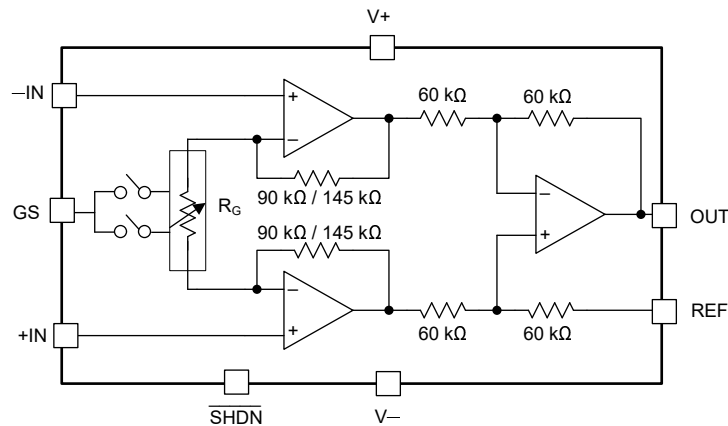

Note: 90 kΩ for INA350ABS and 145 kΩ for INA350CDS

Simplified Internal Schematic

8.3 Feature Description

8.3.1 Gain-Setting

The gain equation of INA350ABS can be given by [Equation 1](#):

$$G = 1 + \frac{180 \text{ k}\Omega}{R_G} \quad (1)$$

The value of the internal gain resistor R_G for INA350ABS can then be derived from the gain equation:

$$R_G = \frac{180 \text{ k}\Omega}{G - 1} \quad (2)$$

Similarly The gain equation of INA350CDS can be given by [Equation 3](#):

$$G = 1 + \frac{290 \text{ k}\Omega}{R_G} \quad (3)$$

The value of the internal gain resistor R_G for INA350CDS can then be derived from the gain equation:

$$R_G = \frac{290 \text{ k}\Omega}{G - 1} \quad (4)$$

[Table 8-1](#) provides how to choose different gain options across INA350ABS and INA350CDS. The 60-k Ω , 90-k Ω , and 145-k Ω resistors mentioned are all typical values of the on-chip resistors.

Table 8-1. Gain Selection Table

DEVICE	GAIN SELECT (GS)	SELECTED GAIN
INA350ABS	High or No Connect	20
	Low	10
INA350CDS	High or No Connect	50
	Low	30

8.3.1.1 Gain Error and Drift

Gain error in INA350 is limited by the mismatch of the integrated precision resistors and it is specified based on characterization results. Gain error of maximum 0.5% can be expected for the gains of 10 and 0.6% for the gains of 20, 30 and 50. Gain drift in INA350 is limited by the slight mismatch of the temperature coefficient of the integrated resistors. Since these integrated resistors are precision matched with low temperature coefficient resistors to begin with, the overall gain drift would be much better in comparison to discrete implementation of the instrumentation amplifiers built using external resistors.

8.3.2 Input Common-Mode Voltage Range

INA350 has two gain stages, the first stage has a common-mode gain of 1 and a differential gain set by the GS pin. The second stage is configured in a difference-amplifier configuration with differential gain of 1 and ideally rejects all of the input common mode completely. The second stage also provides a gain of 1 from REF pin to set the output common-mode voltage.

The linear input voltage range of the INA350, even for a rail-to-rail first stage is dictated by the signal swing at output of the first stage as well as the input common-mode voltage range output swing of the second stage. It is imperative that the INA350 stays linear for a particular combination of gain, reference, and input common-mode voltage for a chosen input differential. Input common-mode voltage (V_{CM}) vs output voltage graphs (V_{OUT}) in this section show a particular reference voltage and gain configuration to outline the linear performance region of INA350. A good common-mode rejection can be expected when operating with in the limits of the V_{CM} vs V_{OUT} graph. Note, that the INA350 linear input voltage cannot be close to or extend beyond the supply rails as the output of the first stage will be driven into saturation.

The common-mode range for the most common operating conditions is outlined as follows. Figure 8-1 shows the region of operation where a minimum of 85 dB can be achieved. Figure 8-2 has much wider region of operation with a lower minimum CMRR of 62 dB, because the input signal crosses over the transition region of the input pairs to achieve rail-to-rail operation. The common-mode range for other operating conditions is best calculated with the INA V_{CM} vs V_{OUT} tool located under the *Amplifiers and Comparators* section of the [Analog Engineer's Calculator](#) on ti.com. INA350-HCM model can be specifically used for applications requiring high CMRR and corresponds to performance shown in Figure 8-1. INA350xxS model can be used for applications where the input common mode can be expected to vary rail-to-rail and it corresponds to performance shown in Figure 8-2 where CMRR drops to 62-dB minimum.

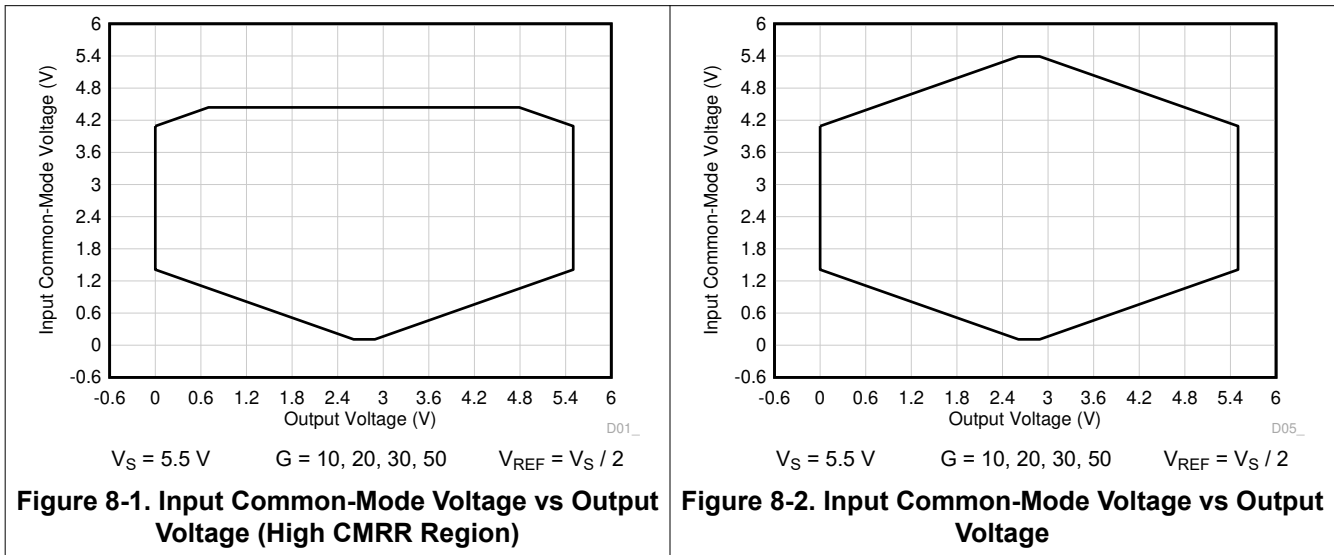

8.3.3 EMI Rejection

The INA350 uses integrated electromagnetic interference (EMI) filtering to reduce the effects of EMI from sources such as wireless communications and densely-populated boards with a mix of analog signal chain and digital components. EMI immunity can be improved with circuit design techniques; the INA350 benefits from these design improvements. Texas Instruments has developed the ability to accurately measure and quantify the immunity of an operational amplifier over a broad frequency spectrum extending from 10 MHz to 6 GHz. Figure 8-3 shows the results of this testing on the INA350. Table 8-2 provides the EMIRR IN+ values for the INA350 at particular frequencies commonly encountered in real-world applications. The [EMI Rejection Ratio of Operational Amplifiers](#) application report contains detailed information on the topic of EMIRR performance as it relates to op amps and is available for download from www.ti.com.

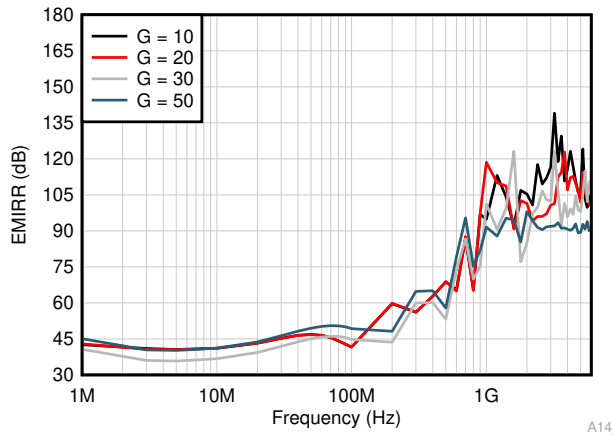

Figure 8-3. EMIRR Testing

Table 8-2. INA350 EMIRR IN+ for Frequencies of Interest

FREQUENCY	APPLICATION OR ALLOCATION	EMIRR IN+
400 MHz	Mobile radio, mobile satellite, space operation, weather, radar, ultra-high frequency (UHF) applications	60 dB
900 MHz	Global system for mobile communications (GSM) applications, radio communication, navigation, GPS (to 1.6 GHz), GSM, aeronautical mobile, UHF applications	92 dB
1.8 GHz	GSM applications, mobile personal communications, broadband, satellite, L-band (1 GHz to 2 GHz)	90 dB
2.4 GHz	802.11b, 802.11g, 802.11n, Bluetooth®, mobile personal communications, industrial, scientific and medical (ISM) radio band, amateur radio and satellite, S-band (2 GHz to 4 GHz)	95 dB
3.6 GHz	Radiolocation, aero communication and navigation, satellite, mobile, S-band	108 dB
5 GHz	802.11a, 802.11n, aero communication and navigation, mobile communication, space and satellite operation, C-band (4 GHz to 8 GHz)	105 dB

8.3.4 Typical Specifications and Distributions

Designers often have questions about a typical specification of an amplifier in order to design a more robust circuit. Due to natural variation in process technology and manufacturing procedures, every specification of an amplifier will exhibit some amount of deviation from the ideal value, like an amplifier's input offset voltage. These deviations often follow *Gaussian (bell curve)*, or *normal* distributions, and circuit designers can leverage this information to guard band their system, even when there is not a minimum or maximum specification in the [Electrical Characteristics](#) table.

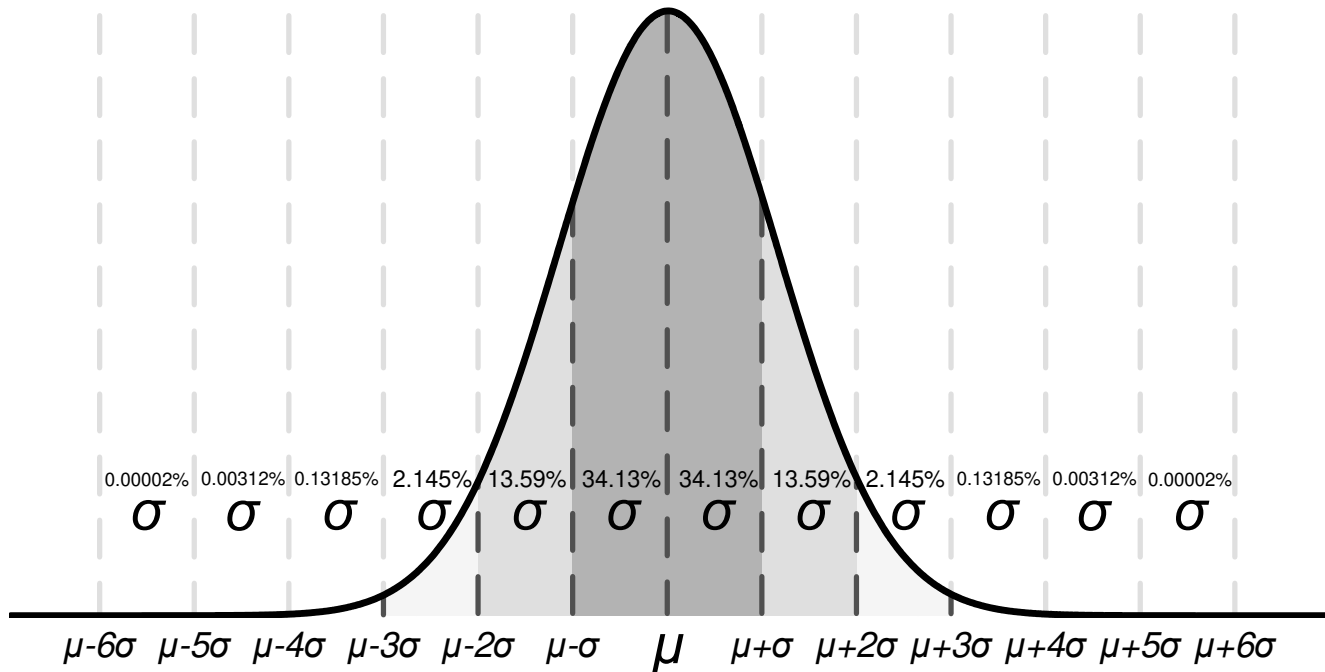

Figure 8-4. Ideal Gaussian Distribution

Figure 8-4 shows an example distribution, where μ , or *mu*, is the mean of the distribution, and where σ , or *sigma*, is the standard deviation of a system. For a specification that exhibits this kind of distribution, approximately two-thirds (68.26%) of all units can be expected to have a value within one standard deviation, or one sigma, of the mean (from $\mu - \sigma$ to $\mu + \sigma$).

Depending on the specification, values listed in the *typical* column of the [Electrical Characteristics](#) table are represented in different ways. As a general rule, if a specification naturally has a nonzero mean (for example, like gain bandwidth), then the typical value is equal to the mean (μ). However, if a specification naturally has a mean near zero (like input offset voltage), then the typical value is equal to the mean plus one standard deviation ($\mu + \sigma$) in order to most accurately represent the typical value.

You can use this chart to calculate approximate probability of a specification in a unit; for example, the INA350 typical input voltage offset is 200 μV , so 68.2% of all INA350 devices are expected to have an offset from $-200 \mu\text{V}$ to $+200 \mu\text{V}$. At 4 σ ($\pm 800 \mu\text{V}$), 99.9937% of the distribution has an offset voltage less than $\pm 800 \mu\text{V}$, which means 0.0063% of the population is outside of these limits, which corresponds to about 1 in 15,873 units.

Specifications with a value in the minimum or maximum column are assured by TI, and units outside these limits will be removed from production material. For example, the INA350 family has a maximum offset voltage of 1.2 mV at 25°C, and even though this corresponds to 6 σ (≈ 1 in 500 million units), which is extremely unlikely, TI assures that any unit with larger offset than 1.2 mV will be removed from production material.

For specifications with no value in the minimum or maximum column, consider selecting a sigma value of sufficient guard band for your application, and design worst-case conditions using this value. As stated earlier, the 6- σ value corresponds to about 1 in 500 million units, which is an extremely unlikely chance, and could be an option as a wide guard band to design a system around. In this case, the INA350 family does not have a maximum or minimum for offset voltage drift, but based on [Figure 7-2](#) and the typical value of 0.6 $\mu\text{V}/^\circ\text{C}$ in the [Electrical Characteristics](#) table, it can be calculated from that the 6- σ value for offset voltage drift is about 2 $\mu\text{V}/^\circ\text{C}$. When designing for worst-case system conditions, this value can be used to estimate the worst possible offset drift without having an actual minimum or maximum value.

However, process variation and adjustments over time can shift typical means and standard deviations, and unless there is a value in the minimum or maximum specification column, TI cannot assure the performance of a device. This information should be used only to estimate the performance of a device.

8.3.5 Electrical Overstress

Designers often ask questions about the capability of an operational amplifier to withstand electrical overstress. These questions tend to focus on the device inputs, but can involve the supply voltage pins or even the output pin. Each of these different pin functions have electrical stress limits determined by the voltage breakdown characteristics of the particular semiconductor fabrication process and specific circuits connected to the pin. Additionally, internal electrostatic discharge (ESD) protection is built into these circuits to protect them from accidental ESD events both before and during product assembly.

Having a good understanding of this basic ESD circuitry and its relevance to an electrical overstress event is helpful. Figure 8-5 shows the ESD circuits contained in the INA350 devices. The ESD protection circuitry involves several current-steering diodes connected from the input and output pins and routed back to the internal power supply lines, where they meet at an absorption device internal to the operational amplifier. This protection circuitry is intended to remain inactive during normal circuit operation.

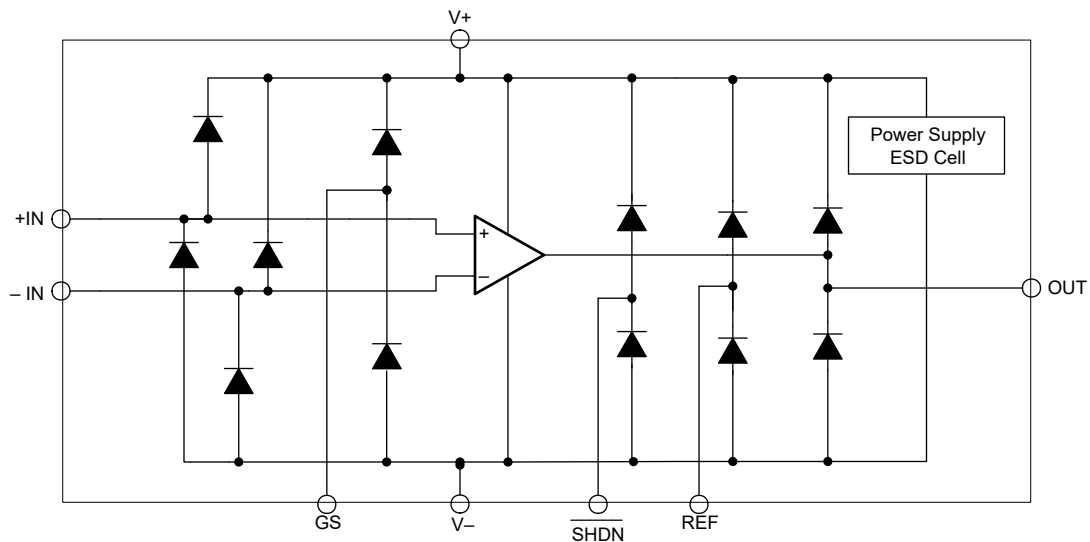

Figure 8-5. Equivalent Internal ESD Circuitry

8.4 Device Functional Modes

The INA350 has a shutdown or disable mode to enable power savings in battery powered applications. The shutdown mode has a maximum quiescent current of just 1.25 μA , which is 100 times lower from the quiescent current when the amplifier is powered-on or enabled.

INA350 enters disable mode when the $\overline{\text{SHDN}}$ pin is tied low. INA350 is enabled when the $\overline{\text{SHDN}}$ pin is tied high. A no connection or a floating $\overline{\text{SHDN}}$ pin enables or powers-on the INA as the pin has an internal pull up current to default to the same configuration as $\overline{\text{SHDN}}$ pin tied high.

9 Application and Implementation

Note

Information in the following applications sections is not part of the TI component specification, and TI does not warrant its accuracy or completeness. TI's customers are responsible for determining suitability of components for their purposes, as well as validating and testing their design implementation to confirm system functionality.

9.1 Application Information

9.1.1 Reference Pin

The output voltage of the INA350 is developed with respect to the voltage on the reference pin (REF). Often in dual-supply operation, REF pin connects to the low-impedance system ground. In single-supply operation, offsetting the output signal to a precise mid-supply level is useful (for example, 2.75-V in a 5.5-V supply environment). To accomplish this level shift, a voltage source must be connected to the REF pin to level-shift the output so that the INA350 can drive a single-supply ADC.

The voltage source applied to the reference pin must have a low output impedance. Any resistance at the reference pin (R_{REF}) is in series with the internal 60-k Ω resistor.

The parasitic resistance at the reference pin (R_{REF}) creates an imbalance in the four resistors of the internal difference amplifier that results in a degraded common-mode rejection ratio (CMRR). For the best performance, keep the source impedance to the REF pin (R_{REF}) less than 5 Ω .

Voltage reference devices are an excellent option for providing a low-impedance voltage source for the reference pin. However, if a resistor voltage divider generates a reference voltage, buffer the divider by an op amp, as shown in Figure 9-1, to avoid CMRR degradation.

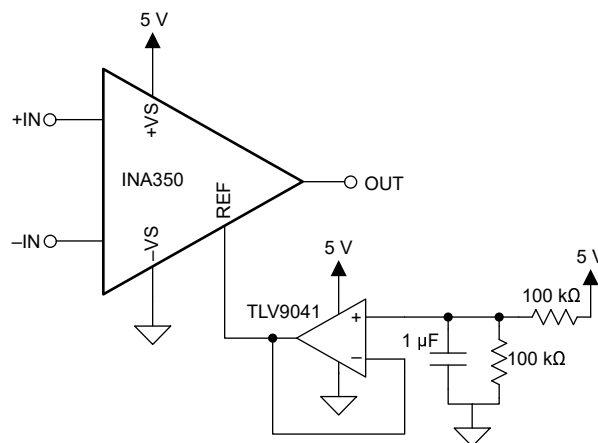
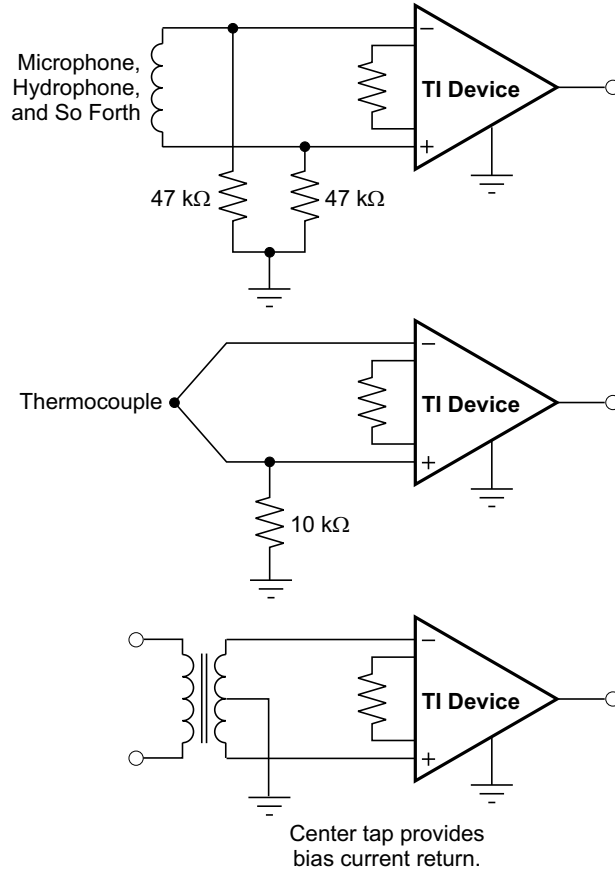

Figure 9-1. Use an Op Amp to Buffer Reference Voltages

9.1.2 Input Bias Current Return Path

The input impedance of the INA350 is extremely high, but a path must be provided for the input bias current of both inputs. This input bias current is typically a few pico amps but at high temperature this can be a few nano amps. High input impedance means that the input bias current changes little with varying input voltage.

For proper operation, input circuitry must provide a path for this input bias current. Figure 9-2 shows various provisions for an input bias current path. Without a bias current path, the inputs float to a potential that exceeds the common-mode range of the INA350, and the input amplifiers saturate. If the differential source resistance is low, the bias current return path connects to one input (as shown in the thermocouple example in Figure 9-2). With a higher source impedance, use two equal resistors to provide a balanced input, with the possible advantages of a lower input offset voltage as a result of bias current, and better high-frequency common-mode rejection.



Copyright © 2017, Texas Instruments Incorporated

Figure 9-2. Providing an Input Common-Mode Current Path

9.2 Typical Applications

9.2.1 Resistive-Bridge Pressure Sensor

The INA350 is an integrated instrumentation amplifier that measures small differential voltages while simultaneously rejecting larger common-mode voltages. The device offers a low power consumption of 100 μA (typical) and has a smaller form factor.

The device is designed for portable applications where sensors measure physical parameters, such as changes in fluid, pressure, temperature, or humidity. An example of a pressure sensor used in the medical sector is in portable infusion pumps or dialysis machines.

The pressure sensor is made of a piezo-resistive element that can be derived as a classical 4-resistor Wheatstone bridge.

Occlusion (infusion of fluids, medication, or nutrients) happens only in one direction, and therefore can only cause the resistive element (R) to expand. This expansion causes a change in voltage on one leg of the Wheatstone bridge, which induces a differential voltage V_{DIFF} .

Figure 9-3 shows an example circuit for an occlusion pressure sensor application, as required in infusion pumps. When blockage (occlusion) occurs against a set-point value, the tubing depresses, thus causing the piezo-resistive element to expand (Node AD: $R + \Delta R$). The signal chain connected to the bridge downstream processes the pressure change and can trigger an alarm.

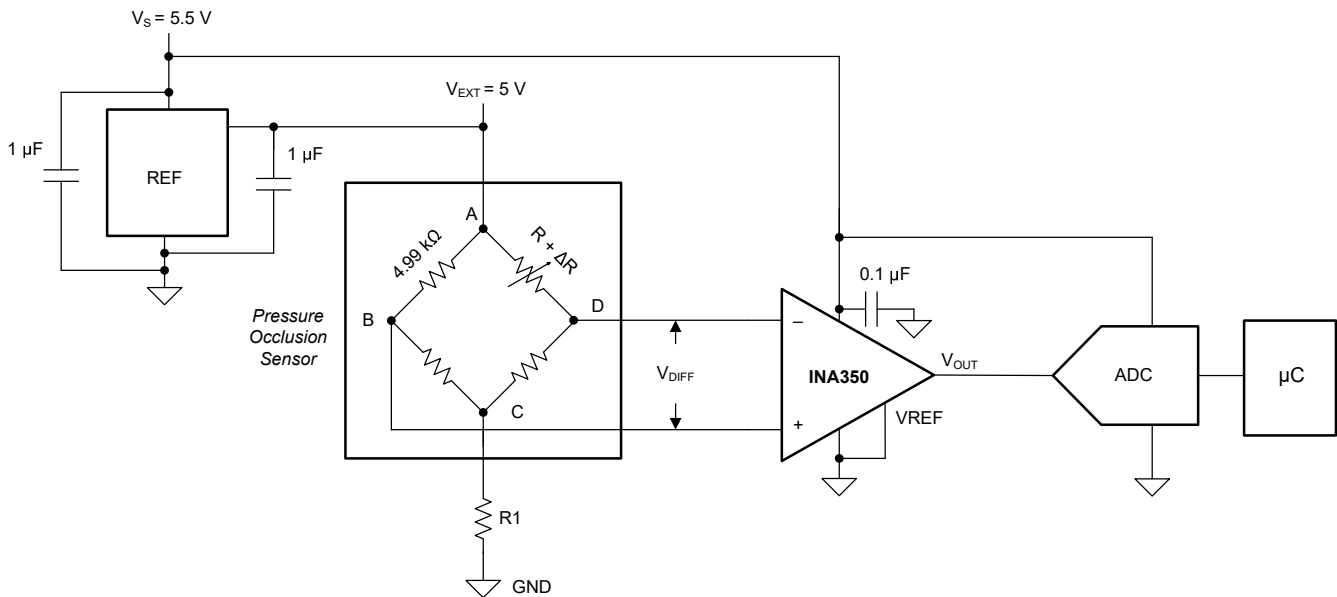

Figure 9-3. Resistive-Bridge Pressure Sensor

Low-tolerance bridge resistors must be used to minimize the offset and gain errors.

Given that there is only a positive differential voltage applied, this circuit is laid out in single-ended supply mode. The excitation voltage, V_{EXT} , to the bridge must be precise and stable; otherwise, measurement errors can be introduced.

9.2.1.1 Design Requirements

For this application, the design requirements are as provided in [Table 9-1](#).

Table 9-1. Design Requirements

DESCRIPTION	VALUE
Single supply voltage	$V_S = 5.5\text{ V}$
Excitation voltage	$V_{EXT} = 5.0\text{ V}$
Occlusion pressure range	$P = 1\text{ psi to }12\text{ psi, increments of }P = 0.5\text{ psi}$
Occlusion pressure sensitivity	$S = 2 \pm 0.5\text{ (25\%)}\text{ mV/V/psi}$
Occlusion pressure impedance (R)	$R = 4.99\text{ k}\Omega \pm 50\ \Omega\text{ (0.1\%)}$
Total pressure sampling rate	$S_r = 20\text{ Hz}$
Full-scale range of ADC	$V_{ADC(fs)} = V_{OUT} = 3.0\text{ V}$

9.2.1.2 Detailed Design Procedure

This section provides basic calculations to lay out the instrumentation amplifier with respect to the given design requirements.

One of the key considerations in resistive-bridge sensors is the common-mode voltage, V_{CM} . If the bridge is balanced (no pressure, thus no voltage change), $V_{CM(zero)}$ is half of the bridge excitation (V_{EXT}). In this example $V_{CM(zero)}$ is 2.5 V. For the maximum pressure of 12 psi, the bridge common-mode voltage, $V_{CM(MAX)}$, is calculated by:

$$V_{CM(MAX)} = \frac{V_{DIFF}}{2} + V_{CM(zero)} \quad (5)$$

where

$$V_{DIFF} = S_{MAX} \times V_{EXT} \times P_{MAX} = 2.5 \frac{\text{mV}}{\text{V} \times \text{psi}} \times 5\text{ V} \times 12\text{ psi} = 150\text{ mV} \quad (6)$$

Thus, the maximum common-mode voltage applied results in:

$$V_{CM(MAX)} = \frac{150\text{ mV}}{2} + 2.5\text{ V} = 2.575\text{ V} \quad (7)$$

Similarly, the minimum common-mode voltage can be calculated as,

$$V_{CM(MIN)} = \frac{-150\text{ mV}}{2} + 2.5\text{ V} = 2.425\text{ V} \quad (8)$$

The next step is to calculate the gain required for the given maximum sensor output voltage span, V_{DIFF} , in respect to the required V_{OUT} , which is the full-scale range of the ADC.

The following equation calculates the gain value using the maximum input voltage and the required output voltage:

$$G = \frac{V_{OUT}}{V_{DIFF(MAX)}} = \frac{3.0\text{ V}}{150\text{ mV}} = 20\text{ V/V} \quad (9)$$

Considering, INA350 is a selectable gain INA with gain options of 10, 20, 30, 50, the INA350ABS with GS tied high enables $G = 20$ ensuring the maximum output signal swing for the ADC.

Next, let us make sure that the INA350 can operate within this range checking the *Input Common-Mode Voltage vs Output Voltage* curves in the [Typical Characteristics](#) section. The relevant figure is also in this section for convenience. Looking at [Figure 9-4](#), we can confirm that a output signal swing of 3 V is supported for the input signal swing between 2.425 V and 2.575 V, thus making sure of the linear operation.

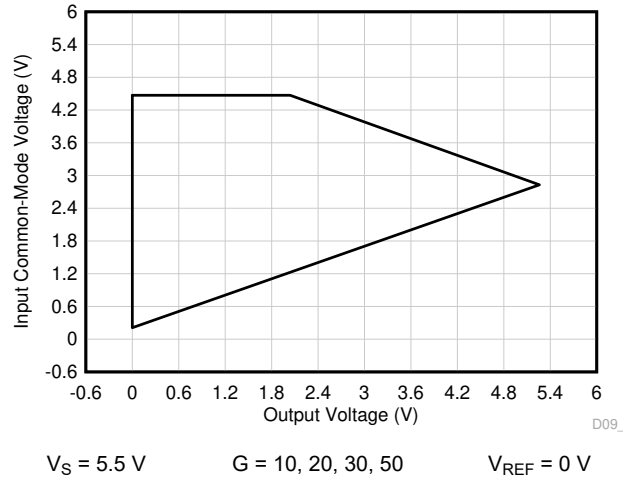

Figure 9-4. Input Common-Mode Voltage vs Output Voltage (High CMRR Region)

Additional series resistor in the Wheatstone bridge string (R1) may or may not be required. This is decided based on the intended output voltage swing for a particular combination of supply voltage, reference voltage and the selected gain for an input common mode voltage range. R1 helps adjust the input common-mode voltage range, and thus can help accommodate the intended output voltage swing. In this particular example, it are not required and can be shorted out.

9.2.1.3 Application Curves

The following typical characteristic curve is for the circuit in [Figure 9-3](#).

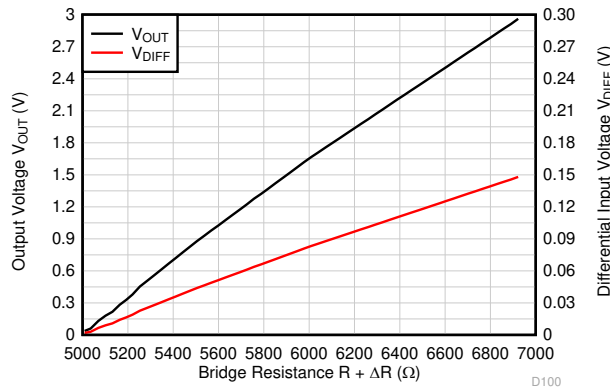

Figure 9-5. Input Differential Voltage, Output Voltage vs Bridge Resistance

9.3 Power Supply Recommendations

The nominal performance of the INA350 is specified with a supply voltage of $\pm 2.75\text{ V}$ and midsupply reference voltage. The device also operates using power supplies from $\pm 0.85\text{ V}$ (1.7 V) to $\pm 2.75\text{ V}$ (5.5 V) and non-midsupply reference voltages with excellent performance. Parameters can vary significantly with operating voltage and reference voltage.

9.4 Layout

9.4.1 Layout Guidelines

Attention to good layout practices is always recommended. For best operational performance of the device, use the following PCB layout practices:

- Make sure that both input paths are well-matched for source impedance and capacitance to avoid converting common-mode signals into differential signals.
- Use bypass capacitors to reduce the coupled noise by providing low-impedance power sources local to the analog circuitry.
 - Connect low-ESR, 0.1- μ F ceramic bypass capacitors between each supply pin and ground, placed as close to the device as possible. A single bypass capacitor from V+ to ground is applicable for single-supply applications.
- Route the input traces as far away from the supply or output traces as possible to reduce parasitic coupling. If these traces cannot be kept separate, crossing the sensitive trace perpendicular is much better than crossing in parallel with the noisy trace.
- Place the external components as close to the device as possible.
- Keep the traces as short as possible.

9.4.2 Layout Example

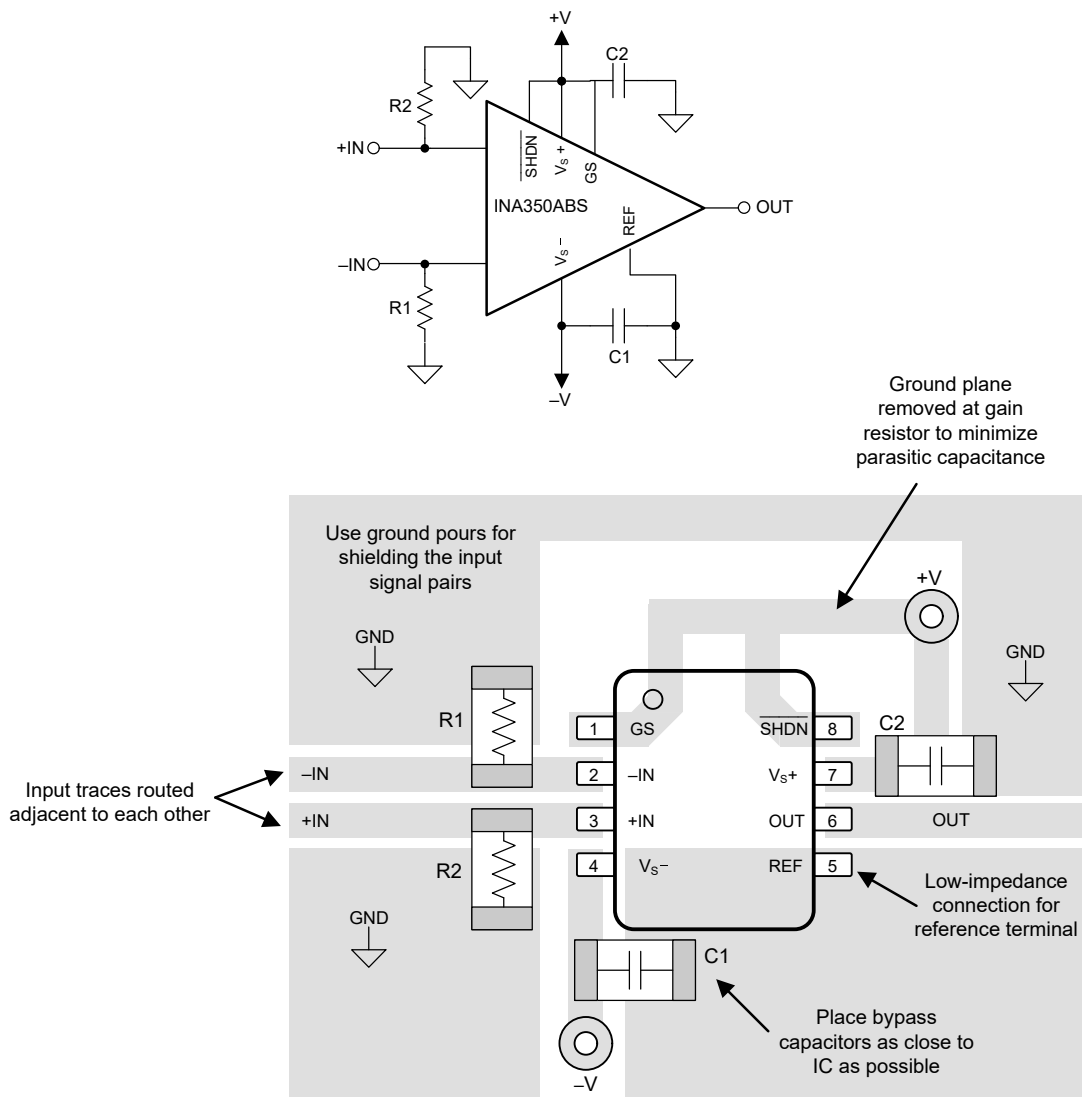

Figure 9-6. Example Schematic and Associated PCB Layout

10 Device and Documentation Support

10.1 Device Support

10.1.1 Development Support

- [SPICE-based analog simulation program — TINA-TI software folder](#)
- [Analog Engineers Calculator](#)

10.1.1.1 PSpice® for TI

PSpice® for TI is a design and simulation environment that helps evaluate performance of analog circuits. Create subsystem designs and prototype solutions before committing to layout and fabrication, reducing development cost and time to market.

10.2 Documentation Support

10.2.1 Related Documentation

For related documentation see the following:

- Texas Instruments, [EMI Rejection Ratio of Operational Amplifiers application report](#)

10.3 Receiving Notification of Documentation Updates

To receive notification of documentation updates, navigate to the device product folder on [ti.com](#). Click on *Subscribe to updates* to register and receive a weekly digest of any product information that has changed. For change details, review the revision history included in any revised document.

10.4 Support Resources

[TI E2E™ support forums](#) are an engineer's go-to source for fast, verified answers and design help — straight from the experts. Search existing answers or ask your own question to get the quick design help you need.

Linked content is provided "AS IS" by the respective contributors. They do not constitute TI specifications and do not necessarily reflect TI's views; see TI's [Terms of Use](#).

10.5 Trademarks

TI E2E™ is a trademark of Texas Instruments.

Bluetooth® is a registered trademark of Bluetooth SIG, Inc.

PSpice® is a registered trademark of Cadence Design Systems, Inc.

All trademarks are the property of their respective owners.

10.6 Electrostatic Discharge Caution



This integrated circuit can be damaged by ESD. Texas Instruments recommends that all integrated circuits be handled with appropriate precautions. Failure to observe proper handling and installation procedures can cause damage.

ESD damage can range from subtle performance degradation to complete device failure. Precision integrated circuits may be more susceptible to damage because very small parametric changes could cause the device not to meet its published specifications.

10.7 Glossary

[TI Glossary](#) This glossary lists and explains terms, acronyms, and definitions.

11 Mechanical, Packaging, and Orderable Information

The following pages include mechanical, packaging, and orderable information. This information is the most current data available for the designated devices. This data is subject to change without notice and revision of this document. For browser-based versions of this data sheet, refer to the left-hand navigation.

PACKAGING INFORMATION

Orderable part number	Status (1)	Material type (2)	Package Pins	Package qty Carrier	RoHS (3)	Lead finish/ Ball material (4)	MSL rating/ Peak reflow (5)	Op temp (°C)	Part marking (6)
INA350ABSIDDFR	Active	Production	SOT-23-THIN (DDF) 8	3000 LARGE T&R	Yes	NIPDAU	Level-1-260C-UNLIM	-40 to 125	IN35A
INA350ABSIDDFR.A	Active	Production	SOT-23-THIN (DDF) 8	3000 LARGE T&R	Yes	NIPDAU	Level-1-260C-UNLIM	-40 to 125	IN35A
INA350ABSIDSGR	Active	Production	WSON (DSG) 8	3000 LARGE T&R	Yes	SN	Level-1-260C-UNLIM	-40 to 125	I35A
INA350ABSIDSGR.A	Active	Production	WSON (DSG) 8	3000 LARGE T&R	Yes	SN	Level-1-260C-UNLIM	-40 to 125	I35A
INA350ABSIRUGR	Active	Production	X2QFN (RUG) 10	3000 LARGE T&R	Yes	NIPDAU	Level-1-260C-UNLIM	-40 to 125	1NC
INA350ABSIRUGR.A	Active	Production	X2QFN (RUG) 10	3000 LARGE T&R	Yes	NIPDAU	Level-1-260C-UNLIM	-40 to 125	1NC
INA350CDSIDDFR	Active	Production	SOT-23-THIN (DDF) 8	3000 LARGE T&R	Yes	NIPDAU	Level-1-260C-UNLIM	-40 to 125	IN35C
INA350CDSIDDFR.A	Active	Production	SOT-23-THIN (DDF) 8	3000 LARGE T&R	Yes	NIPDAU	Level-1-260C-UNLIM	-40 to 125	IN35C
INA350CDSIDSGR	Active	Production	WSON (DSG) 8	3000 LARGE T&R	Yes	SN	Level-1-260C-UNLIM	-40 to 125	I35C
INA350CDSIDSGR.A	Active	Production	WSON (DSG) 8	3000 LARGE T&R	Yes	SN	Level-1-260C-UNLIM	-40 to 125	I35C
INA350CDSIRUGR	Active	Production	X2QFN (RUG) 10	3000 LARGE T&R	Yes	NIPDAU	Level-1-260C-UNLIM	-40 to 125	1ND
INA350CDSIRUGR.A	Active	Production	X2QFN (RUG) 10	3000 LARGE T&R	Yes	NIPDAU	Level-1-260C-UNLIM	-40 to 125	1ND

(1) **Status:** For more details on status, see our [product life cycle](#).

(2) **Material type:** When designated, preproduction parts are prototypes/experimental devices, and are not yet approved or released for full production. Testing and final process, including without limitation quality assurance, reliability performance testing, and/or process qualification, may not yet be complete, and this item is subject to further changes or possible discontinuation. If available for ordering, purchases will be subject to an additional waiver at checkout, and are intended for early internal evaluation purposes only. These items are sold without warranties of any kind.

(3) **RoHS values:** Yes, No, RoHS Exempt. See the [TI RoHS Statement](#) for additional information and value definition.

(4) **Lead finish/Ball material:** Parts may have multiple material finish options. Finish options are separated by a vertical ruled line. Lead finish/Ball material values may wrap to two lines if the finish value exceeds the maximum column width.

(5) **MSL rating/Peak reflow:** The moisture sensitivity level ratings and peak solder (reflow) temperatures. In the event that a part has multiple moisture sensitivity ratings, only the lowest level per JEDEC standards is shown. Refer to the shipping label for the actual reflow temperature that will be used to mount the part to the printed circuit board.

(6) **Part marking:** There may be an additional marking, which relates to the logo, the lot trace code information, or the environmental category of the part.

Multiple part markings will be inside parentheses. Only one part marking contained in parentheses and separated by a "-" will appear on a part. If a line is indented then it is a continuation of the previous line and the two combined represent the entire part marking for that device.

Important Information and Disclaimer: The information provided on this page represents TI's knowledge and belief as of the date that it is provided. TI bases its knowledge and belief on information provided by third parties, and makes no representation or warranty as to the accuracy of such information. Efforts are underway to better integrate information from third parties. TI has taken and continues to take reasonable steps to provide representative and accurate information but may not have conducted destructive testing or chemical analysis on incoming materials and chemicals. TI and TI suppliers consider certain information to be proprietary, and thus CAS numbers and other limited information may not be available for release.

In no event shall TI's liability arising out of such information exceed the total purchase price of the TI part(s) at issue in this document sold by TI to Customer on an annual basis.

TAPE AND REEL INFORMATION

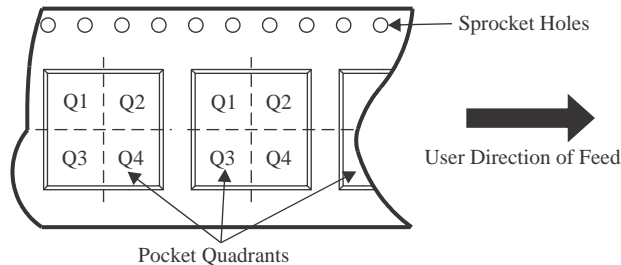
QUADRANT ASSIGNMENTS FOR PIN 1 ORIENTATION IN TAPE

*All dimensions are nominal

Device	Package Type	Package Drawing	Pins	SPQ	Reel Diameter (mm)	Reel Width W1 (mm)	A0 (mm)	B0 (mm)	K0 (mm)	P1 (mm)	W (mm)	Pin1 Quadrant
INA350ABSIDDFR	SOT-23-THIN	DDF	8	3000	180.0	8.4	3.2	3.2	1.4	4.0	8.0	Q3
INA350ABSIDSGR	WSO	DSG	8	3000	180.0	8.4	2.3	2.3	1.15	4.0	8.0	Q2
INA350ABSIRUGR	X2QFN	RUG	10	3000	180.0	8.4	1.75	2.25	0.55	4.0	8.0	Q1
INA350CDSIDDFR	SOT-23-THIN	DDF	8	3000	180.0	8.4	3.2	3.2	1.4	4.0	8.0	Q3
INA350CDSIDSGR	WSO	DSG	8	3000	180.0	8.4	2.3	2.3	1.15	4.0	8.0	Q2
INA350CDSIRUGR	X2QFN	RUG	10	3000	180.0	8.4	1.75	2.25	0.55	4.0	8.0	Q1

TAPE AND REEL BOX DIMENSIONS

*All dimensions are nominal

Device	Package Type	Package Drawing	Pins	SPQ	Length (mm)	Width (mm)	Height (mm)
INA350ABSIDDFR	SOT-23-THIN	DDF	8	3000	210.0	185.0	35.0
INA350ABSIDSGR	WSON	DSG	8	3000	210.0	185.0	35.0
INA350ABSIRUGR	X2QFN	RUG	10	3000	210.0	185.0	35.0
INA350CDSIDDFR	SOT-23-THIN	DDF	8	3000	210.0	185.0	35.0
INA350CDSIDSGR	WSON	DSG	8	3000	210.0	185.0	35.0
INA350CDSIRUGR	X2QFN	RUG	10	3000	210.0	185.0	35.0

GENERIC PACKAGE VIEW

RUG 10

X2QFN - 0.4 mm max height

1.5 x 2, 0.5 mm pitch

PLASTIC QUAD FLATPACK - NO LEAD

This image is a representation of the package family, actual package may vary.
Refer to the product data sheet for package details.

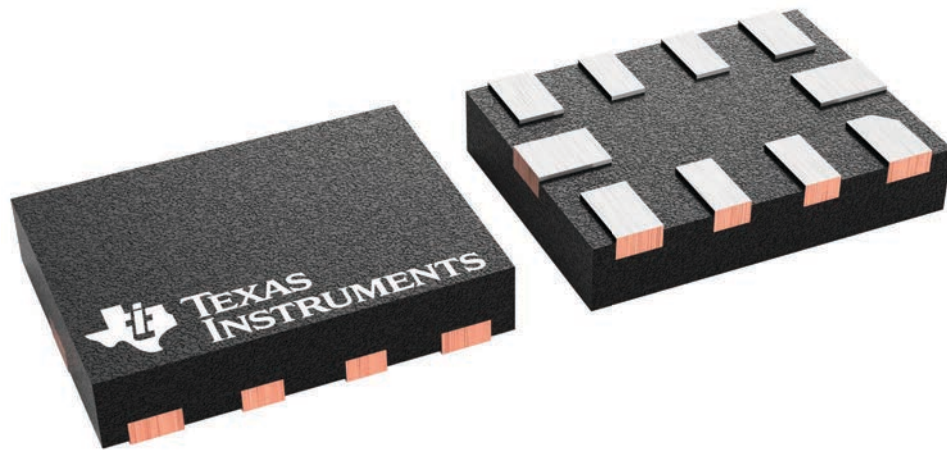

4231768/A

RUG (R-PQFP-N10)

PLASTIC QUAD FLATPACK

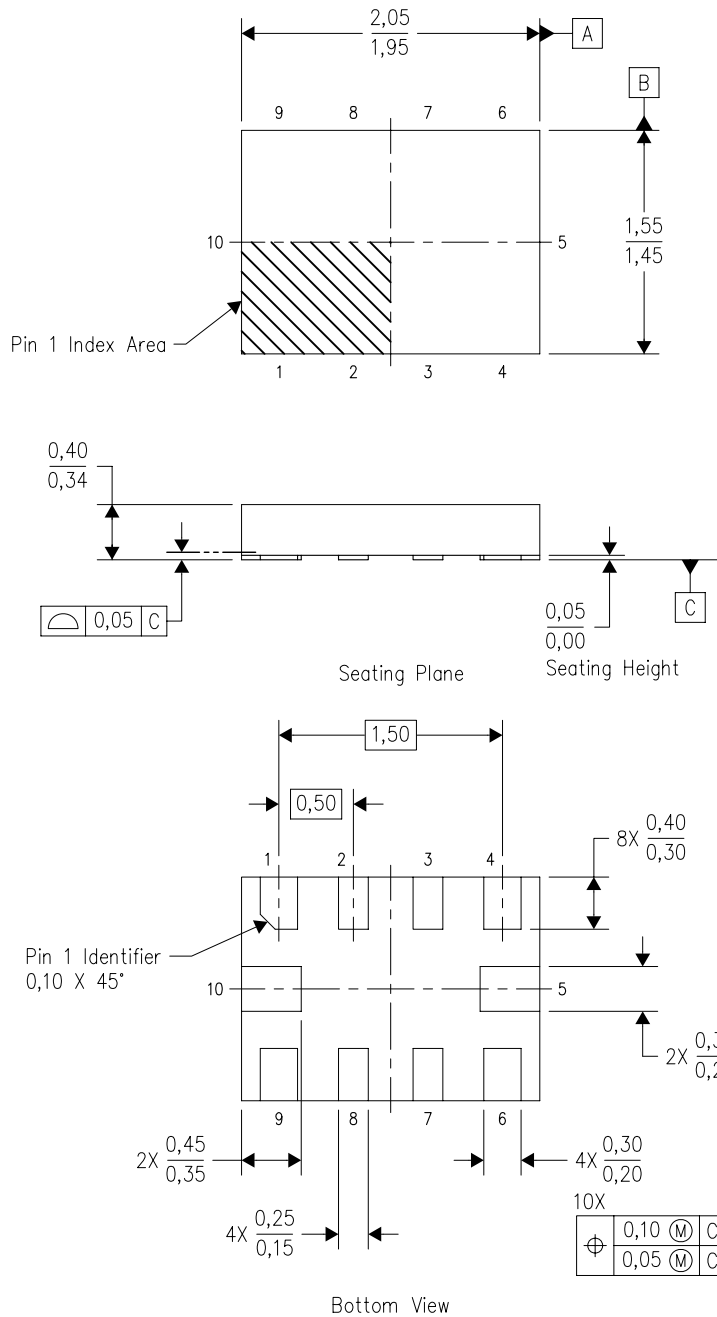

4208528-3/B 04/2008

- NOTES:
- A. All linear dimensions are in millimeters. Dimensioning and tolerancing per ASME Y14.5M-1994.
 - B. This drawing is subject to change without notice.
 - C. QFN (Quad Flatpack No-Lead) package configuration.
 - D. This package complies to JEDEC MO-288 variation X2EFD.

RUG (R-PQFP-N10)

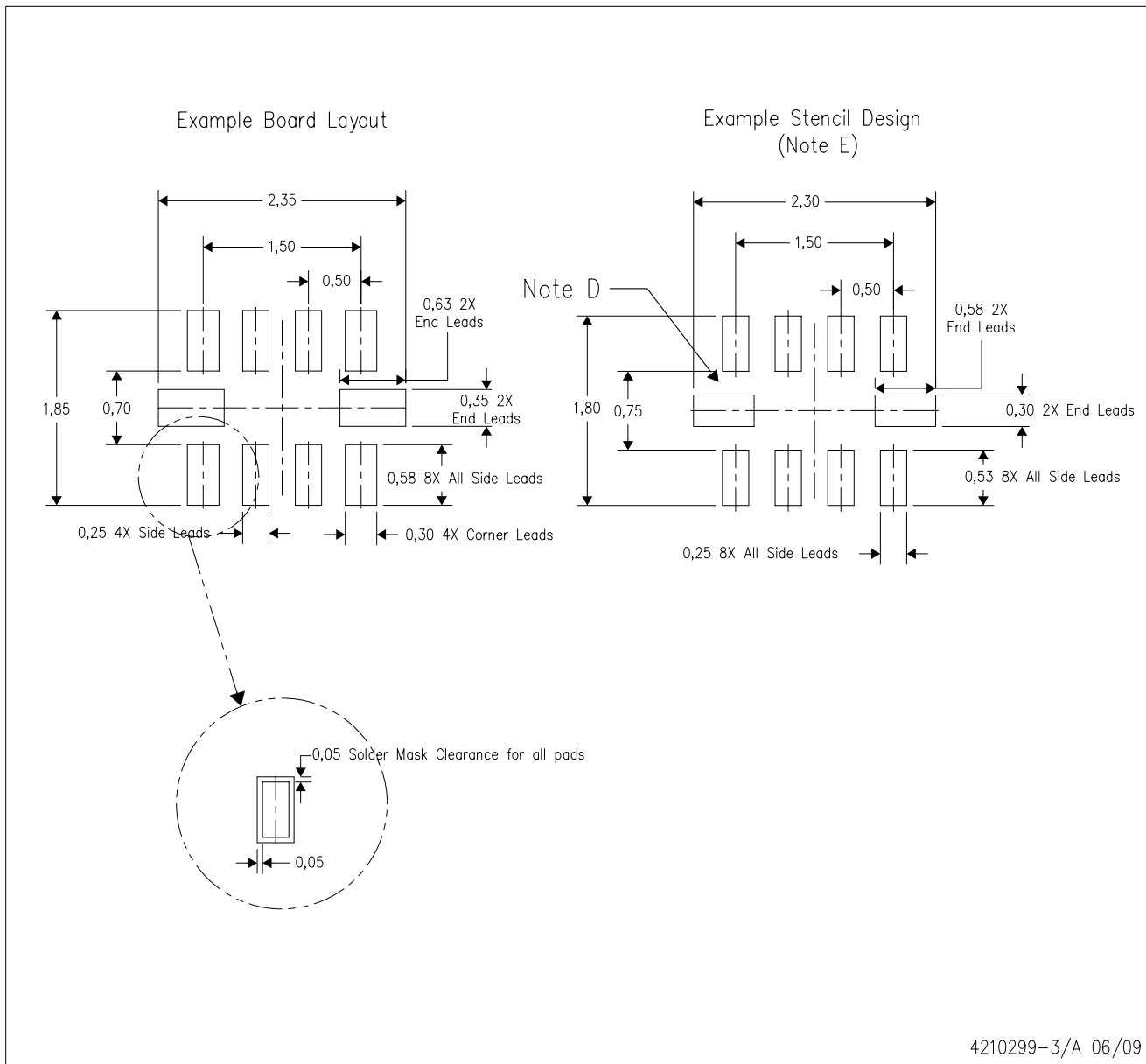

4210299-3/A 06/09

- NOTES:
- A. All linear dimensions are in millimeters.
 - B. This drawing is subject to change without notice.
 - C. Publication IPC-7351 is recommended for alternate designs.
 - D. Customers should contact their board fabrication site for minimum solder mask web tolerances between signal pads.
 - E. Maximum stencil thickness 0,127 mm (5 mils). All linear dimensions are in millimeters.
 - F. Laser cutting apertures with trapezoidal walls and also rounding corners will offer better paste release. Customers should contact their board assembly site for stencil design recommendations. Refer to IPC 7525 for stencil design considerations.
 - G. Side aperture dimensions over-print land for acceptable area ratio > 0.66. Customer may reduce side aperture dimensions if stencil manufacturing process allows for sufficient release at smaller opening.

DDF0008A



PACKAGE OUTLINE

SOT-23-THIN - 1.1 mm max height

PLASTIC SMALL OUTLINE

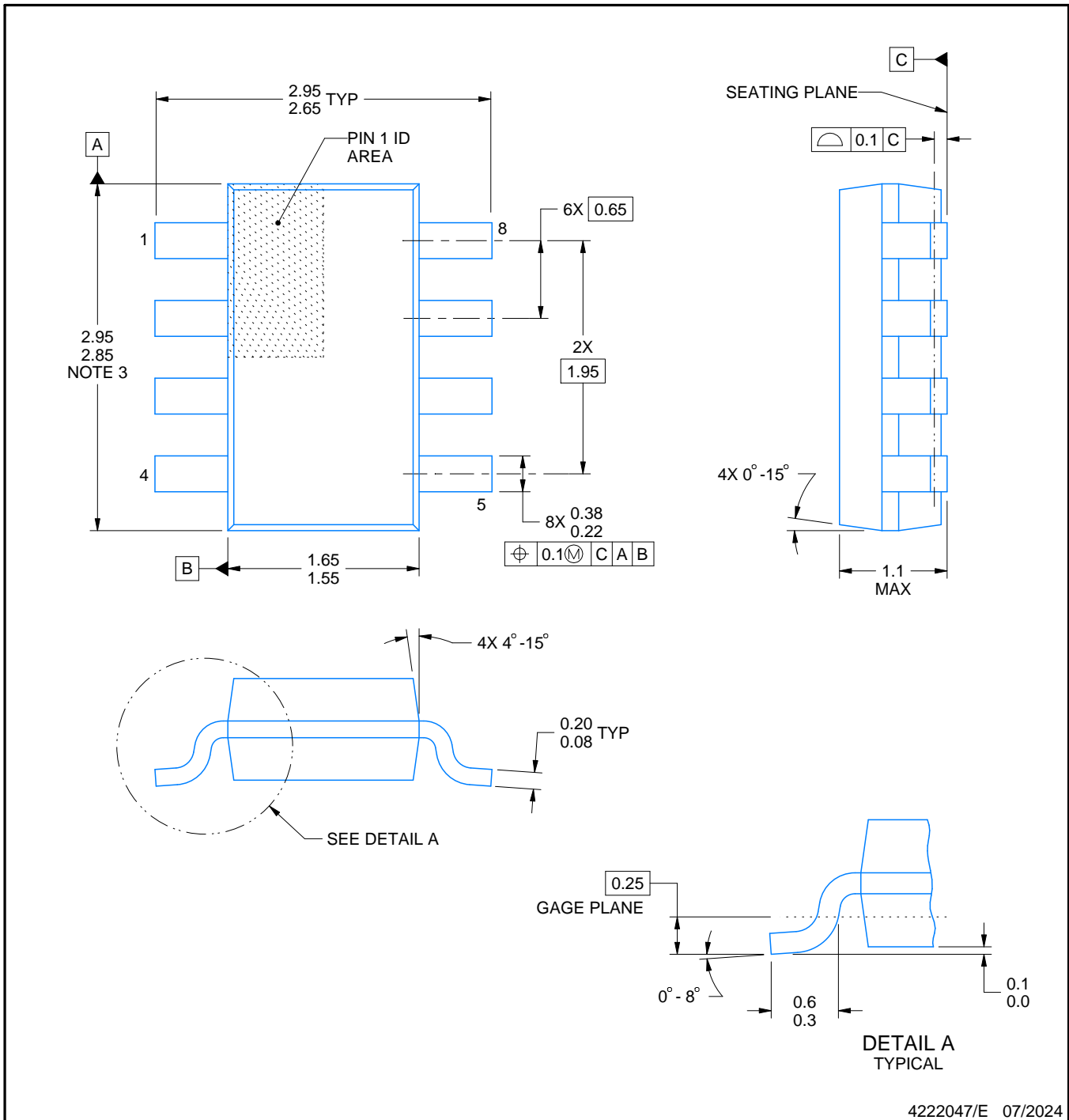

4222047/E 07/2024

NOTES:

- All linear dimensions are in millimeters. Any dimensions in parenthesis are for reference only. Dimensioning and tolerancing per ASME Y14.5M.
- This drawing is subject to change without notice.
- This dimension does not include mold flash, protrusions, or gate burrs. Mold flash, protrusions, or gate burrs shall not exceed 0.15 mm per side.

EXAMPLE BOARD LAYOUT

DDF0008A

SOT-23-THIN - 1.1 mm max height

PLASTIC SMALL OUTLINE

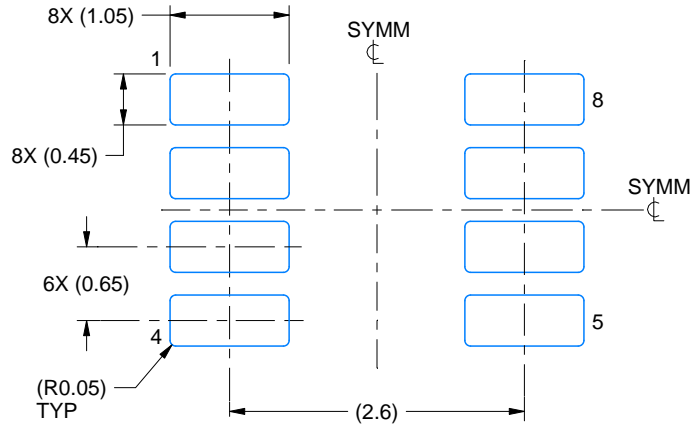

LAND PATTERN EXAMPLE
EXPOSED METAL SHOWN
SCALE:15X

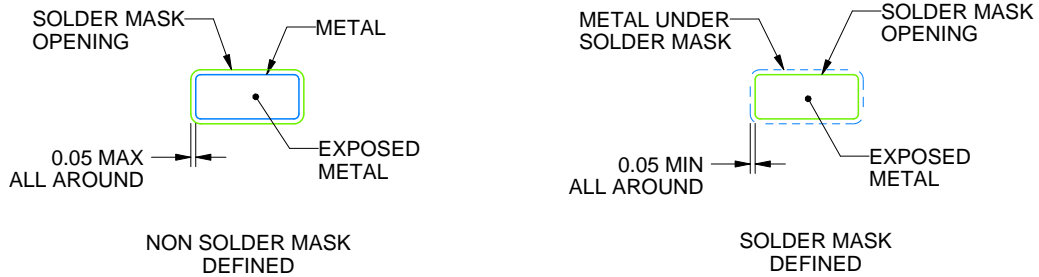

SOLDER MASK DETAILS

4222047/E 07/2024

NOTES: (continued)

- 4. Publication IPC-7351 may have alternate designs.
- 5. Solder mask tolerances between and around signal pads can vary based on board fabrication site.

EXAMPLE STENCIL DESIGN

DDF0008A

SOT-23-THIN - 1.1 mm max height

PLASTIC SMALL OUTLINE



SOLDER PASTE EXAMPLE
BASED ON 0.125 mm THICK STENCIL
SCALE:15X

4222047/E 07/2024

NOTES: (continued)

6. Laser cutting apertures with trapezoidal walls and rounded corners may offer better paste release. IPC-7525 may have alternate design recommendations.
7. Board assembly site may have different recommendations for stencil design.

GENERIC PACKAGE VIEW

DSG 8

WSON - 0.8 mm max height

2 x 2, 0.5 mm pitch

PLASTIC SMALL OUTLINE - NO LEAD

This image is a representation of the package family, actual package may vary.
Refer to the product data sheet for package details.



4224783/A

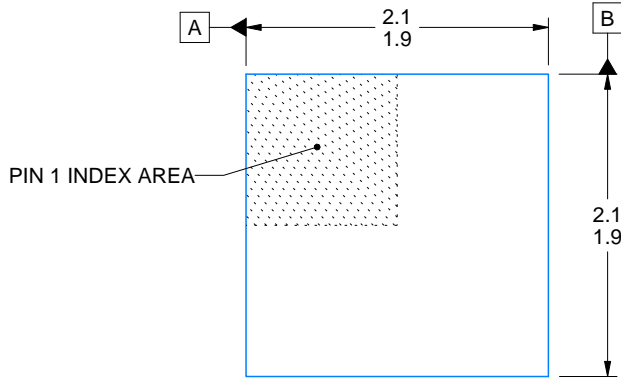
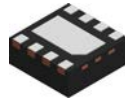

ALTERNATIVE TERMINAL SHAPE TYPICAL

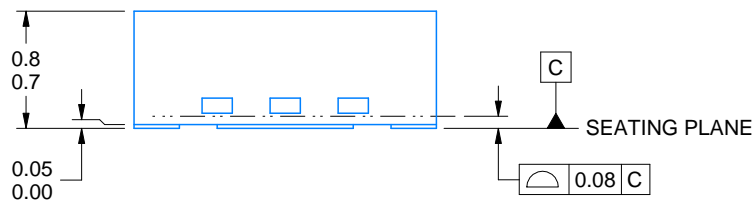

SIDE WALL METAL THICKNESS DIM A	
OPTION 1	OPTION 2
0.1	0.2

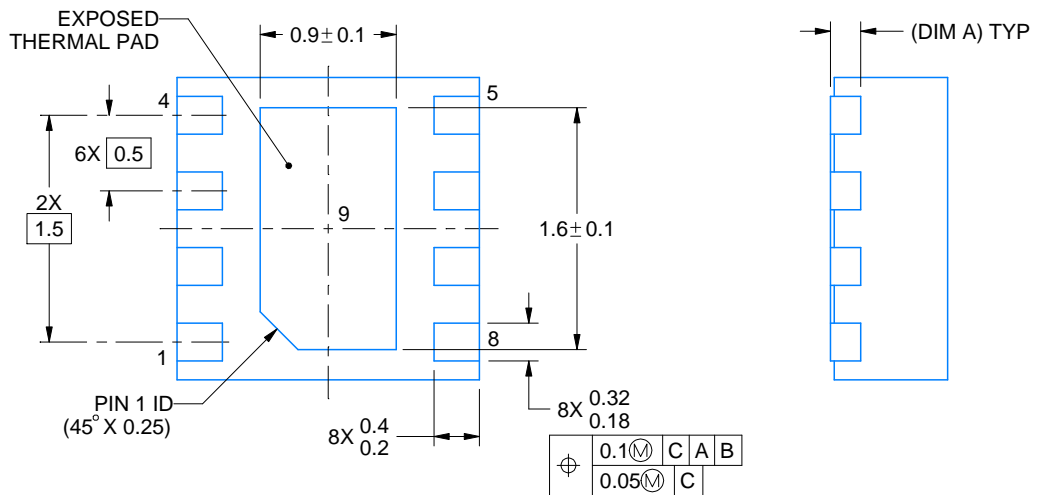

4218900/E 08/2022

NOTES:

1. All linear dimensions are in millimeters. Any dimensions in parenthesis are for reference only. Dimensioning and tolerancing per ASME Y14.5M.
2. This drawing is subject to change without notice.
3. The package thermal pad must be soldered to the printed circuit board for thermal and mechanical performance.

EXAMPLE BOARD LAYOUT

DSG0008A

WSON - 0.8 mm max height

PLASTIC SMALL OUTLINE - NO LEAD



LAND PATTERN EXAMPLE
SCALE:20X



SOLDER MASK DETAILS

4218900/E 08/2022

NOTES: (continued)

4. This package is designed to be soldered to a thermal pad on the board. For more information, see Texas Instruments literature number SLUA271 (www.ti.com/lit/slua271).
5. Vias are optional depending on application, refer to device data sheet. If any vias are implemented, refer to their locations shown on this view. It is recommended that vias under paste be filled, plugged or tented.

EXAMPLE STENCIL DESIGN

DSG0008A

WSON - 0.8 mm max height

PLASTIC SMALL OUTLINE - NO LEAD

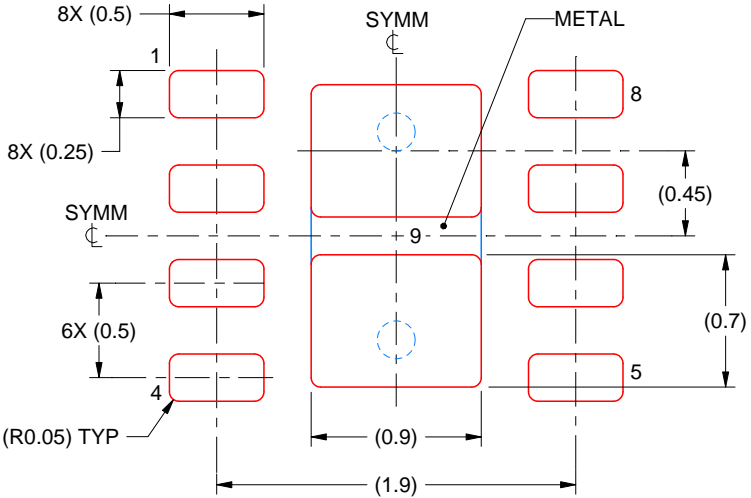

**SOLDER PASTE EXAMPLE
 BASED ON 0.125 mm THICK STENCIL**

EXPOSED PAD 9:
 87% PRINTED SOLDER COVERAGE BY AREA UNDER PACKAGE
 SCALE:25X

4218900/E 08/2022

NOTES: (continued)

6. Laser cutting apertures with trapezoidal walls and rounded corners may offer better paste release. IPC-7525 may have alternate design recommendations.

IMPORTANT NOTICE AND DISCLAIMER

TI PROVIDES TECHNICAL AND RELIABILITY DATA (INCLUDING DATASHEETS), DESIGN RESOURCES (INCLUDING REFERENCE DESIGNS), APPLICATION OR OTHER DESIGN ADVICE, WEB TOOLS, SAFETY INFORMATION, AND OTHER RESOURCES "AS IS" AND WITH ALL FAULTS, AND DISCLAIMS ALL WARRANTIES, EXPRESS AND IMPLIED, INCLUDING WITHOUT LIMITATION ANY IMPLIED WARRANTIES OF MERCHANTABILITY, FITNESS FOR A PARTICULAR PURPOSE OR NON-INFRINGEMENT OF THIRD PARTY INTELLECTUAL PROPERTY RIGHTS.

These resources are intended for skilled developers designing with TI products. You are solely responsible for (1) selecting the appropriate TI products for your application, (2) designing, validating and testing your application, and (3) ensuring your application meets applicable standards, and any other safety, security, regulatory or other requirements.

These resources are subject to change without notice. TI grants you permission to use these resources only for development of an application that uses the TI products described in the resource. Other reproduction and display of these resources is prohibited. No license is granted to any other TI intellectual property right or to any third party intellectual property right. TI disclaims responsibility for, and you fully indemnify TI and its representatives against any claims, damages, costs, losses, and liabilities arising out of your use of these resources.

TI's products are provided subject to [TI's Terms of Sale](#), [TI's General Quality Guidelines](#), or other applicable terms available either on [ti.com](#) or provided in conjunction with such TI products. TI's provision of these resources does not expand or otherwise alter TI's applicable warranties or warranty disclaimers for TI products. Unless TI explicitly designates a product as custom or customer-specified, TI products are standard, catalog, general purpose devices.

TI objects to and rejects any additional or different terms you may propose.

Copyright © 2025, Texas Instruments Incorporated

Last updated 10/2025