

Industry-Standard Dual Operational Amplifiers

1 Features

- Wide supply range of 3V to 36V (B, BA versions)
- Quiescent current: 300µA/ch (B, BA versions)
- Unity-gain bandwidth of 1.2MHz (B, BA versions)
- Common-mode input voltage range includes ground, enabling direct sensing near ground
- 2mV input offset voltage maximum at 25°C (BA version)
- 3mV input offset voltage maximum at 25°C (A, B versions)
- Internal RF and EMI filter (B, BA versions)
- On products compliant to MIL-PRF-38535, all parameters are tested unless otherwise noted. On all other products, production processing does not necessarily include testing of all parameters.

2 Applications

- [Merchant network and server power supply units](#)
- [Multi-function printers](#)
- [Power supplies and mobile chargers](#)
- [Motor control: AC induction, brushed DC, brushless DC, high-voltage, low-voltage, permanent magnet, and stepper motor](#)
- [Desktop PC and motherboard](#)
- [Indoor and outdoor air conditioners](#)
- [Washers, dryers, and refrigerators](#)
- [AC inverters, string inverters, central inverters, and voltage frequency drives](#)
- [Uninterruptible power supplies](#)
- [Electronic point-of-sale systems](#)

3 Description

The LM358B and LM2904B devices are the next-generation versions of the industry-standard operational amplifiers (op amps) LM358 and LM2904, which include two high-voltage (36V) op amps. These

devices provide outstanding value for cost-sensitive applications, with features including low offset (300µV, typical), common-mode input range to ground, and high differential input voltage capability.

The LM358B and LM2904B op amps simplify circuit design with enhanced features such as unity-gain stability, lower offset voltage maximum of 3mV (2mV maximum for LM358BA and LM2904BA), and lower quiescent current of 300µA per amplifier (typical). High ESD (2kV, HBM) and integrated EMI and RF filters enable the LM358B and LM2904B devices to be used in the most rugged, environmentally challenging applications.

The LM358B and LM2904B amplifiers are available in micro-sized packaging, such as the SOT23-8, as well as industry standard packages including SOIC, TSSOP, and VSSOP.

Package Information

PART NUMBER ⁽¹⁾	PACKAGE	PACKAGE SIZE ⁽²⁾
LM358B, LM358BA, LM2904B, LM2904BA, LM358, LM358A, LM2904, LM2904V, LM258, LM258A	D (SOIC, 8)	4.9mm × 6mm
LM358B, LM358BA, LM2904B, LM2904BA, LM358, LM358A, LM2904, LM2490V	PW (TSSOP, 8)	3mm × 6.4mm
LM358B, LM358BA, LM2904B, LM2904BA, LM358, LM358A, LM2904, LM2904V, LM258, LM258A	DGK (VSSOP, 8)	3mm × 4.9mm
LM358B, LM358BA, LM2904B, LM2904BA	DDF (SOT-23, 8)	2.9mm × 2.8mm
LM358, LM2904	PS (SO, 8)	6.2mm × 7.8mm
LM358, LM2904, LM358A, LM258, LM258A	P (PDIP, 8)	9.81mm × 9.43mm
LM158, LM158A	JG (CDIP, 8)	9.6mm × 6.67mm
LM158, LM158A	FK (LCCC, 20)	8.89mm × 8.89mm

Family Comparison

Specification	LM358B LM358BA	LM2904B LM2904BA	LM358 LM358A	LM2904	LM2904V LM2904AV	LM258 LM258A	LM158 LM158A	Units
Supply voltage	3 to 36	3 to 36	3 to 30	3 to 26	3 to 30	3 to 30	3 to 30	V
Offset voltage (max, 25°C)	± 3 ± 2	± 3 ± 2	± 7 ± 3	± 7	± 7 ± 2	± 5 ± 3	± 5 ± 2	mV
Input bias current (typ / max)	10 / 35	10 / 35	20 / 250 15 / 100	20 / 250	20 / 250	20 / 150 15 / 80	20 / 150 15 / 50	nA
Gain bandwidth product	1.2	1.2	0.7	0.7	0.7	0.7	0.7	MHz
Supply current (typ, per channel)	0.3	0.3	0.35	0.35	0.35	0.35	0.35	mA
ESD (HBM)	2000	2000	500	500	500	500	500	V
Operating ambient temperature	-40 to 85	-40 to 125	0 to 70	-40 to 125	-40 to 125	-25 to 85	-55 to 125	°C

(1) For all available packages, see the orderable addendum at the end of the data sheet.

(2) The package size (length × width) is a nominal value and includes pins, where applicable.



Table of Contents

1 Features	1	7 Detailed Description	25
2 Applications	1	7.1 Overview.....	25
3 Description	1	7.2 Functional Block Diagram: LM358B, LM358BA, LM2904B, LM2904BA.....	25
4 Pin Configuration and Functions	3	7.3 Feature Description.....	26
5 Specifications	4	7.4 Device Functional Modes.....	26
5.1 Absolute Maximum Ratings.....	4	8 Application and Implementation	27
5.2 ESD Ratings.....	4	8.1 Application Information.....	27
5.3 Recommended Operating Conditions.....	5	8.2 Typical Application.....	27
5.4 Thermal Information.....	5	8.3 Power Supply Recommendations.....	28
5.5 Electrical Characteristics: LM358B and LM358BA.....	6	8.4 Layout.....	28
5.6 Electrical Characteristics: LM2904B and LM2904BA.....	8	9 Device and Documentation Support	30
5.7 Electrical Characteristics: LM358, LM358A.....	10	9.1 Receiving Notification of Documentation Updates...30	
5.8 Electrical Characteristics: LM2904, LM2904V.....	11	9.2 Support Resources.....	30
5.9 Electrical Characteristics: LM158, LM158A.....	12	9.3 Trademarks.....	30
5.10 Electrical Characteristics: LM258, LM258A.....	14	9.4 Electrostatic Discharge Caution.....	30
5.11 Typical Characteristics: LM358B and LM2904B.....	15	9.5 Glossary.....	30
5.12 Typical Characteristics: LM158, LM158A, LM258, LM258A, LM358, LM358A, LM2904, and LM2904V.....	22	10 Revision History	30
6 Parameter Measurement Information	24	11 Mechanical, Packaging, and Orderable Information	32

4 Pin Configuration and Functions

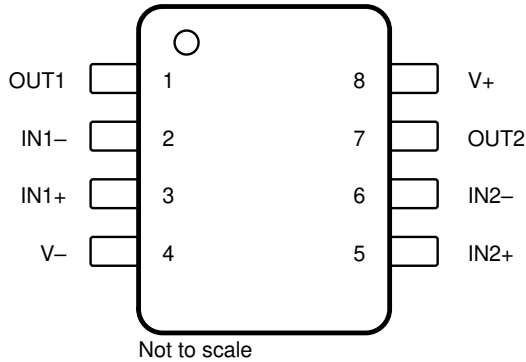

**Figure 4-1. D, DDF, DGK, P, PS, PW, and JG Package
8-Pin SOIC, SOT23-8, VSSOP, PDIP, SO, TSSOP,
and CDIP
Top View**

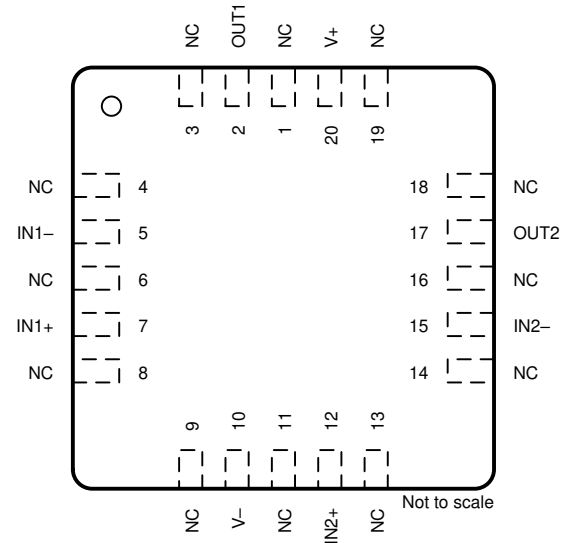

NC - No internal connection

**Figure 4-2. FK Package
20-Pin LCCC
Top View**

Table 4-1. Pin Functions

NAME	PIN		I/O	DESCRIPTION
	LCCC ⁽¹⁾	SOIC, SOT23-8, VSSOP, CDIP, PDIP, SO, TSSOP, CFP ⁽¹⁾		
IN1-	5	2	I	Negative input
IN1+	7	3	I	Positive input
IN2-	15	6	I	Negative input
IN2+	12	5	I	Positive input
OUT1	2	1	O	Output
OUT2	17	7	O	Output
V-	10	4	—	Negative (lowest) supply or ground (for single-supply operation)
NC	1, 3, 4, 6, 8, 9, 11, 13, 14, 16, 18, 19	—	—	No internal connection
V+	20	8	—	Positive (highest) supply

(1) For a listing of which devices are available in what packages, see [Section 3](#).

5 Specifications

5.1 Absolute Maximum Ratings

over operating ambient temperature range (unless otherwise noted)⁽¹⁾

		MIN	MAX	UNIT	
Supply voltage, $V_S = ([V+] - [V-])$	LM358B, LM358BA, LM2904B, LM2904BA		±20 or 40	V	
	LM158, LM258, LM358, LM158A, LM258A, LM358A, LM2904V		±16 or 32		
	LM2904		±13 or 26		
Differential input voltage, V_{ID} ⁽²⁾	LM358B, LM358BA, LM2904B, LM2904BA, LM158, LM258, LM358, LM158A, LM258A, LM358A, LM2904V	-32	32	V	
	LM2904	-26	26		
Input voltage, V_I	Either input	LM358B, LM358BA, LM2904B, LM2904BA	-0.3	40	V
		LM158, LM258, LM358, LM158A, LM258A, LM358A, LM2904V	-0.3	32	
		LM2904	-0.3	26	
Duration of output short circuit (one amplifier) to ground at (or below) $T_A = 25^\circ\text{C}$, $V_S \leq 15\text{ V}$ ⁽³⁾			Unlimited	s	
Operating ambient temperature, T_A	LM158, LM158A	-55	125	°C	
	LM258, LM258A	-25	85		
	LM358B, LM358BA	-40	85		
	LM358, LM358A	0	70		
	LM2904B, LM2904BA, LM2904, LM2904V	-40	125		
Operating virtual-junction temperature, T_J			150	°C	
Storage temperature, T_{stg}		-65	150	°C	

- (1) Stresses beyond those listed under *Absolute Maximum Ratings* may cause permanent damage to the device. These are stress ratings only, and do not imply functional operation of the device at these or any other conditions beyond those indicated under *Recommended Operating Conditions*. Exposure to absolute-maximum-rated conditions for extended periods may affect device reliability.
- (2) Differential voltages are at $IN+$, with respect to $IN-$.
- (3) Short circuits from outputs to V_S can cause excessive heating and eventual destruction.

5.2 ESD Ratings

		VALUE	UNIT
LM358B, LM358BA, LM2904B, AND LM2904BA			
$V_{(ESD)}$ Electrostatic discharge	Human-body model (HBM), per ANSI/ESDA/JEDEC JS-001 ⁽¹⁾	±2000	V
	Charged-device model (CDM), per JEDEC specification JESD22-C101 ⁽²⁾	±1500	
LM158, LM258, LM358, LM158, LM258A, LM358A, LM2904, AND LM2904V			
$V_{(ESD)}$ Electrostatic discharge	Human-body model (HBM), per ANSI/ESDA/JEDEC JS-001 ⁽¹⁾	±500	V
	Charged-device model (CDM), per JEDEC specification JESD22-C101 ⁽²⁾	±1000	

- (1) JEDEC document JEP155 states that 500-V HBM allows safe manufacturing with a standard ESD control process.
- (2) JEDEC document JEP157 states that 250-V CDM allows safe manufacturing with a standard ESD control process.

5.3 Recommended Operating Conditions

over operating ambient temperature range (unless otherwise noted)

		MIN	MAX	UNIT	
V _S	Supply voltage, V _S = ([V+] – [V–])	LM358B, LM358BA, LM2904B, LM2904BA	3	36	V
		LM158, LM258, LM358, LM158A, LM258A, LM358A, LM2904V	3	30	
		LM2904	3	26	
V _{CM}	Common-mode voltage	V–	V+ – 2	V	
T _A	Operating ambient temperature	LM358B, LM358BA	–40	85	°C
		LM2904B, LM2904BA, LM2904, LM2904V	–40	125	
		LM358, LM358A	0	70	
		LM258, LM258A	–20	85	
		LM158, LM158A	–55	125	

5.4 Thermal Information

THERMAL METRIC ⁽¹⁾	LM258, LM258A, LM358, LM358A, LM358B, LM358BA, LM2904, LM2904B, LM2904BA, LM2904V ⁽²⁾						LM158, LM158A		UNIT	
	D (SOIC)	DGK (VSSOP)	P (PDIP)	PS (SO)	PW (TSSOP)	DDF (SOT-23)	FK (LCCC)	JG (CDIP)		
	8 PINS	8 PINS	8 PINS	8 PINS	8 PINS	8PINS	20 PINS	8 PINS		
R _{θJA}	Junction-to-ambient thermal resistance	124.7	181.4	80.9	116.9	171.7	164.3	84.0	112.4	°C/W
R _{θJC(top)}	Junction-to-case (top) thermal resistance	66.9	69.4	70.4	62.5	68.8	98.1	56.9	63.6	°C/W
R _{θJB}	Junction-to-board thermal resistance	67.9	102.9	57.4	68.6	99.2	82.1	57.5	100.3	°C/W
ψ _{JT}	Junction-to-top characterization parameter	19.2	11.8	40	21.9	11.5	11.4	51.7	35.7	°C/W
ψ _{JB}	Junction-to-board characterization parameter	67.2	101.2	56.9	67.6	97.9	81.7	57.1	93.3	°C/W
R _{θJC(bot)}	Junction-to-case (bottom) thermal resistance	—	—	—	—	—	—	10.6	22.3	°C/W

(1) For more information about traditional and new thermal metrics, see [Semiconductor and IC Package Thermal Metrics](#).

(2) For a listing of which devices are available in what packages, see [Section 3](#).

5.5 Electrical Characteristics: LM358B and LM358BA

$V_S = (V+) - (V-) = 5\text{ V} - 36\text{ V} (\pm 2.5\text{ V} - \pm 18\text{ V})$, $T_A = 25^\circ\text{C}$, $V_{CM} = V_{OUT} = V_S / 2$, $R_L = 10\text{k}$ connected to $V_S / 2$ (unless otherwise noted)

PARAMETER		TEST CONDITIONS		MIN	TYP	MAX	UNIT	
OFFSET VOLTAGE								
V_{OS}	Input offset voltage	LM358B			±0.3	±3.0	mV	
			$T_A = -40^\circ\text{C}$ to $+85^\circ\text{C}$			±4		mV
		LM358BA				±2.0		mV
			$T_A = -40^\circ\text{C}$ to $+85^\circ\text{C}$				±2.5	
dV_{OS}/dT	Input offset voltage drift		$T_A = -40^\circ\text{C}$ to $+85^\circ\text{C}^{(1)}$	±3.5		11	$\mu\text{V}/^\circ\text{C}$	
PSRR	Power supply rejection ratio				±2		15	$\mu\text{V}/\text{V}$
	Channel separation, dc	$f = 1\text{ kHz}$ to 20 kHz				±1		$\mu\text{V}/\text{V}$
INPUT VOLTAGE RANGE								
V_{CM}	Common-mode voltage range	$V_S = 3\text{ V}$ to 36 V		(V-)		(V+) - 1.5	V	
		$V_S = 5\text{ V}$ to 36 V	$T_A = -40^\circ\text{C}$ to $+85^\circ\text{C}$	(V-)		(V+) - 2	V	
CMRR	Common-mode rejection ratio	$(V-) \leq V_{CM} \leq (V+) - 1.5\text{ V}$	$V_S = 3\text{ V}$ to 36 V			20	100	$\mu\text{V}/\text{V}$
		$(V-) \leq V_{CM} \leq (V+) - 2.0\text{ V}$	$V_S = 5\text{ V}$ to 36 V	$T_A = -40^\circ\text{C}$ to $+85^\circ\text{C}$			25	316
INPUT BIAS CURRENT								
I_B	Input bias current				-10	-35	nA	
			$T_A = -40^\circ\text{C}$ to $+85^\circ\text{C}^{(1)}$			-50		nA
I_{OS}	Input offset current				0.5	4	nA	
			$T_A = -40^\circ\text{C}$ to $+85^\circ\text{C}^{(1)}$			5		nA
dI_{OS}/dT	Input offset current drift		$T_A = -40^\circ\text{C}$ to $+85^\circ\text{C}$		10		$\text{pA}/^\circ\text{C}$	
NOISE								
E_n	Input voltage noise	$f = 0.1$ to 10 Hz			3		μV_{PP}	
e_n	Input voltage noise density	$f = 1\text{ kHz}$			40		$\text{nV}/\sqrt{\text{Hz}}$	
INPUT IMPEDANCE								
Z_{ID}	Differential				10 0.1		$\text{M}\Omega \text{pF}$	
Z_{IC}	Common-mode				4 1.5		$\text{G}\Omega \text{pF}$	
OPEN-LOOP GAIN								
A_{OL}	Open-loop voltage gain	$V_S = 15\text{ V}$; $V_O = 1\text{ V}$ to 11 V ; $R_L \geq 10\text{ k}\Omega$, connected to (V-)			70	140	V/mV	
				$T_A = -40^\circ\text{C}$ to $+85^\circ\text{C}$	35		V/mV	
FREQUENCY RESPONSE								
GBW	Gain bandwidth product				1.2		MHz	
SR	Slew rate	$G = +1$			0.5		$\text{V}/\mu\text{s}$	
θ_m	Phase margin	$G = +1$, $R_L = 10\text{ k}\Omega$, $C_L = 20\text{ pF}$			56		°	
t_{OR}	Overload recovery time	$V_{IN} \times \text{gain} > V_S$			10		μs	
t_s	Settling time	To 0.1%, $V_S = 5\text{ V}$, 2-V step, $G = +1$, $C_L = 100\text{ pF}$			4		μs	
THD+N	Total harmonic distortion + noise	$G = +1$, $f = 1\text{ kHz}$, $V_O = 3.53\text{ V}_{RMS}$, $V_S = 36\text{ V}$, $R_L = 100\text{k}$, $I_{OUT} \leq \pm 50\text{ }\mu\text{A}$, $\text{BW} = 80\text{ kHz}$			0.001		%	
OUTPUT								
V_O	Voltage output swing from rail	Positive rail (V+)	$I_{OUT} = 50\text{ }\mu\text{A}$		1.35	1.42	V	
			$I_{OUT} = 1\text{ mA}$		1.4	1.48	V	
			$I_{OUT} = 5\text{ mA}^{(1)}$		1.5	1.61	V	
		Negative rail (V-)	$I_{OUT} = 50\text{ }\mu\text{A}$		100	150	mV	
			$I_{OUT} = 1\text{ mA}$		0.75	1	V	
			$V_S = 5\text{ V}$, $R_L \leq 10\text{ k}\Omega$ connected to (V-)	$T_A = -40^\circ\text{C}$ to $+85^\circ\text{C}$	5	20	mV	
I_O	Output current	$V_S = 15\text{ V}$; $V_O = V-$; $V_{ID} = 1\text{ V}$	Source ⁽¹⁾		-20	-30	mA	
			$T_A = -40^\circ\text{C}$ to $+85^\circ\text{C}$		-10			
		$V_S = 15\text{ V}$; $V_O = V+$; $V_{ID} = -1\text{ V}$	Sink ⁽¹⁾		10	20		
			$T_A = -40^\circ\text{C}$ to $+85^\circ\text{C}$		5			
		$V_{ID} = -1\text{ V}$; $V_O = (V-) + 200\text{ mV}$			60	100	μA	
I_{SC}	Short-circuit current	$V_S = 20\text{ V}$, (V+) = 10 V, (V-) = -10 V, $V_O = 0\text{ V}$			±40	±60	mA	
C_{LOAD}	Capacitive load drive				100		pF	
R_O	Open-loop output resistance	$f = 1\text{ MHz}$, $I_O = 0\text{ A}$			300		Ω	

5.5 Electrical Characteristics: LM358B and LM358BA (continued)

$V_S = (V+) - (V-) = 5\text{ V} - 36\text{ V} (\pm 2.5\text{ V} - \pm 18\text{ V})$, $T_A = 25^\circ\text{C}$, $V_{CM} = V_{OUT} = V_S / 2$, $R_L = 10\text{k}$ connected to $V_S / 2$
(unless otherwise noted)

PARAMETER		TEST CONDITIONS		MIN	TYP	MAX	UNIT
POWER SUPPLY							
I_Q	Quiescent current per amplifier	$V_S = 5\text{ V}; I_O = 0\text{ A}$	$T_A = -40^\circ\text{C to } +85^\circ\text{C}$		300	460	μA
I_Q	Quiescent current per amplifier	$V_S = 36\text{ V}; I_O = 0\text{ A}$				800	μA

(1) Specified by characterization only.

5.6 Electrical Characteristics: LM2904B and LM2904BA

$V_S = (V+) - (V-) = 5\text{ V} - 36\text{ V} (\pm 2.5\text{ V} - \pm 18\text{ V})$, $T_A = 25^\circ\text{C}$, $V_{CM} = V_{OUT} = V_S/2$, $R_L = 10\text{k}$ connected to $V_S/2$
 (unless otherwise noted)

PARAMETER		TEST CONDITIONS		MIN	TYP	MAX	UNIT	
OFFSET VOLTAGE								
V_{OS}	Input offset voltage	LM2904B		± 0.3	± 3.0		mV	
			$T_A = -40^\circ\text{C}$ to $+125^\circ\text{C}$			± 4		mV
		LM2904BA				± 2.0		mV
			$T_A = -40^\circ\text{C}$ to $+125^\circ\text{C}$			± 3.0		mV
dV_{OS}/dT	Input offset voltage drift		$T_A = -40^\circ\text{C}$ to $+125^\circ\text{C}^{(1)}$	± 3.5	12		$\mu\text{V}/^\circ\text{C}$	
PSRR	Power Supply Rejection Ratio			± 2	15		$\mu\text{V}/\text{V}$	
	Channel separation, dc	$f = 1\text{ kHz}$ to 20 kHz		± 1			$\mu\text{V}/\text{V}$	
INPUT VOLTAGE RANGE								
V_{CM}	Common-mode voltage range	$V_S = 3\text{ V}$ to 36 V		(V-)	(V+) - 1.5		V	
		$V_S = 5\text{ V}$ to 36 V		$T_A = -40^\circ\text{C}$ to $+125^\circ\text{C}$	(V-) - 2			V
CMRR	Common-mode rejection ratio	$(V-) \leq V_{CM} \leq (V+) - 1.5\text{ V}$	$V_S = 3\text{ V}$ to 36 V		20	100	$\mu\text{V}/\text{V}$	
		$(V-) \leq V_{CM} \leq (V+) - 2.0\text{ V}$	$V_S = 5\text{ V}$ to 36 V	$T_A = -40^\circ\text{C}$ to $+125^\circ\text{C}$	25	316		
INPUT BIAS CURRENT								
I_B	Input bias current			-10	-35		nA	
			$T_A = -40^\circ\text{C}$ to $+125^\circ\text{C}^{(1)}$			-50	nA	
I_{OS}	Input offset current			0.5	4		nA	
			$T_A = -40^\circ\text{C}$ to $+125^\circ\text{C}^{(1)}$			5	nA	
dI_{OS}/dT	Input offset current drift		$T_A = -40^\circ\text{C}$ to $+125^\circ\text{C}$	10			$\text{pA}/^\circ\text{C}$	
NOISE								
E_n	Input voltage noise	$f = 0.1$ to 10 Hz			3		μV_{PP}	
e_n	Input voltage noise density	$f = 1\text{ kHz}$			40		$\text{nV}/\sqrt{\text{Hz}}$	
INPUT IMPEDANCE								
Z_{ID}	Differential			$10 \parallel 0.1$			$\text{M}\Omega \parallel \text{pF}$	
Z_{IC}	Common-mode			$4 \parallel 1.5$			$\text{G}\Omega \parallel \text{pF}$	
OPEN-LOOP GAIN								
A_{OL}	Open-loop voltage gain	$V_S = 15\text{ V}$; $V_O = 1\text{ V}$ to 11 V ; $R_L \geq 10\text{ k}\Omega$, connected to (V-)		70	140		V/mV	
				$T_A = -40^\circ\text{C}$ to $+125^\circ\text{C}$	35		V/mV	
FREQUENCY RESPONSE								
GBW	Gain bandwidth product				1.2		MHz	
SR	Slew rate	$G = +1$			0.5		$\text{V}/\mu\text{s}$	
ϕ_m	Phase margin	$G = +1$, $R_L = 10\text{k}\Omega$, $C_L = 20\text{ pF}$			56		$^\circ$	
t_{OR}	Overload recovery time	$V_{IN} \times \text{gain} > V_S$			10		μs	
t_s	Settling time	To 0.1%, $V_S = 5\text{ V}$, 2-V Step, $G = +1$, $C_L = 100\text{ pF}$			4		μs	
THD+N	Total harmonic distortion + noise	$G = +1$, $f = 1\text{ kHz}$, $V_O = 3.53\text{ V}_{RMS}$, $V_S = 36\text{ V}$, $R_L = 100\text{k}$, $I_{OUT} \leq \pm 50\mu\text{A}$, $\text{BW} = 80\text{ kHz}$			0.001		%	
OUTPUT								
V_O	Voltage output swing from rail	Positive Rail (V+)		$I_{OUT} = 50\mu\text{A}$	1.35	1.42	V	
				$I_{OUT} = 1\text{ mA}$	1.4	1.48	V	
				$I_{OUT} = 5\text{ mA}^{(1)}$	1.5	1.61	V	
		Negative Rail (V-)		$I_{OUT} = 50\mu\text{A}$	100	150	mV	
				$I_{OUT} = 1\text{ mA}$	0.75	1	V	
				$V_S = 5\text{ V}$, $R_L \leq 10\text{ k}\Omega$ connected to (V-)	$T_A = -40^\circ\text{C}$ to $+125^\circ\text{C}$	5	20	mV
I_O	Output current	$V_S = 15\text{ V}$; $V_O = V$; $V_{ID} = 1\text{ V}$	Source ⁽¹⁾	-20	-30	mA		
			$T_A = -40^\circ\text{C}$ to $+125^\circ\text{C}$	-10				
		$V_S = 15\text{ V}$; $V_O = V+$; $V_{ID} = -1\text{ V}$	Sink ⁽¹⁾	10	20			
			$T_A = -40^\circ\text{C}$ to $+125^\circ\text{C}$	5				
		$V_{ID} = -1\text{ V}$; $V_O = (V-) + 200\text{ mV}$		60	100	μA		
I_{SC}	Short-circuit current	$V_S = 20\text{ V}$, (V+) = 10 V , (V-) = -10 V , $V_O = 0\text{ V}$			± 40	± 60	mA	
C_{LOAD}	Capacitive load drive				100		pF	
R_O	Open-loop output resistance	$f = 1\text{ MHz}$, $I_O = 0\text{ A}$			300		Ω	
POWER SUPPLY								

$V_S = (V+) - (V-) = 5\text{ V} - 36\text{ V} (\pm 2.5\text{ V} - \pm 18\text{ V})$, $T_A = 25^\circ\text{C}$, $V_{CM} = V_{OUT} = V_S/2$, $R_L = 10\text{k}$ connected to $V_S/2$
 (unless otherwise noted)

PARAMETER		TEST CONDITIONS		MIN	TYP	MAX	UNIT
I_Q	Quiescent current per amplifier	$V_S = 5\text{ V}$; $I_O = 0\text{ A}$	$T_A = -40^\circ\text{C}$ to $+125^\circ\text{C}$		300	460	μA
I_Q	Quiescent current per amplifier	$V_S = 36\text{ V}$; $I_O = 0\text{ A}$				800	μA

(1) Specified by characterization only

5.7 Electrical Characteristics: LM358, LM358A

For $V_S = (V+) - (V-) = 5\text{ V}$, $T_A = 25^\circ\text{C}$ (unless otherwise noted)

PARAMETER		TEST CONDITIONS ⁽¹⁾		MIN	TYP ⁽²⁾	MAX	UNIT	
OFFSET VOLTAGE								
V_{OS}	Input offset voltage	$V_S = 5\text{ V to }30\text{ V}$; $V_{CM} = 0\text{ V}$; $V_O = 1.4\text{ V}$	LM358	$T_A = 0^\circ\text{C to }70^\circ\text{C}$	3	7	mV	
			LM358A		2	3		
dV_{OS}/dT	Input offset voltage drift		LM358	$T_A = 0^\circ\text{C to }70^\circ\text{C}$	7		$\mu\text{V}/^\circ\text{C}$	
			LM358A		7	20		
PSRR	Input offset voltage vs power supply ($\Delta V_{IO}/\Delta V_S$)	$V_S = 5\text{ V to }30\text{ V}$			65	100	dB	
V_{O1}/V_{O2}	Channel separation	$f = 1\text{ kHz to }20\text{ kHz}$				120	dB	
INPUT VOLTAGE RANGE								
V_{CM}	Common-mode voltage range	$V_S = 5\text{ V to }30\text{ V}$	LM358	$T_A = 0^\circ\text{C to }70^\circ\text{C}$	(V-)	(V+) – 1.5	V	
		$V_S = 30\text{ V}$	LM358A					
		$V_S = 5\text{ V to }30\text{ V}$	LM358		(V-)	(V+) – 2		
		$V_S = 30\text{ V}$	LM358A					
CMRR	Common-mode rejection ratio	$V_S = 5\text{ V to }30\text{ V}$; $V_{CM} = 0\text{ V}$			65	80	dB	
INPUT BIAS CURRENT								
I_B	Input bias current	$V_O = 1.4\text{ V}$	LM358	$T_A = 0^\circ\text{C to }70^\circ\text{C}$	-20	-250	nA	
			LM358A		-15	-100		
I_{OS}	Input offset current	$V_O = 1.4\text{ V}$	LM358	$T_A = 0^\circ\text{C to }70^\circ\text{C}$	2	50	nA	
			LM358A		2	30		
dI_{OS}/dT	Input offset current drift		LM358	$T_A = 0^\circ\text{C to }70^\circ\text{C}$	10		$\text{pA}/^\circ\text{C}$	
			LM358A		300			
NOISE								
e_n	Input voltage noise density	$f = 1\text{ kHz}$				40	$\text{nV}/\sqrt{\text{Hz}}$	
OPEN-LOOP GAIN								
A_{OL}	Open-loop voltage gain	$V_S = 15\text{ V}$; $V_O = 1\text{ V to }11\text{ V}$; $R_L \geq 2\text{ k}\Omega$			25	100	V/mV	
				$T_A = 0^\circ\text{C to }70^\circ\text{C}$	15			
FREQUENCY RESPONSE								
GBW	Gain bandwidth product					0.7	MHz	
SR	Slew rate	$G = +1$				0.3	V/ μs	
OUTPUT								
V_O	Voltage output swing from rail	Positive rail	$V_S = 30\text{ V}$; $R_L = 2\text{ k}\Omega$	$T_A = 0^\circ\text{C to }70^\circ\text{C}$		4	V	
			$V_S = 30\text{ V}$; $R_L \geq 10\text{ k}\Omega$		2	3		
			$V_S = 5\text{ V}$; $R_L \geq 2\text{ k}\Omega$			1.5		
	Negative rail	$V_S = 5\text{ V}$; $R_L \leq 10\text{ k}\Omega$	$T_A = 0^\circ\text{C to }70^\circ\text{C}$		5	20	mV	
I_O	Output current	$V_S = 15\text{ V}$; $V_O = 0\text{ V}$; $V_{ID} = 1\text{ V}$	Source	$T_A = 0^\circ\text{C to }70^\circ\text{C}$	-20	-30	mA	
			LM358A		-60			
		$V_S = 15\text{ V}$; $V_O = 15\text{ V}$; $V_{ID} = -1\text{ V}$	Sink	$T_A = 0^\circ\text{C to }70^\circ\text{C}$	10	20		
					5			
		$V_{ID} = -1\text{ V}$; $V_O = 200\text{ mV}$			12	30	μA	
I_{SC}	Short-circuit current	$V_S = 10\text{ V}$; $V_O = V_S/2$				± 40	± 60	mA
POWER SUPPLY								
I_Q	Quiescent current per amplifier	$V_O = 2.5\text{ V}$; $I_O = 0\text{ A}$	$T_A = 0^\circ\text{C to }70^\circ\text{C}$		350	600	μA	
		$V_S = 30\text{ V}$; $V_O = 15\text{ V}$; $I_O = 0\text{ A}$			500	1000		

- All characteristics are measured under open-loop conditions, with zero common-mode input voltage, unless otherwise specified. Maximum V_S for testing purposes is 30 V for LM358 and LM358A.
- All typical values are $T_A = 25^\circ\text{C}$.

5.8 Electrical Characteristics: LM2904, LM2904V

For $V_S = (V+) - (V-) = 5\text{ V}$, $T_A = 25^\circ\text{C}$ (unless otherwise noted)

PARAMETER		TEST CONDITIONS ⁽¹⁾		MIN	TYP ⁽²⁾	MAX	UNIT
OFFSET VOLTAGE							
V_{OS}	Input offset voltage	$V_S = 5\text{ V}$ to maximum; $V_{CM} = 0\text{ V}$; $V_O = 1.4\text{ V}$	Non-A suffix devices	$T_A = -40^\circ\text{C}$ to 125°C	3	7	mV
			A-suffix devices		1	2	
dV_{OS}/dT	Input offset voltage drift			$T_A = -40^\circ\text{C}$ to 125°C	7		$\mu\text{V}/^\circ\text{C}$
PSRR	Input offset voltage vs power supply ($\Delta V_{IO}/\Delta V_S$)	$V_S = 5\text{ V}$ to 30 V			65	100	dB
V_{O1}/V_{O2}	Channel separation	$f = 1\text{ kHz}$ to 20 kHz				120	dB
INPUT VOLTAGE RANGE							
V_{CM}	Common-mode voltage range	$V_S = 5\text{ V}$ to maximum			(V-)	(V+) - 1.5	V
			$T_A = -40^\circ\text{C}$ to 125°C	(V-)	(V+) - 2		
CMRR	Common-mode rejection ratio	$V_S = 5\text{ V}$ to maximum; $V_{CM} = 0\text{ V}$			65	80	dB
INPUT BIAS CURRENT							
I_B	Input bias current	$V_O = 1.4\text{ V}$			-20	-250	nA
			$T_A = -40^\circ\text{C}$ to 125°C			-500	
I_{OS}	Input offset current	$V_O = 1.4\text{ V}$	Non-V suffix device	$T_A = -40^\circ\text{C}$ to 125°C	2	50	nA
			V-suffix device		2	50	
dI_{OS}/dT	Input offset current drift			$T_A = -40^\circ\text{C}$ to 125°C	10		$\text{pA}/^\circ\text{C}$
NOISE							
e_n	Input voltage noise density	$f = 1\text{ kHz}$			40		$\text{nV}/\sqrt{\text{Hz}}$
OPEN-LOOP GAIN							
A_{OL}	Open-loop voltage gain	$V_S = 15\text{ V}$; $V_O = 1\text{ V}$ to 11 V ; $R_L \geq 2\text{ k}\Omega$			25	100	V/mV
			$T_A = -40^\circ\text{C}$ to 125°C			15	
FREQUENCY RESPONSE							
GBW	Gain bandwidth product				0.7		MHz
SR	Slew rate	$G = +1$			0.3		$\text{V}/\mu\text{s}$
OUTPUT							
V_O	Voltage output swing from rail	Positive rail	$R_L \geq 10\text{ k}\Omega$	$T_A = -40^\circ\text{C}$ to 125°C	$V_S - 1.5$		V
					Non-V suffix device	$V_S = \text{maximum}$; $R_L = 2\text{ k}\Omega$	
		V-suffix device	$V_S = \text{maximum}$; $R_L \geq 10\text{ k}\Omega$		2	3	
			$V_S = \text{maximum}$; $R_L = 2\text{ k}\Omega$		6	5	
Negative rail	$V_S = 5\text{ V}$; $R_L \leq 10\text{ k}\Omega$	$T_A = -40^\circ\text{C}$ to 125°C	5	20	mV		
I_O	Output current	$V_S = 15\text{ V}$; $V_O = 0\text{ V}$; $V_{ID} = 1\text{ V}$	Source	$T_A = -40^\circ\text{C}$ to 125°C	-20	-30	mA
					$T_A = -40^\circ\text{C}$ to 125°C	-10	
		$V_S = 15\text{ V}$; $V_O = 15\text{ V}$; $V_{ID} = -1\text{ V}$	Sink		10	20	5
		$V_{ID} = -1\text{ V}$; $V_O = 200\text{ mV}$	Non-V suffix device		30	40	μA
		V-suffix device	12	40			
I_{SC}	Short-circuit current	$V_S = 10\text{ V}$; $V_O = V_S / 2$			± 40	± 60	mA
POWER SUPPLY							
I_Q	Quiescent current per amplifier	$V_O = 2.5\text{ V}$; $I_O = 0\text{ A}$	$T_A = -40^\circ\text{C}$ to 125°C	350	600	μA	
		$V_S = \text{maximum}$; $V_O = \text{maximum} / 2$; $I_O = 0\text{ A}$		500	1000		

(1) All characteristics are measured under open-loop conditions, with zero common-mode input voltage, unless otherwise specified. Maximum V_S for testing purposes is 26 V for LM2904 and 32 V for LM2904V.

(2) All typical values are $T_A = 25^\circ\text{C}$.

5.9 Electrical Characteristics: LM158, LM158A

For $V_S = (V_+) - (V_-) = 5\text{ V}$, $T_A = 25^\circ\text{C}$ (unless otherwise noted)

PARAMETER		TEST CONDITIONS ⁽¹⁾		MIN	TYP ⁽²⁾	MAX	UNIT	
OFFSET VOLTAGE								
V_{OS}	Input offset voltage	$V_S = 5\text{ V to }30\text{ V}$; $V_{CM} = 0\text{ V}$; $V_O = 1.4\text{ V}$	LM158		3	5	mV	
				$T_A = -55^\circ\text{C to }125^\circ\text{C}$		7		
			LM158A			2		
				$T_A = -55^\circ\text{C to }125^\circ\text{C}$		4		
dV_{OS}/dT	Input offset voltage drift		LM158	$T_A = -55^\circ\text{C to }125^\circ\text{C}$	7		$\mu\text{V}/^\circ\text{C}$	
			LM158A	$T_A = -55^\circ\text{C to }125^\circ\text{C}$	7	15 ⁽³⁾		
PSRR	Input offset voltage vs power supply ($\Delta V_{IO}/\Delta V_S$)	$V_S = 5\text{ V to }30\text{ V}$			65	100	dB	
V_{O1}/V_{O2}	Channel separation	$f = 1\text{ kHz to }20\text{ kHz}$				120	dB	
INPUT VOLTAGE RANGE								
V_{CM}	Common-mode voltage range	$V_S = 5\text{ V to }30\text{ V}$	LM158		(V-)	(V+) - 1.5	V	
		$V_S = 30\text{ V}$	LM158A					
		$V_S = 5\text{ V to }30\text{ V}$	LM158	$T_A = -55^\circ\text{C to }125^\circ\text{C}$	(V-)	(V+) - 2		
		$V_S = 30\text{ V}$	LM158A					
CMRR	Common-mode rejection ratio	$V_S = 5\text{ V to }30\text{ V}$; $V_{CM} = 0\text{ V}$			70	80	dB	
INPUT BIAS CURRENT								
I_B	Input bias current	$V_O = 1.4\text{ V}$	LM158		-20	-150	nA	
				$T_A = -55^\circ\text{C to }125^\circ\text{C}$		-300		
			LM158A		-15	-50		
				$T_A = -55^\circ\text{C to }125^\circ\text{C}$		-100		
I_{OS}	Input offset current	$V_O = 1.4\text{ V}$	LM158		2	30	nA	
				$T_A = -55^\circ\text{C to }125^\circ\text{C}$		100		
			LM158A		2	10		
				$T_A = -55^\circ\text{C to }125^\circ\text{C}$		30		
dI_{OS}/dT	Input offset current drift				10		$\text{pA}/^\circ\text{C}$	
			LM158A	$T_A = -55^\circ\text{C to }125^\circ\text{C}$		200		
NOISE								
e_n	Input voltage noise density	$f = 1\text{ kHz}$			40		$\text{nV}/\sqrt{\text{Hz}}$	
OPEN-LOOP GAIN								
A_{OL}	Open-loop voltage gain	$V_S = 15\text{ V}$; $V_O = 1\text{ V to }11\text{ V}$; $R_L \geq 2\text{ k}\Omega$			50	100	V/mV	
				$T_A = -55^\circ\text{C to }125^\circ\text{C}$	25			
FREQUENCY RESPONSE								
GBW	Gain bandwidth product				0.7		MHz	
SR	Slew rate	$G = +1$			0.3		V/ μs	
OUTPUT								
V_O	Voltage output swing from rail	Positive rail	$V_S = 30\text{ V}$; $R_L = 2\text{ k}\Omega$	$T_A = -55^\circ\text{C to }125^\circ\text{C}$		4	V	
			$V_S = 30\text{ V}$; $R_L \geq 10\text{ k}\Omega$		2	3		
			$V_S = 5\text{ V}$; $R_L \geq 2\text{ k}\Omega$			1.5		
		Negative rail	$V_S = 5\text{ V}$; $R_L \leq 10\text{ k}\Omega$	$T_A = -55^\circ\text{C to }125^\circ\text{C}$		5	20	mV
I_O	Output current	$V_S = 15\text{ V}$; $V_O = 0\text{ V}$; $V_{ID} = 1\text{ V}$	Source	LM158A		-20	-30	mA
					$T_A = -55^\circ\text{C to }125^\circ\text{C}$	-10		
		$V_S = 15\text{ V}$; $V_O = 15\text{ V}$; $V_{ID} = -1\text{ V}$	Sink			10	20	
					$T_A = -55^\circ\text{C to }125^\circ\text{C}$	5		
	$V_{ID} = -1\text{ V}$; $V_O = 200\text{ mV}$				12	30	μA	
I_{SC}	Short-circuit current	$V_S = 10\text{ V}$; $V_O = V_S/2$			± 40	± 60	mA	

5.9 Electrical Characteristics: LM158, LM158A (continued)

For $V_S = (V+) - (V-) = 5\text{ V}$, $T_A = 25^\circ\text{C}$ (unless otherwise noted)

PARAMETER		TEST CONDITIONS ⁽¹⁾		MIN	TYP ⁽²⁾	MAX	UNIT
POWER SUPPLY							
I_Q	Quiescent current per amplifier	$V_O = 2.5\text{ V}; I_O = 0\text{ A}$	$T_A = -55^\circ\text{C to } 125^\circ\text{C}$		350	600	μA
		$V_S = 30\text{ V}; V_O = 15\text{ V}; I_O = 0\text{ A}$			500	1000	

- (1) All characteristics are measured under open-loop conditions, with zero common-mode input voltage, unless otherwise specified. Maximum V_S for testing purposes is 30 V for LM158 and LM158A.
- (2) All typical values are $T_A = 25^\circ\text{C}$.
- (3) On products compliant to MIL-PRF-38535, this parameter is not production tested.

5.10 Electrical Characteristics: LM258, LM258A

For $V_S = (V_+) - (V_-) = 5\text{ V}$, $T_A = 25^\circ\text{C}$ (unless otherwise noted)

PARAMETER		TEST CONDITIONS ⁽¹⁾		MIN	TYP ⁽²⁾	MAX	UNIT
OFFSET VOLTAGE							
V_{OS}	Input offset voltage	$V_S = 5\text{ V to }30\text{ V}$; $V_{CM} = 0\text{ V}$; $V_O = 1.4\text{ V}$	LM258		3	5	mV
				$T_A = -25^\circ\text{C to }85^\circ\text{C}$		7	
			LM258A		2	3	
				$T_A = -25^\circ\text{C to }85^\circ\text{C}$		4	
dV_{OS}/dT	Input offset voltage drift		LM258		7		$\mu\text{V}/^\circ\text{C}$
			LM258A	$T_A = -25^\circ\text{C to }85^\circ\text{C}$	7	15	
PSRR	Input offset voltage vs power supply ($\Delta V_{IO}/\Delta V_S$)	$V_S = 5\text{ V to }30\text{ V}$			65	100	dB
V_{O1}/V_{O2}	Channel separation	$f = 1\text{ kHz to }20\text{ kHz}$				120	dB
INPUT VOLTAGE RANGE							
V_{CM}	Common-mode voltage range	$V_S = 5\text{ V to }30\text{ V}$	LM258		(V-)	(V+) - 1.5	V
		$V_S = 30\text{ V}$	LM258A				
		$V_S = 5\text{ V to }30\text{ V}$	LM258	$T_A = -25^\circ\text{C to }85^\circ\text{C}$	(V-)	(V+) - 2	
		$V_S = 30\text{ V}$	LM258A				
CMRR	Common-mode rejection ratio	$V_S = 5\text{ V to }30\text{ V}$; $V_{CM} = 0\text{ V}$			70	80	dB
INPUT BIAS CURRENT							
I_B	Input bias current	$V_O = 1.4\text{ V}$	LM258		-20	-150	nA
				$T_A = -25^\circ\text{C to }85^\circ\text{C}$		-300	
			LM258A		-15	-80	
				$T_A = -25^\circ\text{C to }85^\circ\text{C}$		-100	
I_{OS}	Input offset current	$V_O = 1.4\text{ V}$	LM258		2	30	nA
				$T_A = -25^\circ\text{C to }85^\circ\text{C}$		100	
			LM258A		2	15	
				$T_A = -25^\circ\text{C to }85^\circ\text{C}$		30	
dI_{OS}/dT	Input offset current drift				10		$\text{pA}/^\circ\text{C}$
			LM258A	$T_A = -25^\circ\text{C to }85^\circ\text{C}$		200	
NOISE							
e_n	Input voltage noise density	$f = 1\text{ kHz}$			40		$\text{nV}/\sqrt{\text{Hz}}$
OPEN-LOOP GAIN							
A_{OL}	Open-loop voltage gain	$V_S = 15\text{ V}$; $V_O = 1\text{ V to }11\text{ V}$; $R_L \geq 2\text{ k}\Omega$			50	100	V/mV
				$T_A = -25^\circ\text{C to }85^\circ\text{C}$	25		
FREQUENCY RESPONSE							
GBW	Gain bandwidth product				0.7		MHz
SR	Slew rate	$G = +1$			0.3		V/ μs
OUTPUT							
V_O	Voltage output swing from rail	Positive rail	$V_S = 30\text{ V}$; $R_L = 2\text{ k}\Omega$	$T_A = -25^\circ\text{C to }85^\circ\text{C}$		4	V
			$V_S = 30\text{ V}$; $R_L \geq 10\text{ k}\Omega$		2	3	
			$V_S = 5\text{ V}$; $R_L \geq 2\text{ k}\Omega$			1.5	
		Negative rail	$V_S = 5\text{ V}$; $R_L \leq 10\text{ k}\Omega$	$T_A = -25^\circ\text{C to }85^\circ\text{C}$		5	20
I_O	Output current	$V_S = 15\text{ V}$; $V_O = 0\text{ V}$; $V_{ID} = 1\text{ V}$	Source	LM258		-20	mA
					$T_A = -25^\circ\text{C to }85^\circ\text{C}$	-10	
		$V_S = 15\text{ V}$; $V_O = 15\text{ V}$; $V_{ID} = -1\text{ V}$	Sink			10	20
					$T_A = -25^\circ\text{C to }85^\circ\text{C}$	5	
		$V_{ID} = -1\text{ V}$; $V_O = 200\text{ mV}$			12	30	μA
I_{SC}	Short-circuit current	$V_S = 10\text{ V}$; $V_O = V_S/2$			± 40	± 60	mA
POWER SUPPLY							
I_Q	Quiescent current per amplifier	$V_O = 2.5\text{ V}$; $I_O = 0\text{ A}$			350	600	μA
		$V_S = 30\text{ V}$; $V_O = 15\text{ V}$; $I_O = 0\text{ A}$		$T_A = -25^\circ\text{C to }85^\circ\text{C}$	500	1000	

- All characteristics are measured under open-loop conditions, with zero common-mode input voltage, unless otherwise specified. Maximum V_S for testing purposes is 30 V for LM258 and LM258A.
- All typical values are $T_A = 25^\circ\text{C}$.

5.11 Typical Characteristics: LM358B and LM2904B

This typical characteristics section is applicable for LM358B and LM2904B. Typical characteristics data in this section was taken with $T_A = 25^\circ\text{C}$, $V_S = 36\text{ V}$ ($\pm 18\text{ V}$), $V_{CM} = V_S / 2$, $R_{LOAD} = 10\text{ k}\Omega$ connected to $V_S / 2$ (unless otherwise noted).

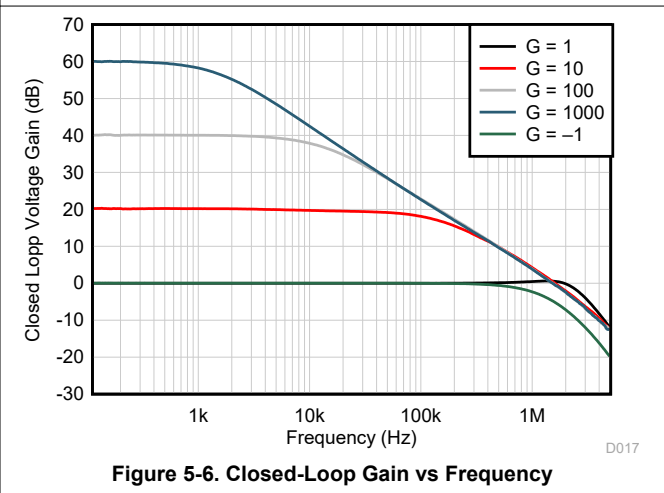
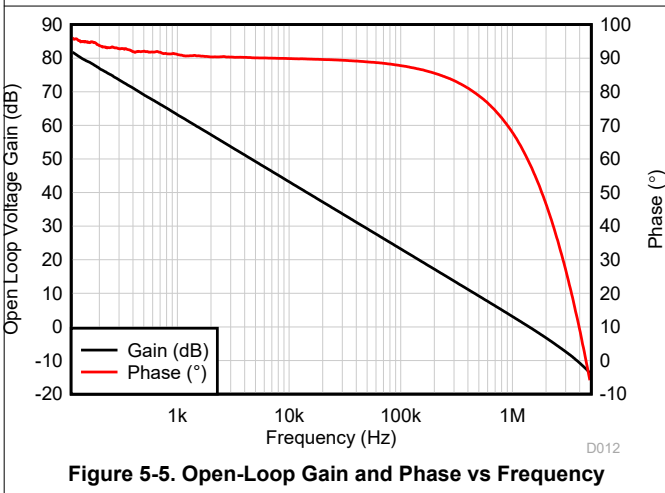
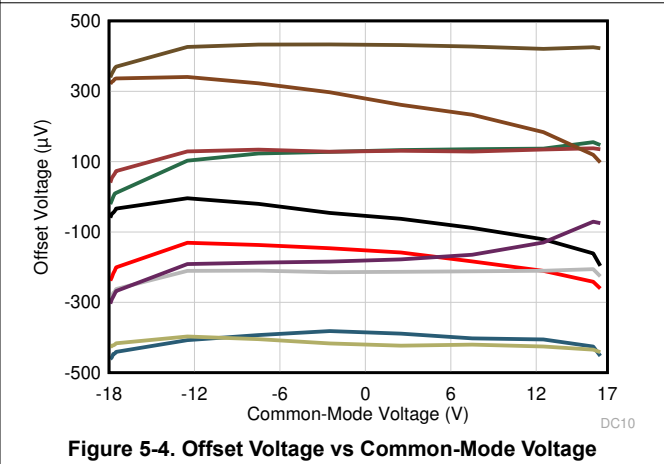
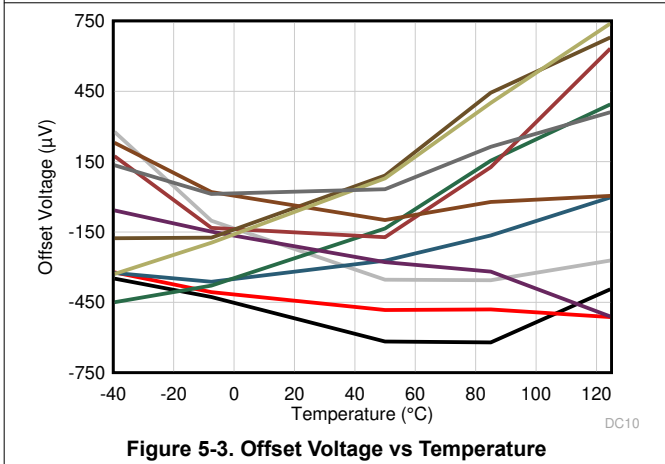
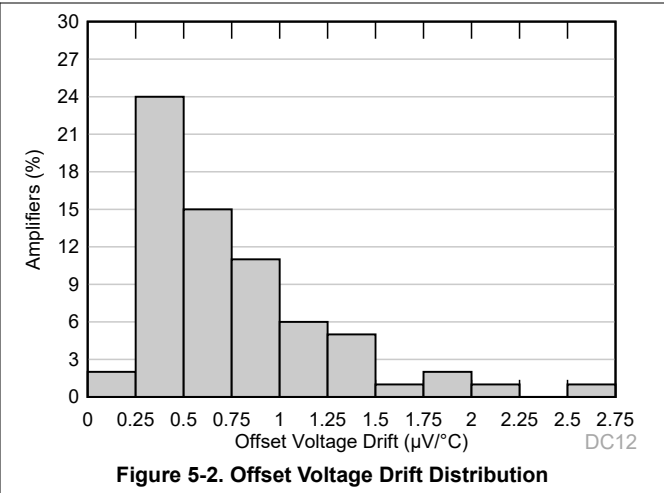
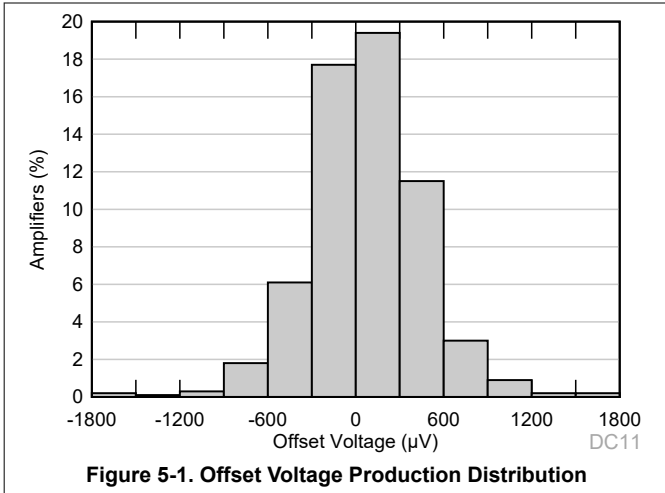

5.11 Typical Characteristics: LM358B and LM2904B (continued)

This typical characteristics section is applicable for LM358B and LM2904B. Typical characteristics data in this section was taken with $T_A = 25^\circ\text{C}$, $V_S = 36\text{ V}$ ($\pm 18\text{ V}$), $V_{CM} = V_S / 2$, $R_{LOAD} = 10\text{ k}\Omega$ connected to $V_S / 2$ (unless otherwise noted).

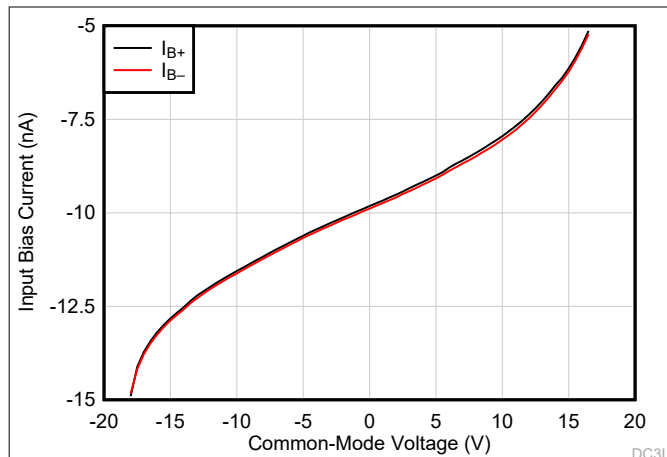

Figure 5-7. Input Bias Current vs Common-Mode Voltage

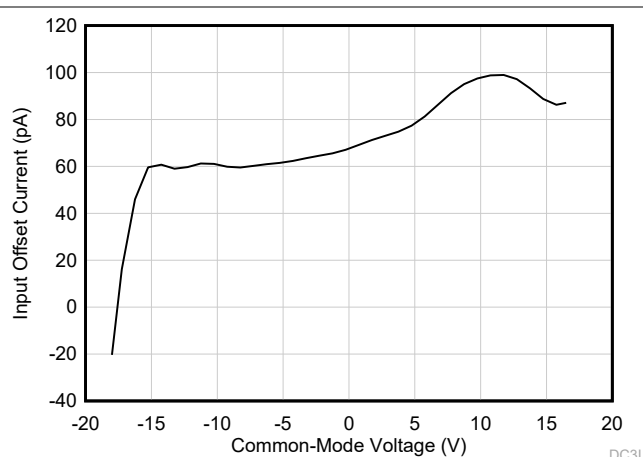

Figure 5-8. Input Offset Current vs Common-Mode Voltage

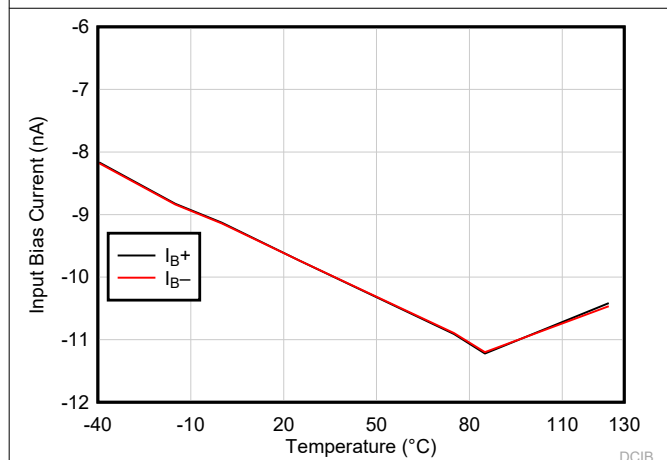

Figure 5-9. Input Bias Current vs Temperature

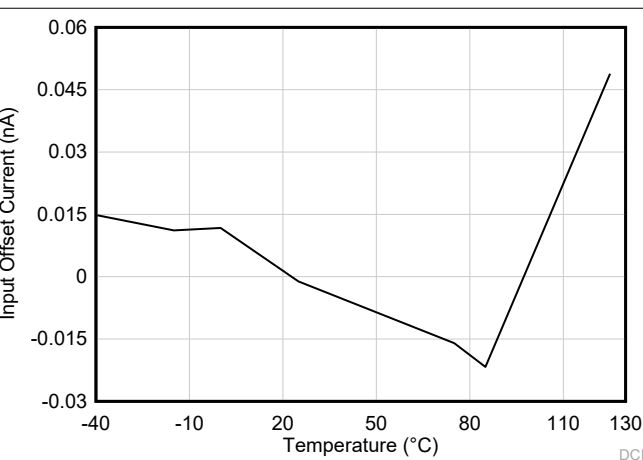

Figure 5-10. Input Offset Current vs Temperature

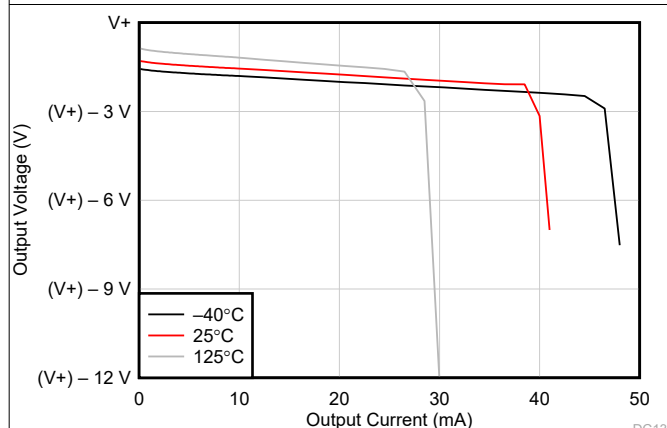

Figure 5-11. Output Voltage Swing vs Output Current (Sourcing)

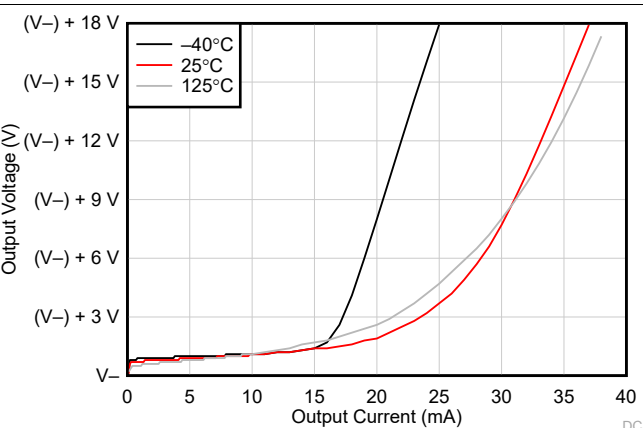

Figure 5-12. Output Voltage Swing vs Output Current (Sinking)

5.11 Typical Characteristics: LM358B and LM2904B (continued)

This typical characteristics section is applicable for LM358B and LM2904B. Typical characteristics data in this section was taken with $T_A = 25^\circ\text{C}$, $V_S = 36\text{ V}$ ($\pm 18\text{ V}$), $V_{CM} = V_S / 2$, $R_{LOAD} = 10\text{ k}\Omega$ connected to $V_S / 2$ (unless otherwise noted).

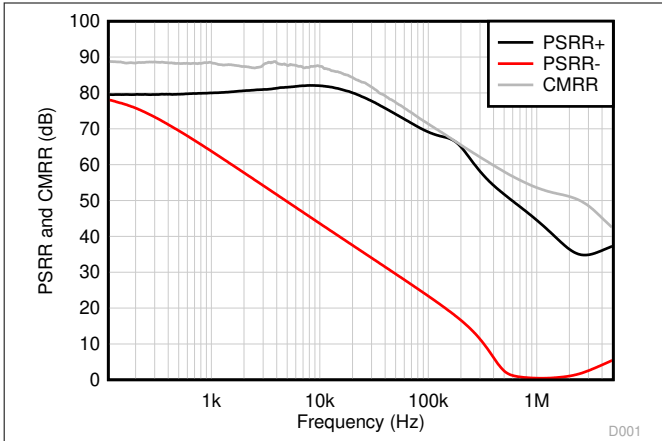

Figure 5-13. CMRR and PSRR vs Frequency

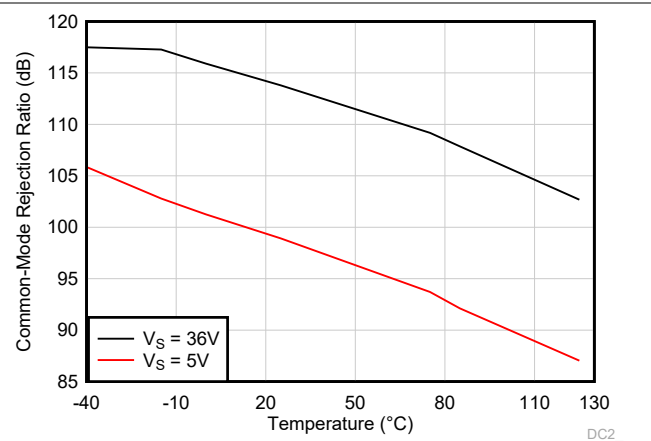

Figure 5-14. Common-Mode Rejection Ratio vs Temperature (dB)

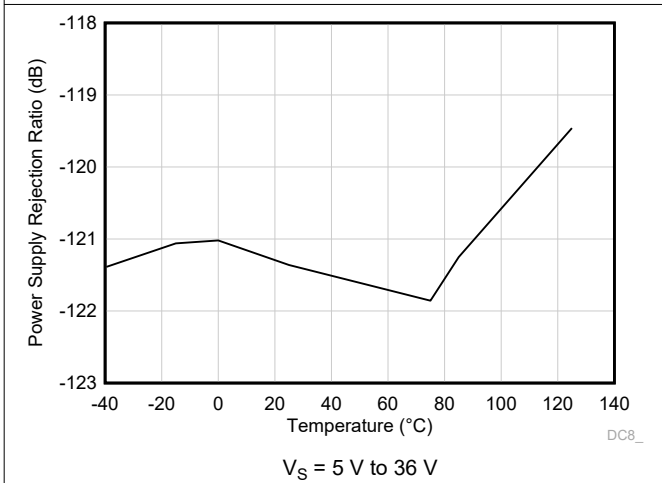

Figure 5-15. Power Supply Rejection Ratio vs Temperature (dB)

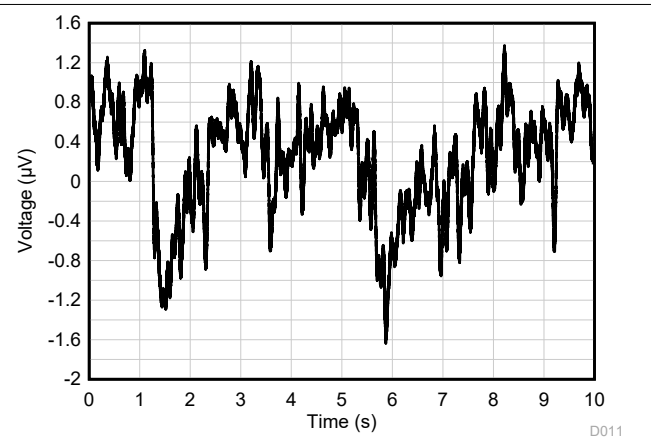

Figure 5-16. 0.1-Hz to 10-Hz Noise

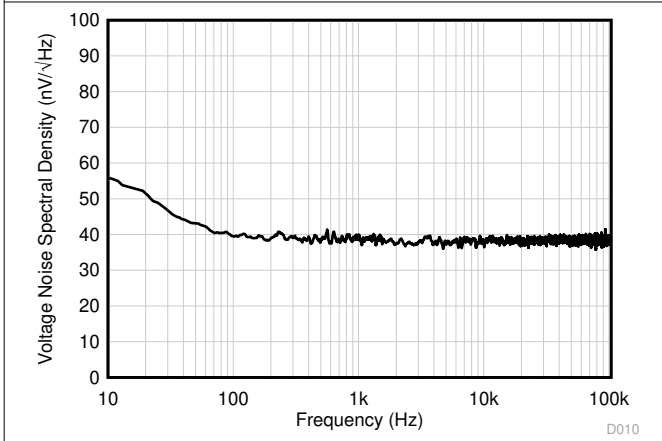

Figure 5-17. Input Voltage Noise Spectral Density vs Frequency

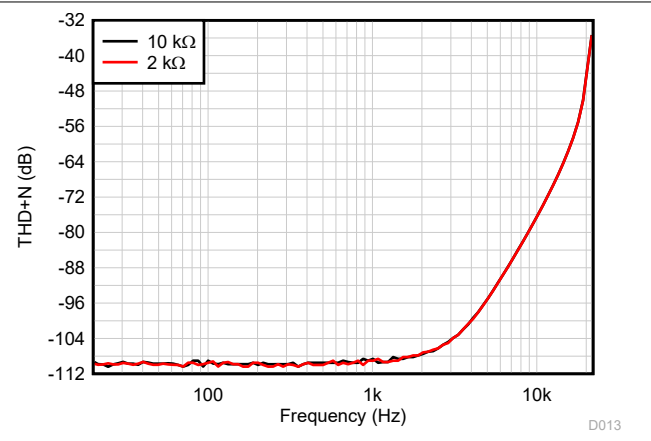

Figure 5-18. THD+N Ratio vs Frequency, $G = 1$
 $G = 1$, $f = 1\text{ kHz}$, $BW = 80\text{ kHz}$,
 $V_{OUT} = 10\text{ V}_{PP}$, R_L connected to V_-

5.11 Typical Characteristics: LM358B and LM2904B (continued)

This typical characteristics section is applicable for LM358B and LM2904B. Typical characteristics data in this section was taken with $T_A = 25^\circ\text{C}$, $V_S = 36\text{ V}$ ($\pm 18\text{ V}$), $V_{CM} = V_S / 2$, $R_{LOAD} = 10\text{ k}\Omega$ connected to $V_S / 2$ (unless otherwise noted).

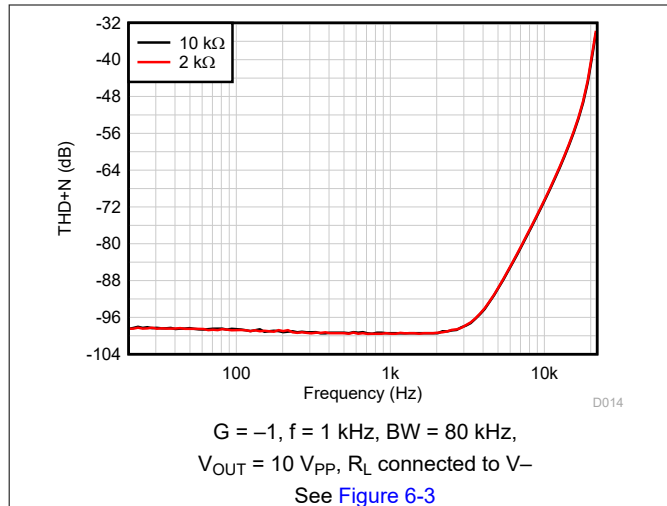

Figure 5-19. THD+N Ratio vs Frequency, $G = -1$

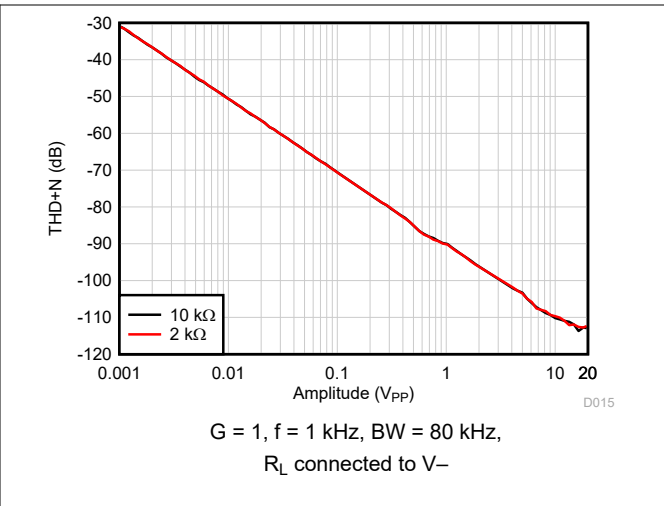

Figure 5-20. THD+N vs Output Amplitude, $G = 1$

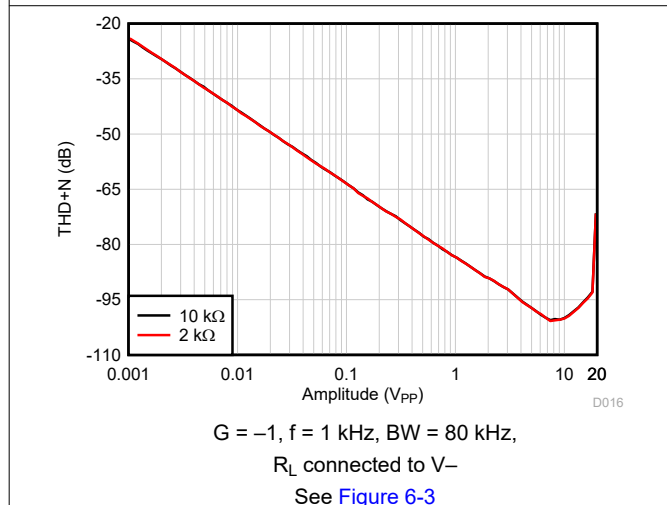

Figure 5-21. THD+N vs Output Amplitude, $G = -1$

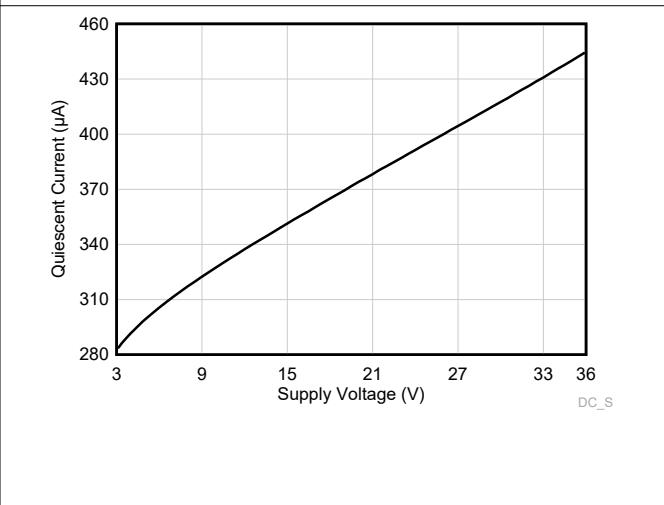

Figure 5-22. Quiescent Current vs Supply Voltage

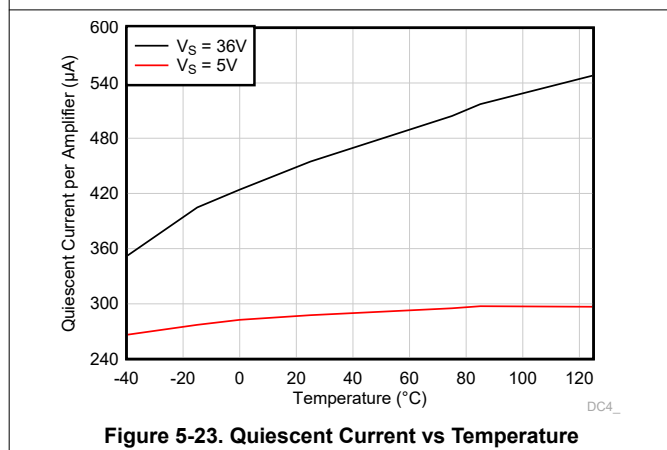

Figure 5-23. Quiescent Current vs Temperature

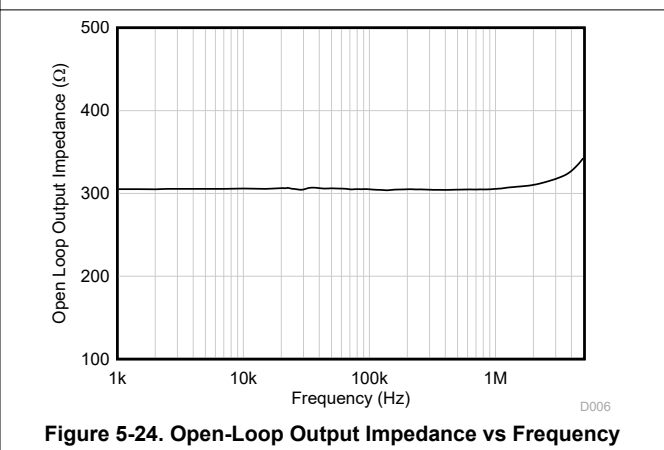

Figure 5-24. Open-Loop Output Impedance vs Frequency

5.11 Typical Characteristics: LM358B and LM2904B (continued)

This typical characteristics section is applicable for LM358B and LM2904B. Typical characteristics data in this section was taken with $T_A = 25^\circ\text{C}$, $V_S = 36\text{ V}$ ($\pm 18\text{ V}$), $V_{CM} = V_S / 2$, $R_{LOAD} = 10\text{ k}\Omega$ connected to $V_S / 2$ (unless otherwise noted).

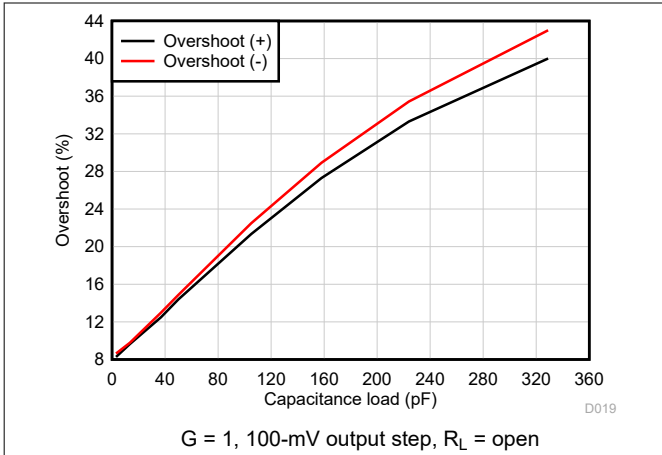

Figure 5-25. Small-Signal Overshoot vs Capacitive Load

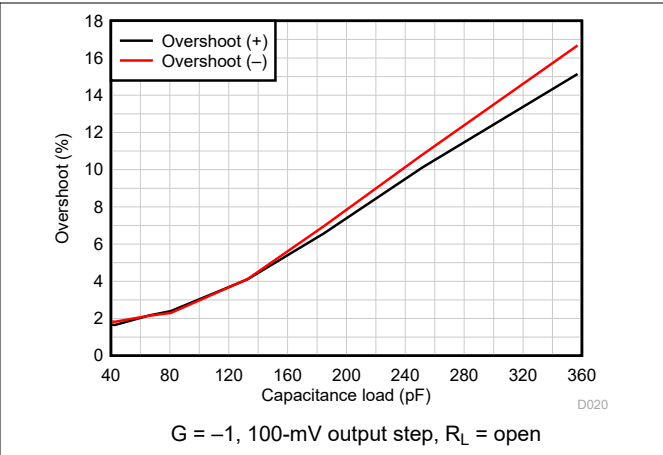

Figure 5-26. Small-Signal Overshoot vs Capacitive Load

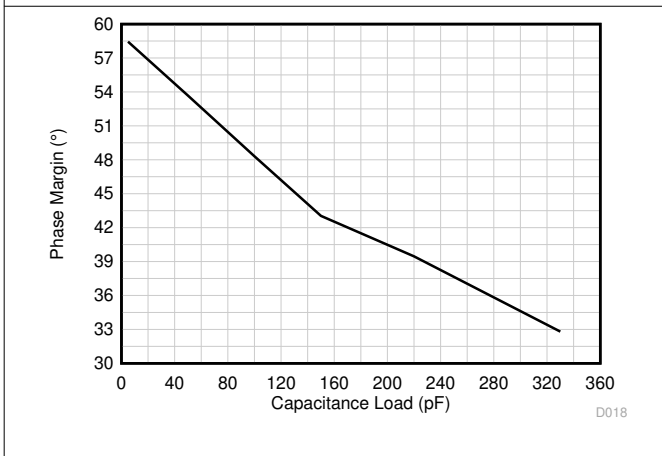

Figure 5-27. Phase Margin vs Capacitive Load

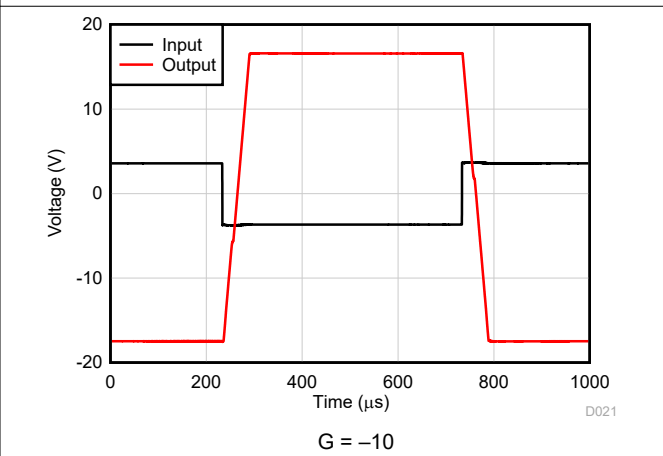

Figure 5-28. Overload Recovery

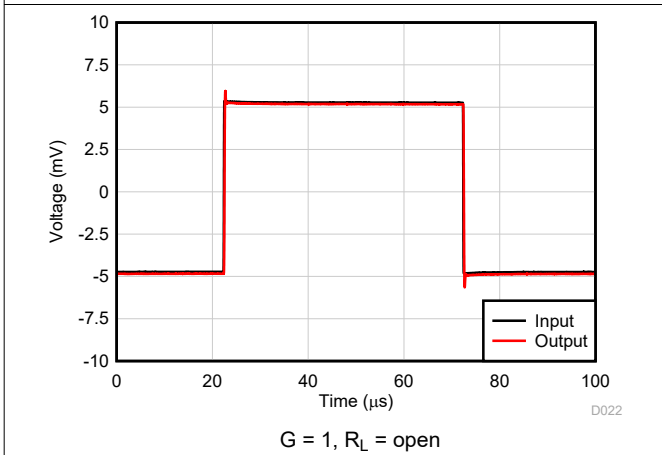

Figure 5-29. Small-Signal Step Response, $G = 1$

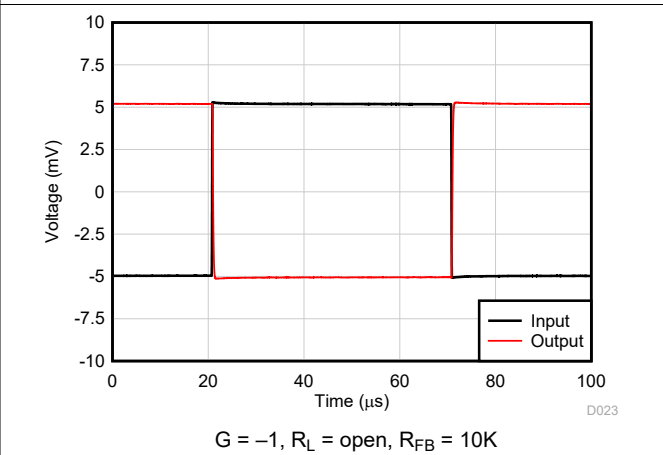

Figure 5-30. Small-Signal Step Response, $G = -1$

5.11 Typical Characteristics: LM358B and LM2904B (continued)

This typical characteristics section is applicable for LM358B and LM2904B. Typical characteristics data in this section was taken with $T_A = 25^\circ\text{C}$, $V_S = 36\text{ V}$ ($\pm 18\text{ V}$), $V_{CM} = V_S / 2$, $R_{LOAD} = 10\text{ k}\Omega$ connected to $V_S / 2$ (unless otherwise noted).

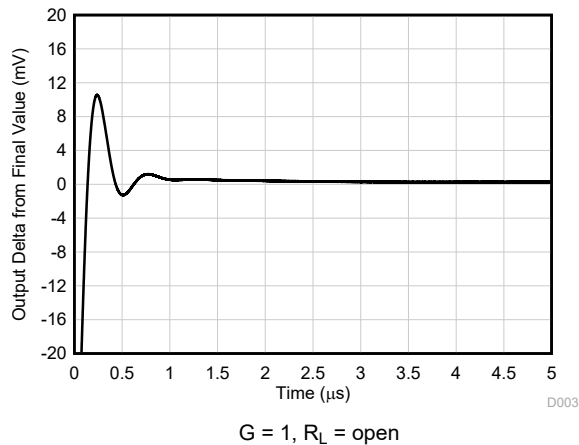

Figure 5-31. Large-Signal Step Response (Rising)

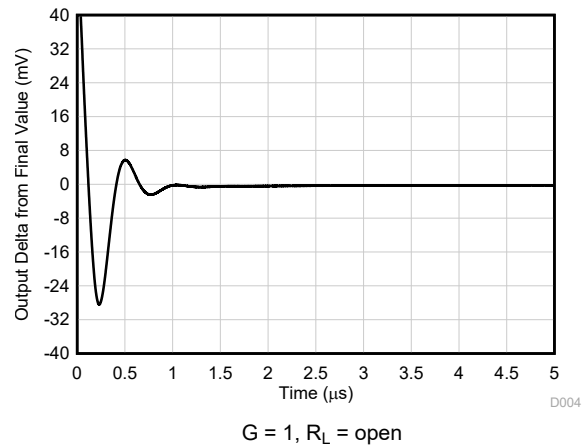

Figure 5-32. Large-Signal Step Response (Falling)

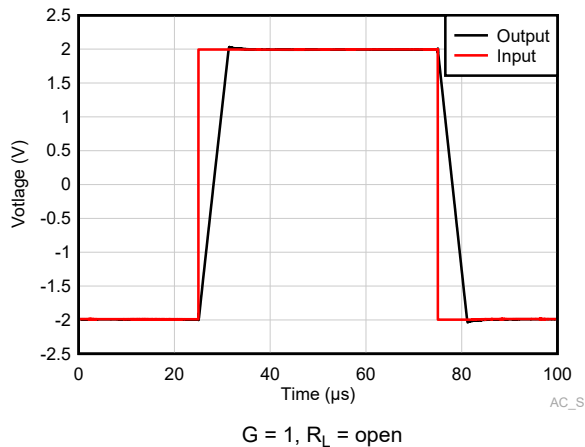

Figure 5-33. Large-Signal Step Response

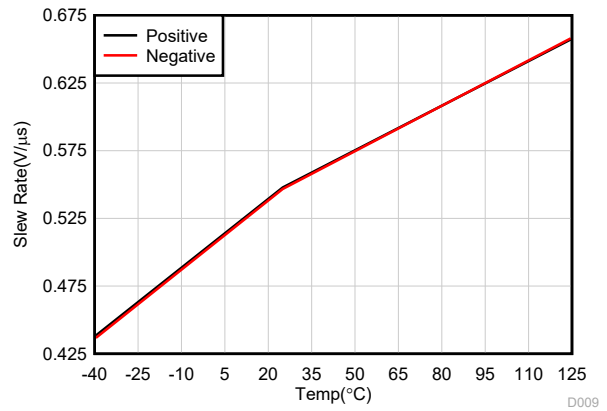

Figure 5-34. Slew Rate vs Temperature

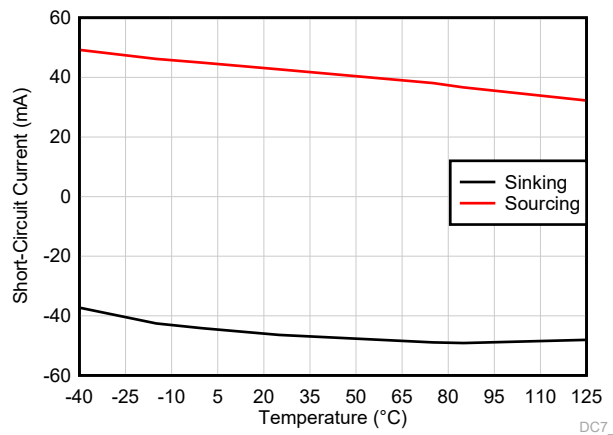

Figure 5-35. Short-Circuit Current vs Temperature

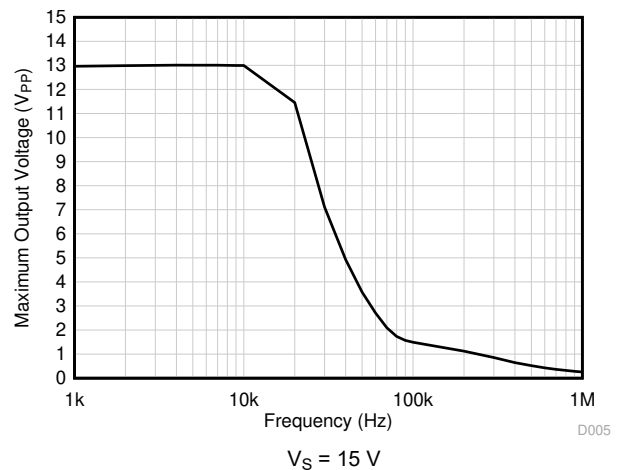
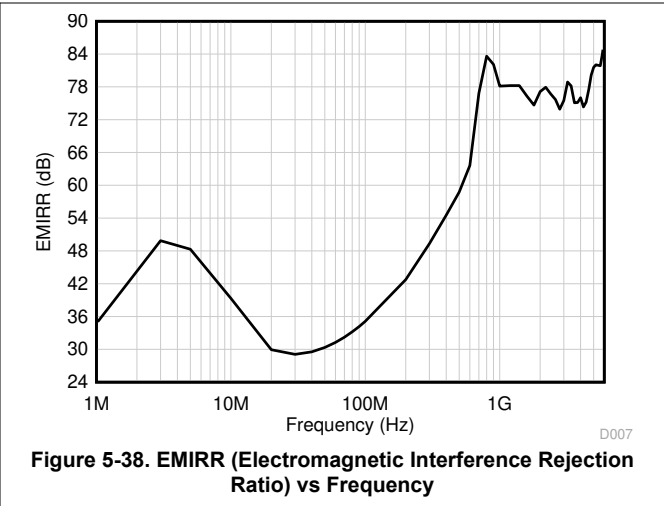
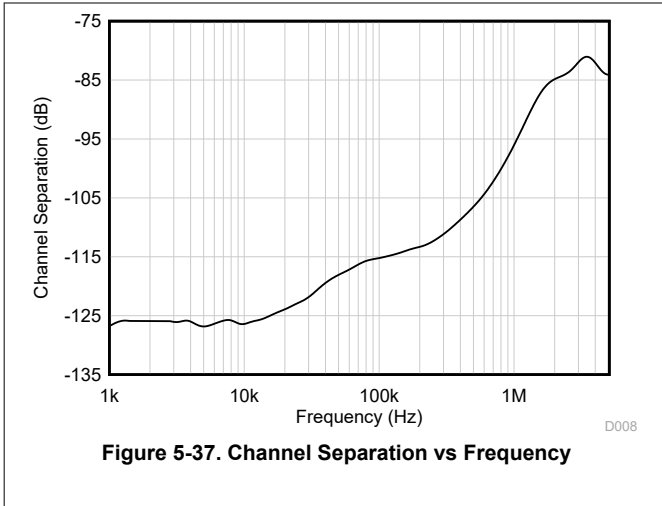

Figure 5-36. Maximum Output Voltage vs Frequency

5.11 Typical Characteristics: LM358B and LM2904B (continued)

This typical characteristics section is applicable for LM358B and LM2904B. Typical characteristics data in this section was taken with $T_A = 25^\circ\text{C}$, $V_S = 36\text{ V}$ ($\pm 18\text{ V}$), $V_{CM} = V_S / 2$, $R_{LOAD} = 10\text{ k}\Omega$ connected to $V_S / 2$ (unless otherwise noted).



5.12 Typical Characteristics: LM158, LM158A, LM258, LM258A, LM358, LM358A, LM2904, and LM2904V

Typical characteristics section is applicable for LM158, LM158A, LM258, LM258A, LM358, LM358A, LM2904, and LM2904V.

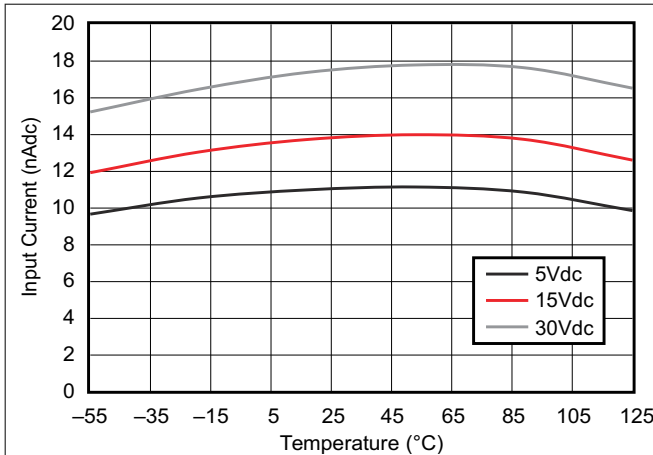

Figure 5-39. Input Current vs Temperature

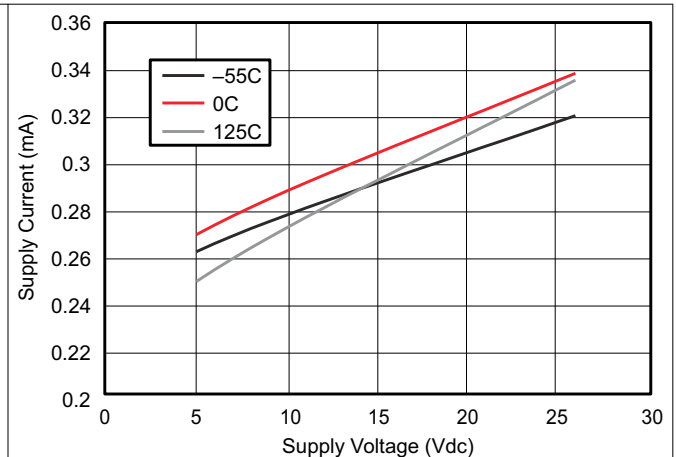

Figure 5-40. Supply Current vs Supply Voltage

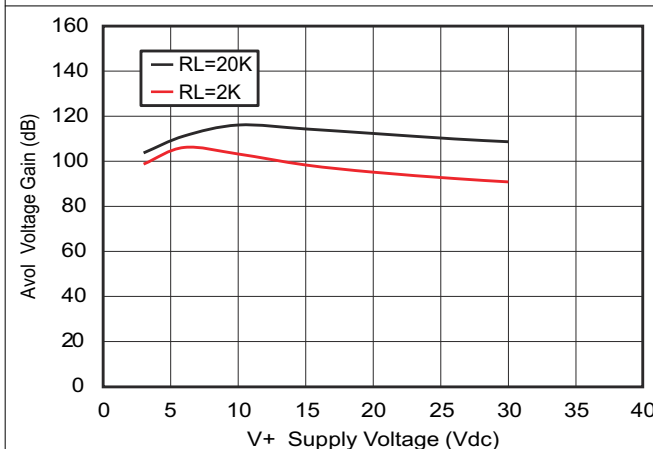

Figure 5-41. Voltage Gain vs Supply Voltage

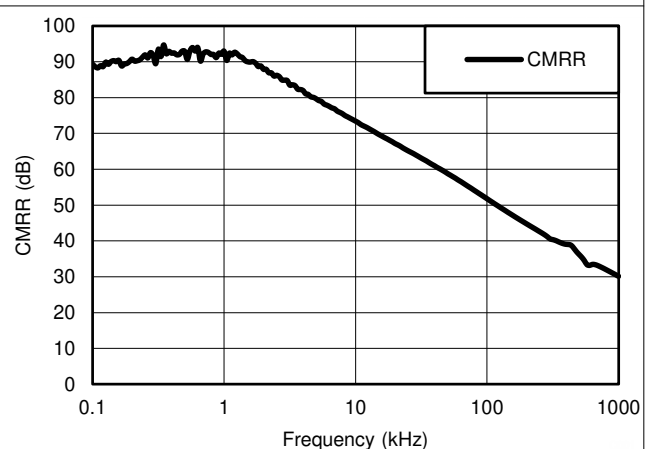

Figure 5-42. Common-Mode Rejection Ratio vs Frequency

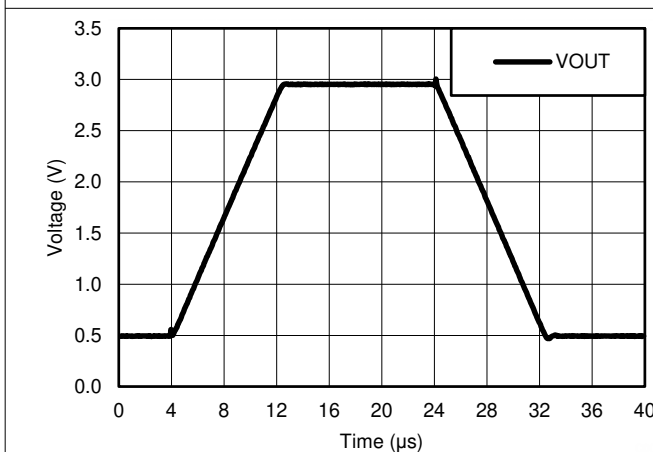

Figure 5-43. Voltage Follower Large Signal Response (50 pF)

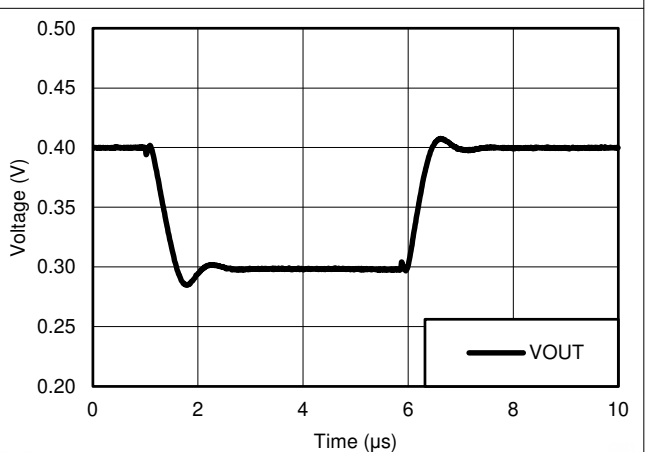

Figure 5-44. Voltage Follower Small Signal Response (50 pF)

5.12 Typical Characteristics: LM158, LM158A, LM258, LM258A, LM358, LM358A, LM2904, and LM2904V (continued)

Typical characteristics section is applicable for LM158, LM158A, LM258, LM258A, LM358, LM358A, LM2904, and LM2904V.

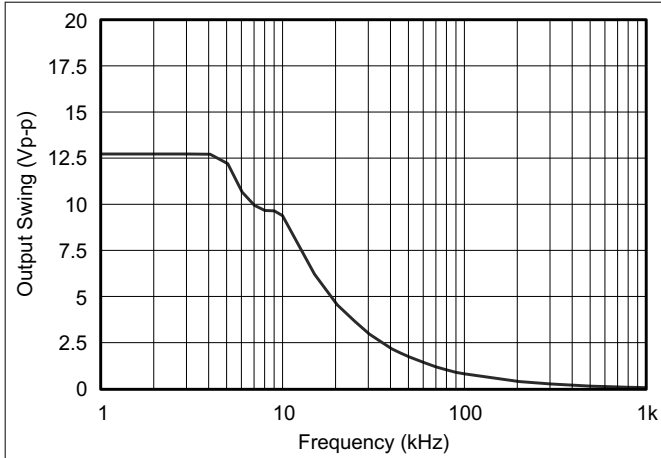

Figure 5-45. Maximum Output Swing vs Frequency ($V_{CC} = 15\text{ V}$)

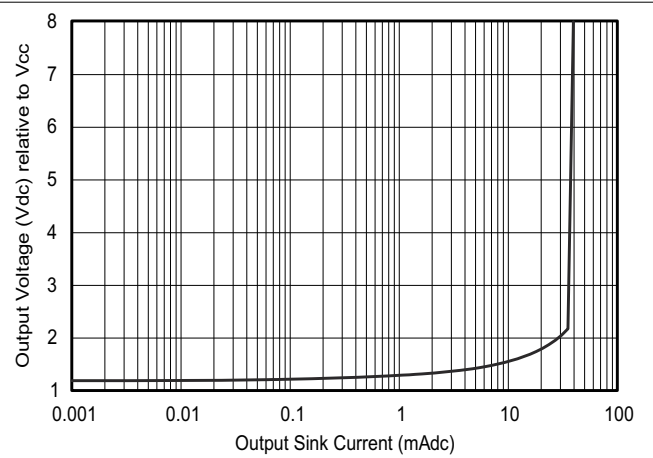

Figure 5-46. Output Sourcing Characteristics

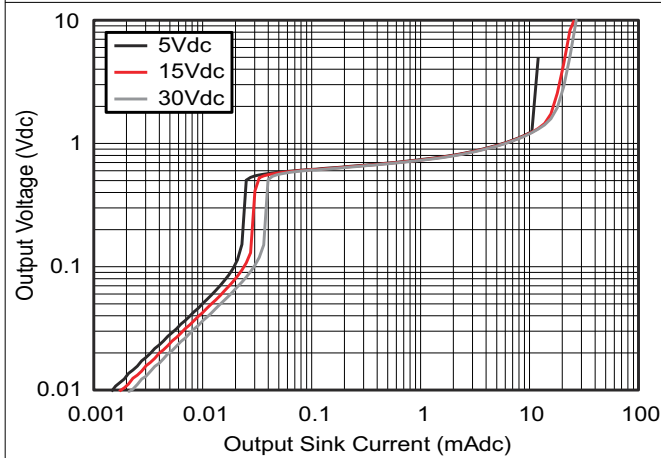

Figure 5-47. Output Sinking Characteristics

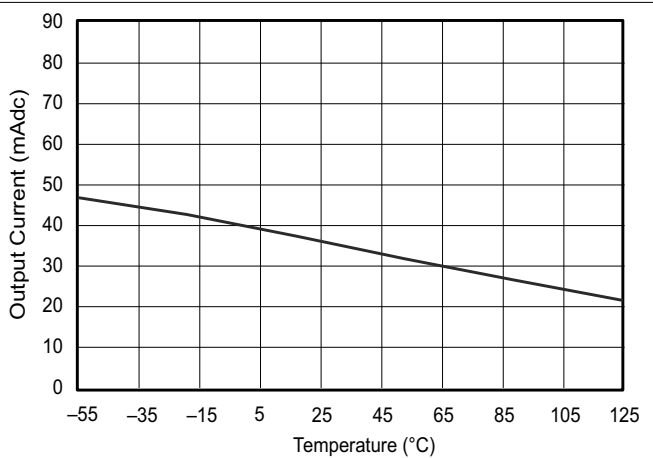

Figure 5-48. Source Current Limiting

6 Parameter Measurement Information

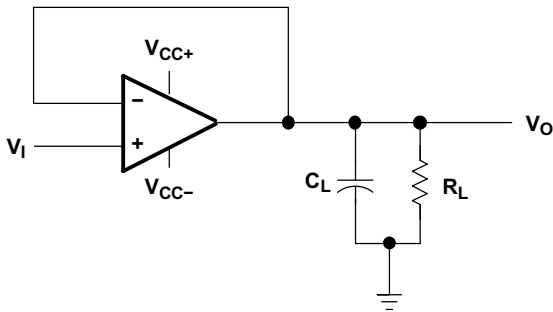

Figure 6-1. Unity-Gain Amplifier

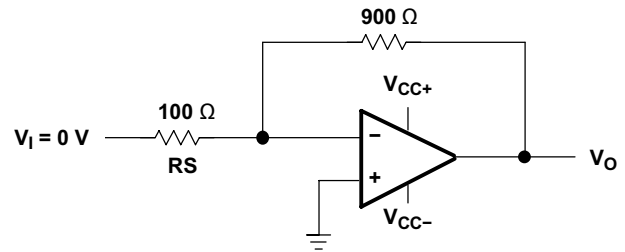

Figure 6-2. Noise-Test Circuit

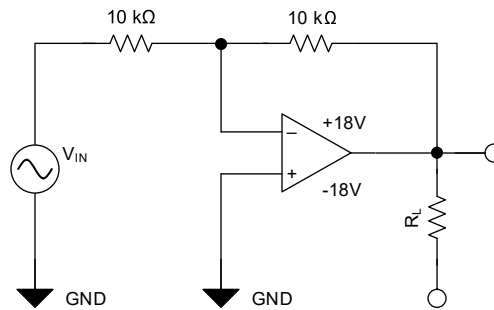

Figure 6-3. Test Circuit, $G = -1$, for THD+N and Small-Signal Step Response

7 Detailed Description

7.1 Overview

These devices consist of two independent, high-gain frequency-compensated operational amplifiers designed to operate from a single supply over a wide range of voltages. Operation from split supplies also is possible if the difference between the two supplies is within the supply voltage range specified in [Recommended Operating Conditions](#) and V_S is at least 1.5 V more positive than the input common-mode voltage. The low supply-current drain is independent of the magnitude of the supply voltage.

Applications include transducer amplifiers, dc amplification blocks, and all the conventional operational amplifier circuits that now can be implemented more easily in single-supply-voltage systems. For example, these devices can be operated directly from the standard 5-V supply used in digital systems and easily can provide the required interface electronics without additional ± 5 -V supplies.

7.2 Functional Block Diagram: LM358B, LM358BA, LM2904B, LM2904BA

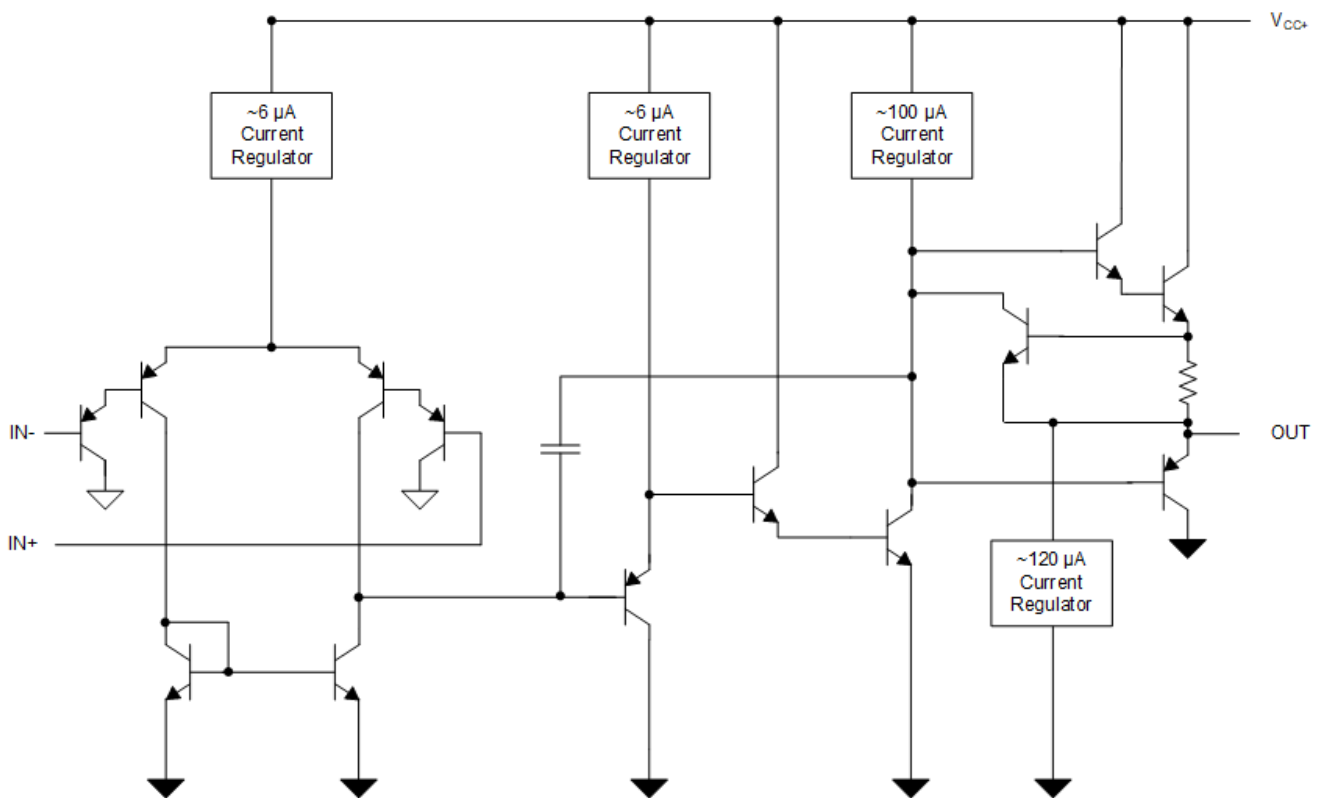

7.3 Feature Description

7.3.1 Unity-Gain Bandwidth

The unity-gain bandwidth is the frequency up to which an amplifier with a unity gain may be operated without greatly distorting the signal. These devices have a 1.2-MHz unity-gain bandwidth (B Version).

7.3.2 Slew Rate

The slew rate is the rate at which an operational amplifier can change its output when there is a change on the input. These devices have a 0.5-V/ μ s slew rate (B Version).

7.3.3 Input Common-Mode Range

The valid common-mode range is from device ground to $V_S - 1.5$ V ($V_S - 2$ V across temperature). Inputs may exceed V_S up to the maximum V_S without device damage. At least one input must be in the valid input common-mode range for the output to be the correct phase. If both inputs exceed the valid range, then the output phase is undefined. If either input more than 0.3 V below V_- then input current should be limited to 1 mA and the output phase is undefined.

7.4 Device Functional Modes

These devices are powered on when the supply is connected. This device can be operated as a single-supply operational amplifier or dual-supply amplifier, depending on the application.

8 Application and Implementation

Note

Information in the following applications sections is not part of the TI component specification, and TI does not warrant its accuracy or completeness. TI's customers are responsible for determining suitability of components for their purposes. Customers should validate and test their design implementation to confirm system functionality.

8.1 Application Information

The LMx58 and LM2904 operational amplifiers are useful in a wide range of signal conditioning applications. Inputs can be powered before V_S for flexibility in multiple supply circuits.

8.2 Typical Application

A typical application for an operational amplifier is an inverting amplifier. This amplifier takes a positive voltage on the input, and makes it a negative voltage of the same magnitude. In the same manner, it also makes negative voltages positive.

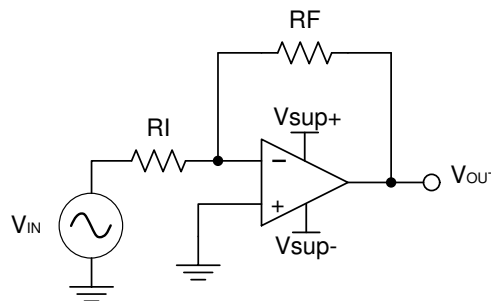

Figure 8-1. Application Schematic

8.2.1 Design Requirements

The supply voltage must be chosen such that it is larger than the input voltage range and output range. For instance, this application scales a signal of ± 0.5 V to ± 1.8 V. Setting the supply at ± 12 V is sufficient to accommodate this application.

8.2.2 Detailed Design Procedure

Determine the gain required by the inverting amplifier using [Equation 1](#) and [Equation 2](#):

$$A_V = \frac{V_{OUT}}{V_{IN}} \quad (1)$$

$$A_V = \frac{1.8}{-0.5} = -3.6 \quad (2)$$

Once the desired gain is determined, choose a value for R_I or R_F . [Subscripts should be fixed in the accompanying figures and equations also.] Choosing a value in the kilohm range is desirable because the amplifier circuit uses currents in the milliamperere range. This ensures the part does not draw too much current. This example uses 10 k Ω for R_I which means 36 k Ω is used for R_F . This was determined by [Equation 3](#).

$$A_V = -\frac{R_F}{R_I} \quad (3)$$

8.2.3 Application Curve

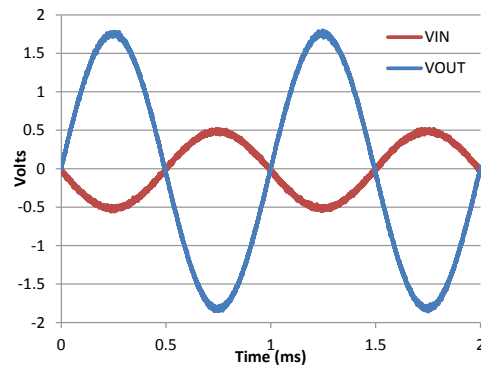

Figure 8-2. Input and Output Voltages of the Inverting Amplifier

8.3 Power Supply Recommendations

CAUTION

Supply voltages larger than specified in the recommended operating region can permanently damage the device (see [Absolute Maximum Ratings](#)).

Place 0.1- μ F bypass capacitors close to the power-supply pins to reduce errors coupling in from noisy or high-impedance power supplies. For more detailed information on bypass capacitor placement, see [Section 8.4](#).

8.4 Layout

8.4.1 Layout Guidelines

For best operational performance of the device, use good PCB layout practices, including:

- Noise can propagate into analog circuitry through the power pins of the circuit as a whole, as well as the operational amplifier. Bypass capacitors are used to reduce the coupled noise by providing low-impedance power sources local to the analog circuitry.
 - Connect low-ESR, 0.1- μ F ceramic bypass capacitors between each supply pin and ground, placed as close to the device as possible. A single bypass capacitor from V+ to ground is applicable for single-supply applications.
- Separate grounding for analog and digital portions of circuitry is one of the simplest and most-effective methods of noise suppression. One or more layers on multilayer PCBs are usually devoted to ground planes. A ground plane helps distribute heat and reduces EMI noise pickup. Make sure to physically separate digital and analog grounds, paying attention to the flow of the ground current.
- To reduce parasitic coupling, run the input traces as far away from the supply or output traces as possible. If it is not possible to keep them separate, it is much better to cross the sensitive trace perpendicular as opposed to in parallel with the noisy trace.
- Place the external components as close to the device as possible. Keeping R_F and R_G close to the inverting input minimizes parasitic capacitance, as shown in [Layout Examples](#).
- Keep the length of input traces as short as possible. Always remember that the input traces are the most sensitive part of the circuit.
- Consider a driven, low-impedance guard ring around the critical traces. A guard ring can significantly reduce leakage currents from nearby traces that are at different potentials.

8.4.2 Layout Examples

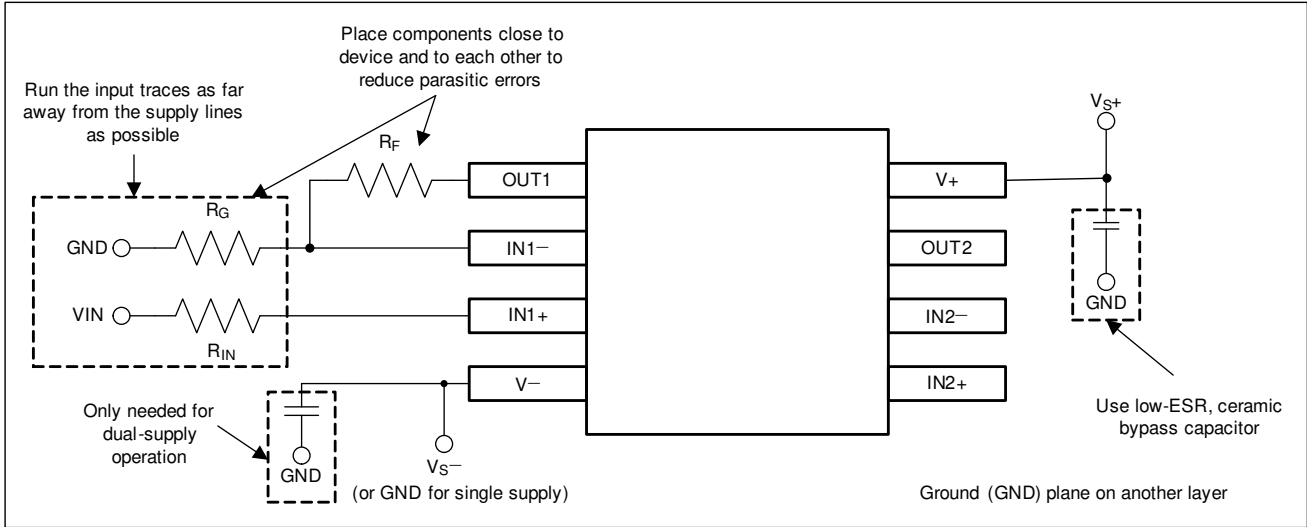

Figure 8-3. Operational Amplifier Board Layout for Noninverting Configuration

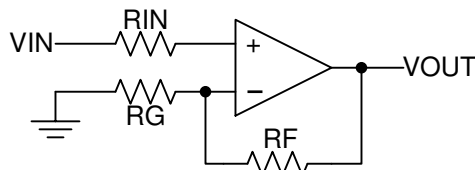

Figure 8-4. Operational Amplifier Schematic for Noninverting Configuration

9 Device and Documentation Support

9.1 Receiving Notification of Documentation Updates

To receive notification of documentation updates, navigate to the device product folder on ti.com. Click on *Notifications* to register and receive a weekly digest of any product information that has changed. For change details, review the revision history included in any revised document.

9.2 Support Resources

[TI E2E™ support forums](#) are an engineer's go-to source for fast, verified answers and design help — straight from the experts. Search existing answers or ask your own question to get the quick design help you need.

Linked content is provided "AS IS" by the respective contributors. They do not constitute TI specifications and do not necessarily reflect TI's views; see TI's [Terms of Use](#).

9.3 Trademarks

TI E2E™ is a trademark of Texas Instruments.
 All trademarks are the property of their respective owners.

9.4 Electrostatic Discharge Caution



This integrated circuit can be damaged by ESD. Texas Instruments recommends that all integrated circuits be handled with appropriate precautions. Failure to observe proper handling and installation procedures can cause damage.

ESD damage can range from subtle performance degradation to complete device failure. Precision integrated circuits may be more susceptible to damage because very small parametric changes could cause the device not to meet its published specifications.

9.5 Glossary

[TI Glossary](#) This glossary lists and explains terms, acronyms, and definitions.

10 Revision History

NOTE: Page numbers for previous revisions may differ from page numbers in the current version.

Changes from Revision AA (March 2022) to Revision AB (October 2024)	Page
• Changed <i>Device Information</i> table to <i>Package Information</i>	1
• Changed the polarity of the LM358B and LM358BA input bias current value from \pm to $-$ in the <i>Electrical Characteristics</i> section.....	6
• Changed the polarity of the LM2904B and LM2904BA input bias current value from \pm to $-$ in the <i>Electrical Characteristics</i> section.....	8

Changes from Revision Z (July 2021) to Revision AA (March 2022)	Page
• Added LM358BA and LM2904BA to the <i>Device Information</i> table.....	1
• Added <i>Family Comparison</i> table to the <i>Description</i> section	1
• Raised ESD (CDM) for B-versions and BA-versions from 1 kV to 1.5 kV in the <i>ESD Ratings</i> table	4
• Changed Input Offset Voltage Max of LM2904BA from $T_A = -40^\circ\text{C}$ to $+125^\circ\text{C}$ from ± 2.5 mV to ± 3.0 mV.....	8

Changes from Revision Y (February 2021) to Revision Z (July 2021)	Page
• Deleted preview tag from LM358B and LM2904B SOT-23 (8) package in <i>Device Information</i> table.....	1
• Updated DDF (SOT-23) package thermal information in the <i>Thermal Information</i> table.....	5
• Deleted <i>Related Links</i> from the <i>Device and Documentation Support</i> section.....	30

Changes from Revision X (June 2020) to Revision Y (February 2021) Page

- Updated the numbering format for tables, figures, and cross-references throughout the document..... 1
- Added SOT23-8 (DDF) package information throughout data sheet..... 1
- Deleted preview tag from LM358B and LM2904B VSSOP (8) package in *Device Information* table..... 1
- Added SOT23-8 (DDF) package information to the *Pin Configuration and Functions* section..... 3
- Added DDF (SOT-23) package to the *Thermal Information* table..... 5

Changes from Revision W (October 2019) to Revision X (June 2020) Page

- Added application links to *Applications* section..... 1
- Deleted preview tag from LM358B and LM2904B TSSOP (8) package in *Device Information* table 1

Changes from Revision V (September 2018) to Revision W (October 2019) Page

- Changed CDM ESD rating for LM358B and LM2904B in *ESD Ratings* 4
- Changed V_S to V_+ in *Recommended Operating Conditions* 5
- Changed *Thermal Information* for the LM158FK and LM158JG devices..... 5
- Added *Typical Characteristics* section for the LM358B and LM2490B op amps..... 15
- Added test circuit for THD+N and small-signal step response, $G = -1$ in the *Parameter Measurement Information* section..... 24
- Changed the *Functional Block Diagram* 25

Changes from Revision U (January 2017) to Revision V (September 2018) Page

- Changed the data sheet title 1
- Changed first four items in the *Features* section 1
- Changed the first item in the *Applications* section and added four new items 1
- Changed voltage values in the first paragraph of the *Description* section..... 1
- Changed text in the second paragraph of the *Description* section..... 1
- Added devices LM358B and LM2904B to data sheet..... 1
- Changed the first three rows of the *Device Information* table and added a cross-referenced note for PREVIEW-status devices..... 1
- Added a table note to the *Pin Functions* table 3
- Changed "free-air temperature" to "ambient temperature" in the *Absolute Maximum Ratings* condition statement..... 4
- Changed all entries in the *Absolute Maximum Ratings* table except T_J and T_{stg} 4
- Deleted lead temperature and case temperature from *Absolute Maximum Ratings* 4
- Changed device listings and their voltage values in the *ESD Ratings* table 4
- Changed "free-air temperature" to "ambient temperature" in the *Recommended Operating Conditions* condition statement 5
- Changed table entries for all parameters in the *Recommended Operating Conditions* table..... 5
- Added rows to the Thermal Information table, and a table note regarding device-package combinations 5
- Deleted the *Operating Conditions* table..... 14
- Added a condition statement to the *Typical Characteristics* section..... 22
- Changed specific voltages to a *Recommended Operating Conditions* reference..... 25
- Changed unity-gain bandwidth from 0.7 MHz for all devices to 1.2 MHz for B-version devices..... 26
- Changed slew rate from 3 V/ μ s for all devices to 0.5 V/ μ s for B-version devices..... 26
- Changed the *Input Common-Mode Range* section in multiple places throughout..... 26
- Changed V_{CC} to V_S in the *Application Information* section 27
- Subscripted the suffixes fro R_I and R_F 27

- Changed *Operational Amplifier Board Layout for Noninverting Configuration* with an image that includes a dual op amp.....29

Changes from Revision T (April 2015) to Revision U (January 2017) Page

- Changed data sheet title.....1

Changes from Revision S (January 2014) to Revision T (April 2015) Page

- Added *Applications* section, *ESD Ratings* table, *Feature Description* section, *Device Functional Modes, Application and Implementation* section, *Power Supply Recommendations* section, *Layout* section, *Device and Documentation Support* section, and *Mechanical, Packaging, and Orderable Information* section 1

Changes from Revision R (July 2010) to Revision S (January 2014) Page

- Converted this data sheet from the QS format to DocZone using the PDF on the web..... 1
- Deleted *Ordering Information* table..... 1
- Updated *Features* to include Military Disclaimer..... 1
- Added Typical Characteristics section.....22

11 Mechanical, Packaging, and Orderable Information

The following pages include mechanical packaging and orderable information. This information is the most-current data available for the designated devices. This data is subject to change without notice and without revision of this document. For browser based versions of this data sheet, see the left-hand navigation pane.

PACKAGING INFORMATION

Orderable part number	Status (1)	Material type (2)	Package Pins	Package qty Carrier	RoHS (3)	Lead finish/ Ball material (4)	MSL rating/ Peak reflow (5)	Op temp (°C)	Part marking (6)
5962-87710012A	Active	Production	LCCC (FK) 20	55 TUBE	No	SNPB	N/A for Pkg Type	-55 to 125	5962-87710012A LM158FKB
5962-8771001PA	Active	Production	CDIP (JG) 8	50 TUBE	No	SNPB	N/A for Pkg Type	-55 to 125	8771001PA LM158
5962-87710022A	Active	Production	LCCC (FK) 20	55 TUBE	No	SNPB	N/A for Pkg Type	-55 to 125	5962-87710022A LM158AFKB
5962-8771002PA	Active	Production	CDIP (JG) 8	50 TUBE	No	SNPB	N/A for Pkg Type	-55 to 125	8771002PA LM158A
LM158 MW8	Active	Production	WAFERSALE (YS) 0	1 NOT REQUIRED	-	Call TI	Level-1-NA-UNLIM	-55 to 125	
LM158AFKB	Active	Production	LCCC (FK) 20	55 TUBE	No	SNPB	N/A for Pkg Type	-55 to 125	5962-87710022A LM158AFKB
LM158AFKB.A	Active	Production	LCCC (FK) 20	55 TUBE	No	SNPB	N/A for Pkg Type	-55 to 125	5962-87710022A LM158AFKB
LM158AJG	Active	Production	CDIP (JG) 8	50 TUBE	No	SNPB	N/A for Pkg Type	-55 to 125	LM158AJG
LM158AJG.A	Active	Production	CDIP (JG) 8	50 TUBE	No	SNPB	N/A for Pkg Type	-55 to 125	LM158AJG
LM158AJGB	Active	Production	CDIP (JG) 8	50 TUBE	No	SNPB	N/A for Pkg Type	-55 to 125	8771002PA LM158A
LM158AJGB.A	Active	Production	CDIP (JG) 8	50 TUBE	No	SNPB	N/A for Pkg Type	-55 to 125	8771002PA LM158A
LM158FKB	Active	Production	LCCC (FK) 20	55 TUBE	No	SNPB	N/A for Pkg Type	-55 to 125	5962-87710012A LM158FKB
LM158FKB.A	Active	Production	LCCC (FK) 20	55 TUBE	No	SNPB	N/A for Pkg Type	-55 to 125	5962-87710012A LM158FKB
LM158JG	Active	Production	CDIP (JG) 8	50 TUBE	No	SNPB	N/A for Pkg Type	-55 to 125	LM158JG
LM158JG.A	Active	Production	CDIP (JG) 8	50 TUBE	No	SNPB	N/A for Pkg Type	-55 to 125	LM158JG
LM158JGB	Active	Production	CDIP (JG) 8	50 TUBE	No	SNPB	N/A for Pkg Type	-55 to 125	8771001PA LM158

Orderable part number	Status (1)	Material type (2)	Package Pins	Package qty Carrier	RoHS (3)	Lead finish/ Ball material (4)	MSL rating/ Peak reflow (5)	Op temp (°C)	Part marking (6)
LM158JGB.A	Active	Production	CDIP (JG) 8	50 TUBE	No	SNPB	N/A for Pkg Type	-55 to 125	8771001PA LM158
LM258ADGKR	Active	Production	VSSOP (DGK) 8	2500 LARGE T&R	Yes	NIPDAU SN	Level-1-260C-UNLIM	-25 to 85	(M3L, M3P, M3S, M3 U)
LM258ADGKR.A	Active	Production	VSSOP (DGK) 8	2500 LARGE T&R	Yes	NIPDAU	Level-1-260C-UNLIM	-25 to 85	(M3L, M3P, M3S, M3 U)
LM258ADGKR.B	Active	Production	VSSOP (DGK) 8	2500 LARGE T&R	Yes	NIPDAU	Level-1-260C-UNLIM	-25 to 85	(M3L, M3P, M3S, M3 U)
LM258ADR	Active	Production	SOIC (D) 8	2500 LARGE T&R	Yes	NIPDAU	Level-1-260C-UNLIM	-25 to 85	LM258A
LM258ADR.A	Active	Production	SOIC (D) 8	2500 LARGE T&R	Yes	NIPDAU	Level-1-260C-UNLIM	-25 to 85	LM258A
LM258ADR.B	Active	Production	SOIC (D) 8	2500 LARGE T&R	Yes	NIPDAU	Level-1-260C-UNLIM	-25 to 85	LM258A
LM258ADRG4	Active	Production	SOIC (D) 8	2500 LARGE T&R	Yes	NIPDAU	Level-1-260C-UNLIM	-25 to 85	LM258A
LM258ADRG4.A	Active	Production	SOIC (D) 8	2500 LARGE T&R	Yes	NIPDAU	Level-1-260C-UNLIM	-25 to 85	LM258A
LM258ADRG4.B	Active	Production	SOIC (D) 8	2500 LARGE T&R	Yes	NIPDAU	Level-1-260C-UNLIM	-25 to 85	LM258A
LM258AP	Active	Production	PDIP (P) 8	50 TUBE	Yes	NIPDAU	N/A for Pkg Type	-25 to 85	LM258AP
LM258AP.A	Active	Production	PDIP (P) 8	50 TUBE	Yes	NIPDAU	N/A for Pkg Type	-25 to 85	LM258AP
LM258AP.B	Active	Production	PDIP (P) 8	50 TUBE	Yes	NIPDAU	N/A for Pkg Type	-25 to 85	LM258AP
LM258APE4	Active	Production	PDIP (P) 8	50 TUBE	Yes	NIPDAU	N/A for Pkg Type	-25 to 85	LM258AP
LM258APE4.A	Active	Production	PDIP (P) 8	50 TUBE	Yes	NIPDAU	N/A for Pkg Type	-25 to 85	LM258AP
LM258APE4.B	Active	Production	PDIP (P) 8	50 TUBE	Yes	NIPDAU	N/A for Pkg Type	-25 to 85	LM258AP
LM258DGKR	Active	Production	VSSOP (DGK) 8	2500 LARGE T&R	Yes	SN	Level-1-260C-UNLIM	-25 to 85	(M2L, M2P, M2S, M2 U)
LM258DGKR.A	Active	Production	VSSOP (DGK) 8	2500 LARGE T&R	Yes	SN	Level-1-260C-UNLIM	-25 to 85	(M2L, M2P, M2S, M2 U)
LM258DGKR.B	Active	Production	VSSOP (DGK) 8	2500 LARGE T&R	Yes	SN	Level-1-260C-UNLIM	-25 to 85	(M2L, M2P, M2S, M2 U)
LM258DR	Active	Production	SOIC (D) 8	2500 LARGE T&R	Yes	NIPDAU	Level-1-260C-UNLIM	-25 to 85	LM258
LM258DR.A	Active	Production	SOIC (D) 8	2500 LARGE T&R	Yes	NIPDAU	Level-1-260C-UNLIM	-25 to 85	LM258
LM258DR.B	Active	Production	SOIC (D) 8	2500 LARGE T&R	Yes	NIPDAU	Level-1-260C-UNLIM	-25 to 85	LM258
LM258DRG3	Obsolete	Production	SOIC (D) 8	-	-	Call TI	Call TI	-25 to 85	LM258
LM258DRG4	Active	Production	SOIC (D) 8	2500 LARGE T&R	Yes	NIPDAU	Level-1-260C-UNLIM	-25 to 85	LM258
LM258DRG4.A	Active	Production	SOIC (D) 8	2500 LARGE T&R	Yes	NIPDAU	Level-1-260C-UNLIM	-25 to 85	LM258

Orderable part number	Status (1)	Material type (2)	Package Pins	Package qty Carrier	RoHS (3)	Lead finish/ Ball material (4)	MSL rating/ Peak reflow (5)	Op temp (°C)	Part marking (6)
LM258DRG4.B	Active	Production	SOIC (D) 8	2500 LARGE T&R	Yes	NIPDAU	Level-1-260C-UNLIM	-25 to 85	LM258
LM258P	Active	Production	PDIP (P) 8	50 TUBE	Yes	NIPDAU SN	N/A for Pkg Type	-25 to 85	LM258P
LM258P.A	Active	Production	PDIP (P) 8	50 TUBE	Yes	NIPDAU	N/A for Pkg Type	-25 to 85	LM258P
LM258P.B	Active	Production	PDIP (P) 8	50 TUBE	Yes	NIPDAU	N/A for Pkg Type	-25 to 85	LM258P
LM258PE4	Active	Production	PDIP (P) 8	50 TUBE	Yes	NIPDAU	N/A for Pkg Type	-25 to 85	LM258P
LM258PE4.B	Active	Production	PDIP (P) 8	50 TUBE	Yes	NIPDAU	N/A for Pkg Type	-25 to 85	LM258P
LM2904AVQDR	Active	Production	SOIC (D) 8	2500 LARGE T&R	Yes	NIPDAU	Level-1-260C-UNLIM	-40 to 125	L2904AV
LM2904AVQDR.A	Active	Production	SOIC (D) 8	2500 LARGE T&R	Yes	NIPDAU	Level-1-260C-UNLIM	-40 to 125	L2904AV
LM2904AVQDR.B	Active	Production	SOIC (D) 8	2500 LARGE T&R	Yes	NIPDAU	Level-1-260C-UNLIM	-40 to 125	L2904AV
LM2904AVQDRG4	Active	Production	SOIC (D) 8	2500 LARGE T&R	Yes	NIPDAU	Level-1-260C-UNLIM	-40 to 125	L2904AV
LM2904AVQDRG4.A	Active	Production	SOIC (D) 8	2500 LARGE T&R	Yes	NIPDAU	Level-1-260C-UNLIM	-40 to 125	L2904AV
LM2904AVQDRG4.B	Active	Production	SOIC (D) 8	2500 LARGE T&R	Yes	NIPDAU	Level-1-260C-UNLIM	-40 to 125	L2904AV
LM2904AVQPWR	Active	Production	TSSOP (PW) 8	2000 LARGE T&R	Yes	NIPDAU	Level-1-260C-UNLIM	-40 to 125	L2904AV
LM2904AVQPWR.A	Active	Production	TSSOP (PW) 8	2000 LARGE T&R	Yes	NIPDAU	Level-1-260C-UNLIM	-40 to 125	L2904AV
LM2904AVQPWR.B	Active	Production	TSSOP (PW) 8	2000 LARGE T&R	Yes	NIPDAU	Level-1-260C-UNLIM	-40 to 125	L2904AV
LM2904AVQPWRG4	Active	Production	TSSOP (PW) 8	2000 LARGE T&R	Yes	NIPDAU	Level-1-260C-UNLIM	-40 to 125	L2904AV
LM2904AVQPWRG4.A	Active	Production	TSSOP (PW) 8	2000 LARGE T&R	Yes	NIPDAU	Level-1-260C-UNLIM	-40 to 125	L2904AV
LM2904AVQPWRG4.B	Active	Production	TSSOP (PW) 8	2000 LARGE T&R	Yes	NIPDAU	Level-1-260C-UNLIM	-40 to 125	L2904AV
LM2904BAIDDFR	Active	Production	SOT-23-THIN (DDF) 8	3000 LARGE T&R	Yes	NIPDAU	Level-1-260C-UNLIM	-40 to 125	2904A
LM2904BAIDDFR.A	Active	Production	SOT-23-THIN (DDF) 8	3000 LARGE T&R	Yes	NIPDAU	Level-1-260C-UNLIM	-40 to 125	2904A
LM2904BAIDDFR.B	Active	Production	SOT-23-THIN (DDF) 8	3000 LARGE T&R	Yes	NIPDAU	Level-1-260C-UNLIM	-40 to 125	2904A
LM2904BAIDGKR	Active	Production	VSSOP (DGK) 8	2500 LARGE T&R	Yes	SN	Level-1-260C-UNLIM	-40 to 125	28CB
LM2904BAIDGKR.A	Active	Production	VSSOP (DGK) 8	2500 LARGE T&R	Yes	SN	Level-1-260C-UNLIM	-40 to 125	28CB
LM2904BAIDGKR.B	Active	Production	VSSOP (DGK) 8	2500 LARGE T&R	Yes	SN	Level-1-260C-UNLIM	-40 to 125	28CB
LM2904BAIDR	Active	Production	SOIC (D) 8	2500 LARGE T&R	Yes	NIPDAU	Level-1-260C-UNLIM	-40 to 125	2904BA
LM2904BAIDR.A	Active	Production	SOIC (D) 8	2500 LARGE T&R	Yes	NIPDAU	Level-1-260C-UNLIM	-40 to 125	2904BA
LM2904BAIDR.B	Active	Production	SOIC (D) 8	2500 LARGE T&R	Yes	NIPDAU	Level-1-260C-UNLIM	-40 to 125	2904BA
LM2904BAIPWR	Active	Production	TSSOP (PW) 8	2000 LARGE T&R	Yes	NIPDAU	Level-1-260C-UNLIM	-40 to 125	2904BA
LM2904BAIPWR.A	Active	Production	TSSOP (PW) 8	2000 LARGE T&R	Yes	NIPDAU	Level-1-260C-UNLIM	-40 to 125	2904BA
LM2904BAIPWR.B	Active	Production	TSSOP (PW) 8	2000 LARGE T&R	Yes	NIPDAU	Level-1-260C-UNLIM	-40 to 125	2904BA
LM2904BIDDFR	Active	Production	SOT-23-THIN (DDF) 8	3000 LARGE T&R	Yes	NIPDAU	Level-1-260C-UNLIM	-40 to 125	L2904

Orderable part number	Status (1)	Material type (2)	Package Pins	Package qty Carrier	RoHS (3)	Lead finish/ Ball material (4)	MSL rating/ Peak reflow (5)	Op temp (°C)	Part marking (6)
LM2904BIDDFR.A	Active	Production	SOT-23-THIN (DDF) 8	3000 LARGE T&R	Yes	NIPDAU	Level-1-260C-UNLIM	-40 to 125	L2904
LM2904BIDDFR.B	Active	Production	SOT-23-THIN (DDF) 8	3000 LARGE T&R	Yes	NIPDAU	Level-1-260C-UNLIM	-40 to 125	L2904
LM2904BIDGKR	Active	Production	VSSOP (DGK) 8	2500 LARGE T&R	Yes	NIPDAU SN	Level-1-260C-UNLIM	-40 to 125	28BB
LM2904BIDGKR.A	Active	Production	VSSOP (DGK) 8	2500 LARGE T&R	Yes	NIPDAU	Level-1-260C-UNLIM	-40 to 125	28BB
LM2904BIDGKR.B	Active	Production	VSSOP (DGK) 8	2500 LARGE T&R	Yes	NIPDAU	Level-1-260C-UNLIM	-40 to 125	28BB
LM2904BIDR	Active	Production	SOIC (D) 8	2500 LARGE T&R	Yes	NIPDAU	Level-1-260C-UNLIM	-40 to 125	L2904B
LM2904BIDR.A	Active	Production	SOIC (D) 8	2500 LARGE T&R	Yes	NIPDAU	Level-1-260C-UNLIM	-40 to 125	L2904B
LM2904BIDR.B	Active	Production	SOIC (D) 8	2500 LARGE T&R	Yes	NIPDAU	Level-1-260C-UNLIM	-40 to 125	L2904B
LM2904BIDRG4	Active	Production	SOIC (D) 8	2500 LARGE T&R	Yes	NIPDAU	Level-1-260C-UNLIM	-40 to 125	L2904B
LM2904BIDRG4.A	Active	Production	SOIC (D) 8	2500 LARGE T&R	Yes	NIPDAU	Level-1-260C-UNLIM	-40 to 125	L2904B
LM2904BIDRG4.B	Active	Production	SOIC (D) 8	2500 LARGE T&R	Yes	NIPDAU	Level-1-260C-UNLIM	-40 to 125	L2904B
LM2904BIPWR	Active	Production	TSSOP (PW) 8	2000 LARGE T&R	Yes	NIPDAU	Level-1-260C-UNLIM	-40 to 125	L2904B
LM2904BIPWR.A	Active	Production	TSSOP (PW) 8	2000 LARGE T&R	Yes	NIPDAU	Level-1-260C-UNLIM	-40 to 125	L2904B
LM2904BIPWR.B	Active	Production	TSSOP (PW) 8	2000 LARGE T&R	Yes	NIPDAU	Level-1-260C-UNLIM	-40 to 125	L2904B
LM2904DE4	NRND	Production	null (null)	75 TUBE	-	Call TI	Call TI	-40 to 125	
LM2904DGKR	Active	Production	VSSOP (DGK) 8	2500 LARGE T&R	Yes	SN	Level-1-260C-UNLIM	-40 to 125	(MBL, MBP, MBS, MB U)
LM2904DGKR.A	Active	Production	VSSOP (DGK) 8	2500 LARGE T&R	Yes	SN	Level-1-260C-UNLIM	-40 to 125	(MBL, MBP, MBS, MB U)
LM2904DGKR.B	Active	Production	VSSOP (DGK) 8	2500 LARGE T&R	Yes	SN	Level-1-260C-UNLIM	-40 to 125	(MBL, MBP, MBS, MB U)
LM2904DR	Active	Production	SOIC (D) 8	2500 LARGE T&R	Yes	NIPDAU	Level-1-260C-UNLIM	-40 to 125	LM2904
LM2904DR.A	Active	Production	SOIC (D) 8	2500 LARGE T&R	Yes	NIPDAU	Level-1-260C-UNLIM	-40 to 125	LM2904
LM2904DR.B	Active	Production	SOIC (D) 8	2500 LARGE T&R	Yes	NIPDAU	Level-1-260C-UNLIM	-40 to 125	LM2904
LM2904DRG3	Obsolete	Production	SOIC (D) 8	-	-	Call TI	Call TI	-40 to 125	LM2904
LM2904DRG4	Obsolete	Production	SOIC (D) 8	-	-	Call TI	Call TI	-40 to 125	LM2904
LM2904P	Active	Production	PDIP (P) 8	50 TUBE	Yes	NIPDAU	N/A for Pkg Type	-40 to 125	LM2904P
LM2904P.A	Active	Production	PDIP (P) 8	50 TUBE	Yes	NIPDAU	N/A for Pkg Type	-40 to 125	LM2904P
LM2904P.B	Active	Production	PDIP (P) 8	50 TUBE	Yes	NIPDAU	N/A for Pkg Type	-40 to 125	LM2904P
LM2904PE4	Active	Production	PDIP (P) 8	50 TUBE	Yes	NIPDAU	N/A for Pkg Type	-40 to 125	LM2904P
LM2904PE4.A	Active	Production	PDIP (P) 8	50 TUBE	Yes	NIPDAU	N/A for Pkg Type	-40 to 125	LM2904P

Orderable part number	Status (1)	Material type (2)	Package Pins	Package qty Carrier	RoHS (3)	Lead finish/ Ball material (4)	MSL rating/ Peak reflow (5)	Op temp (°C)	Part marking (6)
LM2904PE4.B	Active	Production	PDIP (P) 8	50 TUBE	Yes	NIPDAU	N/A for Pkg Type	-40 to 125	LM2904P
LM2904PSR	Active	Production	SO (PS) 8	2000 LARGE T&R	Yes	NIPDAU	Level-1-260C-UNLIM	-40 to 125	L2904
LM2904PSR.A	Active	Production	SO (PS) 8	2000 LARGE T&R	Yes	NIPDAU	Level-1-260C-UNLIM	-40 to 125	L2904
LM2904PW	Obsolete	Production	TSSOP (PW) 8	-	-	Call TI	Call TI	-40 to 125	L2904
LM2904PWR	Active	Production	TSSOP (PW) 8	2000 LARGE T&R	Yes	NIPDAU SN	Level-1-260C-UNLIM	-40 to 125	L2904
LM2904PWR.A	Active	Production	TSSOP (PW) 8	2000 LARGE T&R	Yes	NIPDAU	Level-1-260C-UNLIM	-40 to 125	L2904
LM2904PWRG3	Obsolete	Production	TSSOP (PW) 8	-	-	Call TI	Call TI	-40 to 125	L2904
LM2904PWRG4-JF	Obsolete	Production	TSSOP (PW) 8	-	-	Call TI	Call TI	-40 to 125	L2904
LM2904QDR	Active	Production	SOIC (D) 8	2500 LARGE T&R	Yes	NIPDAU	Level-1-260C-UNLIM	-40 to 125	2904Q1
LM2904QDR.A	Active	Production	SOIC (D) 8	2500 LARGE T&R	Yes	NIPDAU	Level-1-260C-UNLIM	-40 to 125	2904Q1
LM2904QDR.B	Active	Production	SOIC (D) 8	2500 LARGE T&R	Yes	NIPDAU	Level-1-260C-UNLIM	-40 to 125	2904Q1
LM2904QDRG4	Obsolete	Production	SOIC (D) 8	-	-	Call TI	Call TI	-40 to 125	
LM2904VQDR	Active	Production	SOIC (D) 8	2500 LARGE T&R	Yes	NIPDAU	Level-1-260C-UNLIM	-40 to 125	L2904V
LM2904VQDR.A	Active	Production	SOIC (D) 8	2500 LARGE T&R	Yes	NIPDAU	Level-1-260C-UNLIM	-40 to 125	L2904V
LM2904VQDR.B	Active	Production	SOIC (D) 8	2500 LARGE T&R	Yes	NIPDAU	Level-1-260C-UNLIM	-40 to 125	L2904V
LM2904VQDRG4	Active	Production	SOIC (D) 8	2500 LARGE T&R	Yes	NIPDAU	Level-1-260C-UNLIM	-40 to 125	L2904V
LM2904VQDRG4.A	Active	Production	SOIC (D) 8	2500 LARGE T&R	Yes	NIPDAU	Level-1-260C-UNLIM	-40 to 125	L2904V
LM2904VQDRG4.B	Active	Production	SOIC (D) 8	2500 LARGE T&R	Yes	NIPDAU	Level-1-260C-UNLIM	-40 to 125	L2904V
LM2904VQPWR	Active	Production	TSSOP (PW) 8	2000 LARGE T&R	Yes	NIPDAU	Level-1-260C-UNLIM	-40 to 125	L2904V
LM2904VQPWR.A	Active	Production	TSSOP (PW) 8	2000 LARGE T&R	Yes	NIPDAU	Level-1-260C-UNLIM	-40 to 125	L2904V
LM2904VQPWR.B	Active	Production	TSSOP (PW) 8	2000 LARGE T&R	Yes	NIPDAU	Level-1-260C-UNLIM	-40 to 125	L2904V
LM2904VQPWRG4	Active	Production	TSSOP (PW) 8	2000 LARGE T&R	Yes	NIPDAU	Level-1-260C-UNLIM	-40 to 125	L2904V
LM2904VQPWRG4.A	Active	Production	TSSOP (PW) 8	2000 LARGE T&R	Yes	NIPDAU	Level-1-260C-UNLIM	-40 to 125	L2904V
LM2904VQPWRG4.B	Active	Production	TSSOP (PW) 8	2000 LARGE T&R	Yes	NIPDAU	Level-1-260C-UNLIM	-40 to 125	L2904V
LM358ADE4	NRND	Production	null (null)	75 TUBE	-	Call TI	Call TI	0 to 70	
LM358ADGKR	Active	Production	VSSOP (DGK) 8	2500 LARGE T&R	Yes	SN	Level-1-260C-UNLIM	0 to 70	(M6L, M6P, M6S, M6U)
LM358ADGKR.A	Active	Production	VSSOP (DGK) 8	2500 LARGE T&R	Yes	SN	Level-1-260C-UNLIM	0 to 70	(M6L, M6P, M6S, M6U)
LM358ADGKR.B	Active	Production	VSSOP (DGK) 8	2500 LARGE T&R	Yes	SN	Level-1-260C-UNLIM	0 to 70	(M6L, M6P, M6S, M6U)

Orderable part number	Status (1)	Material type (2)	Package Pins	Package qty Carrier	RoHS (3)	Lead finish/ Ball material (4)	MSL rating/ Peak reflow (5)	Op temp (°C)	Part marking (6)
LM358ADR	Active	Production	SOIC (D) 8	2500 LARGE T&R	Yes	NIPDAU SN	Level-1-260C-UNLIM	0 to 70	LM358A
LM358ADR.A	Active	Production	SOIC (D) 8	2500 LARGE T&R	Yes	NIPDAU	Level-1-260C-UNLIM	0 to 70	LM358A
LM358ADR.B	Active	Production	SOIC (D) 8	2500 LARGE T&R	Yes	NIPDAU	Level-1-260C-UNLIM	0 to 70	LM358A
LM358AP	Active	Production	PDIP (P) 8	50 TUBE	Yes	NIPDAU	N/A for Pkg Type	0 to 70	LM358AP
LM358AP.B	Active	Production	PDIP (P) 8	50 TUBE	Yes	NIPDAU	N/A for Pkg Type	0 to 70	LM358AP
LM358APE4	Active	Production	PDIP (P) 8	50 TUBE	Yes	NIPDAU	N/A for Pkg Type	0 to 70	LM358AP
LM358APE4.A	Active	Production	PDIP (P) 8	50 TUBE	Yes	NIPDAU	N/A for Pkg Type	0 to 70	LM358AP
LM358APE4.B	Active	Production	PDIP (P) 8	50 TUBE	Yes	NIPDAU	N/A for Pkg Type	0 to 70	LM358AP
LM358APW	Obsolete	Production	TSSOP (PW) 8	-	-	Call TI	Call TI	0 to 70	L358A
LM358APWR	Active	Production	TSSOP (PW) 8	2000 LARGE T&R	Yes	NIPDAU SN	Level-1-260C-UNLIM	0 to 70	L358A
LM358APWR.A	Active	Production	TSSOP (PW) 8	2000 LARGE T&R	Yes	NIPDAU	Level-1-260C-UNLIM	0 to 70	L358A
LM358BAIDDFR	Active	Production	SOT-23-THIN (DDF) 8	3000 LARGE T&R	Yes	NIPDAU	Level-1-260C-UNLIM	-40 to 85	358BA
LM358BAIDDFR.A	Active	Production	SOT-23-THIN (DDF) 8	3000 LARGE T&R	Yes	NIPDAU	Level-1-260C-UNLIM	-40 to 85	358BA
LM358BAIDDFR.B	Active	Production	SOT-23-THIN (DDF) 8	3000 LARGE T&R	Yes	NIPDAU	Level-1-260C-UNLIM	-40 to 85	358BA
LM358BAIDDFRG4	Active	Production	SOT-23-THIN (DDF) 8	3000 LARGE T&R	Yes	NIPDAU	Level-1-260C-UNLIM	-40 to 85	358BA
LM358BAIDDFRG4.A	Active	Production	SOT-23-THIN (DDF) 8	3000 LARGE T&R	Yes	NIPDAU	Level-1-260C-UNLIM	-40 to 85	358BA
LM358BAIDDFRG4.B	Active	Production	SOT-23-THIN (DDF) 8	3000 LARGE T&R	Yes	NIPDAU	Level-1-260C-UNLIM	-40 to 85	358BA
LM358BAIDGKR	Active	Production	VSSOP (DGK) 8	2500 LARGE T&R	Yes	SN	Level-1-260C-UNLIM	-40 to 85	28DB
LM358BAIDGKR.B	Active	Production	VSSOP (DGK) 8	2500 LARGE T&R	Yes	SN	Level-1-260C-UNLIM	-40 to 85	28DB
LM358BAIDR	Active	Production	SOIC (D) 8	2500 LARGE T&R	Yes	NIPDAU	Level-1-260C-UNLIM	-40 to 85	L358BA
LM358BAIDR.A	Active	Production	SOIC (D) 8	2500 LARGE T&R	Yes	NIPDAU	Level-1-260C-UNLIM	-40 to 85	L358BA
LM358BAIDR.B	Active	Production	SOIC (D) 8	2500 LARGE T&R	Yes	NIPDAU	Level-1-260C-UNLIM	-40 to 85	L358BA
LM358BAIDRG4	Active	Production	SOIC (D) 8	2500 LARGE T&R	Yes	NIPDAU	Level-1-260C-UNLIM	-40 to 85	L358BA
LM358BAIDRG4.A	Active	Production	SOIC (D) 8	2500 LARGE T&R	Yes	NIPDAU	Level-1-260C-UNLIM	-40 to 85	L358BA
LM358BAIDRG4.B	Active	Production	SOIC (D) 8	2500 LARGE T&R	Yes	NIPDAU	Level-1-260C-UNLIM	-40 to 85	L358BA
LM358BAIPWR	Active	Production	TSSOP (PW) 8	2000 LARGE T&R	Yes	NIPDAU	Level-1-260C-UNLIM	-40 to 85	L358BA
LM358BAIPWR.A	Active	Production	TSSOP (PW) 8	2000 LARGE T&R	Yes	NIPDAU	Level-1-260C-UNLIM	-40 to 85	L358BA
LM358BAIPWR.B	Active	Production	TSSOP (PW) 8	2000 LARGE T&R	Yes	NIPDAU	Level-1-260C-UNLIM	-40 to 85	L358BA
LM358BIDDFR	Active	Production	SOT-23-THIN (DDF) 8	3000 LARGE T&R	Yes	NIPDAU	Level-1-260C-UNLIM	-40 to 85	LM358
LM358BIDDFR.B	Active	Production	SOT-23-THIN (DDF) 8	3000 LARGE T&R	Yes	NIPDAU	Level-1-260C-UNLIM	-40 to 85	LM358
LM358BIDGKR	Active	Production	VSSOP (DGK) 8	2500 LARGE T&R	Yes	NIPDAU SN	Level-1-260C-UNLIM	-40 to 85	(1TKR, 358B)

Orderable part number	Status (1)	Material type (2)	Package Pins	Package qty Carrier	RoHS (3)	Lead finish/ Ball material (4)	MSL rating/ Peak reflow (5)	Op temp (°C)	Part marking (6)
LM358BIDGKR.A	Active	Production	VSSOP (DGK) 8	2500 LARGE T&R	Yes	NIPDAU	Level-1-260C-UNLIM	-40 to 85	(1TKR, 358B)
LM358BIDGKR.B	Active	Production	VSSOP (DGK) 8	2500 LARGE T&R	Yes	NIPDAU	Level-1-260C-UNLIM	-40 to 85	(1TKR, 358B)
LM358BIDR	Active	Production	SOIC (D) 8	2500 LARGE T&R	Yes	NIPDAU	Level-1-260C-UNLIM	-40 to 85	LM358B
LM358BIDR.A	Active	Production	SOIC (D) 8	2500 LARGE T&R	Yes	NIPDAU	Level-1-260C-UNLIM	-40 to 85	LM358B
LM358BIDR.B	Active	Production	SOIC (D) 8	2500 LARGE T&R	Yes	NIPDAU	Level-1-260C-UNLIM	-40 to 85	LM358B
LM358BIDRG4	Active	Production	SOIC (D) 8	2500 LARGE T&R	Yes	NIPDAU	Level-1-260C-UNLIM	-40 to 85	LM358B
LM358BIDRG4.A	Active	Production	SOIC (D) 8	2500 LARGE T&R	Yes	NIPDAU	Level-1-260C-UNLIM	-40 to 85	LM358B
LM358BIDRG4.B	Active	Production	SOIC (D) 8	2500 LARGE T&R	Yes	NIPDAU	Level-1-260C-UNLIM	-40 to 85	LM358B
LM358BIPWR	Active	Production	TSSOP (PW) 8	2000 LARGE T&R	Yes	NIPDAU	Level-1-260C-UNLIM	-40 to 85	LM358B
LM358BIPWR.A	Active	Production	TSSOP (PW) 8	2000 LARGE T&R	Yes	NIPDAU	Level-1-260C-UNLIM	-40 to 85	LM358B
LM358BIPWR.B	Active	Production	TSSOP (PW) 8	2000 LARGE T&R	Yes	NIPDAU	Level-1-260C-UNLIM	-40 to 85	LM358B
LM358BIPWRG4	Active	Production	TSSOP (PW) 8	2000 LARGE T&R	Yes	NIPDAU	Level-1-260C-UNLIM	-40 to 85	LM358B
LM358BIPWRG4.A	Active	Production	TSSOP (PW) 8	2000 LARGE T&R	Yes	NIPDAU	Level-1-260C-UNLIM	-40 to 85	LM358B
LM358BIPWRG4.B	Active	Production	TSSOP (PW) 8	2000 LARGE T&R	Yes	NIPDAU	Level-1-260C-UNLIM	-40 to 85	LM358B
LM358D	Obsolete	Production	SOIC (D) 8	-	-	Call TI	Call TI	0 to 70	LM358
LM358DGKR	Active	Production	VSSOP (DGK) 8	2500 LARGE T&R	Yes	SN	Level-1-260C-UNLIM	0 to 70	(M5L, M5P, M5S, M5U)
LM358DGKR.B	Active	Production	VSSOP (DGK) 8	2500 LARGE T&R	Yes	SN	Level-1-260C-UNLIM	0 to 70	(M5L, M5P, M5S, M5U)
LM358DR	Active	Production	SOIC (D) 8	2500 LARGE T&R	Yes	NIPDAU	Level-1-260C-UNLIM	0 to 70	LM358
LM358DR.A	Active	Production	SOIC (D) 8	2500 LARGE T&R	Yes	NIPDAU	Level-1-260C-UNLIM	0 to 70	LM358
LM358DR.B	Active	Production	SOIC (D) 8	2500 LARGE T&R	Yes	NIPDAU	Level-1-260C-UNLIM	0 to 70	LM358
LM358DRG3	Obsolete	Production	SOIC (D) 8	-	-	Call TI	Call TI	0 to 70	LM358
LM358DRG4	Obsolete	Production	SOIC (D) 8	-	-	Call TI	Call TI	0 to 70	LM358
LM358P	Active	Production	PDIP (P) 8	50 TUBE	Yes	NIPDAU	N/A for Pkg Type	0 to 70	LM358P
LM358P.A	Active	Production	PDIP (P) 8	50 TUBE	Yes	NIPDAU	N/A for Pkg Type	0 to 70	LM358P
LM358P.B	Active	Production	PDIP (P) 8	50 TUBE	Yes	NIPDAU	N/A for Pkg Type	0 to 70	LM358P
LM358PE3	Obsolete	Production	PDIP (P) 8	-	-	Call TI	Call TI	0 to 70	LM358P
LM358PE4	Active	Production	PDIP (P) 8	50 TUBE	Yes	NIPDAU	N/A for Pkg Type	0 to 70	LM358P
LM358PE4.A	Active	Production	PDIP (P) 8	50 TUBE	Yes	NIPDAU	N/A for Pkg Type	0 to 70	LM358P
LM358PE4.B	Active	Production	PDIP (P) 8	50 TUBE	Yes	NIPDAU	N/A for Pkg Type	0 to 70	LM358P

Orderable part number	Status (1)	Material type (2)	Package Pins	Package qty Carrier	RoHS (3)	Lead finish/ Ball material (4)	MSL rating/ Peak reflow (5)	Op temp (°C)	Part marking (6)
LM358PSR	Active	Production	SO (PS) 8	2000 LARGE T&R	Yes	NIPDAU	Level-1-260C-UNLIM	0 to 70	L358
LM358PSR.A	Active	Production	SO (PS) 8	2000 LARGE T&R	Yes	NIPDAU	Level-1-260C-UNLIM	0 to 70	L358
LM358PW	Obsolete	Production	TSSOP (PW) 8	-	-	Call TI	Call TI	0 to 70	L358
LM358PWR	Active	Production	TSSOP (PW) 8	2000 LARGE T&R	Yes	NIPDAU SN	Level-1-260C-UNLIM	0 to 70	L358
LM358PWR.A	Active	Production	TSSOP (PW) 8	2000 LARGE T&R	Yes	NIPDAU	Level-1-260C-UNLIM	0 to 70	L358
LM358PWRG3	Obsolete	Production	TSSOP (PW) 8	-	-	Call TI	Call TI	0 to 70	L358
LM358PWRG4-JF	Obsolete	Production	TSSOP (PW) 8	-	-	Call TI	Call TI	0 to 70	L358

(1) **Status:** For more details on status, see our [product life cycle](#).

(2) **Material type:** When designated, preproduction parts are prototypes/experimental devices, and are not yet approved or released for full production. Testing and final process, including without limitation quality assurance, reliability performance testing, and/or process qualification, may not yet be complete, and this item is subject to further changes or possible discontinuation. If available for ordering, purchases will be subject to an additional waiver at checkout, and are intended for early internal evaluation purposes only. These items are sold without warranties of any kind.

(3) **RoHS values:** Yes, No, RoHS Exempt. See the [TI RoHS Statement](#) for additional information and value definition.

(4) **Lead finish/Ball material:** Parts may have multiple material finish options. Finish options are separated by a vertical ruled line. Lead finish/Ball material values may wrap to two lines if the finish value exceeds the maximum column width.

(5) **MSL rating/Peak reflow:** The moisture sensitivity level ratings and peak solder (reflow) temperatures. In the event that a part has multiple moisture sensitivity ratings, only the lowest level per JEDEC standards is shown. Refer to the shipping label for the actual reflow temperature that will be used to mount the part to the printed circuit board.

(6) **Part marking:** There may be an additional marking, which relates to the logo, the lot trace code information, or the environmental category of the part.

Multiple part markings will be inside parentheses. Only one part marking contained in parentheses and separated by a "-" will appear on a part. If a line is indented then it is a continuation of the previous line and the two combined represent the entire part marking for that device.

Important Information and Disclaimer: The information provided on this page represents TI's knowledge and belief as of the date that it is provided. TI bases its knowledge and belief on information provided by third parties, and makes no representation or warranty as to the accuracy of such information. Efforts are underway to better integrate information from third parties. TI has taken and continues to take reasonable steps to provide representative and accurate information but may not have conducted destructive testing or chemical analysis on incoming materials and chemicals. TI and TI suppliers consider certain information to be proprietary, and thus CAS numbers and other limited information may not be available for release.

In no event shall TI's liability arising out of such information exceed the total purchase price of the TI part(s) at issue in this document sold by TI to Customer on an annual basis.

OTHER QUALIFIED VERSIONS OF LM258A, LM2904, LM2904B, LM2904BA :

- Automotive : [LM2904-Q1](#), [LM2904B-Q1](#), [LM2904BA-Q1](#)
- Enhanced Product : [LM258A-EP](#), [LM2904-EP](#)

NOTE: Qualified Version Definitions:

- Automotive - Q100 devices qualified for high-reliability automotive applications targeting zero defects
- Enhanced Product - Supports Defense, Aerospace and Medical Applications

TAPE AND REEL INFORMATION



QUADRANT ASSIGNMENTS FOR PIN 1 ORIENTATION IN TAPE



*All dimensions are nominal

Device	Package Type	Package Drawing	Pins	SPQ	Reel Diameter (mm)	Reel Width W1 (mm)	A0 (mm)	B0 (mm)	K0 (mm)	P1 (mm)	W (mm)	Pin1 Quadrant
LM258ADGKR	VSSOP	DGK	8	2500	330.0	12.4	5.3	3.4	1.4	8.0	12.0	Q1
LM258ADGKR	VSSOP	DGK	8	2500	330.0	12.4	5.25	3.35	1.25	8.0	12.0	Q1
LM258ADGKR	VSSOP	DGK	8	2500	330.0	12.4	5.3	3.4	1.4	8.0	12.0	Q1
LM258ADR	SOIC	D	8	2500	330.0	12.4	6.4	5.2	2.1	8.0	12.0	Q1
LM258ADR	SOIC	D	8	2500	330.0	12.4	6.4	5.2	2.1	8.0	12.0	Q1
LM258ADRG4	SOIC	D	8	2500	330.0	12.4	6.4	5.2	2.1	8.0	12.0	Q1
LM258ADRG4	SOIC	D	8	2500	330.0	12.4	6.4	5.2	2.1	8.0	12.0	Q1
LM258DGKR	VSSOP	DGK	8	2500	330.0	12.4	5.25	3.35	1.25	8.0	12.0	Q1
LM258DGKR	VSSOP	DGK	8	2500	330.0	12.4	5.3	3.4	1.4	8.0	12.0	Q1
LM258DR	SOIC	D	8	2500	330.0	12.4	6.4	5.2	2.1	8.0	12.0	Q1
LM258DR	SOIC	D	8	2500	330.0	12.4	6.4	5.2	2.1	8.0	12.0	Q1
LM258DR	SOIC	D	8	2500	330.0	12.4	6.4	5.2	2.1	8.0	12.0	Q1
LM258DRG4	SOIC	D	8	2500	330.0	12.4	6.4	5.2	2.1	8.0	12.0	Q1
LM258DRG4	SOIC	D	8	2500	330.0	12.4	6.4	5.2	2.1	8.0	12.0	Q1
LM2904AVQDR	SOIC	D	8	2500	330.0	12.5	6.4	5.2	2.1	8.0	12.0	Q1
LM2904AVQDR	SOIC	D	8	2500	330.0	12.4	6.4	5.2	2.1	8.0	12.0	Q1

Device	Package Type	Package Drawing	Pins	SPQ	Reel Diameter (mm)	Reel Width W1 (mm)	A0 (mm)	B0 (mm)	K0 (mm)	P1 (mm)	W (mm)	Pin1 Quadrant
LM2904AVQDRG4	SOIC	D	8	2500	330.0	12.4	6.4	5.2	2.1	8.0	12.0	Q1
LM2904AVQDRG4	SOIC	D	8	2500	330.0	12.5	6.4	5.2	2.1	8.0	12.0	Q1
LM2904AVQPWR	TSSOP	PW	8	2000	330.0	12.4	7.0	3.6	1.6	8.0	12.0	Q1
LM2904AVQPWRG4	TSSOP	PW	8	2000	330.0	12.4	7.0	3.6	1.6	8.0	12.0	Q1
LM2904BAIDDFR	SOT-23-THIN	DDF	8	3000	180.0	8.4	3.2	3.2	1.4	4.0	8.0	Q3
LM2904BAIDGKR	VSSOP	DGK	8	2500	330.0	12.4	5.25	3.35	1.25	8.0	12.0	Q1
LM2904BAIDR	SOIC	D	8	2500	330.0	12.4	6.4	5.2	2.1	8.0	12.0	Q1
LM2904BAIDR	SOIC	D	8	2500	330.0	12.4	6.4	5.2	2.1	8.0	12.0	Q1
LM2904BAIPWR	TSSOP	PW	8	2000	330.0	12.4	7.0	3.6	1.6	8.0	12.0	Q1
LM2904BIDDFR	SOT-23-THIN	DDF	8	3000	180.0	8.4	3.2	3.2	1.4	4.0	8.0	Q3
LM2904BIDGKR	VSSOP	DGK	8	2500	330.0	12.4	5.3	3.4	1.4	8.0	12.0	Q1
LM2904BIDR	SOIC	D	8	2500	330.0	12.4	6.4	5.2	2.1	8.0	12.0	Q1
LM2904BIDR	SOIC	D	8	2500	330.0	12.4	6.4	5.2	2.1	8.0	12.0	Q1
LM2904BIDR	SOIC	D	8	2500	330.0	12.4	6.4	5.2	2.1	8.0	12.0	Q1
LM2904BIPWR	TSSOP	PW	8	2000	330.0	12.4	7.0	3.6	1.6	8.0	12.0	Q1
LM2904DGKR	VSSOP	DGK	8	2500	330.0	12.4	5.3	3.4	1.4	8.0	12.0	Q1
LM2904DGKR	VSSOP	DGK	8	2500	330.0	12.4	5.25	3.35	1.25	8.0	12.0	Q1
LM2904DR	SOIC	D	8	2500	330.0	12.4	6.4	5.2	2.1	8.0	12.0	Q1
LM2904DR	SOIC	D	8	2500	330.0	12.4	6.4	5.2	2.1	8.0	12.0	Q1
LM2904DR	SOIC	D	8	2500	330.0	12.4	6.4	5.2	2.1	8.0	12.0	Q1
LM2904PSR	SO	PS	8	2000	330.0	16.4	8.35	6.6	2.4	12.0	16.0	Q1
LM2904PWR	TSSOP	PW	8	2000	330.0	12.4	7.0	3.6	1.6	8.0	12.0	Q1
LM2904QDR	SOIC	D	8	2500	330.0	12.4	6.4	5.2	2.1	8.0	12.0	Q1
LM2904VQDR	SOIC	D	8	2500	330.0	12.5	6.4	5.2	2.1	8.0	12.0	Q1
LM2904VQDRG4	SOIC	D	8	2500	330.0	12.4	6.4	5.2	2.1	8.0	12.0	Q1
LM2904VQPWR	TSSOP	PW	8	2000	330.0	12.4	7.0	3.6	1.6	8.0	12.0	Q1
LM2904VQPWRG4	TSSOP	PW	8	2000	330.0	12.4	7.0	3.6	1.6	8.0	12.0	Q1
LM358ADGKR	VSSOP	DGK	8	2500	330.0	12.4	5.25	3.35	1.25	8.0	12.0	Q1
LM358ADR	SOIC	D	8	2500	330.0	12.4	6.4	5.2	2.1	8.0	12.0	Q1
LM358ADR	SOIC	D	8	2500	330.0	12.4	6.4	5.2	2.1	8.0	12.0	Q1
LM358ADR	SOIC	D	8	2500	330.0	12.4	6.4	5.2	2.1	8.0	12.0	Q1
LM358ADR	SOIC	D	8	2500	330.0	12.4	6.4	5.2	2.1	8.0	12.0	Q1
LM358APWR	TSSOP	PW	8	2000	330.0	12.4	7.0	3.6	1.6	8.0	12.0	Q1
LM358BAIDDFR	SOT-23-THIN	DDF	8	3000	180.0	8.4	3.2	3.2	1.4	4.0	8.0	Q3
LM358BAIDDFRG4	SOT-23-THIN	DDF	8	3000	180.0	8.4	3.2	3.2	1.4	4.0	8.0	Q3
LM358BAIDGKR	VSSOP	DGK	8	2500	330.0	12.4	5.25	3.35	1.25	8.0	12.0	Q1
LM358BAIDR	SOIC	D	8	2500	330.0	12.4	6.4	5.2	2.1	8.0	12.0	Q1
LM358BAIDR	SOIC	D	8	2500	330.0	12.4	6.4	5.2	2.1	8.0	12.0	Q1

Device	Package Type	Package Drawing	Pins	SPQ	Reel Diameter (mm)	Reel Width W1 (mm)	A0 (mm)	B0 (mm)	K0 (mm)	P1 (mm)	W (mm)	Pin1 Quadrant
LM358BAIDR	SOIC	D	8	2500	330.0	12.4	6.4	5.2	2.1	8.0	12.0	Q1
LM358BAIPWR	TSSOP	PW	8	2000	330.0	12.4	7.0	3.6	1.6	8.0	12.0	Q1
LM358BIDDFR	SOT-23-THIN	DDF	8	3000	180.0	8.4	3.2	3.2	1.4	4.0	8.0	Q3
LM358BIDGKR	VSSOP	DGK	8	2500	330.0	12.4	6.4	5.2	2.1	8.0	12.0	Q1
LM358BIDR	SOIC	D	8	2500	330.0	12.4	6.4	5.2	2.1	8.0	12.0	Q1
LM358BIDR	SOIC	D	8	2500	330.0	12.4	6.4	5.2	2.1	8.0	12.0	Q1
LM358BIDR	SOIC	D	8	2500	330.0	12.4	6.4	5.2	2.1	8.0	12.0	Q1
LM358BIDRG4	SOIC	D	8	2500	330.0	12.4	6.4	5.2	2.1	8.0	12.0	Q1
LM358BIDRG4	SOIC	D	8	2500	330.0	12.4	6.4	5.2	2.1	8.0	12.0	Q1
LM358BIPWR	TSSOP	PW	8	2000	330.0	12.4	7.0	3.6	1.6	8.0	12.0	Q1
LM358BIPWRG4	TSSOP	PW	8	2000	330.0	12.4	7.0	3.6	1.6	8.0	12.0	Q1
LM358DGKR	VSSOP	DGK	8	2500	330.0	12.4	5.25	3.35	1.25	8.0	12.0	Q1
LM358DGKR	VSSOP	DGK	8	2500	330.0	12.4	5.3	3.4	1.4	8.0	12.0	Q1
LM358DR	SOIC	D	8	2500	330.0	12.4	6.4	5.2	2.1	8.0	12.0	Q1
LM358DR	SOIC	D	8	2500	330.0	12.4	6.4	5.2	2.1	8.0	12.0	Q1
LM358DR	SOIC	D	8	2500	330.0	12.4	6.4	5.2	2.1	8.0	12.0	Q1
LM358PSR	SO	PS	8	2000	330.0	16.4	8.35	6.6	2.4	12.0	16.0	Q1
LM358PWR	TSSOP	PW	8	2000	330.0	12.4	7.0	3.6	1.6	8.0	12.0	Q1

TAPE AND REEL BOX DIMENSIONS

*All dimensions are nominal

Device	Package Type	Package Drawing	Pins	SPQ	Length (mm)	Width (mm)	Height (mm)
LM258ADGKR	VSSOP	DGK	8	2500	356.0	356.0	35.0
LM258ADGKR	VSSOP	DGK	8	2500	366.0	364.0	50.0
LM258ADGKR	VSSOP	DGK	8	2500	353.0	353.0	32.0
LM258ADR	SOIC	D	8	2500	340.5	336.1	25.0
LM258ADR	SOIC	D	8	2500	353.0	353.0	32.0
LM258ADRG4	SOIC	D	8	2500	340.5	338.1	20.6
LM258ADRG4	SOIC	D	8	2500	340.5	338.1	20.6
LM258DGKR	VSSOP	DGK	8	2500	366.0	364.0	50.0
LM258DGKR	VSSOP	DGK	8	2500	356.0	356.0	35.0
LM258DR	SOIC	D	8	2500	353.0	353.0	32.0
LM258DR	SOIC	D	8	2500	340.5	338.1	20.6
LM258DR	SOIC	D	8	2500	340.5	336.1	25.0
LM258DRG4	SOIC	D	8	2500	340.5	338.1	20.6
LM258DRG4	SOIC	D	8	2500	340.5	338.1	20.6
LM2904AVQDR	SOIC	D	8	2500	353.0	353.0	32.0
LM2904AVQDR	SOIC	D	8	2500	340.5	338.1	20.6
LM2904AVQDRG4	SOIC	D	8	2500	340.5	338.1	20.6
LM2904AVQDRG4	SOIC	D	8	2500	353.0	353.0	32.0

Device	Package Type	Package Drawing	Pins	SPQ	Length (mm)	Width (mm)	Height (mm)
LM2904AVQPWR	TSSOP	PW	8	2000	353.0	353.0	32.0
LM2904AVQPWRG4	TSSOP	PW	8	2000	353.0	353.0	32.0
LM2904BAIDDFR	SOT-23-THIN	DDF	8	3000	210.0	185.0	35.0
LM2904BAIDGKR	VSSOP	DGK	8	2500	366.0	364.0	50.0
LM2904BAIDR	SOIC	D	8	2500	340.5	336.1	25.0
LM2904BAIDR	SOIC	D	8	2500	353.0	353.0	32.0
LM2904BAIPWR	TSSOP	PW	8	2000	353.0	353.0	32.0
LM2904BIDDFR	SOT-23-THIN	DDF	8	3000	210.0	185.0	35.0
LM2904BIDGKR	VSSOP	DGK	8	2500	353.0	353.0	32.0
LM2904BIDR	SOIC	D	8	2500	353.0	353.0	32.0
LM2904BIDR	SOIC	D	8	2500	353.0	353.0	32.0
LM2904BIDR	SOIC	D	8	2500	353.0	353.0	32.0
LM2904BIPWR	TSSOP	PW	8	2000	353.0	353.0	32.0
LM2904DGKR	VSSOP	DGK	8	2500	356.0	356.0	35.0
LM2904DGKR	VSSOP	DGK	8	2500	366.0	364.0	50.0
LM2904DR	SOIC	D	8	2500	353.0	353.0	32.0
LM2904DR	SOIC	D	8	2500	340.5	338.1	20.6
LM2904DR	SOIC	D	8	2500	340.5	336.1	25.0
LM2904PSR	SO	PS	8	2000	353.0	353.0	32.0
LM2904PWR	TSSOP	PW	8	2000	353.0	353.0	32.0
LM2904QDR	SOIC	D	8	2500	353.0	353.0	32.0
LM2904VQDR	SOIC	D	8	2500	353.0	353.0	32.0
LM2904VQDRG4	SOIC	D	8	2500	340.5	338.1	20.6
LM2904VQPWR	TSSOP	PW	8	2000	353.0	353.0	32.0
LM2904VQPWRG4	TSSOP	PW	8	2000	353.0	353.0	32.0
LM358ADGKR	VSSOP	DGK	8	2500	366.0	364.0	50.0
LM358ADR	SOIC	D	8	2500	353.0	353.0	32.0
LM358ADR	SOIC	D	8	2500	340.5	336.1	25.0
LM358ADR	SOIC	D	8	2500	340.5	338.1	20.6
LM358ADR	SOIC	D	8	2500	353.0	353.0	32.0
LM358APWR	TSSOP	PW	8	2000	353.0	353.0	32.0
LM358BAIDDFR	SOT-23-THIN	DDF	8	3000	210.0	185.0	35.0
LM358BAIDDFRG4	SOT-23-THIN	DDF	8	3000	210.0	185.0	35.0
LM358BAIDGKR	VSSOP	DGK	8	2500	366.0	364.0	50.0
LM358BAIDR	SOIC	D	8	2500	353.0	353.0	32.0
LM358BAIDR	SOIC	D	8	2500	353.0	353.0	32.0
LM358BAIDR	SOIC	D	8	2500	340.5	336.1	25.0
LM358BAIPWR	TSSOP	PW	8	2000	353.0	353.0	32.0
LM358BIDDFR	SOT-23-THIN	DDF	8	3000	210.0	185.0	35.0
LM358BIDGKR	VSSOP	DGK	8	2500	353.0	353.0	32.0
LM358BIDR	SOIC	D	8	2500	353.0	353.0	32.0
LM358BIDR	SOIC	D	8	2500	340.5	336.1	25.0
LM358BIDR	SOIC	D	8	2500	353.0	353.0	32.0

Device	Package Type	Package Drawing	Pins	SPQ	Length (mm)	Width (mm)	Height (mm)
LM358BIDRG4	SOIC	D	8	2500	353.0	353.0	32.0
LM358BIDRG4	SOIC	D	8	2500	340.5	336.1	25.0
LM358BIPWR	TSSOP	PW	8	2000	353.0	353.0	32.0
LM358BIPWRG4	TSSOP	PW	8	2000	353.0	353.0	32.0
LM358DGKR	VSSOP	DGK	8	2500	366.0	364.0	50.0
LM358DGKR	VSSOP	DGK	8	2500	356.0	356.0	35.0
LM358DR	SOIC	D	8	2500	353.0	353.0	32.0
LM358DR	SOIC	D	8	2500	340.5	336.1	25.0
LM358DR	SOIC	D	8	2500	340.5	338.1	20.6
LM358PSR	SO	PS	8	2000	353.0	353.0	32.0
LM358PWR	TSSOP	PW	8	2000	353.0	353.0	32.0

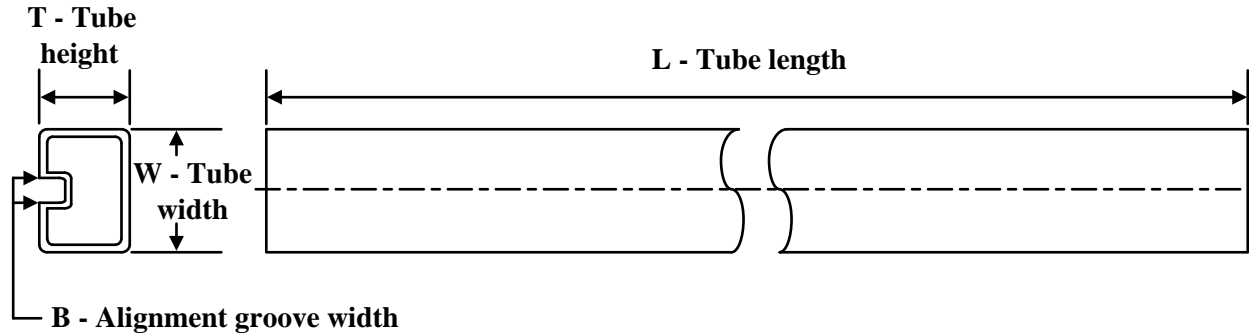
TUBE

*All dimensions are nominal

Device	Package Name	Package Type	Pins	SPQ	L (mm)	W (mm)	T (µm)	B (mm)
5962-87710012A	FK	LCCC	20	55	506.98	12.06	2030	NA
5962-87710022A	FK	LCCC	20	55	506.98	12.06	2030	NA
LM158AFKB	FK	LCCC	20	55	506.98	12.06	2030	NA
LM158AFKB.A	FK	LCCC	20	55	506.98	12.06	2030	NA
LM158FKB	FK	LCCC	20	55	506.98	12.06	2030	NA
LM158FKB.A	FK	LCCC	20	55	506.98	12.06	2030	NA
LM258AP	P	PDIP	8	50	506	13.97	11230	4.32
LM258AP.A	P	PDIP	8	50	506	13.97	11230	4.32
LM258AP.B	P	PDIP	8	50	506	13.97	11230	4.32
LM258APE4	P	PDIP	8	50	506	13.97	11230	4.32
LM258APE4.A	P	PDIP	8	50	506	13.97	11230	4.32
LM258APE4.B	P	PDIP	8	50	506	13.97	11230	4.32
LM258P	P	PDIP	8	50	506.1	9	600	5.4
LM258P	P	PDIP	8	50	506	13.97	11230	4.32
LM258P.A	P	PDIP	8	50	506.1	9	600	5.4
LM258P.A	P	PDIP	8	50	506	13.97	11230	4.32
LM258P.B	P	PDIP	8	50	506	13.97	11230	4.32
LM258P.B	P	PDIP	8	50	506.1	9	600	5.4
LM258PE4	P	PDIP	8	50	506	13.97	11230	4.32
LM258PE4.B	P	PDIP	8	50	506	13.97	11230	4.32
LM2904P	P	PDIP	8	50	506	13.97	11230	4.32
LM2904P.A	P	PDIP	8	50	506	13.97	11230	4.32
LM2904P.B	P	PDIP	8	50	506	13.97	11230	4.32
LM2904PE4	P	PDIP	8	50	506	13.97	11230	4.32
LM2904PE4.A	P	PDIP	8	50	506	13.97	11230	4.32
LM2904PE4.B	P	PDIP	8	50	506	13.97	11230	4.32
LM358AP	P	PDIP	8	50	506	13.97	11230	4.32
LM358AP	P	PDIP	8	50	506	13.97	11230	4.32
LM358AP.B	P	PDIP	8	50	506	13.97	11230	4.32

Device	Package Name	Package Type	Pins	SPQ	L (mm)	W (mm)	T (µm)	B (mm)
LM358AP.B	P	PDIP	8	50	506	13.97	11230	4.32
LM358APE4	P	PDIP	8	50	506	13.97	11230	4.32
LM358APE4	P	PDIP	8	50	506	13.97	11230	4.32
LM358APE4.A	P	PDIP	8	50	506	13.97	11230	4.32
LM358APE4.A	P	PDIP	8	50	506	13.97	11230	4.32
LM358APE4.B	P	PDIP	8	50	506	13.97	11230	4.32
LM358APE4.B	P	PDIP	8	50	506	13.97	11230	4.32
LM358P	P	PDIP	8	50	506	13.97	11230	4.32
LM358P	P	PDIP	8	50	506	13.97	11230	4.32
LM358P.A	P	PDIP	8	50	506	13.97	11230	4.32
LM358P.A	P	PDIP	8	50	506	13.97	11230	4.32
LM358P.B	P	PDIP	8	50	506	13.97	11230	4.32
LM358P.B	P	PDIP	8	50	506	13.97	11230	4.32
LM358PE4	P	PDIP	8	50	506	13.97	11230	4.32
LM358PE4	P	PDIP	8	50	506	13.97	11230	4.32
LM358PE4.A	P	PDIP	8	50	506	13.97	11230	4.32
LM358PE4.A	P	PDIP	8	50	506	13.97	11230	4.32
LM358PE4.B	P	PDIP	8	50	506	13.97	11230	4.32
LM358PE4.B	P	PDIP	8	50	506	13.97	11230	4.32

PACKAGE OUTLINE

JG0008A

CDIP - 5.08 mm max height

CERAMIC DUAL IN-LINE PACKAGE



NOTES:

1. All linear dimensions are in millimeters. Any dimensions in parenthesis are for reference only. Dimensioning and tolerancing per ASME Y14.5M.
2. This drawing is subject to change without notice.
3. This package can be hermetically sealed with a ceramic lid using glass frit.
4. Index point is provided on cap for terminal identification.
5. Falls within MIL STD 1835 GDIP1-T8

EXAMPLE BOARD LAYOUT

JG0008A

CDIP - 5.08 mm max height

CERAMIC DUAL IN-LINE PACKAGE

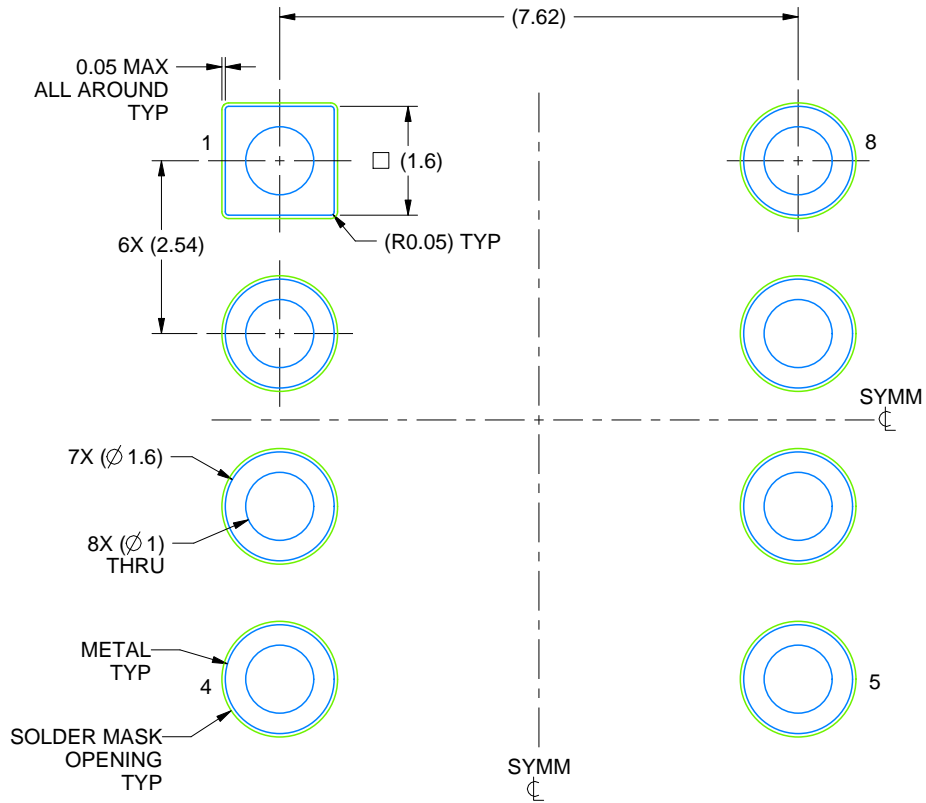

LAND PATTERN EXAMPLE
NON SOLDER MASK DEFINED
SCALE: 9X

4230036/A 09/2023

DGK0008A



PACKAGE OUTLINE

VSSOP - 1.1 mm max height

SMALL OUTLINE PACKAGE

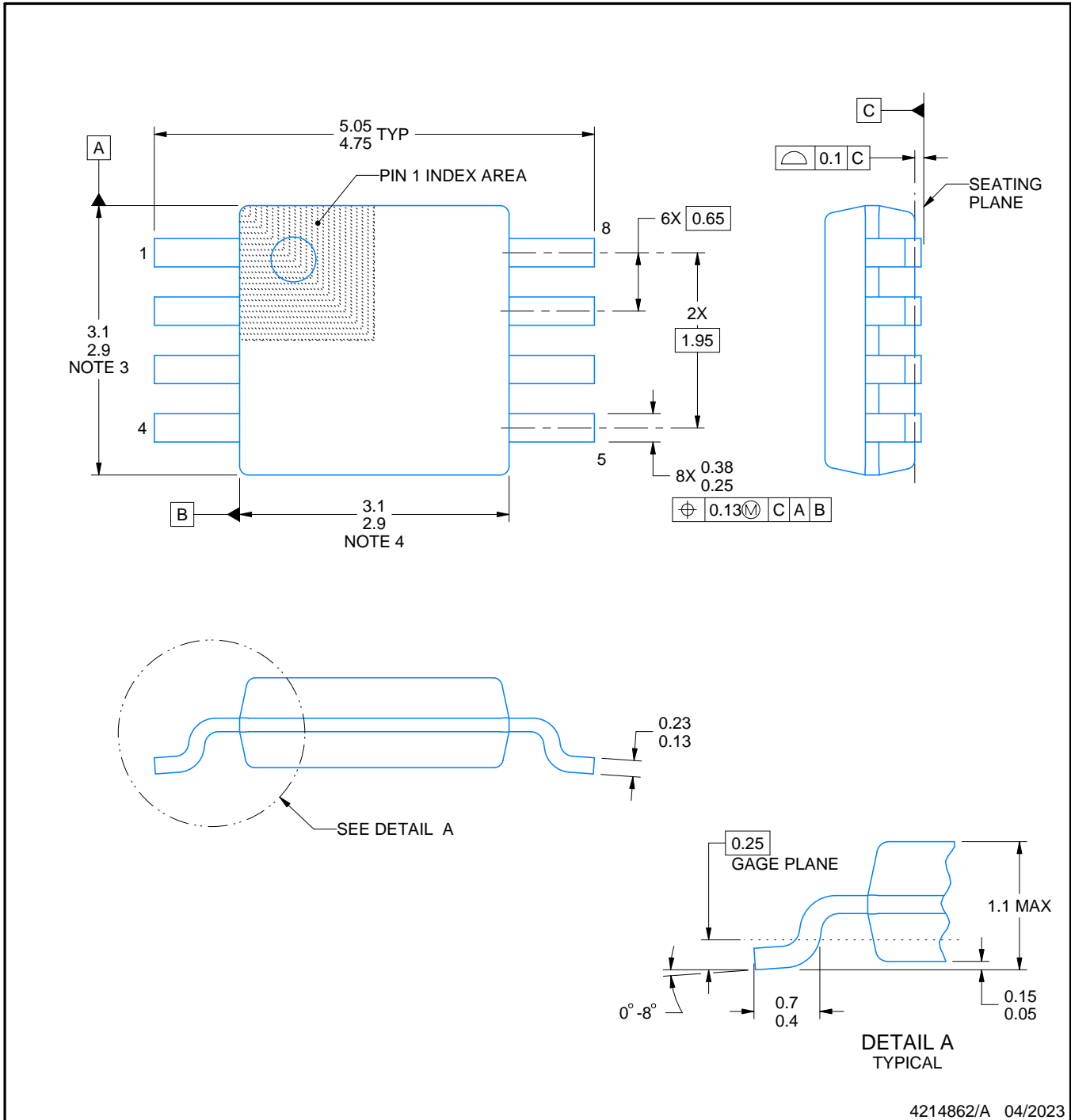

4214862/A 04/2023

NOTES:

PowerPAD is a trademark of Texas Instruments.

1. All linear dimensions are in millimeters. Any dimensions in parenthesis are for reference only. Dimensioning and tolerancing per ASME Y14.5M.
2. This drawing is subject to change without notice.
3. This dimension does not include mold flash, protrusions, or gate burrs. Mold flash, protrusions, or gate burrs shall not exceed 0.15 mm per side.
4. This dimension does not include interlead flash. Interlead flash shall not exceed 0.25 mm per side.
5. Reference JEDEC registration MO-187.

EXAMPLE BOARD LAYOUT

DGK0008A

™ VSSOP - 1.1 mm max height

SMALL OUTLINE PACKAGE

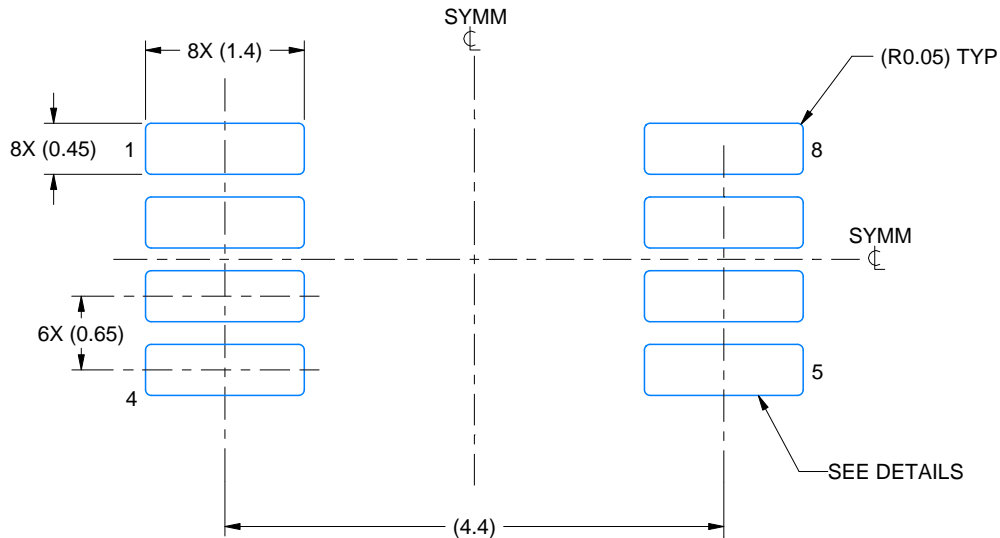

LAND PATTERN EXAMPLE
EXPOSED METAL SHOWN
SCALE: 15X

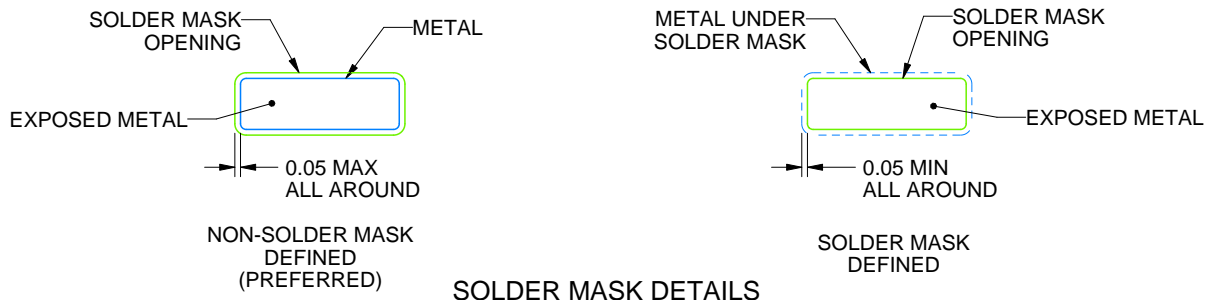

SOLDER MASK DETAILS

4214862/A 04/2023

NOTES: (continued)

6. Publication IPC-7351 may have alternate designs.
7. Solder mask tolerances between and around signal pads can vary based on board fabrication site.
8. Vias are optional depending on application, refer to device data sheet. If any vias are implemented, refer to their locations shown on this view. It is recommended that vias under paste be filled, plugged or tented.
9. Size of metal pad may vary due to creepage requirement.

EXAMPLE STENCIL DESIGN

DGK0008A

TM VSSOP - 1.1 mm max height

SMALL OUTLINE PACKAGE

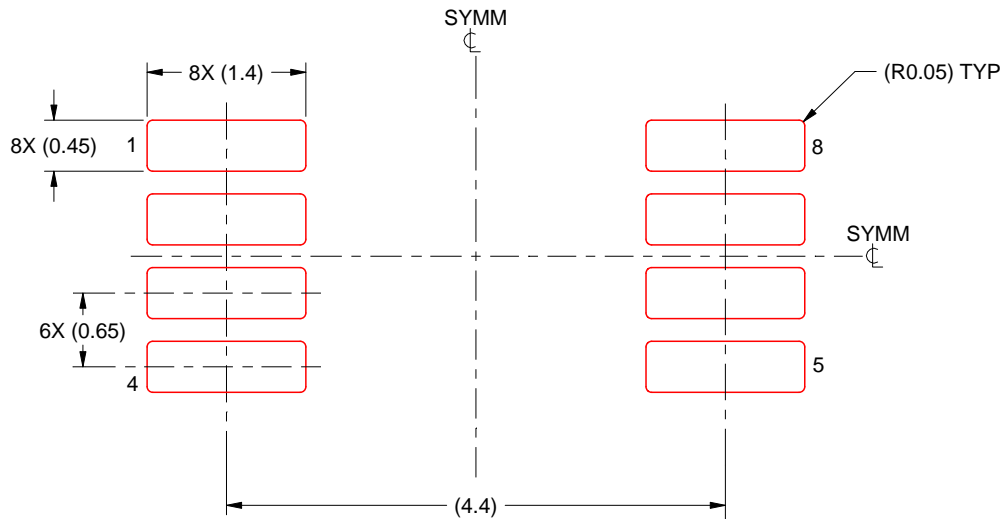

SOLDER PASTE EXAMPLE
SCALE: 15X

4214862/A 04/2023

NOTES: (continued)

11. Laser cutting apertures with trapezoidal walls and rounded corners may offer better paste release. IPC-7525 may have alternate design recommendations.
12. Board assembly site may have different recommendations for stencil design.

P (R-PDIP-T8)

PLASTIC DUAL-IN-LINE PACKAGE

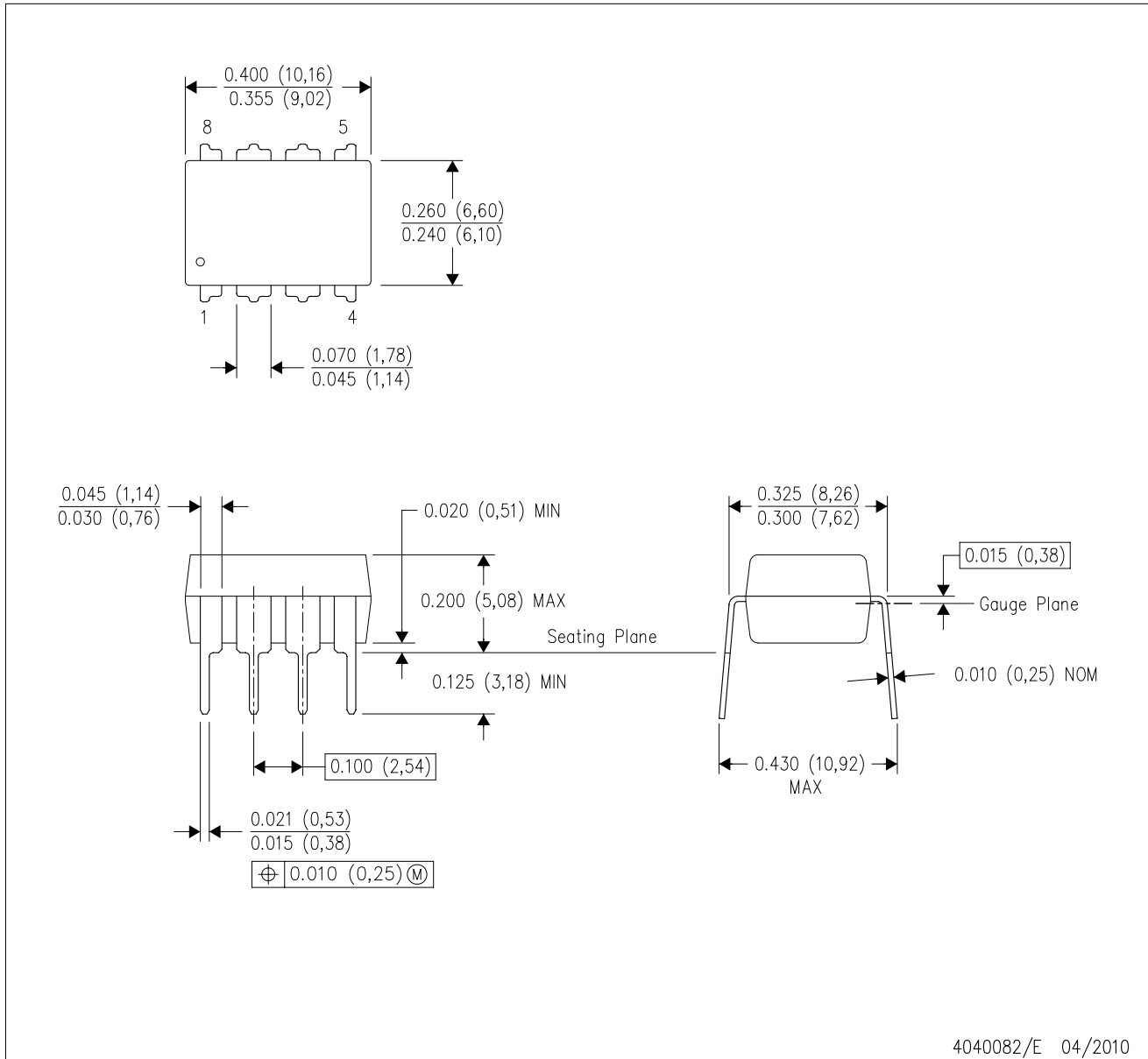

- NOTES:
- A. All linear dimensions are in inches (millimeters).
 - B. This drawing is subject to change without notice.
 - C. Falls within JEDEC MS-001 variation BA.

PW0008A



PACKAGE OUTLINE

TSSOP - 1.2 mm max height

SMALL OUTLINE PACKAGE

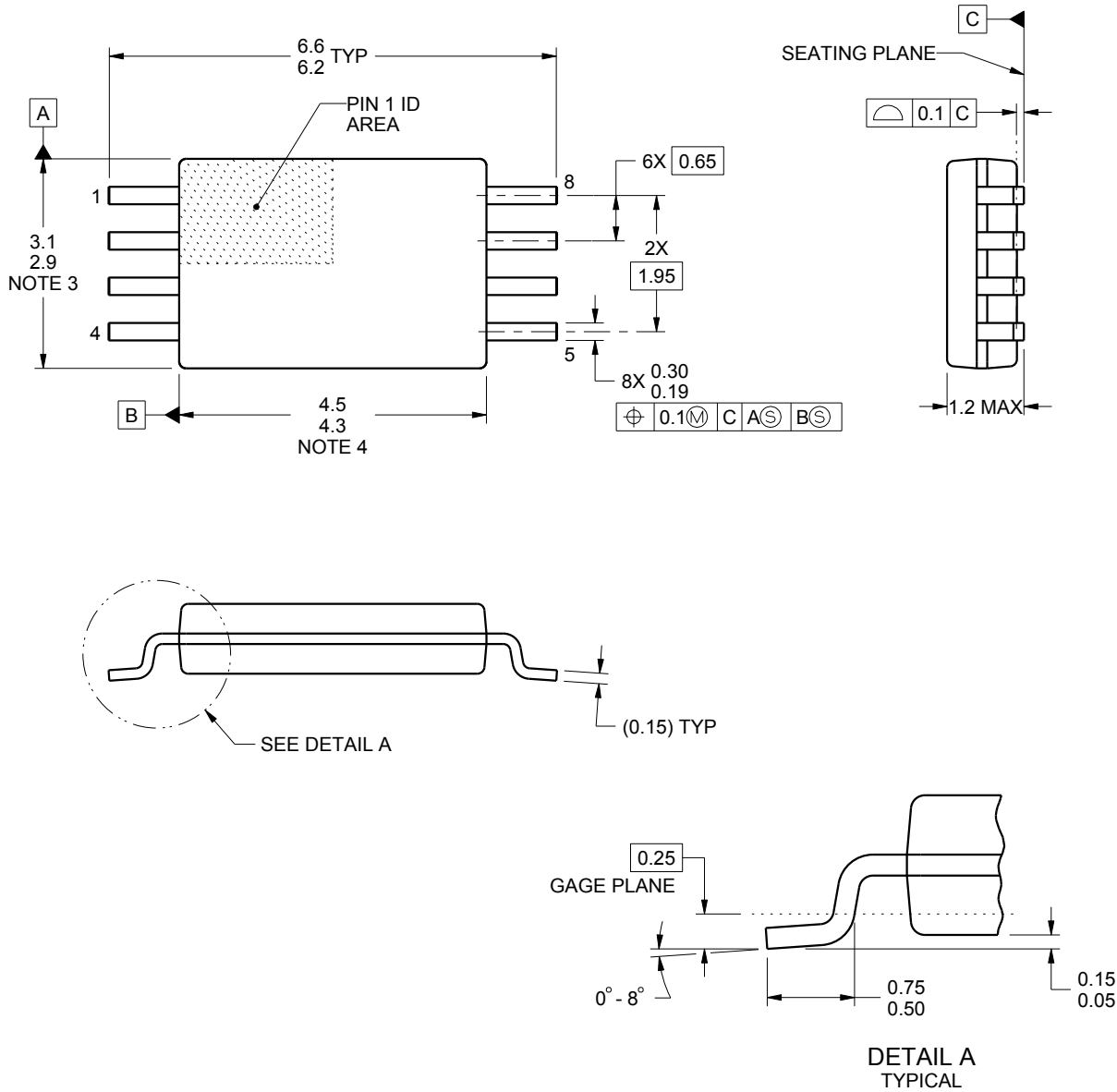

4221848/A 02/2015

NOTES:

1. All linear dimensions are in millimeters. Any dimensions in parenthesis are for reference only. Dimensioning and tolerancing per ASME Y14.5M.
2. This drawing is subject to change without notice.
3. This dimension does not include mold flash, protrusions, or gate burrs. Mold flash, protrusions, or gate burrs shall not exceed 0.15 mm per side.
4. This dimension does not include interlead flash. Interlead flash shall not exceed 0.25 mm per side.
5. Reference JEDEC registration MO-153, variation AA.

EXAMPLE BOARD LAYOUT

PW0008A

TSSOP - 1.2 mm max height

SMALL OUTLINE PACKAGE

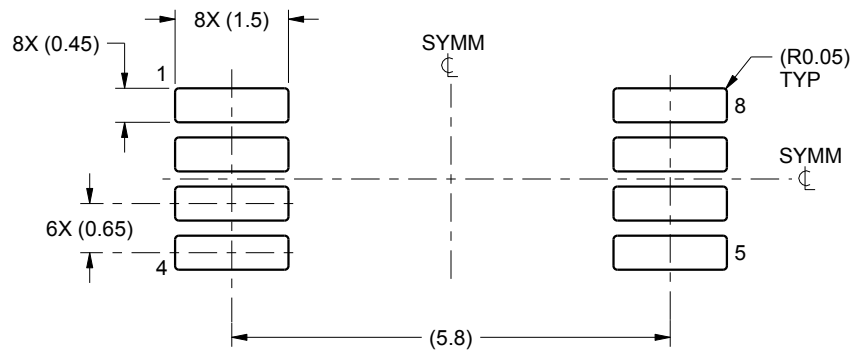

LAND PATTERN EXAMPLE
SCALE:10X



SOLDER MASK DETAILS
NOT TO SCALE

4221848/A 02/2015

NOTES: (continued)

- 6. Publication IPC-7351 may have alternate designs.
- 7. Solder mask tolerances between and around signal pads can vary based on board fabrication site.

EXAMPLE STENCIL DESIGN

PW0008A

TSSOP - 1.2 mm max height

SMALL OUTLINE PACKAGE



SOLDER PASTE EXAMPLE
BASED ON 0.125 mm THICK STENCIL
SCALE:10X

4221848/A 02/2015

NOTES: (continued)

8. Laser cutting apertures with trapezoidal walls and rounded corners may offer better paste release. IPC-7525 may have alternate design recommendations.
9. Board assembly site may have different recommendations for stencil design.

GENERIC PACKAGE VIEW

FK 20

LCCC - 2.03 mm max height

8.89 x 8.89, 1.27 mm pitch

LEADLESS CERAMIC CHIP CARRIER

This image is a representation of the package family, actual package may vary.
Refer to the product data sheet for package details.

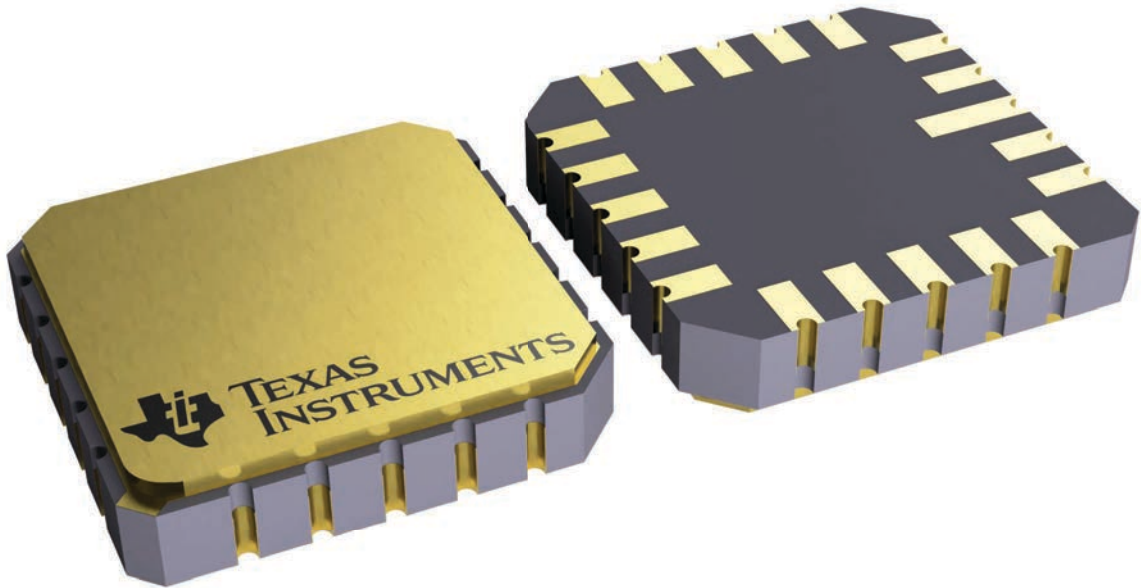

4229370VA\

EXAMPLE BOARD LAYOUT

DDF0008A

SOT-23-THIN - 1.1 mm max height

PLASTIC SMALL OUTLINE

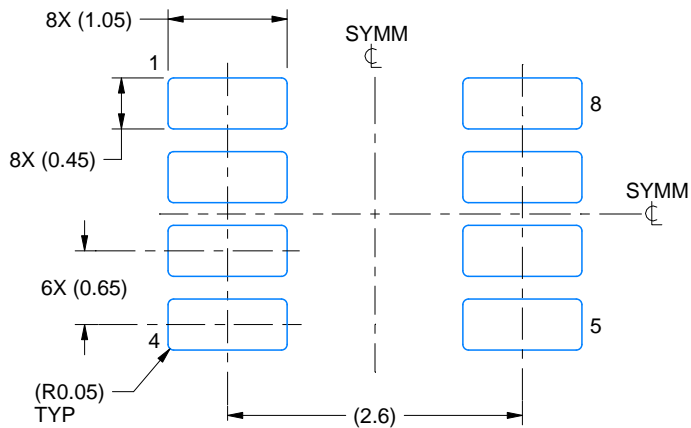

LAND PATTERN EXAMPLE
EXPOSED METAL SHOWN
SCALE:15X

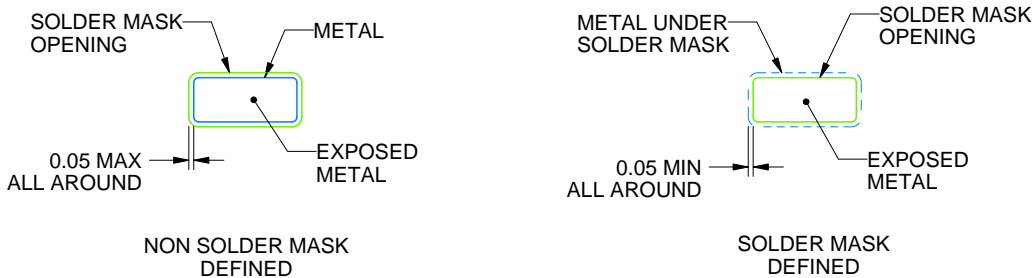

SOLDER MASK DETAILS

4222047/E 07/2024

NOTES: (continued)

- 4. Publication IPC-7351 may have alternate designs.
- 5. Solder mask tolerances between and around signal pads can vary based on board fabrication site.

EXAMPLE STENCIL DESIGN

DDF0008A

SOT-23-THIN - 1.1 mm max height

PLASTIC SMALL OUTLINE

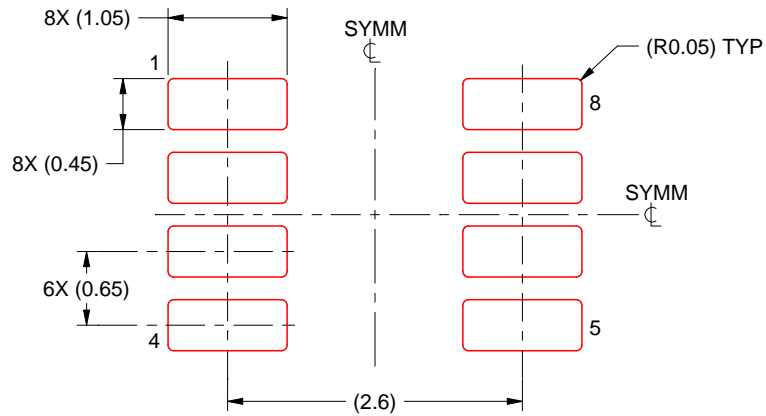

SOLDER PASTE EXAMPLE
BASED ON 0.125 mm THICK STENCIL
SCALE:15X

4222047/E 07/2024

NOTES: (continued)

6. Laser cutting apertures with trapezoidal walls and rounded corners may offer better paste release. IPC-7525 may have alternate design recommendations.
7. Board assembly site may have different recommendations for stencil design.



D0008A

PACKAGE OUTLINE

SOIC - 1.75 mm max height

SMALL OUTLINE INTEGRATED CIRCUIT

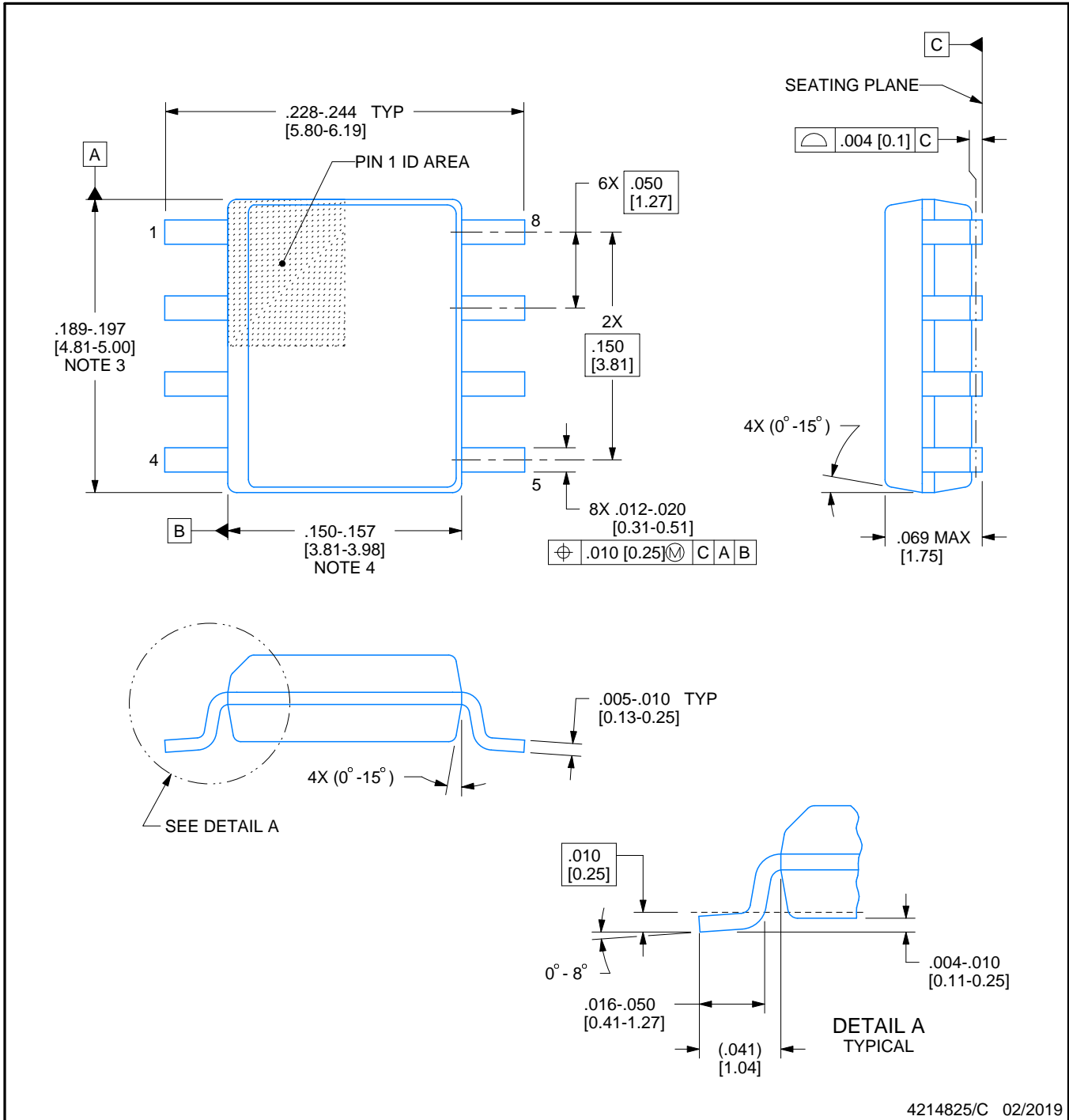

4214825/C 02/2019

NOTES:

1. Linear dimensions are in inches [millimeters]. Dimensions in parenthesis are for reference only. Controlling dimensions are in inches. Dimensioning and tolerancing per ASME Y14.5M.
2. This drawing is subject to change without notice.
3. This dimension does not include mold flash, protrusions, or gate burrs. Mold flash, protrusions, or gate burrs shall not exceed .006 [0.15] per side.
4. This dimension does not include interlead flash.
5. Reference JEDEC registration MS-012, variation AA.

EXAMPLE BOARD LAYOUT

D0008A

SOIC - 1.75 mm max height

SMALL OUTLINE INTEGRATED CIRCUIT

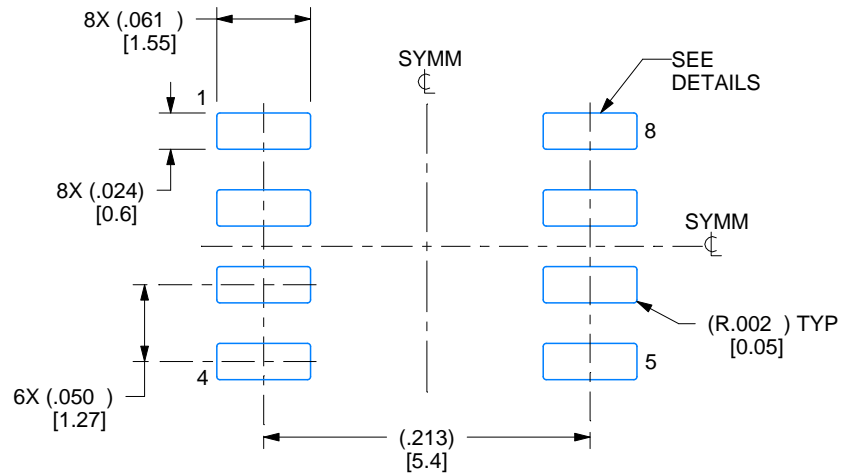

LAND PATTERN EXAMPLE
EXPOSED METAL SHOWN
SCALE:8X

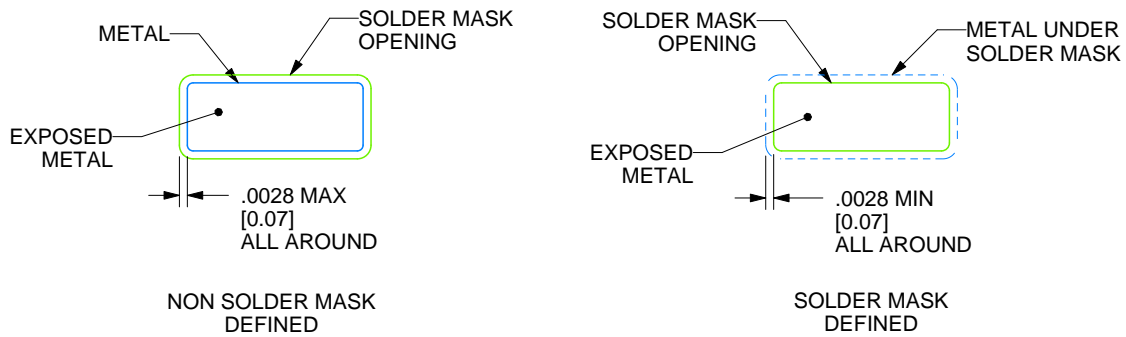

SOLDER MASK DETAILS

4214825/C 02/2019

NOTES: (continued)

6. Publication IPC-7351 may have alternate designs.

7. Solder mask tolerances between and around signal pads can vary based on board fabrication site.

EXAMPLE STENCIL DESIGN

D0008A

SOIC - 1.75 mm max height

SMALL OUTLINE INTEGRATED CIRCUIT



SOLDER PASTE EXAMPLE
BASED ON .005 INCH [0.125 MM] THICK STENCIL
SCALE:8X

4214825/C 02/2019

NOTES: (continued)

8. Laser cutting apertures with trapezoidal walls and rounded corners may offer better paste release. IPC-7525 may have alternate design recommendations.
9. Board assembly site may have different recommendations for stencil design.

MECHANICAL DATA

PS (R-PDSO-G8)

PLASTIC SMALL-OUTLINE PACKAGE

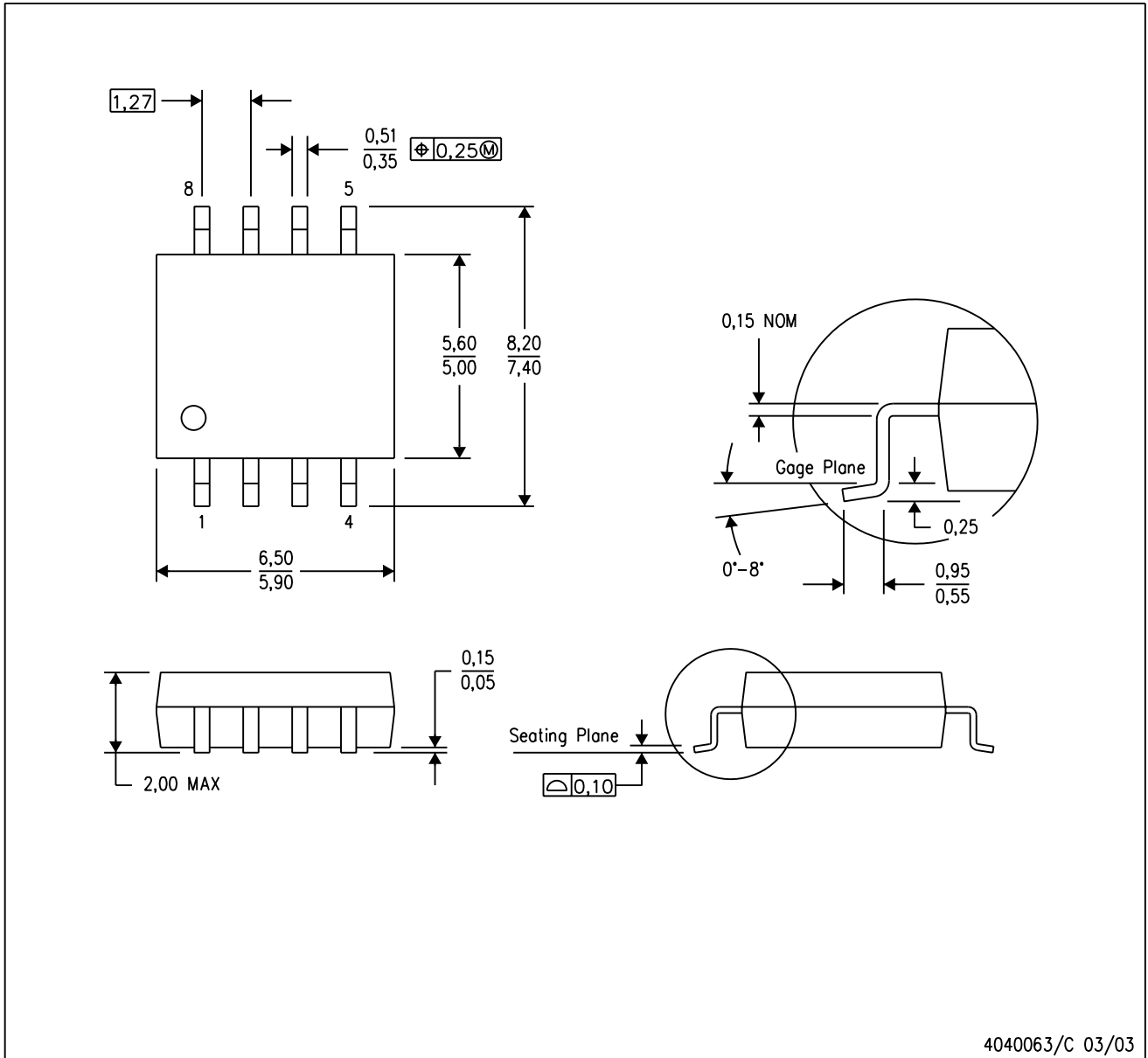

- NOTES:
- A. All linear dimensions are in millimeters.
 - B. This drawing is subject to change without notice.
 - C. Body dimensions do not include mold flash or protrusion, not to exceed 0,15.

PS (R-PDSO-G8)

PLASTIC SMALL OUTLINE

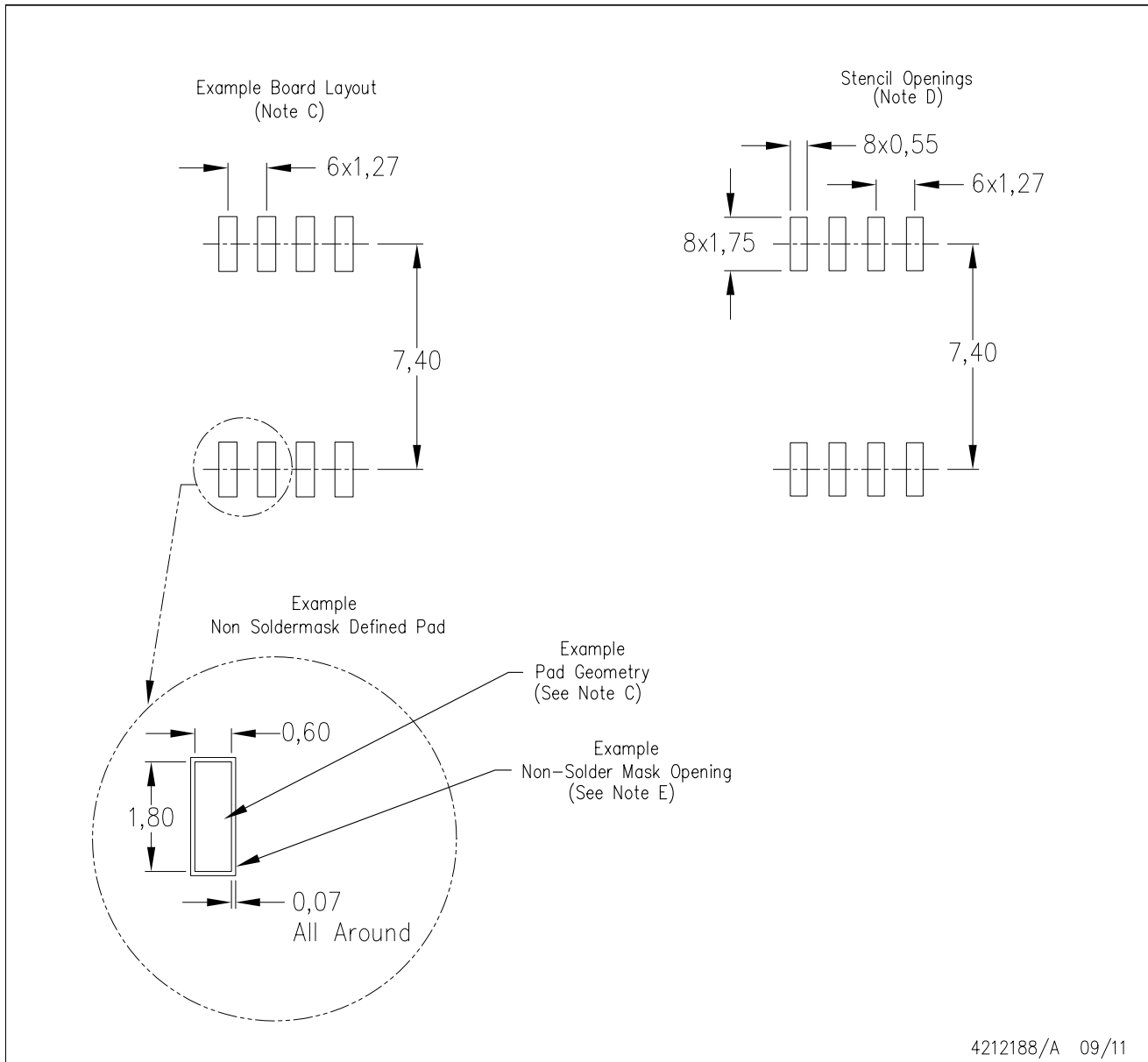

- NOTES:
- All linear dimensions are in millimeters.
 - This drawing is subject to change without notice.
 - Publication IPC-7351 is recommended for alternate designs.
 - Laser cutting apertures with trapezoidal walls and also rounding corners will offer better paste release. Customers should contact their board assembly site for stencil design recommendations. Refer to IPC-7525 for other stencil recommendations.
 - Customers should contact their board fabrication site for solder mask tolerances between and around signal pads.

IMPORTANT NOTICE AND DISCLAIMER

TI PROVIDES TECHNICAL AND RELIABILITY DATA (INCLUDING DATASHEETS), DESIGN RESOURCES (INCLUDING REFERENCE DESIGNS), APPLICATION OR OTHER DESIGN ADVICE, WEB TOOLS, SAFETY INFORMATION, AND OTHER RESOURCES "AS IS" AND WITH ALL FAULTS, AND DISCLAIMS ALL WARRANTIES, EXPRESS AND IMPLIED, INCLUDING WITHOUT LIMITATION ANY IMPLIED WARRANTIES OF MERCHANTABILITY, FITNESS FOR A PARTICULAR PURPOSE OR NON-INFRINGEMENT OF THIRD PARTY INTELLECTUAL PROPERTY RIGHTS.

These resources are intended for skilled developers designing with TI products. You are solely responsible for (1) selecting the appropriate TI products for your application, (2) designing, validating and testing your application, and (3) ensuring your application meets applicable standards, and any other safety, security, regulatory or other requirements.

These resources are subject to change without notice. TI grants you permission to use these resources only for development of an application that uses the TI products described in the resource. Other reproduction and display of these resources is prohibited. No license is granted to any other TI intellectual property right or to any third party intellectual property right. TI disclaims responsibility for, and you fully indemnify TI and its representatives against any claims, damages, costs, losses, and liabilities arising out of your use of these resources.

TI's products are provided subject to [TI's Terms of Sale](#), [TI's General Quality Guidelines](#), or other applicable terms available either on ti.com or provided in conjunction with such TI products. TI's provision of these resources does not expand or otherwise alter TI's applicable warranties or warranty disclaimers for TI products. Unless TI explicitly designates a product as custom or customer-specified, TI products are standard, catalog, general purpose devices.

TI objects to and rejects any additional or different terms you may propose.

Copyright © 2026, Texas Instruments Incorporated

Last updated 10/2025