

LM290xLV-Q1 Industry Standard, Low Voltage Automotive Operational Amplifiers

1 Features

- Industry standard amplifier for cost-sensitive systems
- Low input offset voltage: ± 1 mV
- Common-mode voltage range includes ground
- Unity-gain bandwidth: 1 MHz
- Low broadband noise: $40 \text{ nV}/\sqrt{\text{Hz}}$
- Low quiescent current: $90 \text{ }\mu\text{A}/\text{Ch}$
- Unity-gain stable
- Operational at supply voltages from 2.7 V to 5.5 V
- Offered in dual- and quad-channel variants
- Robust ESD specification: 2-kV HBM, 1-kV CDM
- Extended operating temperature range: -40°C to 125°C

2 Applications

- Optimized for AEC-Q100 grade 1 applications
- [Infotainment and cluster](#)
- [Passive safety](#)
- [Body electronics and lighting](#)
- [HEV/EV inverter and motor control](#)
- [On-board \(OBC\) and wireless charger](#)
- [Powertrain current sensor](#)
- [Advanced driver assistance systems \(ADAS\)](#)
- [Single-supply, low-side, unidirectional current-sensing circuit](#)

3 Description

The LM290xLV-Q1 family includes the dual LM2904LV-Q1 and quad LM2902LV-Q1 operational amplifiers, or op amps. The devices can operate in a supply range of 2.7 V to 5.5 V.

These op amps serve as supply alternatives to the LM2904-Q1 and LM2902-Q1 in low-voltage applications that are sensitive to cost. The LM290xLV-Q1 devices provide better performance than the LM290x-Q1 devices at low voltage and have lower power consumption. The op amps are stable at unity gain, and do not have phase reversal in overdrive conditions. The design for ESD gives the LM290xLV-Q1 family an HBM specification of 2 kV.

The LM290xLV-Q1 family is available in packages that match industry standards. The available packages include SOIC, VSSOP, and TSSOP packages.

Device Information

PART NUMBER ⁽¹⁾	PACKAGE	BODY SIZE (NOM)
LM2902LV-Q1	SOIC (14)	8.65 mm × 3.91 mm
	TSSOP (14)	4.40 mm × 5.00 mm
	SOT23 (14)	4.20 mm × 1.90 mm
LM2904LV-Q1	SOIC (8)	3.91 mm × 4.90 mm
	VSSOP (8)	3.00 mm × 3.00 mm

(1) For all available packages, see the orderable addendum at the end of the data sheet.

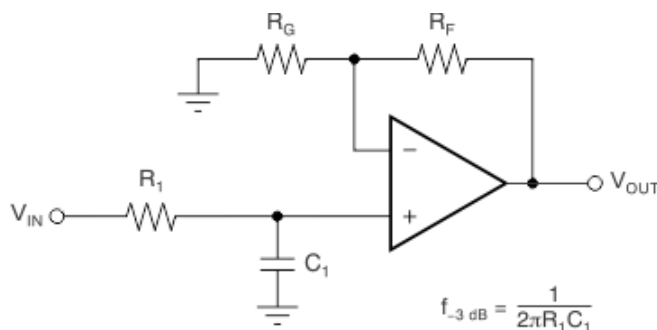

$$\frac{V_{OUT}}{V_{IN}} = \left(1 + \frac{R_F}{R_G}\right) \left(\frac{1}{1 + sR_1C_1}\right)$$

Single-Pole, Low-Pass Filter



Table of Contents

1 Features	1	8 Application and Implementation	16
2 Applications	1	8.1 Application Information.....	16
3 Description	1	8.2 Typical Application.....	16
4 Revision History	2	9 Power Supply Recommendations	18
5 Pin Configuration and Functions	3	9.1 Input and ESD Protection.....	18
6 Specifications	5	10 Layout	19
6.1 Absolute Maximum Ratings.....	5	10.1 Layout Guidelines.....	19
6.2 ESD Ratings.....	5	10.2 Layout Example.....	19
6.3 Recommended Operating Conditions.....	5	11 Device and Documentation Support	20
6.4 Thermal Information: LM2904LV-Q1.....	5	11.1 Documentation Support.....	20
6.5 Thermal Information: LM2902LV-Q1.....	6	11.2 Related Links.....	20
6.6 Electrical Characteristics.....	7	11.3 Receiving Notification of Documentation Updates..	20
6.7 Typical Characteristics.....	9	11.4 Support Resources.....	20
7 Detailed Description	14	11.5 Trademarks.....	20
7.1 Overview.....	14	11.6 Electrostatic Discharge Caution.....	20
7.2 Functional Block Diagram.....	14	11.7 Glossary.....	20
7.3 Feature Description.....	14	12 Mechanical, Packaging, and Orderable	
7.4 Device Functional Modes.....	15	Information	21

4 Revision History

NOTE: Page numbers for previous revisions may differ from page numbers in the current version.

Changes from Revision A (April 2021) to Revision B (October 2021)	Page
• Removed preview note from TSSOP (14) and SOT-23 (14) packages in <i>Device Information</i> table.....	1
• Updated PW package thermal information in <i>Thermal Information: LM2902LV-Q1</i> table.....	6
<hr/>	
Changes from Revision * (August 2020) to Revision A (April 2021)	Page
• Deleted TSSOP (8) package information from <i>Device Information</i> table.	1
• Removed preview note from VSSOP (8) package information in <i>Device Information</i> table.	1
• Deleted PW package from <i>Pin Configuration and Functions</i> section.....	3
• Added note 5 to the differential input voltage in <i>Absolute Maximum Ratings</i> table	5
• Updated DGK package thermal information in <i>Thermal Information: LM2904LV-Q1</i> table.....	5
• Updated DYY package thermal information in <i>Thermal Information: LM2902LV-Q1</i> table.....	6

5 Pin Configuration and Functions

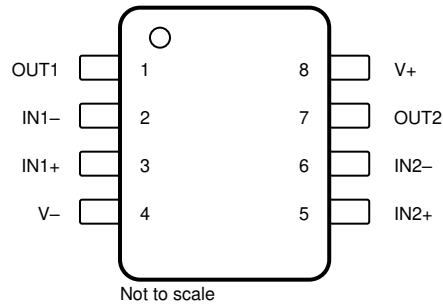

**Figure 5-1. LM2904LV-Q1 D and DGK Packages
8-Pin SOIC and VSSOP
Top View**

Table 5-1. Pin Functions: LM2904LV-Q1

PIN		I/O	DESCRIPTION
NAME	NO.		
IN1-	2	I	Inverting input, channel 1
IN1+	3	I	Noninverting input, channel 1
IN2-	6	I	Inverting input, channel 2
IN2+	5	I	Noninverting input, channel 2
OUT1	1	O	Output, channel 1
OUT2	7	O	Output, channel 2
V-	4	—	Negative (low) supply or ground (for single-supply operation)
V+	8	—	Positive (high) supply

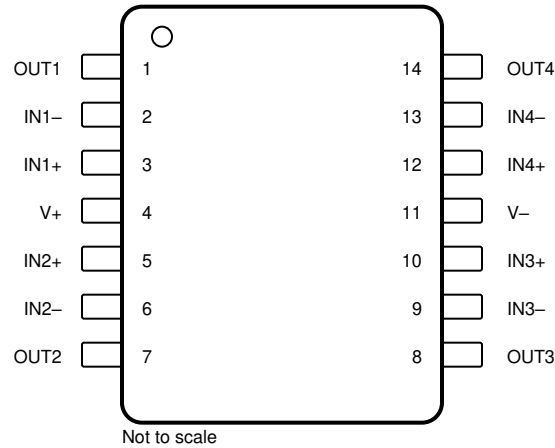

**Figure 5-2. LM2902LV-Q1 D, PW, DYY Packages
14-Pin SOIC, TSSOP, SOT-23
Top View**

Table 5-2. Pin Functions: LM2902LV-Q1

PIN		I/O	DESCRIPTION
NAME	NO.		
IN1–	2	I	Inverting input, channel 1
IN1+	3	I	Noninverting input, channel 1
IN2–	6	I	Inverting input, channel 2
IN2+	5	I	Noninverting input, channel 2
IN3–	9	I	Inverting input, channel 3
IN3+	10	I	Noninverting input, channel 3
IN4–	13	I	Inverting input, channel 4
IN4+	12	I	Noninverting input, channel 4
OUT1	1	O	Output, channel 1
OUT2	7	O	Output, channel 2
OUT3	8	O	Output, channel 3
OUT4	14	O	Output, channel 4
V–	11	—	Negative (low) supply or ground (for single-supply operation)
V+	4	—	Positive (high) supply

6 Specifications

6.1 Absolute Maximum Ratings

over operating junction temperature range (unless otherwise noted)⁽¹⁾

		MIN	MAX	UNIT	
Supply voltage, ([V+] – [V–])		0	6	V	
Signal input pins	Voltage ⁽²⁾	Common-mode	(V–) – 0.5	(V+) + 0.5	V
		Differential ⁽⁵⁾	(V+) – (V–) + 0.2		V
	Current ⁽²⁾	–10	10	mA	
Output short-circuit ^{(3) (4)}		Continuous			
Operating, T _A		–55	125	°C	
Operating junction temperature, T _J			150	°C	
Storage temperature, T _{stg}		–65	150	°C	

- (1) Stresses beyond those listed under *Absolute Maximum Ratings* may cause permanent damage to the device. These are stress ratings only, and functional operation of the device at these or any other conditions beyond those indicated under *Recommended Operating Conditions* is not implied. Exposure to absolute-maximum-rated conditions for extended periods may affect device reliability.
- (2) Input pins are diode-clamped to the power-supply rails. Input signals that may swing more than 0.5 V beyond the supply rails must be current limited to 10 mA or less.
- (3) Short-circuit to ground, one amplifier per package.
- (4) Long term continuous current limit is determined by electromigration limits
- (5) Differential input voltages greater than 0.5 V applied continuously can result in a shift to the input offset voltage above the maximum specification of this parameter. The magnitude of this effect increases as the ambient operating temperature rises.

6.2 ESD Ratings

		VALUE	UNIT
V _(ESD)	Electrostatic discharge	Human-body model (HBM), per ANSI/ESDA/JEDEC JS-001 ⁽¹⁾	±2000
		Charged-device model (CDM), per JEDEC specification JESD22-C101 ⁽²⁾	±1000

- (1) JEDEC document JEP155 states that 500-V HBM allows safe manufacturing with a standard ESD control process.
- (2) JEDEC document JEP157 states that 250-V CDM allows safe manufacturing with a standard ESD control process.

6.3 Recommended Operating Conditions

over operating junction temperature range (unless otherwise noted)

		MIN	MAX	UNIT
V _S	Supply voltage [(V+) – (V–)]	2.7	5.5	V
V _{CM}	Input-pin voltage range	(V–) – 0.1	(V+) – 1	V
T _A	Specified temperature	–40	125	°C

6.4 Thermal Information: LM2904LV-Q1

THERMAL METRIC ⁽¹⁾	LM2904LV-Q1		UNIT	
	D (SOIC)	DGK (VSSOP)		
	8 PINS	8 PINS		
R _{θJA}	Junction-to-ambient thermal resistance	151.9	196.6	°C/W
R _{θJC(top)}	Junction-to-case (top) thermal resistance	92.0	86.2	°C/W
R _{θJB}	Junction-to-board thermal resistance	95.4	118.3	°C/W
ψ _{JT}	Junction-to-top characterization parameter	40.2	23.2	°C/W
ψ _{JB}	Junction-to-board characterization parameter	94.7	116.7	°C/W

- (1) For more information about traditional and new thermal metrics, see [Semiconductor and IC Package Thermal Metrics](#).

6.5 Thermal Information: LM2902LV-Q1

THERMAL METRIC ⁽¹⁾		LM2902LV-Q1			UNIT
		D (SOIC)	DYY (SOT-23)	PW (TSSOP)	
		14 PINS	14 PINS	14 PINS	
$R_{\theta JA}$	Junction-to-ambient thermal resistance	115.1	154.3	135.3	°C/W
$R_{\theta JC(top)}$	Junction-to-case (top) thermal resistance	71.2	86.8	63.5	°C/W
$R_{\theta JB}$	Junction-to-board thermal resistance	71.1	67.9	78.4	°C/W
ψ_{JT}	Junction-to-top characterization parameter	29.6	10.1	13.6	°C/W
ψ_{JB}	Junction-to-board characterization parameter	70.7	67.5	77.9	°C/W

(1) For more information about traditional and new thermal metrics, see [Semiconductor and IC Package Thermal Metrics](#).

6.6 Electrical Characteristics

For $V_S = (V+) - (V-) = 2.7\text{ V to }5.5\text{ V}$ ($\pm 1.35\text{ V to } \pm 2.75\text{ V}$), $T_A = 25^\circ\text{C}$, $R_L = 10\text{ k}\Omega$ connected to $V_S / 2$, and $V_{CM} = V_{OUT} = V_S / 2$ (unless otherwise noted)

PARAMETER ⁽¹⁾		TEST CONDITIONS	MIN	TYP	MAX	UNIT
OFFSET VOLTAGE						
V_{OS}	Input offset voltage	$V_S = 5\text{ V}$		± 1	± 3	mV
		$V_S = 5\text{ V}$, $T_A = -40^\circ\text{C to }125^\circ\text{C}$			± 5	
dV_{OS}/dT	V_{OS} vs temperature	$T_A = -40^\circ\text{C to }125^\circ\text{C}$		± 4		$\mu\text{V}/^\circ\text{C}$
PSRR	Power-supply rejection ratio	$V_S = 2.7\text{ V to }5.5\text{ V}$, $V_{CM} = (V-)$	80	100		dB
INPUT VOLTAGE RANGE						
V_{CM}	Common-mode voltage range	No phase reversal	$(V-) - 0.1$		$(V+) - 1$	V
CMRR	Common-mode rejection ratio	$V_S = 2.7\text{ V}$, $(V-) - 0.1\text{ V} < V_{CM} < (V+) - 1\text{ V}$ $T_A = -40^\circ\text{C to }125^\circ\text{C}$		84		dB
		$V_S = 5.5\text{ V}$, $(V-) - 0.1\text{ V} < V_{CM} < (V+) - 1\text{ V}$ $T_A = -40^\circ\text{C to }125^\circ\text{C}$	63	92		
INPUT BIAS CURRENT						
I_B	Input bias current	$V_S = 5\text{ V}$		± 15		pA
I_{OS}	Input offset current			± 5		pA
NOISE						
E_n	Input voltage noise (peak-to-peak)	$f = 0.1\text{ Hz to }10\text{ Hz}$, $V_S = 5\text{ V}$		5.1		μV_{PP}
e_n	Input voltage noise density	$f = 1\text{ kHz}$, $V_S = 5\text{ V}$		40		$\text{nV}/\sqrt{\text{Hz}}$
INPUT CAPACITANCE						
C_{ID}	Differential			2		pF
C_{IC}	Common-mode			5.5		pF
OPEN-LOOP GAIN						
A_{OL}	Open-loop voltage gain	$V_S = 2.7\text{ V}$, $(V-) + 0.15\text{ V} < V_O < (V+) - 0.15\text{ V}$, $R_L = 2\text{ k}\Omega$		110		dB
		$V_S = 5.5\text{ V}$, $(V-) + 0.15\text{ V} < V_O < (V+) - 0.15\text{ V}$, $R_L = 2\text{ k}\Omega$		125		
FREQUENCY RESPONSE						
GBW	Gain-bandwidth product	$V_S = 5\text{ V}$		1		MHz
ϕ_m	Phase margin	$V_S = 5.5\text{ V}$, $G = +1$		75		$^\circ$
SR	Slew rate	$V_S = 5\text{ V}$, $G = +1$		1.5		$\text{V}/\mu\text{s}$
t_s	Settling time	To 0.1%, $V_S = 5\text{ V}$, 2-V step, $G = 1$, $C_L = 100\text{ pF}$		4		μs
		To 0.01%, $V_S = 5\text{ V}$, 2-V step, $G = 1$, $C_L = 100\text{ pF}$		5		
t_{OR}	Overload recovery time	$V_S = 5\text{ V}$, $V_{IN} \times \text{gain} > V_S$		1		μs
THD+N	Total harmonic distortion + noise	$V_S = 5.5\text{ V}$, $V_{CM} = 2.5\text{ V}$, $V_O = 1\text{ V}_{RMS}$, $G = 1$, $f = 1\text{ kHz}$, 80-kHz measurement BW		0.005%		
OUTPUT						
V_{OH}	Voltage output swing from positive supply	$R_L \geq 2\text{ k}\Omega$, $T_A = -40^\circ\text{C to }125^\circ\text{C}$	1			V
V_{OL}	Voltage output swing from negative supply	$R_L \leq 10\text{ k}\Omega$, $T_A = -40^\circ\text{C to }125^\circ\text{C}$		40	75	mV
I_{SC}	Short-circuit current	$V_S = 5.5\text{ V}$		± 40		mA
Z_O	Open-loop output impedance	$V_S = 5\text{ V}$, $f = 1\text{ MHz}$		1200		Ω

6.6 Electrical Characteristics (continued)

For $V_S = (V+) - (V-) = 2.7\text{ V to }5.5\text{ V } (\pm 1.35\text{ V to } \pm 2.75\text{ V})$, $T_A = 25^\circ\text{C}$, $R_L = 10\text{ k}\Omega$ connected to $V_S / 2$, and $V_{CM} = V_{OUT} = V_S / 2$ (unless otherwise noted)

PARAMETER ⁽¹⁾		TEST CONDITIONS	MIN	TYP	MAX	UNIT
POWER SUPPLY						
V_S	Specified voltage range		2.7 (± 1.35)		5.5 (± 2.75)	V
I_Q	Quiescent current per amplifier	$I_O = 0\text{ mA}$, $V_S = 5.5\text{ V}$		90	150	μA
		$I_O = 0\text{ mA}$, $V_S = 5.5\text{ V}$, $T_A = -40^\circ\text{C to }125^\circ\text{C}$			160	

(1) Overtemperature limits are assured by characterization.

6.7 Typical Characteristics

at $T_A = 25^\circ\text{C}$, $V_+ = 2.75\text{ V}$, $V_- = -2.75\text{ V}$, $R_L = 10\text{ k}\Omega$ connected to $V_S / 2$, $V_{CM} = V_S / 2$, and $V_{OUT} = V_S / 2$ (unless otherwise noted)

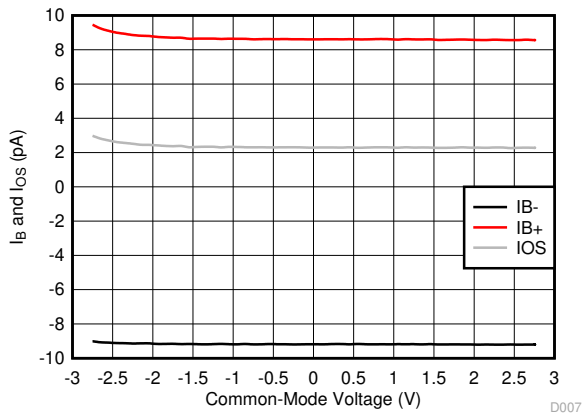

Figure 6-1. I_B and I_{OS} vs Common-Mode Voltage

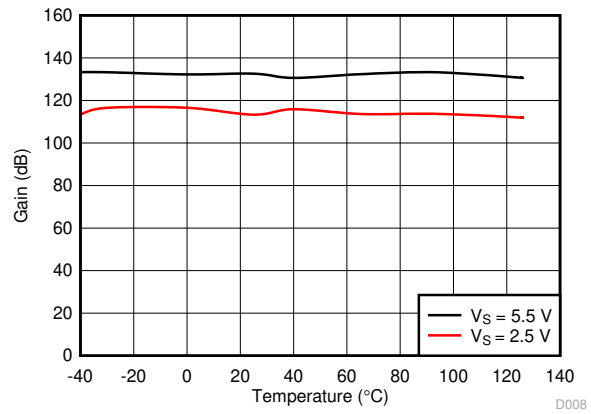

Figure 6-2. Open-Loop Gain vs Temperature

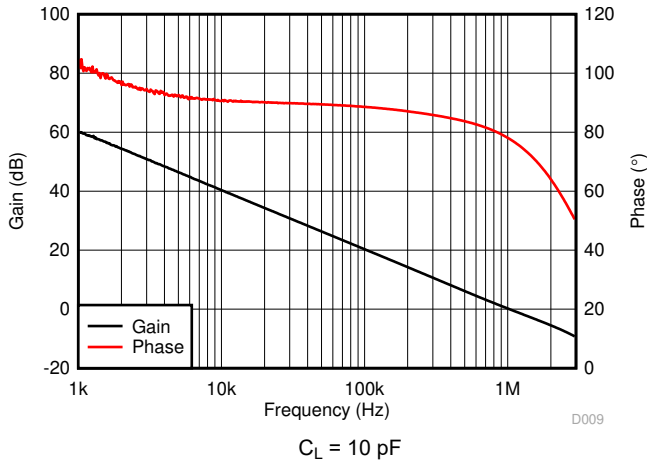

Figure 6-3. Open-Loop Gain and Phase vs Frequency

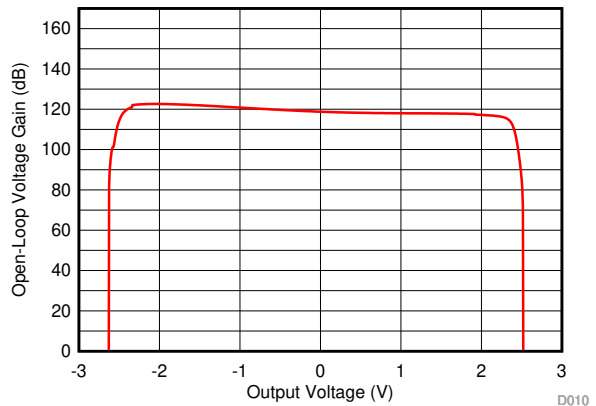

Figure 6-4. Open-Loop Gain vs Output Voltage

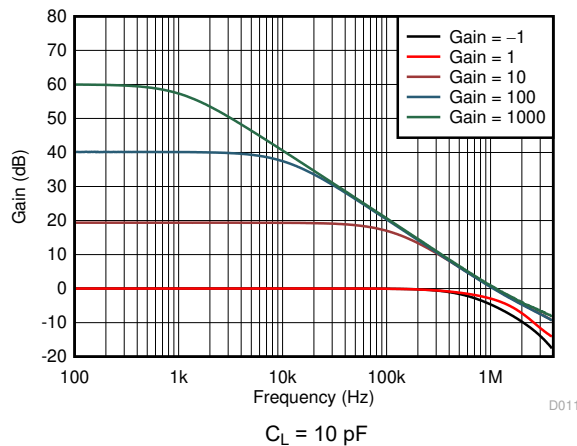

Figure 6-5. Closed-Loop Gain vs Frequency

6.7 Typical Characteristics (continued)

at $T_A = 25^\circ\text{C}$, $V_+ = 2.75\text{ V}$, $V_- = -2.75\text{ V}$, $R_L = 10\text{ k}\Omega$ connected to $V_S / 2$, $V_{CM} = V_S / 2$, and $V_{OUT} = V_S / 2$ (unless otherwise noted)

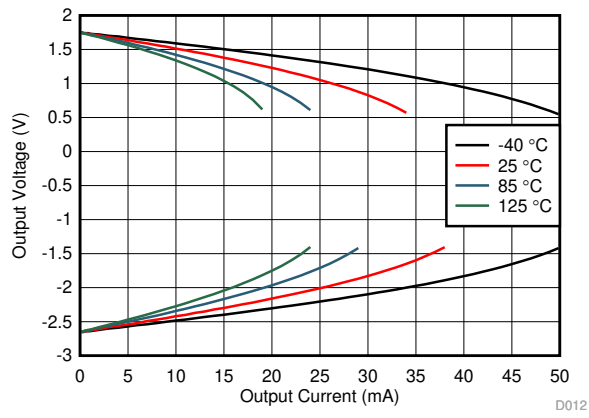

Figure 6-6. Output Voltage vs Output Current (Claw)

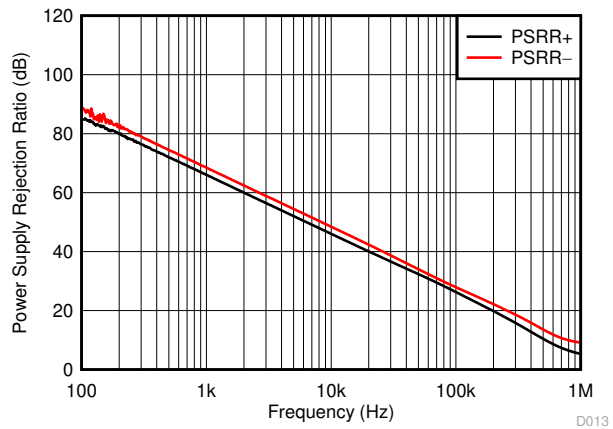

Figure 6-7. PSRR vs Frequency

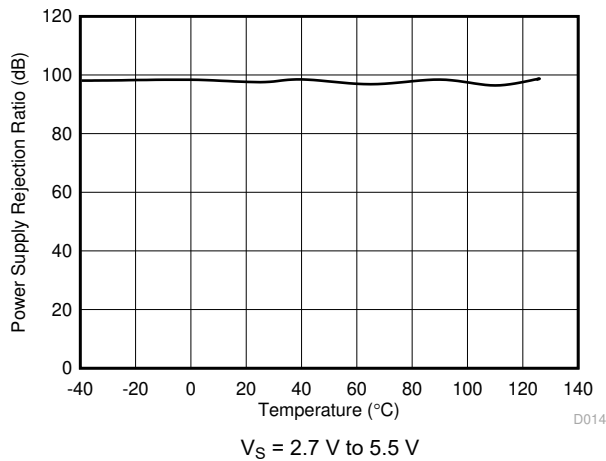

Figure 6-8. DC PSRR vs Temperature

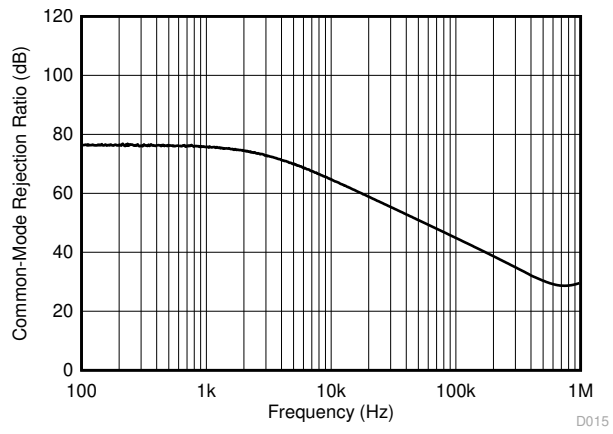

Figure 6-9. CMRR vs Frequency

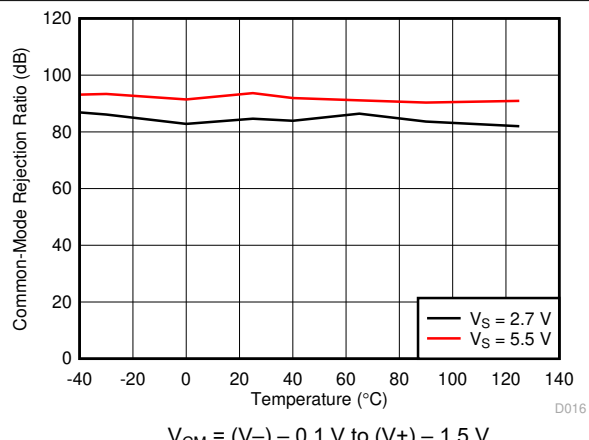

Figure 6-10. DC CMRR vs Temperature

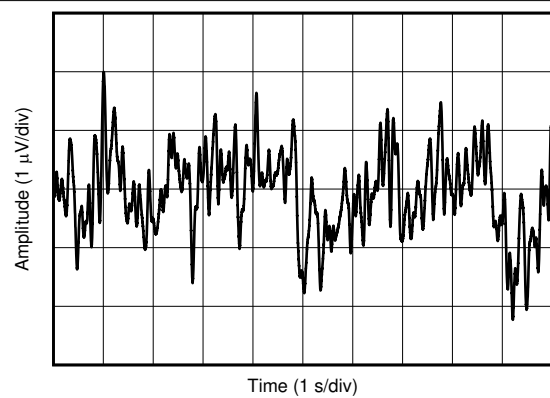

Figure 6-11. 0.1-Hz to 10-Hz Integrated Voltage Noise

6.7 Typical Characteristics (continued)

at $T_A = 25^\circ\text{C}$, $V_+ = 2.75\text{ V}$, $V_- = -2.75\text{ V}$, $R_L = 10\text{ k}\Omega$ connected to $V_S / 2$, $V_{CM} = V_S / 2$, and $V_{OUT} = V_S / 2$ (unless otherwise noted)

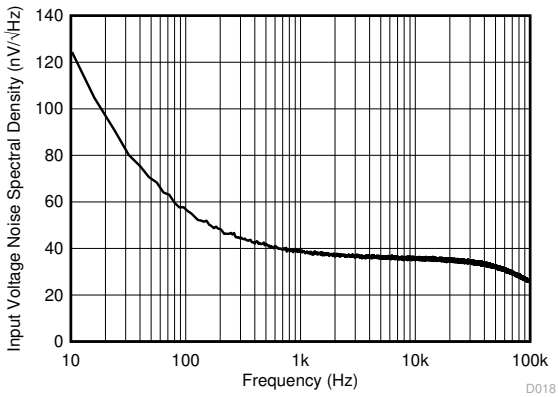

Figure 6-12. Input Voltage Noise Spectral Density

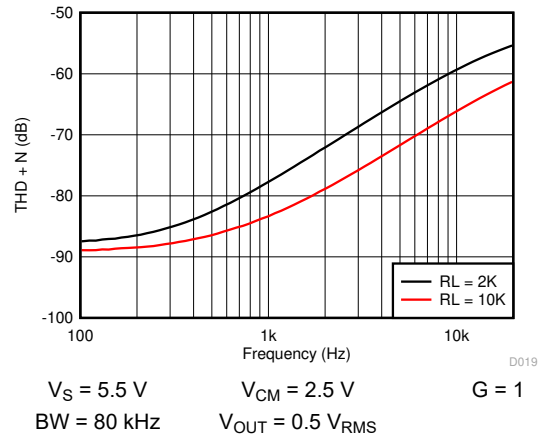

Figure 6-13. THD + N vs Frequency

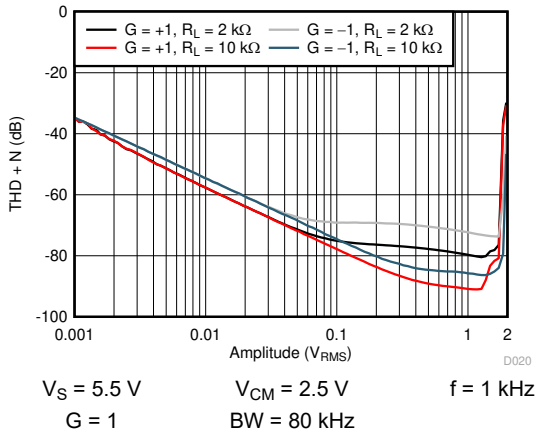

Figure 6-14. THD + N vs Amplitude

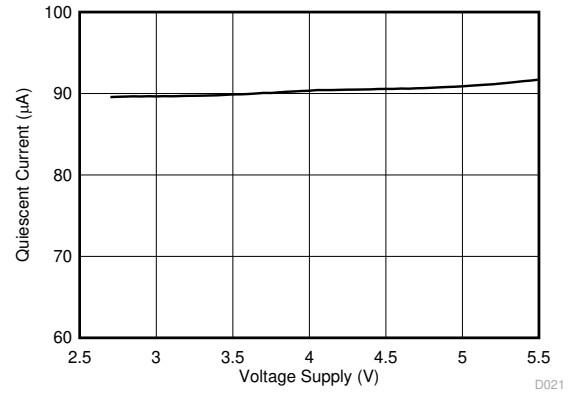

Figure 6-15. Quiescent Current vs Supply Voltage

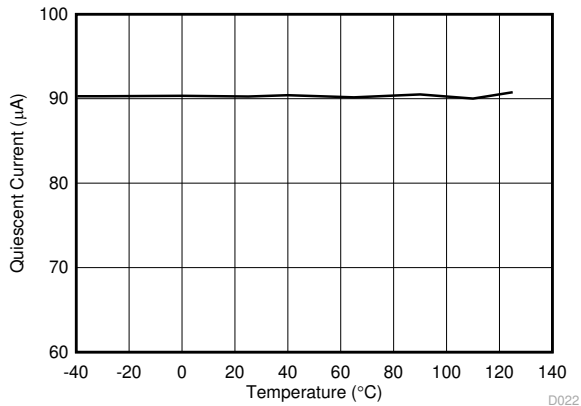

Figure 6-16. Quiescent Current vs Temperature

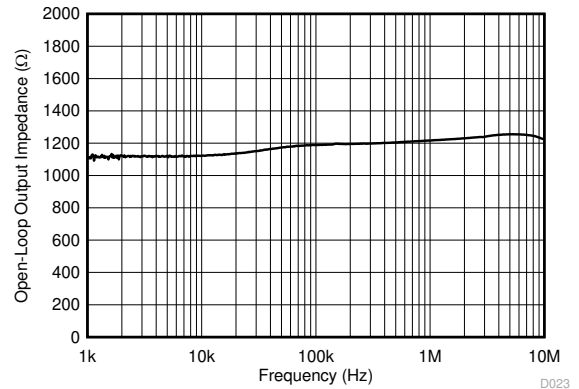
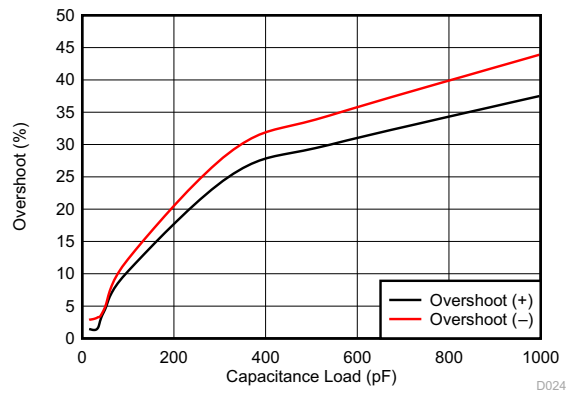

Figure 6-17. Open-Loop Output Impedance vs Frequency

6.7 Typical Characteristics (continued)

at $T_A = 25^\circ\text{C}$, $V_+ = 2.75\text{ V}$, $V_- = -2.75\text{ V}$, $R_L = 10\text{ k}\Omega$ connected to $V_S / 2$, $V_{CM} = V_S / 2$, and $V_{OUT} = V_S / 2$ (unless otherwise noted)



$G = 1$ $V_{IN} = 100\text{ mVpp}$
Figure 6-18. Small Signal Overshoot vs Capacitive Load

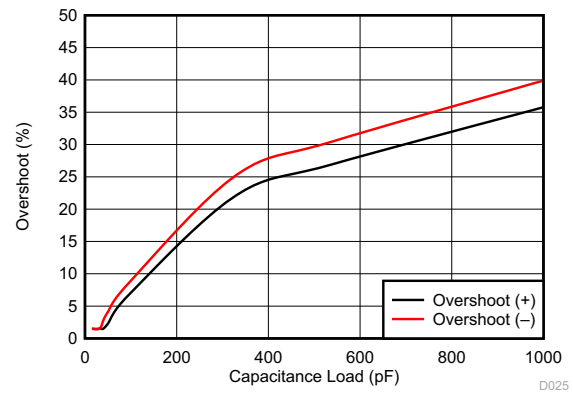

$G = -1$ $V_{IN} = 100\text{ mVpp}$
Figure 6-19. Small Signal Overshoot vs Capacitive Load

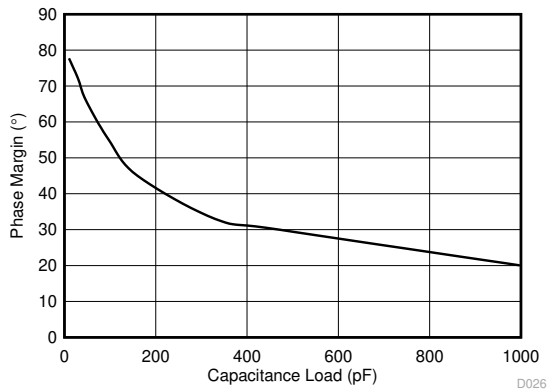
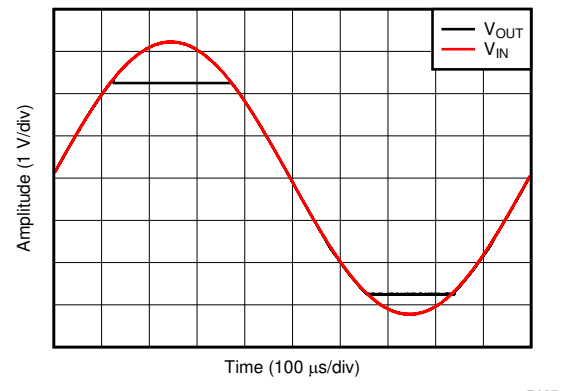
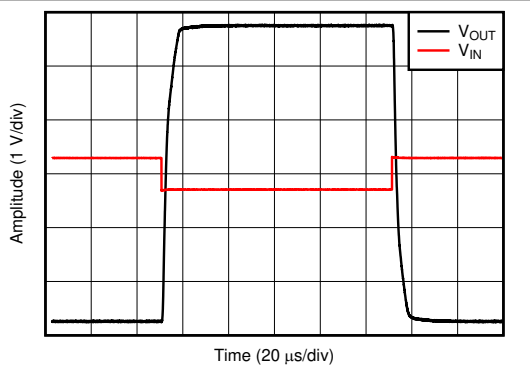

Figure 6-20. Phase Margin vs Capacitive Load



$G = 1$ $V_{IN} = 6.5\text{ Vpp}$

Figure 6-21. No Phase Reversal



$G = -10$ $V_{IN} = 600\text{ mVpp}$

Figure 6-22. Overload Recovery

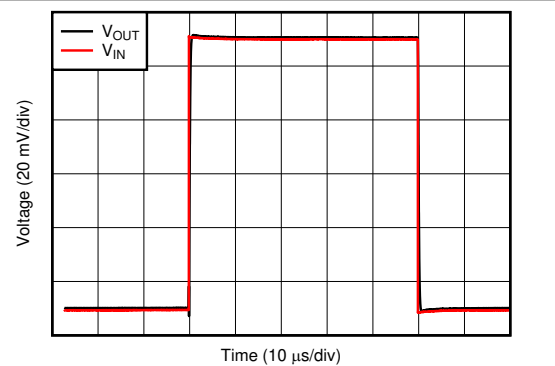

$G = 1$ $V_{IN} = 100\text{ mVpp}$ $C_L = 10\text{ pF}$

Figure 6-23. Small-Signal Step Response

6.7 Typical Characteristics (continued)

at $T_A = 25^\circ\text{C}$, $V_+ = 2.75\text{ V}$, $V_- = -2.75\text{ V}$, $R_L = 10\text{ k}\Omega$ connected to $V_S / 2$, $V_{CM} = V_S / 2$, and $V_{OUT} = V_S / 2$ (unless otherwise noted)

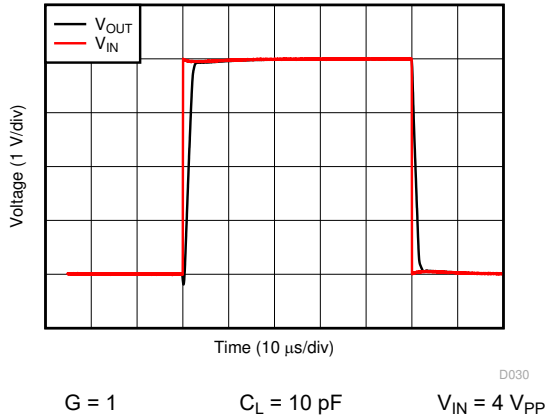

Figure 6-24. Large-Signal Step Response

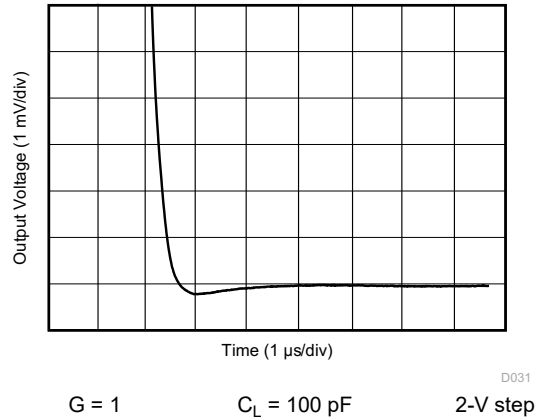

Figure 6-25. Large-Signal Settling Time (Negative)

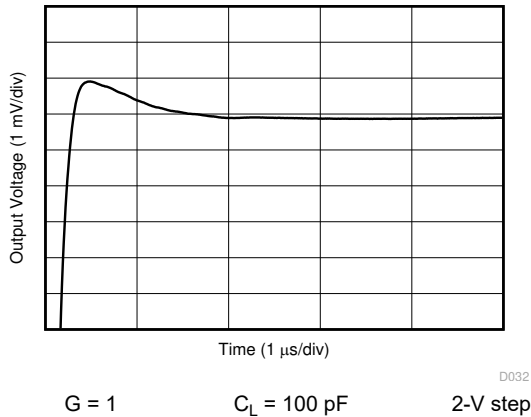

Figure 6-26. Large-Signal Settling Time (Positive)

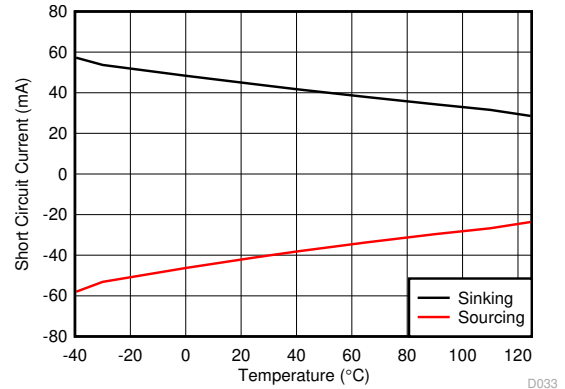

Figure 6-27. Short-Circuit Current vs Temperature

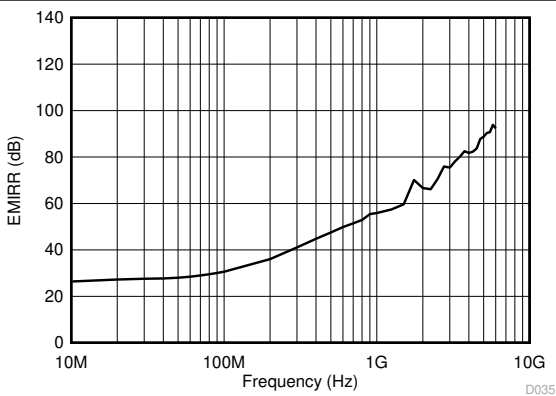

Figure 6-28. Electromagnetic Interference Rejection Ratio Referred to Noninverting Input (EMIRR+) vs Frequency

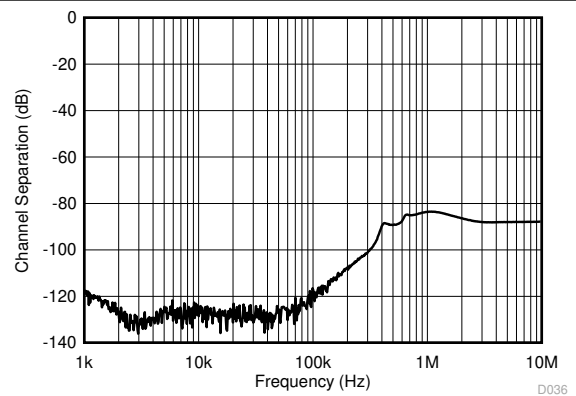

Figure 6-29. Channel Separation

7 Detailed Description

7.1 Overview

The LM290xLV-Q1 family of low-power op amps is intended for cost-optimized systems. These devices operate from 2.7 V to 5.5 V, are unity-gain stable, and are designed for a wide range of general-purpose automotive applications. The input common-mode voltage range includes the negative rail and allows the LM290xLV-Q1 family to be used in many single-supply applications.

7.2 Functional Block Diagram

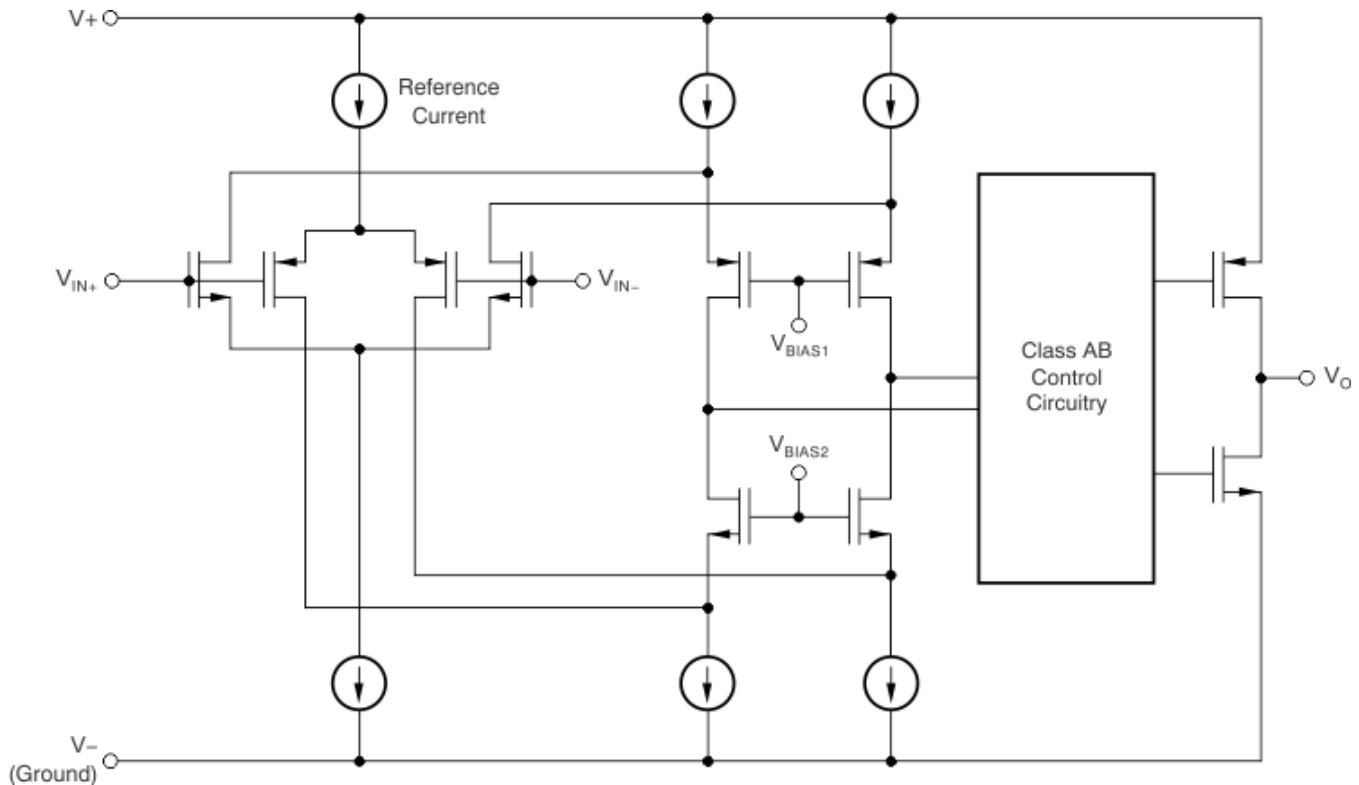

7.3 Feature Description

7.3.1 Operating Voltage

The LM290xLV-Q1 family of op amps is specified for operation from 2.7 V to 5.5 V. In addition, many specifications apply from -40°C to 125°C . Parameters that vary significantly with operating voltages or temperature are shown in the [Electrical Characteristics](#) section.

7.3.2 Common-Mode Input Range Includes Ground

The input common-mode voltage range of the LM290xLV-Q1 family extends to the negative supply rail and within 1 V below the positive rail for the full supply voltage range of 2.7 V to 5.5 V. This performance is achieved with a P-channel differential pair, as shown in the [Functional Block Diagram](#). Additionally, a complementary N-channel differential pair has been included in parallel to eliminate issues with phase reversal that are common with previous generations of op amps. However, the N-channel pair is not optimized for operation, and significant performance degradation occurs while this pair is operational. TI recommends limiting any voltage applied at the inputs to at least 1 V below the positive supply rail ($V+$) to ensure that the op amp conforms to the specifications detailed in the [Electrical Characteristics](#) section.

7.3.3 Overload Recovery

Overload recovery is defined as the time required for the operational amplifier output to recover from a saturated state to a linear state. The output transistors of the operational amplifier enter a saturation region when the output voltage exceeds the specified output voltage swing, because of the high input voltage or the high gain.

After the device enters the saturation region, the charge carriers in the output transistors require time to return to the linear state. After the charge carriers return to the linear state, the device begins to slew at the specified slew rate. Therefore, the propagation delay (in case of an overload condition) is the sum of the overload recovery time and the slew time. The overload recovery time for the LM290xLV-Q1 family is typically 1 μ s.

7.3.4 Electrical Overstress

Designers often ask questions about the capability of an operational amplifier to withstand electrical overstress. These questions tend to focus on the device inputs, but can also involve the supply voltage pins. Each of these different pin functions has electrical stress limits determined by the voltage breakdown characteristics of the particular semiconductor fabrication process and specific circuits connected to the pin. Additionally, internal electrostatic discharge (ESD) protection is built into these circuits to protect them from accidental ESD events both before and during product assembly.

Having a good understanding of this basic ESD circuitry and its relevance to an electrical overstress event is helpful. [Figure 7-1](#) shows the ESD circuits contained in the LM290xLV-Q1. The ESD protection circuitry involves several current-steering diodes connected from the input and output pins and routed back to the internal power supply lines, where they meet at an absorption device internal to the operational amplifier. This protection circuitry is intended to remain inactive during normal circuit operation.

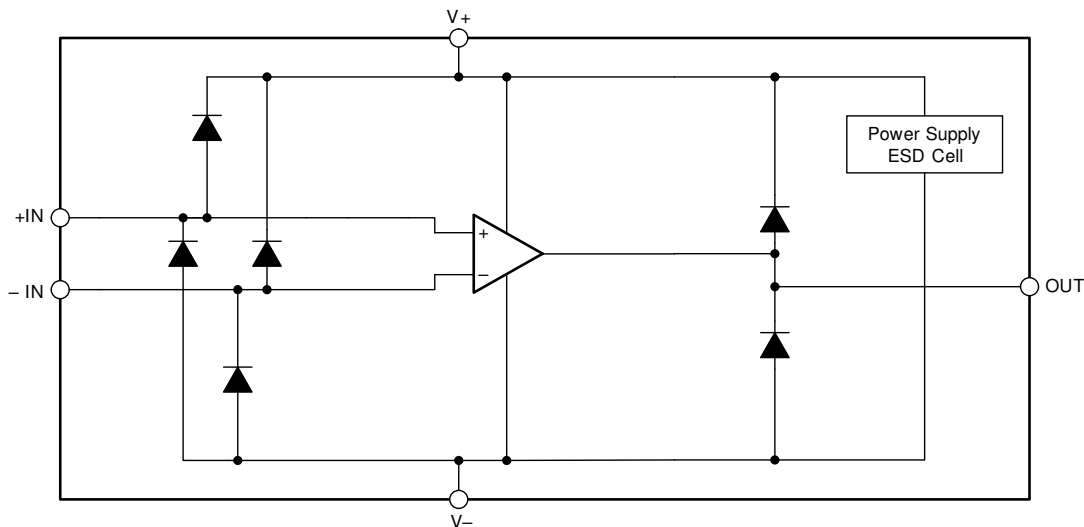

Figure 7-1. Equivalent Internal ESD Circuitry

7.3.5 EMI Susceptibility and Input Filtering

Texas Instruments has developed the ability to accurately measure and quantify the immunity of an operational amplifier over a broad frequency spectrum extending from 10 MHz to 6 GHz. The [Figure 6-28](#) plot illustrates the performance of the LM290xLV-Q1 family's EMI filters across a wide range of frequencies. For more detailed information, see [EMI Rejection Ratio of Operational Amplifiers](#) available for download from www.ti.com.

7.4 Device Functional Modes

The LM290xLV-Q1 family has a single functional mode. The devices are powered on as long as the power-supply voltage is between 2.7 V (± 1.35 V) and 5.5 V (± 2.75 V).

8 Application and Implementation

Note

Information in the following applications sections is not part of the TI component specification, and TI does not warrant its accuracy or completeness. TI's customers are responsible for determining suitability of components for their purposes, as well as validating and testing their design implementation to confirm system functionality.

8.1 Application Information

The LM290xLV-Q1 devices are a family of low-power, cost-optimized operational amplifiers. The devices operate from 2.7 V to 5.5 V, are unity-gain stable, and are suitable for a wide range of general-purpose automotive applications. The input common-mode voltage range includes the negative rail, and allows the LM290xLV-Q1 to be used in any single-supply applications.

8.2 Typical Application

Figure 8-1 shows the LM290xLV-Q1 device configured in a low-side current sensing application.

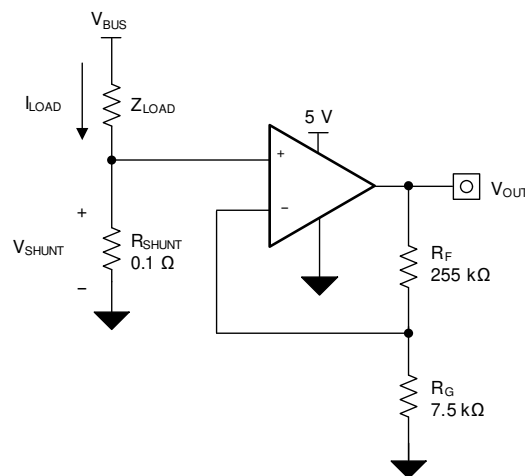

Figure 8-1. LM290xLV-Q1 Device in a Low-Side, Current-Sensing Application

8.2.1 Design Requirements

The design requirements for this design are:

- Load current: 0 A to 1 A
- Output voltage: 3.5 V
- Maximum shunt voltage: 100 mV

8.2.2 Detailed Design Procedure

The transfer function of the circuit in Figure 8-1 is given in Equation 1:

$$V_{OUT} = I_{LOAD} \times R_{SHUNT} \times \text{Gain} \quad (1)$$

The load current (I_{LOAD}) produces a voltage drop across the shunt resistor (R_{SHUNT}). The load current is set from 0 A to 1 A. To keep the shunt voltage below 100 mV at maximum load current, the largest allowable shunt resistor is shown using Equation 2:

$$R_{SHUNT} = \frac{V_{SHUNT_MAX}}{I_{LOAD_MAX}} = \frac{100\text{mV}}{1\text{A}} = 100\text{m}\Omega \quad (2)$$

Using Equation 2, R_{SHUNT} is calculated to be 100 mΩ. The voltage drop produced by I_{LOAD} and R_{SHUNT} is amplified by the LM290xLV-Q1 device to produce an output voltage of approximately 0 V to 3.5 V. The gain needed by the LM290xLV-Q1 to produce the necessary output voltage is calculated using Equation 3:

$$\text{Gain} = \frac{(V_{OUT_MAX} - V_{OUT_MIN})}{(V_{IN_MAX} - V_{IN_MIN})} \quad (3)$$

Using Equation 3, the required gain is calculated to be 35 V/V, which is set with resistors R_F and R_G . Equation 4 sizes the resistors R_F and R_G , to set the gain of the LM290xLV-Q1 device to 35 V/V.

$$\text{Gain} = 1 + \frac{(R_F)}{(R_G)} \quad (4)$$

8.2.3 Application Curve

Selecting R_F as 255 kΩ and R_G as 7.5 kΩ provides a combination that equals 35 V/V. Figure 8-2 shows the measured transfer function of the circuit shown in Figure 8-1. Notice that the gain is only a function of the feedback and gain resistors. This gain is adjusted by varying the ratio of the resistors and the actual resistors values are determined by the impedance levels that the designer wants to establish. The impedance level determines the current drain, the effect that stray capacitance has, and a few other behaviors. There is no optimal impedance selection that works for every system, you must choose an impedance that is ideal for your system parameters.

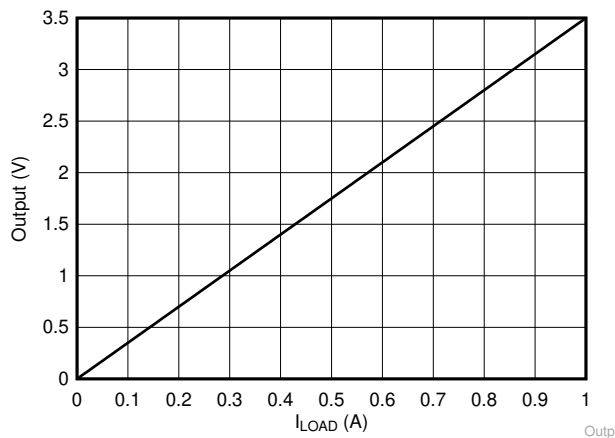

Figure 8-2. Low-Side, Current-Sense Transfer Function

9 Power Supply Recommendations

The LM290xLV-Q1 family is specified for operation from 2.7 V to 5.5 V (± 1.35 V to ± 2.75 V); many specifications apply from -40°C to 125°C . The [Electrical Characteristics](#) section presents parameters that may exhibit significant variance with regard to operating voltage or temperature.

CAUTION

Supply voltages larger than 6 V may permanently damage the device; see the [Absolute Maximum Ratings](#) section.

Place 0.1- μF bypass capacitors close to the power-supply pins to reduce coupling errors from noisy or high-impedance power supplies. For more detailed information on bypass capacitor placement, see the [Layout Guidelines](#) section.

9.1 Input and ESD Protection

The LM290xLV-Q1 family incorporates internal ESD protection circuits on all pins. For input and output pins, this protection primarily consists of current-steering diodes connected between the input and power-supply pins. These ESD protection diodes provide in-circuit, input overdrive protection, as long as the current is limited to 10 mA, as stated in the [Absolute Maximum Ratings](#) section. [Figure 9-1](#) shows how a series input resistor can be added to the driven input to limit the input current. The added resistor contributes thermal noise at the amplifier input and the value must be kept to a minimum in noise-sensitive applications.

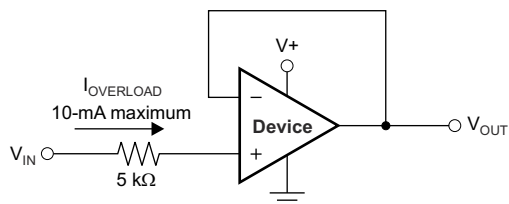

Figure 9-1. Input Current Protection

10 Layout

10.1 Layout Guidelines

For best operational performance of the device, use good printed circuit board (PCB) layout practices, including:

- Noise can propagate into analog circuitry through the power pins of the circuit as a whole and of the op amp itself. Bypass capacitors are used to reduce the coupled noise by providing low-impedance power sources local to the analog circuitry.
 - Connect low-ESR, 0.1- μF ceramic bypass capacitors between each supply pin and ground, placed as close to the device as possible. A single bypass capacitor from V^+ to ground is applicable for single-supply applications.
- Separate grounding for analog and digital portions of circuitry is one of the simplest and most effective methods of noise suppression. One or more layers on multilayer PCBs are usually devoted to ground planes. A ground plane helps distribute heat and reduces electromagnetic interference (EMI) noise pickup. Take care to physically separate digital and analog grounds. Use thermal signatures or EMI measurement techniques to determine where the majority of the ground current is flowing and be sure to route this path away from sensitive analog circuitry.
- To reduce parasitic coupling, run the input traces as far away from the supply or output traces as possible. If these traces cannot be kept separate, crossing the sensitive trace at a 90° angle is much better as opposed to running the traces in parallel with the noisy trace.
- Place the external components as close to the device as possible, as shown in [Figure 10-2](#). Keeping R_F and R_G close to the inverting input minimizes parasitic capacitance.
- Keep the length of input traces as short as possible. Remember that the input traces are the most sensitive part of the circuit.
- Consider a driven, low-impedance guard ring around the critical traces. A guard ring may significantly reduce leakage currents from nearby traces that are at different potentials.
- Cleaning the PCB following board assembly is recommended for best performance.
- Any precision integrated circuit can experience performance shifts resulting from moisture ingress into the plastic package. Following any aqueous PCB cleaning process, baking the PCB assembly is recommended to remove moisture introduced into the device packaging during the cleaning process. A low-temperature, post-cleaning bake at 85°C for 30 minutes is sufficient for most circumstances.

10.2 Layout Example

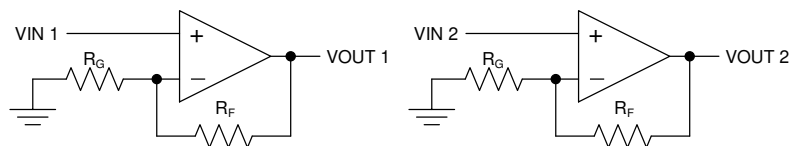

Figure 10-1. Schematic Representation

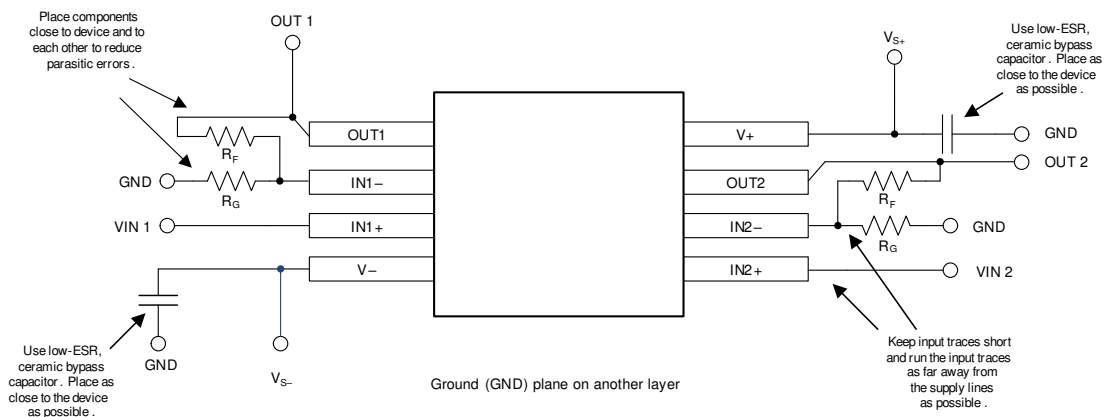

Figure 10-2. Layout Example

11 Device and Documentation Support

11.1 Documentation Support

11.1.1 Related Documentation

For related documentation, see the following:

- Texas Instruments, [EMI Rejection Ratio of Operational Amplifiers](#)

11.2 Related Links

The table below lists quick access links. Categories include technical documents, support and community resources, tools and software, and quick access to order now.

Table 11-1. Related Links

PARTS	PRODUCT FOLDER	ORDER NOW	TECHNICAL DOCUMENTS	TOOLS & SOFTWARE	SUPPORT & COMMUNITY
LM2902LV-Q1	Click here	Click here	Click here	Click here	Click here
LM2904LV-Q1	Click here	Click here	Click here	Click here	Click here

11.3 Receiving Notification of Documentation Updates

To receive notification of documentation updates, navigate to the device product folder on [ti.com](#). Click on *Subscribe to updates* to register and receive a weekly digest of any product information that has changed. For change details, review the revision history included in any revised document.

11.4 Support Resources

[TI E2E™ support forums](#) are an engineer's go-to source for fast, verified answers and design help — straight from the experts. Search existing answers or ask your own question to get the quick design help you need.

Linked content is provided "AS IS" by the respective contributors. They do not constitute TI specifications and do not necessarily reflect TI's views; see TI's [Terms of Use](#).

11.5 Trademarks

TI E2E™ is a trademark of Texas Instruments.

All trademarks are the property of their respective owners.

11.6 Electrostatic Discharge Caution



This integrated circuit can be damaged by ESD. Texas Instruments recommends that all integrated circuits be handled with appropriate precautions. Failure to observe proper handling and installation procedures can cause damage.

ESD damage can range from subtle performance degradation to complete device failure. Precision integrated circuits may be more susceptible to damage because very small parametric changes could cause the device not to meet its published specifications.

11.7 Glossary

[TI Glossary](#) This glossary lists and explains terms, acronyms, and definitions.

12 Mechanical, Packaging, and Orderable Information

The following pages include mechanical, packaging, and orderable information. This information is the most current data available for the designated devices. This data is subject to change without notice and revision of this document. For browser-based versions of this data sheet, refer to the left-hand navigation.

PACKAGING INFORMATION

Orderable Device	Status (1)	Package Type	Package Drawing	Pins	Package Qty	Eco Plan (2)	Lead finish/ Ball material (6)	MSL Peak Temp (3)	Op Temp (°C)	Device Marking (4/5)	Samples
LM2902LVQDRQ1	ACTIVE	SOIC	D	14	2500	RoHS & Green	NIPDAU	Level-2-260C-1 YEAR	-40 to 125	LM2902Q	Samples
LM2902LVQDYRQ1	ACTIVE	SOT-23-THIN	DYY	14	3000	RoHS & Green	NIPDAU	Level-1-260C-UNLIM	-40 to 125	LM2902Q	Samples
LM2902LVQPWRQ1	ACTIVE	TSSOP	PW	14	3000	RoHS & Green	NIPDAU	Level-1-260C-UNLIM	-40 to 125	LM2902	Samples
LM2904LVQDGKRQ1	ACTIVE	VSSOP	DGK	8	2500	RoHS & Green	NIPDAU	Level-1-260C-UNLIM	-40 to 125	27ET	Samples
LM2904LVQDRQ1	ACTIVE	SOIC	D	8	2500	RoHS & Green	NIPDAU	Level-1-260C-UNLIM	-40 to 125	L2904Q	Samples

(1) The marketing status values are defined as follows:

ACTIVE: Product device recommended for new designs.

LIFEBUY: TI has announced that the device will be discontinued, and a lifetime-buy period is in effect.

NRND: Not recommended for new designs. Device is in production to support existing customers, but TI does not recommend using this part in a new design.

PREVIEW: Device has been announced but is not in production. Samples may or may not be available.

OBSELETE: TI has discontinued the production of the device.

(2) **RoHS:** TI defines "RoHS" to mean semiconductor products that are compliant with the current EU RoHS requirements for all 10 RoHS substances, including the requirement that RoHS substance do not exceed 0.1% by weight in homogeneous materials. Where designed to be soldered at high temperatures, "RoHS" products are suitable for use in specified lead-free processes. TI may reference these types of products as "Pb-Free".

RoHS Exempt: TI defines "RoHS Exempt" to mean products that contain lead but are compliant with EU RoHS pursuant to a specific EU RoHS exemption.

Green: TI defines "Green" to mean the content of Chlorine (Cl) and Bromine (Br) based flame retardants meet JS709B low halogen requirements of <=1000ppm threshold. Antimony trioxide based flame retardants must also meet the <=1000ppm threshold requirement.

(3) MSL, Peak Temp. - The Moisture Sensitivity Level rating according to the JEDEC industry standard classifications, and peak solder temperature.

(4) There may be additional marking, which relates to the logo, the lot trace code information, or the environmental category on the device.

(5) Multiple Device Markings will be inside parentheses. Only one Device Marking contained in parentheses and separated by a "~" will appear on a device. If a line is indented then it is a continuation of the previous line and the two combined represent the entire Device Marking for that device.

(6) Lead finish/Ball material - Orderable Devices may have multiple material finish options. Finish options are separated by a vertical ruled line. Lead finish/Ball material values may wrap to two lines if the finish value exceeds the maximum column width.

Important Information and Disclaimer:The information provided on this page represents TI's knowledge and belief as of the date that it is provided. TI bases its knowledge and belief on information provided by third parties, and makes no representation or warranty as to the accuracy of such information. Efforts are underway to better integrate information from third parties. TI has taken and continues to take reasonable steps to provide representative and accurate information but may not have conducted destructive testing or chemical analysis on incoming materials and chemicals. TI and TI suppliers consider certain information to be proprietary, and thus CAS numbers and other limited information may not be available for release.

In no event shall TI's liability arising out of such information exceed the total purchase price of the TI part(s) at issue in this document sold by TI to Customer on an annual basis.

OTHER QUALIFIED VERSIONS OF LM2902LV-Q1, LM2904LV-Q1 :

- Catalog : [LM2902LV](#), [LM2904LV](#)

NOTE: Qualified Version Definitions:

- Catalog - TI's standard catalog product

TAPE AND REEL INFORMATION

QUADRANT ASSIGNMENTS FOR PIN 1 ORIENTATION IN TAPE

*All dimensions are nominal

Device	Package Type	Package Drawing	Pins	SPQ	Reel Diameter (mm)	Reel Width W1 (mm)	A0 (mm)	B0 (mm)	K0 (mm)	P1 (mm)	W (mm)	Pin1 Quadrant
LM2902LVQDRQ1	SOIC	D	14	2500	330.0	16.4	6.5	9.0	2.1	8.0	16.0	Q1
LM2902LVQDYRQ1	SOT-23-THIN	DYY	14	3000	330.0	12.4	4.8	3.6	1.6	8.0	12.0	Q3
LM2902LVQPWRQ1	TSSOP	PW	14	3000	330.0	12.4	6.9	5.6	1.6	8.0	12.0	Q1
LM2904LVQDGKRQ1	VSSOP	DGK	8	2500	330.0	12.4	5.3	3.4	1.4	8.0	12.0	Q1
LM2904LVQDRQ1	SOIC	D	8	2500	330.0	12.4	6.4	5.2	2.1	8.0	12.0	Q1

TAPE AND REEL BOX DIMENSIONS

*All dimensions are nominal

Device	Package Type	Package Drawing	Pins	SPQ	Length (mm)	Width (mm)	Height (mm)
LM2902LVQDRQ1	SOIC	D	14	2500	356.0	356.0	35.0
LM2902LVQDYRQ1	SOT-23-THIN	DYY	14	3000	336.6	336.6	31.8
LM2902LVQPWRQ1	TSSOP	PW	14	3000	356.0	356.0	35.0
LM2904LVQDGKRQ1	VSSOP	DGK	8	2500	366.0	364.0	50.0
LM2904LVQDRQ1	SOIC	D	8	2500	356.0	356.0	35.0

D (R-PDSO-G14)

PLASTIC SMALL OUTLINE



- NOTES:
- A. All linear dimensions are in inches (millimeters).
 - B. This drawing is subject to change without notice.
 - Body length does not include mold flash, protrusions, or gate burrs. Mold flash, protrusions, or gate burrs shall not exceed 0.006 (0,15) each side.
 - Body width does not include interlead flash. Interlead flash shall not exceed 0.017 (0,43) each side.
 - E. Reference JEDEC MS-012 variation AB.

PW (R-PDSO-G14)

PLASTIC SMALL OUTLINE



4040064-3/G 02/11

- NOTES:
- A. All linear dimensions are in millimeters. Dimensioning and tolerancing per ASME Y14.5M-1994.
 - B. This drawing is subject to change without notice.
 -  C. Body length does not include mold flash, protrusions, or gate burrs. Mold flash, protrusions, or gate burrs shall not exceed 0,15 each side.
 -  D. Body width does not include interlead flash. Interlead flash shall not exceed 0,25 each side.
 - E. Falls within JEDEC MO-153



D0008A

PACKAGE OUTLINE

SOIC - 1.75 mm max height

SMALL OUTLINE INTEGRATED CIRCUIT



4214825/C 02/2019

NOTES:

1. Linear dimensions are in inches [millimeters]. Dimensions in parenthesis are for reference only. Controlling dimensions are in inches. Dimensioning and tolerancing per ASME Y14.5M.
2. This drawing is subject to change without notice.
3. This dimension does not include mold flash, protrusions, or gate burrs. Mold flash, protrusions, or gate burrs shall not exceed $.006$ [0.15] per side.
4. This dimension does not include interlead flash.
5. Reference JEDEC registration MS-012, variation AA.

EXAMPLE BOARD LAYOUT

D0008A

SOIC - 1.75 mm max height

SMALL OUTLINE INTEGRATED CIRCUIT



LAND PATTERN EXAMPLE
 EXPOSED METAL SHOWN
 SCALE:8X



SOLDER MASK DETAILS

4214825/C 02/2019

NOTES: (continued)

- 6. Publication IPC-7351 may have alternate designs.
- 7. Solder mask tolerances between and around signal pads can vary based on board fabrication site.

EXAMPLE STENCIL DESIGN

D0008A

SOIC - 1.75 mm max height

SMALL OUTLINE INTEGRATED CIRCUIT



SOLDER PASTE EXAMPLE
BASED ON .005 INCH [0.125 MM] THICK STENCIL
SCALE:8X

4214825/C 02/2019

NOTES: (continued)

8. Laser cutting apertures with trapezoidal walls and rounded corners may offer better paste release. IPC-7525 may have alternate design recommendations.
9. Board assembly site may have different recommendations for stencil design.

DGK0008A



PACKAGE OUTLINE

VSSOP - 1.1 mm max height

SMALL OUTLINE PACKAGE



4214862/A 04/2023

NOTES:

PowerPAD is a trademark of Texas Instruments.

1. All linear dimensions are in millimeters. Any dimensions in parenthesis are for reference only. Dimensioning and tolerancing per ASME Y14.5M.
2. This drawing is subject to change without notice.
3. This dimension does not include mold flash, protrusions, or gate burrs. Mold flash, protrusions, or gate burrs shall not exceed 0.15 mm per side.
4. This dimension does not include interlead flash. Interlead flash shall not exceed 0.25 mm per side.
5. Reference JEDEC registration MO-187.

EXAMPLE BOARD LAYOUT

DGK0008A

™ VSSOP - 1.1 mm max height

SMALL OUTLINE PACKAGE



LAND PATTERN EXAMPLE
EXPOSED METAL SHOWN
SCALE: 15X



SOLDER MASK DETAILS

4214862/A 04/2023

NOTES: (continued)

6. Publication IPC-7351 may have alternate designs.
7. Solder mask tolerances between and around signal pads can vary based on board fabrication site.
8. Vias are optional depending on application, refer to device data sheet. If any vias are implemented, refer to their locations shown on this view. It is recommended that vias under paste be filled, plugged or tented.
9. Size of metal pad may vary due to creepage requirement.

EXAMPLE STENCIL DESIGN

DGK0008A

™ VSSOP - 1.1 mm max height

SMALL OUTLINE PACKAGE



SOLDER PASTE EXAMPLE
SCALE: 15X

4214862/A 04/2023

NOTES: (continued)

11. Laser cutting apertures with trapezoidal walls and rounded corners may offer better paste release. IPC-7525 may have alternate design recommendations.
12. Board assembly site may have different recommendations for stencil design.

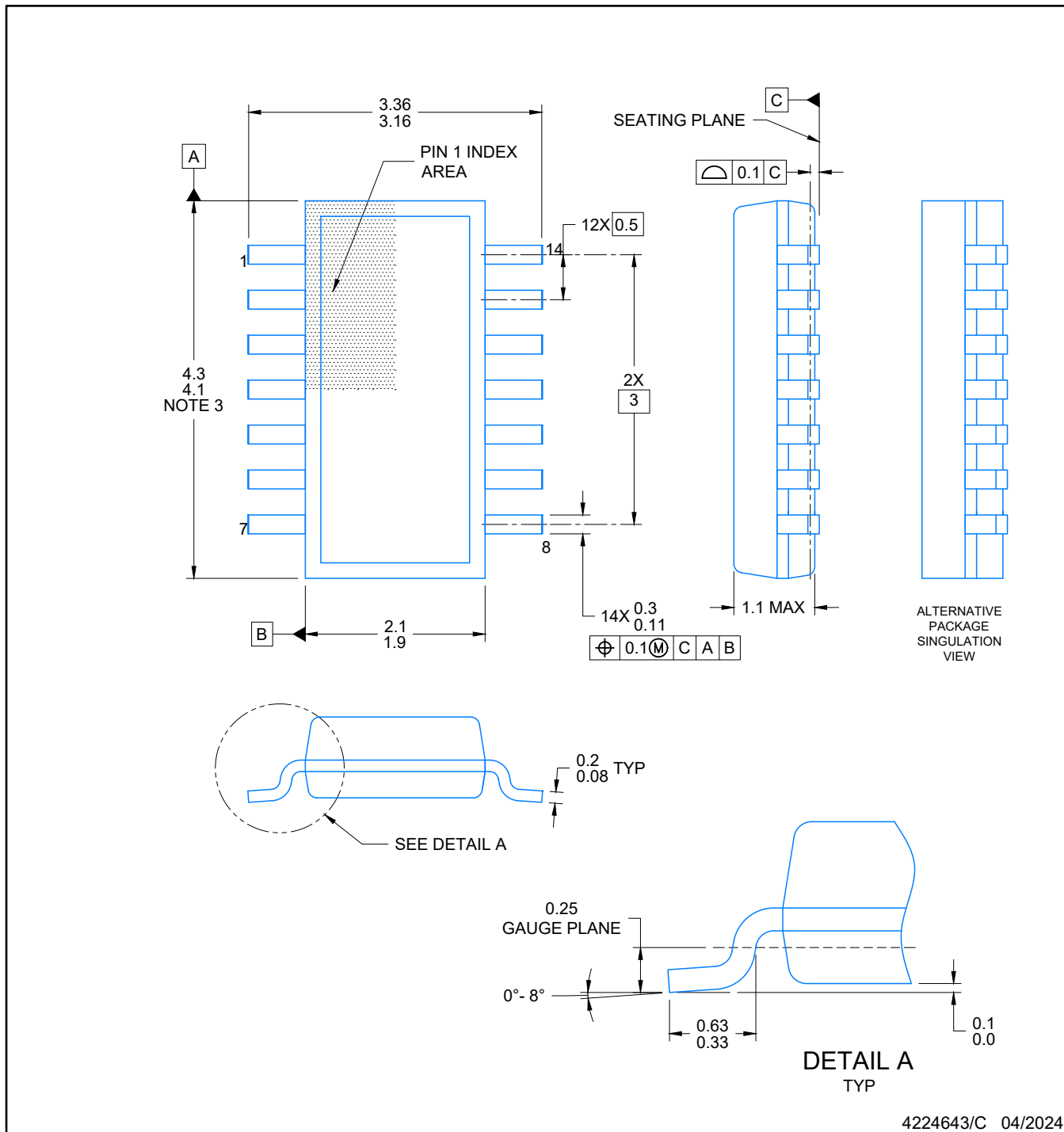

4224643/C 04/2024

NOTES:

1. All linear dimensions are in millimeters. Any dimensions in parenthesis are for reference only. Dimensioning and tolerancing per ASME Y14.5M.
2. This drawing is subject to change without notice.
3. This dimension does not include mold flash, protrusions, or gate burrs. Mold flash, protrusions, or gate burrs shall not exceed 0.15 per side.
4. This dimension does not include interlead flash. Interlead flash shall not exceed 0.50 per side.
5. Reference JEDEC Registration MO-345, Variation AB

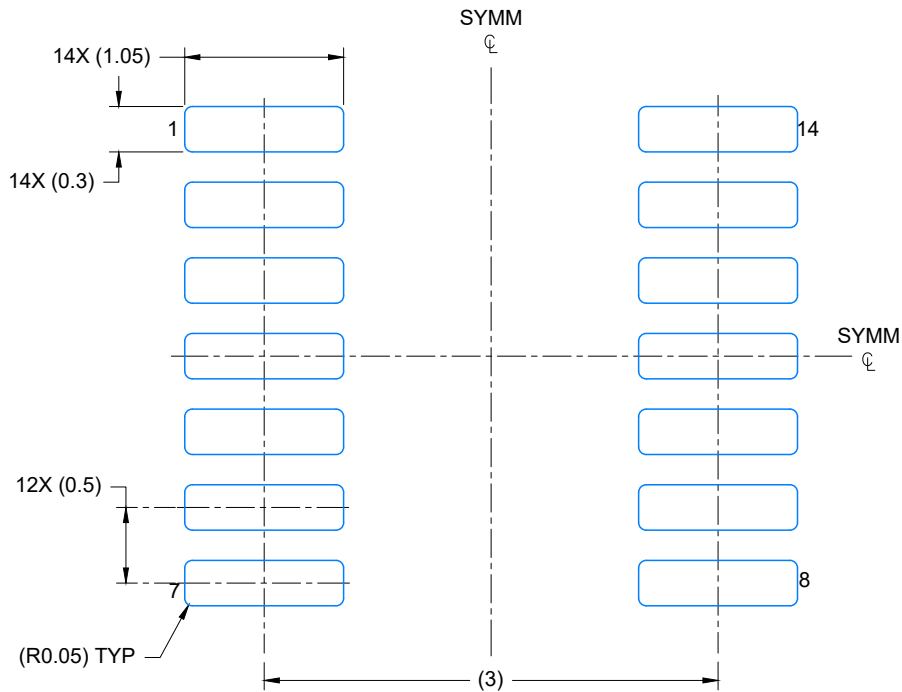

LAND PATTERN EXAMPLE
EXPOSED METAL SHOWN
SCALE: 20X

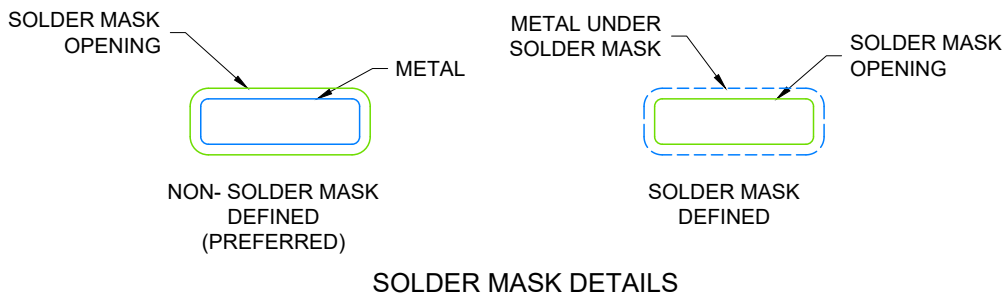

4224643/C 04/2024

NOTES: (continued)

- 6. Publication IPC-7351 may have alternate designs.
- 7. Solder mask tolerances between and around signal pads can vary based on board fabrication site.

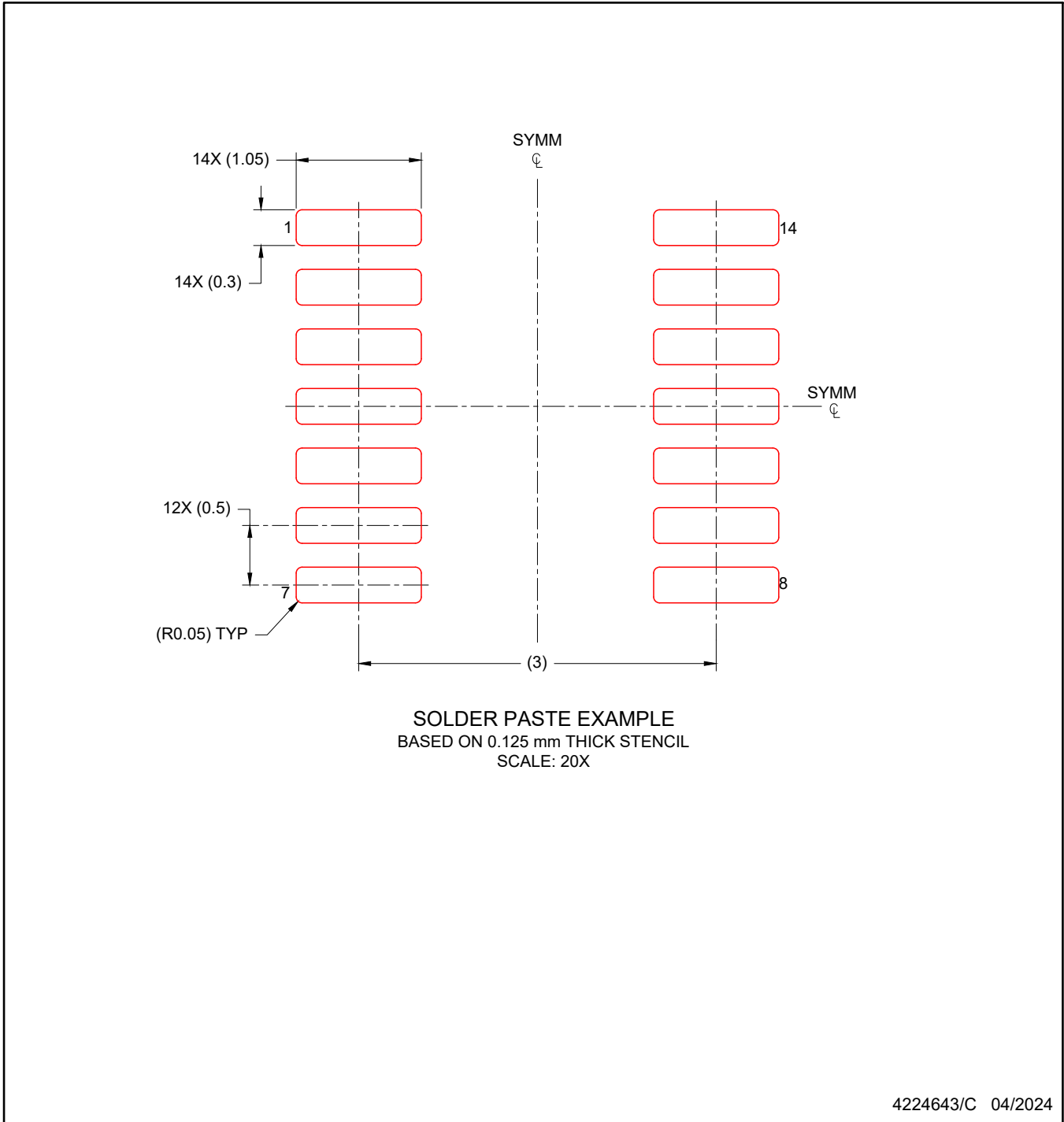

NOTES: (continued)

- 8. Laser cutting apertures with trapezoidal walls and rounded corners may offer better paste release. IPC-7525 may have alternate design recommendations.
- 9. Board assembly site may have different recommendations for stencil design.

IMPORTANT NOTICE AND DISCLAIMER

TI PROVIDES TECHNICAL AND RELIABILITY DATA (INCLUDING DATA SHEETS), DESIGN RESOURCES (INCLUDING REFERENCE DESIGNS), APPLICATION OR OTHER DESIGN ADVICE, WEB TOOLS, SAFETY INFORMATION, AND OTHER RESOURCES "AS IS" AND WITH ALL FAULTS, AND DISCLAIMS ALL WARRANTIES, EXPRESS AND IMPLIED, INCLUDING WITHOUT LIMITATION ANY IMPLIED WARRANTIES OF MERCHANTABILITY, FITNESS FOR A PARTICULAR PURPOSE OR NON-INFRINGEMENT OF THIRD PARTY INTELLECTUAL PROPERTY RIGHTS.

These resources are intended for skilled developers designing with TI products. You are solely responsible for (1) selecting the appropriate TI products for your application, (2) designing, validating and testing your application, and (3) ensuring your application meets applicable standards, and any other safety, security, regulatory or other requirements.

These resources are subject to change without notice. TI grants you permission to use these resources only for development of an application that uses the TI products described in the resource. Other reproduction and display of these resources is prohibited. No license is granted to any other TI intellectual property right or to any third party intellectual property right. TI disclaims responsibility for, and you will fully indemnify TI and its representatives against, any claims, damages, costs, losses, and liabilities arising out of your use of these resources.

TI's products are provided subject to [TI's Terms of Sale](#) or other applicable terms available either on [ti.com](https://www.ti.com) or provided in conjunction with such TI products. TI's provision of these resources does not expand or otherwise alter TI's applicable warranties or warranty disclaimers for TI products.

TI objects to and rejects any additional or different terms you may have proposed.

Mailing Address: Texas Instruments, Post Office Box 655303, Dallas, Texas 75265
Copyright © 2024, Texas Instruments Incorporated