

# LM4947 Boomer<sup>®</sup> Audio Power Amplifier Series Mono Class D and Stereo Audio Sub-System with OCL Headphone Amplifier and TI 3D

Check for Samples: [LM4947](#), [LM4947TLEVAL](#)

## FEATURES

- I<sup>2</sup>C Control Interface
- I<sup>2</sup>C Programmable Texas Instruments 3D Audio
- I<sup>2</sup>C Controlled 32 Step Digital Volume Control (-59.5dB to +18dB)
- Three Independent Volume Channels (Left, Right, Mono)
- Eight Distinct Output Modes
- Small, 25-Bump DSBGA Packaging
- “Click and Pop” Suppression Circuitry
- Thermal Shutdown Protection
- Low Shutdown Current (0.1µA, typ)
- RF Suppression
- Differential Mono and Stereo Inputs
- Stereo Input Mux

## KEY SPECIFICATIONS

- THD+N at 1kHz, 500mW into 8Ω BTL (3.3V): 1.0% (typ)
- THD+N at 1kHz, 37mW into 32Ω SE (3.3V): 1.0% (typ)
- Single Supply Operation (V<sub>DD</sub>): 2.7 to 5.5 V
- I<sup>2</sup>C Single Supply Operation: 2.2 to 5.5 V

## APPLICATIONS

- Mobile Phones
- PDAs

## DESCRIPTION

The LM4947 is an audio subsystem capable of efficiently delivering 500mW (Class D operation) of continuous average power into a mono 8Ω bridged-tied load (BTL) with 1% THD+N, 37mW (Class AB operation) power channel of continuous average power into stereo 32Ω single-ended (SE) loads with 1% THD+N, or an output capacitor-less (OCL) configuration with identical specification as the SE configuration, from a 3.3V power supply.

The LM4947 has six input channels: one pair for a two-channel stereo signal, the second pair for a secondary two-channel stereo input, and the third pair for a differential single-channel mono input. Additionally, the two sets of stereo inputs may be configured as a single stereo differential input (differential left and differential right). The LM4947 features a 32-step digital volume control and eight distinct output modes. The digital volume control, 3D enhancement, and output modes are programmed through a two-wire I<sup>2</sup>C compatible interface that allows flexibility in routing and mixing audio channels.

The RF suppression circuitry in the LM4947 makes it well-suited for GSM mobile phones and other portable applications in which strong RF signals generated by an antenna (and long output traces) may couple audibly into the amplifier.

The LM4947 is designed for cellular phones, PDAs, and other portable handheld applications. It delivers high quality output power from a surface-mount package and requires only eight external components in the OCL mode (two additional components in SE mode).



Please be aware that an important notice concerning availability, standard warranty, and use in critical applications of Texas Instruments semiconductor products and disclaimers thereto appears at the end of this data sheet.

All trademarks are the property of their respective owners.

TYPICAL APPLICATION

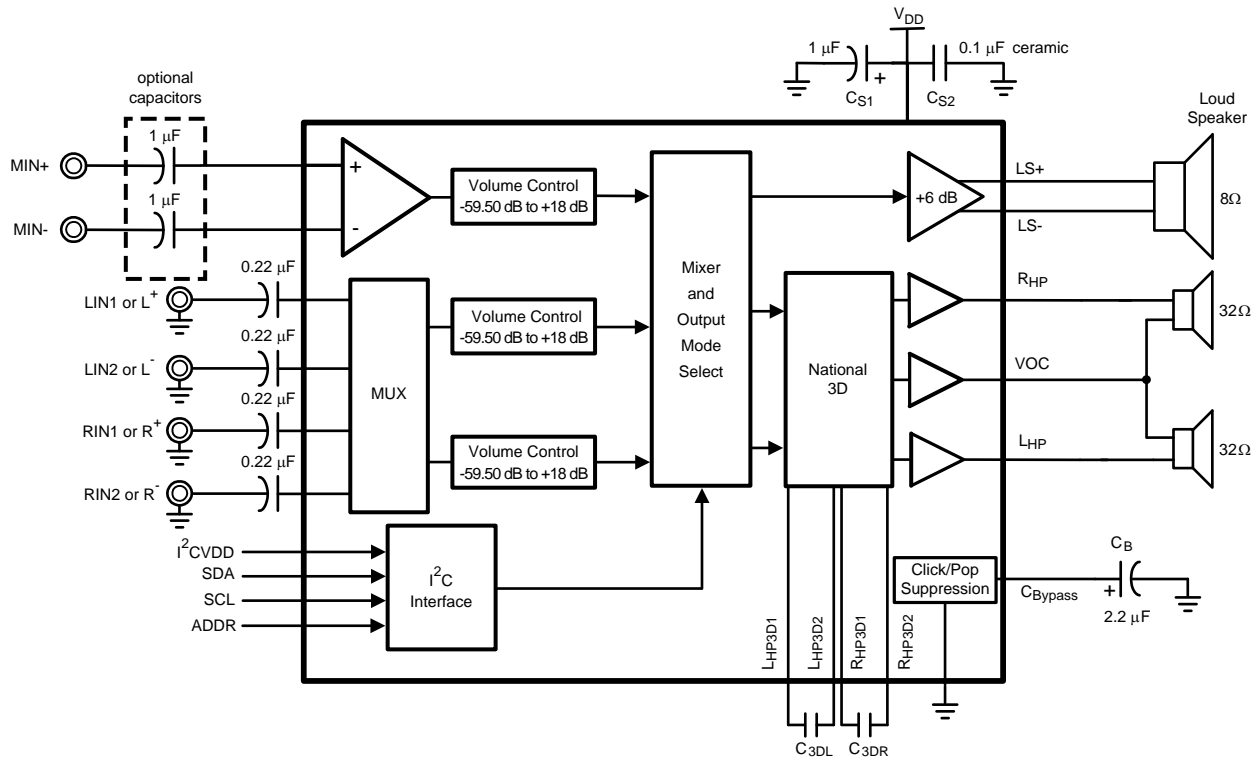

Figure 1. Typical Audio Amplifier Application Circuit-Output Capacitor-less

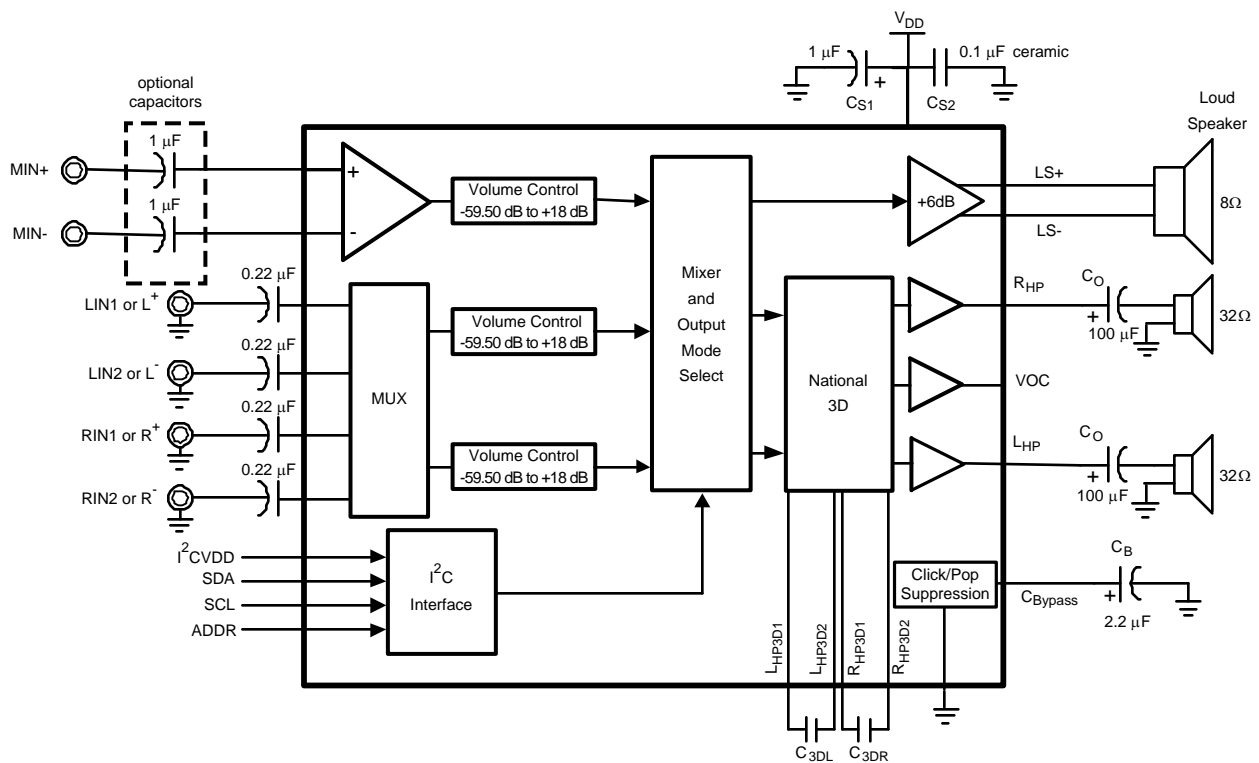
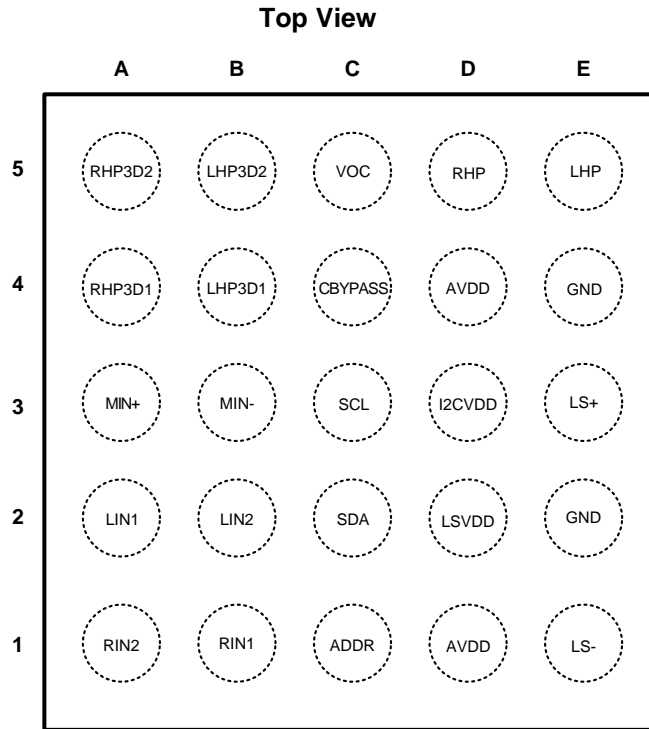

Figure 2. Typical Audio Amplifier Application Circuit-Single Ended

CONNECTION DIAGRAM



**Figure 3. 25-Bump DSBGA Package**  
See Package Number YZR0025BBA

**PIN DESCRIPTIONS**

Bump	Name	Description
A1	R <sub>IN2</sub>	Right Input Channel 2 or Right Differential Input –
A2	L <sub>IN1</sub>	Left Input Channel 1 or Left Differential Input +
A3	MIN+	Mono Channel Non-inverting Input
A4	RHP <sub>3D1</sub>	Right Headphone 3D Input 1
A5	RHP <sub>3D2</sub>	Right Headphone 3D Input 2
B1	R <sub>IN1</sub>	Right Input Channel 1 or Right Differential Input +
B2	L <sub>IN2</sub>	Left Input Channel 2 or Left Differential Input–
B3	MIN-	Mono Channel Inverting Input
B4	L <sub>HP3D1</sub>	Left Headphone 3D Input 2
B5	L <sub>HP3D2</sub>	Left Headphone 3D Input 1
C1	ADDR	Address Identification
C2	SDA	Serial Data Input
C3	SCL	Serial Clock Input
C4	C <sub>BYPASS</sub>	Half-Supply Bypass Capacitor
C5	VOC	Headphone return bias output
D1	AV <sub>DD</sub>	Analog Power Supply
D2	LSV <sub>DD</sub>	Loudspeaker Power Supply
D3	I2CV <sub>DD</sub>	I2C Interface Power Supply
D4	AV <sub>DD</sub>	Analog Power Supply
D5	R <sub>HP</sub>	Right Headphone Output
E1	LS-	Loudspeaker Output Negative
E2	GND	Ground
E3	LS+	Loudspeaker Output Positive
E4	GND	Ground
E5	L <sub>HP</sub>	Left Headphone Output



These devices have limited built-in ESD protection. The leads should be shorted together or the device placed in conductive foam during storage or handling to prevent electrostatic damage to the MOS gates.

**ABSOLUTE MAXIMUM RATINGS<sup>(1)(2)</sup>**

Supply Voltage		6.0V
Storage Temperature		-65°C to +150°C
Input Voltage		-0.3 to V <sub>DD</sub> +0.3
ESD Susceptibility <sup>(3)</sup>		2.0kV
ESD Machine model <sup>(4)</sup>		200V
Junction Temperature (T <sub>J</sub> )		150°C
Solder Information	Vapor Phase (60 sec.)	215°C
	Infrared (15 sec.)	220°C
Thermal Resistance	θ <sub>JA</sub> (typ) - YZR0025BBA	65°C/W

- (1) Operating Ratings indicate conditions for which the device is functional, but do not ensure specific performance limits. For ensured specifications and test conditions, see the Electrical Characteristics. The ensured specifications apply only for the test conditions listed. Some performance characteristics may degrade when the device is not operated under the listed test conditions.
- (2) If Military/Aerospace specified devices are required, please contact the Texas Instruments Sales Office/ Distributors for availability and specifications.
- (3) Human body model, 100pF discharged through a 1.5kΩ resistor.
- (4) Machine Model ESD test is covered by specification EIAJ IC-121-1981. A 200pF cap is charged to the specified voltage, then discharged directly into the IC with no external series resistor (resistance of discharge path must be under 50Ω).

**OPERATING RATINGS**

Temperature Range	-40°C to 85°C
Supply Voltage (V <sub>DD</sub> )	2.7V ≤ V <sub>DD</sub> ≤ 5.5V
Supply Voltage (I <sup>2</sup> C)	2.2V ≤ V <sub>DD</sub> ≤ 5.5V
Supply Voltage (Loudspeaker V <sub>DD</sub> )	2.7V ≤ V <sub>DD</sub> ≤ 5.5V

**ELECTRICAL CHARACTERISTICS 3.3V<sup>(1)(2)</sup>**

The following specifications apply for V<sub>DD</sub> = 3.3V, T<sub>A</sub> = 25°C, and all gains are set for 0dB unless otherwise specified.

Symbol	Parameter	Conditions	LM4947		Units (Limits)
			Typical <sup>(3)</sup>	Limits <sup>(4)</sup>	
I <sub>DDQ</sub>	Quiescent Supply Current	Output Modes 2, 4, 6 V <sub>IN</sub> = 0V; No load, OCL = 0 (Table 2)	4.5	6.5	mA (max)
		Output Modes 1, 3, 5, 7 V <sub>IN</sub> = 0V; No load, BTL, OCL = 0 (Table 2)	6.5	8	mA (max)
I <sub>SD</sub>	Shutdown Current	Output Mode 0	0.1	1	μA (max)
V <sub>OS</sub>	Output Offset Voltage	V <sub>IN</sub> = 0V, Mode 7, Mono	2	15	mV (max)
		V <sub>IN</sub> = 0V, Mode 7, Headphones	2	15	mV (max)
P <sub>O</sub>	Output Power	MONO <sub>OUT</sub> ; R <sub>L</sub> = 8Ω THD+N = 1%; f = 1kHz, BTL, Mode 1	500	400	mW (min)
		R <sub>OUT</sub> and L <sub>OUT</sub> ; R <sub>L</sub> = 32Ω THD+N = 1%; f = 1kHz, SE, Mode 4	37	33	mW (min)
THD+N	Total Harmonic Distortion Plus Noise	MONO <sub>OUT</sub> f = 1kHz, P <sub>OUT</sub> = 250mW; R <sub>L</sub> = 8Ω, BTL, Mode 1	0.03		%
		R <sub>OUT</sub> and L <sub>OUT</sub> f = 1kHz, P <sub>OUT</sub> = 12mW; R <sub>L</sub> = 32Ω, SE, Mode 4	0.02		%

- (1) Operating Ratings indicate conditions for which the device is functional, but do not ensure specific performance limits. For ensured specifications and test conditions, see the Electrical Characteristics. The ensured specifications apply only for the test conditions listed. Some performance characteristics may degrade when the device is not operated under the listed test conditions.
- (2) All voltages are measured with respect to the ground pin, unless otherwise specified.
- (3) Typical specifications are specified at +25°C and represent the most likely parametric norm.
- (4) Tested limits are specified to AOQL (Average Outgoing Quality Level).

**ELECTRICAL CHARACTERISTICS 3.3V<sup>(1)(2)</sup> (continued)**

The following specifications apply for  $V_{DD} = 3.3V$ ,  $T_A = 25^\circ C$ , and all gains are set for 0dB unless otherwise specified.

Symbol	Parameter	Conditions	LM4947		Units (Limits)	
			Typical <sup>(3)</sup>	Limits <sup>(4)</sup>		
N <sub>OUT</sub>	Output Noise	A-weighted, 0dB inputs terminated, output referred				
		Speaker; Mode 1	39		μV	
		Speaker; Mode 3	39		μV	
		Speaker; Mode 5	42		μV	
		Speaker; Mode 7	38		μV	
		Headphone; SE, Mode 2	15		μV	
		Headphone; SE, Mode 4	15		μV	
		Headphone; SE, Mode 6	17		μV	
		Headphone; OCL, Mode 2	12		μV	
		Headphone; OCL, Mode 4	15		μV	
		Headphone; OCL, Mode 6	17		μV	
PSRR	Power Supply Rejection Ratio Loudspeaker out	V <sub>RIIPPLE</sub> = 200mV <sub>PP</sub> ; f = 217Hz, R <sub>L</sub> = 8Ω, C <sub>B</sub> = 2.2μF, BTL All audio inputs terminated to GND; output referred				
		BTL, Output Mode 1	79		dB	
		BTL, Output Mode 3	78		dB	
		BTL, Output Mode 5	79		dB	
			BTL, Output Mode 7	80		dB
	Power Supply Rejection Ratio R <sub>OUT</sub> and L <sub>OUT</sub>	V <sub>RIIPPLE</sub> = 200mV <sub>PP</sub> ; f = 217Hz, R <sub>L</sub> = 32Ω, C <sub>B</sub> = 2.2μF, BTL All audio inputs terminated to GND; output referred				
		SE, Output Mode 2	78		dB	
		SE, Output Mode 4	71		dB	
		SE, Output Mode 6	71		dB	
		OCL, Output Mode 2	83		dB	
OCL, Output Mode 4		74		dB		
		OCL, Output Mode 6	74		dB	
η	Class D Efficiency	Output Mode 1, 3, 5	86		%	
CMRR	Common-Mode-Rejection Ratio	f = 217Hz, V <sub>CM</sub> = 1V <sub>pp</sub> , Mode 1, BTL, R <sub>L</sub> = 8Ω	-49		dB	
XTALK	Crosstalk	Headphone, P <sub>O</sub> = 12mW, f = 1kHz, OCL, Mode 4, R <sub>L</sub> = 32Ω	-58		dB	
		Headphone, P <sub>O</sub> = 12mW, f = 1kHz, SE, Mode 4, R <sub>L</sub> = 32Ω	-73		dB	
T <sub>WU</sub>	Wake-Up Time from Shutdown	C <sub>B</sub> = 2.2μF, OCL, R <sub>L</sub> = 32Ω	90		ms	
		C <sub>B</sub> = 2.2μF, SE, R <sub>L</sub> = 32Ω	115		ms	
	Volume Control Step Size Error		±0.2		dB	
	Digital Volume Range	Input referred maximum attenuation	-59.5	-60.25 -58.75	dB (min) dB (max)	
		Input referred maximum gain	+18	17.25 18.75	dB (min) dB (max)	
	Mute Attenuation	Output Mode 1, 3, 5	87		dB (min)	
	MONO_IN Input Impedance R <sub>IN</sub> and L <sub>IN</sub> Input Impedance	Maximum gain setting	12	8 14	kΩ (min) kΩ (max)	
		Maximum attenuation setting	100	75 125	kΩ (min) kΩ (max)	

**ELECTRICAL CHARACTERISTICS 5V<sup>(1)(2)</sup>**

 The following specifications apply for  $V_{DD} = 5V$ ,  $T_A = 25^\circ C$  and all gains are set for 0dB unless otherwise specified.

Symbol	Parameter	Conditions	LM4947		Units (Limits)
			Typical <sup>(3)</sup>	Limits <sup>(4)</sup>	
$I_{DDQ}$	Quiescent Supply Current	Output Modes 2, 4, 6 $V_{IN} = 0V$ ; No load, OCL = 0 (Table 2)	5.4	7.5	mA
		Output Modes 1, 3, 5, 7 $V_{IN} = 0V$ ; No load, BTL, OCL = 0 (Table 2)	7.6	12	mA
$I_{SD}$	Shutdown Current	Output Mode 0	0.1	1	$\mu A$ (max)
$V_{OS}$	Output Offset Voltage	$V_{IN} = 0V$ , Mode 7, Mono	2	15	mV (max)
		$V_{IN} = 0V$ , Mode 7, Headphones	2	15	mV (max)
$P_O$	Output Power	MONO <sub>OUT</sub> ; $R_L = 8\Omega$ THD+N = 1%; $f = 1kHz$ , BTL, Mode 1	1.19		W
		$R_{OUT}$ and $L_{OUT}$ ; $R_L = 32\Omega$ THD+N = 1%; $f = 1kHz$ , SE, Mode 4	87		mW
THD+N	Total Harmonic Distortion + Noise	MONO <sub>OUT</sub> $f = 1kHz$ , $P_{OUT} = 500mW$ ; $R_L = 8\Omega$ , BTL, Mode 1	0.04		%
		$R_{OUT}$ and $L_{OUT}$ $f = 1kHz$ , $P_{OUT} = 30mW$ ; $R_L = 32\Omega$ , SE, Mode 4	0.01		%
$N_{OUT}$	Output Noise	A-weighted, 0dB inputs terminated, output referred			
		Speaker; Mode 1	38		$\mu V$
		Speaker; Mode 3	38		$\mu V$
		Speaker; Mode 5	39		$\mu V$
		Speaker; Mode 7	36		$\mu V$
		Headphone; SE, Mode 2	21		$\mu V$
		Headphone; SE, Mode 4	21		$\mu V$
		Headphone; SE, Mode 6	24		$\mu V$
		Headphone; OCL, Mode 2	16		$\mu V$
		Headphone; OCL, Mode 4	16		$\mu V$
	Headphone; OCL, Mode 6	19		$\mu V$	

- (1) Operating Ratings indicate conditions for which the device is functional, but do not ensure specific performance limits. For ensured specifications and test conditions, see the Electrical Characteristics. The ensured specifications apply only for the test conditions listed. Some performance characteristics may degrade when the device is not operated under the listed test conditions.
- (2) All voltages are measured with respect to the ground pin, unless otherwise specified.
- (3) Typical specifications are specified at  $+25^\circ C$  and represent the most likely parametric norm.
- (4) Tested limits are specified to AOQL (Average Outgoing Quality Level).

**ELECTRICAL CHARACTERISTICS 5V<sup>(1)(2)</sup> (continued)**

The following specifications apply for  $V_{DD} = 5V$ ,  $T_A = 25^\circ C$  and all gains are set for 0dB unless otherwise specified.

Symbol	Parameter	Conditions	LM4947		Units (Limits)
			Typical <sup>(3)</sup>	Limits <sup>(4)</sup>	
PSRR	Power Supply Rejection Ratio Loudspeaker out	$V_{RIPPLE} = 200mV_{PP}$ ; $f = 217Hz$ , $R_L = 8\Omega$ , $C_B = 2.2\mu F$ , BTL All audio inputs terminated to GND; output referred			
		BTL, Output Mode 1	70		dB
		BTL, Output Mode 3	61		dB
		BTL, Output Mode 5	64		dB
		BTL, Output Mode 7	61		dB
	Power Supply Rejection Ratio $R_{OUT}$ and $L_{OUT}$	$V_{RIPPLE} = 200mV_{PP}$ ; $f = 217Hz$ , $R_L = 32\Omega$ , $C_B = 2.2\mu F$ , BTL All audio inputs terminated to GND; output referred			
		SE, Output Mode 2	72		dB
		SE, Output Mode 4	70		dB
		SE, Output Mode 6	65		dB
		OCL, Output Mode 2	76		dB
OCL, Output Mode 4		72		dB	
OCL, Output Mode 6	70		dB		
$\eta$	Class D Efficiency	Output Mode 1, 3, 5	86		%
CMRR	Common-Mode Rejection Ratio	$f = 1kHz$ , $V_{CM} = 1V_{pp}$ , 0dB gain, Mode 1, BTL, $R_L = 8\Omega$	-49		dB
XTALK	Crosstalk	Headphone, $P_O = 30mW$ , $f = 1kHz$ , OCL, Mode 4	-55		dB
		Headphone, $P_O = 30mW$ , $f = 1kHz$ , SE, Mode 4	-72		dB
$T_{WU}$	Wake-Up Time from Shutdown	$C_B = 2.2\mu F$ , OCL, $R_L = 32\Omega$	116		ms
		$C_B = 2.2\mu F$ , SE, $R_L = 32\Omega$	150		ms
	Volume Control Step Size Error		$\pm 0.2$		dB
	Digital Volume Range	Input referred maximum attenuation	-59.5		dB
		Input referred maximum gain	+18		dB
	Mute Attenuation	Output Mode 1, 3, 5	90		dB (min)
	MONO_IN Input Impedance $R_{IN}$ and $L_{IN}$ Input Impedance	Maximum gain setting	11		k $\Omega$ (min) k $\Omega$ (max)
		Maximum attenuation setting	100		k $\Omega$ (min) k $\Omega$ (max)



## I<sup>2</sup>C<sup>(1)(2)</sup>

The following specifications apply for  $V_{DD} = 5V$  and  $3.3V$ ,  $T_A = 25^\circ C$  unless otherwise specified.

Symbol	Parameter	Conditions	LM4947		Units (Limits)
			Typical <sup>(3)</sup>	Limits <sup>(4)</sup>	
$t_1$	Clock Period			2.5	$\mu s$ (max)
$t_2$	Clock Setup Time			100	ns (min)
$t_3$	Data Hold Time			100	ns (min)
$t_4$	Start Condition Time			100	ns (min)
$t_5$	Stop Condition Time			100	ns (min)
$V_{IH}$	SPI Input Voltage High			$0.7 \times V_{DD}$	V (min)
$V_{IL}$	SPI Input Voltage Low			$0.3 \times V_{DD}$	V (max)

- (1) Operating Ratings indicate conditions for which the device is functional, but do not ensure specific performance limits. For ensured specifications and test conditions, see the Electrical Characteristics. The ensured specifications apply only for the test conditions listed. Some performance characteristics may degrade when the device is not operated under the listed test conditions.
- (2) All voltages are measured with respect to the ground pin, unless otherwise specified.
- (3) Typical specifications are specified at  $+25^\circ C$  and represent the most likely parametric norm.
- (4) Tested limits are specified to AOQL (Average Outgoing Quality Level).

## I<sup>2</sup>C Protocol Information

The I<sup>2</sup>C address for the LM4947 is determined using the ID\_ENB pin. The LM4947's two possible I<sup>2</sup>C chip addresses are of the form 11110X<sub>1</sub>0 (binary), where  $X_1 = 0$ , if ID\_ADDR is logic LOW; and  $X_1 = 1$ , if ID\_ENB is logic HIGH. If the I<sup>2</sup>C interface is used to address a number of chips in a system, the LM4947's chip address can be changed to avoid any possible address conflicts.

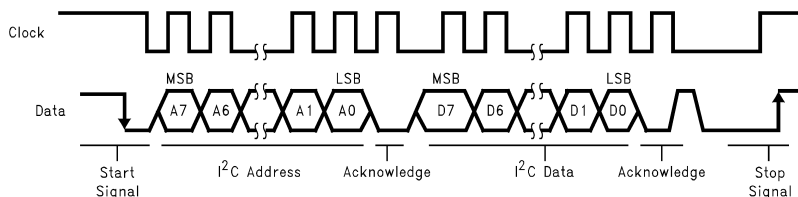

Figure 4. I<sup>2</sup>C Bus Format

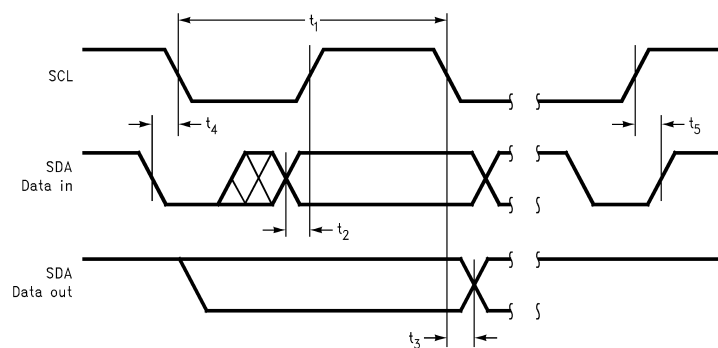

Figure 5. I<sup>2</sup>C Timing Diagram

TYPICAL PERFORMANCE CHARACTERISTICS

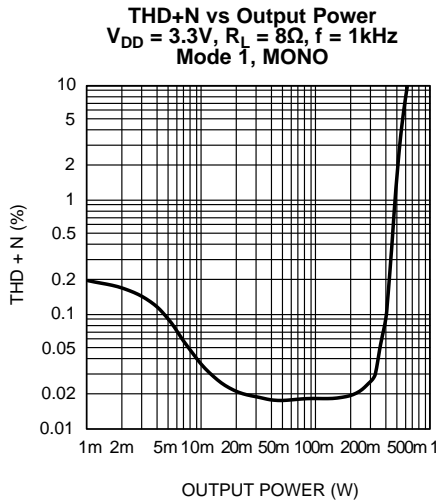

Figure 6.

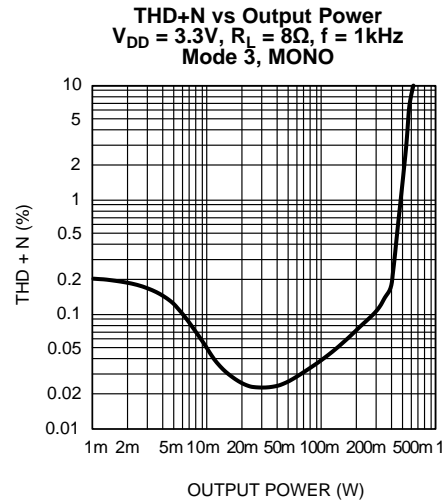

Figure 7.

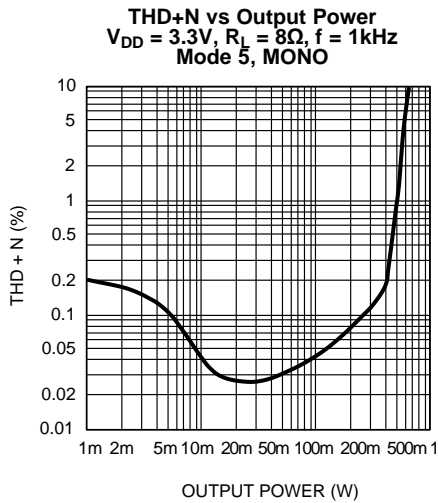

Figure 8.

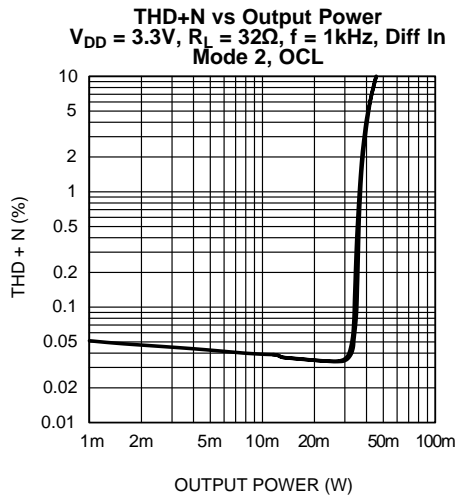

Figure 9.

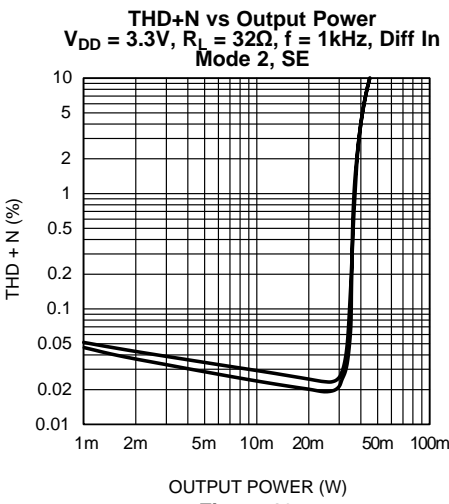

Figure 10.

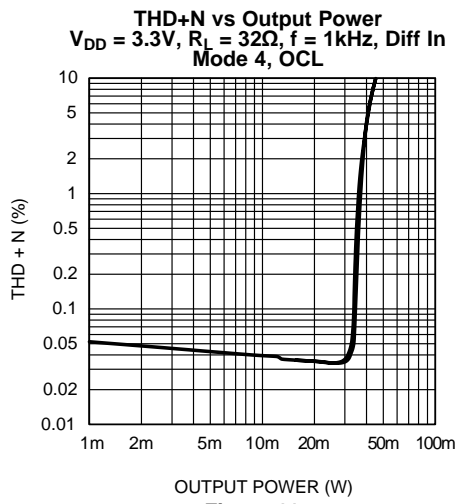

Figure 11.

**TYPICAL PERFORMANCE CHARACTERISTICS (continued)**

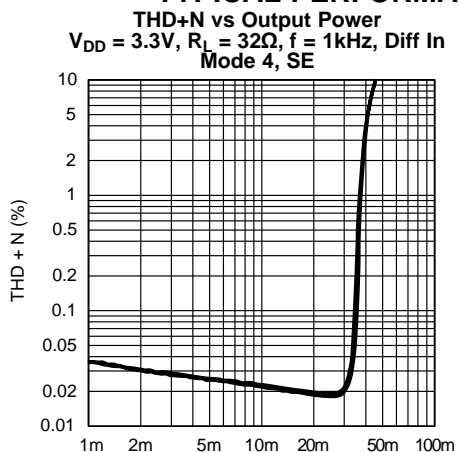

Figure 12.

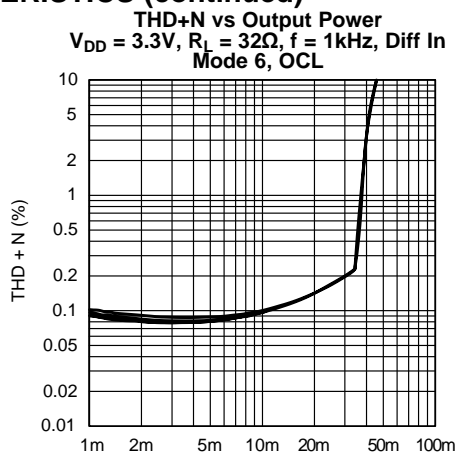

Figure 13.

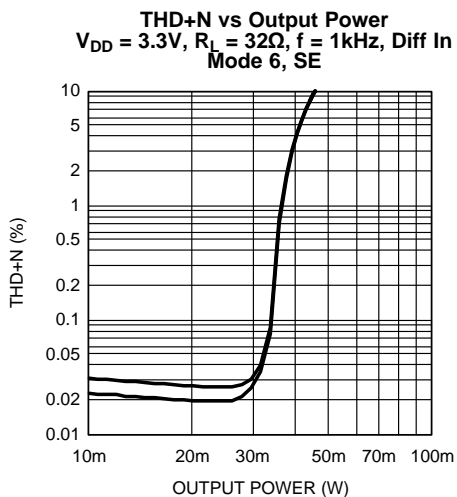

Figure 14.

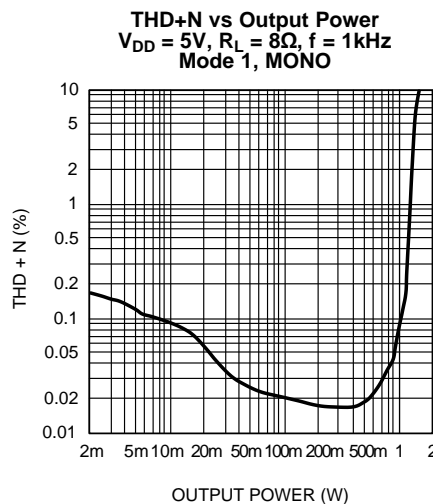

Figure 15.

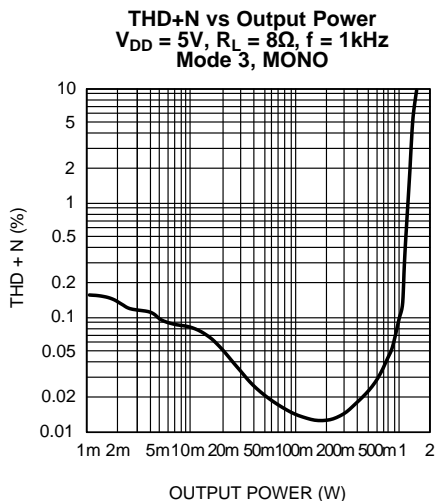

Figure 16.

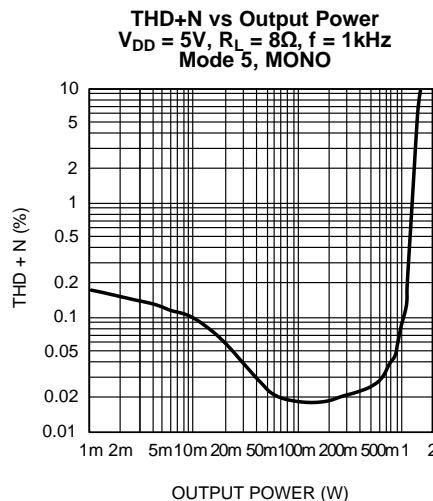
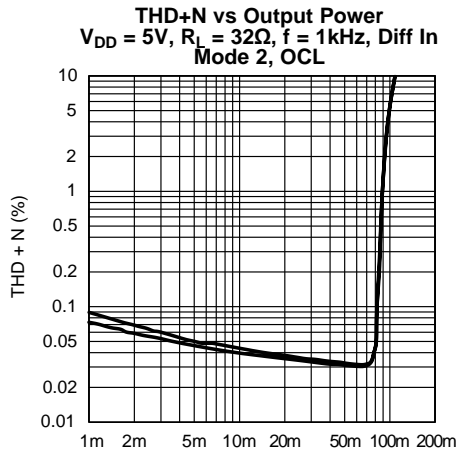
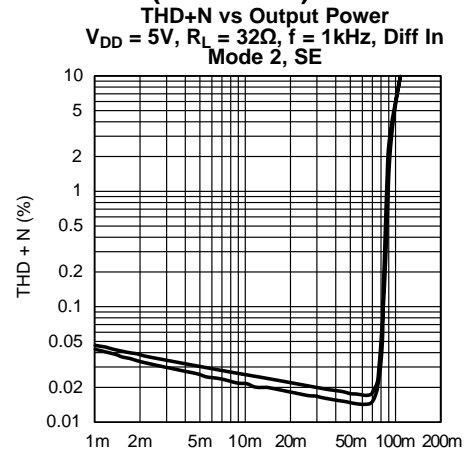

Figure 17.

**TYPICAL PERFORMANCE CHARACTERISTICS (continued)**



OUTPUT POWER (W)  
**Figure 18.**



OUTPUT POWER (W)  
**Figure 19.**

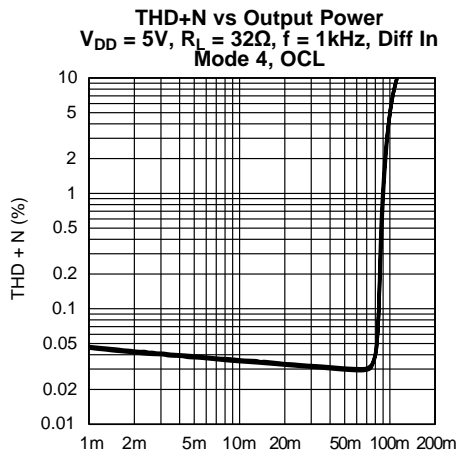

OUTPUT POWER (W)  
**Figure 20.**

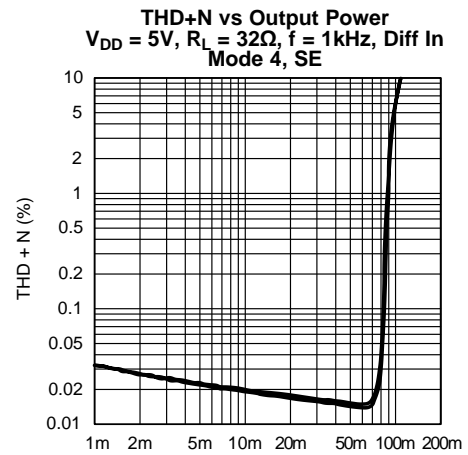

OUTPUT POWER (W)  
**Figure 21.**

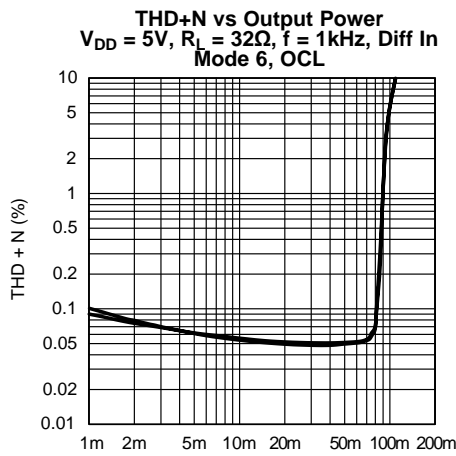

OUTPUT POWER (W)  
**Figure 22.**

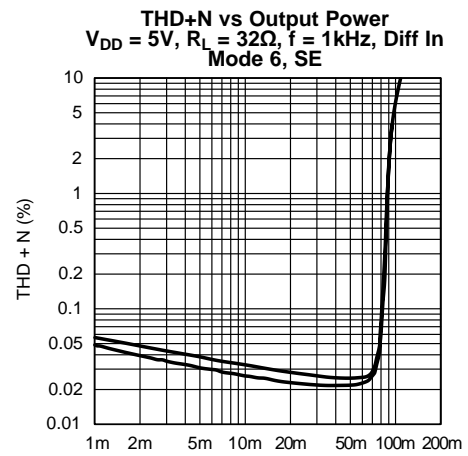

OUTPUT POWER (W)  
**Figure 23.**

**TYPICAL PERFORMANCE CHARACTERISTICS (continued)**

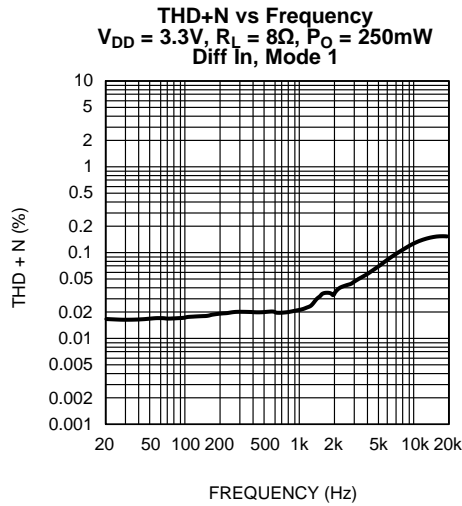

Figure 24.

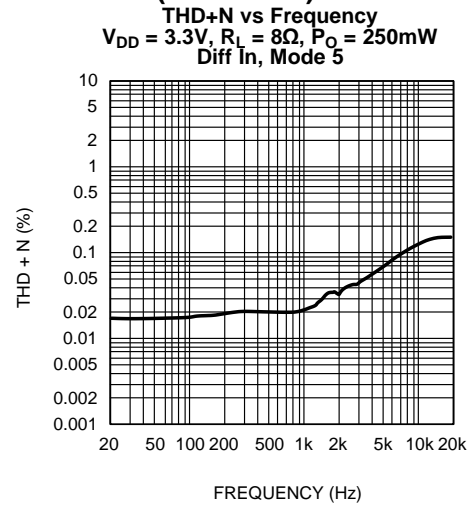

Figure 25.

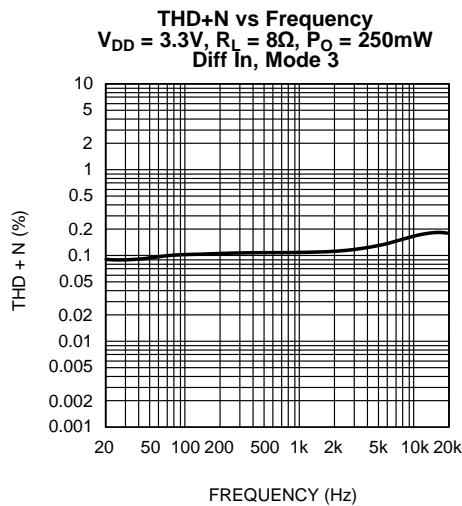

Figure 26.

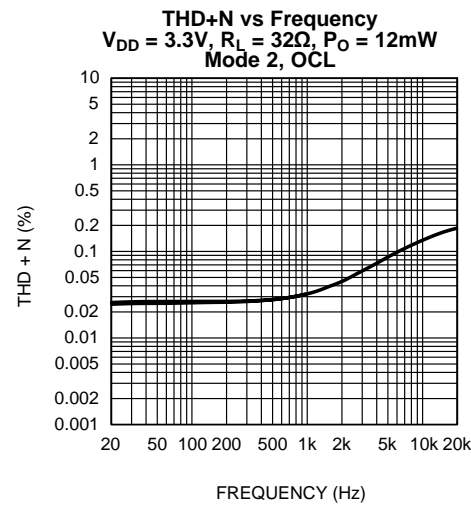

Figure 27.

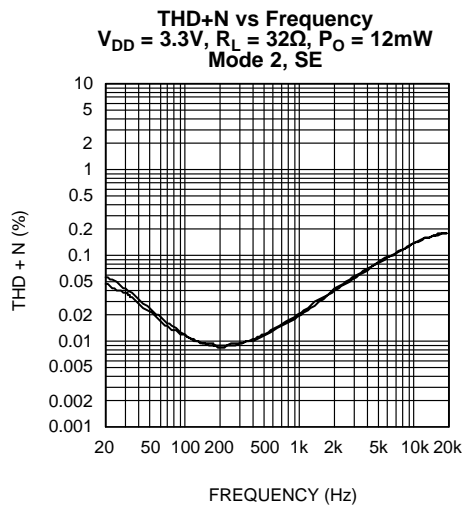

Figure 28.

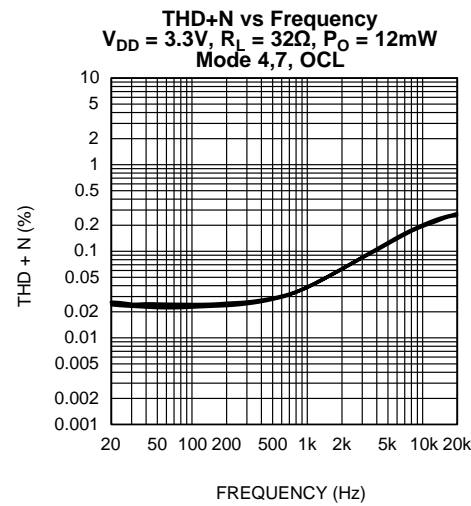

Figure 29.

**TYPICAL PERFORMANCE CHARACTERISTICS (continued)**

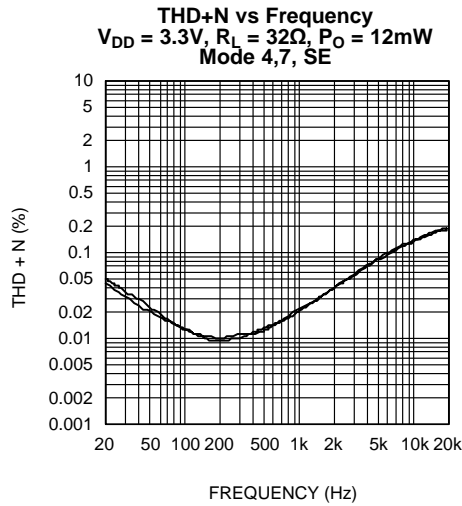

Figure 30.

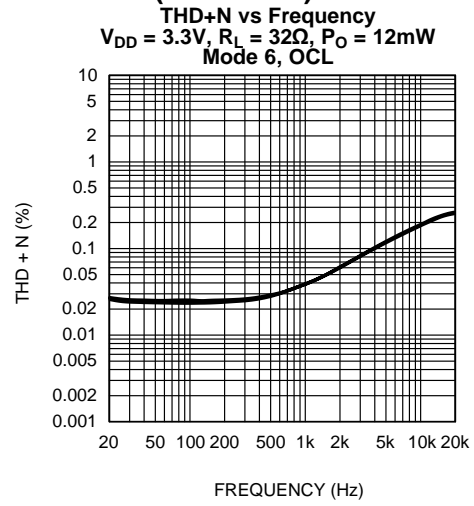

Figure 31.

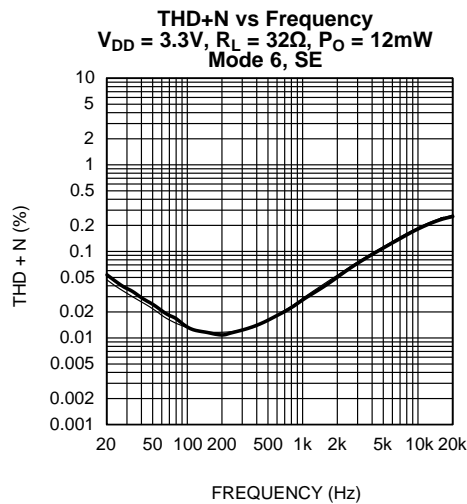

Figure 32.

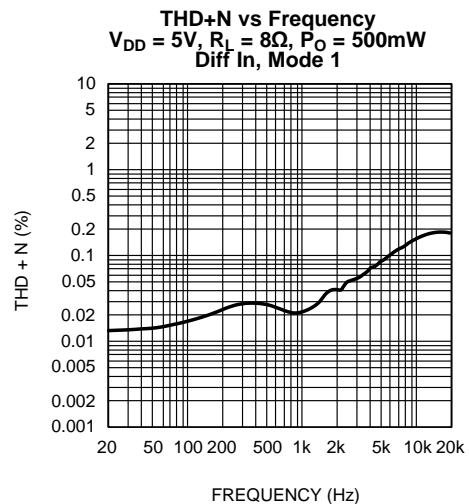

Figure 33.

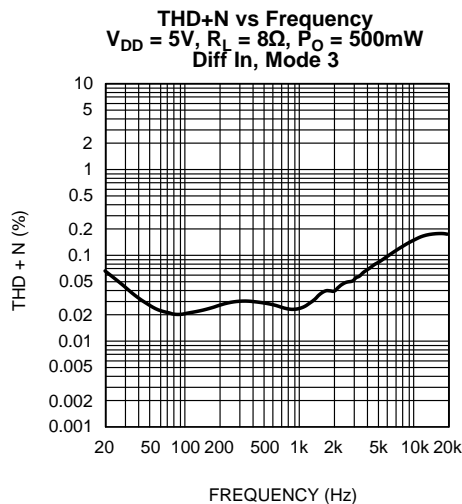

Figure 34.

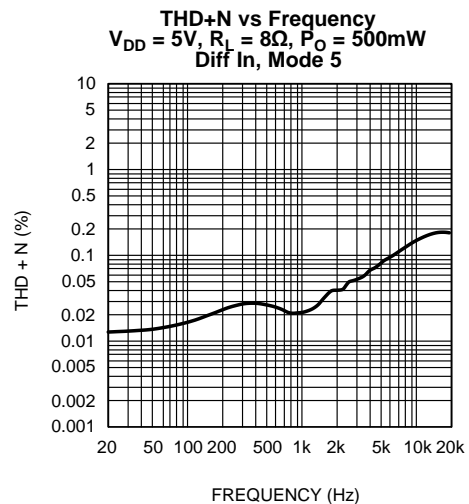

Figure 35.

**TYPICAL PERFORMANCE CHARACTERISTICS (continued)**

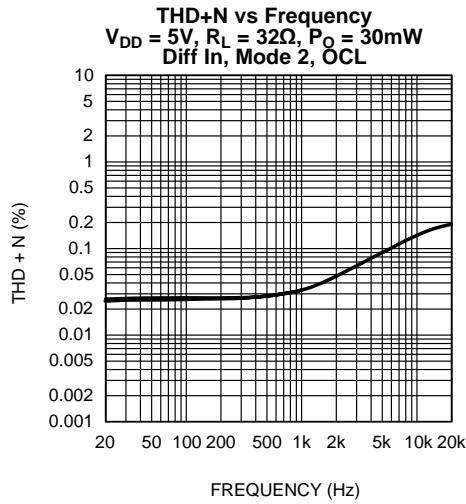

Figure 36.

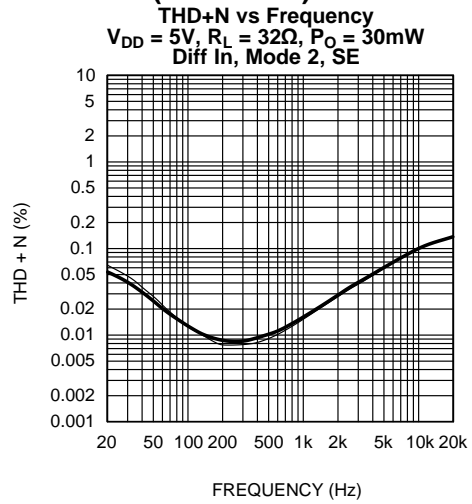

Figure 37.

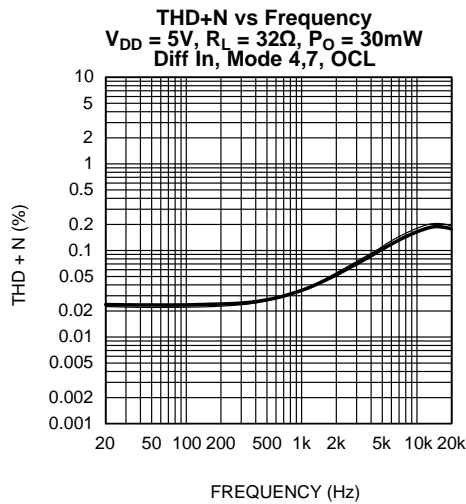

Figure 38.

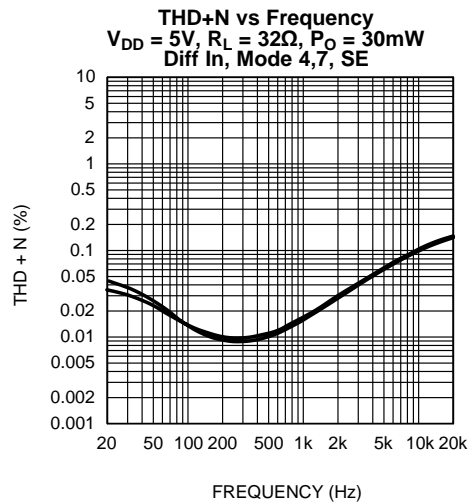

Figure 39.

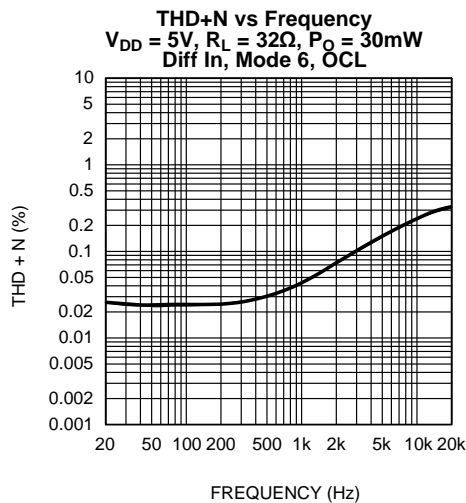

Figure 40.

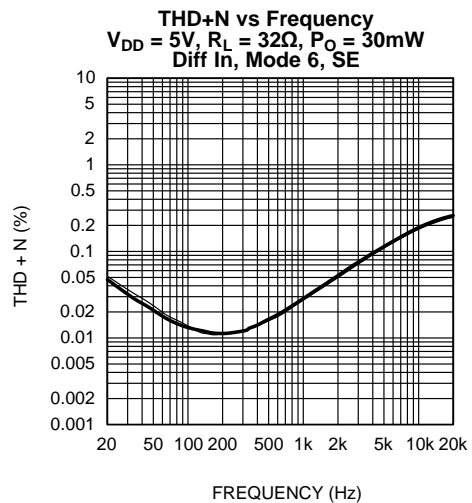

Figure 41.

**TYPICAL PERFORMANCE CHARACTERISTICS (continued)**

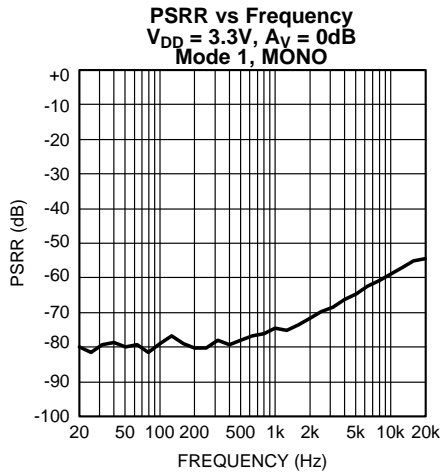

Figure 42.

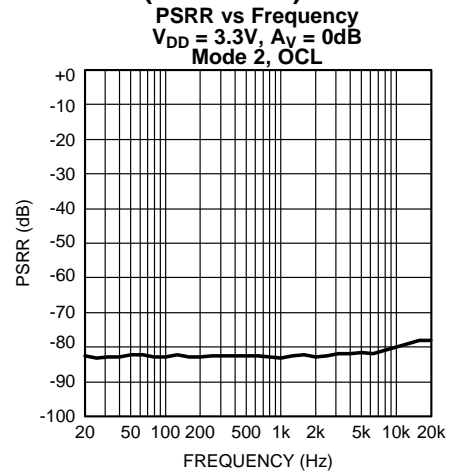

Figure 43.

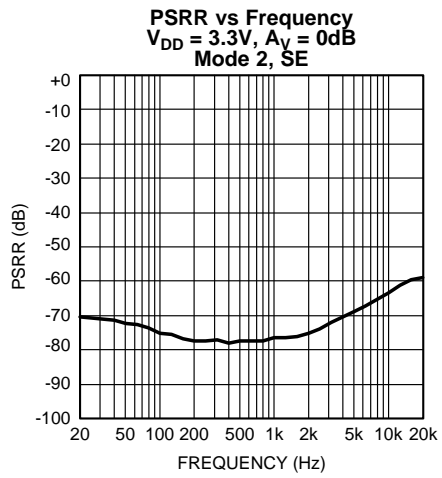

Figure 44.

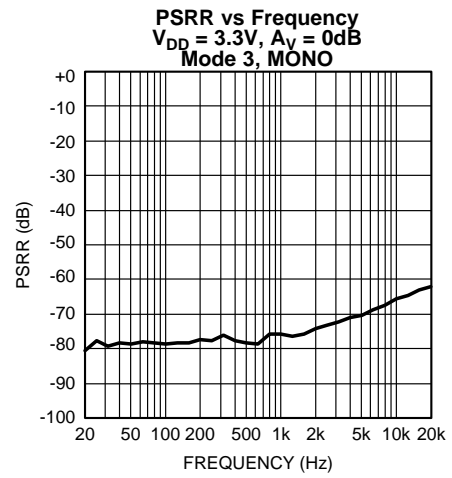

Figure 45.

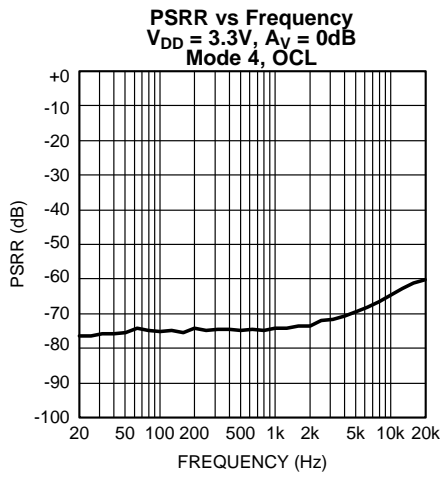

Figure 46.

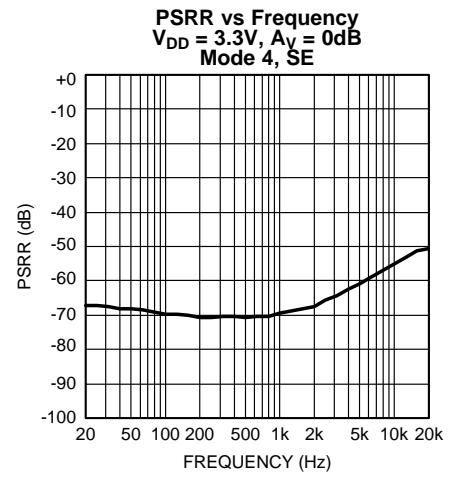

Figure 47.



**TYPICAL PERFORMANCE CHARACTERISTICS (continued)**

**PSRR vs Frequency**  
 $V_{DD} = 3.3V, A_V = 0dB$   
Mode 5, MONO

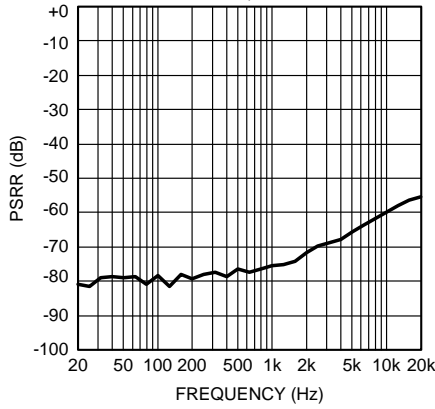

Figure 48.

**PSRR vs Frequency**  
 $V_{DD} = 3.3V, A_V = 0dB$   
Mode 6, OCL

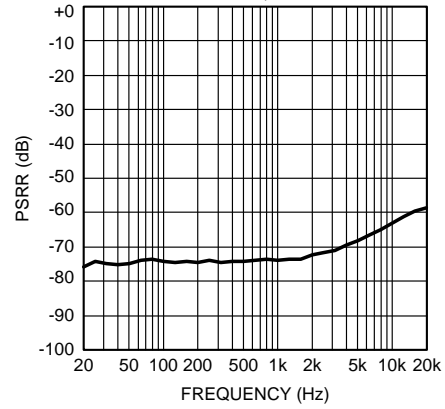

Figure 49.

**PSRR vs Frequency**  
 $V_{DD} = 3.3V, A_V = 0dB$   
Mode 6, SE

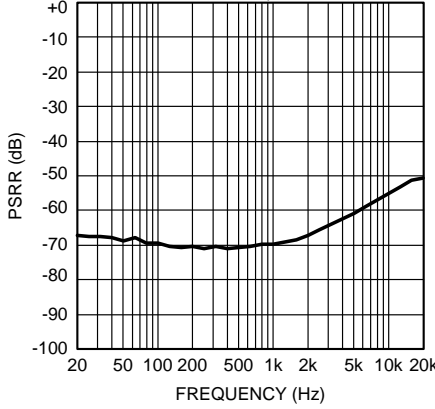

Figure 50.

**PSRR vs Frequency**  
 $V_{DD} = 3.3V, A_V = 0dB$   
Mode 7, MONO

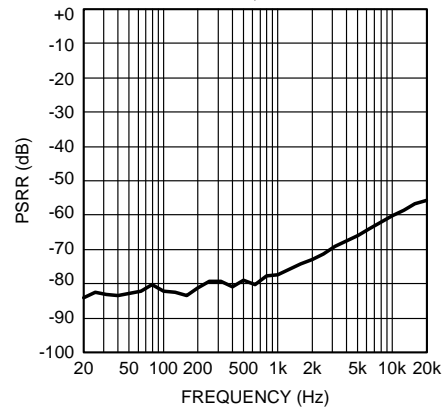

Figure 51.

**PSRR vs Frequency**  
 $V_{DD} = 5V, A_V = 0dB$   
Mode 1, MONO

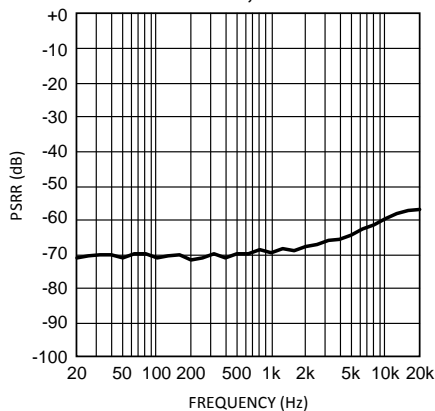

Figure 52.

**PSRR vs Frequency**  
 $V_{DD} = 5V, A_V = 0dB$   
Mode 2, OCL

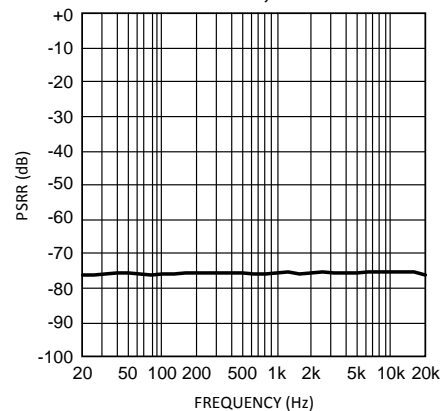

Figure 53.

**TYPICAL PERFORMANCE CHARACTERISTICS (continued)**

**PSRR vs Frequency**  
 $V_{DD} = 5V, A_V = 0dB$   
 Mode 2, SE

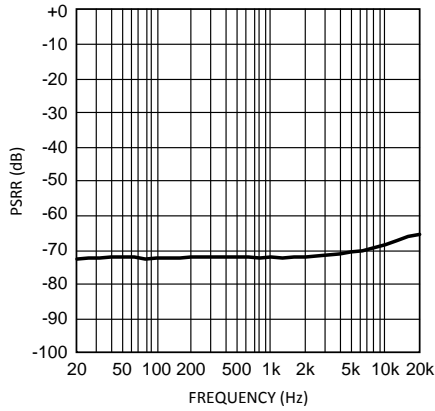

Figure 54.

**PSRR vs Frequency**  
 $V_{DD} = 5V, A_V = 0dB$   
 Mode 3, MONO

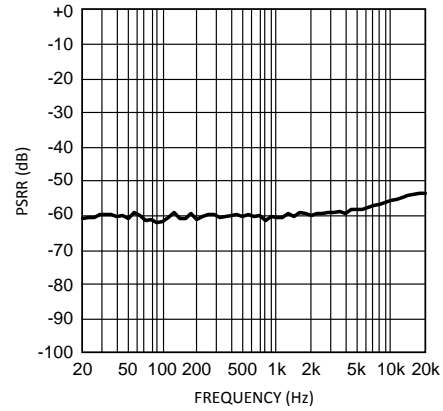

Figure 55.

**PSRR vs Frequency**  
 $V_{DD} = 5V, A_V = 0dB$   
 Mode 4, OCL

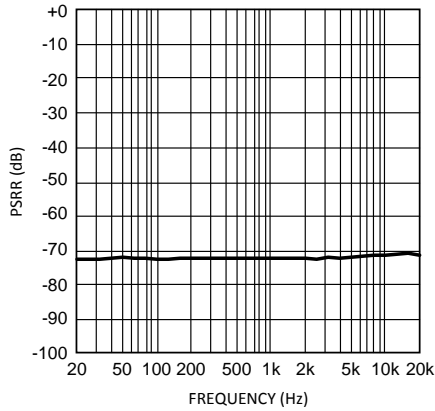

Figure 56.

**PSRR vs Frequency**  
 $V_{DD} = 5V, A_V = 0dB$   
 Mode 4, SE

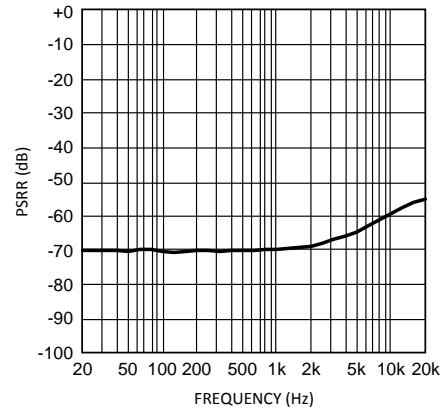

Figure 57.

**PSRR vs Frequency**  
 $V_{DD} = 5V, A_V = 0dB$   
 Mode 5, MONO

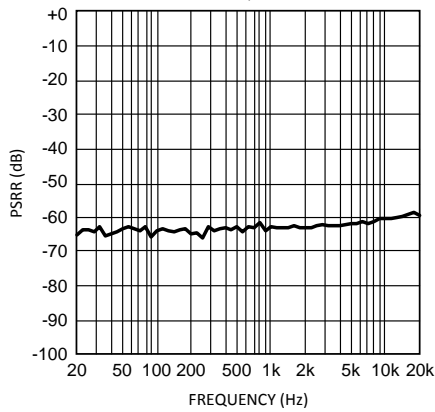

Figure 58.

**PSRR vs Frequency**  
 $V_{DD} = 5V, A_V = 0dB$   
 Mode 6, OCL

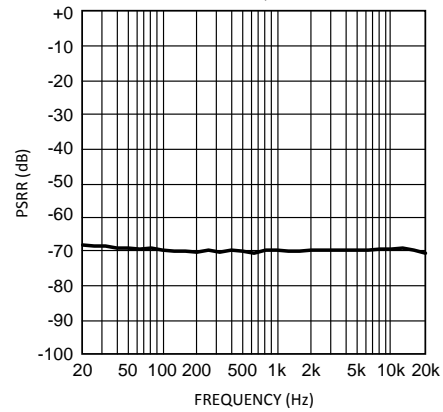
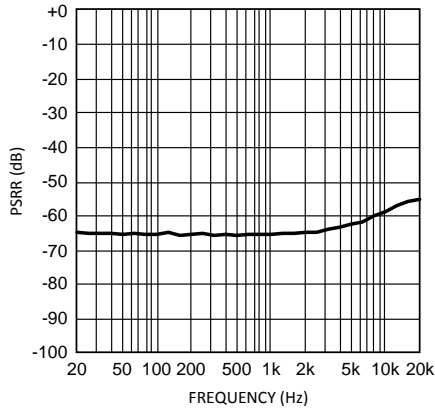

Figure 59.

**TYPICAL PERFORMANCE CHARACTERISTICS (continued)**

**PSRR vs Frequency**  
 $V_{DD} = 5V$ ,  $A_V = 0dB$   
 Mode 6, SE



**Figure 60.**

**PSRR vs Frequency**  
 $V_{DD} = 5V$ ,  $A_V = 0dB$   
 Mode 7, MONO

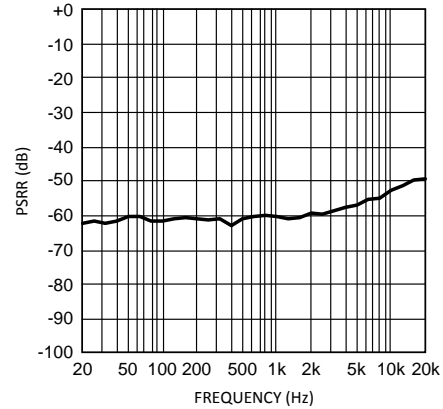

**Figure 61.**

**Power Dissipation vs Output Power**  
 $V_{DD} = 3.3V$ ,  $R_L = 32\Omega$ ,  $f = 1kHz$   
 Mode 7, OCL

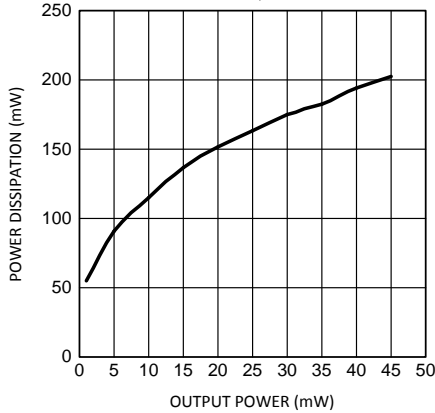

**Figure 62.**

**Power Dissipation vs Output Power**  
 $V_{DD} = 3.3V$ ,  $R_L = 32\Omega$ ,  $f = 1kHz$   
 Mode 7, SE

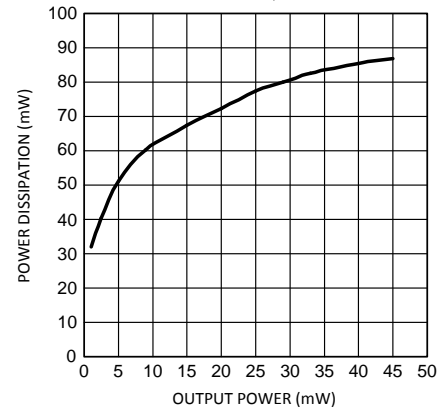

**Figure 63.**

**Power Dissipation vs Output Power**  
 $V_{DD} = 3.3V$ ,  $R_L = 8\Omega$ ,  $f = 1kHz$   
 Mode 1, 3, 5, MONO

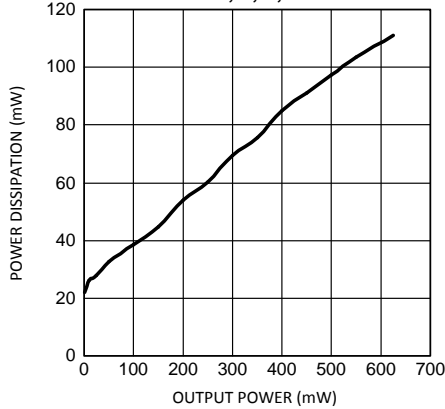

**Figure 64.**

**Power Dissipation vs Output Power**  
 $V_{DD} = 3.3V$ ,  $R_L = 32\Omega$ ,  $f = 1kHz$   
 Mode 2, 4, 6, OCL

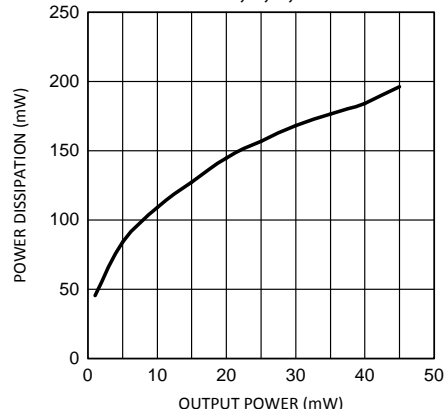

**Figure 65.**

**TYPICAL PERFORMANCE CHARACTERISTICS (continued)**

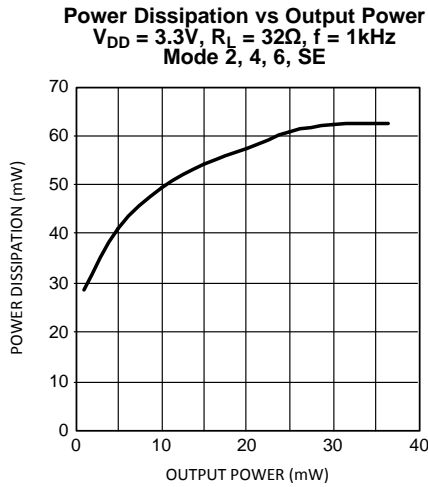

Figure 66.

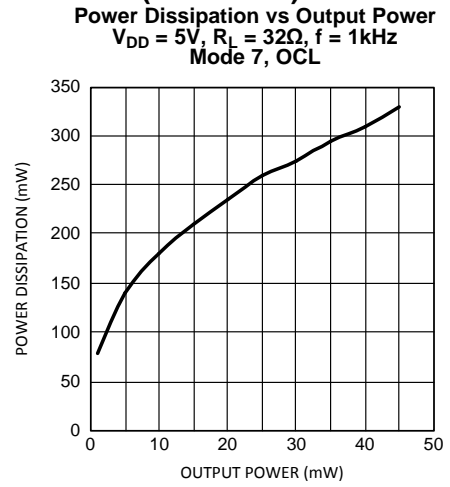

Figure 67.

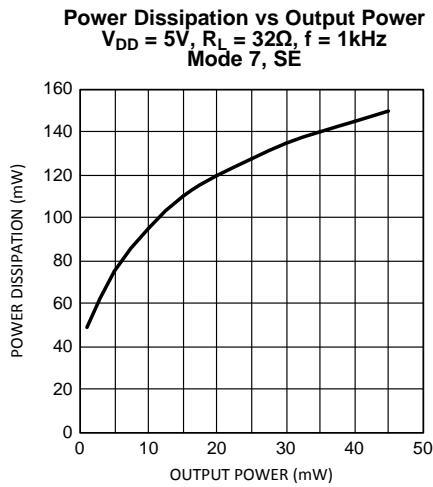

Figure 68.

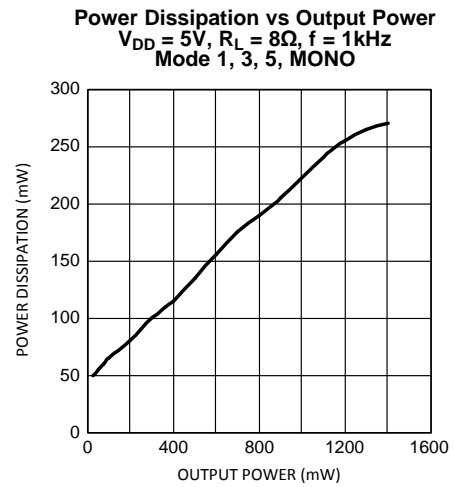

Figure 69.

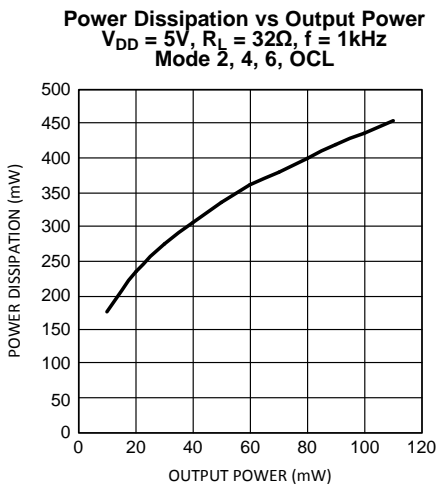

Figure 70.

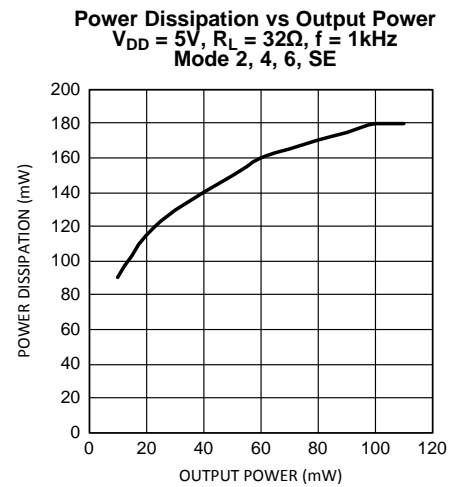

Figure 71.

**TYPICAL PERFORMANCE CHARACTERISTICS (continued)**

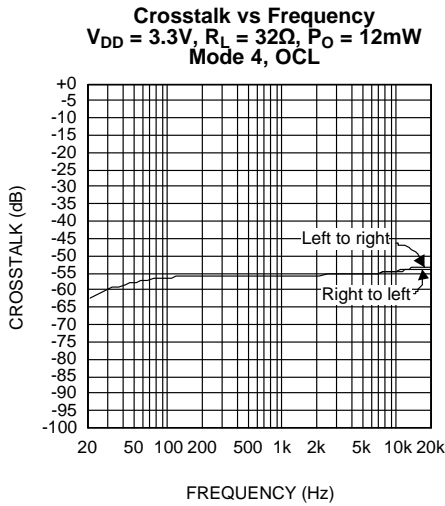

Figure 72.

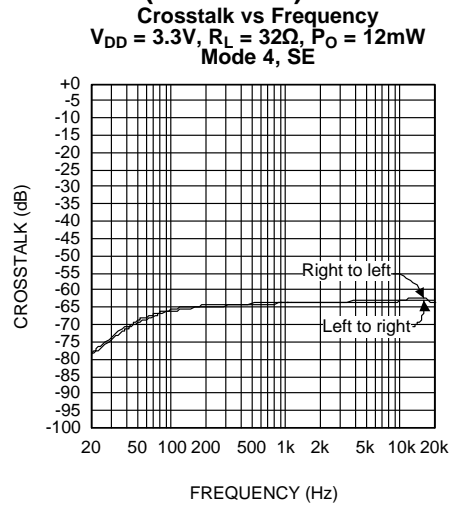

Figure 73.

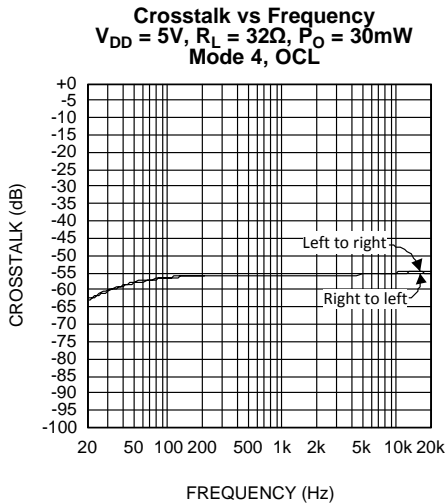

Figure 74.

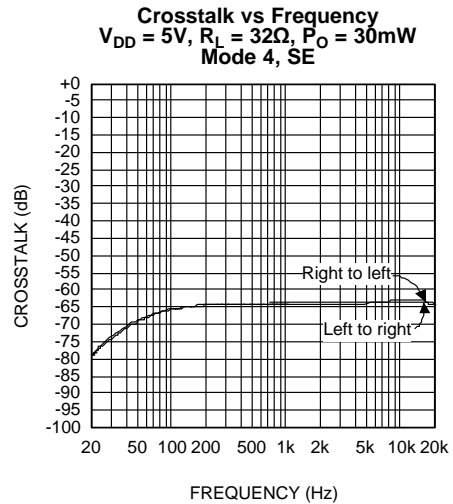

Figure 75.

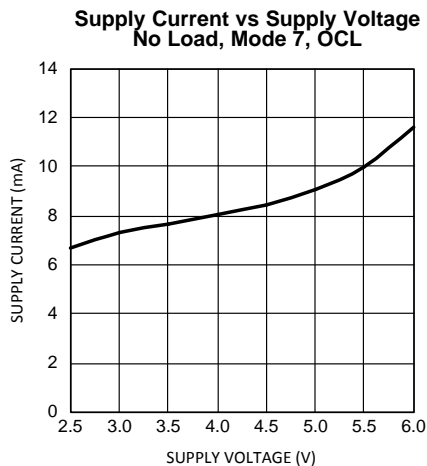

Figure 76.

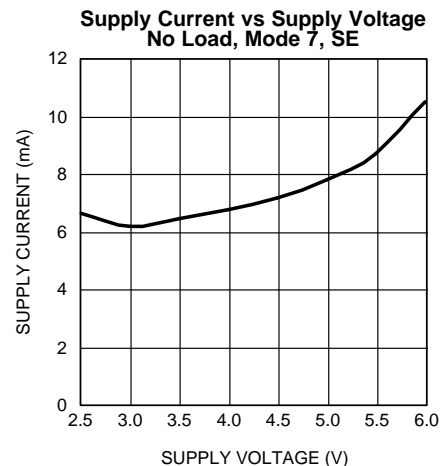

Figure 77.

**TYPICAL PERFORMANCE CHARACTERISTICS (continued)**

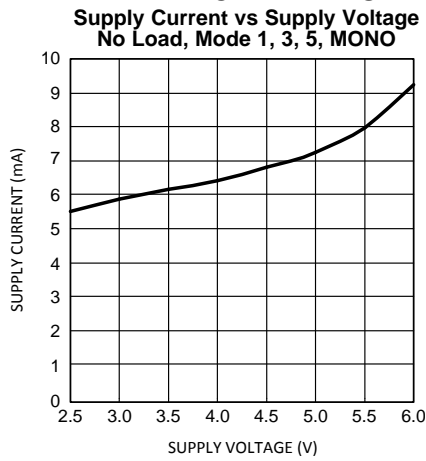

Figure 78.

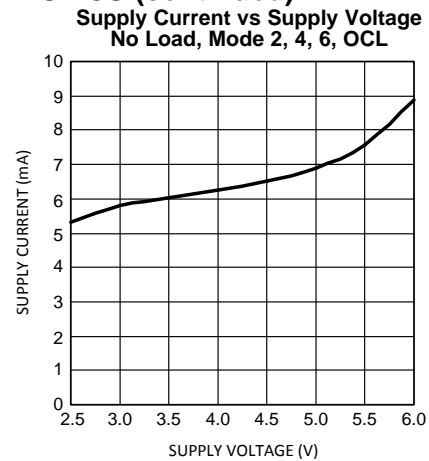

Figure 79.

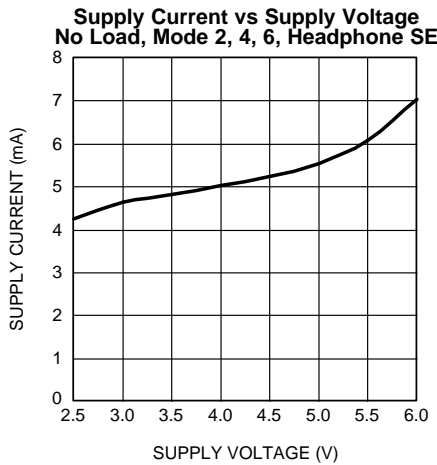

Figure 80.

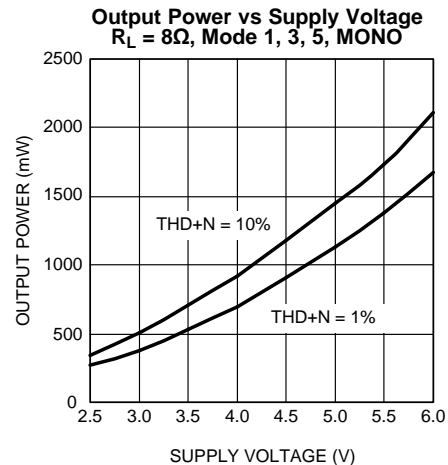

Figure 81.

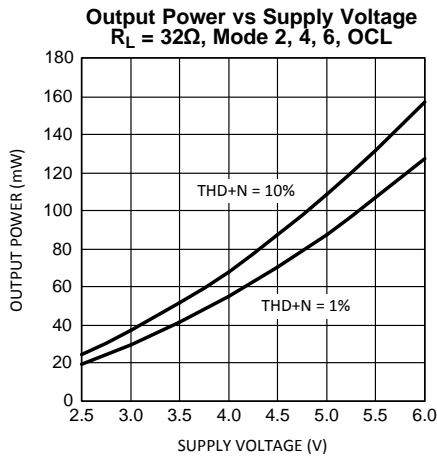

Figure 82.

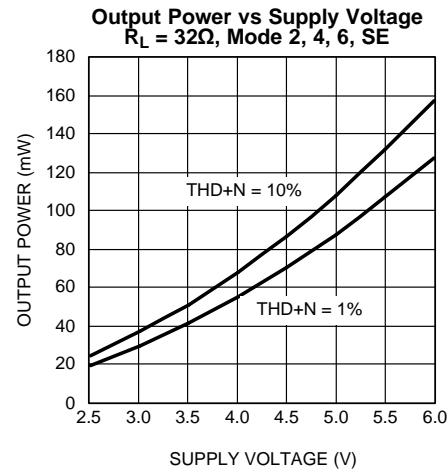

Figure 83.

**TYPICAL PERFORMANCE CHARACTERISTICS (continued)**

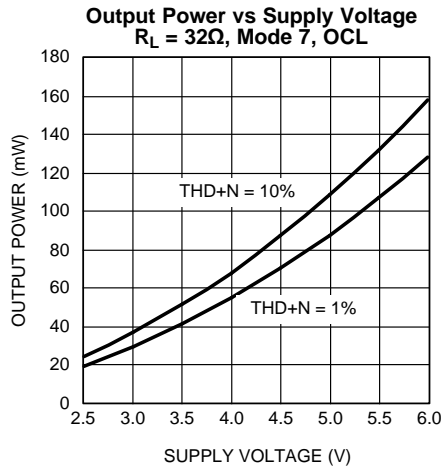

Figure 84.

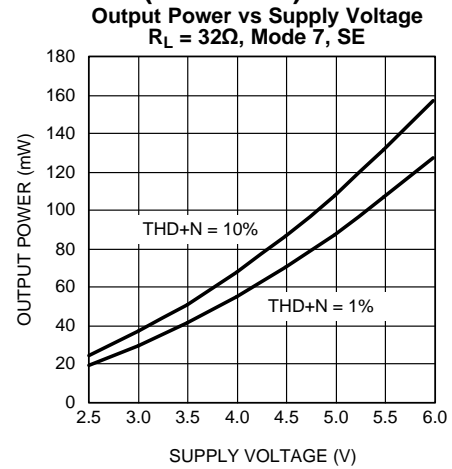

Figure 85.

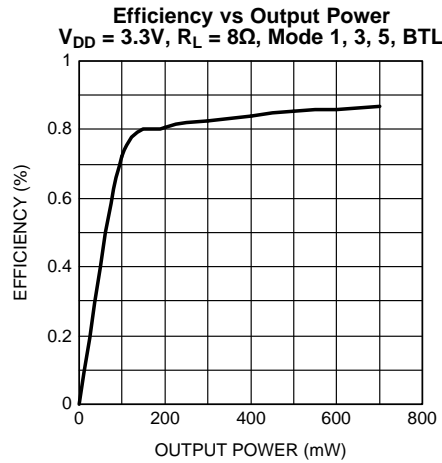

Figure 86.

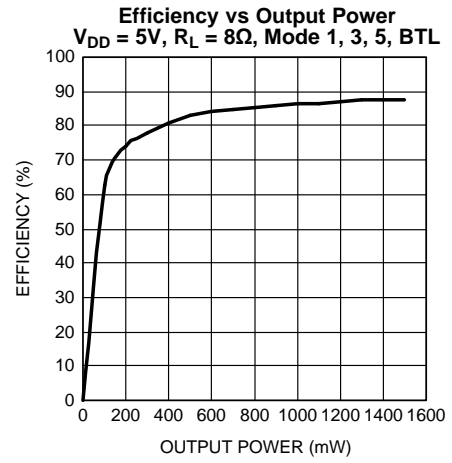

Figure 87.

## APPLICATION INFORMATION

### I<sup>2</sup>C PIN DESCRIPTION

SDA: This is the serial data input pin.

SCL: This is the clock input pin.

ID\_ENB: This is the address select input pin.

### I<sup>2</sup>C COMPATIBLE INTERFACE

The LM4947 uses a serial bus which conforms to the I<sup>2</sup>C protocol to control the chip's functions with two wires: clock (SCL) and data (SDA). The clock line is uni-directional. The data line is bi-directional (open-collector). The maximum clock frequency specified by the I<sup>2</sup>C standard is 400kHz. In this discussion, the master is the controlling microcontroller and the slave is the LM4947.

The I<sup>2</sup>C address for the LM4947 is determined using the ID\_ENB pin. The LM4947's two possible I<sup>2</sup>C chip addresses are of the form 111110X<sub>1</sub>0 (binary), where X<sub>1</sub> = 0, if ID\_ADDR is logic LOW; and X<sub>1</sub> = 1, if ID\_ENB is logic HIGH. If the I<sup>2</sup>C interface is used to address a number of chips in a system, the LM4947's chip address can be changed to avoid any possible address conflicts.

The bus format for the I<sup>2</sup>C interface is shown in [Figure 4](#). The bus format diagram is broken up into six major sections:

1. The "start" signal is generated by lowering the data signal while the clock signal is HIGH. The start signal will alert all devices attached to the I<sup>2</sup>C bus to check the incoming address against their own address.
2. The 8-bit chip address is sent next, most significant bit first. The data is latched in on the rising edge of the clock. Each address bit must be stable while the clock level is HIGH.
3. After the last bit of the address bit is sent, the master releases the data line HIGH (through a pull-up resistor). Then the master sends an acknowledge clock pulse. If the LM4947 has received the address correctly, then it holds the data line LOW during the clock pulse. If the data line is not held LOW during the acknowledge clock pulse, then the master should abort the rest of the data transfer to the LM4947.
4. The 8 bits of data are sent next, most significant bit first. Each data bit should be valid while the clock level is stable HIGH.
5. After the data byte is sent, the master must check for another acknowledge to see if the LM4947 received the data.
6. The "stop" signal ends the transfer. To signal "stop", the data signal goes HIGH while the clock signal is HIGH. The data line should be held HIGH when not in use.

### I<sup>2</sup>C INTERFACE POWER SUPPLY PIN (I<sup>2</sup>CV<sub>DD</sub>)

The LM4947's I<sup>2</sup>C interface is powered up through the I<sup>2</sup>CV<sub>DD</sub> pin. The LM4947's I<sup>2</sup>C interface operates at a voltage level set by the I<sup>2</sup>CV<sub>DD</sub> pin which can be set independent to that of the main power supply pin V<sub>DD</sub>. This is ideal whenever logic levels for the I<sup>2</sup>C interface are dictated by a microcontroller or microprocessor that is operating at a lower supply voltage than the main battery of a portable system.

**Table 1. Chip Address**

	A7	A6	A5	A4	A3	A2	A1	A0
Chip Address	1	1	1	1	1	0	EC	0
ID_ADDR = 0	1	1	1	1	1	0	0	0
ID_ADDR = 1	1	1	1	1	1	0	1	0



**Table 2. Control Registers**

	D7	D6	D5	D4	D3	D2	D1	D0
Mode Control	0	0	SE/Diff (select)	0	OCL (select)	MC2	MC1	MC0
Programmable 3D	0	1	L2R2 (select)	L1R1 (select)	N3D3	N3D2	N3D1	N3D0
Mono Volume Control	1	0	0	MVC4	MVC3	MVC2	MVC1	MVC0
Left Volume Control	1	1	0	LVC4	LVC3	LVC2	LVC1	LVC0
Right Volume Control	1	1	1	RVC4	RVC3	RVC2	RVC1	RVC0

**Table 3. Programmable Texas Instruments 3D Audio**

	N3D3	N3D2
Low	0	0
Medium	0	1
High	1	0
Maximum	1	1

**Table 4. Input/Output Control**

	L2R2	L1R1	SE/DIFF
Select L <sub>IN1</sub> and R <sub>IN1</sub> Stereo Pair	0	1	0
Select L <sub>IN2</sub> and R <sub>IN2</sub> Stereo Pair	1	0	0
Select L <sub>IN1</sub> +L <sub>IN2</sub> and R <sub>IN1</sub> +R <sub>IN2</sub> Stereo Pair	1	1	0
Sets Stereo Inputs to Differential	x	x	1

**Table 5. Output Volume Control Table**

Volume Step	xVC4	xVC3	xVC2	xVC1	xVC0	Gain, dB
1	0	0	0	0	0	-59.50
2	0	0	0	0	1	-48.00
3	0	0	0	1	0	-40.50
4	0	0	0	1	1	-34.50
5	0	0	1	0	0	-30.00
6	0	0	1	0	1	-27.00
7	0	0	1	1	0	-24.00
8	0	0	1	1	1	-21.00
9	0	1	0	0	0	-18.00
10	0	1	0	0	1	-15.00
11	0	1	0	1	0	-13.50
12	0	1	0	1	1	-12.00
13	0	1	1	0	0	-10.50
14	0	1	1	0	1	-9.00
15	0	1	1	1	0	-7.50
16	0	1	1	1	1	-6.00
17	1	0	0	0	0	-4.50
18	1	0	0	0	1	-3.00
19	1	0	0	1	0	-1.50
20	1	0	0	1	1	0.00
21	1	0	1	0	0	1.50
22	1	0	1	0	1	3.00
23	1	0	1	1	0	4.50
24	1	0	1	1	1	6.00

**Table 5. Output Volume Control Table (continued)**

Volume Step	xVC4	xVC3	xVC2	xVC1	xVC0	Gain, dB
25	1	1	0	0	0	7.50
26	1	1	0	0	1	9.00
27	1	1	0	1	0	10.50
28	1	1	0	1	1	12.00
29	1	1	1	0	0	13.50
30	1	1	1	0	1	15.00
31	1	1	1	1	0	16.50
32	1	1	1	1	1	18.00

**Table 6. Output Mode Selection**

Output Mode Number	MC2	MC1	MC0	Handsfree Mono Output	Right HP Output	Left HP Output
0	0	0	0	SD	SD	SD
1	0	0	1	2 x G <sub>M</sub> x M	MUTE	MUTE
2	0	1	0	SD	G <sub>M</sub> x M	G <sub>M</sub> x M
3	0	1	1	G <sub>L</sub> x L + G <sub>R</sub> x R	MUTE	MUTE
4	1	0	0	SD	G <sub>R</sub> x R	G <sub>L</sub> x L
5	1	0	1	G <sub>L</sub> x L + G <sub>R</sub> x R + 2(G <sub>M</sub> x M)	MUTE	MUTE
6	1	1	0	SD	G <sub>R</sub> x R + G <sub>M</sub> x M	G <sub>L</sub> x L + G <sub>M</sub> x M
7	1	1	1	G <sub>R</sub> x R + G <sub>L</sub> x L	G <sub>R</sub> x R	G <sub>L</sub> x L

**TI 3D ENHANCEMENT**

The LM4947 features a stereo headphone, 3D audio enhancement effect that widens the perceived soundstage from a stereo audio signal. The 3D audio enhancement creates a perceived spatial effect optimized for stereo headphone listening. The LM4947 can be programmed for a “narrow” or “wide” soundstage perception. The narrow soundstage has a more focused approaching sound direction, while the wide soundstage has a spatial, theater-like effect. Within each of these two modes, four discrete levels of 3D effect that can be programmed: low, medium, high, and maximum (Table 2), each level with an ever increasing aural effect, respectively. The difference between each level is 3dB.

The external capacitors, shown in Figure 88, are required to enable the 3D effect. The value of the capacitors set the cutoff frequency of the 3D effect, as shown by Equation 1 and Equation 2. Note that the internal 20kΩ resistor is nominal (±25%).

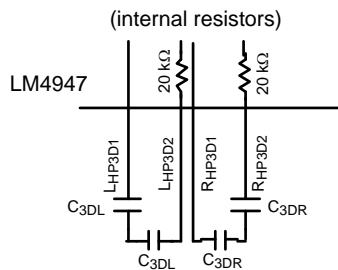
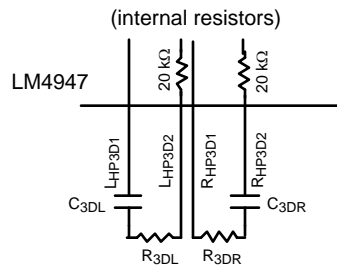

**Figure 88. External 3D Effect Capacitors**

$$f_{3DL(-3dB)} = 1 / 2\pi * 20k\Omega * C_{3DL} \tag{1}$$

$$f_{3DR(-3dB)} = 1 / 2\pi * 20k\Omega * C_{3DR} \tag{2}$$

Optional resistors R<sub>3DL</sub> and R<sub>3DR</sub> can also be added (Figure 89) to affect the -3dB frequency and 3D magnitude.



**Figure 89. External RC Network with Optional R<sub>3DL</sub> and R<sub>3DR</sub> Resistors**

$$f_{3DL(-3dB)} = 1 / 2\pi * (20k\Omega + R_{3DL}) * C_{3DL} \tag{3}$$

$$f_{3DR(-3dB)} = 1 / 2\pi * 20k\Omega + R_{3DR} * C_{3DR} \tag{4}$$

$\Delta AV$  (change in AC gain) =  $1 / 1 + M$ , where M represents some ratio of the nominal internal resistor, 20k $\Omega$  (see example below).

$$f_{3dB (3D)} = 1 / 2\pi (1 + M)(20k\Omega * C_{3D}) \tag{5}$$

$$C_{Equivalent (new)} = C_{3D} / 1 + M \tag{6}$$

**Table 7. Pole Locations**

R <sub>3D</sub> (k $\Omega$ ) (optional)	C <sub>3D</sub> (nF)	M	$\Delta AV$ (dB)	f-3dB (3D) (Hz)	Value of C <sub>3D</sub> to keep same pole location (nF)	new Pole Location (Hz)
0	68	0	0	117		
1	68	0.05	-0.4	111	64.8	117
5	68	0.25	-1.9	94	54.4	117
10	68	0.50	-3.5	78	45.3	117
20	68	1.00	-6.0	59	34.0	117

### PCB LAYOUT AND SUPPLY REGULATION CONSIDERATIONS FOR DRIVING 8 $\Omega$ LOAD

Power dissipated by a load is a function of the voltage swing across the load and the load's impedance. As load impedance decreases, load dissipation becomes increasingly dependent on the interconnect (PCB trace and wire) resistance between the amplifier output pins and the load's connections. Residual trace resistance causes a voltage drop, which results in power dissipated in the trace and not in the load as desired. For example, 0.1 $\Omega$  trace resistance reduces the output power dissipated by an 8 $\Omega$  load from 158.3mW to 156.4mW. The problem of decreased load dissipation is exacerbated as load impedance decreases. Therefore, to maintain the highest load dissipation and widest output voltage swing, PCB traces that connect the output pins to a load must be as wide as possible.

Poor power supply regulation adversely affects maximum output power. A poorly regulated supply's output voltage decreases with increasing load current. Reduced supply voltage causes decreased headroom, output signal clipping, and reduced output power. Even with tightly regulated supplies, trace resistance creates the same effects as poor supply regulation. Therefore, making the power supply traces as wide as possible helps maintain full output voltage swing.

### POWER DISSIPATION AND EFFICIENCY

In general terms, efficiency is considered to be the ratio of useful work output divided by the total energy required to produce it with the difference being the power dissipated, typically, in the IC. The key here is "useful" work. For audio systems, the energy delivered in the audible bands is considered useful including the distortion products of the input signal. Sub-sonic (DC) and super-sonic components (>22kHz) are not useful. The difference between the power flowing from the power supply and the audio band power being transduced is dissipated in the

LM4947 and in the transducer load. The amount of power dissipation in the LM4947 is very low. This is because the ON resistance of the switches used to form the output waveforms is typically less than  $0.25\Omega$ . This leaves only the transducer load as a potential "sink" for the small excess of input power over audio band output power. The LM4947 dissipates only a fraction of the excess power requiring no additional PCB area or copper plane to act as a heat sink.

The LM4947 also has a pair of single-ended amplifiers driving stereo headphones,  $R_{HP}$  and  $L_{HP}$ . The maximum internal power dissipation for  $R_{HP}$  and  $L_{HP}$  is given by [Equation 7](#) and [Equation 8](#). From [Equation 7](#) and [Equation 8](#), assuming a 5V power supply and a  $32\Omega$  load, the maximum power dissipation for  $L_{HP}$  and  $R_{HP}$  is 40mW, or 80mW total.

$$P_{DMAX-LHP} = (V_{DD})^2 / (2\pi^2 R_L): \text{Single-ended Mode} \quad (7)$$

$$P_{DMAX-RHP} = (V_{DD})^2 / (2\pi^2 R_L): \text{Single-ended Mode} \quad (8)$$

The maximum internal power dissipation of the LM4947 occurs when all 3 amplifiers pairs are simultaneously on; and is given by [Equation 9](#).

$$P_{DMAX-TOTAL} = P_{DMAX-SPKROUT} + P_{DMAX-LHP} + P_{DMAX-RHP} \quad (9)$$

The maximum power dissipation point given by [Equation 9](#) must not exceed the power dissipation given by [Equation 10](#):

$$P_{DMAX} = (T_{JMAX} - T_A) / \theta_{JA} \quad (10)$$

The LM4947's  $T_{JMAX} = 150^\circ\text{C}$ . In the ITL package, the LM4947's  $\theta_{JA}$  is  $65^\circ\text{C/W}$ . At any given ambient temperature  $T_A$ , use [Equation 10](#) to find the maximum internal power dissipation supported by the IC packaging. Rearranging [Equation 10](#) and substituting  $P_{DMAX-TOTAL}$  for  $P_{DMAX}$  results in [Equation 11](#). This equation gives the maximum ambient temperature that still allows maximum stereo power dissipation without violating the LM4947's maximum junction temperature.

$$T_A = T_{JMAX} - P_{DMAX-TOTAL} \theta_{JA} \quad (11)$$

For a typical application with a 5V power supply and an  $8\Omega$  load, the maximum ambient temperature that allows maximum stereo power dissipation without exceeding the maximum junction temperature is approximately  $104^\circ\text{C}$  for the ITL package.

$$T_{JMAX} = P_{DMAX-TOTAL} \theta_{JA} + T_A \quad (12)$$

[Equation 12](#) gives the maximum junction temperature  $T_{JMAX}$ . If the result violates the LM4947's  $150^\circ\text{C}$ , reduce the maximum junction temperature by reducing the power supply voltage or increasing the load resistance. Further allowance should be made for increased ambient temperatures.

The above examples assume that a device is a surface mount part operating around the maximum power dissipation point. Since internal power dissipation is a function of output power, higher ambient temperatures are allowed as output power or duty cycle decreases. If the result of [Equation 9](#) is greater than that of [Equation 10](#), then decrease the supply voltage, increase the load impedance, or reduce the ambient temperature. If these measures are insufficient, a heat sink can be added to reduce  $\theta_{JA}$ . The heat sink can be created using additional copper area around the package, with connections to the ground pin(s), supply pin and amplifier output pins. External, solder attached SMT heatsinks such as the Thermalloy 7106D can also improve power dissipation. When adding a heat sink, the  $\theta_{JA}$  is the sum of  $\theta_{JC}$ ,  $\theta_{CS}$ , and  $\theta_{SA}$ . ( $\theta_{JC}$  is the junction-to-case thermal impedance,  $\theta_{CS}$  is the case-to-sink thermal impedance, and  $\theta_{SA}$  is the sink-to-ambient thermal impedance). Refer to the [TYPICAL PERFORMANCE CHARACTERISTICS](#) curves for power dissipation information at lower output power levels.

## POWER SUPPLY BYPASSING

As with any power amplifier, proper supply bypassing is critical for low noise performance and high power supply rejection. Applications that employ a 5V regulator typically use a  $1\mu\text{F}$  in parallel with a  $0.1\mu\text{F}$  filter capacitors to stabilize the regulator's output, reduce noise on the supply line, and improve the supply's transient response. However, their presence does not eliminate the need for a local  $1.1\mu\text{F}$  tantalum bypass capacitance connected between the LM4947's supply pins and ground. Keep the length of leads and traces that connect capacitors between the LM4947's power supply pin and ground as short as possible. Connecting a  $2.2\mu\text{F}$  capacitor,  $C_B$ , between the BYPASS pin and ground improves the internal bias voltage's stability and improves the amplifier's PSRR. The PSRR improvements increase as the bypass pin capacitor value increases. Too large, however, increases turn-on time and can compromise the amplifier's click and pop performance. The selection of bypass capacitor values, especially  $C_B$ , depends on desired PSRR requirements, click and pop performance (as explained in the section, [SELECTING EXTERNAL COMPONENTS](#)), system cost, and size constraints.

## SELECTING EXTERNAL COMPONENTS

### Input Capacitor Value Selection

Amplifying the lowest audio frequencies requires high value input coupling capacitor ( $C_i$  in [Figure 1](#) and [Figure 2](#)). A high value capacitor can be expensive and may compromise space efficiency in portable designs. In many cases, however, the speakers used in portable systems, whether internal or external, have little ability to reproduce signals below 150Hz. Applications using speakers with this limited frequency response reap little improvement by using large input capacitor.

The internal input resistor ( $R_i$ ), nominal 20k $\Omega$ , and the input capacitor ( $C_i$ ) produce a high pass filter cutoff frequency that is found using [Equation 13](#).

$$f_c = 1 / (2\pi R_i C_i) \quad (13)$$

As an example when using a speaker with a low frequency limit of 150Hz,  $C_i$ , using [Equation 13](#) is 0.053 $\mu$ F. The 0.22 $\mu$ F  $C_i$  shown in [Figure 1](#) allows the LM4947 to drive high efficiency, full range speaker whose response extends below 40Hz.

### Bypass Capacitor Value Selection

Besides minimizing the input capacitor size, careful consideration should be paid to value of  $C_B$ , the capacitor connected to the BYPASS bump. Since  $C_B$  determines how fast the LM4947 settles to quiescent operation, its value is critical when minimizing turn-on pops. The slower the LM4947's outputs ramp to their quiescent DC voltage (nominally  $V_{DD}/2$ ), the smaller the turn-on pop. Choosing  $C_B$  equal to 1.0 $\mu$ F along with a small value of  $C_i$  (in the range of 0.1 $\mu$ F to 0.39 $\mu$ F), produces a click-less and pop-less shutdown function. As discussed above, choosing  $C_i$  no larger than necessary for the desired bandwidth helps minimize clicks and pops.  $C_B$ 's value should be in the range of 5 times to 7 times the value of  $C_i$ . This ensures that output transients are eliminated when power is first applied or the LM4947 resumes operation after shutdown.

DEMO BOARD SCHEMATIC

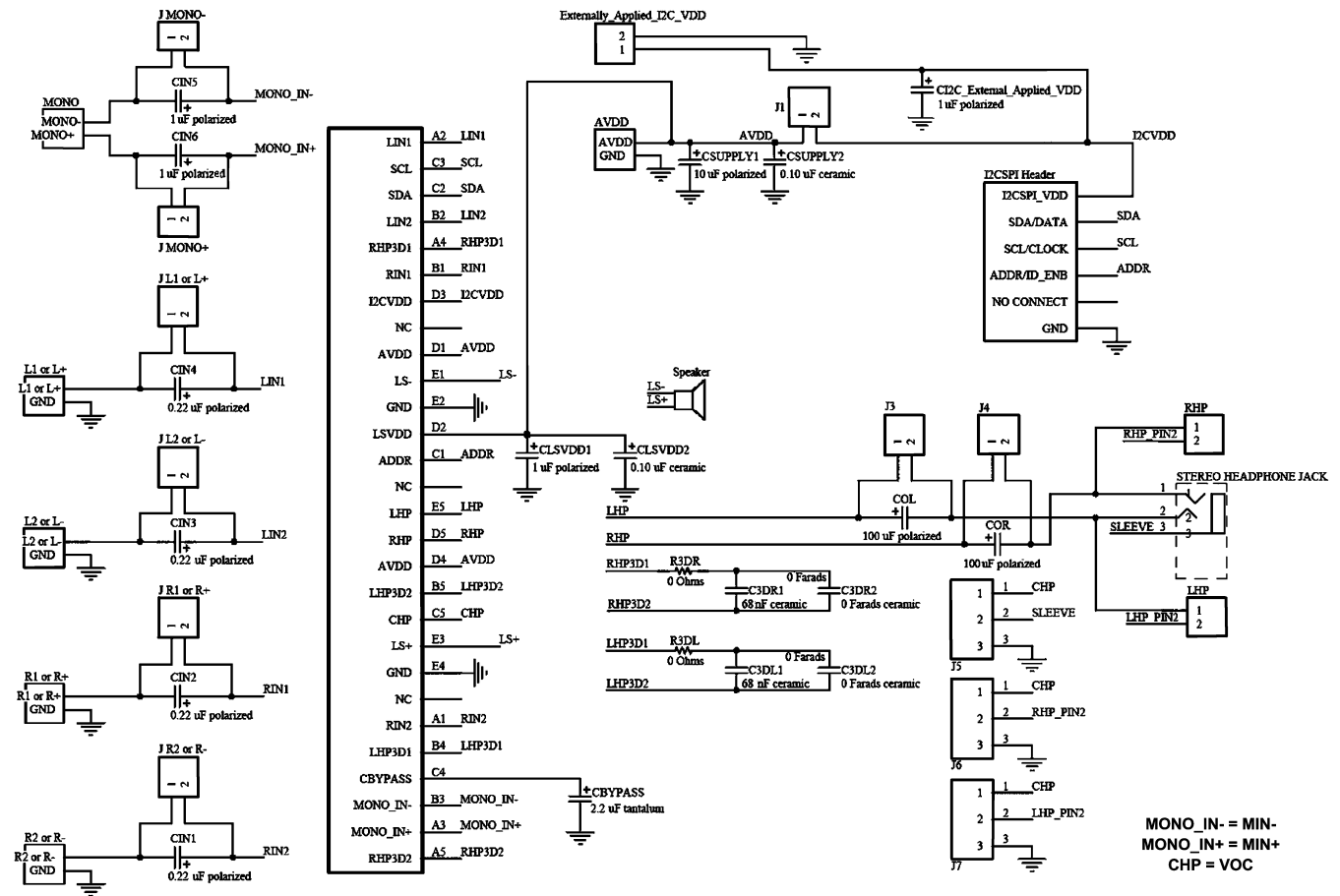

Figure 90.

## REVISION HISTORY

Rev	Date	Description
1.0	06/16/06	Initial release.
1.1	06/19/06	Changed the Class D Efficiency (n) on Typical limit (from 79 to 86) on the 5V specification table.
1.2	06/22/06	Added more Typ Perf curves.
1.3	07/18/06	Replaced some of the curves.
1.4	08/29/06	Text edits.
1.5	10/18/06	Edited DSBGA pkg drawing, <a href="#">Figure 1</a> and <a href="#">Figure 2</a> . Changed I <sub>DDQ</sub> typical and limit values on the 3.3V and 5.0V specification table. Removed CMRR SE condition and changed typical values for CMRR BTL on 3.3V and 5.0V specification table. Changed Mute Attenuation typical value on 5.0V specification table.
1.6	03/02/07	Edited the 3.3V and 5V EC tables.
1.7	03/02/07	Composed (CONFIDENTIAL) D/S for customer (SAMSUNG).
1.8	09/06/07	Edited Table 4.
1.9	11/09/07	Text edits.
D	05/03/13	Changed layout of National Data Sheet to TI format.

**PACKAGING INFORMATION**

Orderable part number	Status (1)	Material type (2)	Package   Pins	Package qty   Carrier	RoHS (3)	Lead finish/ Ball material (4)	MSL rating/ Peak reflow (5)	Op temp (°C)	Part marking (6)
<a href="#">LM4947TL/NOPB</a>	Active	Production	DSBGA (YZR)   25	250   SMALL T&R	Yes	SNAGCU	Level-1-260C-UNLIM	-40 to 85	GH1
LM4947TL/NOPB.A	Active	Production	DSBGA (YZR)   25	250   SMALL T&R	Yes	SNAGCU	Level-1-260C-UNLIM	-40 to 85	GH1

(1) **Status:** For more details on status, see our [product life cycle](#).

(2) **Material type:** When designated, preproduction parts are prototypes/experimental devices, and are not yet approved or released for full production. Testing and final process, including without limitation quality assurance, reliability performance testing, and/or process qualification, may not yet be complete, and this item is subject to further changes or possible discontinuation. If available for ordering, purchases will be subject to an additional waiver at checkout, and are intended for early internal evaluation purposes only. These items are sold without warranties of any kind.

(3) **RoHS values:** Yes, No, RoHS Exempt. See the [TI RoHS Statement](#) for additional information and value definition.

(4) **Lead finish/Ball material:** Parts may have multiple material finish options. Finish options are separated by a vertical ruled line. Lead finish/Ball material values may wrap to two lines if the finish value exceeds the maximum column width.

(5) **MSL rating/Peak reflow:** The moisture sensitivity level ratings and peak solder (reflow) temperatures. In the event that a part has multiple moisture sensitivity ratings, only the lowest level per JEDEC standards is shown. Refer to the shipping label for the actual reflow temperature that will be used to mount the part to the printed circuit board.

(6) **Part marking:** There may be an additional marking, which relates to the logo, the lot trace code information, or the environmental category of the part.

Multiple part markings will be inside parentheses. Only one part marking contained in parentheses and separated by a "~" will appear on a part. If a line is indented then it is a continuation of the previous line and the two combined represent the entire part marking for that device.

**Important Information and Disclaimer:**The information provided on this page represents TI's knowledge and belief as of the date that it is provided. TI bases its knowledge and belief on information provided by third parties, and makes no representation or warranty as to the accuracy of such information. Efforts are underway to better integrate information from third parties. TI has taken and continues to take reasonable steps to provide representative and accurate information but may not have conducted destructive testing or chemical analysis on incoming materials and chemicals. TI and TI suppliers consider certain information to be proprietary, and thus CAS numbers and other limited information may not be available for release.

In no event shall TI's liability arising out of such information exceed the total purchase price of the TI part(s) at issue in this document sold by TI to Customer on an annual basis.



**TAPE AND REEL INFORMATION**

**QUADRANT ASSIGNMENTS FOR PIN 1 ORIENTATION IN TAPE**

\*All dimensions are nominal

Device	Package Type	Package Drawing	Pins	SPQ	Reel Diameter (mm)	Reel Width W1 (mm)	A0 (mm)	B0 (mm)	K0 (mm)	P1 (mm)	W (mm)	Pin1 Quadrant
LM4947TL/NOPB	DSBGA	YZR	25	250	178.0	8.4	2.69	2.69	0.76	4.0	8.0	Q1

**TAPE AND REEL BOX DIMENSIONS**

\*All dimensions are nominal

Device	Package Type	Package Drawing	Pins	SPQ	Length (mm)	Width (mm)	Height (mm)
LM4947TL/NOPB	DSBGA	YZR	25	250	208.0	191.0	35.0

YZR0025

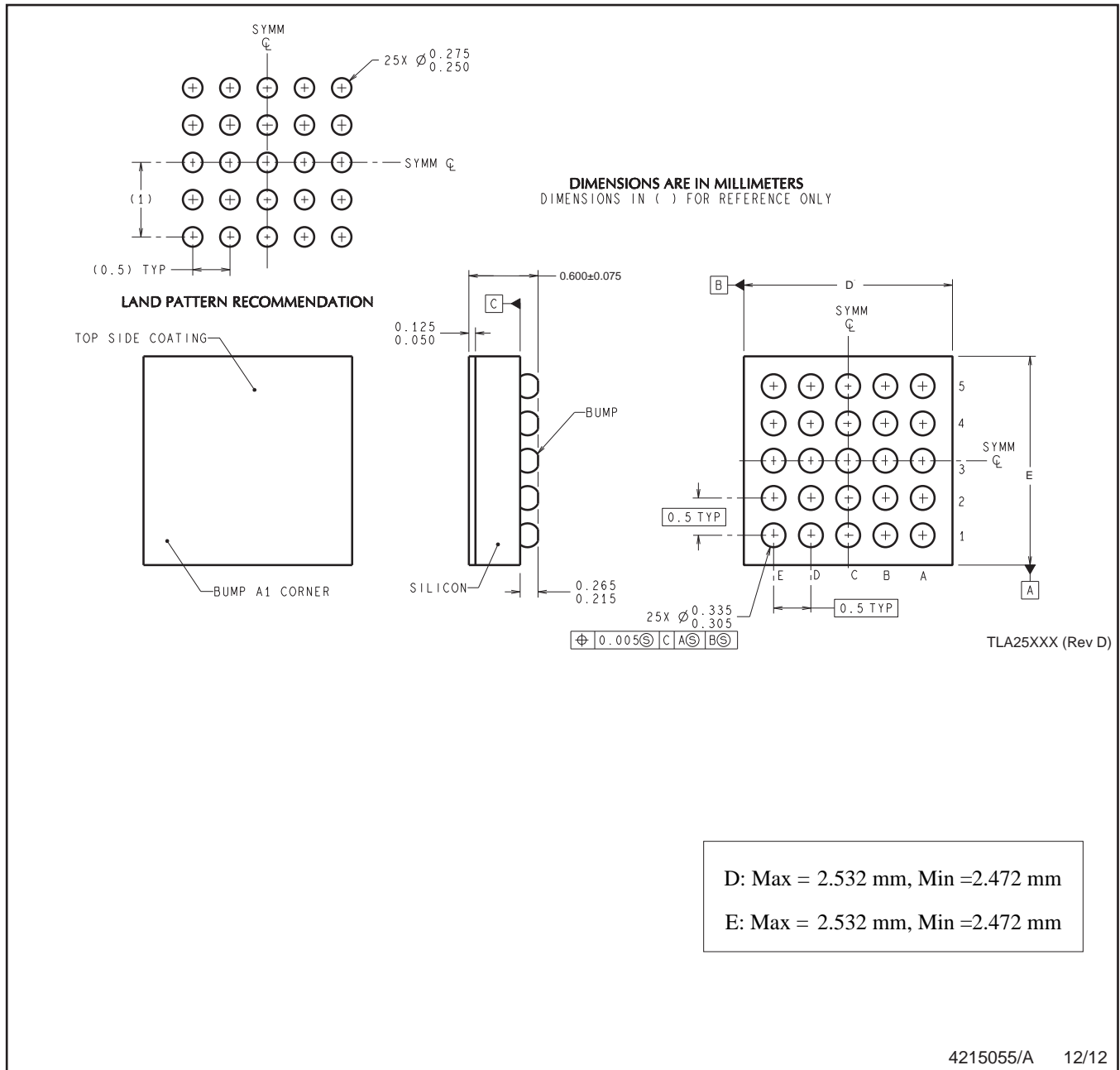

4215055/A 12/12

NOTES: A. All linear dimensions are in millimeters. Dimensioning and tolerancing per ASME Y14.5M-1994.  
B. This drawing is subject to change without notice.

## IMPORTANT NOTICE AND DISCLAIMER

TI PROVIDES TECHNICAL AND RELIABILITY DATA (INCLUDING DATASHEETS), DESIGN RESOURCES (INCLUDING REFERENCE DESIGNS), APPLICATION OR OTHER DESIGN ADVICE, WEB TOOLS, SAFETY INFORMATION, AND OTHER RESOURCES "AS IS" AND WITH ALL FAULTS, AND DISCLAIMS ALL WARRANTIES, EXPRESS AND IMPLIED, INCLUDING WITHOUT LIMITATION ANY IMPLIED WARRANTIES OF MERCHANTABILITY, FITNESS FOR A PARTICULAR PURPOSE OR NON-INFRINGEMENT OF THIRD PARTY INTELLECTUAL PROPERTY RIGHTS.

These resources are intended for skilled developers designing with TI products. You are solely responsible for (1) selecting the appropriate TI products for your application, (2) designing, validating and testing your application, and (3) ensuring your application meets applicable standards, and any other safety, security, regulatory or other requirements.

These resources are subject to change without notice. TI grants you permission to use these resources only for development of an application that uses the TI products described in the resource. Other reproduction and display of these resources is prohibited. No license is granted to any other TI intellectual property right or to any third party intellectual property right. TI disclaims responsibility for, and you fully indemnify TI and its representatives against any claims, damages, costs, losses, and liabilities arising out of your use of these resources.

TI's products are provided subject to [TI's Terms of Sale](#), [TI's General Quality Guidelines](#), or other applicable terms available either on [ti.com](http://ti.com) or provided in conjunction with such TI products. TI's provision of these resources does not expand or otherwise alter TI's applicable warranties or warranty disclaimers for TI products. Unless TI explicitly designates a product as custom or customer-specified, TI products are standard, catalog, general purpose devices.

TI objects to and rejects any additional or different terms you may propose.

Copyright © 2025, Texas Instruments Incorporated

Last updated 10/2025