

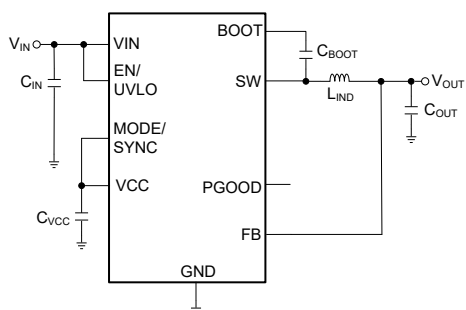
# LMR36503E-Q1 3V to 65V, 0.3A, Automotive, Grade 0, Synchronous Buck Converter Optimized for Size and Light Load Efficiency

## 1 Features

- AEC-Q100-qualified for automotive applications:
  - Device temperature grade 0:  $-40^{\circ}\text{C}$  to  $+150^{\circ}\text{C}$ ,  $T_A$
- > 70% efficiency at 5mA
  - $4\mu\text{A}$   $I_Q$  (switching) at  $24V_{IN}$  to  $3.3V_{OUT}$  (fixed output option)
- Miniature design size and low component cost
  - $2\text{mm} \times 2\text{mm}$  HotRod™ package with wettable flanks
  - Internal compensation
- Designed for automotive applications:
  - Junction temperature range  $-40^{\circ}\text{C}$  to  $+175^{\circ}\text{C}$
  - Pseudo-random spread spectrum compatible with [CISPR 25 EMI standard](#)
  - Wide input voltage range: 3V (falling threshold) to 65V
  - Adjustable and 3.3V fixed output voltage options available
  - Synchronizable with MODE/SYNC pin variant
  - Adjustable  $F_{SW}$ : 200kHz to 2.2MHz with RT pin variant
  - [Functional Safety-Capable](#)
    - [Documentation available to aid designs requiring functional safety](#)
  - Pin compatible with [LMR36503-Q1](#) (65V, 300mA)
- Create a custom design using the LMR36503E-Q1 with the [WEBENCH® Power Designer](#)

## 2 Applications

- [Advanced driver assistance systems \(ADAS\)](#)
- [Body electronics and lighting](#)
- [Infotainment and cluster](#)



Simplified Schematic

## 3 Description

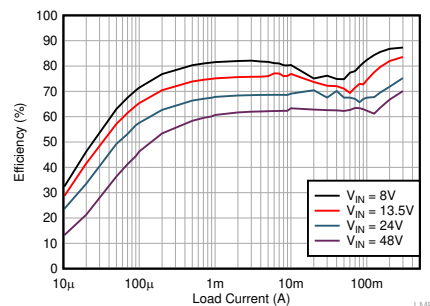
The LMR36503E-Q1 is a 65V, 0.3A synchronous step-down DC/DC converter in  $2\text{mm} \times 2\text{mm}$  HotRod package. This easy-to-use converter can handle input voltage transients up to 70V, provide excellent EMI performance, and support fixed 3.3V, 5V and other adjustable output voltages.

The LMR36503E-Q1 uses peak current mode control architecture with internal compensation and maintains stable operation with minimal output capacitance. The wide input operating range of the LMR36503E-Q1 helps the device remain functional during a deep input voltage sag condition, making the device an excellent choice for automotive applications withstanding severe cold crank start impulses. The PGOOD flag in the LMR36503E-Q1 provides precise indication of the output voltage status, eliminating the requirement for an external supervisor. A seamless transition from FPWM to PFM, with an ultra-low standby quiescent current allows the LMR36503E-Q1 to support much higher system efficiency at low output loads. The MODE/SYNC pin variant helps to synchronize the LMR36503E-Q1 to an external clock. With the right resistor selection, the LMR36503E-Q1 RT pin variant can also be externally programmed to any desired switching frequency of operation. The rich feature set of the LMR36503E-Q1 is designed to simplify implementation for a wide range of automotive end equipments.

### Package Information

PART NUMBER	PACKAGE <sup>(1)</sup>	PACKAGE SIZE <sup>(2)</sup>
LMR36503E-Q1	RPE (VQFN-HR, 9)	$2.00\text{mm} \times 2.00\text{mm}$

- (1) For more information, see [Section 11](#).
- (2) The package size (length  $\times$  width) is a nominal value and includes pins, where applicable.



Efficiency versus Output Current  $V_{OUT} = 3.3V$   
(Fixed), 2.2MHz



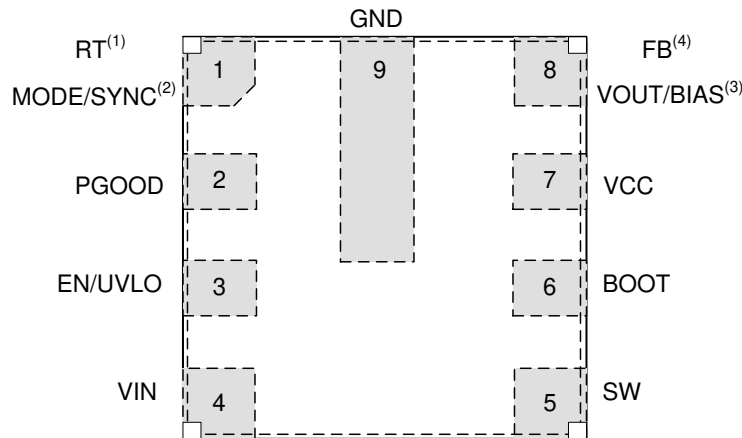
## Table of Contents

<b>1 Features</b> .....	<b>1</b>	<b>8 Application and Implementation</b> .....	<b>29</b>
<b>2 Applications</b> .....	<b>1</b>	8.1 Application Information.....	29
<b>3 Description</b> .....	<b>1</b>	8.2 Typical Application.....	30
<b>4 Device Comparison Table</b> .....	<b>3</b>	8.3 Best Design Practices.....	41
<b>5 Pin Configuration and Functions</b> .....	<b>4</b>	8.4 Power Supply Recommendations.....	41
<b>6 Specifications</b> .....	<b>5</b>	8.5 Layout.....	41
6.1 Absolute Maximum Ratings.....	5	<b>9 Device and Documentation Support</b> .....	<b>44</b>
6.2 ESD (Automotive) Ratings.....	5	9.1 Device Support.....	44
6.3 Recommended Operating Conditions.....	5	9.2 Documentation Support.....	44
6.4 Thermal Information.....	6	9.3 Receiving Notification of Documentation Updates.....	44
6.5 Electrical Characteristics.....	6	9.4 Support Resources.....	44
6.6 System Characteristics.....	8	9.5 Trademarks.....	45
6.7 Typical Characteristics.....	10	9.6 Electrostatic Discharge Caution.....	45
<b>7 Detailed Description</b> .....	<b>11</b>	9.7 Glossary.....	45
7.1 Overview.....	11	<b>10 Revision History</b> .....	<b>45</b>
7.2 Functional Block Diagram.....	12	<b>11 Mechanical, Packaging, and Orderable Information</b> .....	<b>46</b>
7.3 Feature Description.....	13	11.1 Tape and Reel Information.....	46
7.4 Device Functional Modes.....	23		

## 4 Device Comparison Table

ORDERABLE PART NUMBER	OUTPUT VOLTAGE	EXTERNAL SYNC	F <sub>sw</sub>	SPREAD SPECTRUM
LMR36503MSAERPERQ1	Adjustable	Yes (PFM/FPWM Selectable)	Fixed 400kHz	Yes
LMR36503MSCERPERQ1	Adjustable	Yes (PFM/FPWM Selectable)	Fixed 2.2MHz	Yes
LMR36503RSERPERQ1	Adjustable	No (Default PFM at light load)	Adjustable with RT resistor	Yes
LMR36503RS3ERPERQ1	3.3V fixed	No (Default PFM at light load)	Adjustable with RT resistor	Yes

## 5 Pin Configuration and Functions



- A. See [Section 4](#) for more details. Pin 1 trimmed and factory-set for externally adjustable switching frequency RT variants only.
- B. Pin 1 factory-set for fixed switching frequency MODE/SYNC variants only.
- C. Pin 8 trimmed and factory-set for fixed output voltage VOUT/BIAS variants only.
- D. Pin 8 factory-set for adjustable output voltage FB variants only.

**Figure 5-1. 9-Pin (2mm × 2mm) VQFN-HR RPE Package (Top View)**

**Table 5-1. Pin Functions**

PIN		TYPE	DESCRIPTION
NO.	NAME		
1	RT or MODE/SYNC	A	When the device is trimmed as the RT variant, the switching frequency can be adjusted from 200kHz to 2.2MHz. When the device is trimmed as the MODE/SYNC variant, the device can operate in user-selectable PFM/FPWM mode and can be synchronized to an external clock. <i>Do not float this pin.</i>
2	PGOOD	A	Open-drain power-good flag output. Connect to a suitable voltage supply through a current limiting resistor. High = power OK, low = power bad. This pin goes low when EN = low. This pin can be open or grounded when not used.
3	EN/UVLO	A	Enable input to regulator. High = ON, low = OFF. Can be connected directly to VIN. <i>Do not float this pin.</i>
4	VIN	P	Input supply to regulator. Connect a high-quality bypass capacitor or capacitors directly to this pin and GND.
5	SW	P	Regulator switch node. Connect to power inductor.
6	BOOT	P	Bootstrap supply voltage for internal high-side driver. Connect a high-quality, 100nF capacitor from this pin to the SW pin.
7	VCC	P	Internal LDO output. Used as supply to internal control circuits. Do not connect to external loads. Can be used as logic supply for power-good flag. Connect a high-quality, 1μF capacitor from this pin to GND.
8	VOUT/BIAS or FB	A	Fixed output options are available with the VOUT/BIAS pin variant. Connect to output voltage node for fixed VOUT. Check <a href="#">Section 4</a> for more details. The FB pin variant can help adjust the output voltage. Connect to tap point of feedback voltage divider. <i>Do not float this pin.</i>
9	GND	G	Power ground terminal. Connect to system ground. Connect to C <sub>IN</sub> with short, wide traces.

A = Analog, P = Power, G = Ground

## 6 Specifications

### 6.1 Absolute Maximum Ratings

Over the recommended operating junction temperature range of  $-40^{\circ}\text{C}$  to  $175^{\circ}\text{C}$  (unless otherwise noted)<sup>(1) (2)</sup>

PARAMETER		MIN	MAX	UNIT
Voltage	VIN to GND	-0.3	70	V
	EN to GND	-0.3	70	V
	SW to GND	-0.3	70.3	V
	PGOOD to GND	0	20	V
	VOUT/BIAS to GND (Fixed output)	-0.3	16	V
	FB to GND - (Adjustable output)	-0.3	16	V
	BOOT to SW	-0.3	5.5	V
	VCC to GND	-0.3	5.5	V
	RT to GND (RT variant)	-0.3	5.5	V
	MODE/SYNC to GND (MODE/SYNC variant)	-0.3	5.5	V
T <sub>J</sub>	Junction temperature <sup>(2)</sup>	-40	175	$^{\circ}\text{C}$
T <sub>stg</sub>	Storage temperature	-65	175	$^{\circ}\text{C}$

- (1) Operation outside the Absolute Maximum Ratings may cause permanent device damage. Absolute Maximum Ratings do not imply functional operation of the device at these or any other conditions beyond those listed under Recommended Operating Conditions. If used outside the Recommended Operating Conditions but within the Absolute Maximum Ratings, the device may not be fully functional, and this may affect device reliability, functionality, performance, and shorten the device lifetime.
- (2) High junction temperatures degrade operating lifetimes. Operating lifetime is derated for junction temperatures greater than  $175^{\circ}\text{C}$ . See [Section 8.1.1](#) for more information.

### 6.2 ESD (Automotive) Ratings

			VALUE	UNIT
V <sub>(ESD)</sub>	Electrostatic discharge	Human-body model (HBM), per AEC Q100-002 <sup>(1)</sup>	$\pm 2000$	V
		Charged-device model (CDM), per AEC Q100-011	$\pm 750$	V

- (1) AEC Q100-002 indicates that HBM stressing must be in accordance with the ANSI/ESDA/JEDEC JS-001 specification.

### 6.3 Recommended Operating Conditions

Over the recommended operating junction temperature range of  $-40^{\circ}\text{C}$  to  $175^{\circ}\text{C}$  (unless otherwise noted)<sup>(1) (2)</sup>

		MIN	TYP	MAX	UNIT
Input voltage	Input voltage range after start-up	3.6		65	V
Output current	Load current range <sup>(3)</sup>	0		0.3	A
Frequency setting	Selectable frequency range with RT (RT variant only)	0.2		2.2	MHz
	Set frequency value with RT connected to GND (RT variant only)		2.2		MHz
	Set frequency value with RT connected to VCC (RT variant only)		1		MHz
External clock setting	External Sync CLK (MODE/SYNC variant only)	0.2		2.2	MHz
T <sub>J</sub>	Operating junction temperature <sup>(2)</sup>	-40		175	$^{\circ}\text{C}$

- (1) Recommended operating conditions indicate conditions for which the device is intended to be functional, but do not ensure specific performance limits. For ensured specifications, see Electrical Characteristics table.
- (2) High junction temperatures degrade operating lifetimes. Operating lifetime is derated for junction temperatures greater than  $175^{\circ}\text{C}$ . See [Section 8.1.1](#) for more information.
- (3) Maximum continuous DC current can be derated when operating with high switching frequency or high ambient temperature. See Application section for details.

## 6.4 Thermal Information

The value of  $R_{\theta JA}$  given in this table is only valid for comparison with other packages and cannot be used for design purposes. These values were calculated in accordance with JESD 51-7, and simulated on a 4-layer JEDEC board. It does not represent the performance obtained in an actual application. For example, with a 4-layer PCB, a  $R_{\theta JA} = 58^{\circ}\text{C/W}$  can be achieved

THERMAL METRIC <sup>(1)</sup>		LMR36503E-Q1	
		VQFN (RPE)	
		9 Pins	
			UNIT
$R_{\theta JA}$	Junction-to-ambient thermal resistance	84.4	$^{\circ}\text{C/W}$
$R_{\theta JC(\text{top})}$	Junction-to-case (top) thermal resistance	47.5	$^{\circ}\text{C/W}$
$R_{\theta JB}$	Junction-to-board thermal resistance	26.1	$^{\circ}\text{C/W}$
$\Psi_{JT}$	Junction-to-top characterization parameter	0.9	$^{\circ}\text{C/W}$
$\Psi_{JB}$	Junction-to-board characterization parameter	25.9	$^{\circ}\text{C/W}$
$R_{\theta JA\text{-EVM}}$	Junction-to-ambient thermal resistance for EVM	49.6	$^{\circ}\text{C/W}$

- (1) For more information about traditional and new thermal metrics, see the [Semiconductor and IC Package Thermal Metrics](#) application note. For design information see the Maximum Ambient Temperature section.

## 6.5 Electrical Characteristics

Limits apply over the recommended operating junction temperature ( $T_J$ ) range of  $-40^{\circ}\text{C}$  to  $+175^{\circ}\text{C}$ , unless otherwise stated. Minimum and maximum limits are specified through test, design or statistical correlation. Typical values represent the most likely parametric norm at  $T_J = 25^{\circ}\text{C}$ , and are provided for reference purposes only. Unless otherwise stated, the following conditions apply:  $V_{IN} = 24\text{V}$ .<sup>(1)</sup>

PARAMETER		TEST CONDITIONS	MIN	TYP	MAX	UNIT
<b>SUPPLY VOLTAGE (VIN PIN)</b>						
$V_{IN\_R}$	Minimum operating input voltage (rising)	Rising threshold		3.4	3.6	V
$V_{IN\_F}$	Minimum operating input voltage (falling)	Once operating; Falling threshold	2.45	3.0		V
$I_{SD\_13p5}$	Shutdown quiescent current; measured at VIN pin <sup>(2)</sup>	$V_{EN} = 0; V_{IN} = 13.5\text{V}$		0.5	1.1	$\mu\text{A}$
$I_{SD\_24p0}$	Shutdown quiescent current; measured at VIN pin <sup>(2) (5)</sup>	$V_{EN} = 0; V_{IN} = 24\text{V}$		1	1.6	$\mu\text{A}$
$I_{Q\_13p5\_Fixed}$	Non-switching input current; measured at VIN pin <sup>(2)</sup>	$V_{IN} = V_{EN} = 13.5\text{V}; V_{OUT/BIAS} = 5.25\text{V}, V_{MODE/SYNC} = V_{RT} = 0\text{V};$ Fixed output	0.25	0.672	1.1	$\mu\text{A}$
$I_{Q\_13p5\_Adj}$	Non-switching input current; measured at VIN pin <sup>(2)</sup>	$V_{IN} = V_{EN} = 13.5\text{V}; V_{FB} = 1.05\text{V}, V_{MODE/SYNC} = V_{RT} = 0\text{V};$ Adjustable output	10	17	27	$\mu\text{A}$
$I_{Q\_24p0\_Fixed}$	Non-switching input current; measured at VIN pin <sup>(2)</sup>	$V_{IN} = V_{EN} = 24\text{V}; V_{OUT/BIAS} = 5.25\text{V}, V_{MODE/SYNC} = V_{RT} = 0\text{V};$ Fixed output	0.8	1.2	1.7	$\mu\text{A}$
$I_{Q\_24p0\_Adj}$	Non-switching input current; measured at VIN pin <sup>(2)</sup>	$V_{IN} = V_{EN} = 24\text{V}; V_{FB} = 1.05\text{V}, V_{MODE/SYNC} = V_{RT} = 0\text{V};$ Adjustable output	10	18	27	$\mu\text{A}$
$I_{B\_13p5}$	Current into VOUT/BIAS pin (not switching) <sup>(2)</sup>	$V_{IN} = 13.5\text{V}, V_{OUT/BIAS} = 5.25\text{V}, V_{MODE/SYNC} = V_{RT} = 0\text{V};$ Fixed output	14	17	22	$\mu\text{A}$
$I_{B\_24p0}$	Current into VOUT/BIAS pin (not switching) <sup>(2)</sup>	$V_{IN} = 24\text{V}, V_{OUT/BIAS} = 5.25\text{V}, V_{MODE/SYNC} = V_{RT} = 0\text{V};$ Fixed output	14	18	22	$\mu\text{A}$
<b>ENABLE (EN PIN)</b>						
$V_{EN\text{-WAKE}}$	Enable wake-up threshold		0.4			V
$V_{EN\text{-VOU}}$	Precision enable high level for VOUT		1.16	1.263	1.36	V
$V_{EN\text{-HYST}}$	Enable threshold hysteresis below $V_{EN\text{-VOU}}$		0.3	0.35	0.4	V
$I_{LKG\text{-EN}}$	Enable input leakage current	$V_{EN} = 3.3\text{V}$		0.3	8	nA
<b>INTERNAL LDO</b>						

## 6.5 Electrical Characteristics (continued)

Limits apply over the recommended operating junction temperature ( $T_J$ ) range of  $-40^{\circ}\text{C}$  to  $+175^{\circ}\text{C}$ , unless otherwise stated. Minimum and maximum limits are specified through test, design or statistical correlation. Typical values represent the most likely parametric norm at  $T_J = 25^{\circ}\text{C}$ , and are provided for reference purposes only. Unless otherwise stated, the following conditions apply:  $V_{IN} = 24\text{V}$ .<sup>(1)</sup>

PARAMETER		TEST CONDITIONS	MIN	TYP	MAX	UNIT
$V_{CC}$	Internal VCC voltage	Adjustable or fixed output; Auto mode	3	3.15	3.25	V
$I_{CC}$	Bias regulator current limit			65	240	mA
$V_{CC-UVLO}$	Internal VCC undervoltage lockout	VCC rising under voltage threshold	3	3.3	3.65	V
$V_{CC-UVLO-HYST}$	Internal VCC under voltage lock-out hysteresis	Hysteresis below $V_{CC-UVLO}$	0.4	0.8	1.2	V
<b>CURRENT LIMITS</b>						
$I_{PEAK-MIN}$	Minimum peak inductor current <sup>(3)</sup>	PFM Operation, Duty Factor = 0	0.067	0.09	0.14	A
$I_{ZC}$	Zero cross current <sup>(3)</sup>	Auto mode	0	0.01	0.025	A
$I_{L-NEG}$	Sink current limit (negative) <sup>(3)</sup>	FPWM mode	-0.6	-0.72	-0.8	A
<b>POWER GOOD</b>						
PG-OV	PGOOD upper threshold - rising	% of FB (Adjustable output) or % of VOUT/BIAS (Fixed output)	106	107	110	%
PG-UV	PGOOD lower threshold - falling	% of FB (Adjustable output) or % of VOUT/BIAS (Fixed output)	93	94	96.5	%
PG-HYS	PGOOD hysteresis - rising/falling	% of FB (Adjustable output) or % of VOUT/BIAS (Fixed output)	0.85	1.8	2.3	%
$V_{PG-VALID}$	Minimum input voltage for proper PG function		0.75	1	2	V
$R_{PG-EN5p0}$	$R_{DS(ON)}$ PGOOD output	$V_{EN} = 5.0\text{V}$ , 1mA pullup current	20	40	85	$\Omega$
$R_{PG-EN0}$	$R_{DS(ON)}$ PGOOD output	$V_{EN} = 0\text{V}$ , 1mA pullup current	10	18	40	$\Omega$
<b>OSCILLATOR (MODE/SYNC)</b>						
$V_{MODE-H}$	Sync input and mode high level threshold		1.8			V
$V_{SYNC-HYS}$	Sync input hysteresis		210	300	400	mV
$V_{MODE-L}$	Sync input and mode low level threshold				0.8	V
<b>MOSFETS</b>						
$R_{DS-ON-HS}$	High-side MOSFET on-resistance	Load = 0.3A		560	1200	m $\Omega$
$R_{DS-ON-LS}$	Low-side MOSFET on-resistance	Load = 0.3A		280	550	m $\Omega$
$V_{CBOOT-UVLO}$	Cboot - SW UVLO threshold <sup>(4)</sup>		2.14	2.3	2.42	V
<b>THERMAL SHUTDOWN</b>						
<b>VOLTAGE REFERENCE</b>						
$V_{REF}$	Internal reference voltage	$V_{IN} = 3.6\text{V}$ to 65V, FPWM mode	0.985	1	1.01	V
$I_{FB}$	FB input current	Adjustable output, FB = 1V		85	110	nA
<b>SOFT START</b>						
$t_{SS}$	Time from first SW pulse to $V_{FB}$ at 90%, of $V_{REF}$	$V_{IN} \geq 3.6\text{V}$	1.95	2.58	3.2	ms
<b>POWER GOOD</b>						
$t_{RESET\_FILTER}$	Glitch filter time constant for PG function		15	25	40	$\mu\text{s}$
$t_{PGOOD\_ACT}$	Delay time to PG high signal		1.7	1.956	2.16	ms
<b>OSCILLATOR (MODE/SYNC)</b>						
$t_{PULSE\_H}$	High duration needed to be recognized as a pulse		100			ns

## 6.5 Electrical Characteristics (continued)

Limits apply over the recommended operating junction temperature ( $T_J$ ) range of  $-40^{\circ}\text{C}$  to  $+175^{\circ}\text{C}$ , unless otherwise stated. Minimum and maximum limits are specified through test, design or statistical correlation. Typical values represent the most likely parametric norm at  $T_J = 25^{\circ}\text{C}$ , and are provided for reference purposes only. Unless otherwise stated, the following conditions apply:  $V_{IN} = 24\text{V}$ .<sup>(1)</sup>

PARAMETER		TEST CONDITIONS	MIN	TYP	MAX	UNIT
$t_{\text{PULSE\_L}}$	Low duration needed to be recognized as a pulse		100			ns
$t_{\text{SYNC}}$	High/low signal duration in a valid synchronization signal		6	9	13	$\mu\text{s}$
$t_{\text{MODE}}$	Time at one level needed to indicate FPWM or Auto Mode		18			$\mu\text{s}$
<b>PWM LIMITS (SW)</b>						
$t_{\text{ON-MIN}}$	Minimum switch on-time	$I_{\text{OUT}} = 0.3\text{A}$	35	60	97	ns
$t_{\text{OFF-MIN}}$	Minimum switch off-time		40	58	80	ns
$t_{\text{ON-MAX}}$	Maximum switch on-time	HS timeout in dropout	7.6	9	9.8	$\mu\text{s}$
<b>OSCILLATOR (RT)</b>						
$f_{\text{OSC\_2p2MHz}}$	Internal oscillator frequency	RT = GND	2.1	2.2	2.3	MHz
$f_{\text{OSC\_1p0MHz}}$	Internal oscillator frequency	RT = VCC	0.93	1	1.05	MHz
$f_{\text{FIXED\_400kHz}}$		RT = 39.2k $\Omega$	0.3	0.4	0.46	MHz
<b>SPREAD SPECTRUM</b>						

- (1) MIN and MAX limits are 100% production tested at  $25^{\circ}\text{C}$ . Limits over the operating temperature range verified through correlation using Statistical Quality Control (SQC) methods. Limits are used to calculate Average Outgoing Quality Level (AOQL).
- (2) This is the current used by the device open loop. It does not represent the total input current of the system when in regulation.
- (3) The current limit values in this table are tested, open loop, in production. They can differ from those found in a closed loop application.
- (4) When the voltage across the  $C_{\text{BOOT}}$  capacitor falls below this voltage, the low side MOSFET is turn to recharge the boot capacitor.
- (5) Expected spec change due to  $175^{\circ}\text{C}$   $T_J$  operation. Based on  $175^{\circ}\text{C}$  sims from LMR36502.

## 6.6 System Characteristics

The following specifications apply only to the typical applications circuit, with nominal component values. Specifications in the typical (TYP) column apply to  $T_J = 25^{\circ}\text{C}$  only. Specifications in the minimum (MIN) and maximum (MAX) columns apply to the case of typical components over the temperature range of  $T_J = -40^{\circ}\text{C}$  to  $175^{\circ}\text{C}$ . These specifications are not specified by production testing.

PARAMETER		TEST CONDITIONS	MIN	TYP	MAX	UNIT
<b>STANDBY CURRENT AND DUTY RATIO</b>						
$I_{\text{SUPPLY}}$	Input supply current when in regulation	$V_{IN} = 13.5\text{V}$ , $V_{\text{OUT}/\text{BIAS}} = 3.3\text{V}$ , $I_{\text{OUT}} = 0\text{A}$ , PFM mode		6.5		$\mu\text{A}$
$I_{\text{SUPPLY}}$	Input supply current when in regulation	$V_{IN} = 24\text{V}$ , $V_{\text{OUT}/\text{BIAS}} = 3.3\text{V}$ , $I_{\text{OUT}} = 0\text{A}$ , PFM mode		4		$\mu\text{A}$
$D_{\text{MAX}}$	Maximum switch duty cycle <sup>(1)</sup>			98%		
<b>OUTPUT VOLTAGE ACCURACY (VOUT/BIAS)</b>						
$V_{\text{OUT\_3p3V\_ACC}}$	$V_{\text{OUT}} = 3.3\text{V}$ , $V_{IN} = 3.6\text{V}$ to $65\text{V}$ , $I_{\text{OUT}} = 0$ to full load <sup>(2)</sup>	FPWM mode	-1.5		1.5	%
$V_{\text{OUT\_3p3V\_ACC}}$	$V_{\text{OUT}} = 3.3\text{V}$ , $V_{IN} = 3.6\text{V}$ to $65\text{V}$ , $I_{\text{OUT}} = 0\text{A}$ to full load <sup>(2)</sup>	Auto mode	-1.5		2.5	%
<b>SPREAD SPECTRUM</b>						
$f_{\text{SSS}}$	Frequency span of spread spectrum operation - largest deviation from center frequency	Spread spectrum active		$\pm 2$		%



## 6.6 System Characteristics (continued)

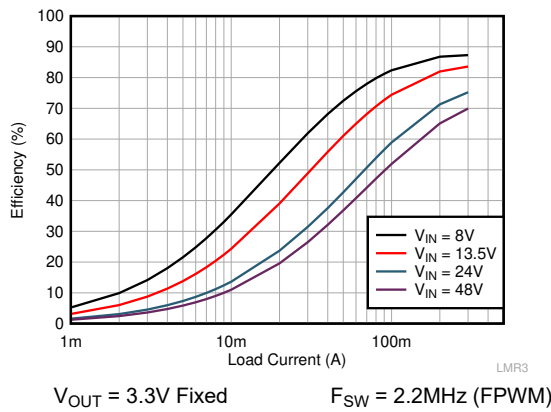
The following specifications apply only to the typical applications circuit, with nominal component values. Specifications in the typical (TYP) column apply to  $T_J = 25^\circ\text{C}$  only. Specifications in the minimum (MIN) and maximum (MAX) columns apply to the case of typical components over the temperature range of  $T_J = -40^\circ\text{C}$  to  $175^\circ\text{C}$ . These specifications are not specified by production testing.

PARAMETER		TEST CONDITIONS	MIN	TYP	MAX	UNIT
$f_{\text{PSS}}$	Spread spectrum pseudo random pattern frequency			0.98	1.5	Hz

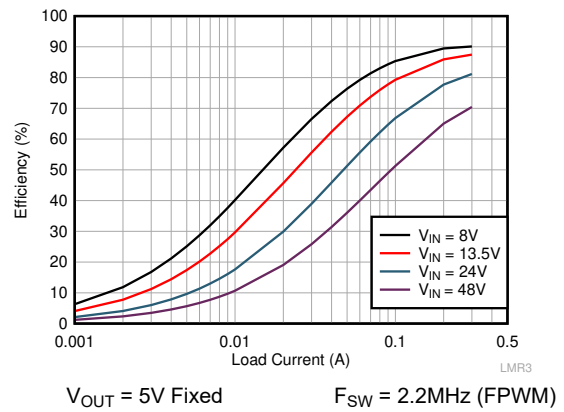
- (1) In dropout the switching frequency drops to increase the effective duty cycle. The lowest frequency is clamped at approximately:  $f_{\text{MIN}} = 1 / (t_{\text{ON-MAX}} + t_{\text{OFF-MIN}})$ .  $D_{\text{MAX}} = t_{\text{ON-MAX}} / (t_{\text{ON-MAX}} + t_{\text{OFF-MIN}})$ .
- (2) Deviation is with respect to  $V_{\text{IN}} = 13.5\text{V}$ .

## 6.7 Typical Characteristics

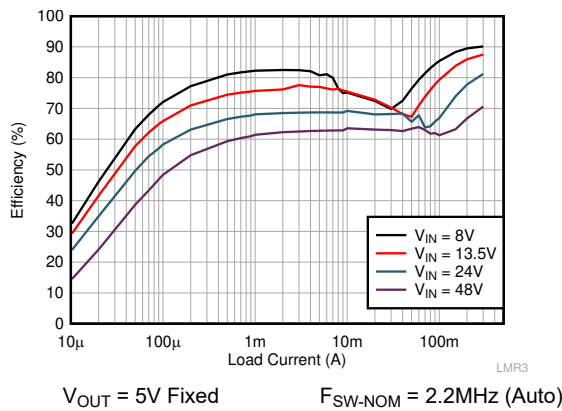
Unless otherwise specified, the following conditions apply:  $T_A = 25^\circ\text{C}$ ,  $V_{IN} = 13.5\text{V}$ .



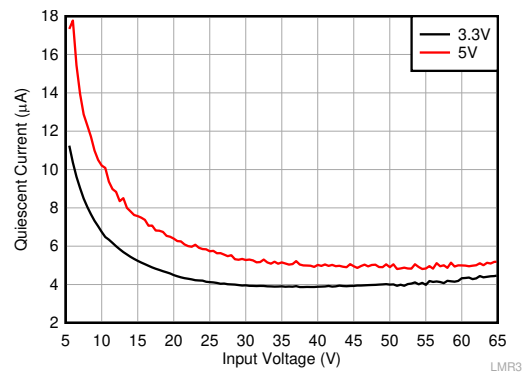
**Figure 6-1. Efficiency 3.3V Output, FPWM**



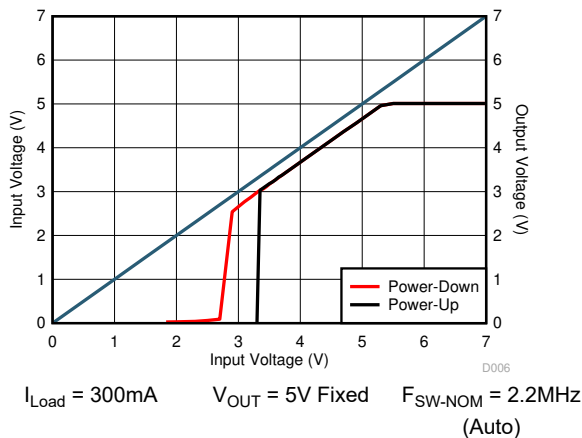
**Figure 6-2. Efficiency 5V Output, FPWM**



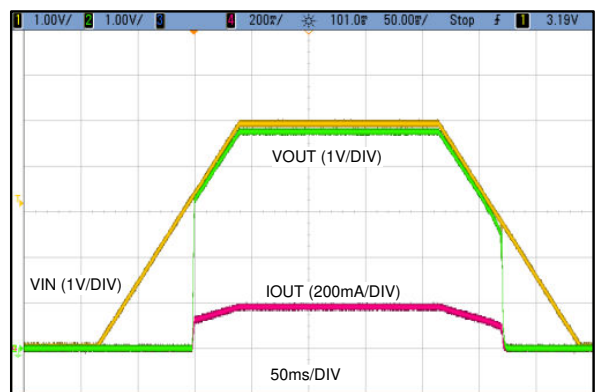
**Figure 6-3. Efficiency 5V Output, Auto Mode**



**Figure 6-4. Typical Input Supply Current at No Load for Fixed 3.3V and 5V Output**



**Figure 6-5. Dropout at Power-Up and Power-Down**



**Figure 6-6. Typical Start-up and Shutdown at  $V_{OUT} = 5\text{V}$**

## 7 Detailed Description

### 7.1 Overview

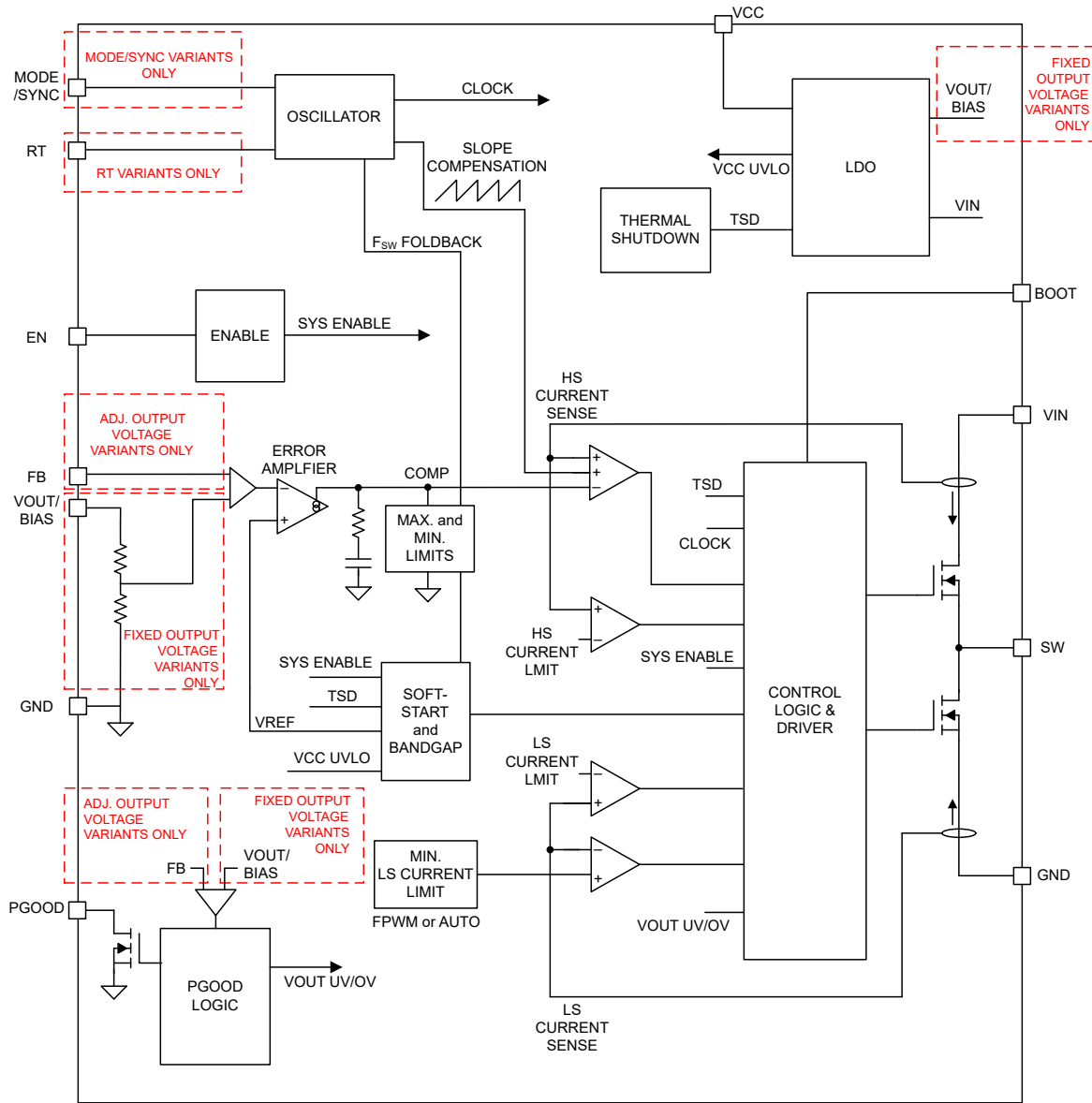
The LMR36503E-Q1 is a wide input, low-quiescent current, high-performance regulator that can operate over a wide range of duty ratio and the switching frequencies, including sub-AM band at 400kHz and above AM band at 2.2MHz. During wide input transients, if the minimum ON-time or the minimum OFF-time cannot support the desired duty ratio at the higher switching frequency settings, the switching frequency is reduced automatically, allowing the LMR36503E-Q1 to maintain the output voltage regulation. With an internally-compensated design optimized for minimal output capacitors, the system design process with the LMR36503E-Q1 is simplified significantly compared to other buck regulators available in the market.

The LMR36503E-Q1 is designed to minimize external component cost and design size while operating in all demanding automotive environments. The LMR36503E-Q1 family includes variants that can be set-up to operate over a wide switching frequency range, from 200kHz to 2.2MHz, with the correct resistor selection from RT pin to ground. To further reduce system cost, the PGOOD output feature with built-in delayed release allows the elimination of the reset supervisor in many applications.

The LMR36503E-Q1 family is designed to reduce EMI/EMC emissions. The design includes a pseudo-random spread spectrum switching frequency dithering scheme, has no bond-wire flip-chip on the lead (HotRod) package, and is available with the MODE/SYNC feature (select variants), allowing synchronization to an external clock, when available. Together, these features eliminate the need for any common-mode choke or shielding or any elaborate input filter design scheme, greatly reducing the complexity and cost of the EMI/EMC mitigation measures.

The LMR36503E-Q1 comes in an ultra-small, 2mm × 2mm QFN package with wettable flanks, allowing for quick optical inspection along with specially designed corner anchor pins for reliable board level solder connections.

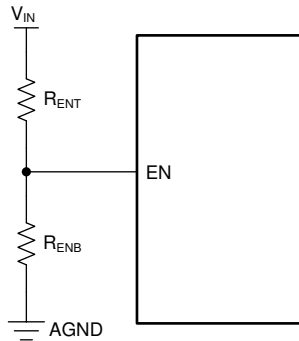
## 7.2 Functional Block Diagram



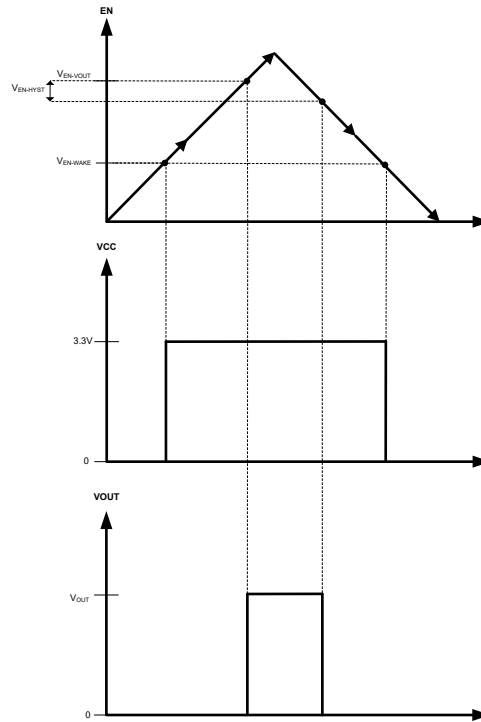
## 7.3 Feature Description

### 7.3.1 Enable, Start-Up, and Shutdown

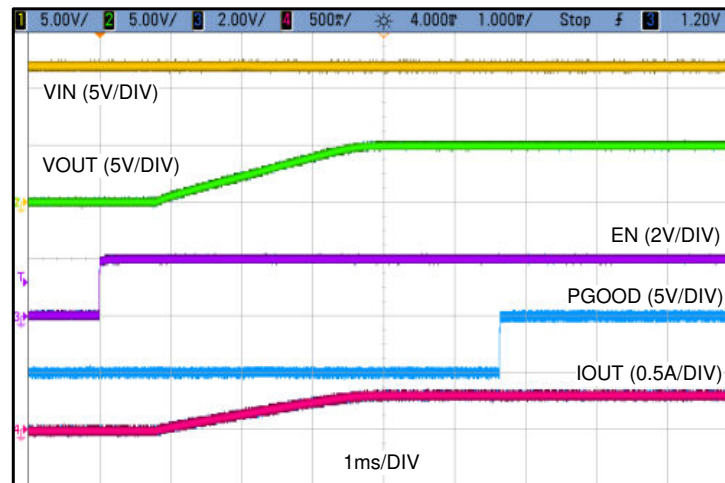
Voltage at the EN pin controls the start-up or remote shutdown of the LMR36503E-Q1 family of devices. The part stays shut down as long as the EN pin voltage is less than  $V_{EN-WAKE} = 0.4V$ . During the shutdown, the input current drawn by the device typically drops down to  $0.5\mu A$  ( $V_{IN} = 13.5V$ ). With the voltage at the EN pin greater than the  $V_{EN-WAKE}$ , the device enters the device standby mode, and the internal LDO powers up to generate VCC. As the EN voltage increases further, approaching  $V_{EN-VOUT}$ , the device finally starts to switch, entering the start-up mode, with a soft start. During the device shutdown process, when the EN input voltage measures less than  $(V_{EN-VOUT} - V_{EN-HYST})$ , the regulator stops switching and re-enters the device standby mode. Any further decrease in the EN pin voltage, below  $V_{EN-WAKE}$ , the device is then firmly shut down. The high-voltage compliant EN input pin can be connected directly to the VIN input pin if remote precision control is not needed. The EN input pin must not be allowed to float. The various EN threshold parameters and the values are listed in [Electrical Characteristics](#). [Figure 7-2](#) shows the precision enable behavior. [Figure 7-3](#) shows a typical remote EN start-up waveform in an application. After EN goes high, after a delay of about 1ms, the output voltage begins to rise with a soft start and reaches close to the final value in about 2.67ms ( $t_{SS}$ ). After a delay of about 2ms ( $t_{PGOOD\_ACT}$ ), the PGOOD flag goes high. During start-up, the device is not allowed to enter FPWM mode until the soft-start time has elapsed. This time is measured from the rising edge of EN. Check [Section 8.2.2.9.1](#) for component selection.



**Figure 7-1. VIN UVLO Using the EN Pin**



**Figure 7-2. Precision Enable Behavior**



**Figure 7-3. Enable Start-up  $V_{IN} = 12V$ ,  $V_{OUT} = 5V$ ,  $I_{OUT} = 300mA$**

### 7.3.2 External CLK SYNC (with MODE/SYNC)

Synchronizing the operation of multiple regulators in a single system, resulting in a well-defined system level performance is often desirable. The select variants in the LMR36503E-Q1 with the MODE/SYNC pin allow the power designer to synchronize the device to a common external clock. The LMR36503E-Q1 implements an in-phase locking scheme, where the rising edge of the clock signal, provided to the MODE/SYNC pin of the LMR36503E-Q1, corresponds to the turning on of the high-side device. The external clock synchronization is implemented using a phase locked loop (PLL) eliminating any large glitches. The external clock fed into the LMR36503E-Q1 replaces the internal free-running clock, but does not affect any frequency foldback operation. Output voltage continues to be well-regulated. The device remains in FPWM mode and operates in CCM for light loads when synchronization input is provided.

The MODE/SYNC input pin in the LMR36503E-Q1 can operate in one of three selectable modes:

- Auto mode: Pulse frequency modulation (PFM) operation is enabled during light load and diode emulation prevents reverse current through the inductor. See [Section 7.4.3.2](#) for more details.
- FPWM mode: In FPWM mode, diode emulation is disabled, allowing current to flow backwards through the inductor. This allows operation at full frequency even without load current. See [Section 7.4.3.3](#) for more details.
- SYNC mode: The internal clock locks to an external signal applied to the MODE/SYNC pin. As long as output voltage can be regulated at full frequency and is not limited by minimum off-time or minimum on-time, clock frequency is matched to the frequency of the signal applied to the MODE/SYNC pin. While the device is in SYNC mode, the device operates as though in FPWM mode. Diode emulation is disabled allowing the frequency applied to the MODE/SYNC pin to be matched without a load.

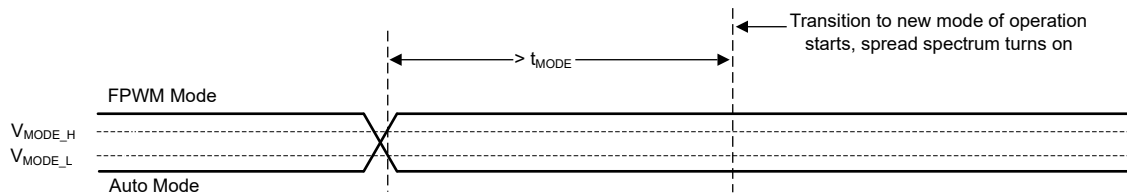
### 7.3.2.1 Pulse-Dependent MODE/SYNC Pin Control

Most systems that require more than a single mode of operation from the LMR36503E-Q1 are controlled by digital circuitry such as a microprocessor. These systems can generate dynamic signals easily but have difficulty generating multi-level signals. Pulse-dependent MODE/SYNC pin control is useful with these systems. To initiate Pulse-dependent MODE/SYNC pin control, a valid sync signal must be applied. [Table 7-1](#) shows a summary of the pulse dependent mode selection settings.

**Table 7-1. Pulse-Dependent Mode Selection Settings**

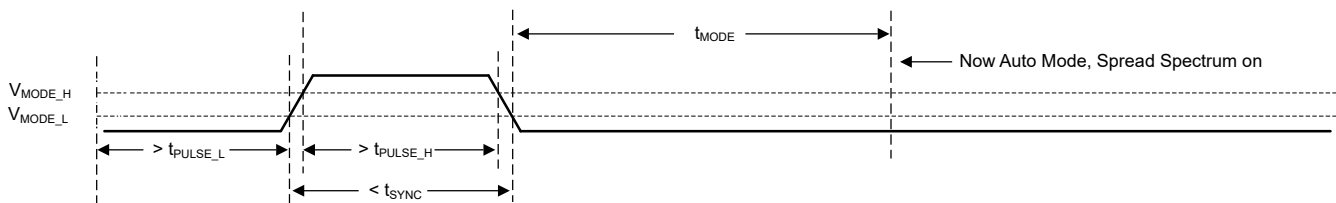
MODE/SYNC INPUT	MODE
$> V_{MODE\_H}$	FPWM with Spread Spectrum factory setting
$< V_{MODE\_L}$	Auto Mode with Spread Spectrum factory setting
Synchronization Clock	SYNC mode

[Figure 7-4](#) shows the transition between AUTO Mode and FPWM Mode while in Pulse-dependent MODE/SYNC control. The LMR36503E-Q1 transitions to a new mode of operation after the time,  $t_{MODE}$ . [Figure 7-4](#) and [Figure 7-5](#) show the details.

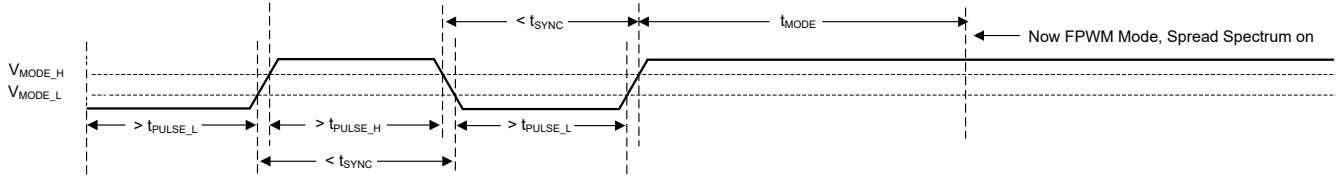


**Figure 7-4. Transition from Auto Mode and FPWM Mode**

If MODE/SYNC voltage remains constant longer than  $t_{MODE}$ , the LMR36503E-Q1 enters either Auto mode or FPWM mode with spread spectrum turned on (if factory setting is enabled) and MODE/SYNC continues to operate in Pulse-Dependent scheme.



**Figure 7-5. Transition from SYNC Mode to Auto Mode**



**Figure 7-6. Transition from SYNC Mode to FPWM Mode**

**7.3.3 Adjustable Switching Frequency (with RT)**

The select variants in the LMR36503E-Q1 family with the RT pin allow the power designers to set any desired operating frequency between 200kHz and 2.2MHz in the applications. See [Figure 7-7](#) to determine the resistor value needed for the desired switching frequency. The RT pin and the MODE/SYNC pin variants share the same pin location. The power supply designer can either use the RT pin variant and adjust the switching frequency of operation as warranted by the application or use the MODE/SYNC variant and synchronize to an external clock signal. See [Table 7-2](#) for selection on programming the RT pin.

**Table 7-2. RT Pin Setting**

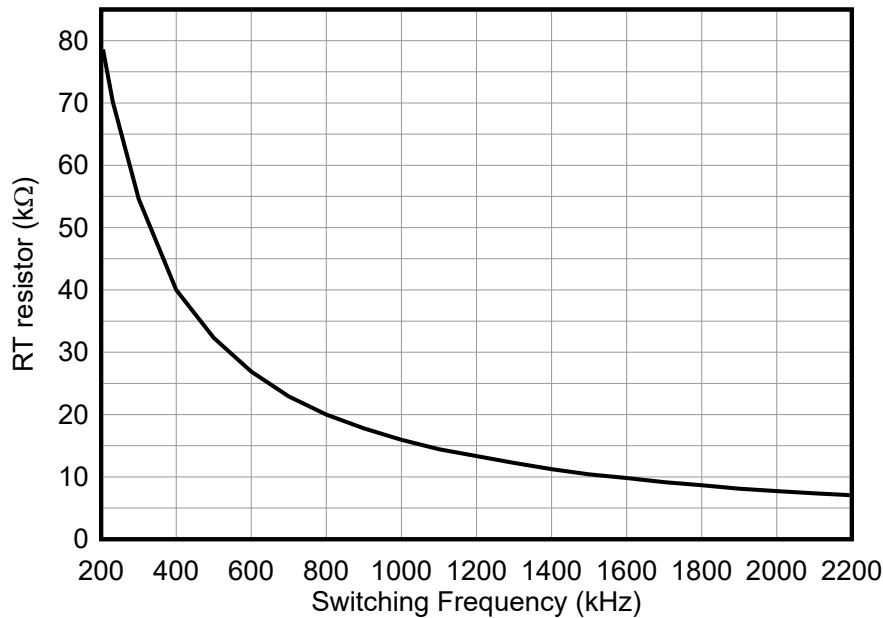
RT INPUT	SWITCHING FREQUENCY
VCC	1MHz
GND	2.2MHz
RT to GND	Adjustable according to <a href="#">Figure 7-7</a>
Float (Not Recommended)	No switching

[Equation 1](#) can be used to calculate the value of RT for a desired frequency.

$$R_T = \frac{18286}{F_{SW}^{1.021}} \tag{1}$$

where

- RT = Frequency setting resistor value (kΩ)
- F<sub>SW</sub> = Switching frequency (kHz)



**Figure 7-7. RT Values vs Frequency**



### 7.3.4 Power-Good Output Operation

The power-good feature using the PG pin of the LMR36503E-Q1 can be used to reset a system microprocessor whenever the output voltage is out of regulation. This open-drain output remains low under device fault conditions, such as current limit and thermal shutdown, as well as during normal start-up. A glitch filter prevents false flag operation for any short duration excursions in the output voltage, such as during line and load transients. Output voltage excursions lasting less than  $t_{\text{RESET\_FILTER}}$  do not trip the power-good flag. Power-good operation can best be understood in reference to Figure 7-8. Table 7-3 gives a more detailed breakdown the PGOOD operation. Here,  $V_{\text{PG-UV}}$  is defined as the PG-UV scaled version of the  $V_{\text{OUT-Reg}}$  (target regulated output voltage) and  $V_{\text{PG-HYS}}$  as the PG-HYS scaled version of the  $V_{\text{OUT-Reg}}$ , where both PG-UV and PG-HYS are listed in Section 6.5. During the initial power up, a total delay of 5ms (typical) is encountered from the time the  $V_{\text{EN-VOUT}}$  is triggered to the time that the power-good is flagged high. This delay only occurs during the device start-up and is not encountered during any other normal operation of the power-good function. When EN is pulled low, the power-good flag output is also forced low. With EN low, power-good remains valid as long as the input voltage ( $V_{\text{PG-VALID}}$  is  $\geq 1\text{V}$  (typical)).

The power-good output scheme consists of an open-drain n-channel MOSFET, which requires an external pullup resistor connected to a suitable logic supply. The power-good output scheme can also be pulled up to either  $V_{\text{CC}}$  or  $V_{\text{OUT}}$  through an appropriate resistor, as desired. If this function is not needed, the PGOOD pin can be open or grounded. Limit the current into this pin to  $\leq 4\text{mA}$ .

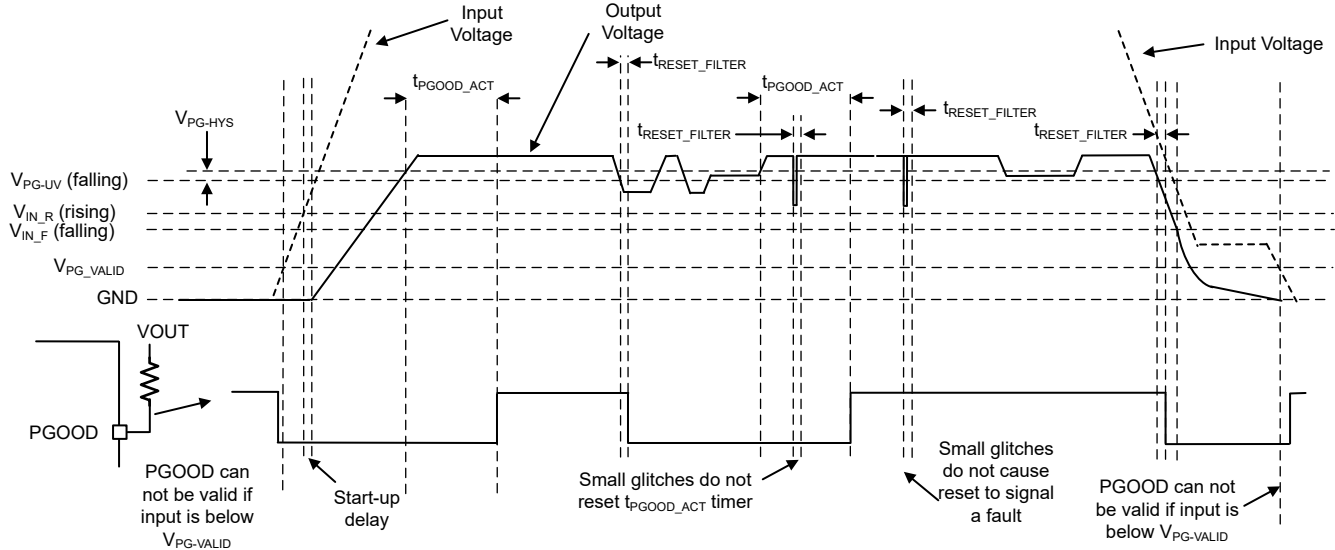


Figure 7-8. Power-Good Operation (OV Events Not Included)

Table 7-3. Fault Conditions for PGOOD (Pull Low)

FAULT CONDITION INITIATED	FAULT CONDITION ENDS (AFTER WHICH $t_{\text{PGOOD\_ACT}}$ MUST PASS BEFORE PGOOD OUTPUT IS RELEASED)
$V_{\text{OUT}} < V_{\text{PG-UV}}$ AND $t > t_{\text{RESET\_FILTER}}$	Output voltage in regulation: $V_{\text{PG-UV}} + V_{\text{PG-HYS}} < V_{\text{OUT}} < V_{\text{PG-OV}} - V_{\text{PG-HYS}}$
$V_{\text{OUT}} > V_{\text{PG-OV}}$ AND $t > t_{\text{RESET\_FILTER}}$	Output voltage in regulation
$T_{\text{J}} > T_{\text{SD-R}}$	$T_{\text{J}} < T_{\text{SD-F}}$ AND output voltage in regulation
$\text{EN} < V_{\text{EN-VOUT}} - V_{\text{EN-HYST}}$	$\text{EN} > V_{\text{EN-VOUT}}$ AND output voltage in regulation
$V_{\text{CC}} < V_{\text{CC-UVLO}} - V_{\text{CC-UVLO-HYST}}$	$V_{\text{CC}} > V_{\text{CC-UVLO}}$ AND output voltage in regulation

### 7.3.5 Internal LDO, VCC UVLO, and VOUT/BIAS Input

The LMR36503E-Q1 uses the internal LDO output and the VCC pin for all internal power supply. The VCC pin draws power either from the VIN (in adjustable output variants) or the VOUT/BIAS (in fixed-output variants). In the fixed output variants, after the LMR36503E-Q1 is active but has yet to regulate, the VCC rail continues to

draw power from the input voltage, VIN, until the VOUT/BIAS voltage reaches > 3.15V (or when the device has reached steady-state regulation post the soft start). The VCC rail typically measures 3.15V in both adjustable and fixed output variants. To prevent unsafe operation, VCC has an undervoltage lockout, which prevents switching if the internal voltage is too low. See  $V_{VCC-UVLO}$  and  $V_{VCC-UVLO-HYST}$  in [Section 6.5](#). During start-up, VCC momentarily exceeds the normal operating voltage until  $V_{VCC-UVLO}$  is exceeded, then drops to the normal operating voltage. Note that these undervoltage lockout values, when combined with the LDO dropout, drives the minimum input voltage rising and falling thresholds.

### 7.3.6 Bootstrap Voltage and $V_{CBOOT-UVLO}$ (CBOOT Terminal)

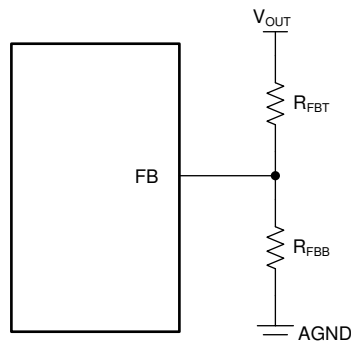
The high-side switch driver circuit requires a bias voltage higher than VIN to make sure the HS switch is turned ON. The capacitor connected between CBOOT and SW works as a charge pump to boost voltage on the CBOOT terminal to (SW+VCC). The boot diode is integrated on the LMR36503E-Q1 die to minimize physical design size. TI recommends a 100nF capacitor rated for 10V or higher for CBOOT. The CBOOT rail has an UVLO setting. This UVLO has a threshold of  $V_{CBOOT-UVLO}$  and is typically set at 2.3V. If the CBOOT capacitor is not charged above this voltage with respect to the SW pin, then the part initiates a charging sequence, turning on the low-side switch before attempting to turn on the high-side device.

### 7.3.7 Output Voltage Selection

In the LMR36503E-Q1 family, select variants with an adjustable output voltage option (see [Section 4](#)), and you need an external resistor divider connection between the output voltage node, the device FB pin, and the system GND, as shown in [Figure 7-9](#). The variants with adjustable output voltage option in the LMR36503E-Q1 family are designed with a 1V internal reference voltage.

$$R_{FBB} = \frac{R_{FBT}}{V_{OUT} - 1} \quad (2)$$

When using the fixed-output variants from the LMR36503E-Q1 family, simply connect the FB pin (identified as VOUT/BIAS pin for fixed-output variants in the rest of the data sheet) to the system output voltage node. See [Section 4](#) for more details.



**Figure 7-9. Setting Output Voltage for Adjustable Output Variant**

In adjustable output voltage variants, an additional feed-forward capacitor,  $C_{FF}$ , in parallel with the  $R_{FBT}$ , can be used to optimize the phase margin and transient response. See [Section 8.2.2.9](#) for more details. No additional resistor divider or feed-forward capacitor,  $C_{FF}$ , is needed in fixed-output variants.

### 7.3.8 Soft Start and Recovery from Dropout

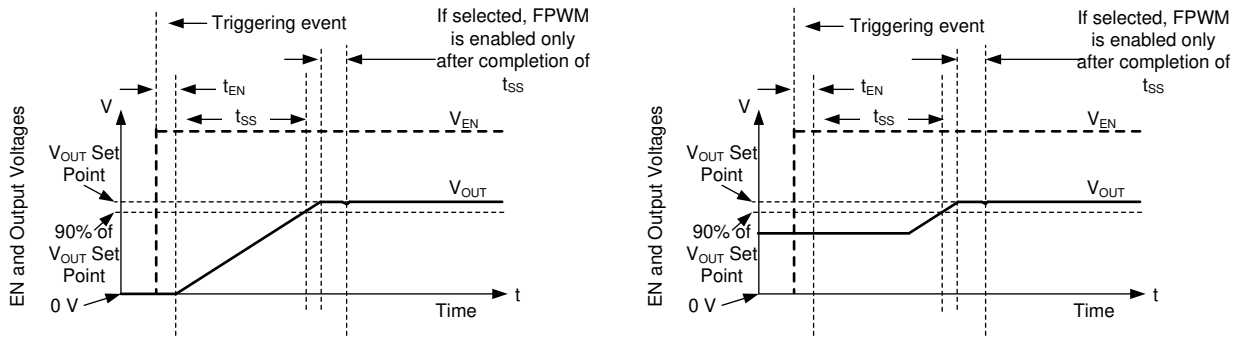
When designing with the LMR36503E-Q1, slow rise in output voltage due to recovery from dropout and soft start must be considered as a two separate operating conditions, as shown in [Figure 7-10](#) and [Figure 7-11](#). Soft start is triggered by any of the following conditions:

- Power is applied to the VIN pin of the device, releasing undervoltage lockout.

- EN is used to turn on the device.
- Recovery from shutdown due to overtemperature protection.

After soft start is triggered, the IC takes the following actions:

- The reference used by the IC to regulate output voltage is slowly ramped up. The net result is that output voltage, if previously 0V, takes  $t_{SS}$  to reach 90% of the desired value.
- Operating mode is set to auto mode of operation, activating the diode emulation mode for the low-side MOSFET. This action allows start-up without pulling the output low. This fact is true even when there is a voltage already present at the output during a prebias start-up.

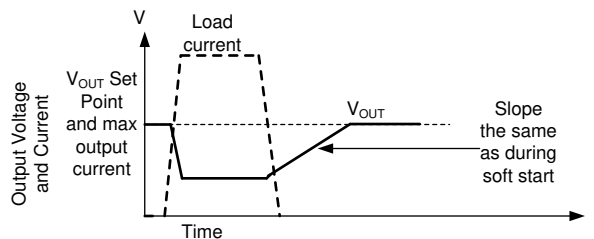


**Figure 7-10. Soft Start With and Without Prebias Voltage**

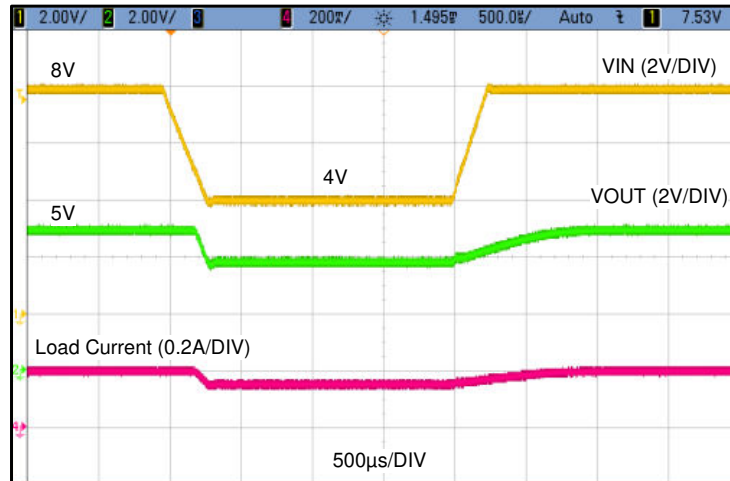
### 7.3.8.1 Recovery from Dropout

Any time the output voltage falls more than a few percent, output voltage ramps up slowly. This condition, called graceful recovery from dropout in this document, differs from soft start in two important ways:

- The reference voltage is set to approximately 1% above what is needed to achieve the existing output voltage.
- If the device is set to FPWM, the device continues to operate in that mode during the recovery from dropout. If output voltage were to suddenly be pulled up by an external supply, the LMR36503E-Q1 can pull down on the output. Note that all protections that are present during normal operation are in place, preventing any catastrophic failure if output is shorted to a high voltage or ground.



**Figure 7-11. Recovery from Dropout**



**Figure 7-12. Typical Output Recovery from Dropout from 8V to 4V**

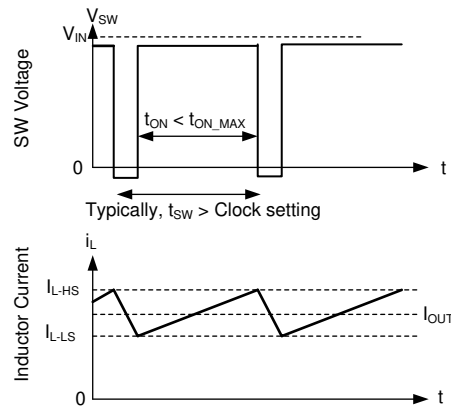
Whether output voltage falls due to high load or low input voltage, after the condition that causes output to fall below the set point is removed, the output climbs at the same speed as during start-up.

### 7.3.9 Current Limit and Short Circuit

The LMR36503E-Q1 is protected from overcurrent conditions by cycle-by-cycle current limiting on both high-side and low-side MOSFETs.

High-side MOSFET overcurrent protection is implemented by the typical peak-current mode control scheme. The HS switch current is sensed when the HS is turned on after a short blanking time. The HS switch current is compared to either the minimum of a fixed current set point or the output of the internal error amplifier loop minus the slope compensation every switching cycle. Because the output of the internal error amplifier loop has a maximum value and slope compensation increases with duty cycle, HS current limit decreases with increased duty factor if duty factor is typically above 35%.

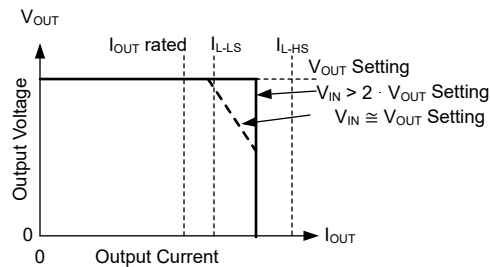
When the LS switch is turned on, the current going through is also sensed and monitored. Like the high-side device, the low-side device has a turn-off commanded by the internal error amplifier loop. In the case of the low-side device, turn-off is prevented if the current exceeds this value, even if the oscillator normally starts a new switching cycle. Also like the high-side device, there is a limit on how high the turn-off current is allowed to be. This limit is called the low-side current limit,  $I_{LS-LIMIT}$  (or  $I_{L-LS}$  in [Figure 7-13](#)). If the LS current limit is exceeded, the LS MOSFET stays on and the HS switch is not to be turned on. The LS switch is turned off after the LS current falls below this limit and the HS switch is turned on again as long as at least one clock period has passed since the last time the HS device has turned on.



**Figure 7-13. Current Limit Waveforms**

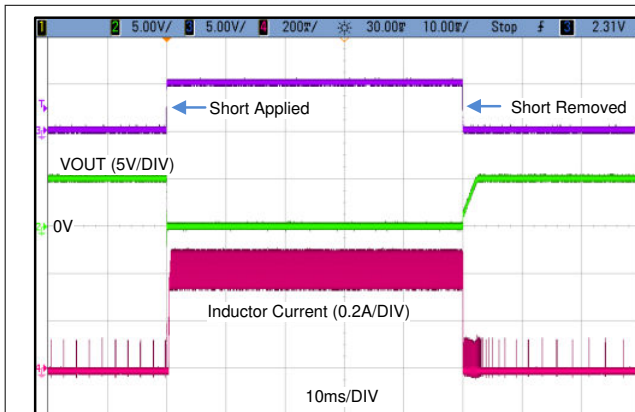
Because the current waveform assumes values between  $I_{SC}$  (or  $I_{L-HS}$  in Figure 7-13) and  $I_{L-LIMIT}$ , the maximum output current is very close to the average of these two values unless duty factor is very high. After operating in current limit, hysteretic control is used and current does not increase as output voltage approaches zero.

If duty factor is very high, current ripple must be very low to prevent instability. Because current ripple is low, the part is able to deliver full current. The current delivered is very close to  $I_{L-LIMIT}$ .

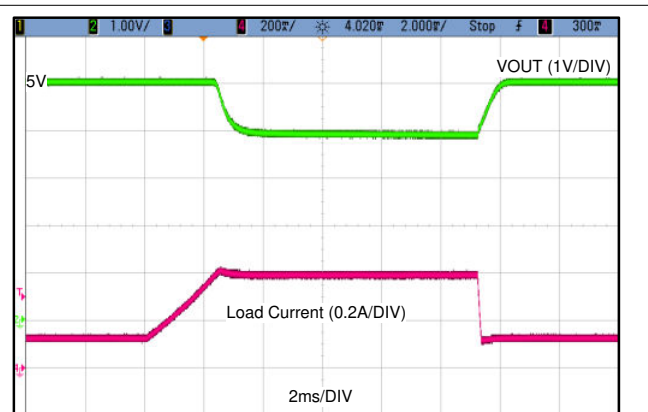


**Figure 7-14. Output Voltage versus Output Current**

Under most conditions, current is limited to the average of  $I_{L-HS}$  and  $I_{L-LS}$ , which is approximately 1.3 times the maximum-rated current. If input voltage is low, current can be limited to approximately  $I_{L-LS}$ . Also note that the maximum output current does not exceed the average of  $I_{L-HS}$  and  $I_{L-LS}$ . After the overload is removed, the part recovers as though in soft start.



**Figure 7-15. Short-Circuit Waveform**



**Figure 7-16. Overload Output Recovery**

### 7.3.10 Thermal Shutdown

Thermal shutdown limits total power dissipation by turning off the internal switches when the device junction temperature exceeds 184°C (typical). Thermal shutdown does not trigger below 176°C (minimum). After thermal shutdown occurs, hysteresis prevents the part from switching until the junction temperature drops to approximately 174°C (typical). When the junction temperature falls below 174°C (typical), the LMR36503E-Q1 attempts another soft start.

While the LMR36503E-Q1 is shut down due to high junction temperature, power continues to be provided to VCC. To prevent overheating due to a short circuit applied to VCC, the LDO that provides power for VCC has reduced current limit while the part is disabled due to high junction temperature. The LDO only provides a few milliamperes during thermal shutdown.

### 7.3.11 Input Supply Current

The LMR36503E-Q1 is designed to have very low input supply current when regulating light loads. This low input supply current is achieved by powering much of the internal circuitry from the output. The VOUT/BIAS pin in the fixed-output voltage variants is the input to the LDO that powers the majority of the control circuits. By connecting the VOUT/BIAS input pin to the output node of the regulator, a small amount of current is drawn from the output. This current is reduced at the input by the ratio of  $V_{OUT} / V_{IN}$ .

$$I_{Q\_VIN} = I_Q + I_{EN} + I_{BIAS} \times \frac{V_{OUT}}{\eta_{eff} \times V_{IN}} \quad (3)$$

where

- $I_{Q\_VIN}$  is the total standby (switching) current consumed by the operating (switching) buck converter when unloaded.
- $I_Q$  is the current drawn from the  $V_{IN}$  terminal. Check  $I_{Q\_13p5\_Fixed}$  or  $I_{Q\_24p0\_Fixed}$  in [Electrical Characteristics](#) for  $I_Q$ .
- $I_{EN}$  is current drawn by the EN terminal. Include this current if EN is connected to VIN. Check  $I_{LKG-EN}$  in [Electrical Characteristics](#) for  $I_{EN}$ .
- $I_{BIAS}$  is bias current drawn by the BIAS input. Check  $I_{B\_13p5}$  or  $I_{B\_24p0}$  in [Electrical Characteristics](#) for  $I_{BIAS}$ .
- $\eta_{eff}$  is the light-load efficiency of the buck converter with  $I_{Q\_VIN}$  removed from the input current of the buck converter.  $\eta_{eff} = 0.8$  is a conservative value that can be used under normal operating conditions. This can be traced back as the  $I_{SUPPLY}$  in [System Characteristics](#).

## 7.4 Device Functional Modes

### 7.4.1 Shutdown Mode

The EN pin provides electrical ON and OFF control of the device. When the EN pin voltage is below 0.4V, both the converter and the internal LDO have no output voltage and the part is in shutdown mode. In shutdown mode, the quiescent current drops to typically 0.5µA.

### 7.4.2 Standby Mode

The internal LDO has a lower EN threshold than the output of the converter. When the EN pin voltage is above 1.1V (maximum) and below the precision enable threshold for the output voltage, the internal LDO regulates the VCC voltage at 3.3V typical. The precision enable circuitry is ON after VCC is above the UVLO. The internal power MOSFETs of the SW node remain off unless the voltage on EN pin goes above the precision enable threshold. The LMR36503E-Q1 also employs UVLO protection. If the VCC voltage is below the UVLO level, the output of the converter is turned off.

### 7.4.3 Active Mode

The LMR36503E-Q1 is in active mode whenever the EN pin is above  $V_{EN-VOUT}$ ,  $V_{IN}$  is high enough to satisfy  $V_{IN\_R}$ , and no other fault conditions are present. The simplest way to enable the operation is to connect the EN pin to  $V_{IN}$ , which allows self start-up when the applied input voltage exceeds the minimum  $V_{IN\_R}$ .

In active mode, depending on the load current, input voltage, and output voltage, the LMR36503E-Q1 is in one of five modes:

- Continuous conduction mode (CCM) with fixed switching frequency when load current is above half of the inductor current ripple
- Auto mode - light load operation: PFM when switching frequency is decreased at very light load
- FPWM mode - light load operation: Discontinuous conduction mode (DCM) when the load current is lower than half of the inductor current ripple
- Minimum on-time: At high input voltage and low output voltages, the switching frequency is reduced to maintain regulation
- Dropout mode: When switching frequency is reduced to minimize voltage dropout

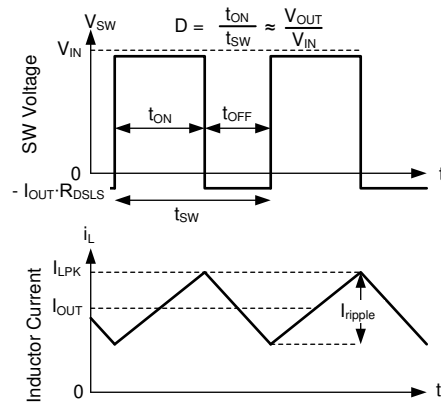
#### 7.4.3.1 CCM Mode

The following operating description of the LMR36503E-Q1 refers to the [Section 7.2](#) and to the waveforms in [Figure 7-17](#). In CCM, the LMR36503E-Q1 supplies a regulated output voltage by turning on the internal high-side (HS) and low-side (LS) switches with varying duty cycle (D). During the HS switch on-time, the SW pin voltage,  $V_{SW}$ , swings up to approximately  $V_{IN}$ , and the inductor current,  $i_L$ , increases with a linear slope. The HS switch is turned off by the control logic. During the HS switch off-time,  $t_{OFF}$ , the LS switch is turned on. Inductor current discharges through the LS switch, which forces the  $V_{SW}$  to swing below ground by the voltage drop across the LS switch. The converter loop adjusts the duty cycle to maintain a constant output voltage. D is defined by the on-time of the HS switch over the switching period:

$$D = T_{ON} / T_{SW} \tag{4}$$

In an ideal buck converter where losses are ignored, D is proportional to the output voltage and inversely proportional to the input voltage:

$$D = V_{OUT} / V_{IN} \tag{5}$$



**Figure 7-17. SW Voltage and Inductor Current Waveforms in Continuous Conduction Mode (CCM)**

#### 7.4.3.2 Auto Mode - Light Load Operation

The LMR36503E-Q1 can have two behaviors while lightly loaded. One behavior, called auto mode operation, allows for seamless transition between normal current mode operation while heavily loaded and highly efficient light load operation. The other behavior, called FPWM Mode, maintains full frequency even when unloaded. Which mode the LMR36503E-Q1 operates in depends on which variant from this family is selected. Note that all parts operate in FPWM mode when synchronizing frequency to an external signal.

The light load operation is employed in the LMR36503E-Q1 only in the auto mode. The light load operation employs two techniques to improve efficiency:

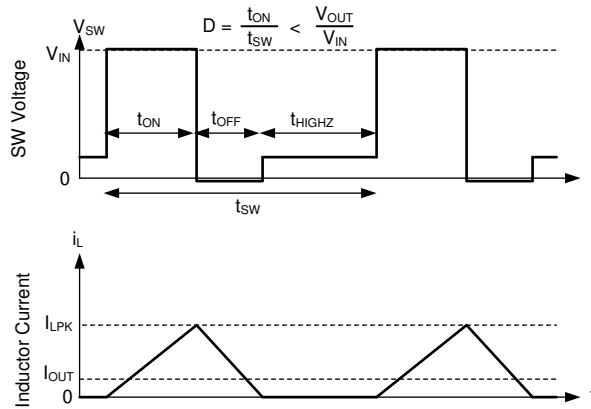
- Diode emulation, which allows DCM operation. See [Figure 7-18](#).
- Frequency reduction. See [Figure 7-19](#).

Note that while these two features operate together to improve light load efficiency, these features operate independent of each other.

##### 7.4.3.2.1 Diode Emulation

Diode emulation prevents reverse current through the inductor which requires a lower frequency needed to regulate given a fixed peak inductor current. Diode emulation also limits ripple current as frequency is reduced. With a fixed peak current, as output current is reduced to zero, frequency must be reduced to near zero to maintain regulation.





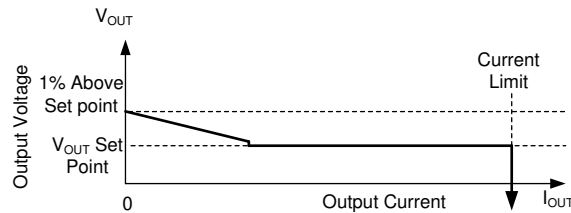
In auto mode, the low-side device is turned off after the SW node current is near zero. As a result, after output current is less than half of what inductor ripple is in CCM, the part operates in DCM which is equivalent to the statement that diode emulation is active.

**Figure 7-18. PFM Operation**

The LMR36503E-Q1 has a minimum peak inductor current setting ( $I_{LPK}$  (see  $I_{PEAK-MIN}$  in [Section 6.5](#)) while in auto mode. After current is reduced to a low value with fixed input voltage, on-time is constant. Regulation is then achieved by adjusting frequency. This mode of operation is called PFM mode regulation.

#### 7.4.3.2.2 Frequency Reduction

The LMR36503E-Q1 reduces frequency whenever output voltage is high. This function is enabled whenever the internal error amplifier compensation output, COMP, an internal signal, is low and there is an offset between the regulation set point of FB and the voltage applied to FB. The net effect is that there is larger output impedance while lightly loaded in auto mode than in normal operation. Output voltage must be approximately 1% high when the part is completely unloaded.



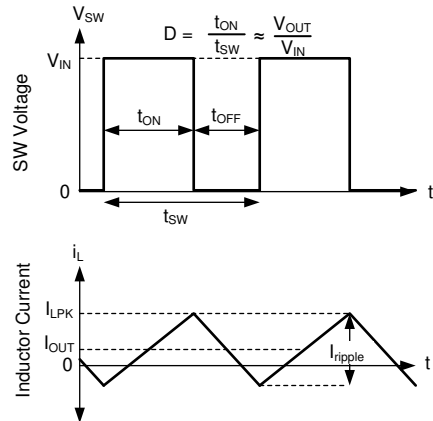
In auto mode, after output current drops below approximately 1/10th the rated current of the part, output resistance increases so that output voltage is 1% high while the buck is completely unloaded.

**Figure 7-19. Steady State Output Voltage versus Output Current in Auto Mode**

In PFM operation, a small DC positive offset is required on the output voltage to activate the PFM detector. The lower the frequency in PFM, the more DC offset is needed on  $V_{OUT}$ . If the DC offset on  $V_{OUT}$  is not acceptable, a dummy load at  $V_{OUT}$  or FPWM Mode can be used to reduce or eliminate this offset.

### 7.4.3.3 FPWM Mode - Light Load Operation

In FPWM Mode, frequency is maintained while lightly loaded. To maintain frequency, a limited reverse current is allowed to flow through the inductor. Reverse current is limited by reverse current limit circuitry, see [Section 6.5](#) for reverse current limit values.



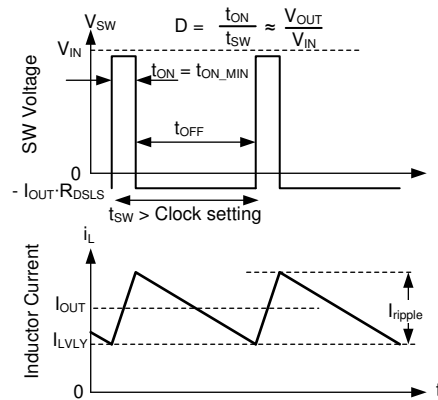
In FPWM mode, Continuous Conduction (CCM) is possible even if  $I_{OUT}$  is less than half of  $I_{ripple}$ .

**Figure 7-20. FPWM Mode Operation**

For all devices, in FPWM mode, frequency reduction is still available if output voltage is high enough to command minimum on-time even while lightly loaded, allowing good behavior during faults which involve output being pulled up.

### 7.4.3.4 Minimum On-Time (High Input Voltage) Operation

The LMR36503E-Q1 continues to regulate output voltage even if the input-to-output voltage ratio requires an on-time less than the minimum on-time of the chip with a given clock setting. This action is accomplished using valley current control. At all times, the compensation circuit dictates both a maximum peak inductor current and a maximum valley inductor current. If for any reason, valley current is exceeded, the clock cycle is extended until valley current falls below that determined by the compensation circuit. If the converter is not operating in current limit, the maximum valley current is set above the peak inductor current, preventing valley control from being used unless there is a failure to regulate using peak current only. If the input-to-output voltage ratio is too high, such that the inductor current peak value exceeds the peak command dictated by compensation, the high-side device cannot be turned off quickly enough to regulate output voltage. As a result, the compensation circuit reduces both peak and valley current. After a low enough current is selected by the compensation circuit, valley current matches that being commanded by the compensation circuit. Under these conditions, the low-side device is kept on and the next clock cycle is prevented from starting until inductor current drops below the desired valley current. Since on-time is fixed at the minimum value, this type of operation resembles that of a device using a Constant On-Time (COT) control scheme; see [Figure 7-21](#).

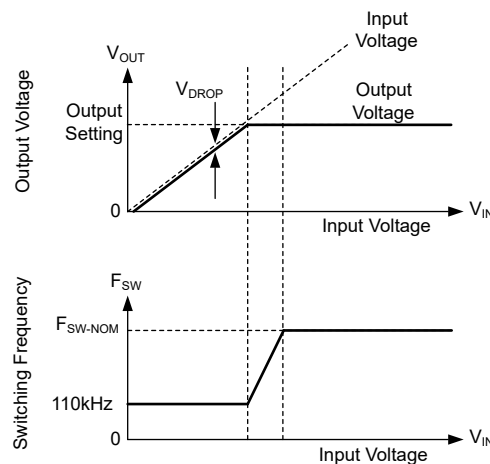


In valley control mode, minimum inductor current is regulated, not peak inductor current.

**Figure 7-21. Valley Current Mode Operation**

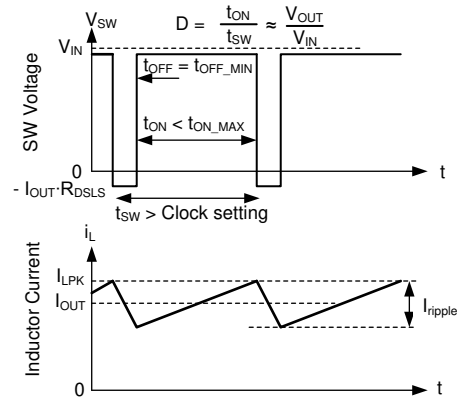
#### 7.4.3.5 Dropout

Dropout operation is defined as any input-to-output voltage ratio that requires frequency to drop to achieve the required duty cycle. At a given clock frequency, duty cycle is limited by minimum off-time. Once this limit is reached as shown in [Figure 7-23](#) if clock frequency was to be maintained, the output voltage can fall. Instead of allowing the output voltage to drop, the LMR36503E-Q1 extends the high side switch on-time past the end of the clock cycle until the needed peak inductor current is achieved. The clock is allowed to start a new cycle once peak inductor current is achieved or once a predetermined maximum on-time,  $t_{ON-MAX}$ , of approximately 9  $\mu s$  passes. As a result, once the needed duty cycle cannot be achieved at the selected clock frequency due to the existence of a minimum off-time, frequency drops to maintain regulation. As shown in [Figure 7-22](#) if input voltage is low enough so that output voltage cannot be regulated even with an on-time of  $t_{ON-MAX}$ , output voltage drops to slightly below the input voltage by  $V_{DROP}$ . For additional information on recovery from dropout, refer back to [Figure 7-11](#).



Output voltage and frequency versus input voltage: if there is little difference between input voltage and output voltage setting, the IC reduces frequency to maintain regulation. If input voltage is too low to provide the desired output voltage at approximately 110kHz, input voltage tracks output voltage.

**Figure 7-22. Frequency and Output Voltage in Dropout**



Switching waveforms while in dropout. Inductor current takes longer than a normal clock to reach the desired peak value. As a result, frequency drops. This frequency drop is limited by  $t_{ON\_MAX}$ .

**Figure 7-23. Dropout Waveforms**

## 8 Application and Implementation

### Note

Information in the following applications sections is not part of the TI component specification, and TI does not warrant its accuracy or completeness. TI's customers are responsible for determining suitability of components for their purposes, as well as validating and testing their design implementation to confirm system functionality.

### 8.1 Application Information

The LMR36503E-Q1 step-down DC-to-DC converter is typically used to convert a higher DC voltage to a lower DC voltage with a maximum output current of 0.3A. The following design procedure can be used to select components for the LMR36503E-Q1.

### Note

All of the capacitance values given in the following application information refer to *effective* values unless otherwise stated. The *effective* value is defined as the actual capacitance under DC bias and temperature, not the rated or nameplate values. Use high-quality, low-ESR, ceramic capacitors with an X7R or better dielectric throughout. All high value ceramic capacitors have a large voltage coefficient in addition to normal tolerances and temperature effects. Under DC bias the capacitance drops considerably. Large case sizes and higher voltage ratings are better in this regard. To help mitigate these effects, multiple capacitors can be used in parallel to bring the minimum *effective* capacitance up to the required value. This action can also ease the RMS current requirements on a single capacitor. A careful study of bias and temperature variation of any capacitor bank must be made to make sure that the minimum value of *effective* capacitance is provided.

#### 8.1.1 High Temperature Specifications

The LMR36503E-Q1 is capable of ultra-high junction temperature operation up to 175°C and meets AEC-Q100 Grade 0 specifications. This device is designed to sustain high temperatures while maintaining performance and reliability. [Table 8-1](#) shows an automotive profile of time and temperature for an LMR36503E-Q1 converter application specified with 12 000 POH at an input voltage of 65V. Power On Hours (POH) for LMR36503E-Q1 is a function of voltage, temperature, and time. Usage at higher voltages and temperatures results in a reduction in POH to achieve the same reliability performance.

**Table 8-1. Power On Hours (POH) Breakdown**

JUNCTION TEMPERATURE	HOURS (TOTAL = 12000 HOURS)
–40°C	6% = 720 Hrs
23°C	20% = 2400 Hrs
100°C	65% = 7800 Hrs
150°C	7% = 840 Hrs
170°C	1% = 120 Hrs
175°C	1% = 120 Hrs

## 8.2 Typical Application

Figure 8-1 shows a typical application circuit for the LMR36503E-Q1. This device is designed to function over a wide range of external components and system parameters. However, the internal compensation is optimized for a certain range of external inductance and output capacitance. As a quick-start guide, Table 8-2 provides typical component values for a range of the most common output voltages.

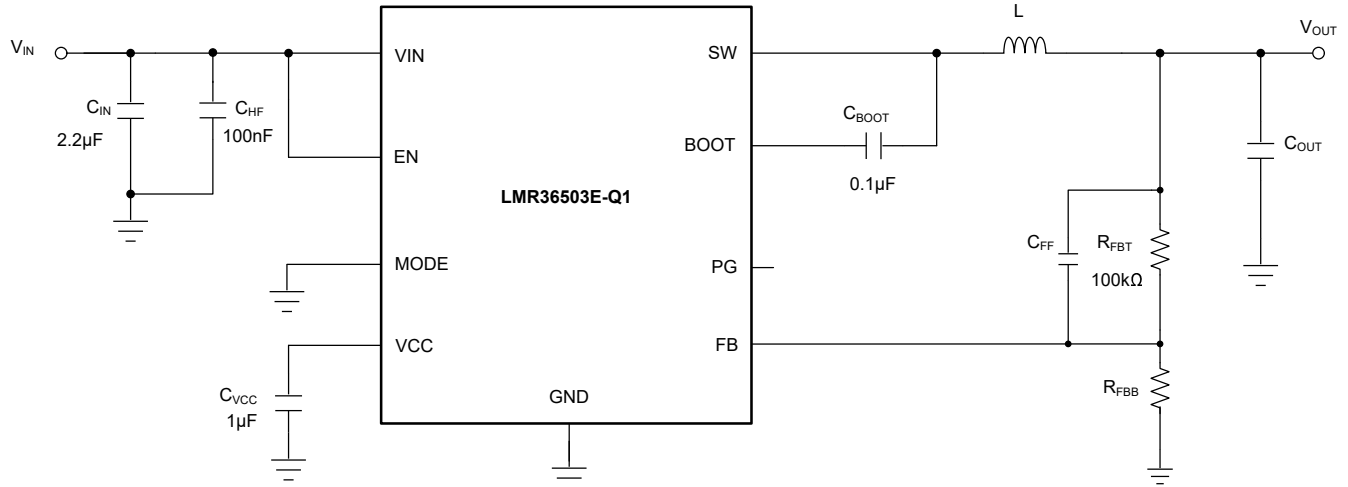


Figure 8-1. Example Application Circuit

Table 8-2. Typical External Component Values <sup>(1)</sup>

$f_{sw}$ (kHz)	$V_{OUT}$ (V)	L (µH)	NOMINAL $C_{OUT}$ (RATED CAPACITANCE)	MINIMUM $C_{OUT}$ (RATED CAPACITANCE)	$R_{FBT}$ (Ω)	$R_{FBB}$ (Ω)	$C_{IN}$	$C_{BOOT}$	$C_{VCC}$
400	3.3	68	1 × 47µF	1 × 22µF	100k	43.2k	2.2µF + 1 × 100nF	100nF	1µF
2200	3.3	10	1 × 10µF	1 × 10µF	100k	43.2k	2.2µF + 1 × 100nF	100nF	1µF
400	5	82	1 × 47µF	1 × 22µF	100k	24.9k	2.2µF + 1 × 100nF	100nF	1µF
2200	5	15	1 × 10µF	1 × 10µF	100k	24.9k	2.2µF + 1 × 100nF	100nF	1µF

(1) Inductor values are calculated based on typical  $V_{IN} = 13.5V$ .

### 8.2.1 Design Requirements

Section 8.2.2 provides a detailed design procedure based on Table 8-3.

Table 8-3. Detailed Design Parameters

DESIGN PARAMETER	EXAMPLE VALUE
Input voltage	13.5V (6V to 60V)
Output voltage	5V
Maximum output current	0A to 0.3A
Switching frequency	2200kHz

### 8.2.2 Detailed Design Procedure

The following design procedure applies to Figure 8-1 and Table 8-2.

#### 8.2.2.1 Custom Design With WEBENCH® Tools

Click [here](#) to create a custom design using the LMR36503E-Q1 device with the WEBENCH Power Designer.

1. Start by entering the input voltage ( $V_{IN}$ ), output voltage ( $V_{OUT}$ ), and output current ( $I_{OUT}$ ) requirements.
2. Optimize the design for key parameters such as efficiency, footprint, and cost using the optimizer dial.
3. Compare the generated design with other possible solutions from Texas Instruments.

The WEBENCH Power Designer provides a customized schematic along with a list of materials with real-time pricing and component availability.

In most cases, these actions are available:

- Run electrical simulations to see important waveforms and circuit performance
- Run thermal simulations to understand board thermal performance
- Export customized schematic and layout into popular CAD formats
- Print PDF reports for the design, and share the design with colleagues

Get more information about WEBENCH tools at [www.ti.com/WEBENCH](http://www.ti.com/WEBENCH).

### 8.2.2.2 Choosing the Switching Frequency

The choice of switching frequency is a compromise between conversion efficiency and overall design size. Lower switching frequency implies reduced switching losses and usually results in higher system efficiency. However, higher switching frequency allows the use of smaller inductors and output capacitors, hence, a more compact design. For this example, 2200kHz is used.

### 8.2.2.3 Setting the Output Voltage

For the fixed output voltage versions, pin 8 (V<sub>OUT</sub>/BIAS) of the device must be connected directly to the output voltage node. This output sensing point is normally located near the top of the output capacitor. If the sensing point is located further away from the output capacitors (that is, remote sensing), then a small 100nF capacitor can be needed at the sensing point.

#### 8.2.2.3.1 FB for Adjustable Output

In an adjustable output voltage version, pin 8 of the device is FB. The output voltage of LMR36503E-Q1 is externally adjustable using an external resistor divider network. The divider network is comprised of R<sub>F<sub>BT</sub></sub> and R<sub>F<sub>BB</sub></sub>, and closes the loop between the output voltage and the converter. The converter regulates the output voltage by holding the voltage on the FB pin equal to the internal reference voltage, V<sub>REF</sub>. The resistance of the divider is a compromise between excessive noise pickup and excessive loading of the output. Smaller values of resistance reduce noise sensitivity but also reduce the light-load efficiency. The recommended value for R<sub>F<sub>BT</sub></sub> is 100kΩ with a maximum value of 1MΩ. After R<sub>F<sub>BT</sub></sub> is selected, Equation 6 is used to select R<sub>F<sub>BB</sub></sub>. V<sub>REF</sub> is nominally 1V. See [Electrical Characteristics](#).

$$R_{FBB} = \frac{R_{FBT}}{\frac{V_{OUT}}{V_{IN}} - 1} \quad (6)$$

For this 5V example, R<sub>F<sub>BT</sub></sub> = 100kΩ and R<sub>F<sub>BB</sub></sub> = 24.9kΩ is chosen.

### 8.2.2.4 Inductor Selection

The parameters for selecting the inductor are the inductance and saturation current. The inductance is based on the desired peak-to-peak ripple current and is normally chosen to be in the range of 20% to 40% of the maximum output current. Experience shows that the best value for inductor ripple current is 30% of the maximum load current. Note that when selecting the ripple current for applications with much smaller maximum load than the maximum available from the device, use the maximum device current. Equation 7 can be used to determine the value of inductance. The constant K is the percentage of inductor current ripple. For this example, choose K = 0.4 and find an inductance of L = 11.9μH. Select the next standard value of L = 15μH.

$$L = \frac{V_{IN} - V_{OUT}}{f_{SW} \times K \times I_{OUTmax}} \times \frac{V_{OUT}}{V_{IN}} \quad (7)$$

Ideally, the saturation current rating of the inductor is at least as large as the high-side switch current limit, I<sub>SC</sub> (see [Electrical Characteristics](#)). This rating make sure that the inductor does not saturate, even during a short circuit on the output. When the inductor core material saturates, the inductance falls to a very low value, causing the inductor current to rise very rapidly. Although the valley current limit, I<sub>LIMIT</sub>, is designed to reduce the risk

of current runaway, a saturated inductor can cause the current to rise to high values very rapidly. This can lead to component damage. Do not allow the inductor to saturate. Inductors with a ferrite core material have very *hard* saturation characteristics, but usually have lower core losses than powdered iron cores. Powered iron cores exhibit a *soft* saturation, allowing some relaxation in the current rating of the inductor. However, Powered iron cores have more core losses at frequencies above about 1MHz. In any case, the inductor saturation current must not be less than the maximum peak inductor current at full load.

To avoid subharmonic oscillation, the inductance value must not be less than that given in

$$L_{MIN} \geq 2.5 \times \frac{V_{OUT}}{f_{SW}} \quad (8)$$

The maximum inductance is limited by the minimum current ripple for the current mode control to perform correctly. As a general rule, the minimum inductor ripple current must be no less than about 10% of the device maximum rated current under nominal conditions.

#### 8.2.2.5 Output Capacitor Selection

The current mode control scheme of the LMR36503E-Q1 devices allows operation over a wide range of output capacitance. The output capacitor bank is usually limited by the load transient requirements and stability rather than the output voltage ripple. Please refer to [Section 8.2](#) for typical output capacitor value for 3.3V and 5V output voltages. Based on this table, for a 5V output design, you can choose the recommended  $1 \times 10\mu\text{F}$  ceramic output capacitor for this example. For other designs with other output voltages, WEBENCH can be used as a starting point for selecting the value of output capacitor.

In practice, the output capacitor has the most influence on the transient response and loop-phase margin. Load transient testing and bode plots are the best way to validate any given design and must always be completed before the application goes into production. In addition to the required output capacitance, a small ceramic placed on the output can help reduce high-frequency noise. Small-case size ceramic capacitors in the range of 1nF to 100nF can be very helpful in reducing spikes on the output caused by inductor and board parasitics.

Limit the maximum value of total output capacitance to about 10 times the design value, or 1000 $\mu\text{F}$ , whichever is smaller. Large values of output capacitance can adversely affect the start-up behavior of the regulator as well as the loop stability. If values larger than noted here must be used, then a careful study of start-up at full load and loop stability must be performed.

#### 8.2.2.6 Input Capacitor Selection

The ceramic input capacitors provide a low impedance source to the regulator in addition to supplying the ripple current and isolating switching noise from other circuits. A minimum ceramic capacitance of 2.2 $\mu\text{F}$  is required on the input of the LMR36503E-Q1. This ceramic capacitance must be rated for at least the maximum input voltage that the application requires, preferably twice the maximum input voltage. This capacitance can be increased to help reduce input voltage ripple and maintain the input voltage during load transients. In addition, a small case size 100nF ceramic capacitor must be used at the input, as close a possible to the regulator. This action provides a high frequency bypass for the control circuits internal to the device. For this example a 2.2 $\mu\text{F}$ , 100V, X7R (or better) ceramic capacitor is chosen. The 100nF must also be rated at 100V with an X7R dielectric.

Using an electrolytic capacitor on the input in parallel with the ceramics is often desirable. This statement is especially true if long leads or traces are used to connect the input supply to the regulator. The moderate ESR of this capacitor can help damp any ringing on the input supply caused by the long power leads. The use of this additional capacitor also helps with voltage dips caused by input supplies with unusually high impedance.

Most of the input switching current passes through the ceramic input capacitor or capacitors. The approximate RMS value of this current can be calculated from [Equation 9](#) and must be checked against the manufacturers maximum ratings.

$$I_{RMS} \cong \frac{I_{OUT}}{2} \quad (9)$$



### 8.2.2.7 C<sub>BOOT</sub>

The LMR36503E-Q1 requires a bootstrap capacitor connected between the BOOT pin and the SW pin. This capacitor stores energy that is used to supply the gate drivers for the power MOSFETs. A high-quality ceramic capacitor of 100nF and at least 16V is required.

### 8.2.2.8 VCC

The VCC pin is the output of the internal LDO used to supply the control circuits of the regulator. This output requires a 1μF, 16V ceramic capacitor connected from VCC to GND for proper operation. In general, this output must not be loaded with any external circuitry. However, this output can be used to supply the pullup for the power-good function (see [Section 7.3.4](#)). A value in the range of 10kΩ to 100kΩ is a good choice in this case. The nominal output voltage on VCC is 3.2V; see [Section 6.5](#) for limits.

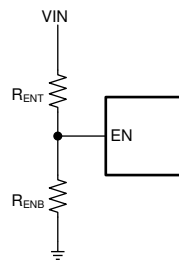
### 8.2.2.9 C<sub>FF</sub> Selection

In some cases, a feedforward capacitor can be used across R<sub>FBT</sub> to improve the load transient response or improve the loop-phase margin. This statement is especially true when values of R<sub>FBT</sub> > 100kΩ are used. Large values of R<sub>FBT</sub>, in combination with the parasitic capacitance at the FB pin, can create a small signal pole that interferes with the loop stability. A C<sub>FF</sub> can help mitigate this effect. Use [Equation 10](#) to estimate the value of C<sub>FF</sub>. The value found with [Equation 10](#) is a starting point; use lower values to determine if any advantage is gained by the use of a C<sub>FF</sub> capacitor. The [Optimizing Transient Response of Internally Compensated DC-DC Converters with Feedforward Capacitor application report](#) is helpful when experimenting with a feedforward capacitor.

$$C_{FF} < \frac{V_{OUT} \times C_{OUT}}{120 \times R_{FBT} \times \sqrt{\frac{V_{REF}}{V_{OUT}}}} \quad (10)$$

#### 8.2.2.9.1 External UVLO

In some cases, an input UVLO level different than that provided internal to the device is needed. This need can be accomplished by using the circuit shown in [Figure 8-2](#). The input voltage at which the device turns on is designated as V<sub>ON</sub> while the turnoff voltage is V<sub>OFF</sub>. First, a value for R<sub>ENB</sub> is chosen in the range of 10kΩ to 100kΩ, then [Equation 11](#) and [Equation 12](#) are used to calculate R<sub>ENT</sub> and V<sub>OFF</sub> respectively.



**Figure 8-2. Setup for External UVLO Application**

$$R_{ENT} = \left( \frac{V_{ON}}{V_{EN} - HYS} - 1 \right) \times R_{ENB} \quad (11)$$

$$V_{OFF} = V_{ON} \left( 1 - \frac{V_{EN} - HYS}{V_{EN}} \right) \quad (12)$$

where

- V<sub>ON</sub> is the V<sub>IN</sub> turn-on voltage.
- V<sub>OFF</sub> is the V<sub>IN</sub> turn-off voltage.

### 8.2.2.10 Maximum Ambient Temperature

As with any power conversion device, the LMR36503E-Q1 dissipates internal power while operating. The effect of this power dissipation is to raise the internal temperature of the converter above ambient. The internal die temperature ( $T_J$ ) is a function of the ambient temperature, the power loss, and the effective thermal resistance,  $R_{\theta JA}$ , of the device and PCB combination. The maximum junction temperature for the LMR36503E-Q1 must be limited to 175°C. This limit establishes a limit on the maximum device power dissipation and, therefore, the load current. Equation 13 shows the relationships between the important parameters. Seeing that larger ambient temperatures ( $T_A$ ) and larger values of  $R_{\theta JA}$  reduce the maximum available output current is easy. The converter efficiency can be estimated by using the curves provided in this data sheet. If the desired operating conditions cannot be found in one of the curves, interpolation can be used to estimate the efficiency. Alternatively, the EVM can be adjusted to match the desired application requirements and the efficiency can be measured directly. The correct value of  $R_{\theta JA}$  is more difficult to estimate. As stated in the [Semiconductor and IC Package Thermal Metrics application report](#), the values given in Section 6.4 are not valid for design purposes and must not be used to estimate the thermal performance of the application. The values reported in that table were measured under a specific set of conditions that are rarely obtained in an actual application.

$$I_{OUTmax} = \frac{(T_J - T_A)}{R_{\theta JA}} \times \frac{\eta}{(1 - \eta)} \times \frac{1}{V_{OUT}} \quad (13)$$

where

- $\eta$  = efficiency

The effective  $R_{\theta JA}$  is a critical parameter and depends on many factors such as the following:

- Power dissipation
- Air temperature, flow
- PCB area
- Copper heat-sink area
- Number of thermal vias under the package
- Adjacent component placement

A typical example of  $R_{\theta JA}$  versus copper board area can be found in Figure 8-3. The copper area given in the graph is for each layer. For a 4-layer PCB design, the top and bottom layers are 2oz. copper each, while the inner layers are 1 oz. For a 2-layer PCB design, the top and bottom layers are 2oz. copper each. Note that the data given in these graphs are for illustration purposes only, and the actual performance in any given application depends on all of the factors mentioned above.

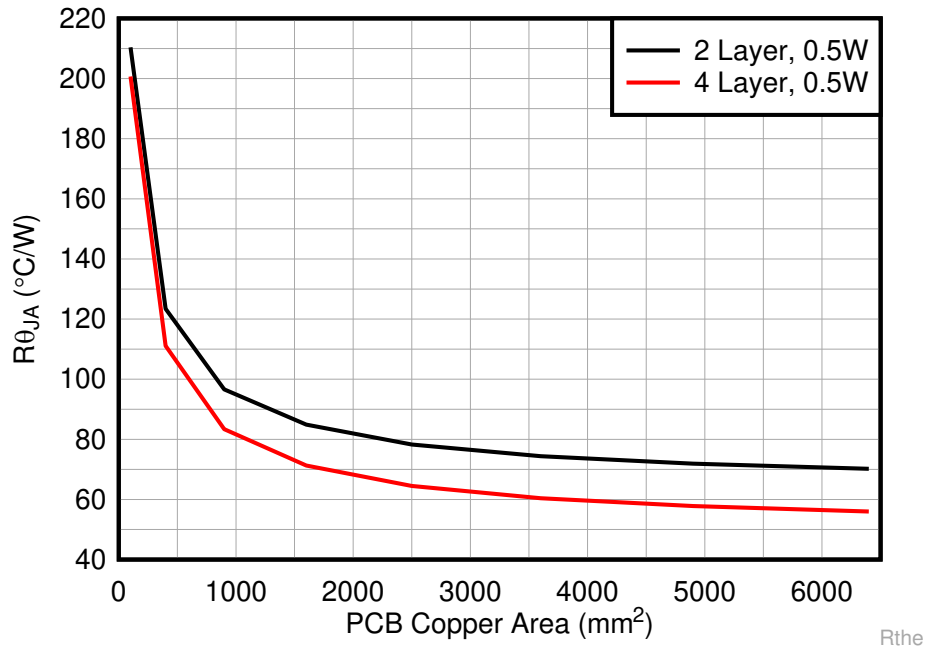
Using the value of  $R_{\theta JA}$  from Figure 8-3 for a given PCB copper area and  $\Psi_{JT}$  from Section 6.4, one can approximate the junction temperature of the IC for a given operating condition using Equation 14

$$T_J \approx T_A + R_{\theta JA} \times \text{IC Power Loss} \quad (14)$$

where

- $T_J$  = IC Junction Temperature (°C)
- $T_A$  = Ambient Temperature (°C)
- $R_{\theta JA}$  = Thermal Resistance (°C/W)
- IC Power Loss = Power loss for the IC (W)

The IC Power loss mentioned above is the overall power loss minus the loss that comes from the inductor DC Resistance. The overall power loss can be approximated from the efficiency curves in the Section 8.2.3 or by using WEBENCH for a specific operating condition and temperature.



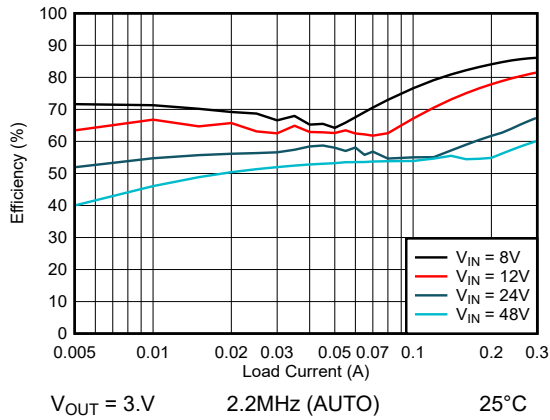
**Figure 8-3. R<sub>θJA</sub> versus PCB Copper Area for the VQFN (RPE) Package**

Use the following resources as guides to optimal thermal PCB design and estimating R<sub>θJA</sub> for a given application environment:

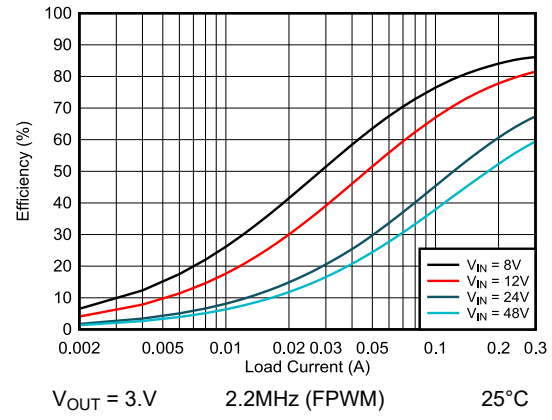
- [Thermal Design by Insight not Hindsight application report](#)
- [A Guide to Board Layout for Best Thermal Resistance for Exposed Pad Packages application report](#)
- [Semiconductor and IC Package Thermal Metrics application report](#)
- [Thermal Design Made Simple with LM43603 and LM43602 application report](#)
- [PowerPAD™ Thermally Enhanced Package application report](#)
- [PowerPAD™ Made Easy application report](#)
- [Using New Thermal Metrics application report](#)
- [PCB Thermal Calculator](#)

### 8.2.3 Application Curves

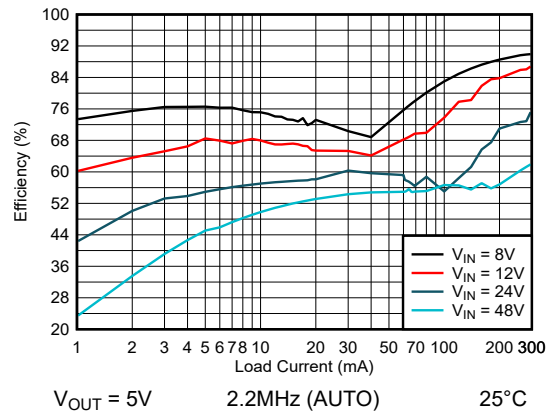
Unless otherwise specified the following conditions apply:  $V_{IN} = 12.0V$ ,  $T_A = 25^\circ C$ . Figure 8-25 shows the circuit with the appropriate BOM in Table 8-4



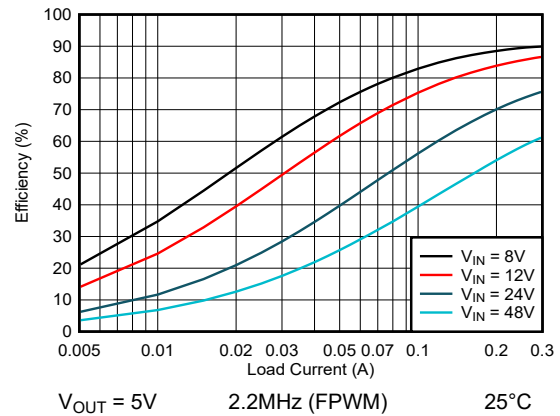
**Figure 8-4. Efficiency**



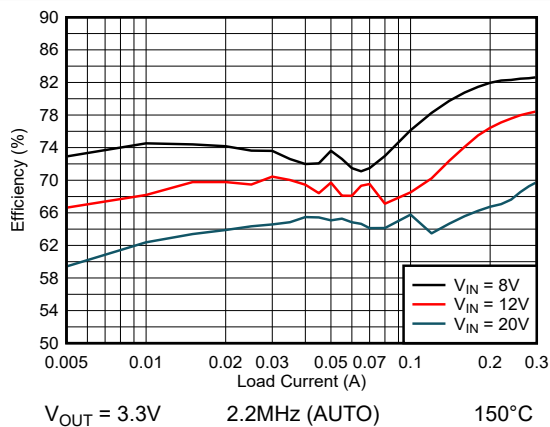
**Figure 8-5. Efficiency**



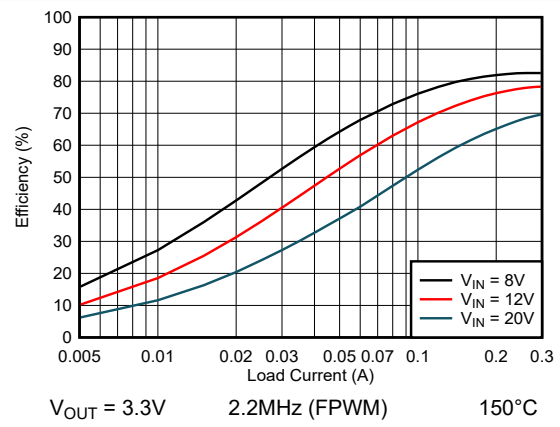
**Figure 8-6. Efficiency**



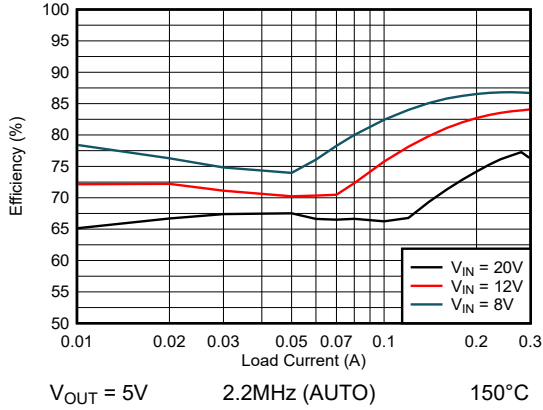
**Figure 8-7. Efficiency**



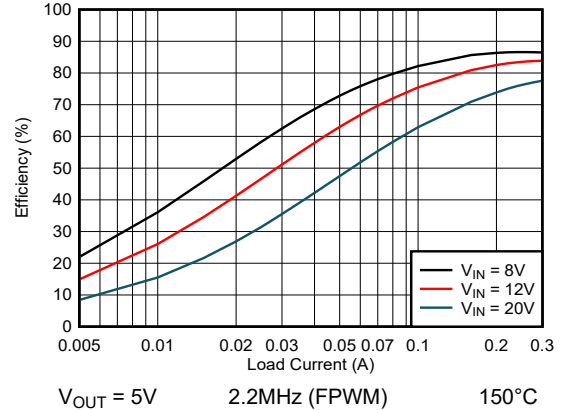
**Figure 8-8. Efficiency**



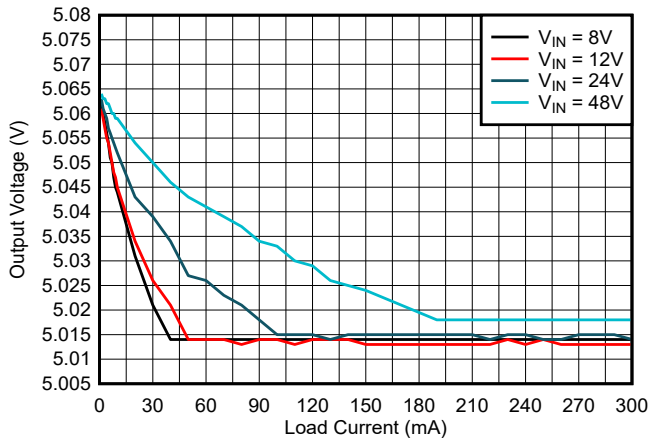
**Figure 8-9. Efficiency**



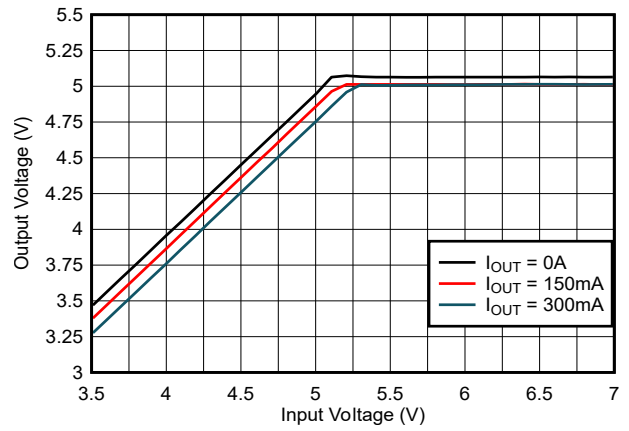
**Figure 8-10. Efficiency**



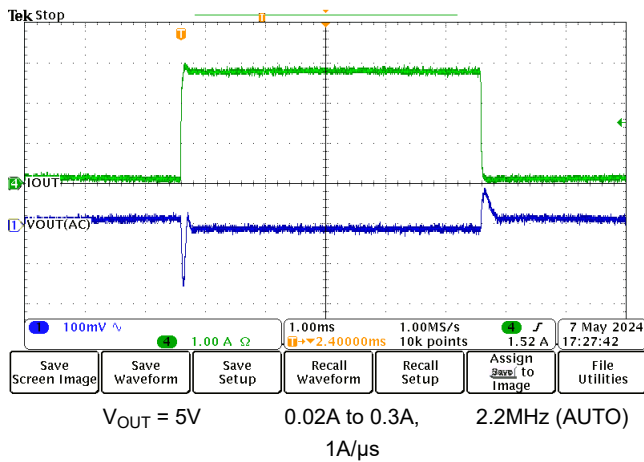
**Figure 8-11. Efficiency**



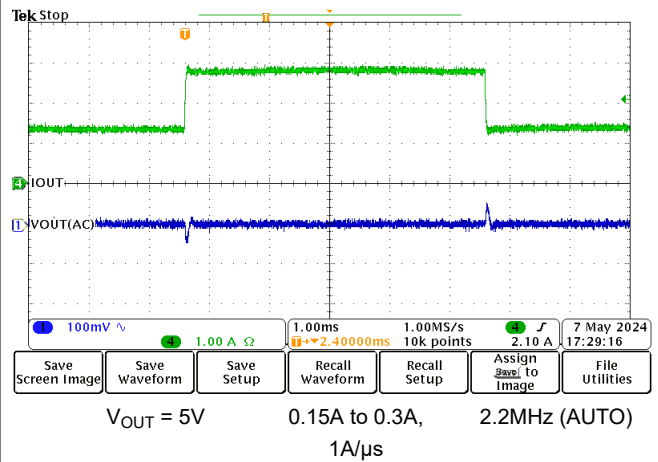
**Figure 8-12. Line and Load Regulation**



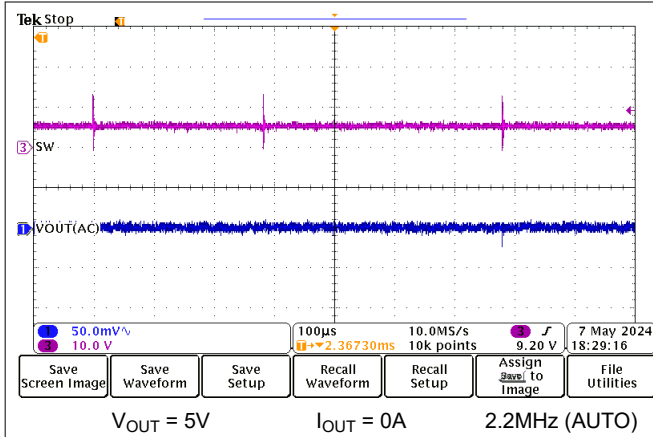
**Figure 8-13. Dropout**



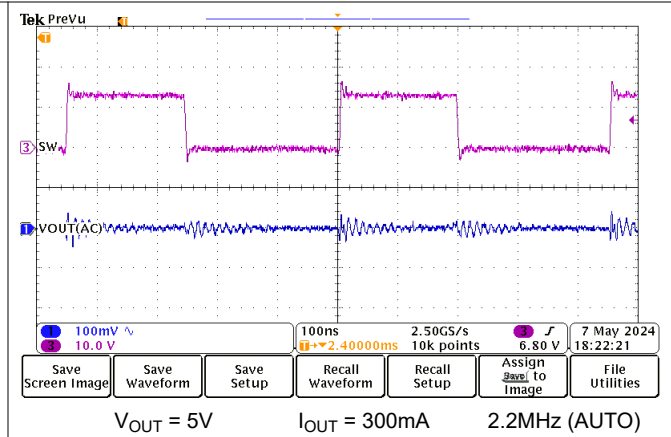
**Figure 8-14. Load Transient**



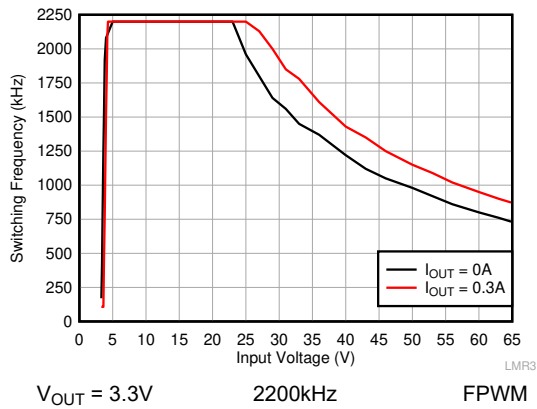
**Figure 8-15. Load Transient**



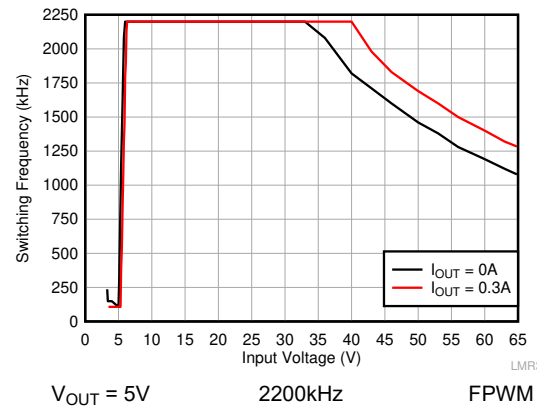
**Figure 8-16. Output Ripple**



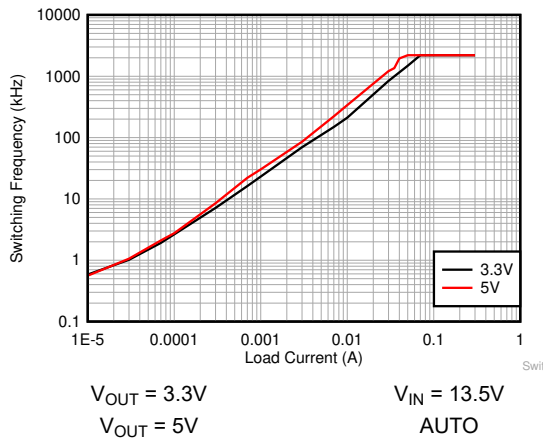
**Figure 8-17. Output Ripple**



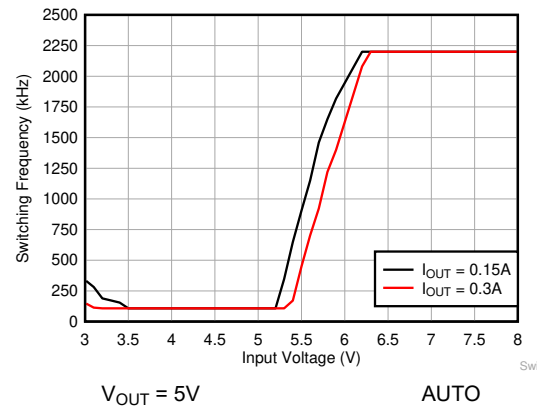
**Figure 8-18. Switching Frequency over Input Voltage**



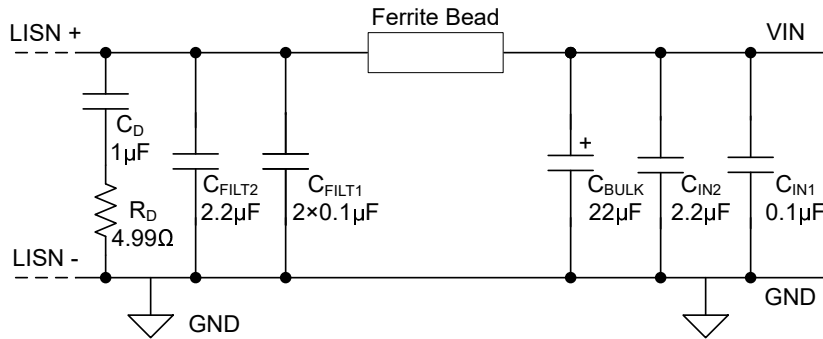
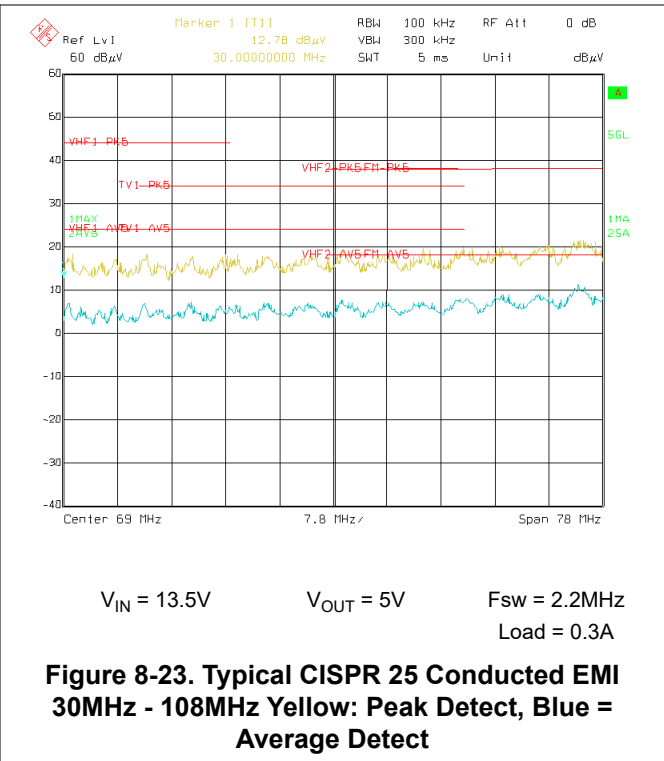
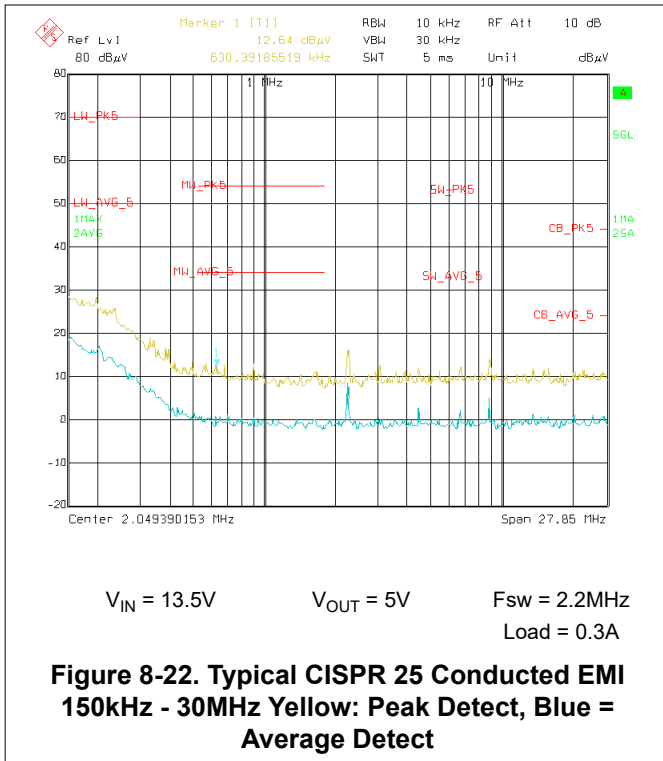
**Figure 8-19. Switching Frequency over Input Voltage**



**Figure 8-20. Switching Frequency Over Load Current**

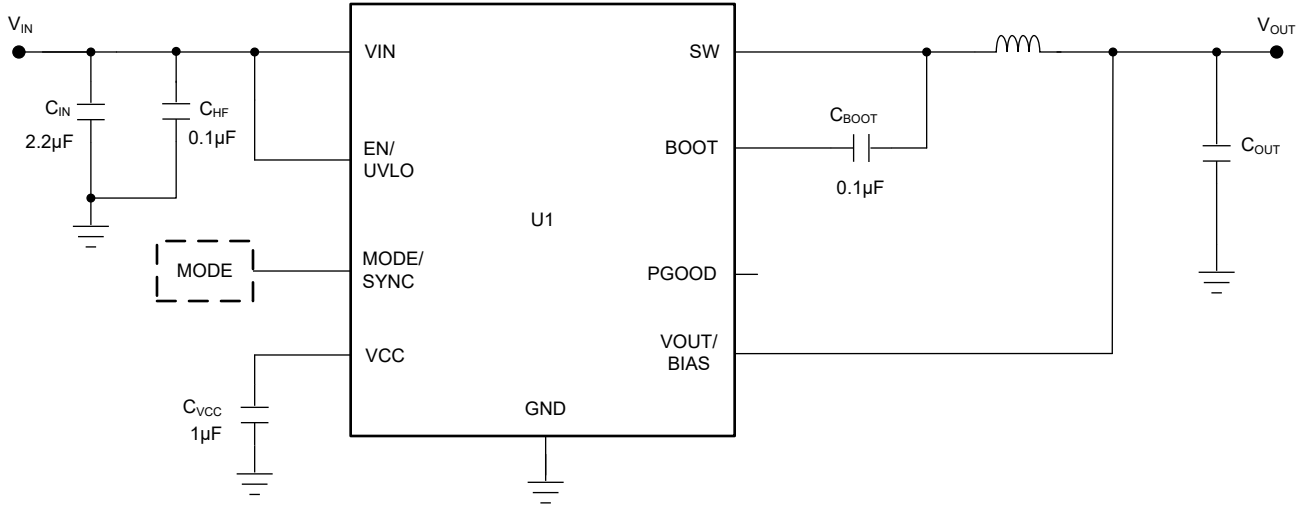


**Figure 8-21. Switching Frequency During Dropout**



Ferrite bead part number:  
FBMH3225HM601NT

Figure 8-24. Typical Input EMI Filter for 2.2MHz



**Figure 8-25. Schematic for Typical Application Curves**

**Table 8-4. BOM for Typical Application Curves**

U1	$f_{sw}$	$V_{OUT}$	L	NOMINAL $C_{OUT}$ (RATED CAPACITANCE)
LMR36503MSCERPERQ1	2200kHz	3.3V	6.8µH, 47.9mΩ	2 × 22µF
LMR36503MSCERPERQ1	2200kHz	5V	6.8µH, 47.9mΩ	2 × 22µF



## 8.3 Best Design Practices

- Do not exceed the [Absolute Maximum Ratings](#).
- Do not exceed the [Recommended Operating Conditions](#).
- Do not exceed the [ESD \(Automotive\) Ratings](#).
- Do not allow the EN input to float.
- Do not allow the output voltage to exceed the input voltage, nor go below ground.
- Follow all the guidelines and suggestions found in this data sheet before committing the design to production. TI application engineers are ready to help critique your design and PCB layout to help make your project a success.

## 8.4 Power Supply Recommendations

The characteristics of the input supply must be compatible with [Specifications](#) found in this data sheet. In addition, the input supply must be capable of delivering the required input current to the loaded regulator. Estimate the average input current with [Equation 15](#).

$$I_{IN} = \frac{V_{OUT} \times I_{OUT}}{V_{IN} \times \eta} \quad (15)$$

where

- $\eta$  is the efficiency

If the regulator is connected to the input supply through long wires or PCB traces, special care is required to achieve good performance. The parasitic inductance and resistance of the input cables can have an adverse effect on the operation of the regulator. The parasitic inductance, in combination with the low-ESR, ceramic input capacitors, can form an underdamped resonant circuit, resulting in overvoltage transients at the input to the regulator. The parasitic resistance can cause the voltage at the VIN pin to dip whenever a load transient is applied to the output. If the application is operating close to the minimum input voltage, this dip can cause the regulator to momentarily shut down and reset. The best way to solve these kind of issues is to limit the distance from the input supply to the regulator or plan to use an aluminum or tantalum input capacitor in parallel with the ceramics. The moderate ESR of these types of capacitors help dampen the input resonant circuit and reduce any overshoots. A value in the range of 20  $\mu$ F to 100  $\mu$ F is usually sufficient to provide input damping and help to hold the input voltage steady during large load transients.

Sometimes, for other system considerations, an input filter is used in front of the regulator. This action can lead to instability, as well as some of the effects mentioned above, unless designed carefully. The [AN-2162 Simple Success With Conducted EMI From DC/DC Converters user's guide](#) provides helpful suggestions when designing an input filter for any switching regulator.

In some cases, a transient voltage suppressor (TVS) is used on the input of regulators. One class of this device has a *snap-back* characteristic (thyristor type). TI does not recommend the use of a device with this type of characteristic. When the TVS fires, the clamping voltage falls to a very low value. If this voltage is less than the output voltage of the regulator, the output capacitors discharge through the device back to the input. This uncontrolled current flow can damage the device.

## 8.5 Layout

### 8.5.1 Layout Guidelines

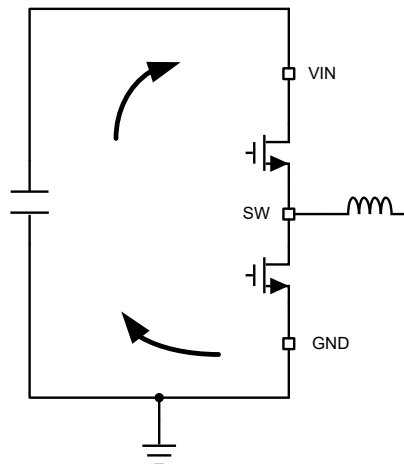
The PCB layout of any DC/DC converter is critical to the optimal performance of the design. Poor PCB layout can disrupt the operation of an otherwise good schematic design. Even if the converter regulates correctly, bad PCB layout can mean the difference between a robust design and one that cannot be mass produced. Furthermore, to a great extent, the EMI performance of the regulator is dependent on the PCB layout. In a buck converter, the most critical PCB feature is the loop formed by the input capacitor or capacitors and power ground, as shown in [Figure 8-26](#). This loop carries large transient currents that can cause large transient voltages when reacting with the trace inductance. These unwanted transient voltages disrupt the proper operation of the converter. Because of this, the traces in this loop must be wide and short, and the loop area as

small as possible to reduce the parasitic inductance. [Figure 8-27](#) shows a recommended layout for the critical components of the LMR36503E-Q1.

1. *Place the input capacitors as close as possible to the VIN and GND terminals.*
2. *Place bypass capacitor for VCC close to the VCC pin.* This capacitor must be placed close to the device and routed with short, wide traces to the VCC and GND pins.
3. *Use wide traces for the C<sub>BOOT</sub> capacitor.* Place C<sub>BOOT</sub> close to the device with short, wide traces to the BOOT and SW pins. Route the SW pin to the N/C pin and used to connect the BOOT capacitor to SW.
4. *Place the feedback divider as close as possible to the FB pin of the device.* Place R<sub>FBB</sub>, R<sub>FBT</sub>, and C<sub>FF</sub>, if used, physically close to the device. The connections to FB and GND must be short and close to those pins on the device. The connection to V<sub>OUT</sub> can be somewhat longer. However, the latter trace must not be routed near any noise source (such as the SW node) that can capacitively couple into the feedback path of the regulator.
5. *Use at least one ground plane in one of the middle layers.* This plane acts as a noise shield and as a heat dissipation path.
6. *Provide wide paths for VIN, VOUT, and GND.* Making these paths as wide and direct as possible reduces any voltage drops on the input or output paths of the converter and maximizes efficiency.
7. *Provide enough PCB area for proper heat-sinking.* As stated in [Section 8.2.2.10](#), enough copper area must be used to make sure of a low R<sub>θJA</sub>, commensurate with the maximum load current and ambient temperature. The top and bottom PCB layers must be made with two ounce copper and no less than one ounce. If the PCB design uses multiple copper layers (recommended), these thermal vias can also be connected to the inner layer heat-spreading ground planes.
8. *Keep switch area small.* Keep the copper area connecting the SW pin to the inductor as short and wide as possible. At the same time, the total area of this node must be minimized to help reduce radiated EMI.

See the following PCB layout resources for additional important guidelines:

- [Layout Guidelines for Switching Power Supplies application report](#)
- [Simple Switcher PCB Layout Guidelines application report](#)
- [Construction Your Power Supply- Layout Considerations seminar](#)
- [Low Radiated EMI Layout Made Simple with LM4360x and LM4600x application report](#)



**Figure 8-26. Current Loops With Fast Edges**

### 8.5.1.1 Ground and Thermal Considerations

As previously mentioned, TI recommends using one of the middle layers as a solid ground plane. A ground plane provides shielding for sensitive circuits and traces as well as a quiet reference potential for the control circuitry. Connect the GND pin to the ground planes using vias next to the bypass capacitors. The GND trace, as well as the VIN and SW traces, must be constrained to one side of the ground planes. The other side of the ground plane contains much less noise; use for sensitive routes.

TI recommends providing adequate device heat-sinking by having enough copper near the GND pin. See [Figure 8-27](#) for example layout. Use as much copper as possible, for system ground plane, on the top and bottom layers for the best heat dissipation. Use a four-layer board with the copper thickness for the four layers, starting from the top as: 2 oz / 1 oz / 1 oz / 2 oz. A four-layer board with enough copper thickness, and proper layout, provides low current conduction impedance, proper shielding and lower thermal resistance.

### 8.5.2 Layout Example

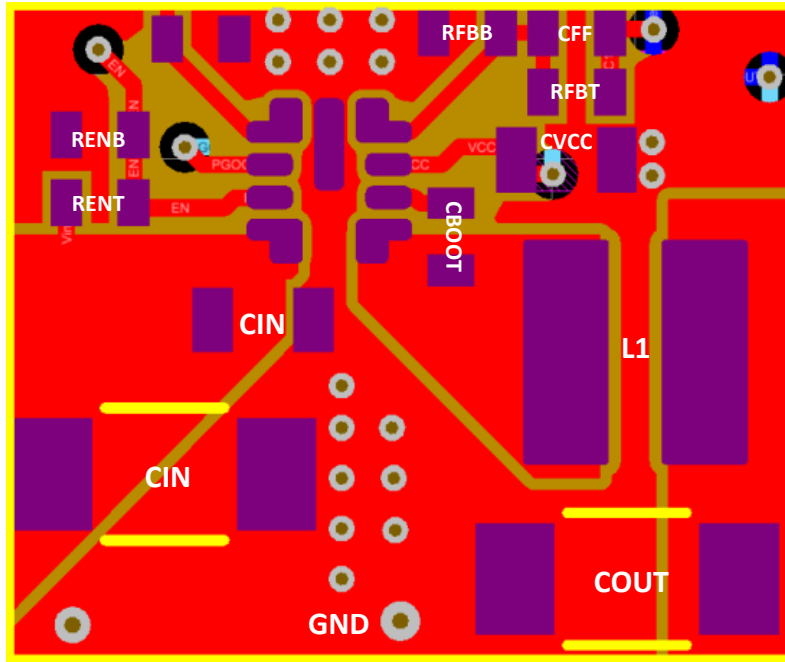


Figure 8-27. Example Layout

## 9 Device and Documentation Support

### 9.1 Device Support

#### 9.1.1 Third-Party Products Disclaimer

TI'S PUBLICATION OF INFORMATION REGARDING THIRD-PARTY PRODUCTS OR SERVICES DOES NOT CONSTITUTE AN ENDORSEMENT REGARDING THE SUITABILITY OF SUCH PRODUCTS OR SERVICES OR A WARRANTY, REPRESENTATION OR ENDORSEMENT OF SUCH PRODUCTS OR SERVICES, EITHER ALONE OR IN COMBINATION WITH ANY TI PRODUCT OR SERVICE.

#### 9.1.2 Development Support

##### 9.1.2.1 Custom Design With WEBENCH® Tools

[Click here](#) to create a custom design using the LMR36503E-Q1 device with the WEBENCH Power Designer.

1. Start by entering the input voltage ( $V_{IN}$ ), output voltage ( $V_{OUT}$ ), and output current ( $I_{OUT}$ ) requirements.
2. Optimize the design for key parameters such as efficiency, footprint, and cost using the optimizer dial.
3. Compare the generated design with other possible solutions from Texas Instruments.

The WEBENCH Power Designer provides a customized schematic along with a list of materials with real-time pricing and component availability.

In most cases, these actions are available:

- Run electrical simulations to see important waveforms and circuit performance
- Run thermal simulations to understand board thermal performance
- Export customized schematic and layout into popular CAD formats
- Print PDF reports for the design, and share the design with colleagues

Get more information about WEBENCH tools at [www.ti.com/WEBENCH](http://www.ti.com/WEBENCH).

### 9.2 Documentation Support

#### 9.2.1 Related Documentation

For related documentation see the following:

- Texas Instruments, [Thermal Design by Insight not Hindsight application report](#)
- Texas Instruments, [A Guide to Board Layout for Best Thermal Resistance for Exposed Pad Packages application report](#)
- Texas Instruments, [Semiconductor and IC Package Thermal Metrics application note](#)
- Texas Instruments, [Thermal Design Made Simple with LM43603 and LM43602 application report](#)
- Texas Instruments, [PowerPAD™ Thermally Enhanced Package application report](#)
- Texas Instruments, [PowerPAD™ Made Easy application report](#)
- Texas Instruments, [Using New Thermal Metrics application report](#)
- Texas Instruments, [Layout Guidelines for Switching Power Supplies application report](#)
- Texas Instruments, [Simple Switcher PCB Layout Guidelines application report](#)
- Texas Instruments, [Construction Your Power Supply- Layout Considerations seminar](#)
- Texas Instruments, [Low Radiated EMI Layout Made Simple with LM4360x and LM4600x application report](#)
- [AN-2162 Simple Success With Conducted EMI From DC/DC Converters user's guide](#)

### 9.3 Receiving Notification of Documentation Updates

To receive notification of documentation updates, navigate to the device product folder on [ti.com](http://ti.com). Click on *Notifications* to register and receive a weekly digest of any product information that has changed. For change details, review the revision history included in any revised document.

### 9.4 Support Resources

TI E2E™ [support forums](#) are an engineer's go-to source for fast, verified answers and design help — straight from the experts. Search existing answers or ask your own question to get the quick design help you need.

Linked content is provided "AS IS" by the respective contributors. They do not constitute TI specifications and do not necessarily reflect TI's views; see TI's [Terms of Use](#).

**9.5 Trademarks**

HotRod™, PowerPAD™, and TI E2E™ are trademarks of Texas Instruments.  
WEBENCH® is a registered trademark of Texas Instruments.  
All trademarks are the property of their respective owners.

**9.6 Electrostatic Discharge Caution**



This integrated circuit can be damaged by ESD. Texas Instruments recommends that all integrated circuits be handled with appropriate precautions. Failure to observe proper handling and installation procedures can cause damage.

ESD damage can range from subtle performance degradation to complete device failure. Precision integrated circuits may be more susceptible to damage because very small parametric changes could cause the device not to meet its published specifications.

**9.7 Glossary**

[TI Glossary](#) This glossary lists and explains terms, acronyms, and definitions.

**10 Revision History**

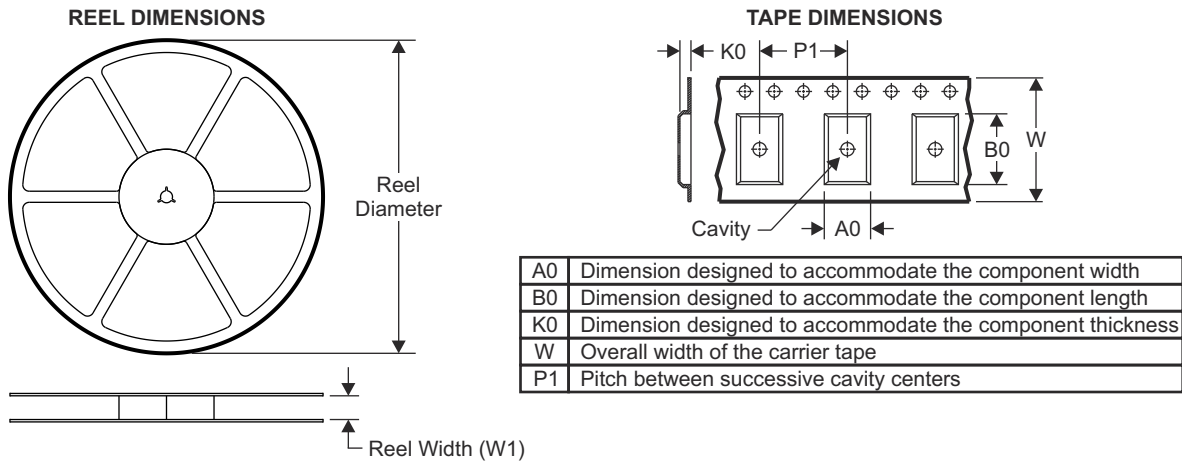
NOTE: Page numbers for previous revisions may differ from page numbers in the current version.

<b>Changes from Revision * (June 2024) to Revision A (September 2024)</b>	<b>Page</b>
• Updated the status of all OPNs to ACTIVE.....	<b>3</b>

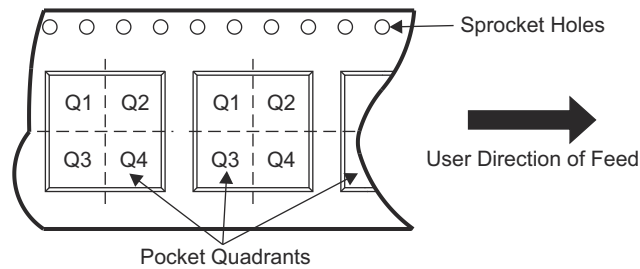
## 11 Mechanical, Packaging, and Orderable Information

The following pages include mechanical, packaging, and orderable information. This information is the most current data available for the designated devices. This data is subject to change without notice and revision of this document. For browser-based versions of this data sheet, refer to the left-hand navigation.

### 11.1 Tape and Reel Information



#### QUADRANT ASSIGNMENTS FOR PIN 1 ORIENTATION IN TAPE



Device	Package Type	Package Drawing	Pins	SPQ	Reel Diameter (mm)	Reel Width W1 (mm)	A0 (mm)	B0 (mm)	K0 (mm)	P1 (mm)	W (mm)	Pin1 Quadrant
LMR36503MSAERPERQ1	VQFN- HR	RPE	9	3000	180.0	8.4	2.2	2.2	1.2	4.0	8.0	Q2
LMR36503MSCERPERQ1	VQFN- HR	RPE	9	3000	180.0	8.4	2.2	2.2	1.2	4.0	8.0	Q2
LMR36503RSERPERQ1	VQFN- HR	RPE	9	3000	180.0	8.4	2.2	2.2	1.2	4.0	8.0	Q2
LMR36503RS3ERPERQ1	VQFN- HR	RPE	9	3000	180.0	8.4	2.2	2.2	1.2	4.0	8.0	Q2

**TAPE AND REEL BOX DIMENSIONS**



Device	Package Type	Package Drawing	Pins	SPQ	Length (mm)	Width (mm)	Height (mm)
LMR36503MSAERPERQ1	VQFN-HR	RPE	9	3000	213.0	191.0	35.0
LMR36503MSCERPERQ1	VQFN-HR	RPE	9	3000	213.0	191.0	35.0
LMR36503RSERPERQ1	VQFN-HR	RPE	9	3000	213.0	191.0	35.0
LMR36503RS3ERPERQ1	VQFN-HR	RPE	9	3000	213.0	191.0	35.0

**PACKAGING INFORMATION**

Orderable part number	Status (1)	Material type (2)	Package   Pins	Package qty   Carrier	RoHS (3)	Lead finish/ Ball material (4)	MSL rating/ Peak reflow (5)	Op temp (°C)	Part marking (6)
<a href="#">LMR36503MSAERPERQ1</a>	Active	Production	VQFN-HR (RPE)   9	3000   LARGE T&R	Yes	SN	Level-2-260C-1 YEAR	-40 to 175	SAEQ
LMR36503MSAERPERQ1.A	Active	Production	VQFN-HR (RPE)   9	3000   LARGE T&R	Yes	SN	Level-2-260C-1 YEAR	-40 to 175	SAEQ
<a href="#">LMR36503MSCERPERQ1</a>	Active	Production	VQFN-HR (RPE)   9	3000   LARGE T&R	Yes	SN	Level-2-260C-1 YEAR	-40 to 175	SCEQ
LMR36503MSCERPERQ1.A	Active	Production	VQFN-HR (RPE)   9	3000   LARGE T&R	Yes	SN	Level-2-260C-1 YEAR	-40 to 175	SCEQ
<a href="#">LMR36503RS3ERPERQ1</a>	Active	Production	VQFN-HR (RPE)   9	3000   LARGE T&R	Yes	SN	Level-2-260C-1 YEAR	-40 to 175	S3EQ
LMR36503RS3ERPERQ1.A	Active	Production	VQFN-HR (RPE)   9	3000   LARGE T&R	Yes	SN	Level-2-260C-1 YEAR	-40 to 175	S3EQ
<a href="#">LMR36503RSERPERQ1</a>	Active	Production	VQFN-HR (RPE)   9	3000   LARGE T&R	Yes	SN	Level-2-260C-1 YEAR	-40 to 175	RSEQ
LMR36503RSERPERQ1.A	Active	Production	VQFN-HR (RPE)   9	3000   LARGE T&R	Yes	SN	Level-2-260C-1 YEAR	-40 to 175	RSEQ

(1) **Status:** For more details on status, see our [product life cycle](#).

(2) **Material type:** When designated, preproduction parts are prototypes/experimental devices, and are not yet approved or released for full production. Testing and final process, including without limitation quality assurance, reliability performance testing, and/or process qualification, may not yet be complete, and this item is subject to further changes or possible discontinuation. If available for ordering, purchases will be subject to an additional waiver at checkout, and are intended for early internal evaluation purposes only. These items are sold without warranties of any kind.

(3) **RoHS values:** Yes, No, RoHS Exempt. See the [TI RoHS Statement](#) for additional information and value definition.

(4) **Lead finish/Ball material:** Parts may have multiple material finish options. Finish options are separated by a vertical ruled line. Lead finish/Ball material values may wrap to two lines if the finish value exceeds the maximum column width.

(5) **MSL rating/Peak reflow:** The moisture sensitivity level ratings and peak solder (reflow) temperatures. In the event that a part has multiple moisture sensitivity ratings, only the lowest level per JEDEC standards is shown. Refer to the shipping label for the actual reflow temperature that will be used to mount the part to the printed circuit board.

(6) **Part marking:** There may be an additional marking, which relates to the logo, the lot trace code information, or the environmental category of the part.

Multiple part markings will be inside parentheses. Only one part marking contained in parentheses and separated by a "-" will appear on a part. If a line is indented then it is a continuation of the previous line and the two combined represent the entire part marking for that device.

**Important Information and Disclaimer:**The information provided on this page represents TI's knowledge and belief as of the date that it is provided. TI bases its knowledge and belief on information provided by third parties, and makes no representation or warranty as to the accuracy of such information. Efforts are underway to better integrate information from third parties. TI has taken and continues to take reasonable steps to provide representative and accurate information but may not have conducted destructive testing or chemical analysis on incoming materials and chemicals. TI and TI suppliers consider certain information to be proprietary, and thus CAS numbers and other limited information may not be available for release.



In no event shall TI's liability arising out of such information exceed the total purchase price of the TI part(s) at issue in this document sold by TI to Customer on an annual basis.

## GENERIC PACKAGE VIEW

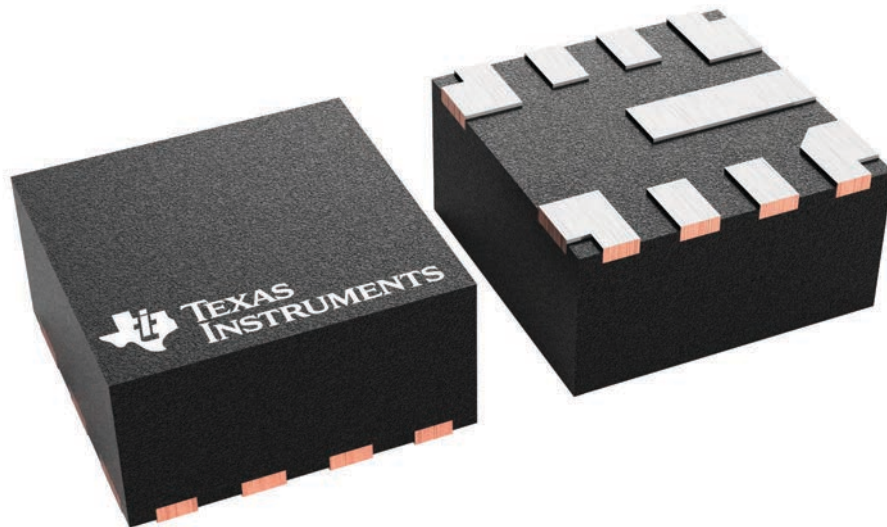
**RPE 9**

**VQFN-HR - 1.0 mm max height**

2 x 2, 0.5 mm pitch

PLASTIC QUAD FLATPACK - NO LEAD

This image is a representation of the package family, actual package may vary.  
Refer to the product data sheet for package details.



4227057/A

## IMPORTANT NOTICE AND DISCLAIMER

TI PROVIDES TECHNICAL AND RELIABILITY DATA (INCLUDING DATASHEETS), DESIGN RESOURCES (INCLUDING REFERENCE DESIGNS), APPLICATION OR OTHER DESIGN ADVICE, WEB TOOLS, SAFETY INFORMATION, AND OTHER RESOURCES "AS IS" AND WITH ALL FAULTS, AND DISCLAIMS ALL WARRANTIES, EXPRESS AND IMPLIED, INCLUDING WITHOUT LIMITATION ANY IMPLIED WARRANTIES OF MERCHANTABILITY, FITNESS FOR A PARTICULAR PURPOSE OR NON-INFRINGEMENT OF THIRD PARTY INTELLECTUAL PROPERTY RIGHTS.

These resources are intended for skilled developers designing with TI products. You are solely responsible for (1) selecting the appropriate TI products for your application, (2) designing, validating and testing your application, and (3) ensuring your application meets applicable standards, and any other safety, security, regulatory or other requirements.

These resources are subject to change without notice. TI grants you permission to use these resources only for development of an application that uses the TI products described in the resource. Other reproduction and display of these resources is prohibited. No license is granted to any other TI intellectual property right or to any third party intellectual property right. TI disclaims responsibility for, and you fully indemnify TI and its representatives against any claims, damages, costs, losses, and liabilities arising out of your use of these resources.

TI's products are provided subject to [TI's Terms of Sale](#), [TI's General Quality Guidelines](#), or other applicable terms available either on [ti.com](#) or provided in conjunction with such TI products. TI's provision of these resources does not expand or otherwise alter TI's applicable warranties or warranty disclaimers for TI products. Unless TI explicitly designates a product as custom or customer-specified, TI products are standard, catalog, general purpose devices.

TI objects to and rejects any additional or different terms you may propose.

Copyright © 2026, Texas Instruments Incorporated

Last updated 10/2025