

## SN74LVC2G02 Dual 2-Input Positive-NOR Gate

### 1 Features

- Available in the Texas Instruments NanoFree™ package
- Supports 5-V  $V_{CC}$  operation
- Inputs accept voltages to 5.5 V
- Max  $t_{pd}$  of 4.9 ns at 3.3 V
- Low power consumption, 10- $\mu$ A Max  $I_{CC}$
- $\pm 24$ -mA Output drive at 3.3 V
- Typical  $V_{OLP}$  (output ground bounce) <0.8 V at  $V_{CC} = 3.3$  V,  $T_A = 25^\circ\text{C}$
- Typical  $V_{OHV}$  (output  $V_{OH}$  undershoot) >2 V at  $V_{CC} = 3.3$  V,  $T_A = 25^\circ\text{C}$
- $I_{off}$  supports partial-power-down mode operation
- Latch-up performance exceeds 100 mA er JESD 78, class II
- ESD protection exceeds JESD 22
  - 2000-V Human-body model (A114-A)
  - 1000-V Charged-device model (C101)

### 2 Applications

- AV receiver
- Audio dock: portable
- Blu-ray player and home theater
- Embedded PC
- MP3 Player/recorder (portable audio)
- Personal digital assistant (PDA)
- Power: Telecom/server AC/DC supply: single controller: analog and digital
- Solid state drive (SSD): client and enterprise
- TV: LCD/digital and high-definition (HDTV)
- Tablet: enterprise
- Video analytics: server
- Wireless headset, keyboard, and mouse

### 3 Description

This dual 2-input positive-NOR gate is designed for 1.65-V to 5.5-V  $V_{CC}$  operation.

The SN74LVC2G02 device performs the Boolean function  $Y = \overline{A + B}$  or  $Y = \overline{A} \times \overline{B}$  in positive logic.

NanoFree™ package technology is a major breakthrough in IC packaging concepts, using the die as the package.

This device is fully specified for partial-power-down applications using  $I_{off}$ . The  $I_{off}$  circuitry disables the outputs, preventing damaging current backflow through the device when it is powered down.

#### Device Information<sup>(1)</sup>

PART NUMBER	PACKAGE	BODY SIZE (NOM)
SN74LVC2G02DCT	SSOP (8)	2.95 mm × 2.8 mm
SN74LVC2G02DCU	VSSOP (8)	2.3 mm × 2.0 mm
SN74LVC2G02YZP	DSBGA (8)	1.91 mm × 0.91 mm

(1) For all available packages, see the orderable addendum at the end of the data sheet.

#### Simplified Schematic

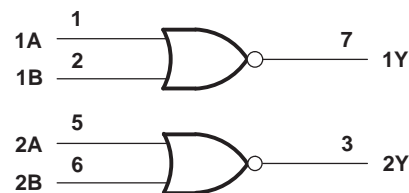

## Table of Contents

<b>1 Features</b> .....	<b>1</b>	8.1 Overview .....	<b>9</b>
<b>2 Applications</b> .....	<b>1</b>	8.2 Functional Block Diagram .....	<b>9</b>
<b>3 Description</b> .....	<b>1</b>	8.3 Feature Description .....	<b>9</b>
<b>4 Revision History</b> .....	<b>2</b>	8.4 Device Functional Modes .....	<b>9</b>
<b>5 Pin Configuration and Functions</b> .....	<b>3</b>	<b>9 Application and Implementation</b> .....	<b>10</b>
<b>6 Specifications</b> .....	<b>4</b>	9.1 Application Information .....	<b>10</b>
6.1 Absolute Maximum Ratings .....	<b>4</b>	9.2 Typical Application .....	<b>10</b>
6.2 ESD Ratings .....	<b>4</b>	<b>10 Power Supply Recommendations</b> .....	<b>11</b>
6.3 Recommended Operating Conditions .....	<b>5</b>	<b>11 Layout</b> .....	<b>11</b>
6.4 Thermal Information .....	<b>5</b>	11.1 Layout Guidelines .....	<b>11</b>
6.5 Electrical Characteristics .....	<b>6</b>	11.2 Layout Example .....	<b>11</b>
6.6 Switching Characteristics .....	<b>6</b>	<b>12 Device and Documentation Support</b> .....	<b>12</b>
6.7 Switching Characteristics .....	<b>6</b>	12.1 Community Resources .....	<b>12</b>
6.8 Operating Characteristics .....	<b>6</b>	12.2 Trademarks .....	<b>12</b>
6.9 Typical Characteristics .....	<b>7</b>	12.3 Electrostatic Discharge Caution .....	<b>12</b>
<b>7 Parameter Measurement Information</b> .....	<b>8</b>	12.4 Glossary .....	<b>12</b>
<b>8 Detailed Description</b> .....	<b>9</b>	<b>13 Mechanical, Packaging, and Orderable Information</b> .....	<b>12</b>

## 4 Revision History

NOTE: Page numbers for previous revisions may differ from page numbers in the current version.

<b>Changes from Revision M (November 2013) to Revision N</b>	<b>Page</b>
• Updated document to new TI data sheet format .....	<b>1</b>
• Added Device Information table. ....	<b>1</b>
• Added $T_J(\text{Max})$ spec to Abs Max Ratings table .....	<b>4</b>
• Moved $T_{\text{stg}}$ spec to Abs Max Ratings table. ....	<b>4</b>

<b>Changes from Revision L (April 1999) to Revision M</b>	<b>Page</b>
• Removed Ordering Information table. ....	<b>1</b>
• Updated operating temperature range. ....	<b>5</b>

## 5 Pin Configuration and Functions

**DCT Package  
8-Pin SSOP  
Top View**

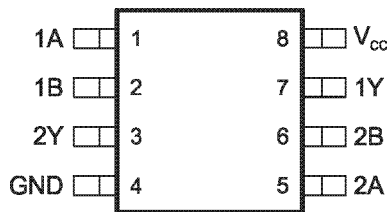

**DCU Package  
8-Pin VSSOP  
Top View**

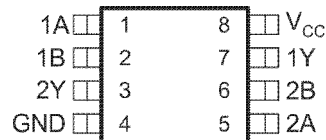

**YZP Package  
8-Pin DSBGA  
Bottom View**

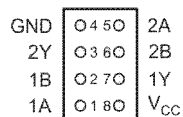

### Pin Functions

PIN		I/O	DESCRIPTION
NAME	NO.		
1A	1	Input	Channel 1 input A
1B	2	Input	Channel 1 input B
2Y	3	Output	Channel 2 output Y
GND	4	–	Ground
2A	5	Input	Channel 2 input A
2B	6	Input	Channel 2 input B
1Y	7	Output	Channel 1 output Y
VCC	8	–	Positive supply

### Logic Diagram (Positive Logic)

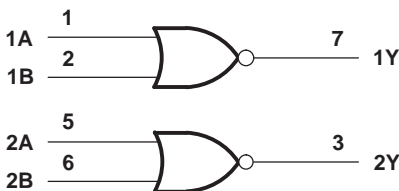

## 6 Specifications

### 6.1 Absolute Maximum Ratings<sup>(1)</sup>

over operating free-air temperature range (unless otherwise noted)

		MIN	MAX	UNIT	
V <sub>CC</sub>	Supply voltage range	-0.5	6.5	V	
V <sub>I</sub>	Input voltage range <sup>(2)</sup>	-0.5	6.5	V	
V <sub>O</sub>	Voltage range applied to any output in the high-impedance or power-off state <sup>(2)</sup>	-0.5	6.5	V	
V <sub>O</sub>	Voltage range applied to any output in the high or low state <sup>(2)(3)</sup>	-0.5	V <sub>CC</sub> + 0.5	V	
I <sub>IK</sub>	Input clamp current	V <sub>I</sub> < 0	-50	mA	
I <sub>OK</sub>	Output clamp current	V <sub>O</sub> < 0	-50	mA	
I <sub>O</sub>	Continuous output current		±50	mA	
	Continuous current through V <sub>CC</sub> or GND		±100	mA	
T <sub>J</sub>	Junction temperature		150	°C	
T <sub>stg</sub>	Storage temperature		-65	150	°C

- (1) Stresses beyond those listed under *Absolute Maximum Ratings* may cause permanent damage to the device. These are stress ratings only, and functional operation of the device at these or any other conditions beyond those indicated under *Recommended Operating Conditions* is not implied. Exposure to absolute-maximum-rated conditions for extended periods may affect device reliability.
- (2) The input negative-voltage and output voltage ratings may be exceeded if the input and output clamp-current ratings are observed.
- (3) The value of V<sub>CC</sub> is provided in the *Recommended Operating Conditions* table.

### 6.2 ESD Ratings

		VALUE	UNIT
V <sub>(ESD)</sub>	Electrostatic discharge	Human-body model (HBM), per ANSI/ESDA/JEDEC JS-001 <sup>(1)</sup>	±2500
		Charged-device model (CDM), per JEDEC specification JESD22-C101 <sup>(2)</sup>	±1500

- (1) JEDEC document JEP155 states that 500-V HBM allows safe manufacturing with a standard ESD control process.
- (2) JEDEC document JEP157 states that 250-V CDM allows safe manufacturing with a standard ESD control process.

### 6.3 Recommended Operating Conditions<sup>(1)</sup>

			MIN	MAX	UNIT
V <sub>CC</sub>	Supply voltage	Operating	1.65	5.5	V
		Data retention only	1.5		
V <sub>IH</sub>	High-level input voltage	V <sub>CC</sub> = 1.65 V to 1.95 V	0.65 × V <sub>CC</sub>		V
		V <sub>CC</sub> = 2.3 V to 2.7 V	1.7		
		V <sub>CC</sub> = 3 V to 3.6 V	2		
		V <sub>CC</sub> = 4.5 V to 5.5 V	0.7 × V <sub>CC</sub>		
V <sub>IL</sub>	Low-level input voltage	V <sub>CC</sub> = 1.65 V to 1.95 V	0.35 × V <sub>CC</sub>		V
		V <sub>CC</sub> = 2.3 V to 2.7 V	0.7		
		V <sub>CC</sub> = 3 V to 3.6 V	0.8		
		V <sub>CC</sub> = 4.5 V to 5.5 V	0.3 × V <sub>CC</sub>		
V <sub>I</sub>	Input voltage		0	5.5	V
V <sub>O</sub>	Output voltage		0	V <sub>CC</sub>	V
I <sub>OH</sub>	High-level output current	V <sub>CC</sub> = 1.65 V	–4		mA
		V <sub>CC</sub> = 2.3 V	–8		
		V <sub>CC</sub> = 3 V	–16		
		V <sub>CC</sub> = 4.5 V	–24		
I <sub>OL</sub>	Low-level output current	V <sub>CC</sub> = 1.65 V	4		mA
		V <sub>CC</sub> = 2.3 V	8		
		V <sub>CC</sub> = 3 V	16		
		V <sub>CC</sub> = 4.5 V	32		
Δt/Δv	Input transition rise or fall rate	V <sub>CC</sub> = 1.8 V ± 0.15 V, 2.5 V ± 0.2 V	20		ns/V
		V <sub>CC</sub> = 3.3 V ± 0.3 V	10		
		V <sub>CC</sub> = 5 V ± 0.5 V	5		
T <sub>A</sub>	Operating free-air temperature		–40	125	°C

(1) All unused inputs of the device must be held at V<sub>CC</sub> or GND to ensure proper device operation. Refer to the TI application report, *Implications of Slow or Floating CMOS Inputs*, literature number [SCBA004](#).

### 6.4 Thermal Information

THERMAL METRIC <sup>(1)</sup>		SN74LVC2G02			UNIT
		DCT (SSOP)	DCU (VSSOP)	YZP (DSBGA)	
		8 PINS	8 PINS	8 PINS	
R <sub>θJA</sub>	Junction-to-ambient thermal resistance	182.8	201.8	99.9	°C/W
R <sub>θJC(top)</sub>	Junction-to-case (top) thermal resistance	87.8	93.3	1.0	°C/W
R <sub>θJB</sub>	Junction-to-board thermal resistance	97.9	124.0	27.8	°C/W
Ψ <sub>JT</sub>	Junction-to-top characterization parameter	20.7	32.3	0.4	°C/W
Ψ <sub>JB</sub>	Junction-to-board characterization parameter	96.6	123.6	27.8	°C/W
R <sub>θJC(bot)</sub>	Junction-to-case (bottom) thermal resistance	N/A	N/A	N/A	°C/W

(1) For more information about traditional and new thermal metrics, see the [Semiconductor and IC package thermal metrics application report](#).

## 6.5 Electrical Characteristics

over recommended operating free-air temperature range (unless otherwise noted)

PARAMETER	TEST CONDITIONS	V <sub>CC</sub>	–40°C to 85°C			–40°C to 125°C			UNIT
			MIN	TYP <sup>(1)</sup>	MAX	MIN	TYP <sup>(1)</sup>	MAX	
V <sub>OH</sub>	I <sub>OH</sub> = –100 μA	1.65 V to 5.5 V	V <sub>CC</sub> – 0.1			V <sub>CC</sub> – 0.1			V
	I <sub>OH</sub> = –4 mA	1.65 V	1.2			1.2			
	I <sub>OH</sub> = –8 mA	2.3 V	1.9			1.9			
	I <sub>OH</sub> = –16 mA	3 V	2.4			2.4			
	I <sub>OH</sub> = –24 mA		2.3			2.3			
	I <sub>OH</sub> = –32 mA	4.5 V	3.8			3.8			
V <sub>OL</sub>	I <sub>OL</sub> = 100 μA	1.65 V to 5.5 V	0.1			0.1			V
	I <sub>OL</sub> = 4 mA	1.65 V	0.45			0.45			
	I <sub>OL</sub> = 8 mA	2.3 V	0.3			0.3			
	I <sub>OL</sub> = 16 mA	3 V	0.4			0.4			
	I <sub>OL</sub> = 24 mA		0.55			0.75			
	I <sub>OL</sub> = 32 mA	4.5 V	0.55			0.75			
I <sub>I</sub>	A or B inputs	V <sub>I</sub> = 5.5 V or GND	0 to 5.5 V			±5			μA
I <sub>off</sub>		V <sub>I</sub> or V <sub>O</sub> = 5.5 V	0			±10			μA
I <sub>CC</sub>		V <sub>I</sub> = 5.5 V or GND, I <sub>O</sub> = 0	1.65 V to 5.5 V			10			μA
ΔI <sub>CC</sub>		One input at V <sub>CC</sub> – 0.6 V, Other inputs at V <sub>CC</sub> or GND	3 V to 5.5 V			500			μA
C <sub>i</sub>		V <sub>I</sub> = V <sub>CC</sub> or GND	3.3 V			5			pF

 (1) All typical values are at V<sub>CC</sub> = 3.3 V, T<sub>A</sub> = 25°C.

## 6.6 Switching Characteristics

over recommended operating free-air temperature range (unless otherwise noted) (see Figure 3)

PARAMETER	FROM (INPUT)	TO (OUTPUT)	–40°C to 85°C								UNIT
			V <sub>CC</sub> = 1.8 V ± 0.15 V		V <sub>CC</sub> = 2.5 V ± 0.2 V		V <sub>CC</sub> = 3.3 V ± 0.3 V		V <sub>CC</sub> = 5 V ± 0.5 V		
			MIN	MAX	MIN	MAX	MIN	MAX	MIN	MAX	
t <sub>pd</sub>	A or B	Y	3.2	8.9	1	5.4	1	4.9	1	4.4	ns

## 6.7 Switching Characteristics

over recommended operating free-air temperature range (unless otherwise noted) (see Figure 3)

PARAMETER	FROM (INPUT)	TO (OUTPUT)	–40°C to 125°C								UNIT
			V <sub>CC</sub> = 1.8 V ± 0.15 V		V <sub>CC</sub> = 2.5 V ± 0.2 V		V <sub>CC</sub> = 3.3 V ± 0.3 V		V <sub>CC</sub> = 5 V ± 0.5 V		
			MIN	MAX	MIN	MAX	MIN	MAX	MIN	MAX	
t <sub>pd</sub>	A or B	Y	3.2	10.9	1	6.4	1	5.9	1	5.4	ns

## 6.8 Operating Characteristics

 T<sub>A</sub> = 25°C

PARAMETER	TEST CONDITIONS	V <sub>CC</sub> = 1.8 V	V <sub>CC</sub> = 2.5 V	V <sub>CC</sub> = 3.3 V	V <sub>CC</sub> = 5 V	UNIT	
		TYP	TYP	TYP	TYP		
C <sub>pd</sub>	Power dissipation capacitance	f = 10 MHz	18	18	19	22	pF

## 6.9 Typical Characteristics

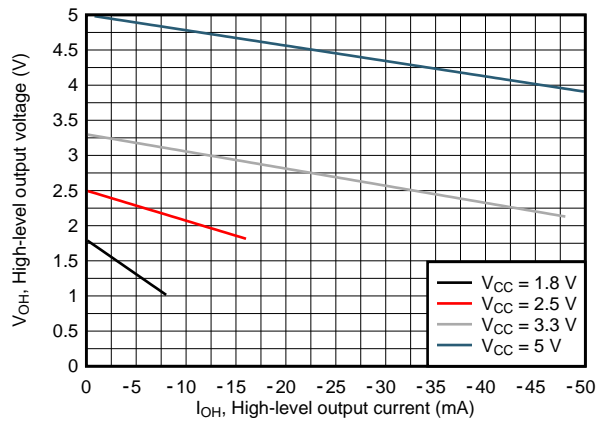

Figure 1. Simulated typical high-level output voltage ( $V_{OH}$ ) across high-level output current ( $I_{OH}$ ) at common supply values

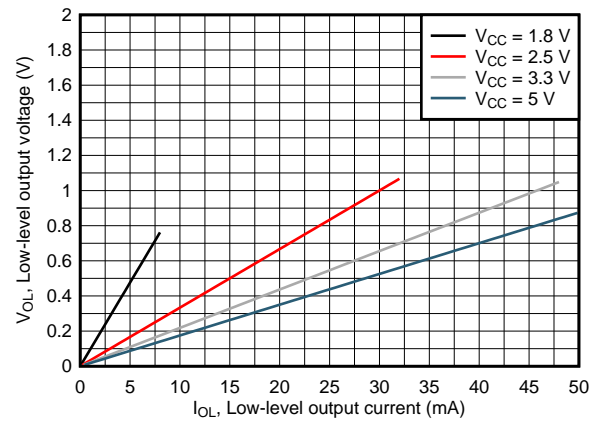
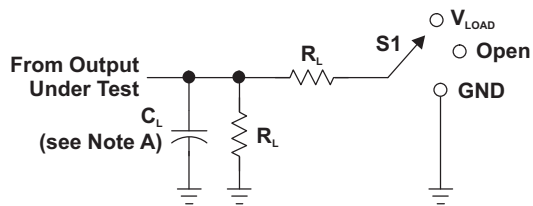

Figure 2. Simulated typical low-level output voltage ( $V_{OL}$ ) across low-level output current ( $I_{OL}$ ) at common supply values

## 7 Parameter Measurement Information

**LOAD CIRCUIT**

TEST	S1
$t_{PLH}/t_{PHL}$	Open
$t_{PLZ}/t_{PZL}$	$V_{LOAD}$
$t_{PHZ}/t_{PZH}$	GND

$V_{CC}$	INPUTS		$V_M$	$V_{LOAD}$	$C_L$	$R_L$	$V_\Delta$
	$V_i$	$t_i/t_r$					
$1.8\text{ V} \pm 0.15\text{ V}$	$V_{CC}$	$\leq 2\text{ ns}$	$V_{CC}/2$	$2 \times V_{CC}$	30 pF	1 k $\Omega$	0.15 V
$2.5\text{ V} \pm 0.2\text{ V}$	$V_{CC}$	$\leq 2\text{ ns}$	$V_{CC}/2$	$2 \times V_{CC}$	30 pF	500 $\Omega$	0.15 V
$3.3\text{ V} \pm 0.3\text{ V}$	3 V	$\leq 2.5\text{ ns}$	1.5 V	6 V	50 pF	500 $\Omega$	0.3 V
$5\text{ V} \pm 0.5\text{ V}$	$V_{CC}$	$\leq 2.5\text{ ns}$	$V_{CC}/2$	$2 \times V_{CC}$	50 pF	500 $\Omega$	0.3 V

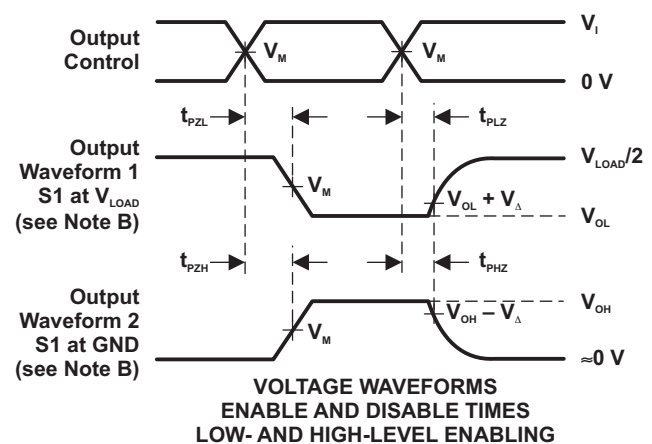
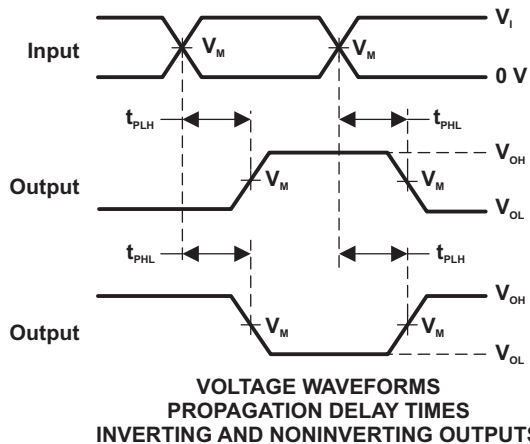
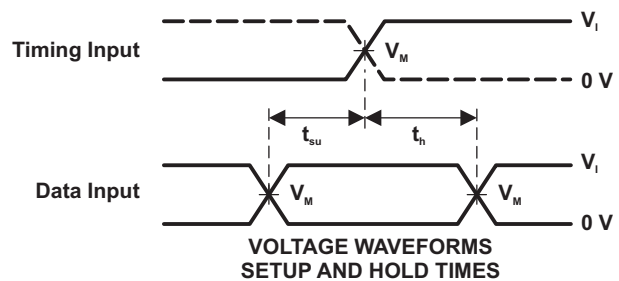
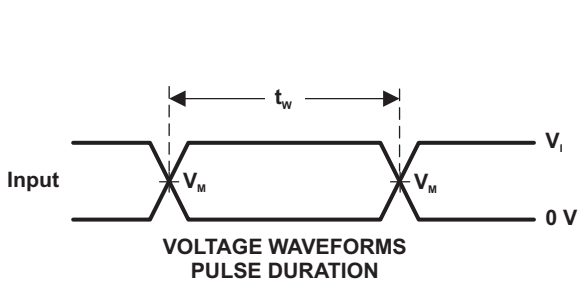

- NOTES:
- A.  $C_L$  includes probe and jig capacitance.
  - B. Waveform 1 is for an output with internal conditions such that the output is low, except when disabled by the output control. Waveform 2 is for an output with internal conditions such that the output is high, except when disabled by the output control.
  - C. All input pulses are supplied by generators having the following characteristics:  $PRR \leq 10\text{ MHz}$ ,  $Z_o = 50\ \Omega$ .
  - D. The outputs are measured one at a time, with one transition per measurement.
  - E.  $t_{PLZ}$  and  $t_{PHZ}$  are the same as  $t_{dis}$ .
  - F.  $t_{PZL}$  and  $t_{PZH}$  are the same as  $t_{en}$ .
  - G.  $t_{PLH}$  and  $t_{PHL}$  are the same as  $t_{pd}$ .
  - H. All parameters and waveforms are not applicable to all devices.

**Figure 3. Load Circuit and Voltage Waveforms**



## 8 Detailed Description

### 8.1 Overview

The SN74LVC2G02 device contains two 2-input positive-NOR gates and each gate performs the Boolean function  $Y = A + B$  or  $Y = \overline{A \cdot B}$ . This device is fully specified for partial-power-down applications using  $I_{off}$ . The  $I_{off}$  circuitry disables the outputs, preventing damaging current backflow through the device when it is powered down.

### 8.2 Functional Block Diagram

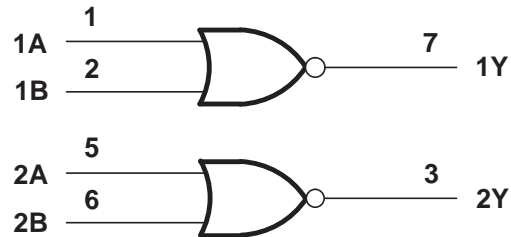

### 8.3 Feature Description

- Wide operating voltage range.
  - Operates from 1.65 V to 5.5 V.
- Allows down voltage translation.
- Inputs accept voltages to 5.5 V.
- $I_{off}$  feature allows voltages on the inputs and outputs, when  $V_{CC}$  is 0 V.

### 8.4 Device Functional Modes

**Table 1. Function Table  
(Each Gate)**

INPUTS		OUTPUT Y
A	B	
H	X	L
X	H	L
L	L	H

## 9 Application and Implementation

### 9.1 Application Information

The SN74LVC2G02 is a high-drive CMOS device that can be used for implement NOR logic with a high output drive, such as an LED application. It can produce 24-mA of drive current at 3.3 V making it Ideal for driving multiple outputs and good for high speed applications up to 100 Mhz. The inputs are 5.5-V tolerant allowing translation down to  $V_{CC}$ .

### 9.2 Typical Application

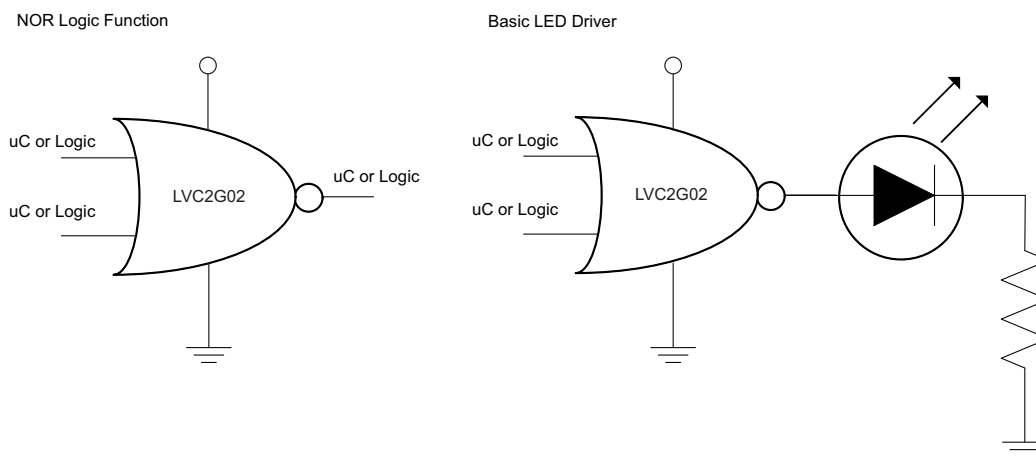

#### 9.2.1 Design Requirements

This device uses CMOS technology and has balanced output drive. Care should be taken to avoid bus contention because it can drive currents that would exceed maximum limits. The high drive will also create fast edges into light loads, so routing and load conditions should be considered to prevent ringing.

#### 9.2.2 Detailed Design Procedure

##### 1. Recommended Input Conditions:

- Rise time and fall time specs. See ( $\Delta t/\Delta V$ ) in the [Recommended Operating Conditions](#) table.
- Specified high and low levels. See ( $V_{IH}$  and  $V_{IL}$ ) in the [Recommended Operating Conditions](#) table.
- Inputs are overvoltage tolerant allowing them to go as high as ( $V_I$  max) in the [Recommended Operating Conditions](#) table at any valid  $V_{CC}$ .

##### 2. Recommend Output Conditions:

- Load currents should not exceed ( $I_O$  max) per output and should not exceed total current (continuous current through  $V_{CC}$  or GND) for the part. These limits are located in the [Absolute Maximum Ratings](#) table.
- Outputs should not be pulled above  $V_{CC}$ .

## Typical Application (continued)

### 9.2.3 Application Curves

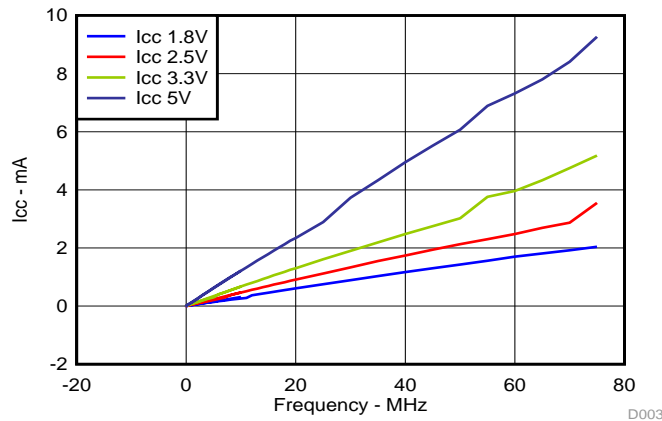

Figure 4. I<sub>CC</sub> vs Frequency

## 10 Power Supply Recommendations

The power supply can be any voltage between the min and max supply voltage rating located in the [Recommended Operating Conditions](#) table.

Each VCC pin should have a good bypass capacitor to prevent power disturbance. For devices with a single supply, a 0.1- $\mu$ F capacitor is recommended. If there are multiple VCC pins, then a 0.01- $\mu$ F or 0.022- $\mu$ F capacitor is recommended for each power pin. It is ok to parallel multiple bypass capacitors to reject different frequencies of noise. A 0.1- $\mu$ F and 1- $\mu$ F capacitors are commonly used in parallel. The bypass capacitor should be installed as close to the power pin as possible for best results.

## 11 Layout

### 11.1 Layout Guidelines

When using multiple bit logic devices inputs should not ever float.

In many cases, functions or parts of functions of digital logic devices are unused; for example, when only two inputs of a triple-input AND gate are used or only 3 of the 4 buffer gates are used. Such input pins should not be left unconnected because the undefined voltages at the outside connections result in undefined operational states. Specified below are the rules that must be observed under all circumstances. All unused inputs of digital logic devices must be connected to a high or low bias to prevent them from floating. The logic level that should be applied to any particular unused input depends on the function of the device. Generally they will be tied to GND or VCC, whichever makes more sense or is more convenient.

### 11.2 Layout Example

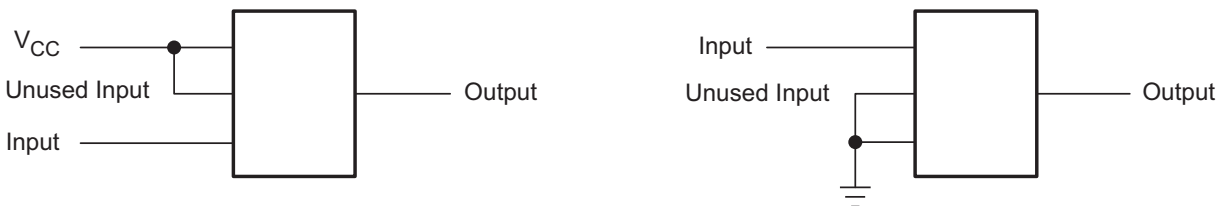

## 12 Device and Documentation Support

### 12.1 Community Resources

The following links connect to TI community resources. Linked contents are provided "AS IS" by the respective contributors. They do not constitute TI specifications and do not necessarily reflect TI's views; see TI's [Terms of Use](#).

**TI E2E™ Online Community** *TI's Engineer-to-Engineer (E2E) Community*. Created to foster collaboration among engineers. At [e2e.ti.com](http://e2e.ti.com), you can ask questions, share knowledge, explore ideas and help solve problems with fellow engineers.

**Design Support** *TI's Design Support* Quickly find helpful E2E forums along with design support tools and contact information for technical support.

### 12.2 Trademarks

NanoFree, E2E are trademarks of Texas Instruments.

### 12.3 Electrostatic Discharge Caution



This integrated circuit can be damaged by ESD. Texas Instruments recommends that all integrated circuits be handled with appropriate precautions. Failure to observe proper handling and installation procedures can cause damage.

ESD damage can range from subtle performance degradation to complete device failure. Precision integrated circuits may be more susceptible to damage because very small parametric changes could cause the device not to meet its published specifications.

### 12.4 Glossary

[SLYZ022](#) — *TI Glossary*.

This glossary lists and explains terms, acronyms, and definitions.

## 13 Mechanical, Packaging, and Orderable Information

The following pages include mechanical, packaging, and orderable information. This information is the most current data available for the designated devices. This data is subject to change without notice and revision of this document. For browser-based versions of this data sheet, refer to the left-hand navigation.

## PACKAGING INFORMATION

Orderable Device	Status (1)	Package Type	Package Drawing	Pins	Package Qty	Eco Plan (2)	Lead finish/ Ball material (6)	MSL Peak Temp (3)	Op Temp (°C)	Device Marking (4/5)	Samples
SN74LVC2G02DCTR	ACTIVE	SM8	DCT	8	3000	RoHS & Green	NIPDAU   SN	Level-1-260C-UNLIM	-40 to 125	(2WI5, C02) (R, Z)	<a href="#">Samples</a>
SN74LVC2G02DCTRE4	ACTIVE	SM8	DCT	8	3000	RoHS & Green	NIPDAU	Level-1-260C-UNLIM	-40 to 125	(2WI5, C02) (R, Z)	<a href="#">Samples</a>
SN74LVC2G02DCUR	ACTIVE	VSSOP	DCU	8	3000	RoHS & Green	NIPDAU   SN	Level-1-260C-UNLIM	-40 to 125	(C02J, C02Q, C02R)	<a href="#">Samples</a>
SN74LVC2G02DCUT	ACTIVE	VSSOP	DCU	8	250	RoHS & Green	NIPDAU   SN	Level-1-260C-UNLIM	-40 to 125	(C02J, C02Q, C02R)	<a href="#">Samples</a>
SN74LVC2G02YZPR	ACTIVE	DSBGA	YZP	8	3000	RoHS & Green	SNAGCU	Level-1-260C-UNLIM	-40 to 125	CBN	<a href="#">Samples</a>

(1) The marketing status values are defined as follows:

**ACTIVE:** Product device recommended for new designs.

**LIFEBUY:** TI has announced that the device will be discontinued, and a lifetime-buy period is in effect.

**NRND:** Not recommended for new designs. Device is in production to support existing customers, but TI does not recommend using this part in a new design.

**PREVIEW:** Device has been announced but is not in production. Samples may or may not be available.

**OBSOLETE:** TI has discontinued the production of the device.

(2) **RoHS:** TI defines "RoHS" to mean semiconductor products that are compliant with the current EU RoHS requirements for all 10 RoHS substances, including the requirement that RoHS substance do not exceed 0.1% by weight in homogeneous materials. Where designed to be soldered at high temperatures, "RoHS" products are suitable for use in specified lead-free processes. TI may reference these types of products as "Pb-Free".

**RoHS Exempt:** TI defines "RoHS Exempt" to mean products that contain lead but are compliant with EU RoHS pursuant to a specific EU RoHS exemption.

**Green:** TI defines "Green" to mean the content of Chlorine (Cl) and Bromine (Br) based flame retardants meet JS709B low halogen requirements of <=1000ppm threshold. Antimony trioxide based flame retardants must also meet the <=1000ppm threshold requirement.

(3) MSL, Peak Temp. - The Moisture Sensitivity Level rating according to the JEDEC industry standard classifications, and peak solder temperature.

(4) There may be additional marking, which relates to the logo, the lot trace code information, or the environmental category on the device.

(5) Multiple Device Markings will be inside parentheses. Only one Device Marking contained in parentheses and separated by a "~" will appear on a device. If a line is indented then it is a continuation of the previous line and the two combined represent the entire Device Marking for that device.

(6) Lead finish/Ball material - Orderable Devices may have multiple material finish options. Finish options are separated by a vertical ruled line. Lead finish/Ball material values may wrap to two lines if the finish value exceeds the maximum column width.

**Important Information and Disclaimer:**The information provided on this page represents TI's knowledge and belief as of the date that it is provided. TI bases its knowledge and belief on information provided by third parties, and makes no representation or warranty as to the accuracy of such information. Efforts are underway to better integrate information from third parties. TI has taken and continues to take reasonable steps to provide representative and accurate information but may not have conducted destructive testing or chemical analysis on incoming materials and chemicals. TI and TI suppliers consider certain information to be proprietary, and thus CAS numbers and other limited information may not be available for release.

In no event shall TI's liability arising out of such information exceed the total purchase price of the TI part(s) at issue in this document sold by TI to Customer on an annual basis.

**OTHER QUALIFIED VERSIONS OF SN74LVC2G02 :**

- Enhanced Product : [SN74LVC2G02-EP](#)

NOTE: Qualified Version Definitions:

- Enhanced Product - Supports Defense, Aerospace and Medical Applications

**TAPE AND REEL INFORMATION**

**QUADRANT ASSIGNMENTS FOR PIN 1 ORIENTATION IN TAPE**

\*All dimensions are nominal

Device	Package Type	Package Drawing	Pins	SPQ	Reel Diameter (mm)	Reel Width W1 (mm)	A0 (mm)	B0 (mm)	K0 (mm)	P1 (mm)	W (mm)	Pin1 Quadrant
SN74LVC2G02DCTR	SM8	DCT	8	3000	180.0	12.4	3.15	4.35	1.55	4.0	12.0	Q3
SN74LVC2G02DCUR	VSSOP	DCU	8	3000	178.0	9.0	2.25	3.35	1.05	4.0	8.0	Q3
SN74LVC2G02DCUT	VSSOP	DCU	8	250	178.0	9.5	2.25	3.35	1.05	4.0	8.0	Q3
SN74LVC2G02DCUT	VSSOP	DCU	8	250	178.0	9.0	2.25	3.35	1.05	4.0	8.0	Q3
SN74LVC2G02YZPR	DSBGA	YZP	8	3000	178.0	9.2	1.02	2.02	0.63	4.0	8.0	Q1

## TAPE AND REEL BOX DIMENSIONS



\*All dimensions are nominal

Device	Package Type	Package Drawing	Pins	SPQ	Length (mm)	Width (mm)	Height (mm)
SN74LVC2G02DCTR	SM8	DCT	8	3000	190.0	190.0	30.0
SN74LVC2G02DCUR	VSSOP	DCU	8	3000	180.0	180.0	18.0
SN74LVC2G02DCUT	VSSOP	DCU	8	250	202.0	201.0	28.0
SN74LVC2G02DCUT	VSSOP	DCU	8	250	180.0	180.0	18.0
SN74LVC2G02YZPR	DSBGA	YZP	8	3000	220.0	220.0	35.0



# DCU0008A



# PACKAGE OUTLINE

## VSSOP - 0.9 mm max height

SMALL OUTLINE PACKAGE



4225266/A 09/2014

### NOTES:

1. All linear dimensions are in millimeters. Any dimensions in parenthesis are for reference only. Dimensioning and tolerancing per ASME Y14.5M.
2. This drawing is subject to change without notice.
3. This dimension does not include mold flash, protrusions, or gate burrs. Mold flash, protrusions, or gate burrs shall not exceed 0.15 mm per side.
4. Reference JEDEC registration MO-187 variation CA.

# EXAMPLE BOARD LAYOUT

DCU0008A

VSSOP - 0.9 mm max height

SMALL OUTLINE PACKAGE

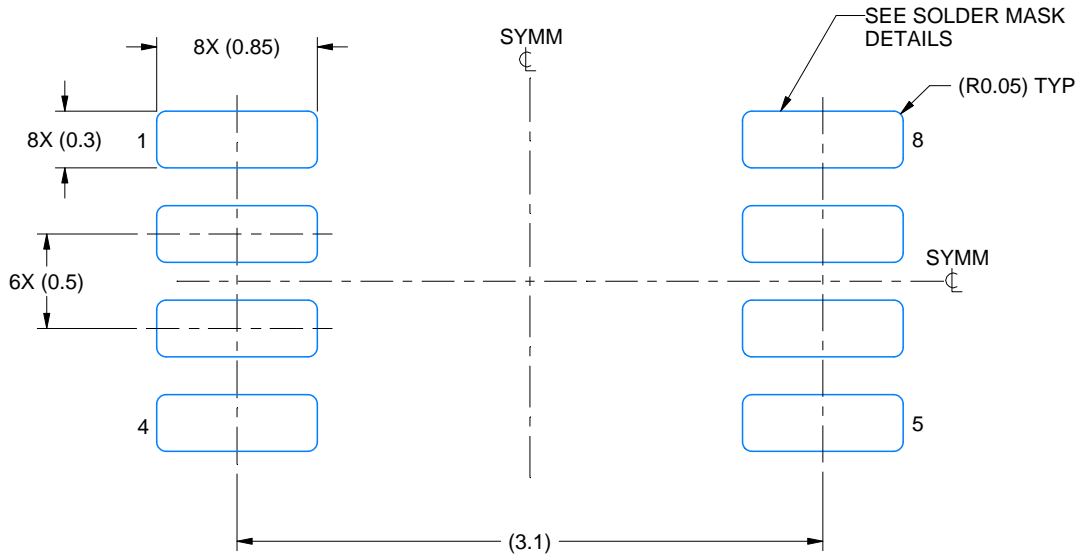

LAND PATTERN EXAMPLE  
EXPOSED METAL SHOWN  
SCALE: 25X



4225266/A 09/2014

NOTES: (continued)

- 5. Publication IPC-7351 may have alternate designs.
- 6. Solder mask tolerances between and around signal pads can vary based on board fabrication site.

# EXAMPLE STENCIL DESIGN

DCU0008A

VSSOP - 0.9 mm max height

SMALL OUTLINE PACKAGE



SOLDER PASTE EXAMPLE  
BASED ON 0.125 mm THICK STENCIL  
SCALE: 25X

4225266/A 09/2014

NOTES: (continued)

7. Laser cutting apertures with trapezoidal walls and rounded corners may offer better paste release. IPC-7525 may have alternate design recommendations.
8. Board assembly site may have different recommendations for stencil design.



4220784/C 06/2021

NOTES:

1. All linear dimensions are in millimeters. Dimensions in parenthesis are for reference only. Dimensioning and tolerancing per ASME Y14.5M.
2. This drawing is subject to change without notice.
3. This dimension does not include mold flash, protrusions, or gate burrs. Mold flash, protrusions, or gate burrs shall not exceed 0.15 mm per side.
4. This dimension does not include interlead flash. Interlead flash shall not exceed 0.25 mm per side.

# EXAMPLE BOARD LAYOUT

DCT0008A

SSOP - 1.3 mm max height

SMALL OUTLINE PACKAGE

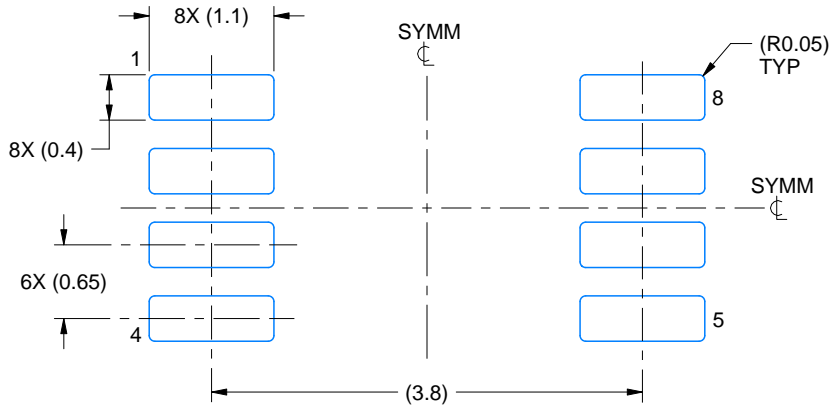

LAND PATTERN EXAMPLE  
EXPOSED METAL SHOWN  
SCALE:15X



SOLDER MASK DETAILS

4220784/C 06/2021

NOTES: (continued)

- 5. Publication IPC-7351 may have alternate designs.
- 6. Solder mask tolerances between and around signal pads can vary based on board fabrication site.

# EXAMPLE STENCIL DESIGN

DCT0008A

SSOP - 1.3 mm max height

SMALL OUTLINE PACKAGE



SOLDER PASTE EXAMPLE  
BASED ON 0.125 mm THICK STENCIL  
SCALE:15X

4220784/C 06/2021

NOTES: (continued)

7. Laser cutting apertures with trapezoidal walls and rounded corners may offer better paste release. IPC-7525 may have alternate design recommendations.
8. Board assembly site may have different recommendations for stencil design.

YZP0008



# PACKAGE OUTLINE

DSBGA - 0.5 mm max height

DIE SIZE BALL GRID ARRAY

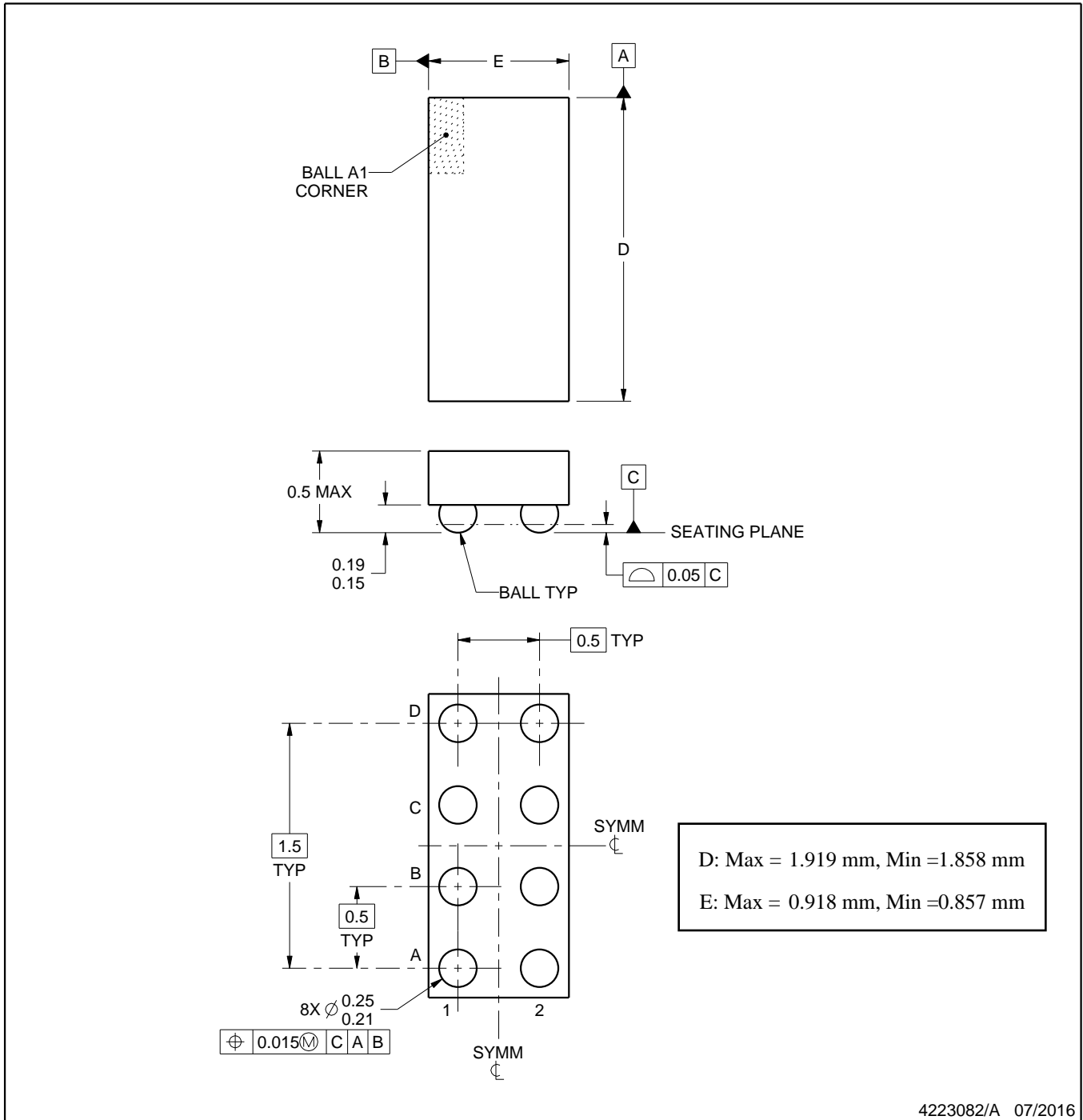

4223082/A 07/2016

NOTES:

1. All linear dimensions are in millimeters. Any dimensions in parenthesis are for reference only. Dimensioning and tolerancing per ASME Y14.5M.
2. This drawing is subject to change without notice.

# EXAMPLE BOARD LAYOUT

YZP0008

DSBGA - 0.5 mm max height

DIE SIZE BALL GRID ARRAY

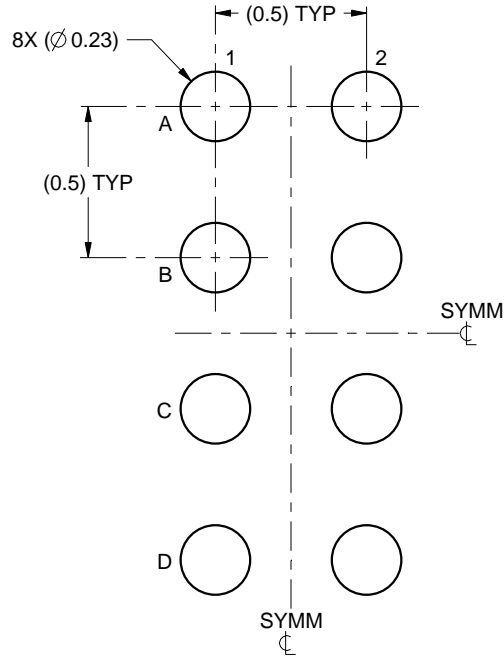

LAND PATTERN EXAMPLE  
SCALE:40X

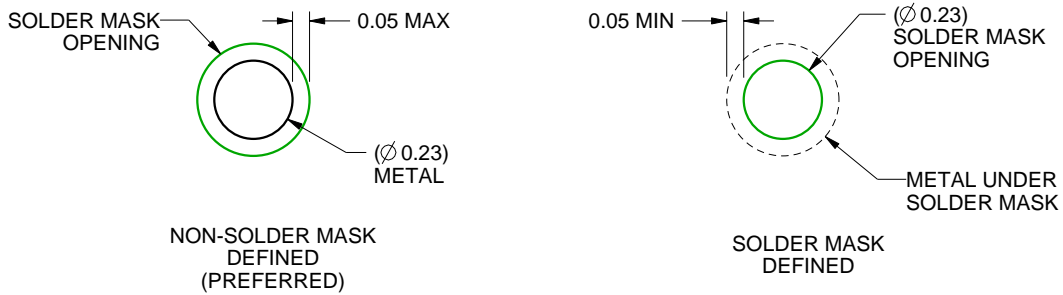

SOLDER MASK DETAILS  
NOT TO SCALE

4223082/A 07/2016

NOTES: (continued)

3. Final dimensions may vary due to manufacturing tolerance considerations and also routing constraints. For more information, see Texas Instruments literature number SNVA009 ([www.ti.com/lit/snva009](http://www.ti.com/lit/snva009)).



# EXAMPLE STENCIL DESIGN

YZP0008

DSBGA - 0.5 mm max height

DIE SIZE BALL GRID ARRAY

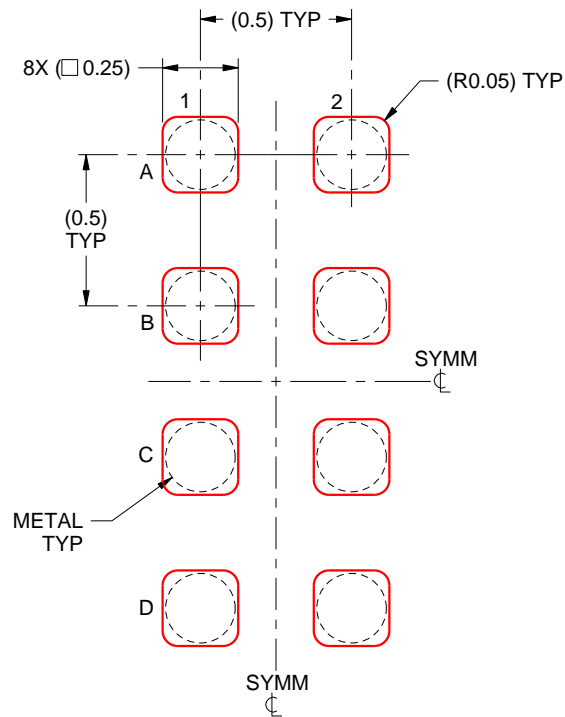

SOLDER PASTE EXAMPLE  
BASED ON 0.1 mm THICK STENCIL  
SCALE:40X

4223082/A 07/2016

NOTES: (continued)

4. Laser cutting apertures with trapezoidal walls and rounded corners may offer better paste release.

## IMPORTANT NOTICE AND DISCLAIMER

TI PROVIDES TECHNICAL AND RELIABILITY DATA (INCLUDING DATA SHEETS), DESIGN RESOURCES (INCLUDING REFERENCE DESIGNS), APPLICATION OR OTHER DESIGN ADVICE, WEB TOOLS, SAFETY INFORMATION, AND OTHER RESOURCES "AS IS" AND WITH ALL FAULTS, AND DISCLAIMS ALL WARRANTIES, EXPRESS AND IMPLIED, INCLUDING WITHOUT LIMITATION ANY IMPLIED WARRANTIES OF MERCHANTABILITY, FITNESS FOR A PARTICULAR PURPOSE OR NON-INFRINGEMENT OF THIRD PARTY INTELLECTUAL PROPERTY RIGHTS.

These resources are intended for skilled developers designing with TI products. You are solely responsible for (1) selecting the appropriate TI products for your application, (2) designing, validating and testing your application, and (3) ensuring your application meets applicable standards, and any other safety, security, regulatory or other requirements.

These resources are subject to change without notice. TI grants you permission to use these resources only for development of an application that uses the TI products described in the resource. Other reproduction and display of these resources is prohibited. No license is granted to any other TI intellectual property right or to any third party intellectual property right. TI disclaims responsibility for, and you will fully indemnify TI and its representatives against, any claims, damages, costs, losses, and liabilities arising out of your use of these resources.

TI's products are provided subject to [TI's Terms of Sale](#) or other applicable terms available either on [ti.com](https://www.ti.com) or provided in conjunction with such TI products. TI's provision of these resources does not expand or otherwise alter TI's applicable warranties or warranty disclaimers for TI products.

TI objects to and rejects any additional or different terms you may have proposed.

Mailing Address: Texas Instruments, Post Office Box 655303, Dallas, Texas 75265  
Copyright © 2024, Texas Instruments Incorporated