

TL331B-Q1, TL391B-Q1 and TL331-Q1 Automotive Single Comparators

1 Features

- Qualified for automotive applications
- AEC-Q100 qualified with the following results:
 - Device temperature grade 0: –40°C to 150°C ambient operating temperature range (E version)
 - Device temperature grade 1: –40°C to 125°C ambient operating temperature range (B and Q versions)
 - Device temperature grade 3: –40°C to 85°C ambient operating temperature range (I version)
 - Device HBM ESD classification level 2
 - Device CDM ESD classification level C5
- NEW [TL331B-Q1](#) and [TL391B-Q1](#)
- Wide range of supply voltage, 2V to 36V
- Low supply-current drain independent of supply voltage:
0.43mA Typ (B version)
- Low input bias current, 3.5nA typ (B version)
- Low input offset voltage, 0.37mV typ (B Version)
- Differential input voltage range equal to maximum-rated supply voltage, ±36V
- Input range includes ground
- [TL391B-Q1](#) provides an [alternate pinout](#)
- Output compatible With TTL, MOS and CMOS

2 Applications

- [Automotive](#)
- [HEV/EV and power train](#)
- [Infotainment and cluster](#)
- [Body control module](#)

3 Description

The [TL331B-Q1](#) and [TL391B-Q1](#) devices are the next generation versions of the industry-standard TL331-Q1 comparator. These next generation devices provide outstanding value for cost-sensitive applications, with features including lower offset voltage, higher supply voltage capability, lower supply current, lower input bias current, lower propagation delay, dedicated ESD protection cells with improved negative input voltage handling. The TL331B-Q1 can drop-in replace both the TL331-Q1 "I" and "Q" versions. The [TL391B-Q1](#) provides an [alternate pinout](#) of the TL331B-Q1. The TL331E-Q1 extends the temp range up to 150°C, meeting AEC-Q100 Grade 0 temperature requirements.

This device consists of a single voltage comparator designed to operate from a single power supply over a wide range of voltages. Operation from dual supplies also is possible if the difference between the two supplies is 2V to 36V and V_{CC} is at least 1.5V more positive than the input common-mode voltage. Current drain is independent of the supply voltage. To achieve wired-AND relationships, one can connect the output to other open-collector outputs.

Device Information

PART NUMBER	PACKAGE (1)	BODY SIZE (NOM)
TL331B-Q1, TL391B-Q1, TL331-Q1, TL331E-Q1	SOT-23 (5)	2.90mm × 1.60mm

(1) For all available packages, see the orderable addendum at the end of the data sheet.

Family Comparison Table

Specification	TL331B-Q1 TL391B-Q1	TL331I-Q1	TL331Q-Q1	TL331E-Q1	Units
Supply Voltage	2 to 36	2 to 36	2 to 36	2 to 36	V
Total Supply Current (5V to 36V max)	0.43	0.7	0.7	0.7	mA
Temperature Range	–40 to 125	–40 to 85	–40 to 125	–40 to 150	°C
ESD (HBM)	2000	2000	2000	2000	V
Offset Voltage (Max over temp)	± 4	± 9	± 9	± 9	mV
Input Bias Current (typ / max)	3.5 / 25	25 / 250	25 / 250	25 / 250	nA
Response Time (typ)	1	1.3	1.3	1.3	µsec



Table of Contents

1 Features	1	5.11 Typical Characteristics.....	8
2 Applications	1	6 Detailed Description	14
3 Description	1	6.1 Overview.....	14
4 Pin Configuration and Functions	3	6.2 Functional Block Diagram.....	14
5 Specifications	4	6.3 Feature Description.....	14
5.1 Absolute Maximum Ratings, TL331-Q1, TL331E-Q1.....	4	6.4 Device Functional Modes.....	14
5.2 Absolute Maximum Ratings, TL331B-Q1 and TL391B-Q1.....	4	7 Application and Implementation	15
5.3 ESD Ratings, All Devices.....	4	7.1 Application Information.....	15
5.4 Recommended Operating Conditions, TL331- Q1, TL331E-Q1.....	5	7.2 Typical Application.....	15
5.5 Recommended Operating Conditions, TL331B- Q1 and TL391B-Q1.....	5	7.3 Power Supply Recommendations.....	17
5.6 Thermal Information.....	5	7.4 Layout.....	17
5.7 Electrical Characteristics, TL331B-Q1 and TL391B-Q1.....	6	8 Device and Documentation Support	18
5.8 Switching Characteristics, TL331B-Q1 and TL391B-Q1.....	6	8.1 Documentation Support.....	18
5.9 Electrical Characteristics, TL331-Q1, TL331E-Q1.....	7	8.2 Receiving Notification of Documentation Updates....	18
5.10 Switching Characteristics, TL331-Q1, TL331E- Q1.....	7	8.3 Support Resources.....	18
		8.4 Trademarks.....	18
		8.5 Electrostatic Discharge Caution.....	18
		8.6 Glossary.....	18
		9 Revision History	19
		10 Mechanical, Packaging, and Orderable Information	19

4 Pin Configuration and Functions



Note reversed inputs compared to similar popular pinout

**Figure 4-1. TL331-Q1, TL331B-Q1 DBV Package
5-Pin SOT-23
Top View**

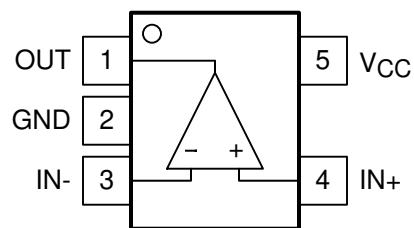

Note reversed inputs compared to similar popular pinout

**Figure 4-2. TL391B-Q1 DBV Package
5-Pin SOT-23
Top View**

Table 4-1. Pin Functions

NAME	PIN		TYPE	DESCRIPTION
	TL331-Q1, TL331B-Q1 NO.	TL391B-Q1 NO.		
IN+	3	4	I	Positive Input
IN-	1	3	I	Negative Input
OUT	4	1	O	Open Collector/Drain Output
V _{CC}	5	5	—	Power Supply Input
GND	2	2	—	Ground

5 Specifications

5.1 Absolute Maximum Ratings, TL331-Q1, TL331E-Q1

over operating free-air temperature range (unless otherwise noted)⁽¹⁾

	MIN	MAX	UNIT
V _{CC} Supply voltage ⁽²⁾	0	36	V
V _{ID} Differential input voltage ⁽³⁾	-36	36	V
V _I Input voltage range (either input)	-0.3	36	V
V _O Output voltage	0	36	V
I _O Output current	0	20	mA
Duration of output short-circuit to ground ⁽⁴⁾	Unlimited		
T _J Operating virtual junction temperature	150		°C
T _{stg} Storage temperature	-65	150	°C

- (1) Stresses beyond those listed under *Absolute Maximum Ratings* can cause permanent damage to the device. These are stress ratings only, which do not imply functional operation of the device at these or any other conditions beyond those indicated under *Recommended Operating Conditions*. Exposure to absolute-maximum-rated conditions for extended periods can affect device reliability.
- (2) All voltage values, except differential voltages, are with respect to the network ground.
- (3) Differential voltages are at IN+ with respect to IN-.
- (4) Short circuits from outputs to V_{CC} can cause excessive heating and eventual destruction.

5.2 Absolute Maximum Ratings, TL331B-Q1 and TL391B-Q1

over operating free-air temperature range (unless otherwise noted)⁽¹⁾

	MIN	MAX	UNIT
V _{CC} Supply voltage ⁽²⁾	-0.3	38	V
V _{ID} Differential input voltage ⁽³⁾	-38	38	V
V _I Input voltage range (either input)	-0.3	38	V
V _O Output voltage	-0.3	38	V
I _O Output current		20	mA
Duration of output short-circuit to ground ⁽⁴⁾	Unlimited		
I _{IK} Input current ⁽⁵⁾		-50	mA
T _J Operating virtual junction temperature	-40	150	°C
T _{stg} Storage temperature	-65	150	°C

- (1) Stresses beyond those listed under *Absolute Maximum Ratings* can cause permanent damage to the device. These are stress ratings only, which do not imply functional operation of the device at these or any other conditions beyond those indicated under *Recommended Operating Conditions*. Exposure to absolute-maximum-rated conditions for extended periods can affect device reliability.
- (2) All voltage values, except differential voltages, are with respect to the network ground.
- (3) Differential voltages are at IN+ with respect to IN-.
- (4) Short circuits from outputs to V_{CC} can cause excessive heating and eventual destruction.
- (5) Input current flows thorough parasitic diode to ground and can turn on parasitic transistors that can increase ICC and can cause output to be incorrect. Normal operation resumes when input current is removed.

5.3 ESD Ratings, All Devices

	VALUE	UNIT
V _(ESD) Electrostatic discharge	Human-body model (HBM), per AEC Q100-002 ⁽¹⁾	±2000
	Charged-device model (CDM), per AEC Q100-0111	±750

- (1) AEC Q100-002 indicates that HBM stressing shall be in accordance with the ANSI/ESDA/JEDEC JS-001 specification.

5.4 Recommended Operating Conditions, TL331-Q1, TL331E-Q1

over operating free-air temperature range (unless otherwise noted)

		MIN	MAX	UNIT
V _{CC}	Supply voltage	2	36	V
T _J	Junction temperature, TL331IDBVRQ1	-40	85	°C
T _J	Junction temperature, TL331QDBVRQ1	-40	125	°C
T _J	Junction temperature, TL331EDBVRQ1	-40	150	°C

5.5 Recommended Operating Conditions, TL331B-Q1 and TL391B-Q1

over operating free-air temperature range (unless otherwise noted)

		MIN	MAX	UNIT
V _{CC}	Supply voltage	2	36	V
T _J	Junction temperature	-40	125	°C

5.6 Thermal Information

THERMAL METRIC ⁽¹⁾		TL331x-Q1, TL391B-Q1	UNIT
		DBV (SOT-23)	
		5 PINS	
R _{θJA}	Junction-to-ambient thermal resistance	211.7	°C/W
R _{θJC(top)}	Junction-to-case (top) thermal resistance	133.6	°C/W
R _{θJB}	Junction-to-board thermal resistance	79.9	°C/W
ψ _{JT}	Junction-to-top characterization parameter	56.4	°C/W
ψ _{JB}	Junction-to-board characterization parameter	79.6	°C/W

(1) For more information about traditional and new thermal metrics, see the [Semiconductor and IC Package Thermal Metrics](#) report.

5.7 Electrical Characteristics, TL331B-Q1 and TL391B-Q1

$V_S = 5V$, $V_{CM} = (V-)$; $T_A = 25^\circ C$ (unless otherwise noted).

PARAMETER		TEST CONDITIONS	MIN	TYP	MAX	UNIT
V_{IO}	Input offset voltage	$V_S = 5$ to $36V$	-2.5	± 0.37	2.5	mV
		$V_S = 5$ to $36V$, $T_A = -40^\circ C$ to $+125^\circ C$	-4		4	
I_B	Input bias current			-3.5	-25	nA
		$T_A = -40^\circ C$ to $+125^\circ C$			-50	nA
I_{OS}	Input offset current		-10	± 0.5	10	nA
		$T_A = -40^\circ C$ to $+125^\circ C$			-25	25
V_{CM}	Common mode range	$V_S = 3$ to $36V$	$(V-) - 0.1$		$(V+) - 1.5$	V
		$V_S = 3$ to $36V$, $T_A = -40^\circ C$ to $+125^\circ C$	$(V-) - 0.05$		$(V+) - 2.0$	V
A_{VD}	Large signal differential voltage amplification	$V_S = 15V$, $V_O = 1.4V$ to $11.4V$; $R_L \geq 15k$ to $(V+)$	50	200		V/mV
V_{OL}	Low level output Voltage {swing from $(V-)$ }	$I_{SINK} \leq 4mA$, $V_{ID} = -1V$		110	400	mV
		$I_{SINK} \leq 4mA$, $V_{ID} = -1V$ $T_A = -40^\circ C$ to $+125^\circ C$			550	mV
I_{OH-LKG}	High-level output leakage current	$(V+) = V_O = 5V$; $V_{ID} = 1V$		0.1	20	nA
I_{OH-LKG}	High-level output leakage current	$(V+) = V_O = 36V$; $V_{ID} = 1V$; $T_A = -40^\circ C$ to $+125^\circ C$			1000	nA
I_{OL}	Low level output current	$V_{OL} = 1.5V$; $V_{ID} = -1V$; $V_S = 5V$	6	18		mA
I_Q	Quiescent current	$V_S = 5V$, no load		210	330	μA
		$V_S = 36V$, no load, $T_A = -40^\circ C$ to $+125^\circ C$		275	430	μA

5.8 Switching Characteristics, TL331B-Q1 and TL391B-Q1

$V_S = 5V$, $V_{O_PULLUP} = 5V$, $V_{CM} = V_S/2$, $C_L = 15pF$, $R_L = 5.1k\ \Omega$, $T_A = 25^\circ C$ (unless otherwise noted).

PARAMETER		TEST CONDITIONS	MIN	TYP	MAX	UNIT
$t_{response}$	Propagation delay time, high-to-low; Small scale input signal ⁽¹⁾	Input overdrive = 5mV, Input step = 100mV		1000		ns
$t_{response}$	Propagation delay time, high-to-low; TTL input signal ⁽¹⁾	TTL input with $V_{ref} = 1.4V$		300		ns

(1) High-to-low and low-to-high refers to the transition at the input.

5.9 Electrical Characteristics, TL331-Q1, TL331E-Q1

at specified free-air temperature, $V_{CC} = 5V$ (unless otherwise noted)

PARAMETER		TEST CONDITIONS ⁽¹⁾	T_A	MIN	TYP	MAX	UNIT
V_{IO}	Input offset voltage	$V_{CC} = 5V$ to $30V$, $V_O = 1.4V$, $V_{IC} = V_{IC(min)}$	25°C		2	5	mV
			Over Temp			9	
I_{IO}	Input offset current	$V_O = 1.4V$	25°C		5	50	nA
			Over Temp			250	
I_{IB}	Input bias current	$V_O = 1.4V$	25°C		-25	-250	nA
			Over Temp			-400	
V_{ICR}	Common-mode input voltage range ⁽²⁾		25°C	0 to $V_{CC} - 1.5$		V	
			Over Temp	0 to $V_{CC} - 2$			
A_{VD}	Large-signal differential-voltage amplification	$V_{CC} = 15V$, $V_O = 1.4V$ to $11.4V$, $R_L \geq 15k\Omega$ to V_{CC}	25°C	50	200		V/mV
I_{OH}	High-level output current	$V_{OH} = 5V$, $V_{ID} = 1V$	25°C		0.1	50	nA
		$V_{OH} = 30V$, $V_{ID} = 1V$	Over Temp			1	μA
V_{OL}	Low-level output voltage	$I_{OL} = 4mA$, $V_{ID} = -1V$	25°C		150	400	mV
			Over Temp			700	
I_{OL}	Low-level output current	$V_{OL} = 1.5V$, $V_{ID} = -1V$	25°C	6			mA
I_{CC}	Supply current	$R_L = \infty$, $V_{CC} = 5V$	25°C		0.4	0.7	mA

(1) All characteristics are measured with zero common-mode input voltage, unless otherwise specified.

(2) The voltage at either input or common-mode can not be allowed to go negative by more than 0.3V. The upper end of the common-mode voltage range is $V_{CC+} - 1.5V$ at 25°C, but either or both inputs can go to 30V without damage.

5.10 Switching Characteristics, TL331-Q1, TL331E-Q1

$V_{CC} = 5V$, $T_A = 25^\circ C$

PARAMETER	TEST CONDITIONS		TYP	UNIT
Response time	R_L connected to 5V through 5.1k Ω , $C_L = 15pF$ ^{(1) (2)}	100mV input step with 5mV overdrive	1.3	μs
		TTL-level input step	0.3	

(1) C_L includes probe and jig capacitance.

(2) The response time specified is the interval between the input step function and the instant when the output crosses 1.4V.

5.11 Typical Characteristics

$T_A = 25^\circ\text{C}$, $V_S = 5\text{V}$, $R_{\text{PULLUP}} = 5.1\text{k}$, $C_L = 15\text{pF}$, $V_{\text{CM}} = 0\text{V}$, $V_{\text{UNDERDRIVE}} = 100\text{mV}$, $V_{\text{OVERDRIVE}} = 100\text{mV}$ unless otherwise noted.

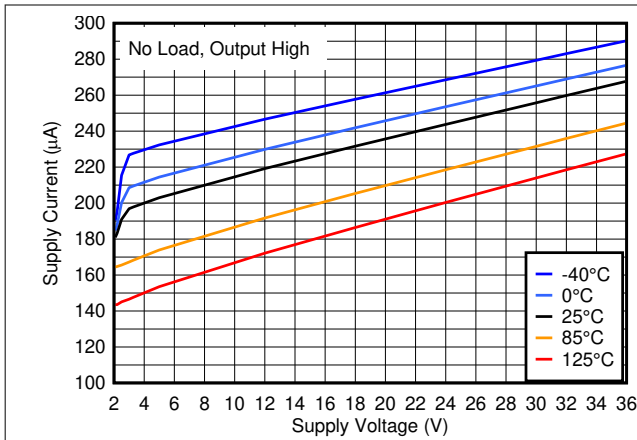

Figure 5-1. Supply Current vs. Supply Voltage

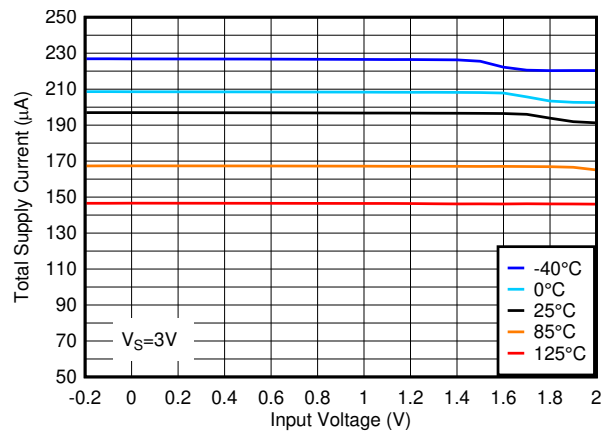

Figure 5-2. Total Supply Current vs. Input Voltage at 3V

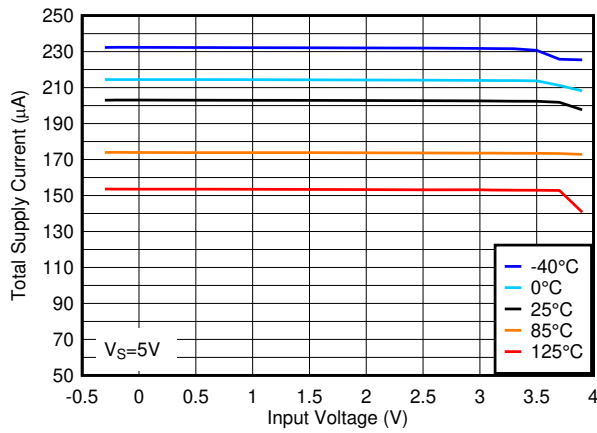

Figure 5-3. Total Supply Current vs. Input Voltage at 3.3V

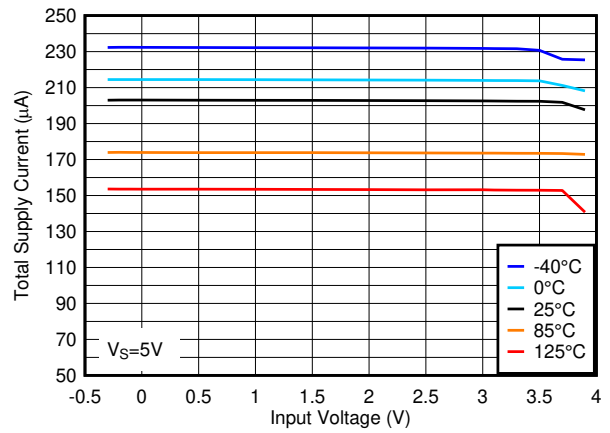

Figure 5-4. Total Supply Current vs. Input Voltage at 5V

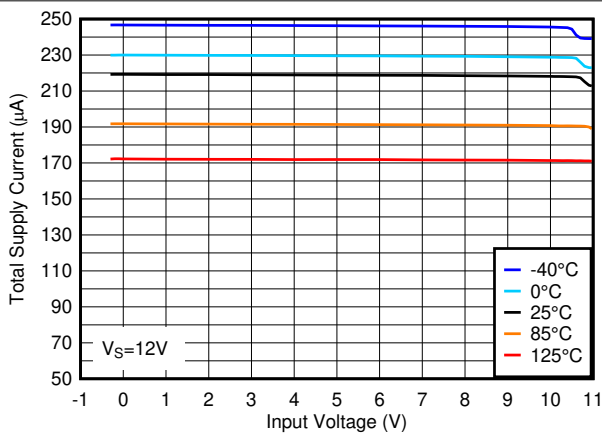

Figure 5-5. Total Supply Current vs. Input Voltage at 12V

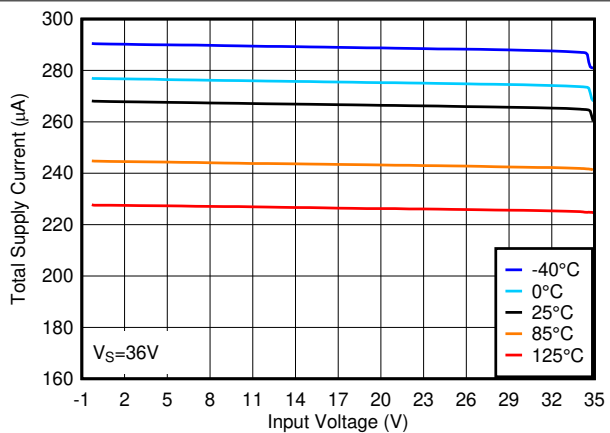

Figure 5-6. Total Supply Current vs. Input Voltage at 36V

5.11 Typical Characteristics (continued)

$T_A = 25^\circ\text{C}$, $V_S = 5\text{V}$, $R_{\text{PULLUP}} = 5.1\text{k}$, $C_L = 15\text{pF}$, $V_{\text{CM}} = 0\text{V}$, $V_{\text{UNDERDRIVE}} = 100\text{mV}$, $V_{\text{OVERDRIVE}} = 100\text{mV}$ unless otherwise noted.



Figure 5-7. Input Bias Current vs. Supply Voltage



Figure 5-8. Input Bias Current vs. Input Voltage at 5V



Figure 5-9. Input Bias Current vs. Input Voltage at 12V



Figure 5-10. Input Bias Current vs. Input Voltage at 36V

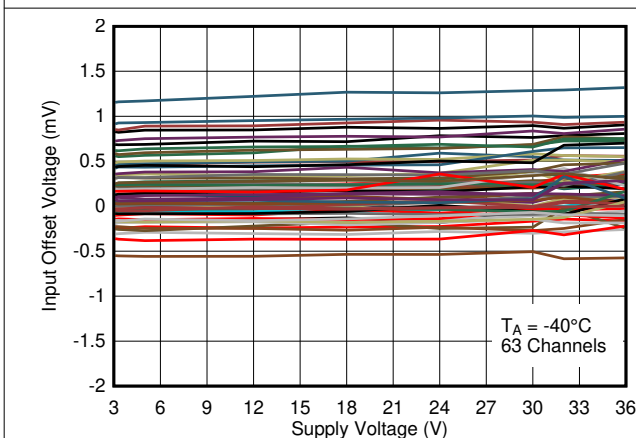

Figure 5-11. Input Offset Voltage vs. Supply Voltage at -40°C

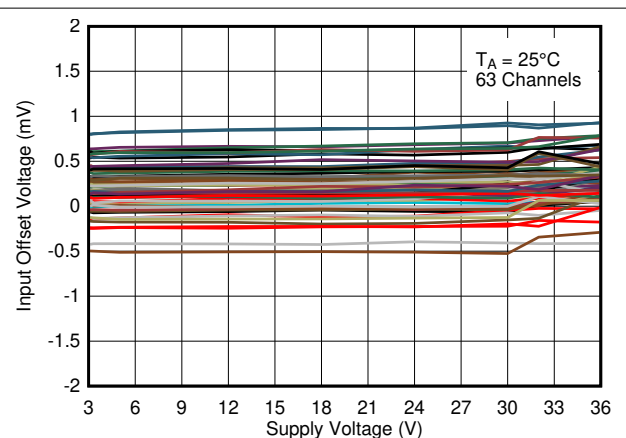

Figure 5-12. Input Offset Voltage vs. Supply Voltage at 25°C

5.11 Typical Characteristics (continued)

$T_A = 25^\circ\text{C}$, $V_S = 5\text{V}$, $R_{\text{PULLUP}} = 5.1\text{k}$, $C_L = 15\text{pF}$, $V_{\text{CM}} = 0\text{V}$, $V_{\text{UNDERDRIVE}} = 100\text{mV}$, $V_{\text{OVERDRIVE}} = 100\text{mV}$ unless otherwise noted.

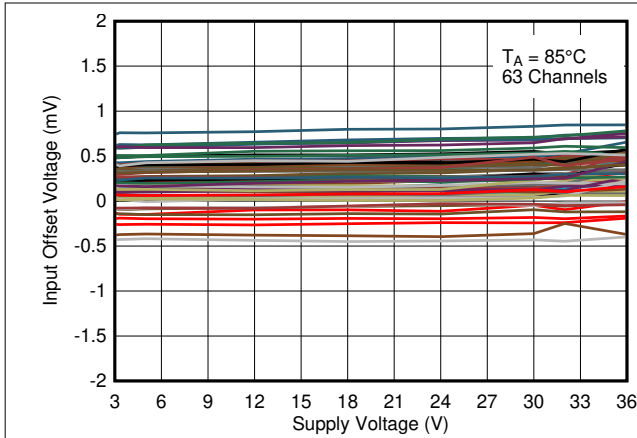

Figure 5-13. Input Offset Voltage vs. Supply Voltage at 85°C

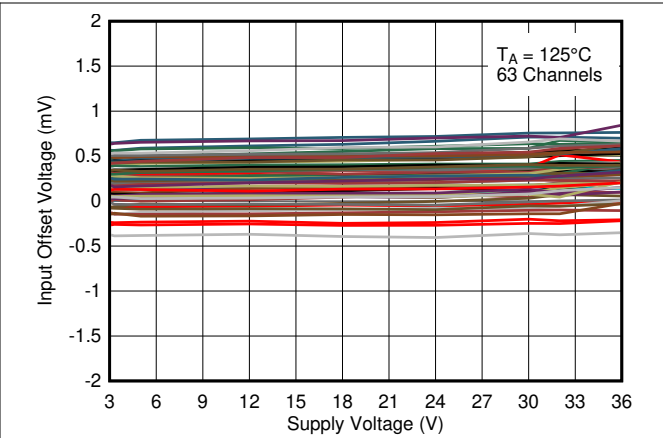

Figure 5-14. Input Offset Voltage vs. Supply Voltage at 125°C

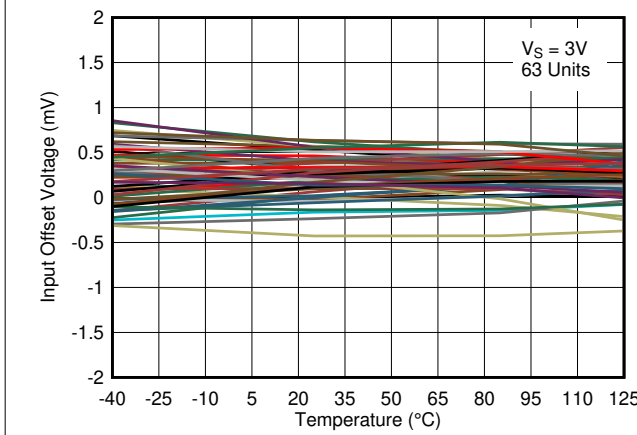

Figure 5-15. Input Offset Voltage vs. Temperature at 3V

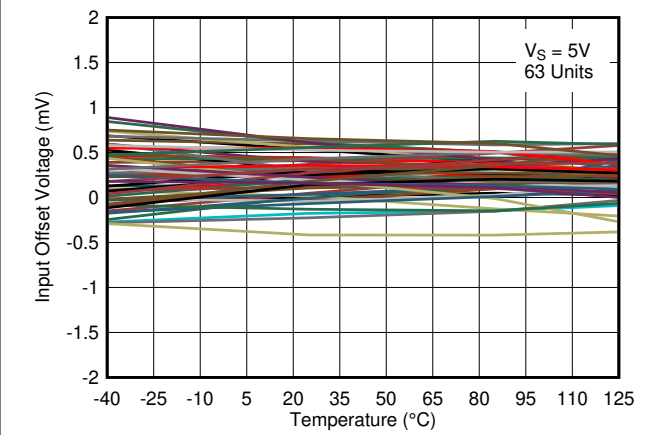

Figure 5-16. Input Offset Voltage vs. Temperature at 5V

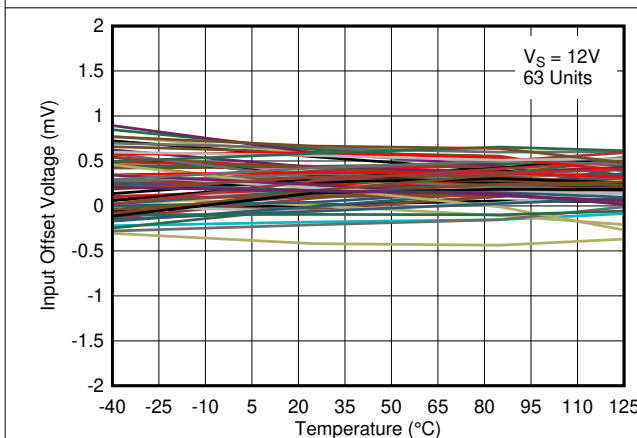

Figure 5-17. Input Offset Voltage vs. Temperature at 12V

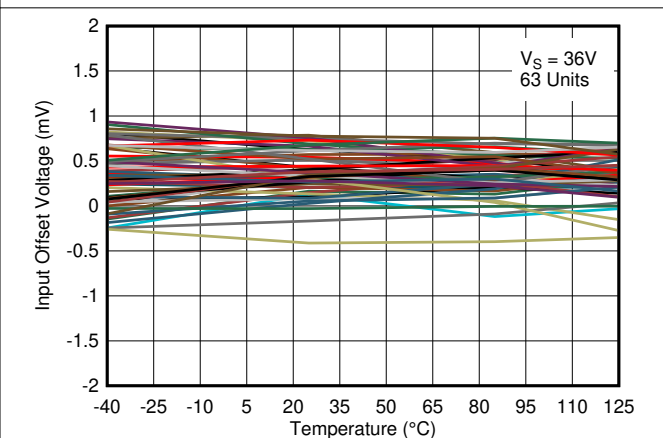

Figure 5-18. Input Offset Voltage vs. Temperature at 36V

5.11 Typical Characteristics (continued)

$T_A = 25^\circ\text{C}$, $V_S = 5\text{V}$, $R_{\text{PULLUP}} = 5.1\text{k}$, $C_L = 15\text{pF}$, $V_{\text{CM}} = 0\text{V}$, $V_{\text{UNDERDRIVE}} = 100\text{mV}$, $V_{\text{OVERDRIVE}} = 100\text{mV}$ unless otherwise noted.



Figure 5-19. Output Low Voltage vs. Output Sinking Current at 3V



Figure 5-20. Output Low Voltage vs. Output Sinking Current at 5V



Figure 5-21. Output Low Voltage vs. Output Sinking Current at 12V



Figure 5-22. Output Low Voltage vs. Output Sinking Current at 36V



Figure 5-23. Output High Leakage Current vs. Temperature at 5V



Figure 5-24. Output High Leakage Current vs. Temperature at 36V

5.11 Typical Characteristics (continued)

$T_A = 25^\circ\text{C}$, $V_S = 5\text{V}$, $R_{\text{PULLUP}} = 5.1\text{k}$, $C_L = 15\text{pF}$, $V_{\text{CM}} = 0\text{V}$, $V_{\text{UNDERDRIVE}} = 100\text{mV}$, $V_{\text{OVERDRIVE}} = 100\text{mV}$ unless otherwise noted.

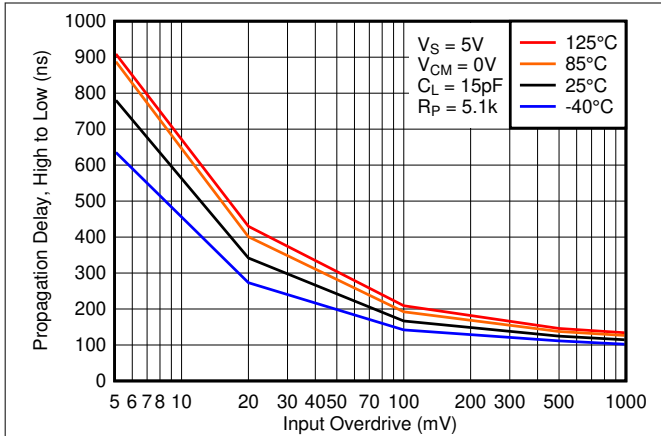

Figure 5-25. High to Low Propagation Delay vs. Input Overdrive Voltage, 5V

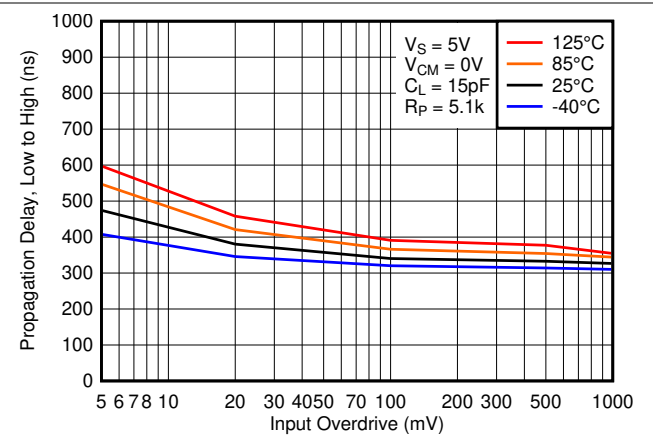

Figure 5-26. Low to High Propagation Delay vs. Input Overdrive Voltage, 5V

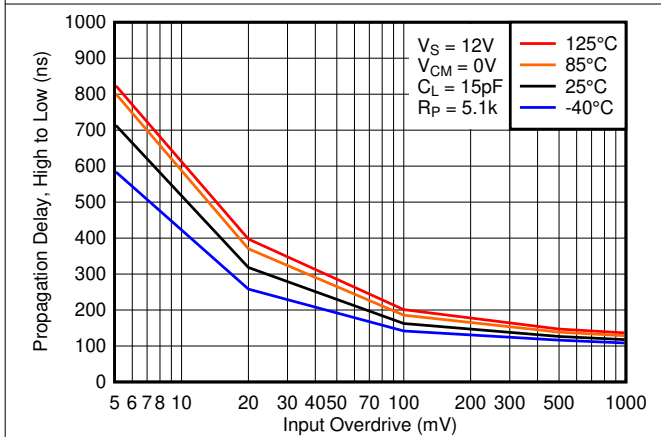

Figure 5-27. High to Low Propagation Delay vs. Input Overdrive Voltage, 12V



Figure 5-28. Low to High Propagation Delay vs. Input Overdrive Voltage, 12V

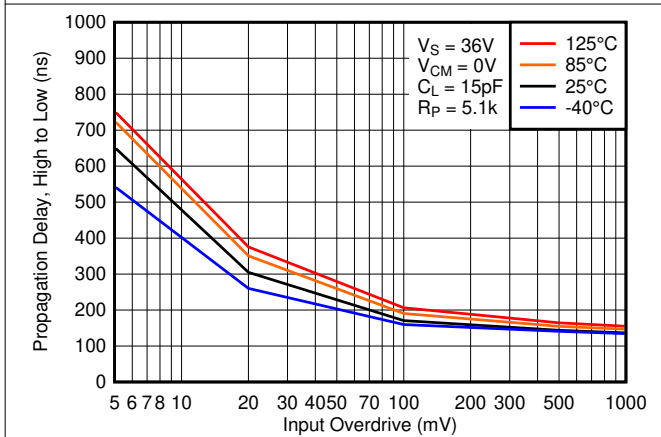

Figure 5-29. High to Low Propagation Delay vs. Input Overdrive Voltage, 36V



Figure 5-30. Low to High Propagation Delay vs. Input Overdrive Voltage, 36V

5.11 Typical Characteristics (continued)

$T_A = 25^\circ\text{C}$, $V_S = 5\text{V}$, $R_{\text{PULLUP}} = 5.1\text{k}$, $C_L = 15\text{pF}$, $V_{\text{CM}} = 0\text{V}$, $V_{\text{UNDERDRIVE}} = 100\text{mV}$, $V_{\text{OVERDRIVE}} = 100\text{mV}$ unless otherwise noted.

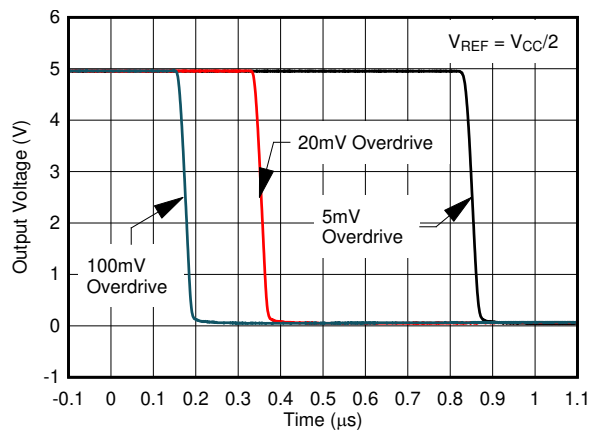

Figure 5-31. Response Time for Various Overdrives, High-to-Low Transition

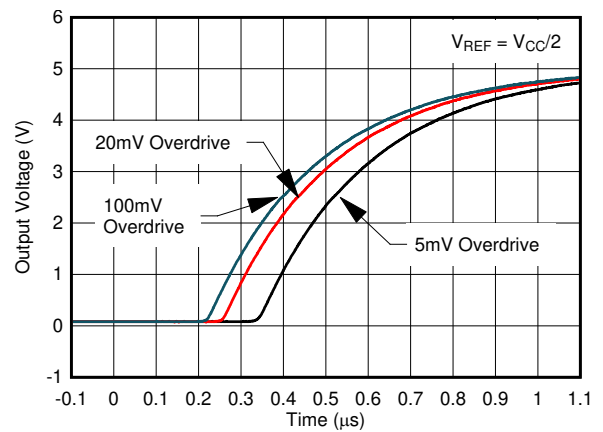

Figure 5-32. Response Time for Various Overdrives, Low-to-High Transition

6 Detailed Description

6.1 Overview

The TL331-Q1 is a single comparator with the ability to operate up to 36V on the supply pin. This standard device has proven ubiquity and versatility across a wide range of applications. This is due to the very wide supply voltage range (2V to 36V), low I_q , and fast response.

The open-collector output allows the user to configure the output's logic low voltage (V_{OL}) and can be utilized to enable the comparator to be used in AND functionality.

The TL331B-Q1 and TL391B-Q1 are performance upgrades to industry standard TL331-Q1 using the latest semiconductor process technologies that allows for lower offset voltages, lower input bias and supply currents and faster response times. The TL331B can drop-in replace the "I" or "Q" versions of TL331-Q1. The TL391B-Q1 is an alternate pinout of the TL331B-Q1 for replacing competitive devices.

6.2 Functional Block Diagram

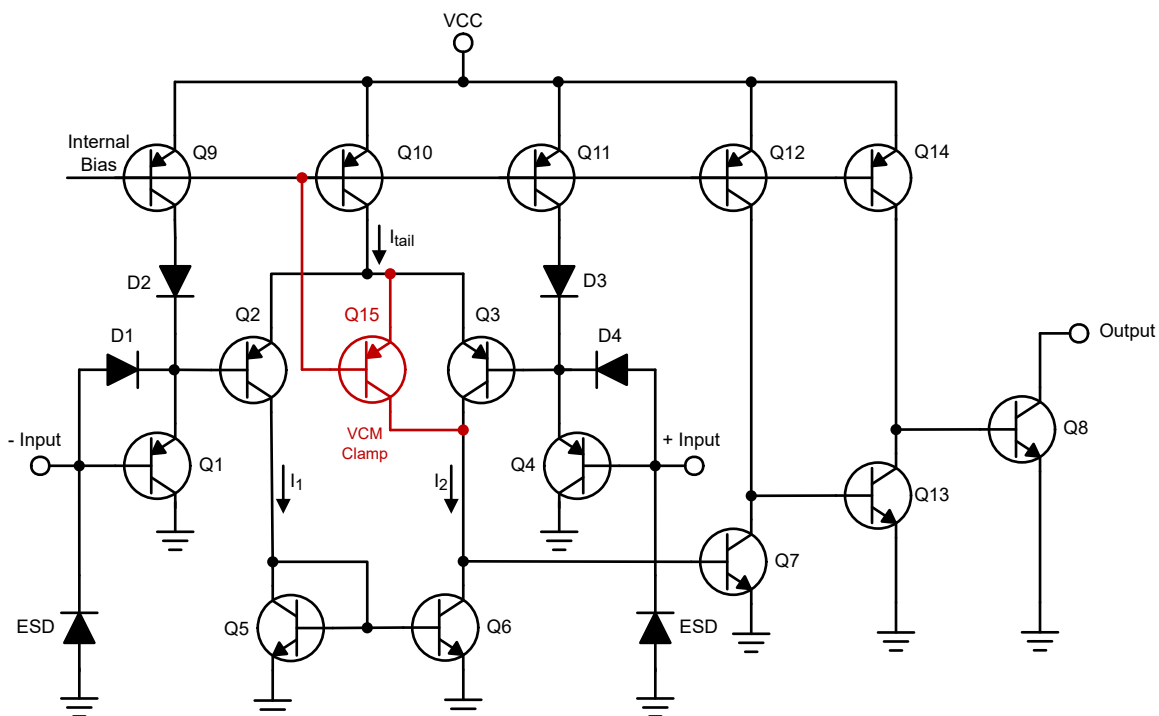

6.3 Feature Description

The TL331-Q1 consists of a PNP Darlington pair input, allowing the device to operate with very high gain and fast response with minimal input bias current. The input Darlington pair creates a limit on the input common mode voltage capability, allowing TL331-Q1 to accurately function from ground to $V_{CC} - 1.5V$ differential input. A clamp (Q15) was added around Q3 to force the output low when both inputs are taken above the VCM range.

The output consists of an open collector NPN (pull-down or low side) transistor. The output NPN sinks current when the negative input voltage is higher than the positive input voltage and the offset voltage. The V_{OL} is resistive and scales with the output current. Please see [Output Low Voltage vs. Output Sinking Current at 5V](#) for V_{OL} values with respect to the output current.

6.4 Device Functional Modes

6.4.1 Voltage Comparison

The TL331-Q1 operates solely as a voltage comparator, comparing the differential voltage between the positive and negative pins and outputting a logic low or high impedance (logic high with pull-up) based on the input differential polarity.

7 Application and Implementation

Note

Information in the following applications sections is not part of the TI component specification, and TI does not warrant its accuracy or completeness. TI's customers are responsible for determining suitability of components for their purposes, as well as validating and testing their design implementation to confirm system functionality.

7.1 Application Information

TL331-Q1 is typically used to compare a single signal to a reference or two signals against each other. Many users take advantage of the open collector output to drive the comparison logic output to a logic voltage level to an MCU or logic device. The wide supply range and high voltage capability makes TL331-Q1 an excellent choice for level shifting to a higher or lower voltage.

7.2 Typical Application

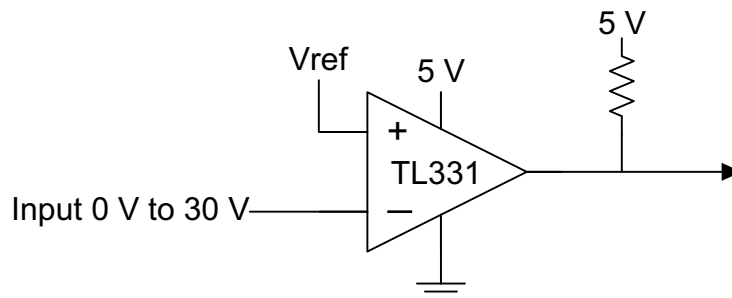

Figure 7-1. Typical Application Schematic

7.2.1 Design Requirements

For this design example, use the parameters listed in [Table 7-1](#) as the input parameters.

Table 7-1. Design Parameters

DESIGN PARAMETER	EXAMPLE VALUE
Input Voltage Range	0V to $V_{CC} - 1.5V$
Supply Voltage	2V to 36V
Logic Supply Voltage (R_{PULLUP} Voltage)	2V to 36V
Output Current (V_{LOGIC}/R_{PULLUP})	1 μ A to 4mA
Input Overdrive Voltage	100mV
Reference Voltage	2.5V
Load Capacitance (C_L)	15pF

7.2.2 Detailed Design Procedure

When using TL331-Q1 in a general comparator application, determine the following:

- Input voltage range
- Minimum overdrive voltage
- Output and drive current
- Response time

7.2.2.1 Input Voltage Range

When choosing the input voltage range, the input common mode voltage range (V_{ICR}) must be taken in to account. If temperature operation is above or below 25°C the V_{ICR} can range from 0V to $V_{CC} - 1.5V$. This limits

the input voltage range to as high as $V_{CC} - 1.5V$ and as low as $0V$. Operation outside of this range can yield incorrect comparisons.

Below is a list of input voltage situation and the outcomes:

1. When both $IN-$ and $IN+$ are both within the common mode range:
 - a. If $IN-$ is higher than $IN+$ and the offset voltage, the output is low and the output transistor is sinking current
 - b. If $IN-$ is lower than $IN+$ and the offset voltage, the output is high impedance and the output transistor is not conducting
2. When $IN-$ is higher than common mode and $IN+$ is within common mode, the output is low and the output transistor is sinking current
3. When $IN+$ is higher than common mode and $IN-$ is within common mode, the output is high impedance and the output transistor is not conducting
4. When $IN-$ and $IN+$ are both higher than common mode, see Section 2 of [Application Design Guidelines for LM339, LM393, TL331 Family Comparators Including the New B-versions](#).

7.2.2.2 ESD Protection

The TL331x-Q1 family have dedicated ESD protection on all the pins for improved ESD performance as well as improved negative input voltage handling. Please see Application Note [SNOAA35](#) for more information.

7.2.2.3 Minimum Overdrive Voltage

Overdrive Voltage is the differential voltage produced between the positive and negative inputs of the comparator over the offset voltage (V_{IO}). To make an accurate comparison the Overdrive Voltage (V_{OD}) must exceed the input offset voltage (V_{IO}). Overdrive voltage can also determine the response time of the comparator, with the response time decreasing with increasing overdrive. [Figure 7-2](#) and [Figure 7-3](#) show positive and negative response times with respect to overdrive voltage.

7.2.2.4 Output and Drive Current

Output current is determined by the load/pull-up resistance and logic/pull-up voltage. The output current determines the output low voltage (V_{OL}) from the comparator. V_{OL} is proportional to the output current. Use [Output Low Voltage vs. Output Sinking Current at 5V](#) to determine V_{OL} based on the output current.

The output current can also effect the transient response. More is explained in the next section.

7.2.2.5 Response Time

Response time is a function of input over drive. See [Application Curves](#) for typical response times. The rise and fall times can be determined by the load capacitance (C_L), load/pullup resistance (R_{PULLUP}), and equivalent collector-emitter resistance (R_{CE}).

- The rise time (τ_R) is approximately $\tau_R = R_{PULLUP} \times C_L$
- The fall time (τ_F) is approximately $\tau_F = R_{CE} \times C_L$
 - R_{CE} can be determined by taking the slope of [Output Low Voltage vs. Output Sinking Current at 5V](#) in the linear region at the desired temperature, or by dividing the V_{OL} by I_{out}

7.2.3 Application Curves

The following curves were generated with 5V on V_{CC} and V_{Logic} , $R_{PULLUP} = 5.1k\Omega$, and 50pF scope probe.

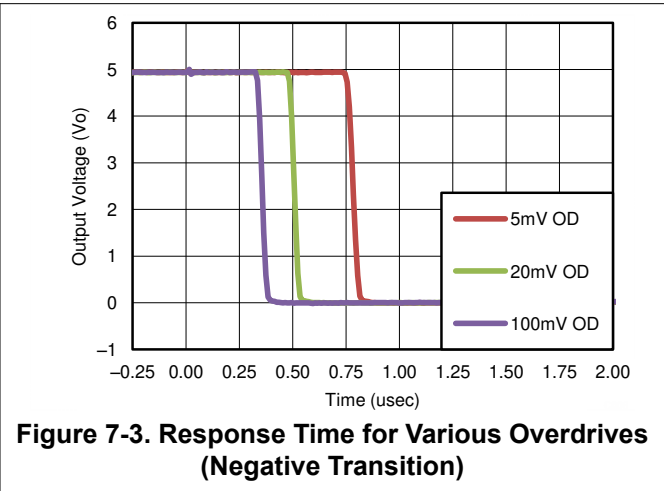
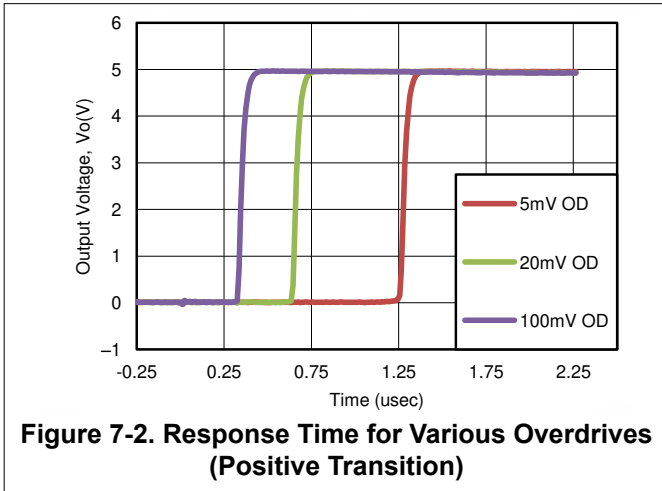

7.3 Power Supply Recommendations

For fast response and comparison applications with noisy or AC inputs, TI recommends using a bypass capacitor on the supply pin to reject any variation on the supply voltage. This variation can distort the comparator's input common mode range and create an inaccurate comparison.

7.4 Layout

7.4.1 Layout Guidelines

For accurate comparator applications without hysteresis, a stable supply is important to minimize noise and glitches, which can affect the high level input common mode voltage range. To achieve this, add a bypass capacitor between the supply voltage and ground. This must be implemented on the positive power supply and negative supply (if available). If a negative supply is not being used, tie the GND pin directly to system ground.

7.4.2 Layout Example

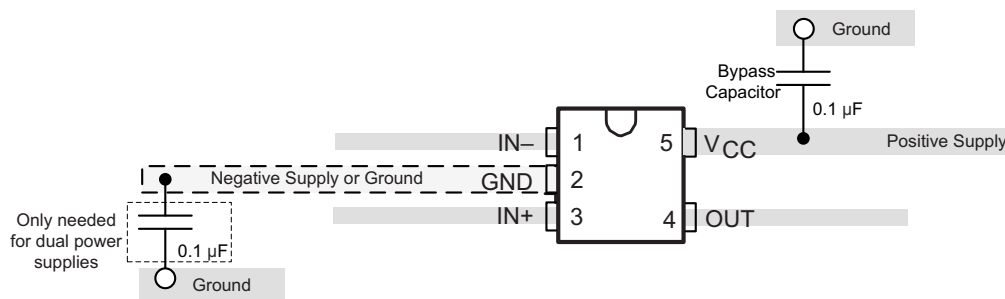

Figure 7-4. TL331-Q1 Layout Example

8 Device and Documentation Support

8.1 Documentation Support

8.1.1 Related Documentation

[Application Design Guidelines for LM339, LM393, TL331 Family Comparators](#) - SNOAA35

[Analog Engineers Circuit Cookbook: Amplifiers \(See Comparators section\)](#) - SLYY137

[Precision Design, Comparator with Hysteresis Reference Design](#)- TIDU020

[Window comparator circuit](#) - SBOA221

[Reference Design, Window Comparator Reference Design](#)- TIPD178

[Comparator with and without hysteresis circuit](#) - SBOA219

[Inverting comparator with hysteresis circuit](#) - SNOA997

[Non-Inverting Comparator With Hysteresis Circuit](#) - SBOA313

[Zero crossing detection using comparator circuit](#) - SNOA999

[A Quad of Independently Functioning Comparators](#) - SNOA654

8.2 Receiving Notification of Documentation Updates

To receive notification of documentation updates, navigate to the device product folder on ti.com. In the upper right corner, click on *Alert me* to register and receive a weekly digest of any product information that has changed. For change details, review the revision history included in any revised document.

8.3 Support Resources

TI E2E™ support forums are an engineer's go-to source for fast, verified answers and design help — straight from the experts. Search existing answers or ask your own question to get the quick design help you need.

Linked content is provided "AS IS" by the respective contributors. They do not constitute TI specifications and do not necessarily reflect TI's views; see TI's [Terms of Use](#).

8.4 Trademarks

TI E2E™ is a trademark of Texas Instruments.

All trademarks are the property of their respective owners.

8.5 Electrostatic Discharge Caution



This integrated circuit can be damaged by ESD. Texas Instruments recommends that all integrated circuits be handled with appropriate precautions. Failure to observe proper handling and installation procedures can cause damage.

ESD damage can range from subtle performance degradation to complete device failure. Precision integrated circuits may be more susceptible to damage because very small parametric changes could cause the device not to meet its published specifications.

8.6 Glossary

[TI Glossary](#) This glossary lists and explains terms, acronyms, and definitions.

9 Revision History

NOTE: Page numbers for previous revisions may differ from page numbers in the current version.

Changes from Revision G (August 2023) to Revision H (January 2025)	Page
• Added TL331E-Q1 throughout.....	1
• Removed Legacy device graphs.....	8
• Updated <i>Functional Block Diagram</i>	14
• Added mention of VCM clamp.....	14
• Updated ESD Protection Section.....	16

Changes from Revision F (January 2021) to Revision G (August 2023)	Page
• Added reference to Application Note.....	15

Changes from Revision E (November 2020) to Revision F (January 2021)	Page
• Corrected front page link text to add missing "B".....	1

Changes from Revision D (June 2020) to Revision E (November 2020)	Page
• Updated the numbering format for tables, figures, and cross-references throughout the document.....	1
• Changed TL331B-Q1 and TL391B-Q1 minimum recommended supply voltage to 2V throughout data sheet..	1
• Corrected supply voltages for all devices in Family Comparison Table.....	1
• Added TL331B-Q1 and TLV391B-Q1 Typical Graphs.....	8

Changes from Revision C (October 2013) to Revision D (June 2020)	Page
• Added B device. Updated to current TI data sheet format. Modified front page text to highlight B version.....	1
• Added Family Comparison Table.....	1
• Added Links to Family Table	1

Changes from Revision B (September 2012) to Revision C (October 2013)	Page
• Changed V_{ICR} in the Electrical Characteristics.....	7
• Changed test conditions of I_{OL} in the Electrical Characteristics.....	7

Changes from Revision A (July 2010) to Revision B (September 2012)	Page
• Changed V_{ICR} in the Electrical Characteristics.....	7

10 Mechanical, Packaging, and Orderable Information

The following pages include mechanical, packaging, and orderable information. This information is the most current data available for the designated devices. This data is subject to change without notice and revision of this document. For browser-based versions of this data sheet, refer to the left-hand navigation.

PACKAGING INFORMATION

Orderable part number	Status (1)	Material type (2)	Package Pins	Package qty Carrier	RoHS (3)	Lead finish/ Ball material (4)	MSL rating/ Peak reflow (5)	Op temp (°C)	Part marking (6)
TL331BQDBVRQ1	Active	Production	SOT-23 (DBV) 5	3000 LARGE T&R	Yes	NIPDAU	Level-1-260C-UNLIM	-40 to 125	31BQ
TL331BQDBVRQ1.B	Active	Production	SOT-23 (DBV) 5	3000 LARGE T&R	Yes	NIPDAU	Level-1-260C-UNLIM	-40 to 125	31BQ
TL331EDBVRQ1	Active	Production	SOT-23 (DBV) 5	3000 LARGE T&R	Yes	NIPDAU	Level-1-260C-UNLIM	-40 to 150	3ISF
TL331EDBVRQ1.A	Active	Production	SOT-23 (DBV) 5	3000 LARGE T&R	Yes	NIPDAU	Level-1-260C-UNLIM	-40 to 150	3ISF
TL331IDBVRQ1	Active	Production	SOT-23 (DBV) 5	3000 LARGE T&R	Yes	NIPDAU SN	Level-1-260C-UNLIM	-40 to 85	TQ1U
TL331IDBVRQ1.A	Active	Production	SOT-23 (DBV) 5	3000 LARGE T&R	Yes	NIPDAU	Level-1-260C-UNLIM	-40 to 85	TQ1U
TL331IDBVRQ1.B	Active	Production	SOT-23 (DBV) 5	3000 LARGE T&R	Yes	NIPDAU	Level-1-260C-UNLIM	-40 to 85	TQ1U
TL331QDBVRQ1	Active	Production	SOT-23 (DBV) 5	3000 LARGE T&R	Yes	NIPDAU SN	Level-1-260C-UNLIM	-40 to 125	T1RU
TL331QDBVRQ1.A	Active	Production	SOT-23 (DBV) 5	3000 LARGE T&R	Yes	NIPDAU	Level-1-260C-UNLIM	-40 to 125	T1RU
TL331QDBVRQ1.B	Active	Production	SOT-23 (DBV) 5	3000 LARGE T&R	Yes	NIPDAU	Level-1-260C-UNLIM	-40 to 125	T1RU
TL391BQDBVRQ1	Active	Production	SOT-23 (DBV) 5	3000 LARGE T&R	Yes	NIPDAU	Level-1-260C-UNLIM	-40 to 125	91BQ
TL391BQDBVRQ1.B	Active	Production	SOT-23 (DBV) 5	3000 LARGE T&R	Yes	NIPDAU	Level-1-260C-UNLIM	-40 to 125	91BQ

(1) **Status:** For more details on status, see our [product life cycle](#).

(2) **Material type:** When designated, preproduction parts are prototypes/experimental devices, and are not yet approved or released for full production. Testing and final process, including without limitation quality assurance, reliability performance testing, and/or process qualification, may not yet be complete, and this item is subject to further changes or possible discontinuation. If available for ordering, purchases will be subject to an additional waiver at checkout, and are intended for early internal evaluation purposes only. These items are sold without warranties of any kind.

(3) **RoHS values:** Yes, No, RoHS Exempt. See the [TI RoHS Statement](#) for additional information and value definition.

(4) **Lead finish/Ball material:** Parts may have multiple material finish options. Finish options are separated by a vertical ruled line. Lead finish/Ball material values may wrap to two lines if the finish value exceeds the maximum column width.

(5) **MSL rating/Peak reflow:** The moisture sensitivity level ratings and peak solder (reflow) temperatures. In the event that a part has multiple moisture sensitivity ratings, only the lowest level per JEDEC standards is shown. Refer to the shipping label for the actual reflow temperature that will be used to mount the part to the printed circuit board.

(6) **Part marking:** There may be an additional marking, which relates to the logo, the lot trace code information, or the environmental category of the part.

Multiple part markings will be inside parentheses. Only one part marking contained in parentheses and separated by a "-" will appear on a part. If a line is indented then it is a continuation of the previous line and the two combined represent the entire part marking for that device.

Important Information and Disclaimer: The information provided on this page represents TI's knowledge and belief as of the date that it is provided. TI bases its knowledge and belief on information provided by third parties, and makes no representation or warranty as to the accuracy of such information. Efforts are underway to better integrate information from third parties. TI has taken and continues to take reasonable steps to provide representative and accurate information but may not have conducted destructive testing or chemical analysis on incoming materials and chemicals. TI and TI suppliers consider certain information to be proprietary, and thus CAS numbers and other limited information may not be available for release.

In no event shall TI's liability arising out of such information exceed the total purchase price of the TI part(s) at issue in this document sold by TI to Customer on an annual basis.

OTHER QUALIFIED VERSIONS OF TL331-Q1, TL331B-Q1, TL391B-Q1 :

- Catalog : [TL331](#), [TL331B](#), [TL391B](#)
- Enhanced Product : [TL331-EP](#)

NOTE: Qualified Version Definitions:

- Catalog - TI's standard catalog product
- Enhanced Product - Supports Defense, Aerospace and Medical Applications

TAPE AND REEL INFORMATION

QUADRANT ASSIGNMENTS FOR PIN 1 ORIENTATION IN TAPE

*All dimensions are nominal

Device	Package Type	Package Drawing	Pins	SPQ	Reel Diameter (mm)	Reel Width W1 (mm)	A0 (mm)	B0 (mm)	K0 (mm)	P1 (mm)	W (mm)	Pin1 Quadrant
TL331BQDBVRQ1	SOT-23	DBV	5	3000	180.0	8.4	3.2	3.2	1.4	4.0	8.0	Q3
TL331BQDBVRQ1	SOT-23	DBV	5	3000	180.0	8.4	3.2	3.2	1.4	4.0	8.0	Q3
TL331EDBVRQ1	SOT-23	DBV	5	3000	180.0	8.4	3.2	3.2	1.4	4.0	8.0	Q3
TL331IDBVRQ1	SOT-23	DBV	5	3000	180.0	8.4	3.2	3.2	1.4	4.0	8.0	Q3
TL331IDBVRQ1	SOT-23	DBV	5	3000	180.0	8.4	3.2	3.2	1.4	4.0	8.0	Q3
TL331IDBVRQ1	SOT-23	DBV	5	3000	180.0	8.4	3.2	3.2	1.4	4.0	8.0	Q3
TL331QDBVRQ1	SOT-23	DBV	5	3000	180.0	8.4	3.2	3.2	1.4	4.0	8.0	Q3
TL331QDBVRQ1	SOT-23	DBV	5	3000	180.0	8.4	3.2	3.2	1.4	4.0	8.0	Q3
TL331QDBVRQ1	SOT-23	DBV	5	3000	180.0	8.4	3.2	3.2	1.4	4.0	8.0	Q3
TL331QDBVRQ1	SOT-23	DBV	5	3000	180.0	8.4	3.2	3.2	1.4	4.0	8.0	Q3
TL391BQDBVRQ1	SOT-23	DBV	5	3000	180.0	8.4	3.2	3.2	1.4	4.0	8.0	Q3
TL391BQDBVRQ1	SOT-23	DBV	5	3000	180.0	8.4	3.2	3.2	1.4	4.0	8.0	Q3

TAPE AND REEL BOX DIMENSIONS

*All dimensions are nominal

Device	Package Type	Package Drawing	Pins	SPQ	Length (mm)	Width (mm)	Height (mm)
TL331BQDBVRQ1	SOT-23	DBV	5	3000	210.0	185.0	35.0
TL331BQDBVRQ1	SOT-23	DBV	5	3000	210.0	185.0	35.0
TL331EDBVRQ1	SOT-23	DBV	5	3000	210.0	185.0	35.0
TL331IDBVRQ1	SOT-23	DBV	5	3000	210.0	185.0	35.0
TL331IDBVRQ1	SOT-23	DBV	5	3000	210.0	185.0	35.0
TL331IDBVRQ1	SOT-23	DBV	5	3000	210.0	185.0	35.0
TL331QDBVRQ1	SOT-23	DBV	5	3000	210.0	185.0	35.0
TL331QDBVRQ1	SOT-23	DBV	5	3000	210.0	185.0	35.0
TL331QDBVRQ1	SOT-23	DBV	5	3000	210.0	185.0	35.0
TL391BQDBVRQ1	SOT-23	DBV	5	3000	210.0	185.0	35.0
TL391BQDBVRQ1	SOT-23	DBV	5	3000	210.0	185.0	35.0

EXAMPLE BOARD LAYOUT

DBV0005A

SOT-23 - 1.45 mm max height

SMALL OUTLINE TRANSISTOR



LAND PATTERN EXAMPLE
EXPOSED METAL SHOWN
SCALE:15X



SOLDER MASK DETAILS

4214839/K 08/2024

NOTES: (continued)

- 6. Publication IPC-7351 may have alternate designs.
- 7. Solder mask tolerances between and around signal pads can vary based on board fabrication site.

EXAMPLE STENCIL DESIGN

DBV0005A

SOT-23 - 1.45 mm max height

SMALL OUTLINE TRANSISTOR



SOLDER PASTE EXAMPLE
BASED ON 0.125 mm THICK STENCIL
SCALE:15X

4214839/K 08/2024

NOTES: (continued)

8. Laser cutting apertures with trapezoidal walls and rounded corners may offer better paste release. IPC-7525 may have alternate design recommendations.
9. Board assembly site may have different recommendations for stencil design.

IMPORTANT NOTICE AND DISCLAIMER

TI PROVIDES TECHNICAL AND RELIABILITY DATA (INCLUDING DATASHEETS), DESIGN RESOURCES (INCLUDING REFERENCE DESIGNS), APPLICATION OR OTHER DESIGN ADVICE, WEB TOOLS, SAFETY INFORMATION, AND OTHER RESOURCES "AS IS" AND WITH ALL FAULTS, AND DISCLAIMS ALL WARRANTIES, EXPRESS AND IMPLIED, INCLUDING WITHOUT LIMITATION ANY IMPLIED WARRANTIES OF MERCHANTABILITY, FITNESS FOR A PARTICULAR PURPOSE OR NON-INFRINGEMENT OF THIRD PARTY INTELLECTUAL PROPERTY RIGHTS.

These resources are intended for skilled developers designing with TI products. You are solely responsible for (1) selecting the appropriate TI products for your application, (2) designing, validating and testing your application, and (3) ensuring your application meets applicable standards, and any other safety, security, regulatory or other requirements.

These resources are subject to change without notice. TI grants you permission to use these resources only for development of an application that uses the TI products described in the resource. Other reproduction and display of these resources is prohibited. No license is granted to any other TI intellectual property right or to any third party intellectual property right. TI disclaims responsibility for, and you fully indemnify TI and its representatives against any claims, damages, costs, losses, and liabilities arising out of your use of these resources.

TI's products are provided subject to [TI's Terms of Sale](#), [TI's General Quality Guidelines](#), or other applicable terms available either on [ti.com](#) or provided in conjunction with such TI products. TI's provision of these resources does not expand or otherwise alter TI's applicable warranties or warranty disclaimers for TI products. Unless TI explicitly designates a product as custom or customer-specified, TI products are standard, catalog, general purpose devices.

TI objects to and rejects any additional or different terms you may propose.

Copyright © 2026, Texas Instruments Incorporated

Last updated 10/2025